



**中认信通**  
CHINA CERTIFICATION ICT CO., LTD (DONGGUAN)



## SAR TEST REPORT

**Applicant: PO FUNG ELECTRONIC (HK) INTERNATONAL GROUP COMPANY LIMITED**

**Address:** Room 1508, 15/F, Office Tower II, Grand Plaza, 625 Nathan Road, Kowloon, Hong Kong

**FCC ID: 2AJGM-GM21**

**Product Name: GMRS Radio**

**Model Number: GM21**

**Multiple Numbers: AR21G**

**Standard(s): 47 CFR Part 2(2.1093)**

The above device has been tested and found compliant with the requirement of the relative standards by China Certification ICT Co., Ltd (Dongguan)

**Report Number: CR231165357-SA**

**Date Of Issue: 2023-12-26**

**Reviewed By: Karl Gong**

*Karl Gong*

Title: SAR Engineer

**Test Laboratory: China Certification ICT Co., Ltd (Dongguan)**

No. 113, Pingkang Road, Dalang Town, Dongguan, Guangdong, China  
Tel: +86-769-82016888

**SAR TEST RESULTS SUMMARY**

Operation Frequency Bands	Highest Reported 1g SAR (W/kg)		Limits (W/kg)
	Head Face Up (Gap 25mm)	Body-Worn (Gap 0mm)	
PTT(462.5500-467.7250MHzMHz)	0.41	0.70	1.6
<b>Maximum Simultaneous Transmission SAR</b>			
Items	Head Face Up (Gap 25mm)	Body-Worn (Gap 0mm)	Limits
Sum SAR(W/kg)	N/A	N/A	1.6
SPLSR	N/A	N/A	0.04
EUT Received Date:	2023/11/06		
Tested Date:	2023/11/10		
Tested Result:	Pass		

## Test Facility

The Test site used by China Certification ICT Co., Ltd (Dongguan) to collect test data is located on the No. 113, Pingkang Road, Dalang Town, Dongguan, Guangdong, China.

The lab has been recognized as the FCC accredited lab under the KDB 974614 D01 and is listed in the FCC Public Access Link (PAL) database, FCC Registration No. : 442868, the FCC Designation No. : CN1314.

The lab has been recognized by Innovation, Science and Economic Development Canada to test to Canadian radio equipment requirements, the CAB identifier: CN0123.

## Declarations

China Certification ICT Co., Ltd (Dongguan) is not responsible for the authenticity of any test data provided by the applicant. Data included from the applicant that may affect test results are marked with a triangle symbol “▲”. Customer model name, addresses, names, trademarks etc. are not considered data.

Unless otherwise stated the results shown in this test report refer only to the sample(s) tested.

This report cannot be reproduced except in full, without prior written approval of the Company.

This report is valid only with a valid digital signature. The digital signature may be available only under the Adobe software above version 7.0.

This report may contain data that are not covered by the accreditation scope and shall be marked with an asterisk “★”.

# CONTENTS

**DOCUMENT REVISION HISTORY ..... 5**

**1. GENERAL INFORMATION ..... 6**

    1.1 PRODUCT DESCRIPTION FOR DEVICE UNDER TEST (EUT)..... 6

    1.2 TEST SPECIFICATION, METHODS AND PROCEDURES ..... 7

    1.3 SAR LIMITS..... 8

    1.4 FACILITIES..... 9

**2. SAR MEASUREMENT SYSTEM ..... 10**

**3. EQUIPMENT LIST AND CALIBRATION ..... 17**

    3.1 EQUIPMENTS LIST & CALIBRATION INFORMATION ..... 17

**4. SAR MEASUREMENT SYSTEM VERIFICATION ..... 18**

    4.1 LIQUID VERIFICATION ..... 18

    4.2 SYSTEM ACCURACY VERIFICATION ..... 19

    4.3 SAR SYSTEM VALIDATION DATA..... 20

**5. EUT TEST STRATEGY AND METHODOLOGY ..... 21**

    5.1 TEST POSITIONS FOR FRONT-OF-FACE CONFIGURATIONS..... 21

    5.2 TEST POSITIONS FOR BODY-WORN AND OTHER CONFIGURATIONS ..... 22

    5.3 TEST DISTANCE FOR SAR EVALUATION..... 22

    5.4 SAR EVALUATION PROCEDURE ..... 23

**6. CONDUCTED OUTPUT POWER MEASUREMENT ..... 24**

    6.1 TEST PROCEDURE ..... 24

    6.2 MAXIMUM TARGET OUTPUT POWER..... 24

    6.3 TEST RESULTS: ..... 24

**7. SAR MEASUREMENT RESULTS ..... 26**

    7.1 SAR TEST DATA ..... 26

**8. SAR MEASUREMENT VARIABILITY ..... 27**

**9. SAR PLOTS ..... 28**

**APPENDIX A MEASUREMENT UNCERTAINTY ..... 36**

**APPENDIX B EUT TEST POSITION PHOTOS..... 38**

**APPENDIX C CALIBRATION CERTIFICATES ..... 40**

## DOCUMENT REVISION HISTORY

Revision Number	Report Number	Description of Revision	Data of Revision
1.0	CR231165357-SA	Original Report	2023-12-26

## 1. GENERAL INFORMATION

### 1.1 Product Description for Device under Test (EUT)

<b>Device Type:</b>	Portable
<b>Exposure Category:</b>	General Population/Uncontrolled Exposure
<b>Antenna Type(s):</b>	External Antenna
<b>Body-Worn Accessories:</b>	Belt Clip ,Headset
<b>Face-Head Accessories:</b>	None
<b>Operation Mode:</b>	PTT_FM
<b>Frequency Band:</b>	462MHz(462.5500-462.7250 MHz) 462MHz(462.5625-462.7125 MHz) 467MHz(467.5500-467.7250 MHz) 467MHz(467.5625-467.7125 MHz)
<b>RF Conducted Output Power:</b>	462MHz(462.5500-462.7250 MHz): 36.38dBm 462MHz(462.5625-462.7125 MHz): 36.42dBm 467MHz(467.5500-467.7250 MHz): 36.36dBm 467MHz(467.5625-467.7125 MHz): 25.95dBm
<b>Power Source:</b>	DC 7.4V from battery
<b>Serial Number:</b>	2D9B-1
<b>Normal Operation:</b>	Face Up and Body-worn

## **1.2 Test Specification, Methods and Procedures**

The tests documented in this report were performed in accordance with FCC 47 CFR § 2.1093, IEEE 1528-2013, the following FCC Published RF exposure KDB procedures:

KDB 447498 D04 Interim General RF Exposure Guidance v01  
KDB 865664 D01 SAR Measurement 100 MHz to 6 GHz v01r04  
KDB 865664 D02 RF Exposure Reporting v01r02  
KDB 643646 D01 SAR Test for PTT Radios v01r03

TCB Workshop April 2019: RF Exposure Procedures

### 1.3 SAR Limits

#### FCC Limit

EXPOSURE LIMITS	SAR (W/kg)	
	(General Population / Uncontrolled Exposure Environment)	(Occupational / Controlled Exposure Environment)
Spatial Average (averaged over the whole body)	0.08	0.4
Spatial Peak (averaged over any 1 g of tissue)	<b>1.60</b>	8.0
Spatial Peak (hands/wrists/feet/ankles averaged over 10 g)	4.0	20.0

Population/Uncontrolled Environments are defined as locations where there is the exposure of individual who have no knowledge or control of their exposure.

Occupational/Controlled Environments are defined as locations where there is exposure that may be incurred by people who are aware of the potential for exposure (i.e. as a result of employment or occupation).

Occupational /Controlled Exposure environments Spatial Peak limit 1.6W/kg for 1g SAR applied to the EUT.



## 1.4 FACILITIES

The Test site used by China Certification ICT Co., Ltd (Dongguan) to collect test data is located on the No. 113, Pingkang Road, Dalang Town, Dongguan, Guangdong, China.

The test sites and measurement facilities used to collect data are located at:

<input type="checkbox"/> SAR Lab 1	<input checked="" type="checkbox"/> SAR Lab 2
------------------------------------	---

## 2. SAR MEASUREMENT SYSTEM

These measurements were performed with the automated near-field scanning system DASY5 from Schmid & Partner Engineering AG (SPEAG) which is the Fifth generation of the system shown in the figure hereinafter:



### DASY5 System Description

The DASY5 system for performing compliance tests consists of the following items:

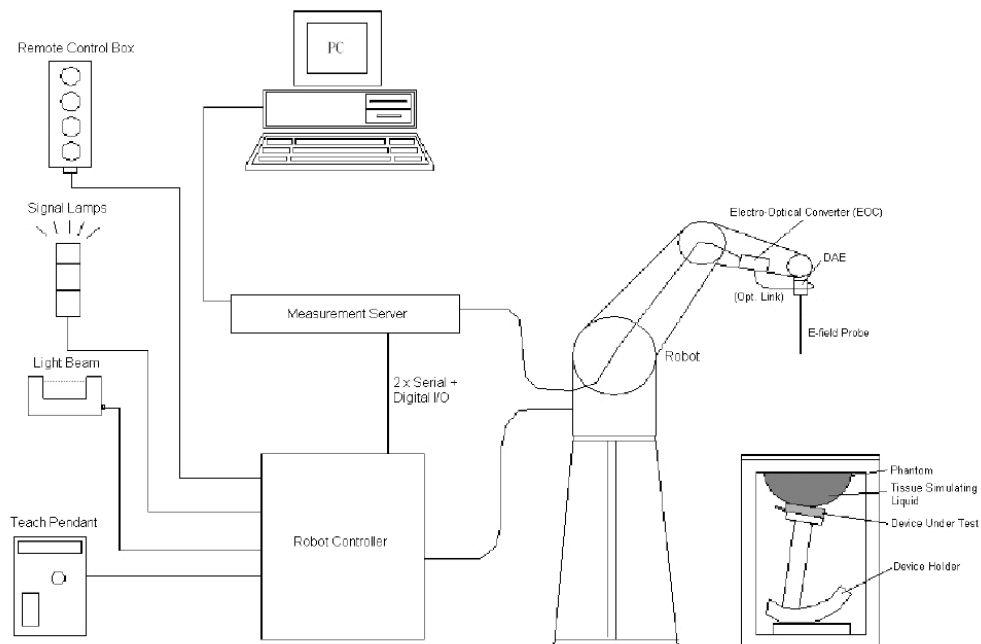

- A standard high precision 6-axis robot with controller, teach pendant and software. An arm extension for accommodating the data acquisition electronics (DAE).
- An isotropic field probe optimized and calibrated for the targeted measurement.
- A data acquisition electronics (DAE) which performs the signal application, signal multiplexing, AD-conversion, offset measurements, mechanical surface detection, collision detection, etc. The unit is battery powered with standard or rechargeable batteries. The signal is optically transmitted to the EOC.
- The Electro-optical converter (EOC) performs the conversion from optical to electrical signals for the digital communication to the DAE. To use optical surface detection, a special version of the EOC is required. The EOC signal is transmitted to the measurement server.
- The function of the measurement server is to perform the time critical tasks such as signal filtering, control of the robot operation and fast movement interrupts.
- The Light Beam used is for probe alignment. This improves the (absolute) accuracy of the probe positioning.
- A computer running Win7 professional operating system and the DASY52 software.
- Remote control and teach pendant as well as additional circuitry for robot safety such as warning lamps, etc.
- The phantom, the device holder and other accessories according to the targeted measurement.

### **DASY5 Measurement Server**

The DASY5 measurement server is based on a PC/104 CPU board with a 400MHz Intel ULV Celeron, 128MB chip-disk and 128MB RAM. The necessary circuits for communication with the DAE4 (or DAE3) electronics box, as well as the 16 bit AD-converter system for optical detection and digital I/O interface are contained on the DASY5 I/O board, which is directly connected to the PC/104 bus of the CPU board.



The measurement server performs all real-time data evaluation of field measurements and surface detection, controls robot movements and handles safety operation. The PC operating system cannot interfere with these time critical processes. All connections are supervised by a watchdog, and disconnection of any of the cables to the measurement server will automatically disarm the robot and disable all program-controlled robot movements. Furthermore, the measurement server is equipped with an expansion port which is reserved for future applications. Please note that this expansion port does not have a standardized point out, and therefore only devices provided by SPEAG can be connected. Devices from any other supplier could seriously damage the measurement server.

### **Data Acquisition Electronics**

The data acquisition electronics (DAE4) consist of a highly sensitive electrometer-grade preamplifier with auto-zeroing, a channel and gain-switching multiplexer, a fast 16 bit AD-converter and a command decoder with a control logic unit. Transmission to the measurement server is accomplished through an optical downlink for data and status information, as well as an optical uplink for commands and the clock.

The mechanical probe mounting device includes two different sensor systems for frontal and sideways probe contacts. They are used for mechanical surface detection and probe collision detection.

The input impedance of both the DAE4 as well as of the DAE3 box is 200M $\Omega$ ; the inputs are symmetrical and floating. Common mode rejection is above 80 dB.

**ES3DV2 E-Field Probes**

<b>Frequency</b>	10 MHz to 4 GHz Linearity: $\pm 0.2$ dB (30 MHz to 4 GHz)
<b>Directivity</b>	$\pm 0.2$ dB in TSL (rotation around probe axis) $\pm 0.3$ dB in TSL (rotation normal to probe axis)
<b>Dynamic Range</b>	5 $\mu$ W/g to > 100 mW/g Linearity: $\pm 0.2$ dB
<b>Dimensions</b>	Overall length: 337 mm (Tip: 20 mm) Tip diameter: 3.9 mm (Body: 12 mm) Distance from the probe tip to dipole centers: 2.0 mm
<b>Application</b>	General dosimetry up to 4 GHz Dosimetry in strong gradient fields Compliance tests of mobile phones
<b>Compatibility</b>	DASY3, DASY4, DASY52, DASY6, DASY8 SAR, EASY6, EASY4/MRI

**Calibration Frequency Points for ES3DV2 E-Field Probes SN: 3019 Calibrated: 2022/11/22**

Calibration Frequency Point(MHz)	Frequency Range(MHz)		Conversion Factor		
	From	To	X	Y	Z
150 Head	100	200	7.75	7.75	7.75
150 Body	100	200	7.43	7.43	7.43
450 Head	350	550	6.97	6.97	6.97
450 Body	350	550	6.96	6.96	6.96

### ELI Phantom

The ELI phantom is intended for compliance testing of handheld and body-mounted wireless devices in the frequency range of 30MHz to 6 GHz. ELI is fully compatible with the latest draft of the standard IEC 62209-2 and the use of all known tissue simulating liquids. ELI has been optimized for performance and can be integrated into a SPEAG standard phantom table. A cover is provided to prevent evaporation of water and changes in liquid parameters. Reference markings on the phantom allow installation of the complete setup, including all predefined phantom positions and measurement grids, by teaching three points.

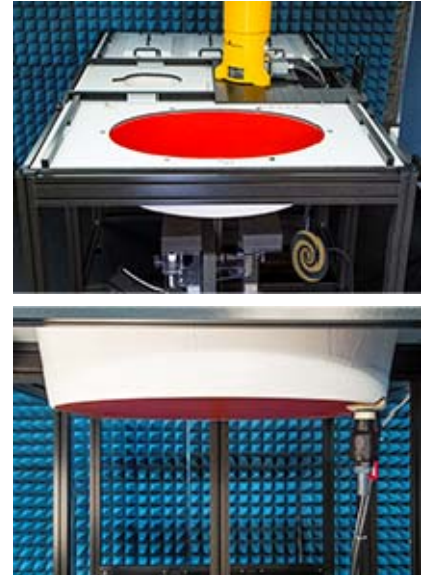

The phantom can be used with the following tissue simulating liquids:

- Sugar-water-based liquids can be left permanently in the phantom. Always cover the liquid when the system is not in use to prevent changes in liquid parameters due to water evaporation.
- DGBE-based liquids should be used with care. As DGBE is a softener for most plastics, the liquid should be taken out of the phantom, and the phantom should be dried when the system is not in use (desirable at least once a week).
- Do not use other organic solvents without previously testing the solvent resistivity of the phantom.

Approximately 25 liters of liquid is required to fill the ELI phantom

### Robots

The DASY5 system uses the high precision industrial robot. The robot offers the same features important for our application:

- High precision (repeatability 0.02mm)
- High reliability (industrial design)
- Low maintenance costs (virtually maintenance free due to direct drive gears; no belt drives)
- Jerk-free straight movements (brushless synchrony motors; no stepper motors)
- Low ELF interference (motor control fields shielded via the closed metallic construction shields)

The above mentioned robots are controlled by the Staubli CS7MB robot controllers. All information regarding the use and maintenance of the robot arm and the robot controller is contained on the CDs delivered along with the robot. Paper manuals are available upon request direct from Staubli.

## SAR Scan Procedures

### Step 1: Power Reference Measurement

The Power Reference Measurement and Power Drift Measurements are for monitoring the power drift of the device under test in the batch process. The minimum distance of probe sensors to surface determines the closest measurement point to phantom surface. The minimum distance of probe sensors to surface is 1.4 mm. This distance cannot be smaller than the distance of sensor calibration points to probe tip as defined in the probe properties.

### Step 2: Area Scans

Area scans are defined prior to the measurement process being executed with a user defined variable spacing between each measurement point (integral) allowing low uncertainty measurements to be conducted. Scans defined for FCC applications utilize a 15mm 2 step integral, with 1.5mm interpolation used to locate the peak SAR area used for zoom scan assessments.

Where the system identifies multiple SAR peaks (which are within 25% of peak value) the system will provide the user with the option of assessing each peak location individually for zoom scan averaging.

Area Scan Parameters extracted from KDB 865664 D01 SAR Measurement 100 MHz to 6 GHz

	≤ 3 GHz	> 3 GHz
Maximum distance from closest measurement point (geometric center of probe sensors) to phantom surface	5 mm ± 1 mm	$\frac{1}{2} \cdot \delta \cdot \ln(2)$ mm ± 0.5 mm
Maximum probe angle from probe axis to phantom surface normal at the measurement location	30° ± 1°	20° ± 1°
Maximum area scan spatial resolution: $\Delta x_{Area}$ , $\Delta y_{Area}$	≤ 2 GHz: ≤ 15 mm 2 – 3 GHz: ≤ 12 mm	3 – 4 GHz: ≤ 12 mm 4 – 6 GHz: ≤ 10 mm
	When the x or y dimension of the test device, in the measurement plane orientation, is smaller than the above, the measurement resolution must be ≤ the corresponding x or y dimension of the test device with at least one measurement point on the test device.	

### Step 3: Zoom Scan (Cube Scan Averaging)

The averaging zoom scan volume utilized in the DASY5 software is in the shape of a cube and the side dimension of a 1 g or 10 g mass is dependent on the density of the liquid representing the simulated tissue. A density of 1000 kg/m<sup>3</sup> is used to represent the head and body tissue density and not the phantom liquid density, in order to be consistent with the definition of the liquid dielectric properties, i.e. the side length of the 1g cube is 10mm, with the side length of the 10g cube is 21.5mm.

When the cube intersects with the surface of the phantom, it is oriented so that 3 vertices touch the surface of the shell or the center of a face is tangent to the surface. The face of the cube closest to the surface is modified in order to conform to the tangent surface.

The zoom scan integer steps can be user defined so as to reduce uncertainty, but normal practice for typical test applications (including FCC) utilize a physical step of 7 x7 x 7 (5mmx5mmx5mm) providing a volume of 30 mm in the X & Y & Z axis.

Zoom Scan Parameters extracted from KDB 865664 D01 SAR Measurement 100 MHz to 6 GHz

			≤ 3 GHz	> 3 GHz
Maximum zoom scan spatial resolution: $\Delta x_{\text{Zoom}}, \Delta y_{\text{Zoom}}$			≤ 2 GHz: ≤ 8 mm 2 – 3 GHz: ≤ 5 mm*	3 – 4 GHz: ≤ 5 mm* 4 – 6 GHz: ≤ 4 mm*
Maximum zoom scan spatial resolution, normal to phantom surface	uniform grid: $\Delta z_{\text{Zoom}}(n)$		≤ 5 mm	3 – 4 GHz: ≤ 4 mm 4 – 5 GHz: ≤ 3 mm 5 – 6 GHz: ≤ 2 mm
	graded grid	$\Delta z_{\text{Zoom}}(1)$ : between 1 <sup>st</sup> two points closest to phantom surface	≤ 4 mm	3 – 4 GHz: ≤ 3 mm 4 – 5 GHz: ≤ 2.5 mm 5 – 6 GHz: ≤ 2 mm
		$\Delta z_{\text{Zoom}}(n>1)$ : between subsequent points	≤ 1.5 · $\Delta z_{\text{Zoom}}(n-1)$ mm	
Minimum zoom scan volume	x, y, z	≥ 30 mm	3 – 4 GHz: ≥ 28 mm 4 – 5 GHz: ≥ 25 mm 5 – 6 GHz: ≥ 22 mm	
Note: $\delta$ is the penetration depth of a plane-wave at normal incidence to the tissue medium; see IEEE Std 1528-2013 for details. * When zoom scan is required and the <i>reported</i> SAR from the <i>area scan based 1-g SAR estimation</i> procedures of KDB Publication 447498 is ≤ 1.4 W/kg, ≤ 8 mm, ≤ 7 mm and ≤ 5 mm zoom scan resolution may be applied, respectively, for 2 GHz to 3 GHz, 3 GHz to 4 GHz and 4 GHz to 6 GHz.				

### Step 4: Power Drift Measurement

The Power Drift Measurement measures the field at the same location as the most recent power reference measurement within the same procedure, and with the same settings. The Power Drift Measurement gives the field difference in dB from the reading conducted within the last Power Reference Measurement. This allows a user to monitor the power drift of the device under test within a batch process. The measurement procedure is the same as Step 1.



## Tissue Dielectric Parameters for Head and Body Phantoms

The head tissue dielectric parameters recommended by the IEC 62209-1:2016

### Recommended Tissue Dielectric Parameters for Head liquid

**Table A.3 – Dielectric properties of the head tissue-equivalent liquid**

Frequency MHz	Relative permittivity $\epsilon_r$	Conductivity ( $\sigma$ ) S/m
300	45,3	0,87
450	43,5	0,87
<i>750</i>	<i>41,9</i>	<i>0,89</i>
835	41,5	0,90
900	41,5	0,97
1 450	40,5	1,20
<i>1 500</i>	<i>40,4</i>	<i>1,23</i>
<i>1 640</i>	<i>40,2</i>	<i>1,31</i>
<i>1 750</i>	<i>40,1</i>	<i>1,37</i>
1 800	40,0	1,40
1 900	40,0	1,40
2 000	40,0	1,40
<i>2 100</i>	<i>39,8</i>	<i>1,49</i>
<i>2 300</i>	<i>39,5</i>	<i>1,67</i>
<i>2 450</i>	<i>39,2</i>	<i>1,80</i>
<i>2 600</i>	<i>39,0</i>	<i>1,96</i>
3 000	38,5	2,40
<i>3 500</i>	<i>37,9</i>	<i>2,91</i>
<i>4 000</i>	<i>37,4</i>	<i>3,43</i>
<i>4 500</i>	<i>36,8</i>	<i>3,94</i>
<i>5 000</i>	<i>36,2</i>	<i>4,45</i>
<i>5 200</i>	<i>36,0</i>	<i>4,66</i>
<i>5 400</i>	<i>35,8</i>	<i>4,86</i>
<i>5 600</i>	<i>35,5</i>	<i>5,07</i>
<i>5 800</i>	<i>35,3</i>	<i>5,27</i>
6 000	35,1	5,48

NOTE For convenience, permittivity and conductivity values at those frequencies which are not part of the original data provided by Drossos et al. [33] or the extension to 5 800 MHz are provided (i.e. the values shown *in italics*). These values were linearly interpolated between the values in this table that are immediately above and below these values, except the values at 6 000 MHz that were linearly extrapolated from the values at 3 000 MHz and 5 800 MHz.



### 3. EQUIPMENT LIST AND CALIBRATION

#### 3.1 Equipments List & Calibration Information

Equipment	Model	S/N	Calibration Date	Calibration Due Date
DASY5 Test Software	DASY52.8	N/A	NCR	NCR
DASY5 Measurement Server	DASY5 5.0.28	1123	NCR	NCR
Data Acquisition Electronics	DAE3	494	2023/9/11	2024/9/10
E-Field Probe	ES3DV2	3019	2022/11/22	2023/11/21
Mounting Device	MD4HHTV5	BJPCTC0152	NCR	NCR
Oval Flat Phantom	ELI V5.0	1078	NCR	NCR
Dipole, 450MHz	D450V3	1096	2022/11/17	2023/11/16
Simulated Tissue 450 MHz	TS-450H	2109045001	Each Time	/
Network Analyzer	8753B	2828A00170	2023/10/17	2024/10/16
Dielectric assessment kit	1319	SM DAK 040 CA	NCR	NCR
MXG Vector Signal Generator	N5182B	MY51350144	2023/3/31	2024/3/30
Power Meter	ML2495A	1106009	2023/8/4	2024/8/3
Power Amplifier	ZHL-5W-202-S+	416402204	NCR	NCR
Directional Coupler	441493	520Z	NCR	NCR
Attenuator	20dB, 100W	LN749	NCR	NCR
Attenuator	6dB, 150W	2754	NCR	NCR
Thermometer	DTM3000	3892	2023/3/31	2024/3/30
Spectrum Analyzer	FSU26	100147	2023/3/31	2024/3/30

## 4. SAR MEASUREMENT SYSTEM VERIFICATION

### 4.1 Liquid Verification

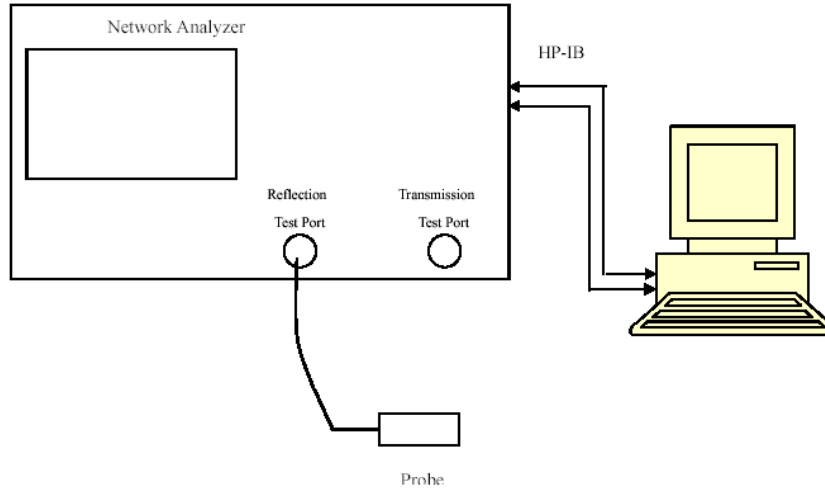

Liquid Verification Setup Block Diagram

### Liquid Verification Results

Frequency (MHz)	Liquid Type	Liquid Parameter		Target Value		Delta (%)		Tolerance (%)
		$\epsilon_r$	$\sigma$ (S/m)	$\epsilon_r$	$\sigma$ (S/m)	$\Delta\epsilon_r$	$\Delta\sigma$ (S/m)	
430	Simulated Tissue 450 MHz Head	44.124	0.846	43.74	0.87	0.88	-2.76	$\pm 5$
440	Simulated Tissue 450 MHz Head	43.985	0.852	43.62	0.87	0.84	-2.07	$\pm 5$
450	Simulated Tissue 450 MHz Head	43.857	0.858	43.5	0.87	0.82	-1.38	$\pm 5$
460	Simulated Tissue 450 MHz Head	43.779	0.862	43.45	0.87	0.76	-0.92	$\pm 5$
470	Simulated Tissue 450 MHz Head	43.687	0.867	43.39	0.87	0.68	-0.34	$\pm 5$

\*Liquid Verification above was performed on 2023/11/10.

## 4.2 System Accuracy Verification

Prior to the assessment, the system validation kit was used to test whether the system was operating within its specifications of  $\pm 10\%$ . The validation results are tabulated below. And also the corresponding SAR plot is attached as well in the SAR plots files.

The spacing distances in the **System Verification Setup Block Diagram** is given by the following:

- $s = 15 \text{ mm} \pm 0,2 \text{ mm}$  for  $300 \text{ MHz} \leq f \leq 1\,000 \text{ MHz}$ ;
- $s = 10 \text{ mm} \pm 0,2 \text{ mm}$  for  $1\,000 \text{ MHz} < f \leq 3\,000 \text{ MHz}$ ;
- $s = 10 \text{ mm} \pm 0,2 \text{ mm}$  for  $3\,000 \text{ MHz} < f \leq 6\,000 \text{ MHz}$ .

### System Verification Setup Block Diagram

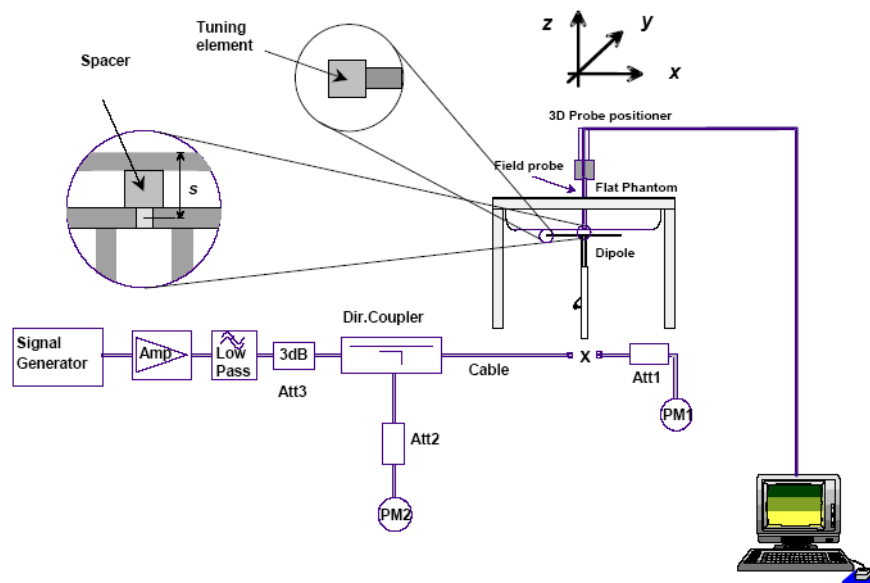

### System Accuracy Check Results

Date	Frequency Band	Liquid Type	Input Power (W)	Measured SAR (W/kg)	Target Value (W/kg)	Delta (%)	Tolerance (%)
2023/11/10	450 MHz	Simulated Tissue 450 MHz Head	1	1g 4.68	4.56	2.63	$\pm 10$

### 4.3 SAR SYSTEM VALIDATION DATA

#### System Performance 450 MHz

**DUT: Dipole 450 MHz; Type: D450V3; Serial: 1096**

Communication System: CW; Frequency: 450 MHz; Duty Cycle: 1:1  
Medium parameters used:  $f = 450$  MHz;  $\sigma = 0.858$  S/m;  $\epsilon_r = 43.857$ ;  $\rho = 1000$  kg/m<sup>3</sup>  
Phantom section: Flat Section

DASY5 Configuration:

- Probe: ES3DV2 - SN3019; ConvF(6.97, 6.97, 6.97) @ 450 MHz; Calibrated: 2022/11/22
- Sensor-Surface: 3mm (Mechanical Surface Detection)
- Electronics: DAE3 Sn494; Calibrated: 2023/9/11
- Phantom: ELI v5.0; Type: QDOVA002AA; Serial: TP:1078
- Measurement SW: DASY52, Version 52.8 (7); SEMCAD X Version 14.6.10 (7164)

**Area Scan (7x21x1):** Measurement grid: dx=15mm, dy=15mm  
Maximum value of SAR (measured) = 4.79 W/kg

**Zoom Scan (5x5x7)/Cube 0:** Measurement grid: dx=8mm, dy=8mm, dz=5mm  
Reference Value = 67.95 V/m; Power Drift = -0.07dB  
Peak SAR (extrapolated) = 6.82 W/kg  
**SAR(1 g) = 4.68 W/kg; SAR(10 g) = 3.18 W/kg**  
Maximum value of SAR (measured) = 4.87 W/kg

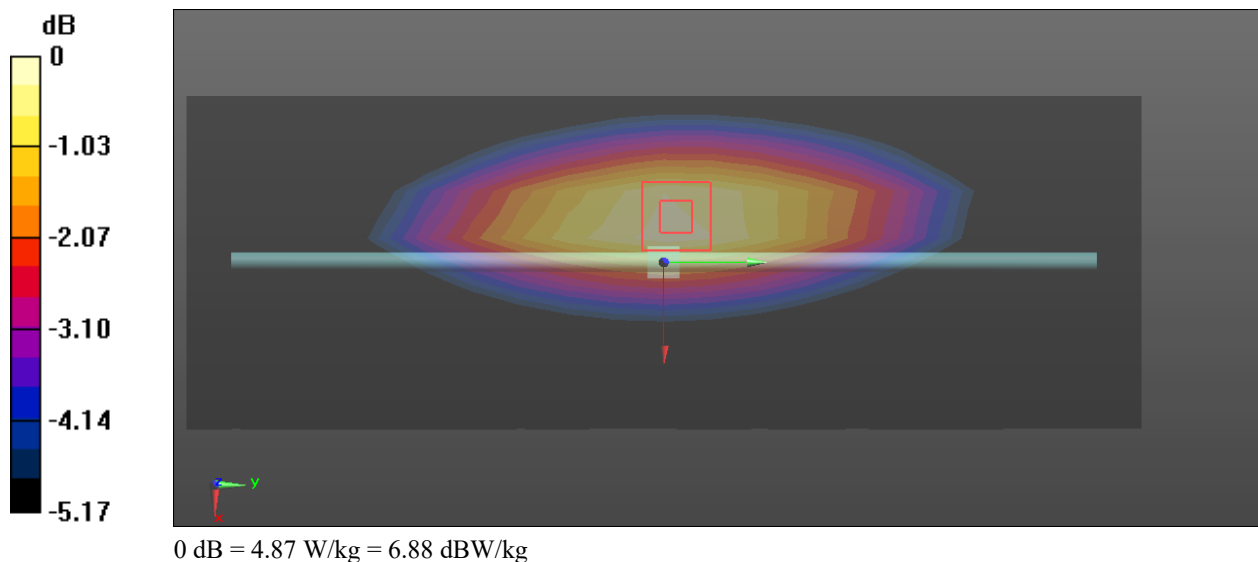

## 5. EUT TEST STRATEGY AND METHODOLOGY

### 5.1 Test positions for Front-of-face configurations

Passive body-worn and audio accessories generally do not apply to the head SAR of PTT radios. Head SAR is measured with the front surface of the radio positioned at 2.5 cm parallel to a flat phantom. A phantom shell thickness of 2 mm is required. When the front of the radio has a contour or non-uniform surface with a variation of 1.0 cm or more, the average distance of such variations is used to establish the 2.5 cm test separation from the phantom.

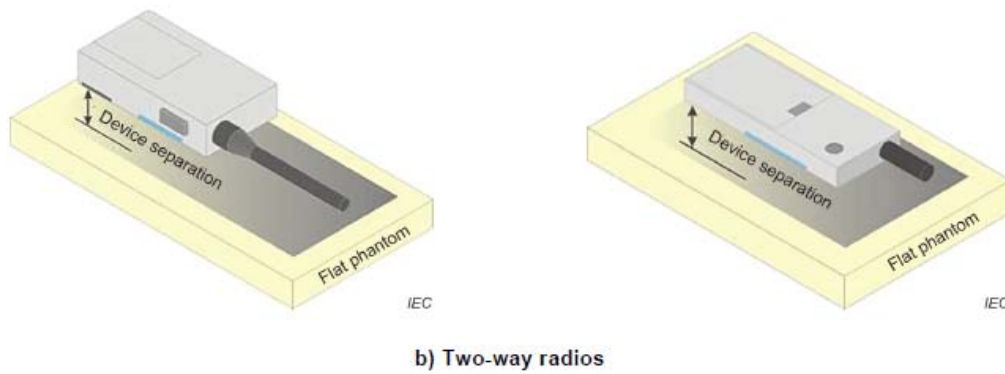

Figure 10 – Test positions for front-of-face devices

## 5.2 Test positions for body-worn and other configurations

Body-worn operating configurations should be tested with the belt-clips and holsters attached to the device and positioned against a flat phantom in normal use configurations. Devices with a headset output should be tested with a headset connected to the device. When multiple accessories that do not contain metallic components are supplied with the device, the device may be tested with only the accessory that dictates the closest spacing to the body. When multiple accessories that contain metallic components are supplied with the device, the device must be tested with each accessory that contains a unique metallic component. If multiple accessories share an identical metallic component (e.g., the same metallic belt-clip used with different holsters with no other metallic components), only the accessory that dictates the closest spacing to the body must be tested.

Body-worn accessories may not always be supplied or available as options for some devices that are intended to be authorized for body-worn use. A separation distance of 1.5 cm between the back of the device and a flat phantom is recommended for testing body-worn SAR compliance under such circumstances. Other separation distances may be used, but they should not exceed 2.5 cm. In these cases, the device may use body-worn accessories that provide a separation distance greater than that tested for the device provided however that the accessory contains no metallic components.

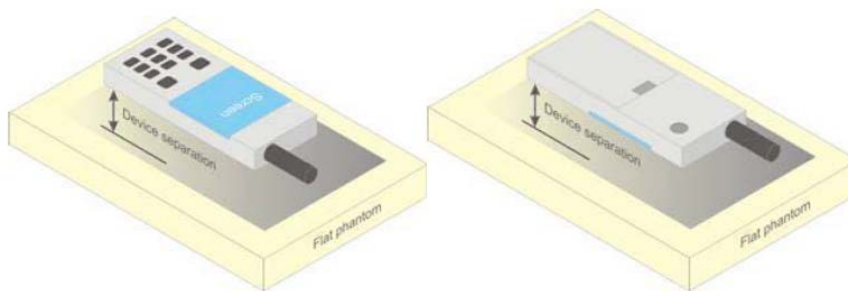

Figure 5 – Test positions for body-worn devices

## 5.3 Test Distance for SAR Evaluation

In this case the DUT(Device Under Test) is set directly against the phantom, the test distance is 0mm for Body Back mode; for Face Up mode the distance is 25mm.

## 5.4 SAR Evaluation Procedure

The evaluation was performed with the following procedure:

Step 1: Measurement of the SAR value at a fixed location above the ear point or central position was used as a reference value for assessing the power drop. The SAR at this point is measured at the start of the test and then again at the end of the testing.

Step 2: The SAR distribution at the exposed side of the head was measured at a distance of 4 mm from the inner surface of the shell. The area covered the entire dimension of the head or radiating structures of the EUT, the horizontal grid spacing was 15 mm x 15 mm, and the SAR distribution was determined by integrated grid of 1.5mm x 1.5mm. Based on these data, the area of the maximum absorption was determined by spline interpolation. The first Area Scan covers the entire dimension of the EUT to ensure that the hotspot was correctly identified.

Step 3: Around this point, a volume of 30 mm x 30 mm x 30 mm was assessed by measuring 7x 7 x 7 points. On the basis of this data set, the spatial peak SAR value was evaluated under the following procedure:

1) The data at the surface were extrapolated, since the center of the dipoles is 1.2 mm away from the tip of the probe and the distance between the surface and the lowest measuring point is 1.3 mm. The extrapolation was based on a least square algorithm. A polynomial of the fourth order was calculated through the points in z-axes. This polynomial was then used to evaluate the points between the surface and the probe tip.

2) The maximum interpolated value was searched with a straightforward algorithm. Around this maximum the SAR values averaged over the spatial volumes (1 g or 10 g) were computed by the 3D-Spline interpolation algorithm. The 3D-Spline is composed of three one dimensional splines with the "Not a knot"-condition (in x, y and z-directions). The volume was integrated with the trapezoidal-algorithm. One thousand points (10 x 10 x 10) were interpolated to calculate the averages.

All neighboring volumes were evaluated until no neighboring volume with a higher average value was found.

Step 4: Re-measurement of the SAR value at the same location as in Step 1. If the value changed by more than 5%, the evaluation was repeated.

## 6. CONDUCTED OUTPUT POWER MEASUREMENT

### 6.1 Test Procedure

The RF output of the transmitter was connected to the input of the Spectrum Analyzer through sufficient attenuation.

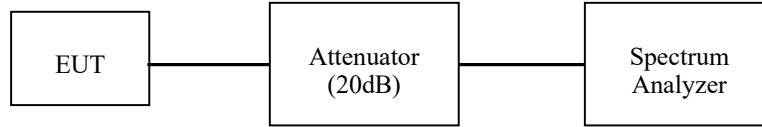

The Signal Analyzer setting:

RBW	VBW
100 kHz	300 kHz

### 6.2 Maximum Target Output Power

Frequency Band	Max. tune-up tolerance power limit for Production(dBm)
462MHz(462.5500-462.7250 MHz)	36.5
462MHz(462.5625-462.7125 MHz)	36.5
467MHz(467.5500-467.7250 MHz)	36.5
467MHz(467.5625-467.7125 MHz)	26

### 6.3 Test Results:

Mode	Frequency (MHz)	Measured Conducted Output Power Unit (dBm)
462MHz(462.5500-462.7250 MHz)	462.625	36.38
462MHz(462.5625-462.7125 MHz)	462.6375	36.42
467MHz(467.5500-467.7250 MHz)	467.625	36.36
467MHz(467.5625-467.7125 MHz)	467.6375	25.95

**Note:**

Per IEEE1528:2013, the width of the transmit frequency band,  $\Delta f = f_{\text{high}} - f_{\text{low}}$  (where  $f_{\text{high}}$  is the highest frequency in the band and  $f_{\text{low}}$  is the lowest) does not exceeds 1% of its center frequency  $f_c$ . then only center frequency need be tested.



**Antennas Location:**

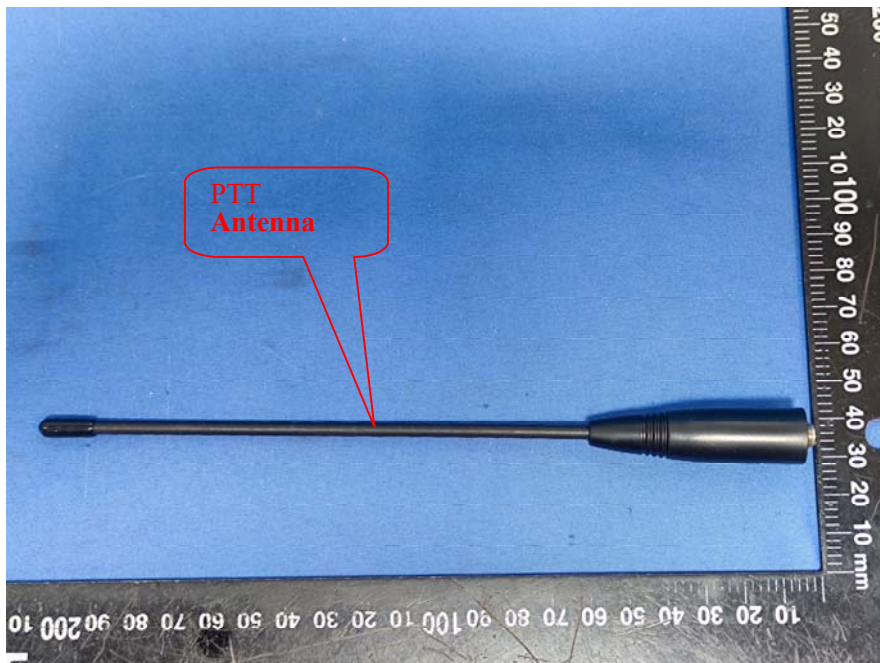

## 7. SAR MEASUREMENT RESULTS

This page summarizes the results of the performed dosimetric evaluation.

### 7.1 SAR Test Data

#### Environmental Conditions

Temperature:	22.3-23.6 °C
Relative Humidity:	54 %
ATM Pressure:	100.1 kPa
Test Date:	2023/11/10

Testing was performed by Leo Lu

#### Test Results:

Test Mode	Frequency (MHz)	Worn accessories	Max. Meas. Power (dBm)	Max. Rated Power (dBm)	1 g SAR Value(W/kg)				
					Power Scaled Factor	Meas. SAR	PTT 50% Factor	Scaled SAR	Plot
Head Face Up (25 mm)	462.625	None	36.38	36.5	1.028	0.696	0.348	0.36	1#
	462.6375	None	36.42	36.5	1.019	0.796	0.398	<b>0.41</b>	2#
	467.625	None	36.36	36.5	1.033	0.592	0.296	0.31	3#
	467.6375	None	25.95	26	1.012	0.078	0.039	0.04	4#
Body Back (0 mm)	462.625	Belt Clip	36.38	36.5	1.028	1.08	0.54	0.56	5#
	462.6375	Belt Clip	36.42	36.5	1.019	1.38	0.69	<b>0.70</b>	6#
	467.625	Belt Clip	36.36	36.5	1.033	1.05	0.525	0.54	7#
	467.6375	Belt Clip	25.95	26	1.012	0.144	0.072	0.07	8#

#### Note:

1. For a PTT, only simplex communication technology was supported, so the SAR value need to be corrected by Multiplying 50%.
2. Passive body-worn and audio accessories generally do not apply to the head SAR of PTT radios.
3. The whole antenna and radiating structures that may contribute to the measured SAR or influence the SAR distribution has been included in the area scan.
4. The UHF bands in this device operate in a half duplex system. A half duplex system only allows the user to transmit or receive. This device cannot transmit and receive simultaneously. The user must stop transmitting in order to receive a signal or listen for a response, regardless of PTT button or with a VOX(Voice Activated Transmit) capacity. This type of operation, along with the RF safety booklet, which instructs the user to transmit no more than 50% of the time, justifies the use of 50% duty factor for this device.

## 8. SAR MEASUREMENT VARIABILITY

In accordance with published RF Exposure KDB procedure 865664 D01 SAR measurement 100 MHz to 6 GHz v01. These additional measurements are repeated after the completion of all measurements requiring the same head or body tissue-equivalent medium in a frequency band. The test device should be returned to ambient conditions (normal room temperature) with the battery fully charged before it is re-mounted on the device holder for the repeated measurement(s) to minimize any unexpected variations in the repeated results

- 1) Repeated measurement is not required when the original highest measured SAR is  $< 0.80$  W/kg; steps 2) through 4) do not apply.
- 2) When the original highest measured SAR is  $\geq 0.80$  W/kg, repeat that measurement once.
- 3) Perform a second repeated measurement only if the ratio of largest to smallest SAR for the original and first repeated measurements is  $> 1.20$  or when the original or repeated measurement is  $\geq 1.45$  W/kg ( $\sim 10\%$  from the 1-g SAR limit).
- 4) Perform a third repeated measurement only if the original, first or second repeated measurement is  $\geq 1.5$  W/kg and the ratio of largest to smallest SAR for the original, first and second repeated measurements is  $> 1.20$ .

*Note: The same procedures should be adapted for measurements according to extremity and occupational exposure limits by applying a factor of 2.5 for extremity exposure and a factor of 5 for occupational exposure to the corresponding SAR thresholds.*

### The Highest Measured SAR Configuration in Each Frequency Band

#### Head(Face Up)

SAR probe calibration point	Freq.(MHz)	EUT Position	Meas. SAR (W/kg)		Largest to Smallest SAR Ratio
			Original	Repeated	
/	/	/	/	/	/

#### Body(Body Back)

SAR probe calibration point	Freq.(MHz)	EUT Position	Meas. SAR (W/kg)		Largest to Smallest SAR Ratio
			Original	Repeated	
/	/	/	/	/	/

#### Note:

1. Second Repeated Measurement is not required since the ratio of the largest to smallest SAR for the original and first repeated measurement is not  $> 1.20$ .
2. The measured SAR results **do not** have to be scaled to the maximum tune-up tolerance to determine if repeated measurements are required.
3. SAR measurement variability must be assessed for each frequency band, which is determined by the **SAR probe calibration point and tissue-equivalent medium** used for the device measurements.

## 9. SAR PLOTS

Plot1#: 462.625MHz \_Face Up

DUT: GMRS Radio; Type: GMRS Radio; Serial: 2D9B-1

Communication System: FM; Frequency: 462.625 MHz; Duty Cycle: 1:1  
Medium parameters used (interpolated):  $f = 462.625$  MHz;  $\sigma = 0.864$  S/m;  $\epsilon_r = 43.755$ ;  $\rho = 1000$  kg/m<sup>3</sup>  
Phantom section: Flat Section

DASY5 Configuration:

- Probe: ES3DV2 - SN3019; ConvF(6.97, 6.97, 6.97) @ 462.625 MHz; Calibrated: 2022/11/22
- Sensor-Surface: 3mm (Mechanical Surface Detection)
- Electronics: DAE3 Sn494; Calibrated: 2023/9/11
- Phantom: ELI v5.0; Type: QDOVA002AA; Serial: TP:1078
- Measurement SW: DASY52, Version 52.8 (7); SEMCAD X Version 14.6.10 (7164)

**Area Scan (7x20x1):** Measurement grid: dx=15mm, dy=15mm  
Maximum value of SAR (measured) = 0.773 W/kg

**Zoom Scan (5x5x7)/Cube 0:** Measurement grid: dx=8mm, dy=8mm, dz=5mm  
Reference Value = 28.82 V/m; Power Drift = 0.10 dB  
Peak SAR (extrapolated) = 0.977 W/kg  
**SAR(1 g) = 0.696 W/kg; SAR(10 g) = 0.511 W/kg**  
Maximum value of SAR (measured) = 0.783 W/kg

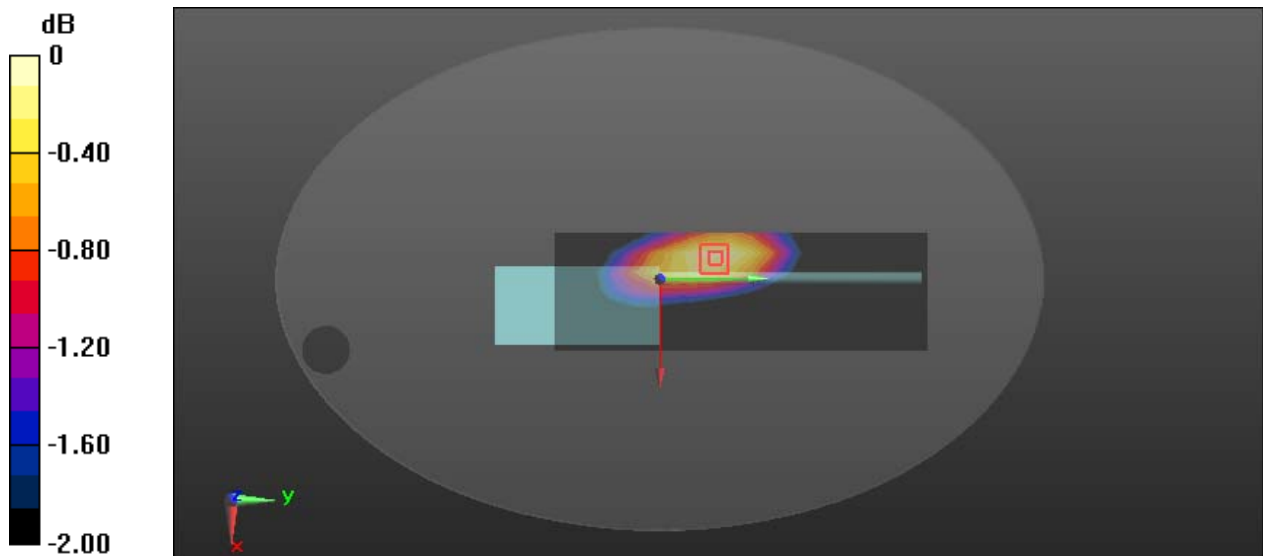

0 dB = 0.783 W/kg = -1.06 dBW/kg

**Plot2#: 462.6375MHz \_Face Up**

**DUT: GMRS Radio; Type: GMRS Radio; Serial: 2D9B-1**

Communication System: FM; Frequency: 462.637 MHz; Duty Cycle: 1:1

Medium parameters used (interpolated):  $f = 462.637$  MHz;  $\sigma = 0.864$  S/m;  $\epsilon_r = 43.755$ ;  $\rho = 1000$  kg/m<sup>3</sup>

Phantom section: Flat Section

DASY5 Configuration:

- Probe: ES3DV2 - SN3019; ConvF(6.97, 6.97, 6.97) @ 462.637 MHz; Calibrated: 2022/11/22
- Sensor-Surface: 3mm (Mechanical Surface Detection)
- Electronics: DAE3 Sn494; Calibrated: 2023/9/11
- Phantom: ELI v5.0; Type: QDOVA002AA; Serial: TP:1078
- Measurement SW: DASY52, Version 52.8 (7); SEMCAD X Version 14.6.10 (7164)

**Area Scan (7x20x1):** Measurement grid: dx=15mm, dy=15mm

Maximum value of SAR (measured) = 0.891 W/kg

**Zoom Scan (5x5x7)/Cube 0:** Measurement grid: dx=8mm, dy=8mm, dz=5mm

Reference Value = 24.90 V/m; Power Drift = 0.11 dB

Peak SAR (extrapolated) = 1.12 W/kg

**SAR(1 g) = 0.796 W/kg; SAR(10 g) = 0.582 W/kg**

Maximum value of SAR (measured) = 0.892 W/kg

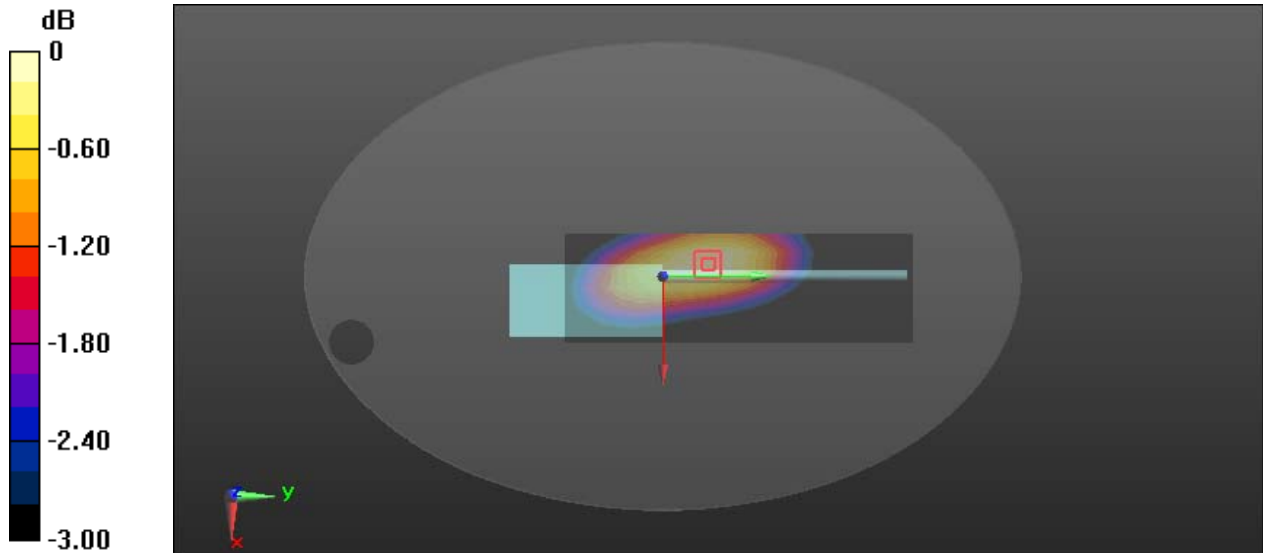

0 dB = 0.892 W/kg = -0.50 dBW/kg

**Plot3#: 467.625MHz \_Face Up****DUT: GMRS Radio; Type: GMRS Radio; Serial: 2D9B-1**

Communication System: FM; Frequency: 467.625 MHz; Duty Cycle: 1:1

Medium parameters used (interpolated):  $f = 467.625$  MHz;  $\sigma = 0.866$  S/m;  $\epsilon_r = 43.709$ ;  $\rho = 1000$  kg/m<sup>3</sup>

Phantom section: Flat Section

DASY5 Configuration:

- Probe: ES3DV2 - SN3019; ConvF(6.97, 6.97, 6.97) @ 467.625 MHz; Calibrated: 2022/11/22
- Sensor-Surface: 3mm (Mechanical Surface Detection)
- Electronics: DAE3 Sn494; Calibrated: 2023/9/11
- Phantom: ELI v5.0; Type: QDOVA002AA; Serial: TP:1078
- Measurement SW: DASY52, Version 52.8 (7); SEMCAD X Version 14.6.10 (7164)

**Area Scan (7x20x1):** Measurement grid: dx=15mm, dy=15mm

Maximum value of SAR (measured) = 0.662 W/kg

**Zoom Scan (5x5x7)/Cube 0:** Measurement grid: dx=8mm, dy=8mm, dz=5mm

Reference Value = 26.21 V/m; Power Drift = 0.13 dB

Peak SAR (extrapolated) = 0.844 W/kg

**SAR(1 g) = 0.592 W/kg; SAR(10 g) = 0.434 W/kg**

Maximum value of SAR (measured) = 0.664 W/kg

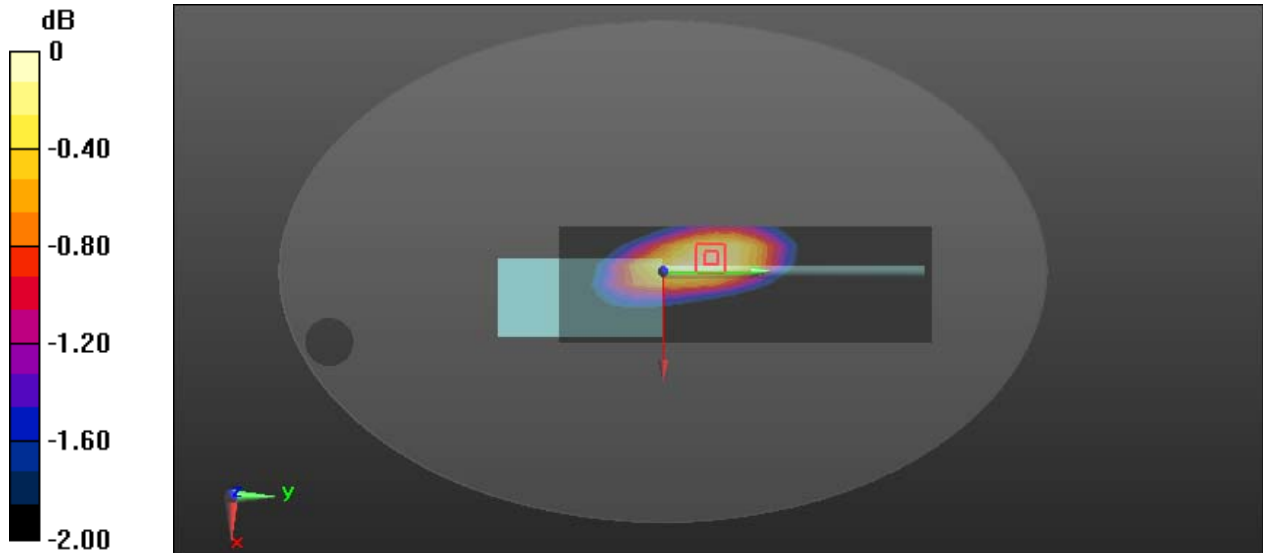

0 dB = 0.664 W/kg = -1.78 dBW/kg

**Plot4#: 467.6375MHz \_Face Up****DUT: GMRS Radio; Type: GMRS Radio; Serial: 2D9B-1**

Communication System: FM; Frequency: 467.637 MHz; Duty Cycle: 1:1

Medium parameters used (interpolated):  $f = 467.637$  MHz;  $\sigma = 0.866$  S/m;  $\epsilon_r = 43.709$ ;  $\rho = 1000$  kg/m<sup>3</sup>

Phantom section: Flat Section

DASY5 Configuration:

- Probe: ES3DV2 - SN3019; ConvF(6.97, 6.97, 6.97) @ 467.637 MHz; Calibrated: 2022/11/22
- Sensor-Surface: 3mm (Mechanical Surface Detection)
- Electronics: DAE3 Sn494; Calibrated: 2023/9/11
- Phantom: ELI v5.0; Type: QDOVA002AA; Serial: TP:1078
- Measurement SW: DASY52, Version 52.8 (7); SEMCAD X Version 14.6.10 (7164)

**Area Scan (7x20x1):** Measurement grid: dx=15mm, dy=15mm

Maximum value of SAR (measured) = 0.0895 W/kg

**Zoom Scan (5x5x7)/Cube 0:** Measurement grid: dx=8mm, dy=8mm, dz=5mm

Reference Value = 9.003 V/m; Power Drift = -0.19 dB

Peak SAR (extrapolated) = 0.112 W/kg

**SAR(1 g) = 0.078 W/kg; SAR(10 g) = 0.056 W/kg**

Maximum value of SAR (measured) = 0.0883 W/kg

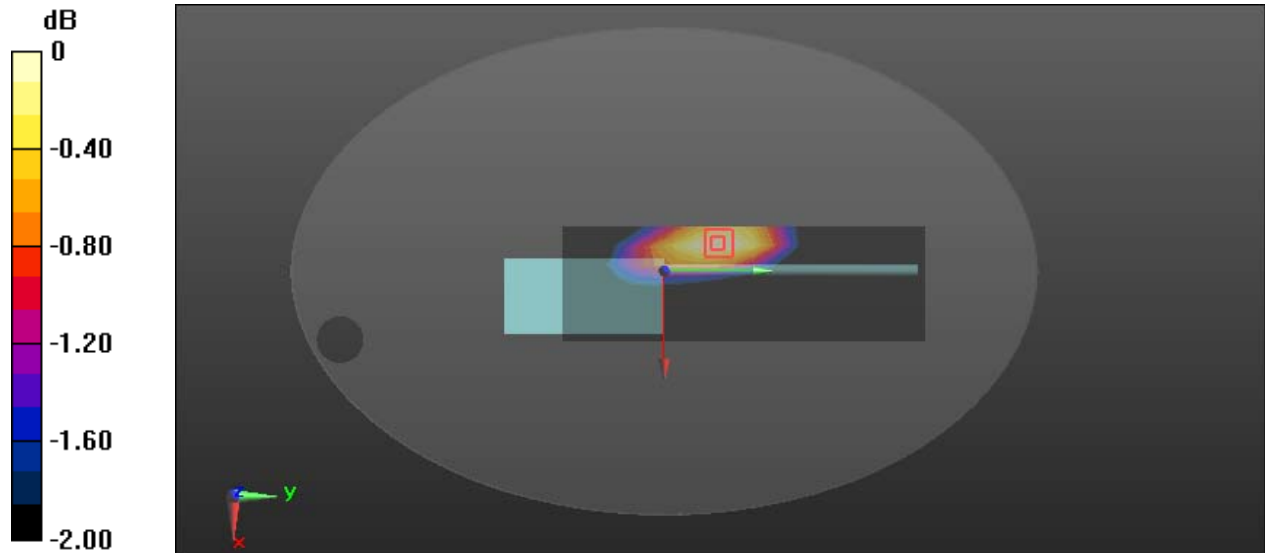

0 dB = 0.0883 W/kg = -10.54 dBW/kg

**Plot5#: 462.625MHz\_ Body Back****DUT: GMRS Radio; Type: GMRS Radio; Serial: 2D9B-1**

Communication System: FM; Frequency: 462.625 MHz; Duty Cycle: 1:1  
Medium parameters used (interpolated):  $f = 462.625$  MHz;  $\sigma = 0.864$  S/m;  $\epsilon_r = 43.755$ ;  $\rho = 1000$  kg/m<sup>3</sup>  
Phantom section: Flat Section

## DASY5 Configuration:

- Probe: ES3DV2 - SN3019; ConvF(6.97, 6.97, 6.97) @ 462.625 MHz; Calibrated: 2022/11/22
- Sensor-Surface: 3mm (Mechanical Surface Detection)
- Electronics: DAE3 Sn494; Calibrated: 2023/9/11
- Phantom: ELI v5.0; Type: QDOVA002AA; Serial: TP:1078
- Measurement SW: DASY52, Version 52.8 (7); SEMCAD X Version 14.6.10 (7164)

**Area Scan (7x20x1):** Measurement grid: dx=15mm, dy=15mm  
Maximum value of SAR (measured) = 1.19 W/kg

**Zoom Scan (5x5x7)/Cube 0:** Measurement grid: dx=8mm, dy=8mm, dz=5mm  
Reference Value = 35.33 V/m; Power Drift = -0.08 dB  
Peak SAR (extrapolated) = 1.54 W/kg  
**SAR(1 g) = 1.08 W/kg; SAR(10 g) = 0.779 W/kg**  
Maximum value of SAR (measured) = 1.21 W/kg

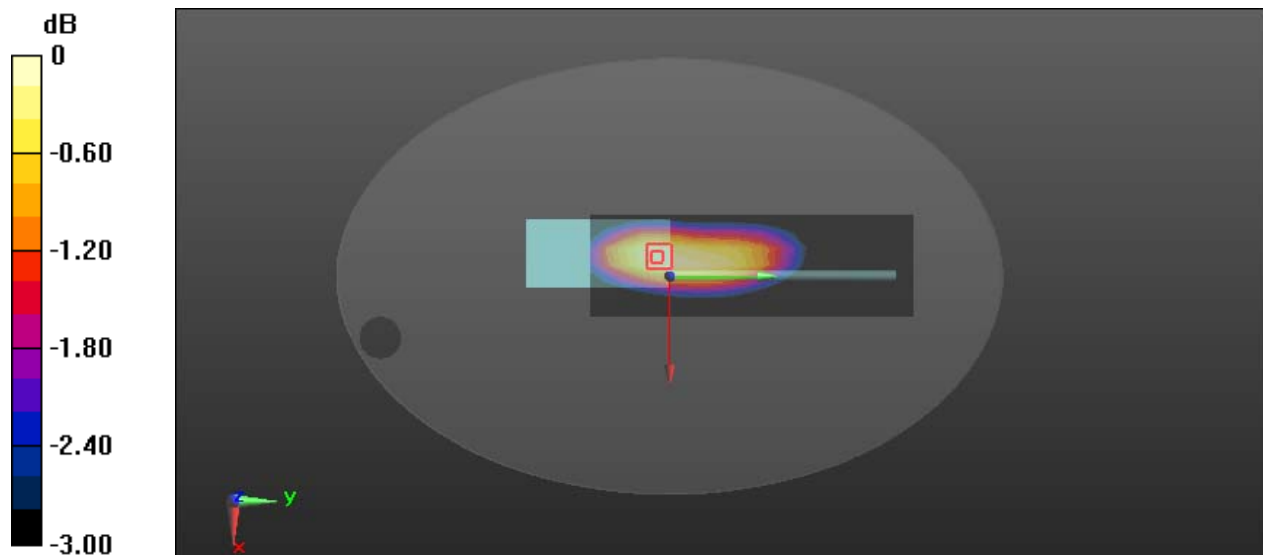

0 dB = 1.21 W/kg = 0.83 dBW/kg



**Plot6#: 462.6375MHz\_ Body Back****DUT: GMRS Radio; Type: GMRS Radio; Serial: 2D9B-1**

Communication System: FM; Frequency: 462.637 MHz; Duty Cycle: 1:1

Medium parameters used (interpolated):  $f = 462.637$  MHz;  $\sigma = 0.864$  S/m;  $\epsilon_r = 43.755$ ;  $\rho = 1000$  kg/m<sup>3</sup>

Phantom section: Flat Section

DASY5 Configuration:

- Probe: ES3DV2 - SN3019; ConvF(6.97, 6.97, 6.97) @ 462.637 MHz; Calibrated: 2022/11/22
- Sensor-Surface: 3mm (Mechanical Surface Detection)
- Electronics: DAE3 Sn494; Calibrated: 2023/9/11
- Phantom: ELI v5.0; Type: QDOVA002AA; Serial: TP:1078
- Measurement SW: DASY52, Version 52.8 (7); SEMCAD X Version 14.6.10 (7164)

**Area Scan (7x18x1):** Measurement grid: dx=15mm, dy=15mm

Maximum value of SAR (measured) = 1.56 W/kg

**Zoom Scan (5x5x7)/Cube 0:** Measurement grid: dx=8mm, dy=8mm, dz=5mm

Reference Value = 38.34 V/m; Power Drift = 0.01 dB

Peak SAR (extrapolated) = 1.99 W/kg

**SAR(1 g) = 1.38 W/kg; SAR(10 g) = 0.994 W/kg**

Maximum value of SAR (measured) = 1.56 W/kg

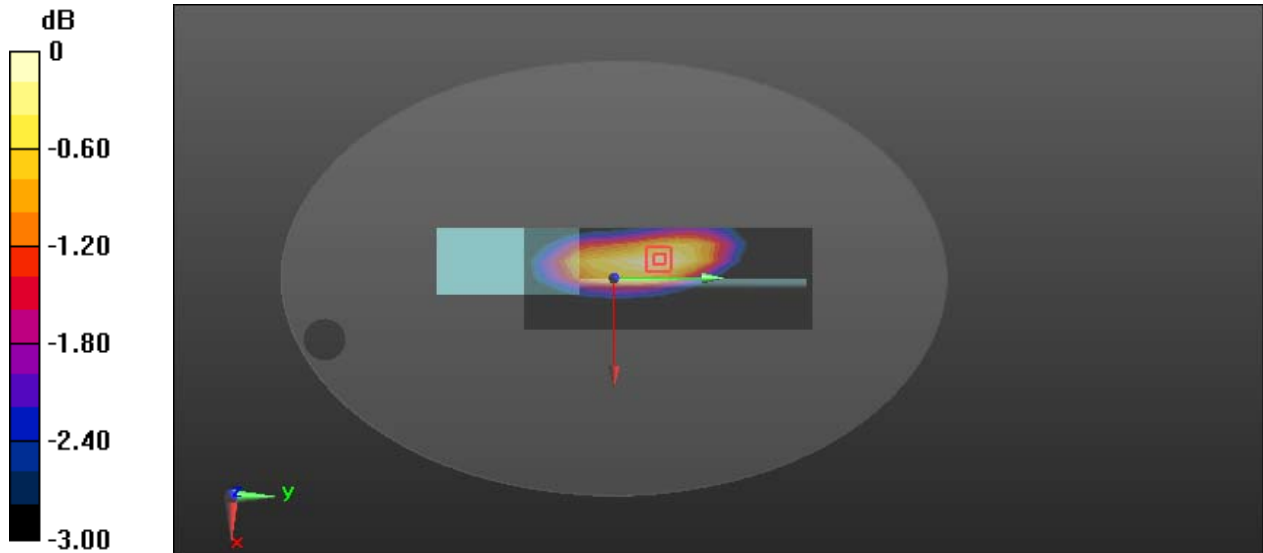

0 dB = 1.56 W/kg = 1.93 dBW/kg

**Plot7#: 467.625MHz \_ Body Back****DUT: GMRS Radio; Type: GMRS Radio; Serial: 2D9B-1**

Communication System: FM; Frequency: 467.625 MHz; Duty Cycle: 1:1

Medium parameters used (interpolated):  $f = 467.625$  MHz;  $\sigma = 0.866$  S/m;  $\epsilon_r = 43.709$ ;  $\rho = 1000$  kg/m<sup>3</sup>

Phantom section: Flat Section

DASY5 Configuration:

- Probe: ES3DV2 - SN3019; ConvF(6.97, 6.97, 6.97) @ 467.625 MHz; Calibrated: 2022/11/22
- Sensor-Surface: 3mm (Mechanical Surface Detection)
- Electronics: DAE3 Sn494; Calibrated: 2023/9/11
- Phantom: ELI v5.0; Type: QDOVA002AA; Serial: TP:1078
- Measurement SW: DASY52, Version 52.8 (7); SEMCAD X Version 14.6.10 (7164)

**Area Scan (7x20x1):** Measurement grid: dx=15mm, dy=15mm

Maximum value of SAR (measured) = 1.16 W/kg

**Zoom Scan (5x5x7)/Cube 0:** Measurement grid: dx=8mm, dy=8mm, dz=5mm

Reference Value = 33.88 V/m; Power Drift = -0.08 dB

Peak SAR (extrapolated) = 1.49 W/kg

**SAR(1 g) = 1.05 W/kg; SAR(10 g) = 0.755 W/kg**

Maximum value of SAR (measured) = 1.19 W/kg

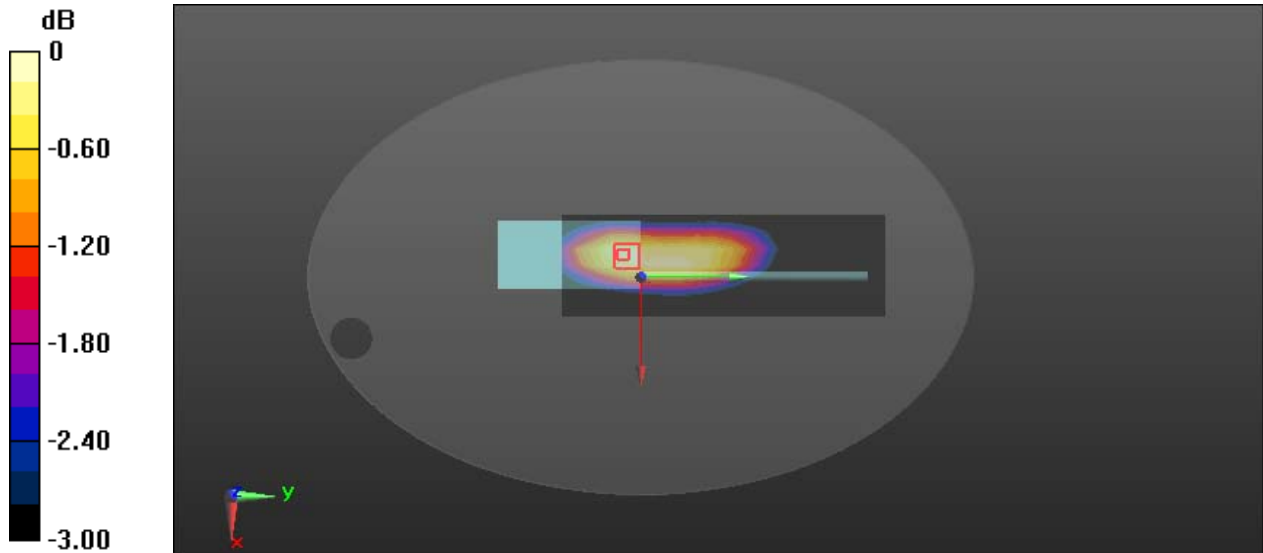

0 dB = 1.19 W/kg = 0.76 dBW/kg

**Plot8#: 467.6375MHz \_ Body Back****DUT: GMRS Radio; Type: GMRS Radio; Serial: 2D9B-1**

Communication System: FM; Frequency: 467.637 MHz; Duty Cycle: 1:1

Medium parameters used (interpolated):  $f = 467.637$  MHz;  $\sigma = 0.866$  S/m;  $\epsilon_r = 43.709$ ;  $\rho = 1000$  kg/m<sup>3</sup>

Phantom section: Flat Section

DASY5 Configuration:

- Probe: ES3DV2 - SN3019; ConvF(6.97, 6.97, 6.97) @ 467.637 MHz; Calibrated: 2022/11/22
- Sensor-Surface: 3mm (Mechanical Surface Detection)
- Electronics: DAE3 Sn494; Calibrated: 2023/9/11
- Phantom: ELI v5.0; Type: QDOVA002AA; Serial: TP:1078
- Measurement SW: DASY52, Version 52.8 (7); SEMCAD X Version 14.6.10 (7164)

**Area Scan (7x18x1):** Measurement grid: dx=15mm, dy=15mm

Maximum value of SAR (measured) = 0.168 W/kg

**Zoom Scan (5x5x7)/Cube 0:** Measurement grid: dx=8mm, dy=8mm, dz=5mm

Reference Value = 12.99 V/m; Power Drift = 0.03 dB

Peak SAR (extrapolated) = 0.208 W/kg

**SAR(1 g) = 0.144 W/kg; SAR(10 g) = 0.102 W/kg**

Maximum value of SAR (measured) = 0.163 W/kg

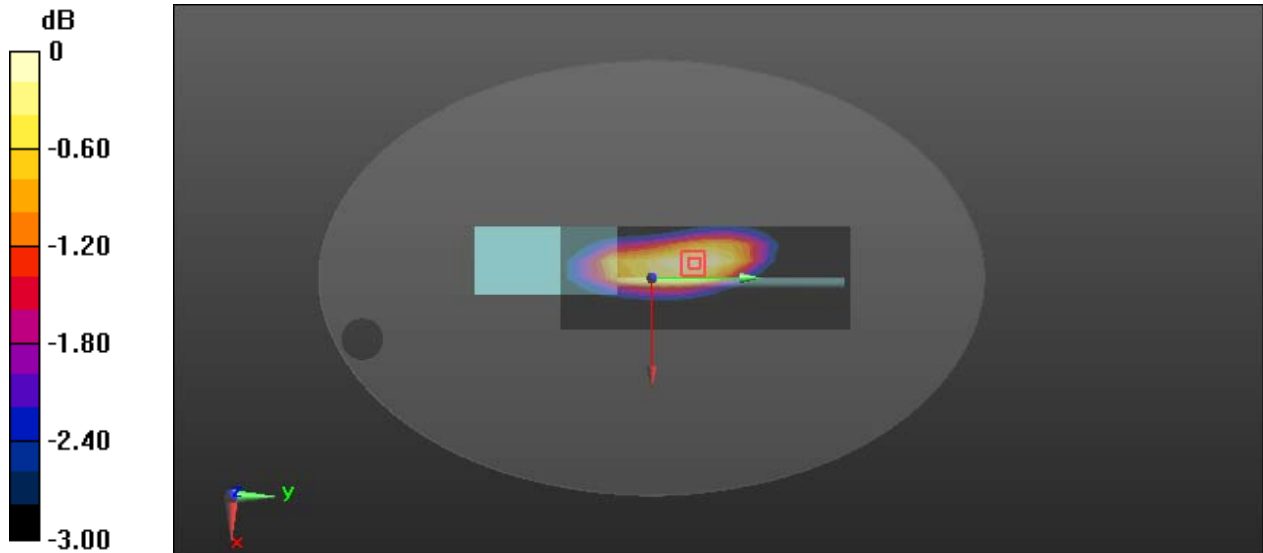

0 dB = 0.163 W/kg = -7.88 dBW/kg

## APPENDIX A MEASUREMENT UNCERTAINTY

The uncertainty budget has been determined for the measurement system and is given in the following Table.

### Measurement uncertainty evaluation for IEEE1528-2013 SAR test

Source of uncertainty	Tolerance/ uncertainty ± %	Probability distribution	Divisor	ci (1 g)	ci (10 g)	Standard uncertainty ± %, (1 g)	Standard uncertainty ± %, (10 g)
<b>Measurement system</b>							
Probe calibration	6.55	N	1	1	1	6.3	6.3
Axial Isotropy	4.7	R	$\sqrt{3}$	1	1	2.7	2.7
Hemispherical Isotropy	9.6	R	$\sqrt{3}$	0	0	0.0	0.0
Boundary effect	1.0	R	$\sqrt{3}$	1	1	0.6	0.6
Linearity	4.7	R	$\sqrt{3}$	1	1	2.7	2.7
Detection limits	1.0	R	$\sqrt{3}$	1	1	0.6	0.6
Readout electronics	0.3	N	1	1	1	0.3	0.3
Response time	0.0	R	$\sqrt{3}$	1	1	0.0	0.0
Integration time	0.0	R	$\sqrt{3}$	1	1	0.0	0.0
RF ambient conditions – noise	1.0	R	$\sqrt{3}$	1	1	0.6	0.6
RF ambient conditions– reflections	1.0	R	$\sqrt{3}$	1	1	0.6	0.6
Probe positioner mech. Restrictions	0.8	R	$\sqrt{3}$	1	1	0.5	0.5
Probe positioning with respect to phantom shell	6.7	R	$\sqrt{3}$	1	1	3.9	3.9
Post-processing	2.0	R	$\sqrt{3}$	1	1	1.2	1.2
<b>Test sample related</b>							
Test sample positioning	2.8	N	1	1	1	2.8	2.8
Device holder uncertainty	6.3	N	1	1	1	6.3	6.3
Drift of output power	5.0	R	$\sqrt{3}$	1	1	2.9	2.9
<b>Phantom and set-up</b>							
Phantom uncertainty (shape and thickness tolerances)	4.0	R	$\sqrt{3}$	1	1	2.3	2.3
Liquid conductivity target)	5.0	R	$\sqrt{3}$	0.64	0.43	1.8	1.2
Liquid conductivity meas.)	2.5	N	1	0.64	0.43	1.6	1.1
Liquid permittivity target)	5.0	R	$\sqrt{3}$	0.6	0.49	1.7	1.4
Liquid permittivity meas.)	2.5	N	1	0.6	0.49	1.5	1.2
Combined standard uncertainty		RSS				12.2	12.0
Expanded uncertainty 95 % confidence interval)						24.1	23.7

## Measurement uncertainty evaluation for IEC62209-1 SAR test

Source of uncertainty	Tolerance/uncertainty ± %	Probability distribution	Divisor	ci (1 g)	ci (10 g)	Standard uncertainty ± %, (1 g)	Standard uncertainty ± %, (10 g)
<b>Measurement system</b>							
Probe calibration	6.55	N	1	1	1	6.3	6.3
Axial Isotropy	4.7	R	√3	1	1	2.7	2.7
Hemispherical Isotropy	9.6	R	√3	0	0	0.0	0.0
Boundary effect	1.0	R	√3	1	1	0.6	0.6
Linearity	4.7	R	√3	1	1	2.7	2.7
Detection limits	1.0	R	√3	1	1	0.6	0.6
Readout electronics	0.3	N	1	1	1	0.3	0.3
Response time	0.0	R	√3	1	1	0.0	0.0
Integration time	0.0	R	√3	1	1	0.0	0.0
RF ambient conditions – noise	1.0	R	√3	1	1	0.6	0.6
Probe positioning with respect to phantom shell	6.7	R	√3	1	1	3.9	3.9
Probe positioner mech. Restrictions	0.8	R	√3	1	1	0.5	0.5
RF ambient conditions– reflections	1.0	R	√3	1	1	0.6	0.6
Post-processing	2.0	R	√3	1	1	1.2	1.2
<b>Test sample related</b>							
Test sample positioning	2.8	N	1	1	1	2.8	2.8
Device holder uncertainty	6.3	N	1	1	1	6.3	6.3
Drift of output power	5.0	R	√3	1	1	2.9	2.9
<b>Phantom and set-up</b>							
Phantom uncertainty (shape and thickness tolerances)	4.0	R	√3	1	1	2.3	2.3
Liquid conductivity target)	5.0	R	√3	0.64	0.43	1.8	1.2
Liquid conductivity meas.)	2.5	N	1	0.64	0.43	1.6	1.1
Liquid permittivity target)	5.0	R	√3	0.6	0.49	1.7	1.4
Liquid permittivity meas.)	2.5	N	1	0.6	0.49	1.5	1.2
Combined standard uncertainty		RSS				12.2	12.0
Expanded uncertainty 95 % confidence interval)						24.0	23.6

## APPENDIX B EUT TEST POSITION PHOTOS

Liquid depth  $\geq 15\text{cm}$

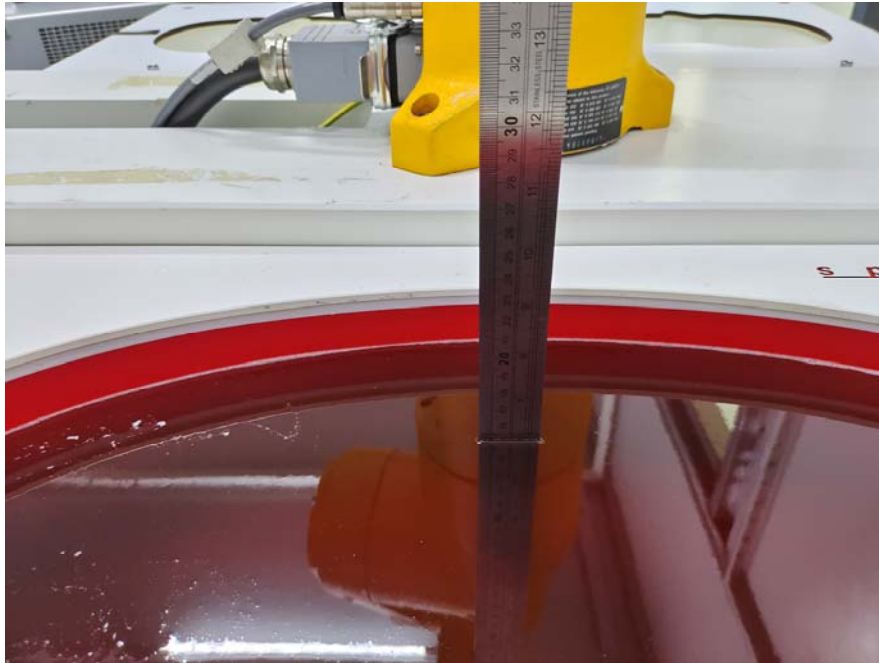

**Face Up Setup Photo (25mm)**

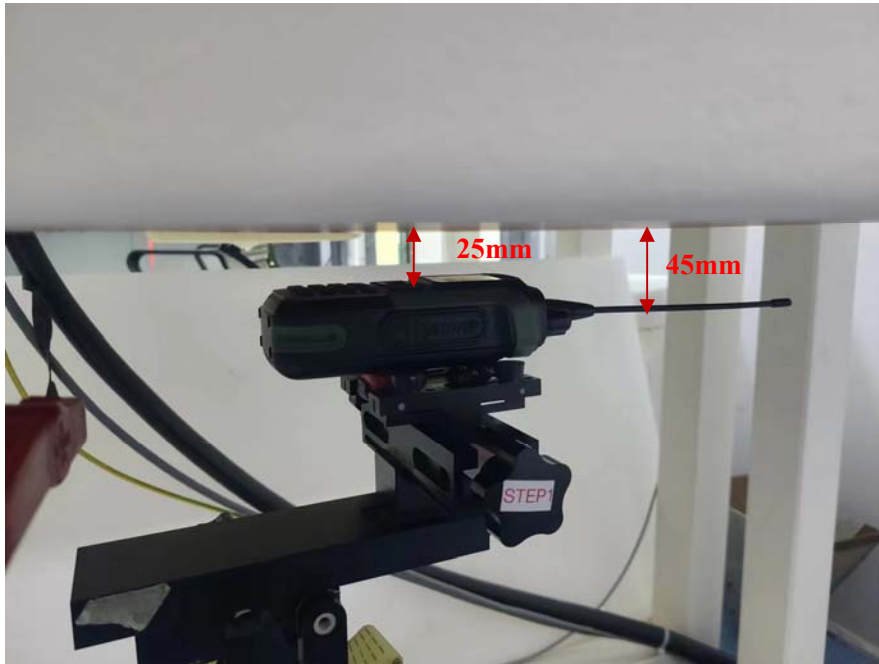

**Body Back Setup Photo (0mm)**

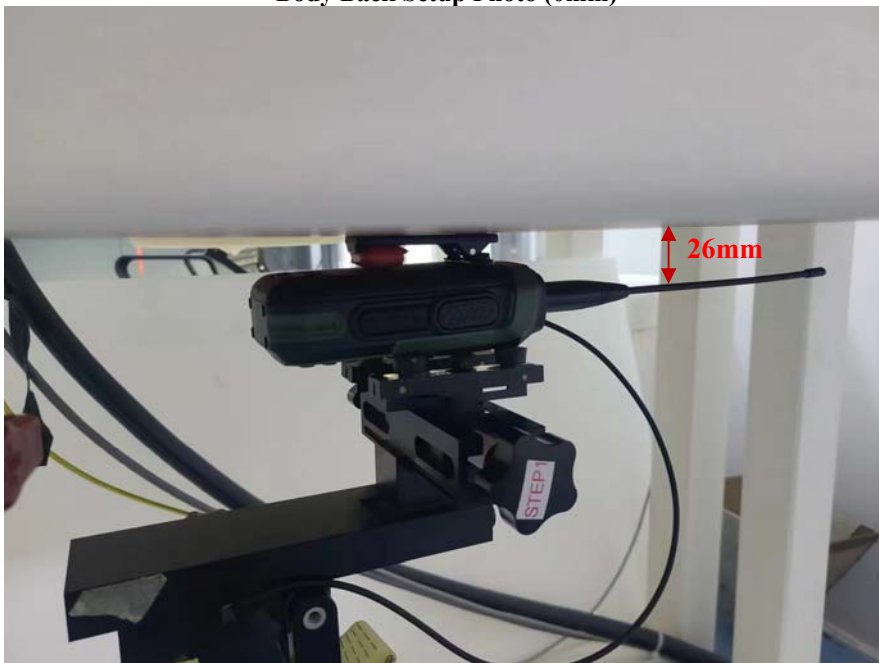

## **APPENDIX C CALIBRATION CERTIFICATES**

---

**Please Refer to the Attachment.**

**\*\*\*\*\* END OF REPORT \*\*\*\*\***