

FCC TEST REPORT
for
DDPAI Technology Co., Ltd

DDPai
Model No.: X2 Pro, X2P lite, X2S, X2

Prepared For : DDPai Technology Co., Ltd
Address : Floor 12, Yihua Finance Building, Nanshan Software Industry
park, Xuefu Rd, Nanshan District, Shenzhen, China

Prepared By : Shenzhen Anbotek Compliance Laboratory Limited
Address : 1/F., Building 1, SEC Industrial Park, No.0409 Qianhai Road,
Nanshan District, Shenzhen, Guangdong, China
Tel: (86) 755-26066544
Fax: (86) 755-26014772

Report Number : R0117020725W
Date of Test : Feb. 23~Mar. 17, 2017
Date of Report : Mar. 20, 2017

TABLE OF CONTENT

Description

Page

Test Report

1. GENERAL INFORMATION.....	4
1.1. Description of Device (EUT).....	4
1.2. Auxiliary Equipment Used during Test.....	5
1.3. Description of Test Facility.....	5
1.4. Measurement Uncertainty.....	5
2. TEST METHODOLOGY.....	6
2.1. Summary of Test Results.....	6
2.2. Description of Test Modes.....	6
2.3. List of channels:.....	7
2.4. Description Of Test Setup.....	8
3. CONDUCTED EMISSION TEST.....	9
3.1. Block Diagram of Test Setup.....	9
3.2 Power Line Conducted Emission Measurement Limits (15.207).....	9
3.3. Configuration of EUT on Measurement.....	10
3.4. Operating Condition of EUT.....	10
3.5. Test Procedure.....	10
3.6. Test equipment.....	10
3.7. Power Line Conducted Emission Measurement Results.....	10
4. FCC PART 15.247 REQUIREMENTS FOR DSSS & OFDM MODULATION.....	13
4.1 Test Setup.....	13
4.2 6dB Bandwidth.....	13
4.3. Maximum Output Power Test.....	22
4.4. 100 kHz bandwidth outside the frequency Measurement.....	30
4.5. Peak Power Spectral Density.....	36
4.6. Radiated Emissions and Band Edge Measurement.....	44
5. ANTENNA APPLICATION.....	56
5.1. Antenna requirement.....	56
5.2. Result.....	56
6. PHOTOGRAPH.....	57
6.1. Photo of Conducted Emission Measurement.....	57
6.2. Photo of Radiation Emission Test.....	57
APPENDIX II (EXTERNAL PHOTOS).....	59
APPENDIX III(INTERNAL PHOTOS).....	66

TEST REPORT

Applicant : DDPAI Technology Co., Ltd
Manufacturer : DDPAI Technology Co., Ltd
EUT : DDPai
Model No. : X2 Pro, X2P lite, X2S, X2
Serial No. : N.A.
Trade Mark : N.A.
Rating : Input DC 12V, 1A

Measurement Procedure Used:
FCC Part15 Subpart C 2016, Paragraph 15.247

The device described above is tested by Shenzhen Anbotek Compliance Laboratory Limited to determine the maximum emission levels emanating from the device and the severe levels of the device can endure and its performance criterion. The measurement results are contained in this test report and Shenzhen Anbotek Compliance Laboratory Limited is assumed full of responsibility for the accuracy and completeness of these measurements. Also, this report shows that the EUT (Equipment Under Test) is technically compliant with the FCC Part 15 Subpart C requirements.

This report applies to above tested sample only and shall not be reproduced in part without written approval of Shenzhen Anbotek Compliance Laboratory Limited.

Date of Test : Feb. 23~Mar. 17, 2017

Prepared by : 
(Tested Engineer / Winkey Wang)

Reviewer : 
(Project Manager / Brown Lu)

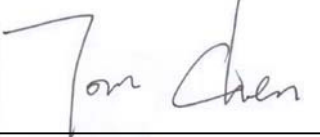
Approved & Authorized Signer : 
(Manager / Tom Chen)

1. GENERAL INFORMATION

1.1. Description of Device (EUT)

EUT : DDPai

Model Number : X2 Pro, X2P lite, X2S, X2
(Note: All samples are the same except the model number and colour, so we prepare “X2 Pro” for test only.)

Test Power Supply : DC 12V

RF Transmission Frequency : 2412MHz~2462MHz (802.11b/802.11g/802.11n(HT20))
2422MHz~2452MHz (802.11n(HT40))

Channels : 11 For (802.11b/802.11g/802.11n(HT20))
7 For (802.11n(HT40))

Modulation : WiFi: 802.11b CCK; 802.11g OFDM; 802.11n MCS

Antenna Type : PIFA Antenna

Antenna Gain: : 2 dBi

Applicant : DDPAI Technology Co., Ltd
Address : Floor 12, Yihua Finance Building, Nanshan Software Industry park,
Xuefu Rd, Nanshan District, Shenzhen, China

Manufacturer : DDPAI Technology Co., Ltd
Address : Floor 12, Yihua Finance Building, Nanshan Software Industry park,
Xuefu Rd, Nanshan District, Shenzhen, China

Date of receipt : Feb. 23, 2017
Date of Test : Feb. 23~Mar. 17, 2017

1.2. Auxiliary Equipment Used during Test

Car Adapter : Input: DC 12V, 1A
Output: DC 12V, 1A

1.3. Description of Test Facility

The test facility is recognized, certified, or accredited by the following organizations:

FCC-Registration No.: 752021

Shenzhen Anbotek Compliance Laboratory Limited, EMC Laboratory has been registered and fully described in a report filed with the (FCC) Federal Communications Commission. The acceptance letter from the FCC is maintained in our files. Registration 752021, July 06, 2016.

IC-Registration No.: 8058A-1

Shenzhen Anbotek Compliance Laboratory Limited., EMC Laboratory has been registered and fully described in a report filed with the (IC) Industry Canada. The acceptance letter from the IC is maintained in our files. Registration 8058A, June 13, 2016.

Test Location

All Emissions tests were performed at
Shenzhen Anbotek Compliance Laboratory Limited. at 1/F., Building 1, SEC
Industrial Park, No.0409 Qianhai Road, Nanshan District, Shenzhen, Guangdong,
China

1.4. Measurement Uncertainty

Radiation Uncertainty : Ur = 4.1 dB (Horizontal)
Ur = 4.3 dB (Vertical)

Conduction Uncertainty : Uc = 3.4dB

2. TEST METHODOLOGY

The tests documented in this report were performed in accordance with ANSI C63.10: 2013 and FCC Part 15, Paragraph 15.247.

2.1. Summary of Test Results

The EUT has been tested according to the following specifications:

Standard	Test Type	Result	Notes
FCC Part 15, Paragraph 15.107, 15.207	Conducted Emission Test	PASS	Complies
FCC Part 15, Paragraph 15.247(b)(1)	Maximum Output Power	PASS	Complies
FCC Part 15, Paragraph 15.247(a)(2)	6dB Bandwidth	PASS	Complies
FCC Part 15, Paragraph 15.247(c)	100kHz Bandwidth of Frequency Band Edges	PASS	Complies
FCC Part 15, Paragraph 15.209(a)(f)	Spurious Emission	PASS	Complies
FCC Part 15, Paragraph 15.247(a)(1)	Frequency Separation	-	N/A
FCC Part 15, Paragraph 15.247(a)(1)(iii)	Number of Hopping Frequency	-	N/A
FCC Part 15, Paragraph 15.247(a)(1)(iii)	Time of Occupancy	-	N/A
FCC Part 15, Paragraph 15.247(c)	Peak Power Density	PASS	Complies

2.2. Description of Test Modes

The EUT has been tested under operating condition.

Software used to control the EUT for staying in continuous transmitting and receiving mode is programmed.

IEEE802.11b: Channel 1(2412MHz), Channel 6(2437MHz) and Channel 11(2462MHz) with 1 Mbps lowest data rate (worst case) are chosen for the final testing.

IEEE802.11g: Channel 1(2412MHz), Channel 6(2437MHz) and Channel 11(2462MHz) with 6 Mbps lowest data rate (the worst case) are chosen for the final testing.

IEEE802.11n (HT20): Channel 1(2412MHz), Channel 6(2437MHz) and Channel 11(2462MHz) with MCS 0 Mbps lowest data rate (the worst case) are chosen for the final testing.

IEEE802.11n (HT40): Channel 3(2422MHz), Channel 6(2437MHz) and Channel 9(2452MHz) with MCS 0 Mbps lowest data rate (the worst case) are chosen for the final testing.

2.3. List of channels:

√ - available

X - tested

Number	Frequency(MHz)		802.11 b/g/n (HT20)	802.11 b/g/n (HT40)
1	2412	√	X	
2	2417	√		
3	2422	√		X
4	2427	√		
5	2432	√		
6	2437	√	X	X
7	2442	√		
8	2447	√		
9	2452	√		X
10	2457	√		
11	2462	√	X	

2.4. Description Of Test Setup

CE

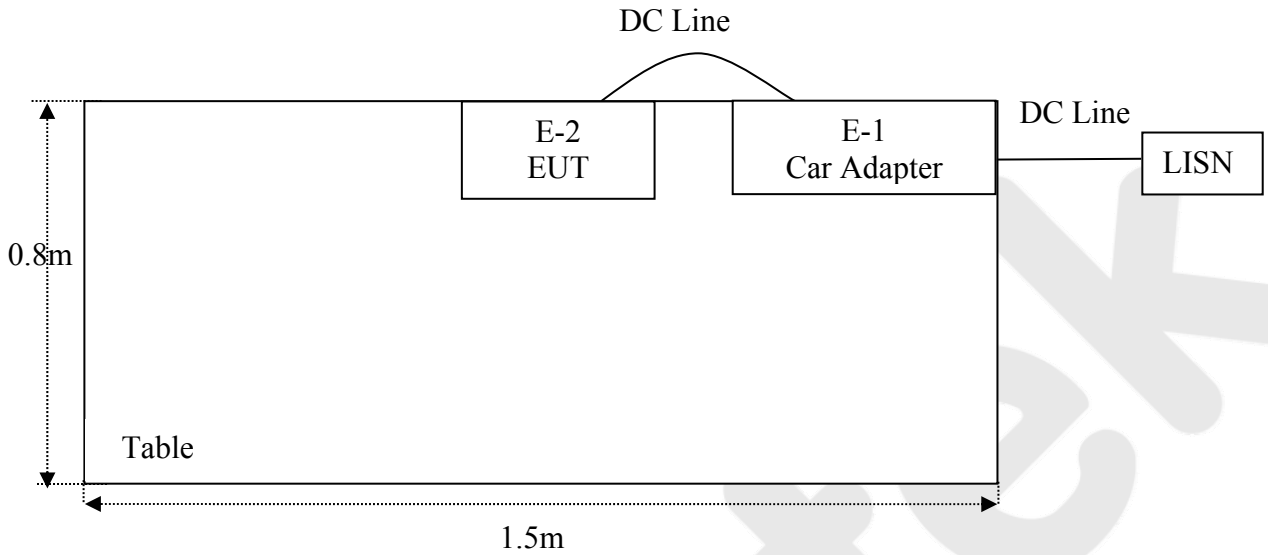

RE

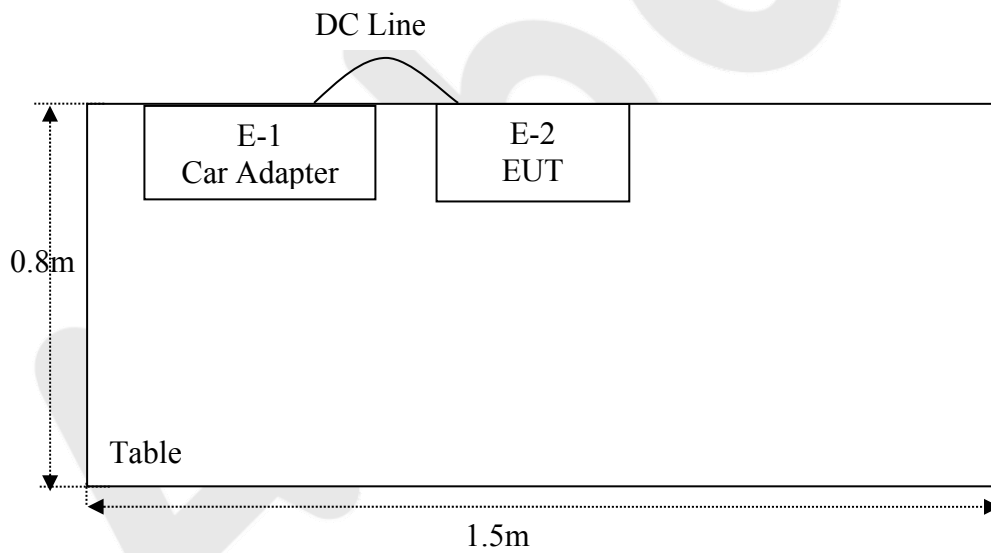

3. Conducted Emission Test

3.1. Block Diagram of Test Setup

3.1.1. Block diagram of connection between the EUT and simulators

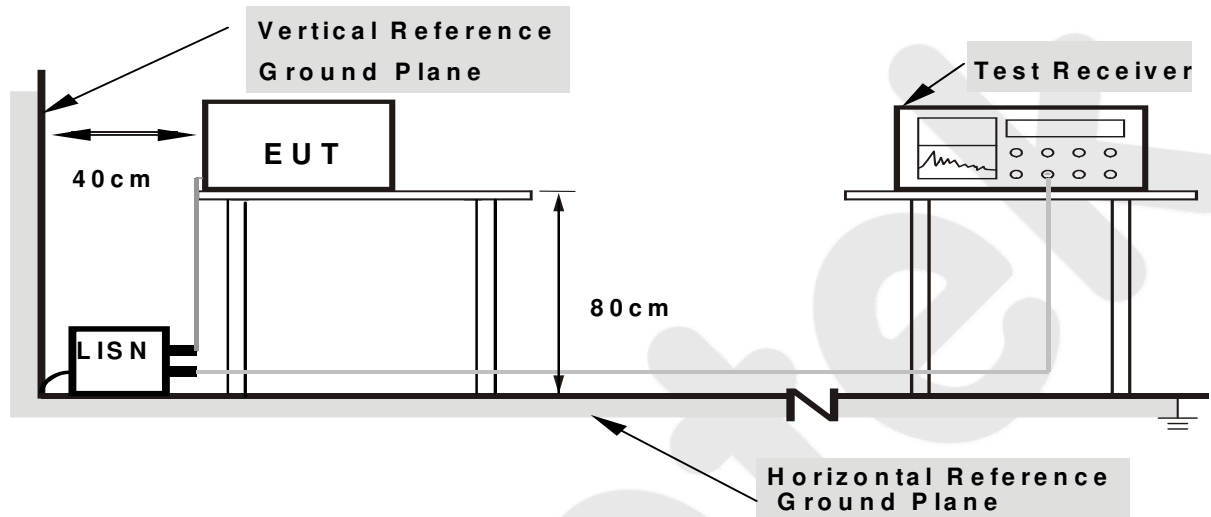

- Note:**
1. Support units were connected to second LISN.
 2. Both of LISNs (AMN) are 80 cm from EUT and at least 80 from other units and other metal planes

3.2 Power Line Conducted Emission Measurement Limits (15.207)

Frequency MHz	Limits dB(μ V)	
	Quasi-peak Level	Average Level
0.15 ~ 0.50	66 ~ 56*	56 ~ 46*
0.50 ~ 5.00	56	46
5.00 ~ 30.00	60	50

- Notes:
1. *Decreasing linearly with logarithm of frequency.
 2. The lower limit shall apply at the transition frequencies.

3.3. Configuration of EUT on Measurement

The following equipments are installed on Power Line Conducted Emission Measurement to meet the commission requirement and operating regulations in a manner which tends to maximize its emission characteristics in a normal application.

3.4. Operating Condition of EUT

- 3.4.1. Setup the EUT and simulator as shown as Section 3.1.
- 3.4.2. Turn on the power of all equipment.
- 3.4.3. Let the EUT work in test mode (WiFi Mode) and measure it.

3.5. Test Procedure

The EUT system is connected to the power mains through a line impedance stabilization network (L.I.S.N.). This provides a 50ohm coupling impedance for the EUT system. Please refer the block diagram of the test setup and photographs. Both sides of AC line are checked to find out the maximum conducted emission. In order to find the maximum emission levels, the relative positions of equipment and all of the interface cables shall be changed according to FCC ANSI C63.10-2013 on Conducted Emission Measurement.

The bandwidth of test receiver (ESCI) set at 9KHz.

The frequency range from 150KHz to 30MHz is checked.

The test results are reported on Section 3.6.

3.6. Test equipment

Item	Equipment	Manufacturer	Model No.	Serial No.	Last Cal.	Cal. Interval
1.	Two-Line V-network	Rohde & Schwarz	ENV216	100055	Jul. 19, 2016	1 Year
2.	EMI Test Receiver	Rohde & Schwarz	ESCI	100627	Jun. 17, 2016	1 Year
3.	RF Switching Unit	Compliance Direction	RSU-M2	38303	Jun. 17, 2016	1 Year

3.7. Power Line Conducted Emission Measurement Results

PASS.

The frequency range from 150KHz to 30 MHz is investigated.
Please refer the following pages.

CONDUCTED EMISSION TEST DATA

Test Site: 1# Shielded Room
 Operating Condition: WiFi Mode
 Test Specification: DC 12V
 Comment: +
 Tem.:25°C Hum.:50%

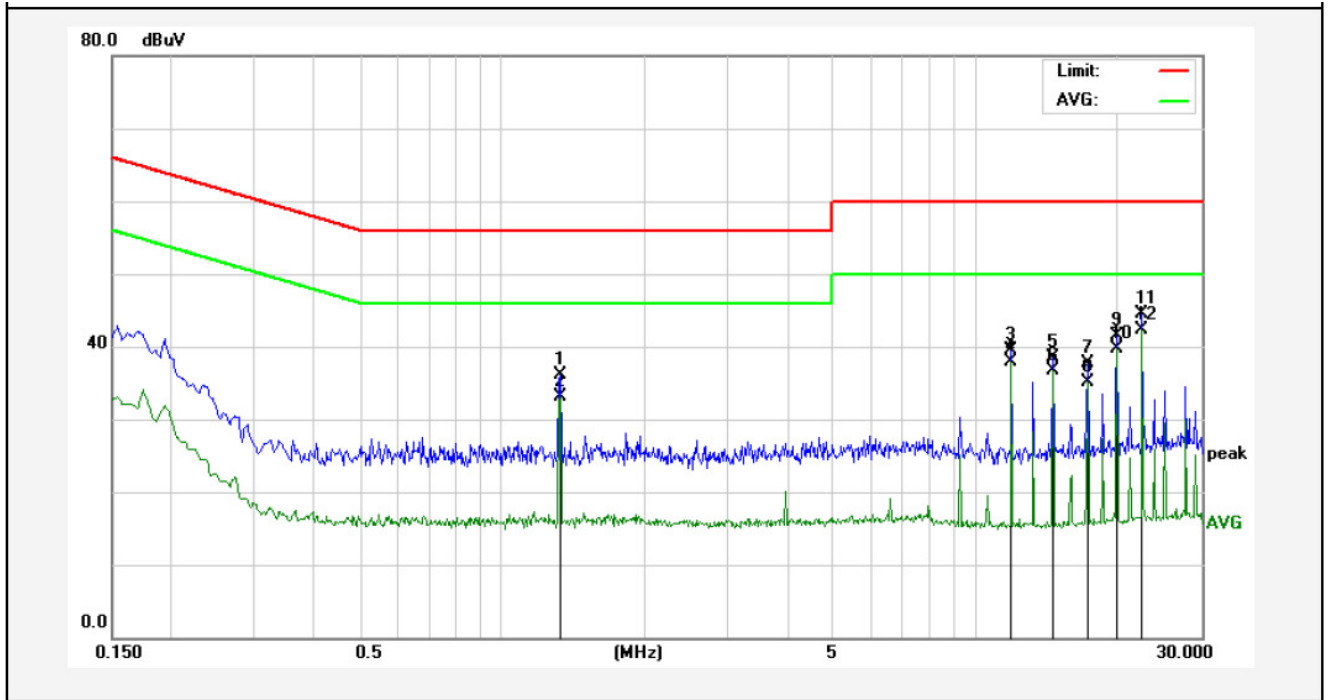

No.	Freq. (MHz)	Reading (dBuV)	Factor (dB)	Result (dBuV)	Limit dBuV	Over Limit (dB)	Detector	Remark
1	1.3260	15.93	20.13	36.06	56.00	-19.94	QP	
2	1.3260	12.98	20.13	33.11	46.00	-12.89	AVG	
3	11.9100	19.23	20.31	39.54	60.00	-20.46	QP	
4	11.9100	17.66	20.31	37.97	50.00	-12.03	AVG	
5	14.5580	18.23	20.27	38.50	60.00	-21.50	QP	
6	14.5580	16.50	20.27	36.77	50.00	-13.23	AVG	
7	17.2060	17.49	20.30	37.79	60.00	-22.21	QP	
8	17.2060	14.87	20.30	35.17	50.00	-14.83	AVG	
9	19.8500	21.20	20.34	41.54	60.00	-18.46	QP	
10	19.8500	19.30	20.34	39.64	50.00	-10.36	AVG	
11	22.5020	24.24	20.31	44.55	60.00	-15.45	QP	
12	22.5020	22.06	20.31	42.37	50.00	-7.63	AVG	

CONDUCTED EMISSION TEST DATA

Test Site: 1# Shielded Room
 Operating Condition: WiFi Mode
 Test Specification: DC 12V
 Comment: -
 Tem.:25°C Hum.:50%

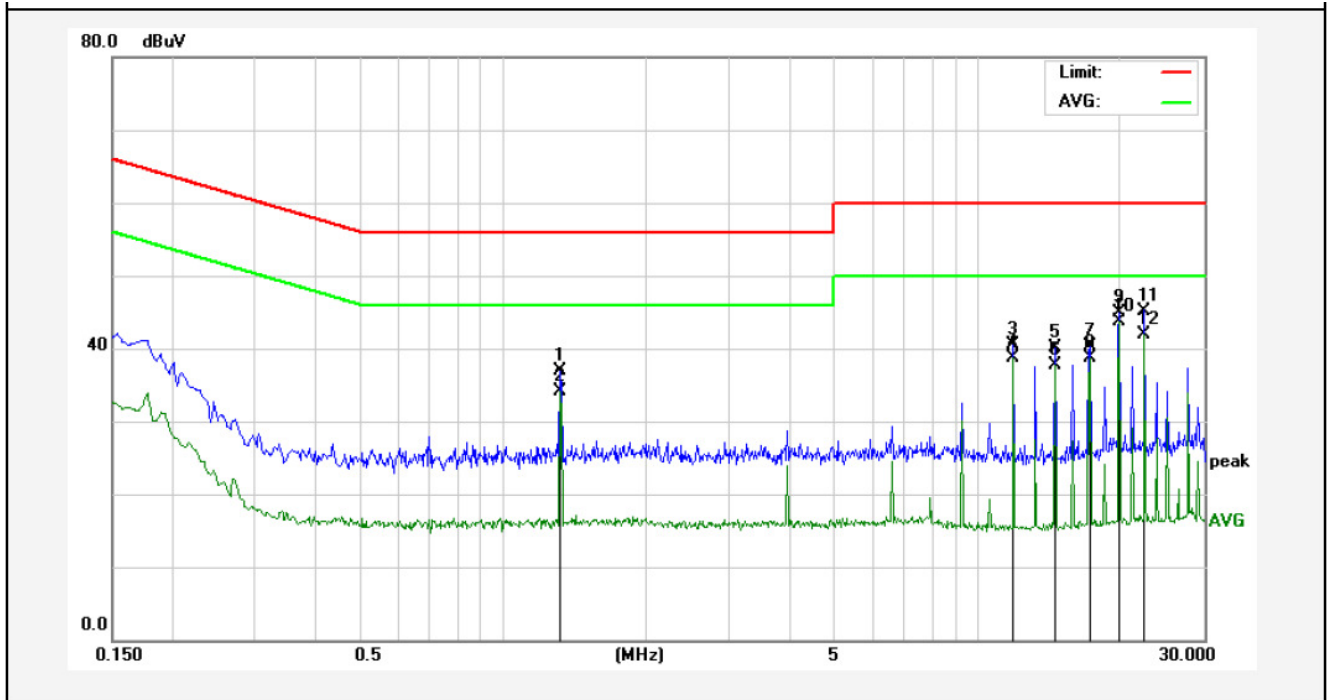

No.	Freq. (MHz)	Reading (dBuV)	Factor (dB)	Result (dBuV)	Limit dBuV	Over Limit (dB)	Detector	Remark
1	1.3220	16.78	20.13	36.91	56.00	-19.09	QP	
2	1.3220	13.99	20.13	34.12	46.00	-11.88	AVG	
3	11.9100	20.22	20.31	40.53	60.00	-19.47	QP	
4	11.9100	18.37	20.31	38.68	50.00	-11.32	AVG	
5	14.5540	19.74	20.27	40.01	60.00	-19.99	QP	
6	14.5540	17.39	20.27	37.66	50.00	-12.34	AVG	
7	17.2020	20.06	20.30	40.36	60.00	-19.64	QP	
8	17.2020	18.44	20.30	38.74	50.00	-11.26	AVG	
9	19.8500	24.53	20.34	44.87	60.00	-15.13	QP	
10	19.8500	23.38	20.34	43.72	50.00	-6.28	AVG	
11	22.4940	24.89	20.31	45.20	60.00	-14.80	QP	
12	22.4940	21.56	20.31	41.87	50.00	-8.13	AVG	

4. FCC Part 15.247 Requirements for DSSS & OFDM Modulation

4.1 Test Setup

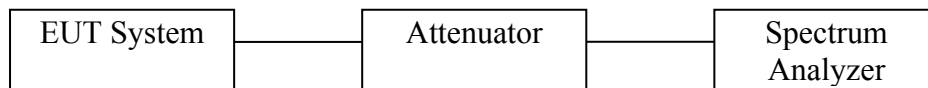

4.2 6dB Bandwidth

6dB Bandwidth

a. Limit

For the direct sequence systems, the minimum 6dB bandwidth shall be at least 500kHz.

b. Test Procedure

1. Place the EUT on the table and set it in the transmitting mode.
2. Remove the antenna from the EUT and then connect a low loss RF cable from the antenna port to the spectrum analyzer.
3. Set the spectrum analyzer as:
RBW = 100kHz, VBW \geq 3*RBW = 300kHz,
Detector= Peak
Trace mode= Max hold.
Sweep- auto couple.
4. Mark the peak frequency and -6dB (upper and lower) frequency.
5. Repeat until all the rest channels are investigated.

c. Test Setup See 4.1

d. Test Equipment

Item	Equipment	Manufacturer	Model No.	Serial No.	Last Cal.	Cal. Interval
1.	Spectrum Analysis	Agilent	E4407B	US39390582	Jul. 12, 2016	1 Year
2.	Preamplifier	Instruments corporation	EMC011830	980100	Jun. 17, 2016	1 Year
3.	EMI Test Receiver	Rohde & Schwarz	ESPI	101604	Jun. 17, 2016	1 Year
4.	Double Ridged Horn Antenna	Instruments corporation	GTH-0118	351600	May 06, 2016	1 Year
5.	Bilog Broadband Antenna	Schwarzbeck	VULB9163	VULB 9163-289	May 06, 2016	1 Year
6.	Pre-amplifier	SONOMA	310N	186860	Jun. 17, 2016	1 Year
7.	EMI Test Software EZ-EMC	SHURPLE	N/A	N/A	N/A	N/A
8	Power Sensor	Agilent	KFSW150502	15I00041SN045	Jun. 17, 2016	1 Year
9	MXA Spectrum Analysis	Agilent	N9020A	MY51170037	Jun. 17, 2016	1 Year
10	MXG RF Vector Signal Generator	Agilent	N5182A	MY48180656	Jun. 17, 2016	1 Year
11	Signal Generator	Agilent	E4421B	MY41000743	Jun. 17, 2016	1 Year
12	DC Power supply	IV	IV-8080	YQSB0096	Jun. 17, 2016	1 Year
13	TEMP&HUMI PROGRAMMABLE CHAMBER	Bell Group	BE-THK-150M8	SE-0137	Jun. 17, 2016	1 Year

e. Test Results

Pass.

f. Test Data

6dB Bandwidth

Test mode: IEEE 802.11b

Channel	Frequency (MHz)	Bandwidth (MHz)	Limit (kHz)	Results
Low	2412	10.11		Pass
Mid	2437	8.568	>500	Pass
High	2462	9.480		Pass

Test mode: IEEE 802.11g

Channel	Frequency (MHz)	Bandwidth (MHz)	Limit (kHz)	Results
Low	2412	9.066		Pass
Mid	2437	15.07	>500	Pass
High	2462	9.068		Pass

Test mode: IEEE 802.11n (HT20)

Channel	Frequency (MHz)	Bandwidth (MHz)	Limit (kHz)	Results
Low	2412	7.594		Pass
Mid	2437	8.546	>500	Pass
High	2462	12.49		Pass

Test mode: IEEE 802.11n (HT40)

Channel	Frequency (MHz)	Bandwidth (MHz)	Limit (kHz)	Results
Low	2422	35.55		Pass
Mid	2437	35.25	>500	Pass
High	2452	35.23		Pass

Test Plots See the following page.

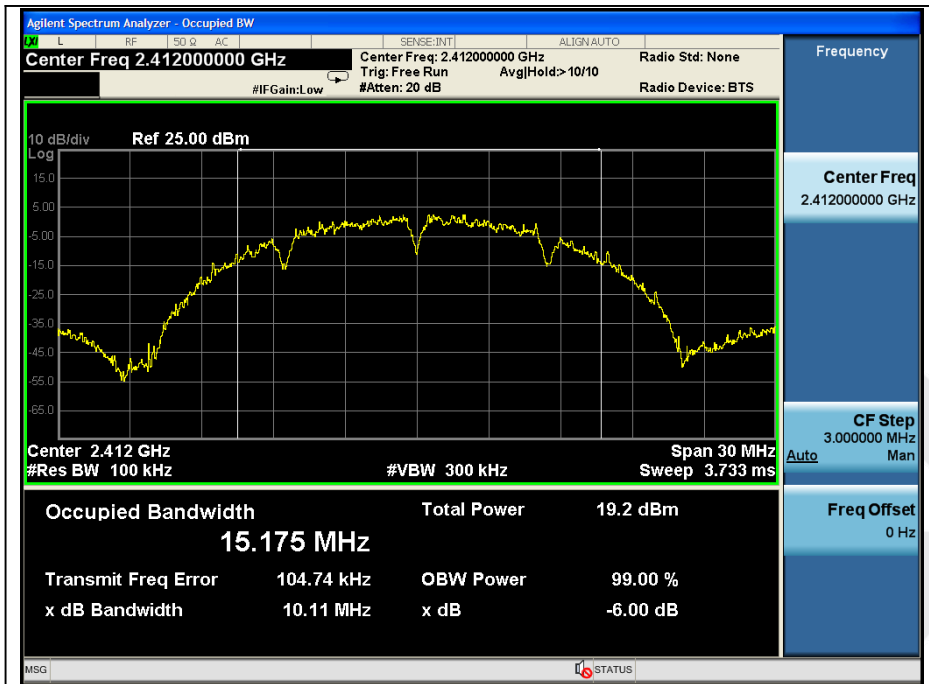

Test Mode: 802.11b---Low

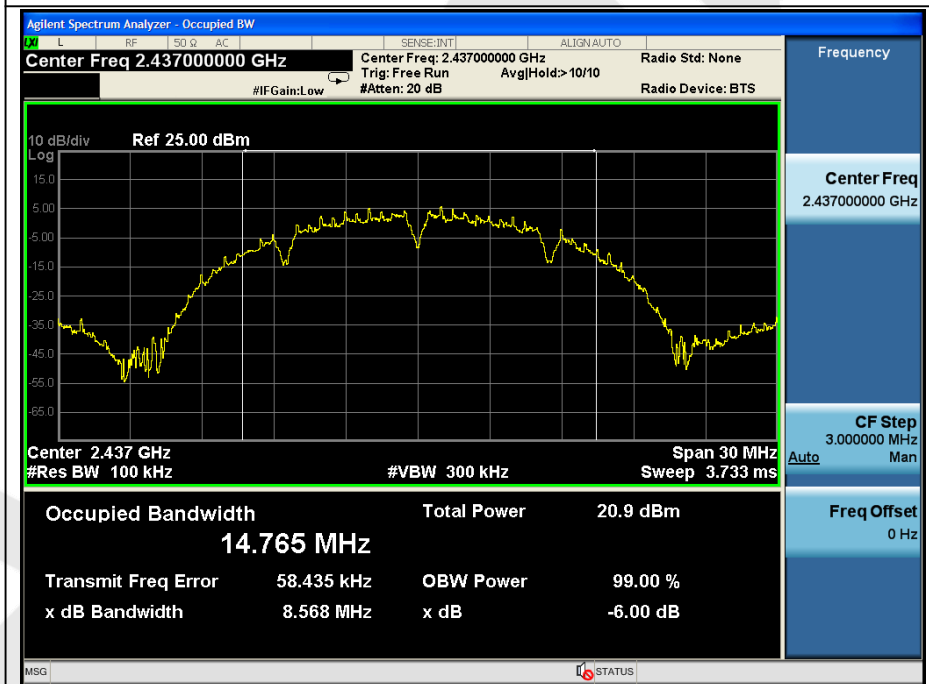

Test Mode: 802.11b---Mid

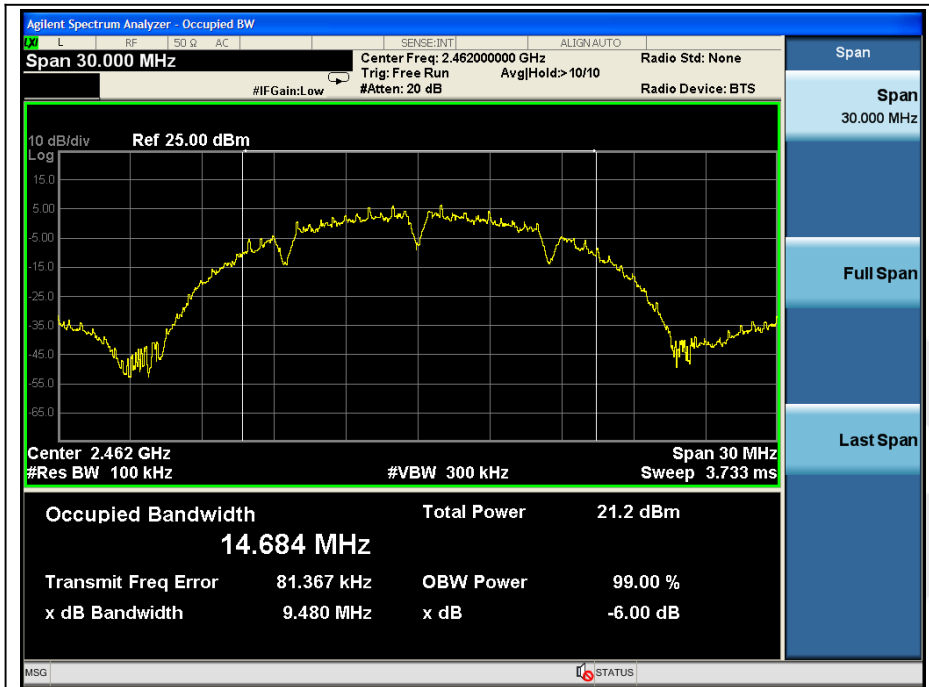

Test Mode: 802.11b---High

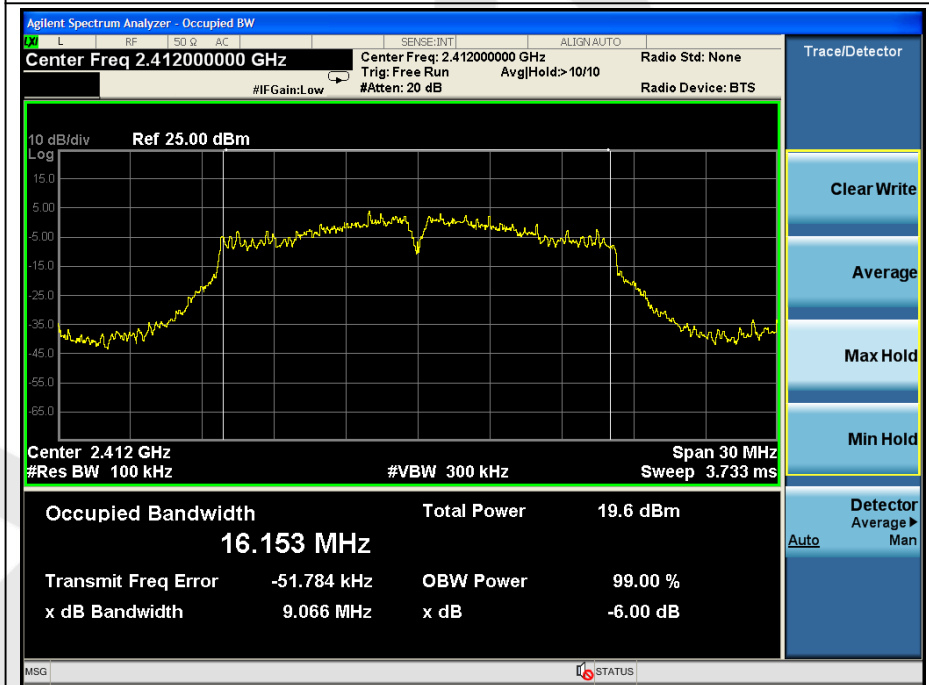

Test Mode: 802.11g---Low

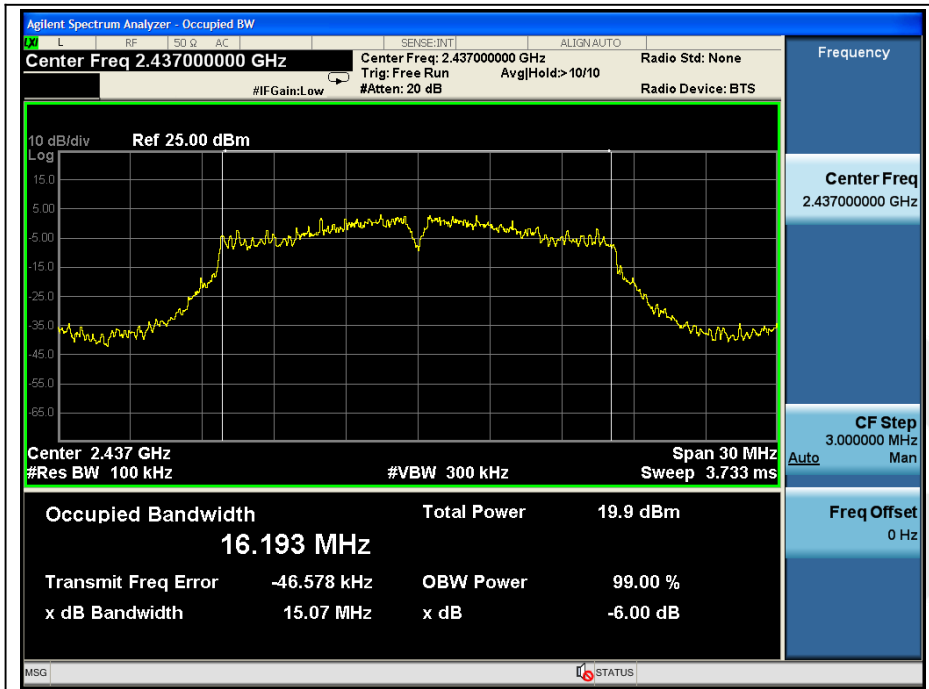

Test Mode: 802.11g---Mid

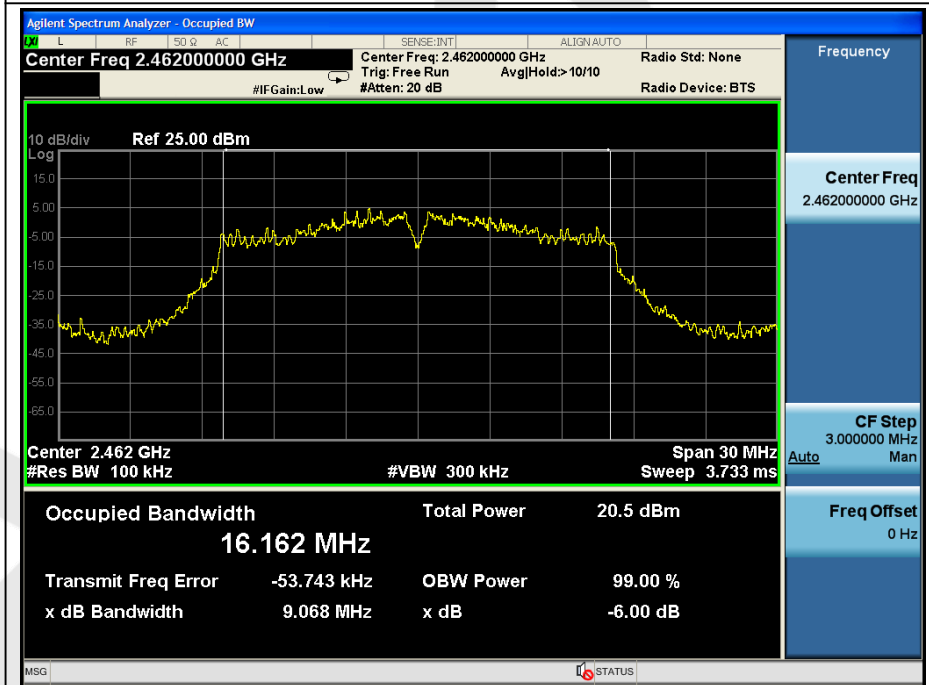

Test Mode: 802.11g---High

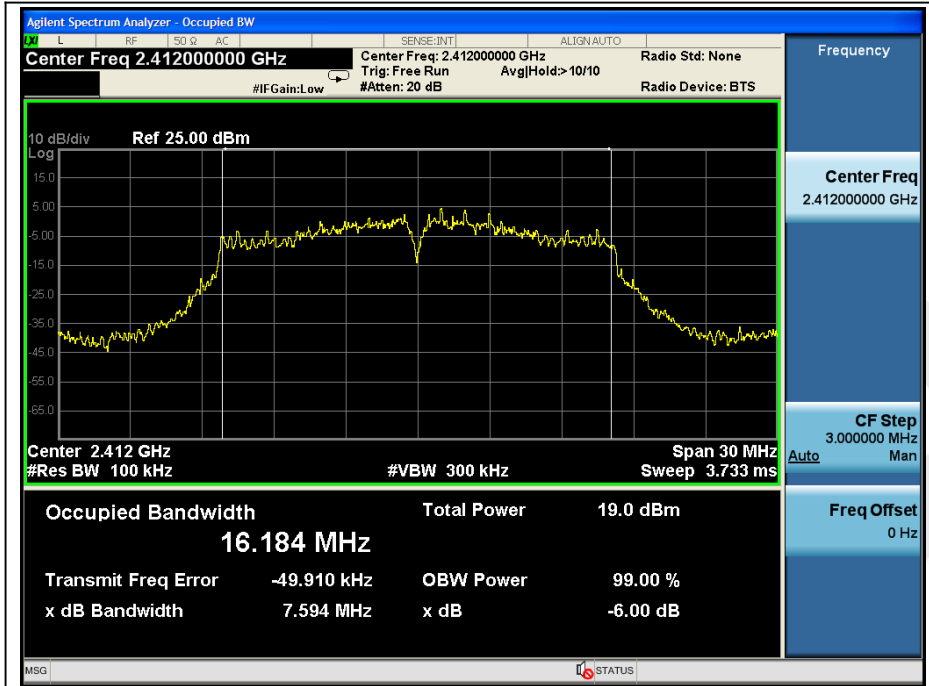

Test Mode: 802.11n20---Low

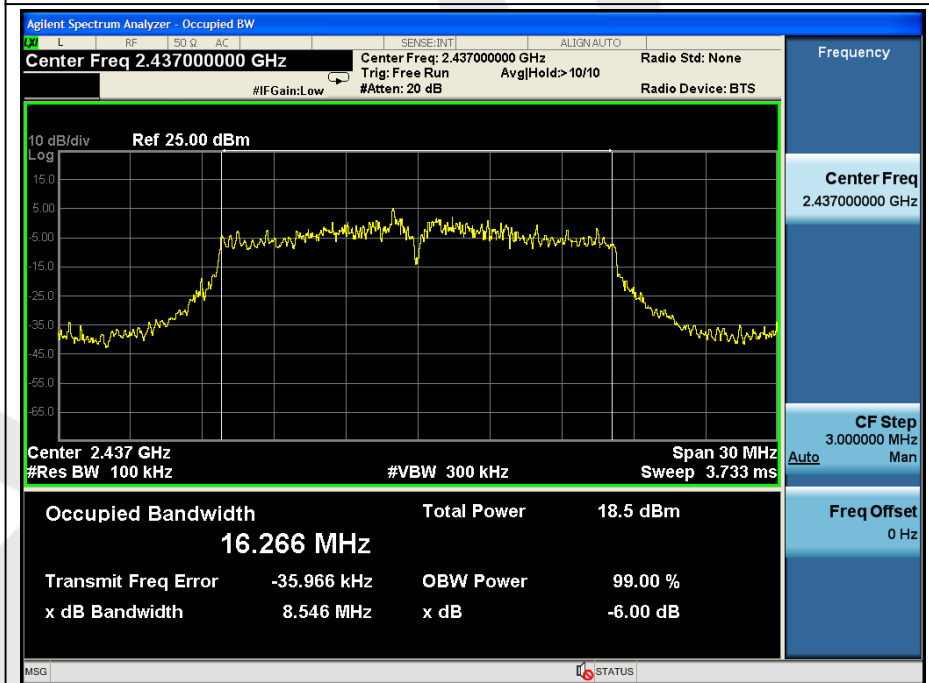

Test Mode: 802.11n20---Mid

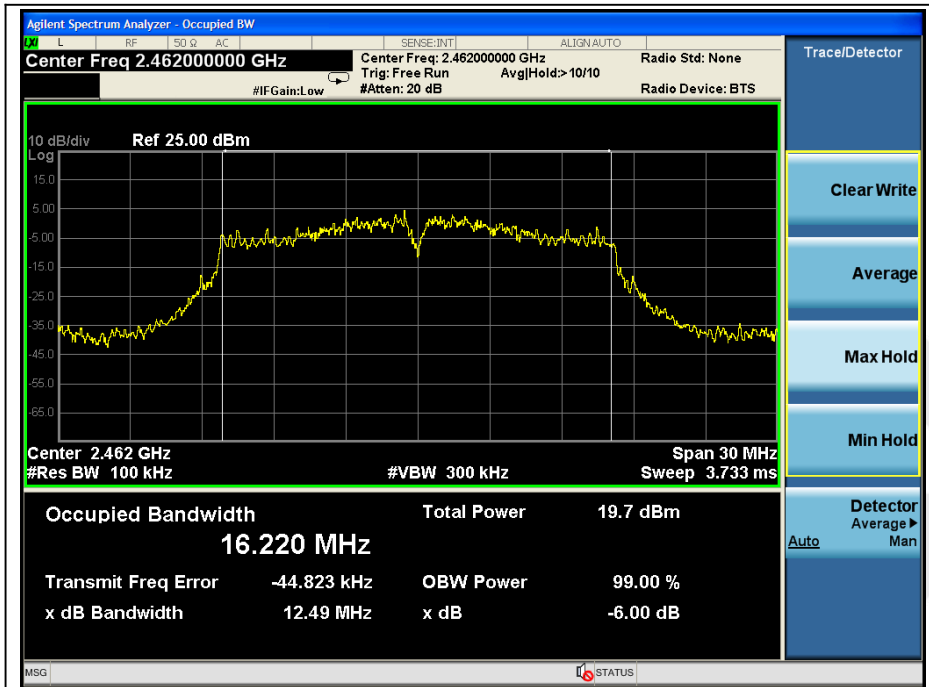

Test Mode: 802.11n20---High

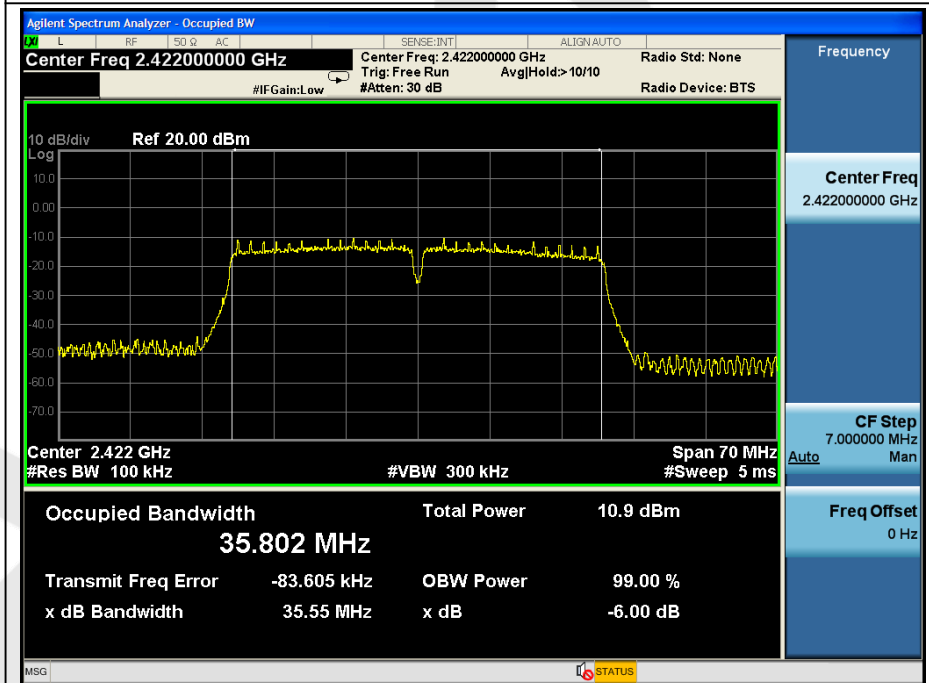

Test Mode: 802.11n40---Low

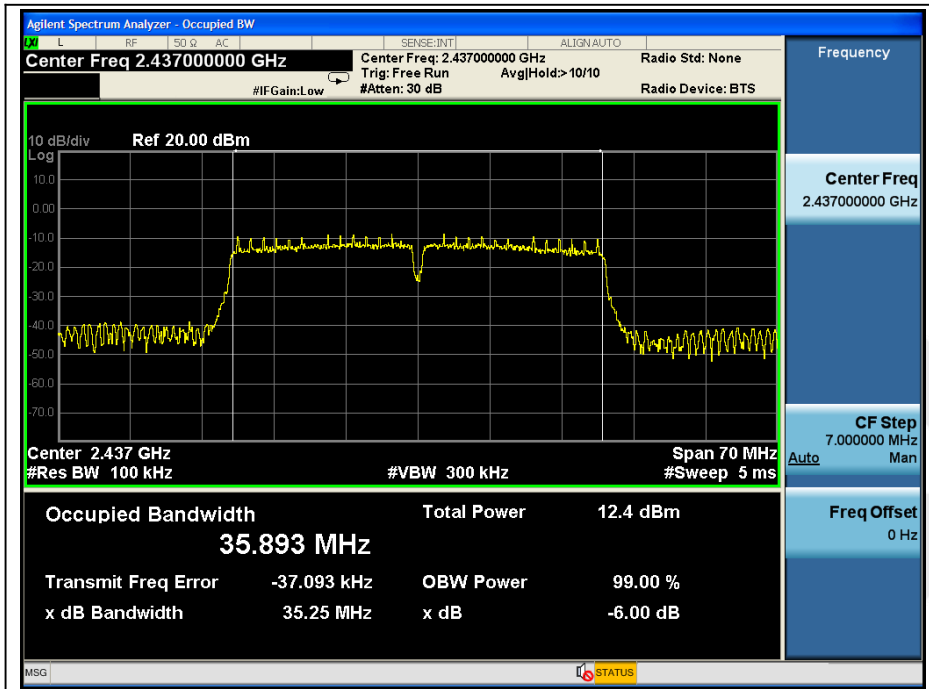

Test Mode: 802.11n40---Mid

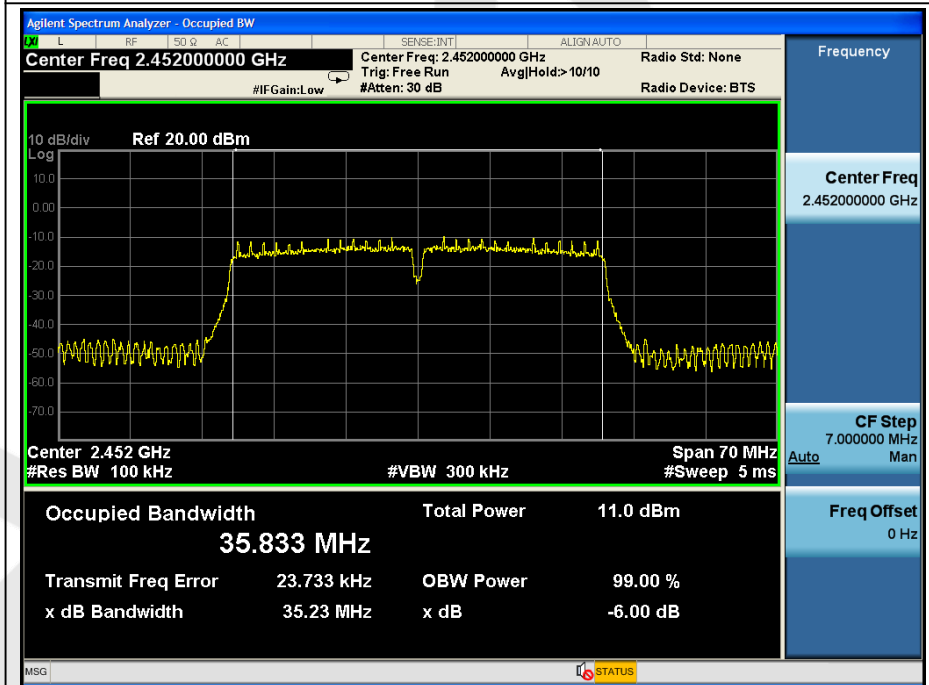

Test Mode: 802.11n40---High

4.3. Maximum Output Power Test

a. Limit

The maximum output power of the intentional radiator shall not exceed the following:

1. For systems using digital modulation in the bands of 902-928 MHz, 2400-2483.5 MHz, and 5725-5850 MHz: 1 watt (30dBm).
2. Except as shown in paragraphs (b)(3) (i), (ii) and (iii) of this section, if transmitting antenna of directional gain greater than 6 dBi are used the peak output power from the intentional radiator shall be reduced below the stated values in paragraphs (b)(1) or (b)(2) of this section, as appropriate, by the amount in dB that the directional gain of the antenna exceeds 6 dBi.

b. Configuration of Measurement

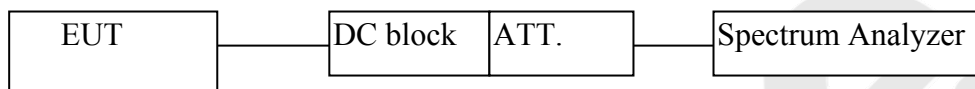

c. Data Rates

IEEE802.11b: Channel 1(2412MHz), Channel 6(2437MHz) and Channel 11(2462MHz) with 1 Mbps data rate (worst case) are chosen for the final testing.

IEEE802.11g: Channel 1(2412MHz), Channel 6(2437MHz) and Channel 11(2462MHz) with 6 Mbps data rate (the worst case) are chosen for the final testing.

IEEE802.11n (HT20: Channel 1(2412MHz), Channel 6(2437MHz) and Channel 11(2462MHz) with 6.5Mbps data rate (the worst case) are chosen for the final testing.

IEEE802.11n (HT40: Channel 3(2422MHz), Channel 6(2437MHz) and Channel 9(2452MHz) with 13.5Mbps data rate (the worst case) are chosen for the final testing.

d. Test Procedure

This test was according the kDB 558074 D01 DTS Meas Guidance v03r05 9.1.1:

1. Set span to at least 1.5 times the OBW.
2. Set the RBW =1~5% of the OBW, not to exceed 1MHz.
3. Set VBW \geq 3*RBW.
4. Detector = Average.
5. Sweep time = auto couple.
6. Trace mode = max hold.
7. Allow trace to fully stabilize.

e. Test Equipment

Same as the equipment listed in 4.2.

f. Test Results

Pass.

g. Test Data

Test mode: IEEE 802.11b

Channel	Frequency (MHz)	Maximum transmit power (dBm)	Limit		Result
			(dBm)	(watts)	
Low	2412	8.31	30	1	Pass
Mid	2437	8.95			Pass
High	2462	8.16			Pass

Test mode: IEEE 802.11g

Channel	Frequency (MHz)	Maximum transmit power (dBm)	Limit		Result
			(dBm)	(watts)	
Low	2412	9.62	30	1	Pass
Mid	2437	9.43			Pass
High	2462	9.50			Pass

Test mode: IEEE 802.11n (HT20)

Channel	Frequency (MHz)	Maximum transmit power (dBm)	Limit		Result
			(dBm)	(watts)	
Low	2412	9.60	30	1	Pass
Mid	2437	8.28			Pass
High	2462	9.69			Pass

Test mode: IEEE 802.11n (HT40)

Channel	Frequency (MHz)	Maximum transmit power (dBm)	Limit		Result
			(dBm)	(watts)	
Low	2422	9.83	30	1	Pass
Mid	2437	8.04			Pass
High	2452	9.64			Pass

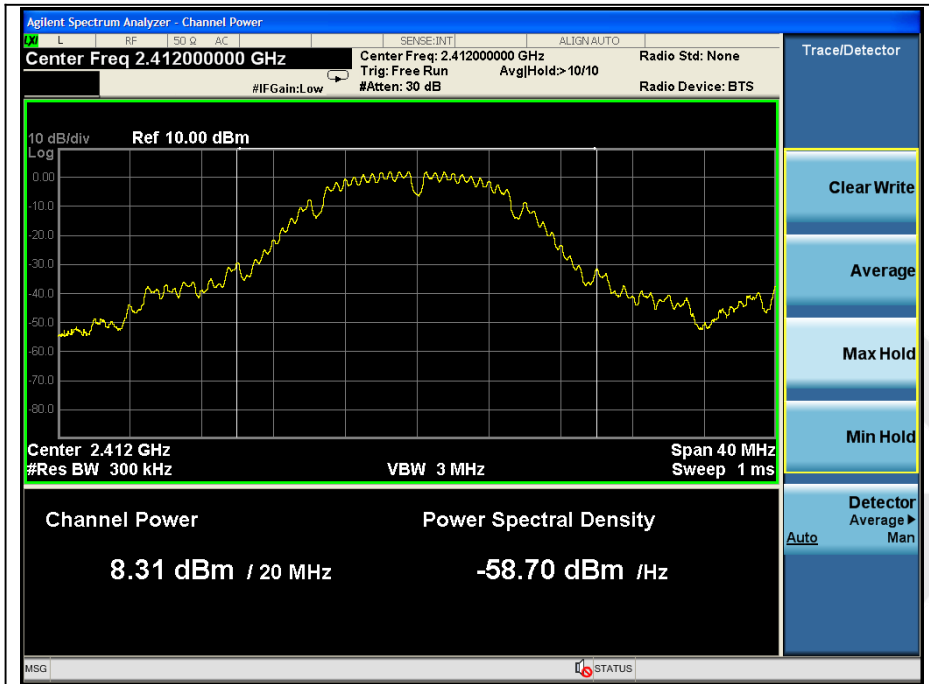

Test Mode: 802.11b---Low

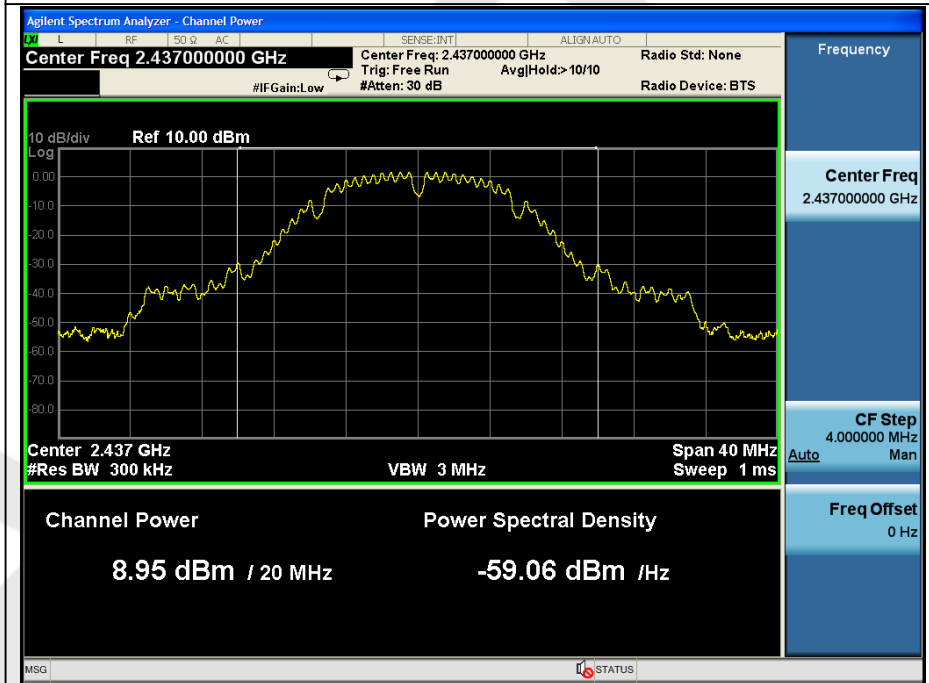

Test Mode: 802.11b---Mid

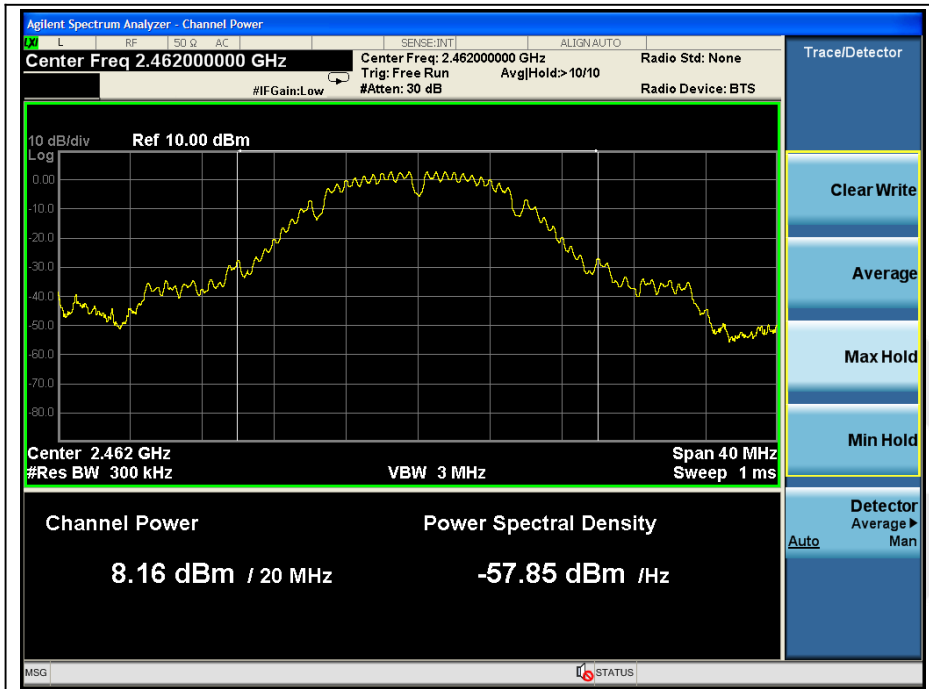

Test Mode: 802.11b---High

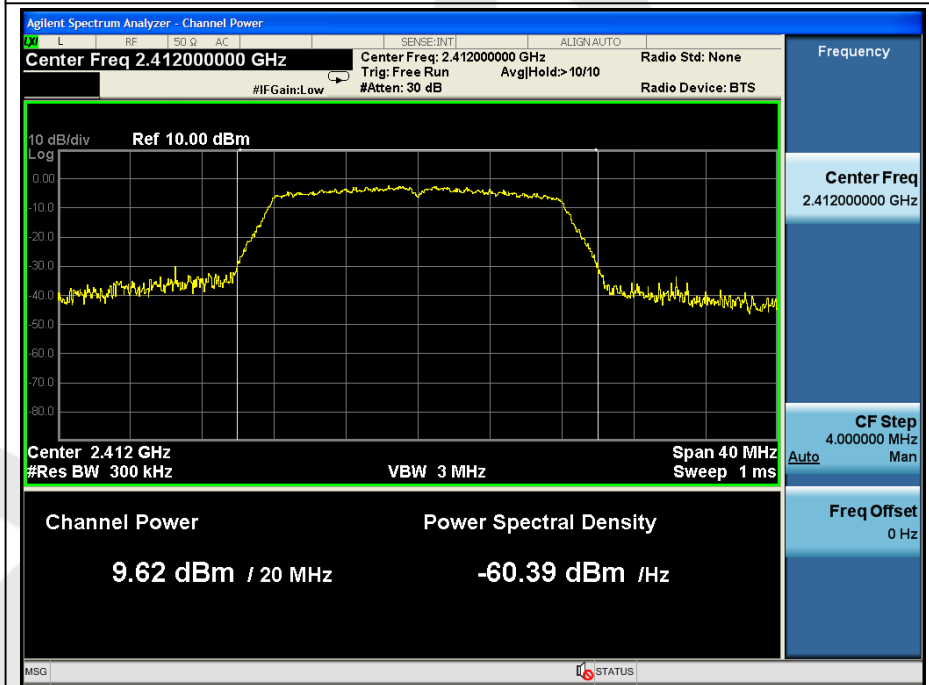

Test Mode: 802.11g---Low

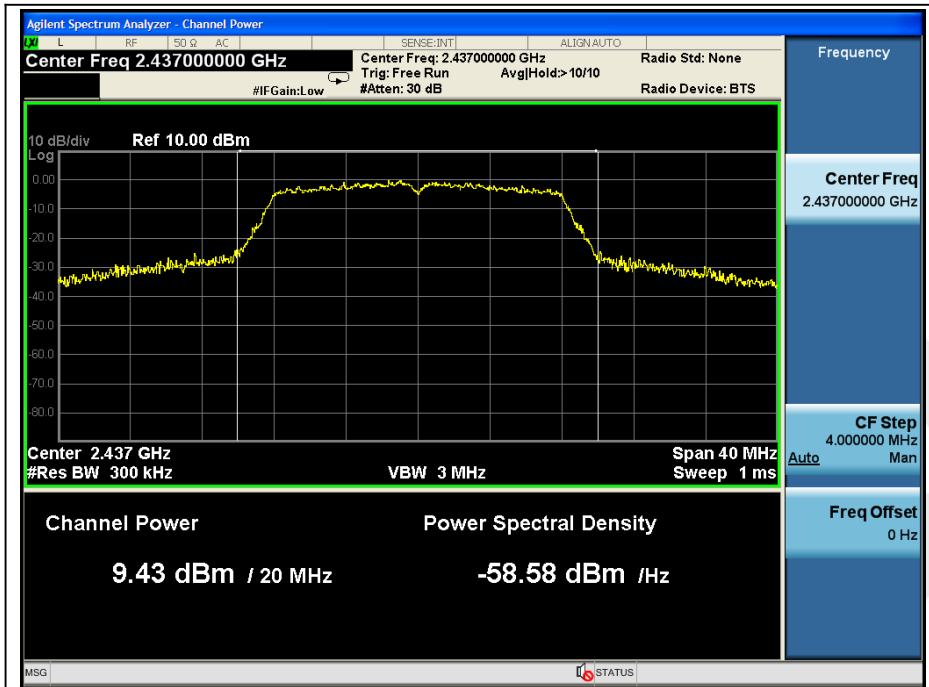

Test Mode: 802.11g---Mid

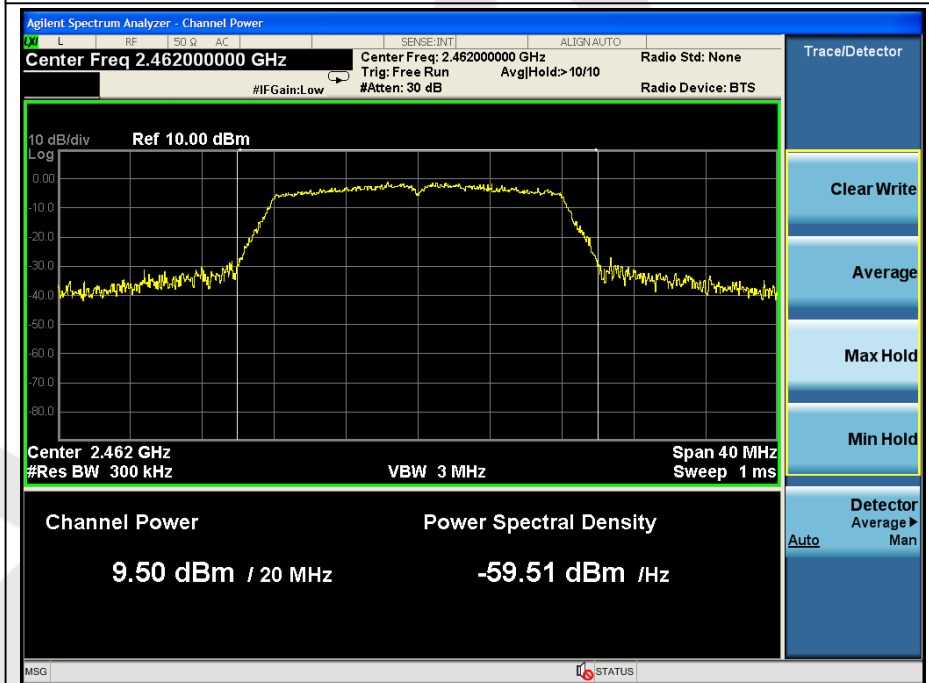

Test Mode: 802.11g---High

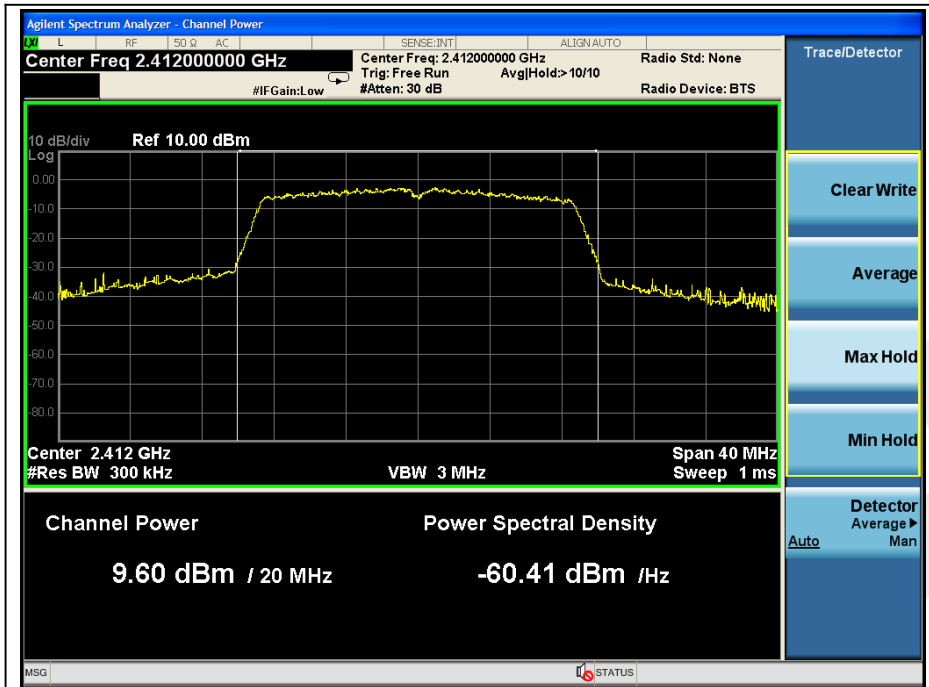

Test Mode: 802.11n20---Low

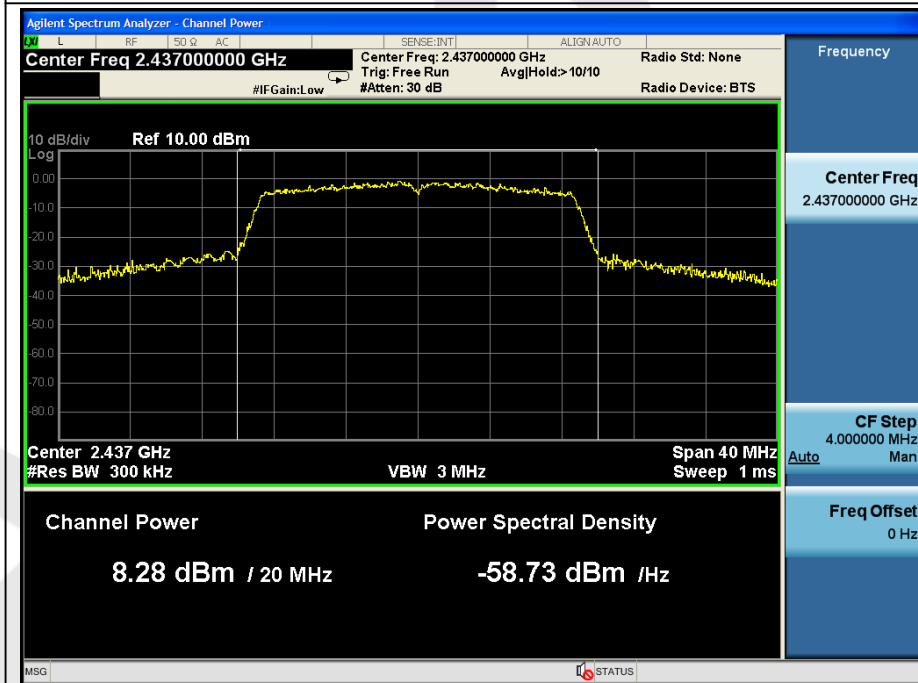

Test Mode: 802.11n20---Mid

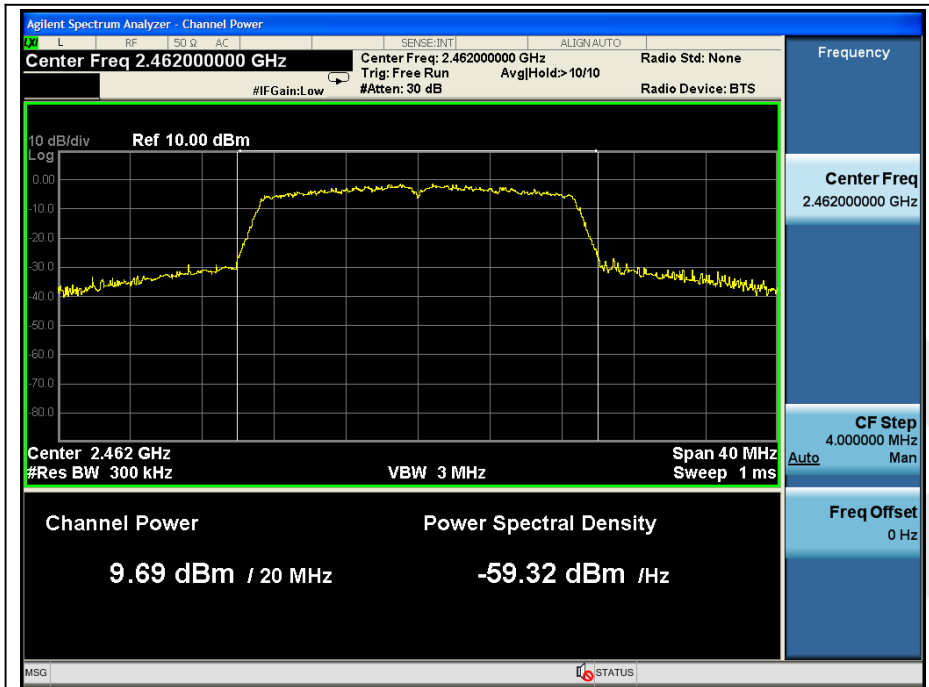

Test Mode: 802.11n20---High

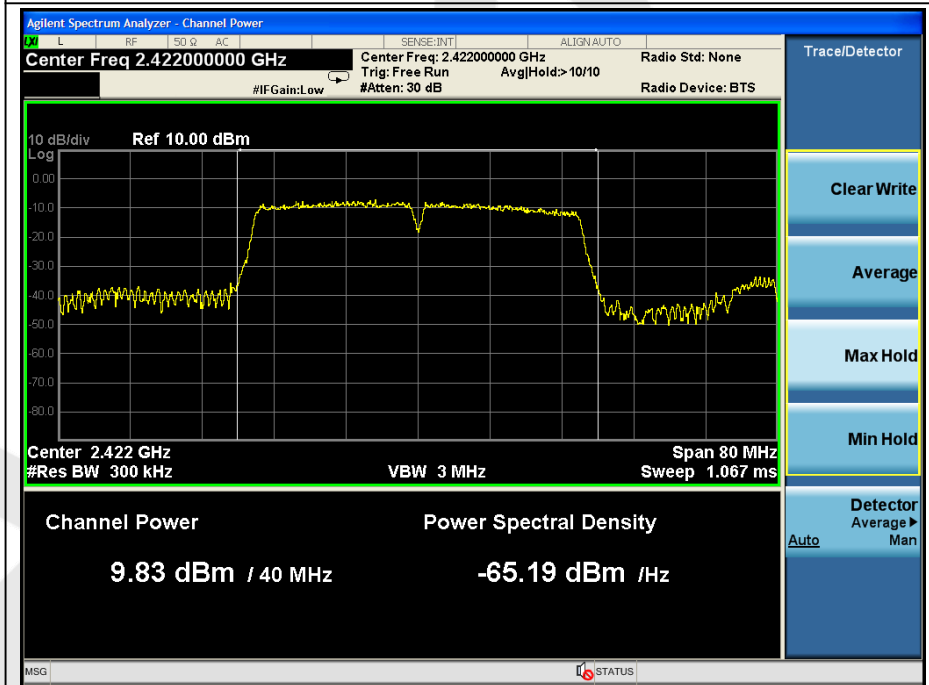

Test Mode: 802.11n40---Low

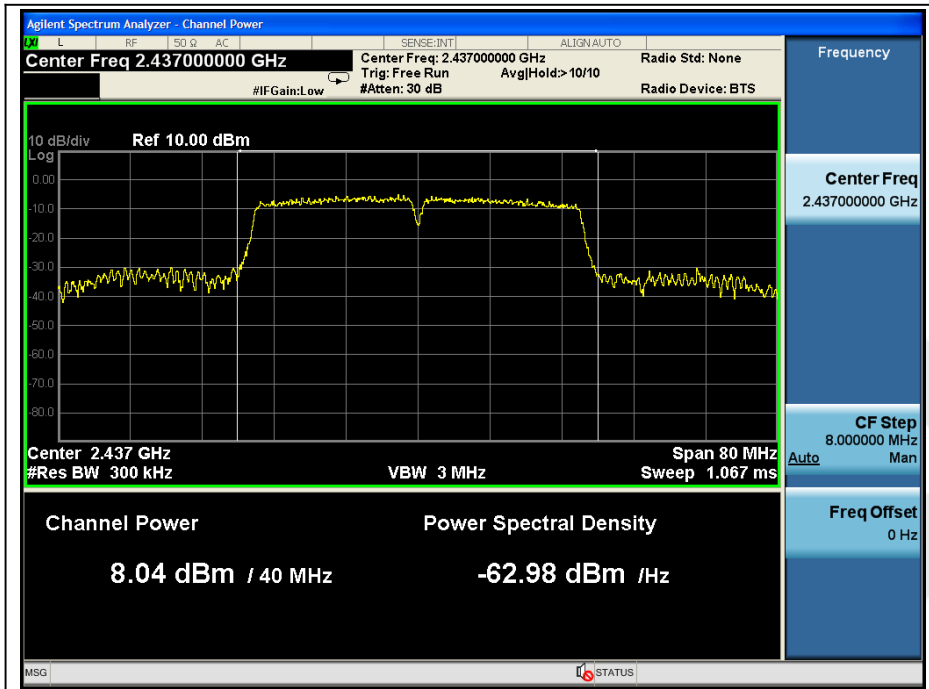

Test Mode: 802.11n40---Mid

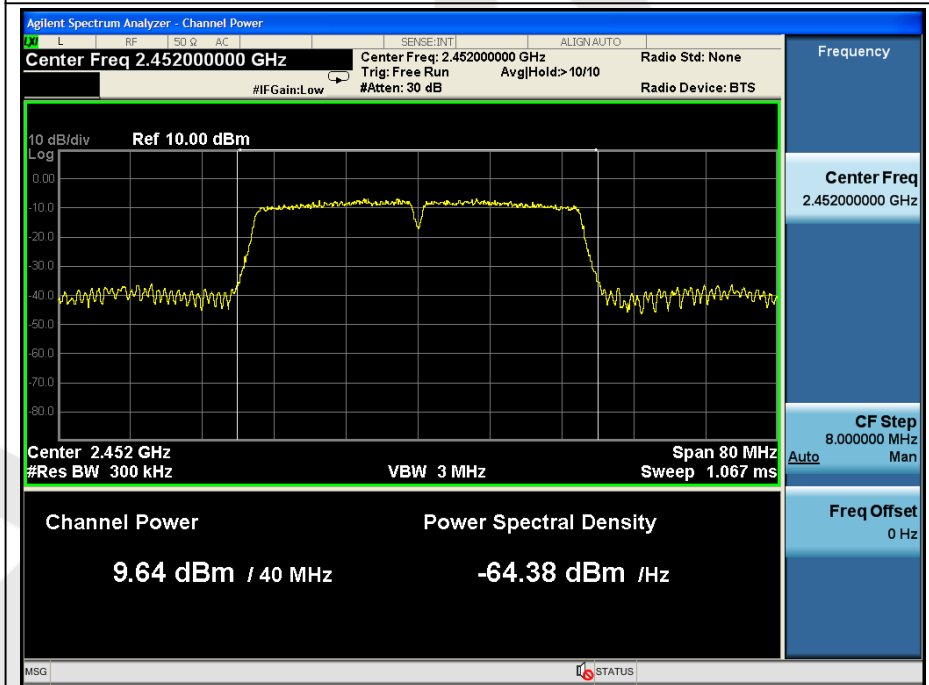

Test Mode: 802.11n40---High

4.4. 100 kHz bandwidth outside the frequency Measurement

a. Applicable Standard

In any 100 kHz bandwidth outside the frequency band in which the spread spectrum or digitally modulated intentional radiator is operating, the radio frequency power that is produced by the intentional radiator shall be at least 20 dB below that in the 100 kHz bandwidth within the band that contains the highest level of the desired power, based on either an RF conducted or a radiated measurement, provided the transmitter demonstrates compliance with the peak conducted power limits. If the transmitter complies with the conducted power limits based on the use of RMS averaging over a time interval, as permitted under paragraph (b)(3) of this section, the attenuation required under this paragraph shall be 30 dB instead of 20 dB. Attenuation below the general limits specified in §15.209(a) is not required. In addition, radiated emissions which fall in the restricted bands, as defined in §15.205(a), must also comply with the radiated emission limits specified in §15.209(a) (see §15.205(c)).

b. Measurement Procedure

The EUT must have its hopping/Non-hopping function enabled. Using the following spectrum analyzer setting:

1. Set the RBW = 100KHz.
2. Set the VBW = 300KHz.
3. Sweep time = auto couple.
4. Detector function = peak.
5. Trace mode = max hold.
6. Allow trace to fully stabilize.

c. Test Equipment

Same as the equipment listed in 4.2.

d. Test Setup

See 4.1

Test Results:

Mode	Frequency Band	Delta Peak to band emission (dBc)	Limit (dBc)	Result
802.11b mode	2400	42.067	30	Pass
	2483.5	52.294	30	Pass
802.11g mode	2400	37.438	30	Pass
	2483.5	43.819	30	Pass
802.11n(HT20) mode	2400	34.306	30	Pass
	2483.5	41.560	30	Pass
802.11n(HT40) mode	2400	36.941	30	Pass
	2483.5	40.917	30	Pass

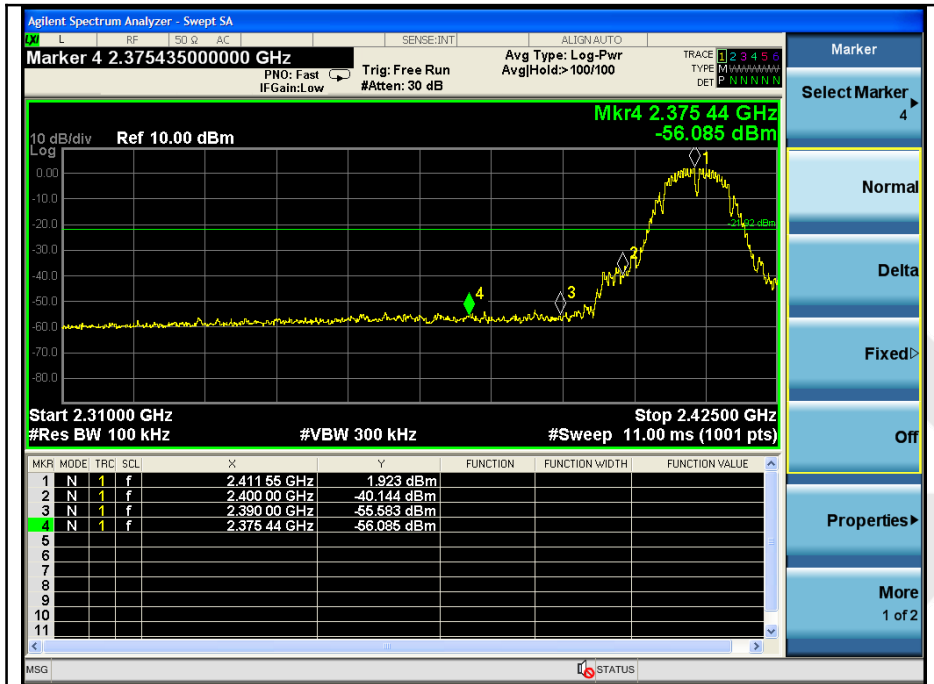

Test Mode: 802.11b---Low



Test Mode: 802.11b---High



Test Mode: 802.11g---Low



Test Mode: 802.11g---High



Test Mode: 802.11n20---Low

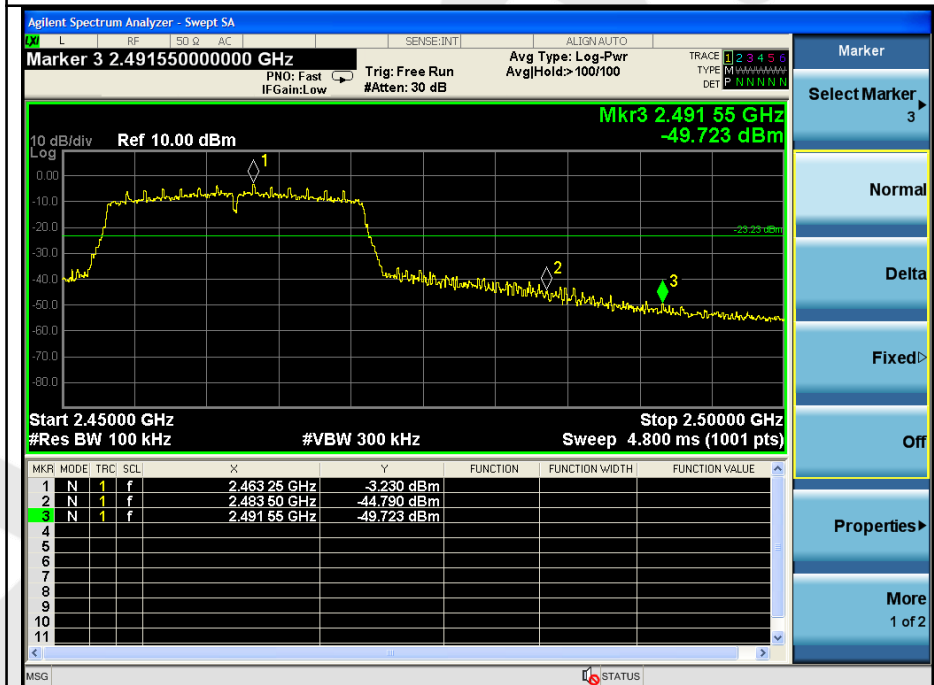

Test Mode: 802.11n20---High

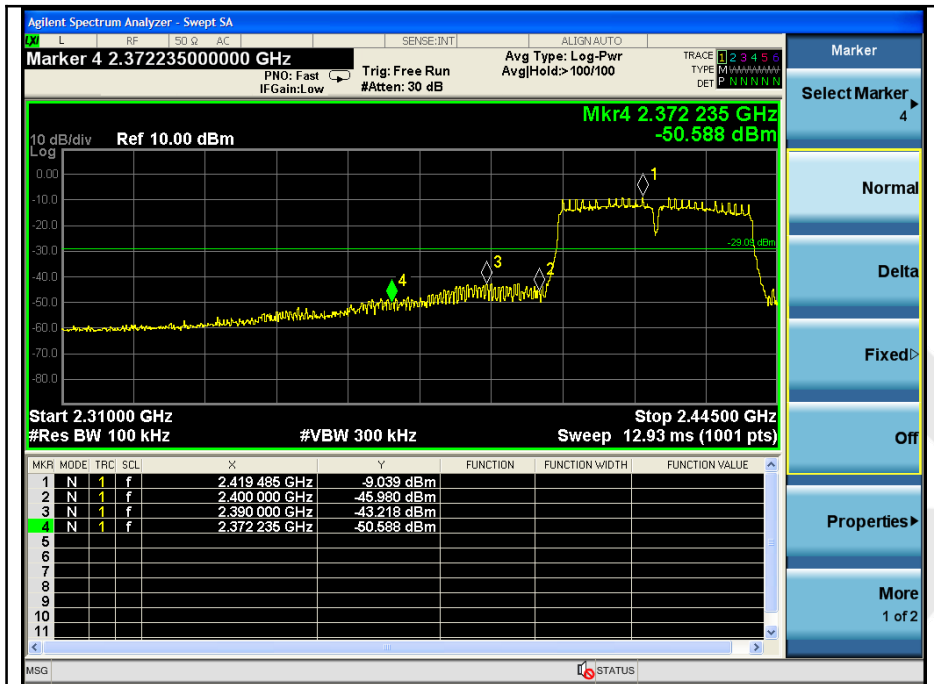

Test Mode: 802.11n40---Low

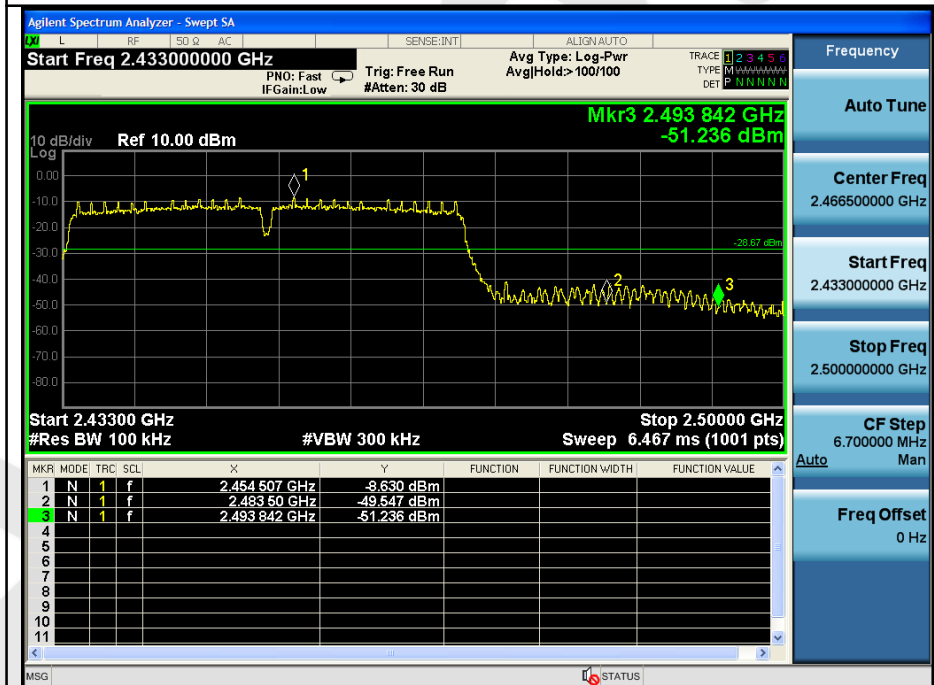

Test Mode: 802.11n40---High

4.5. Peak Power Spectral Density

a. Limit

1. For direct sequence systems, the peak power spectral density conducted from the intentional radiator to the antenna shall not be greater than 8dBm in any 3kHz band during any time interval of continuous transmission.
2. The direct sequence operating of the hybrid system, with the frequency hopping operation turned off, shall comply with the power density requirements of paragraph (d) of this section.

b. Test Procedure

1. Place the EUT on the table and set it in transmitting mode. Remove the antenna from the EUT and then connect a low loss RF cable from the antenna port to the spectrum analyzer.
2. Set the spectrum analyzer as RBW = 3.0kHz, VBW = 10kHz, Span = 1.5xDTS BW
3. Record the max. reading.
4. Repeat the above procedure until the measurements for all frequencies are completed.

c. Test Equipment

Same as the equipment listed in 4.2.

d. Test Setup

See 4.1

Test Results:

Test mode: IEEE 802.11b

Channel	Frequency (MHz)	PPSD (dBm/3KHz)	∑PPSD (dBm/3KHz)	Limit (dBm)	Result
Low	2412	-8.015	-	8.00	Pass
Mid	2437	-11.927	-		Pass
High	2462	-11.138	-		Pass

Test mode: IEEE 802.11g

Channel	Frequency (MHz)	PPSD (dBm)	∑PPSD (dBm)	Limit (dBm)	Result
Low	2412	-18.494	-	8.00	Pass
Mid	2437	-15.904	-		Pass
High	2462	-16.787	-		Pass

Test mode: IEEE 802.11n (HT20)

Channel	Frequency (MHz)	PPSD (dBm/3KHz)	∑PPSD (dBm/3KHz)	Limit (dBm)	Result
Low	2412	-17.984	-	8.00	Pass
Mid	2437	-16.816	-		Pass
High	2462	-16.211	-		Pass

Test mode: IEEE 802.11n (HT40)

Channel	Frequency (MHz)	PPSD (dBm/3KHz)	∑PPSD (dBm/3KHz)	Limit (dBm)	Result
Low	2422	-23.590	-	8.00	Pass
Mid	2437	-21.358	-		Pass
High	2452	-22.733	-		Pass



Test Mode: 802.11b---Low



Test Mode: 802.11b---Mid



Test Mode: 802.11b---High

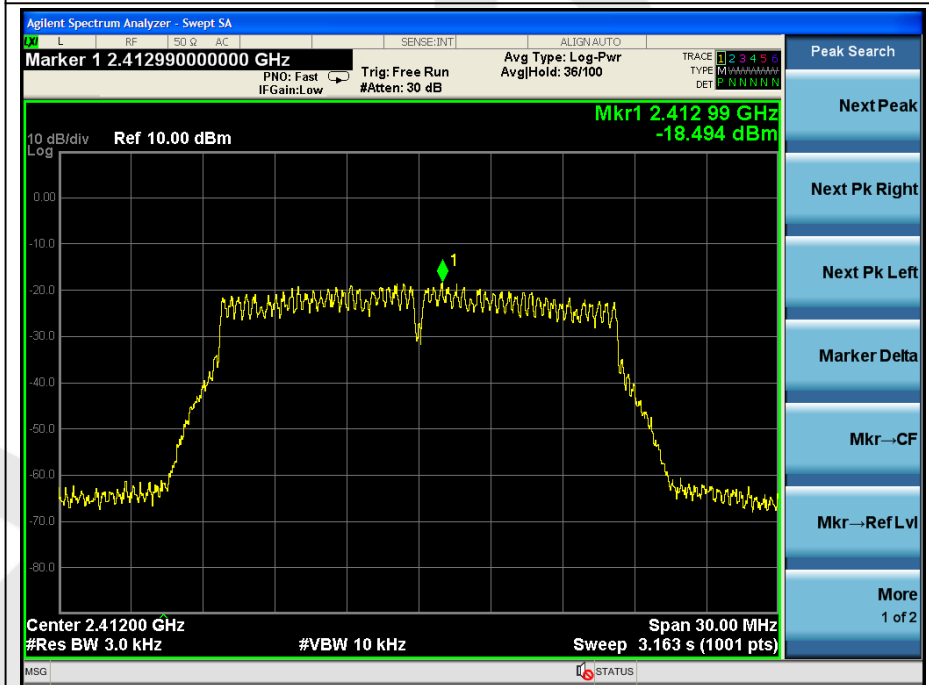

Test Mode: 802.11g---Low

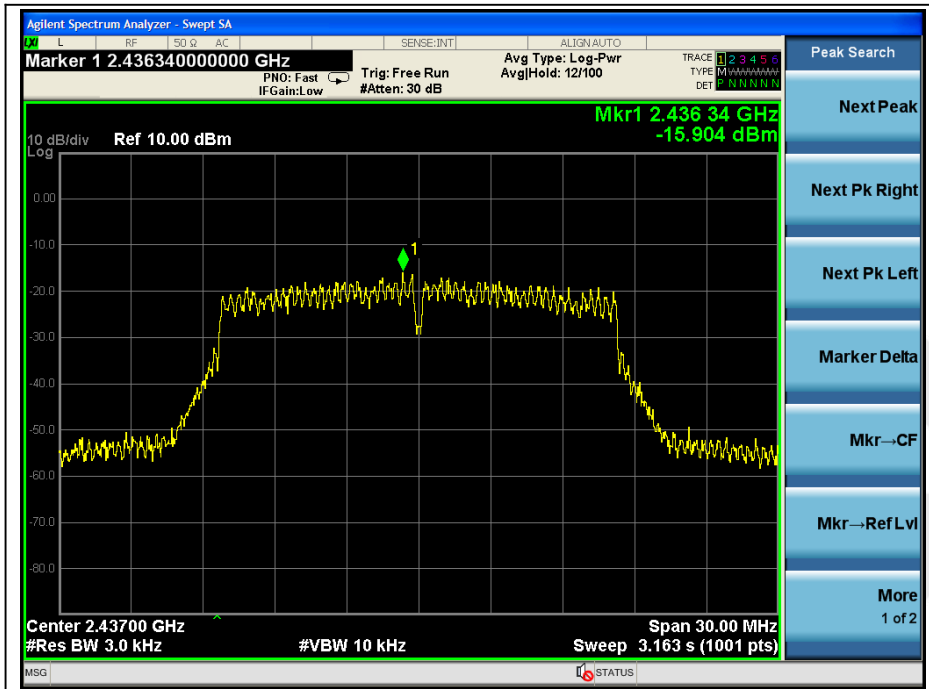

Test Mode: 802.11g---Mid

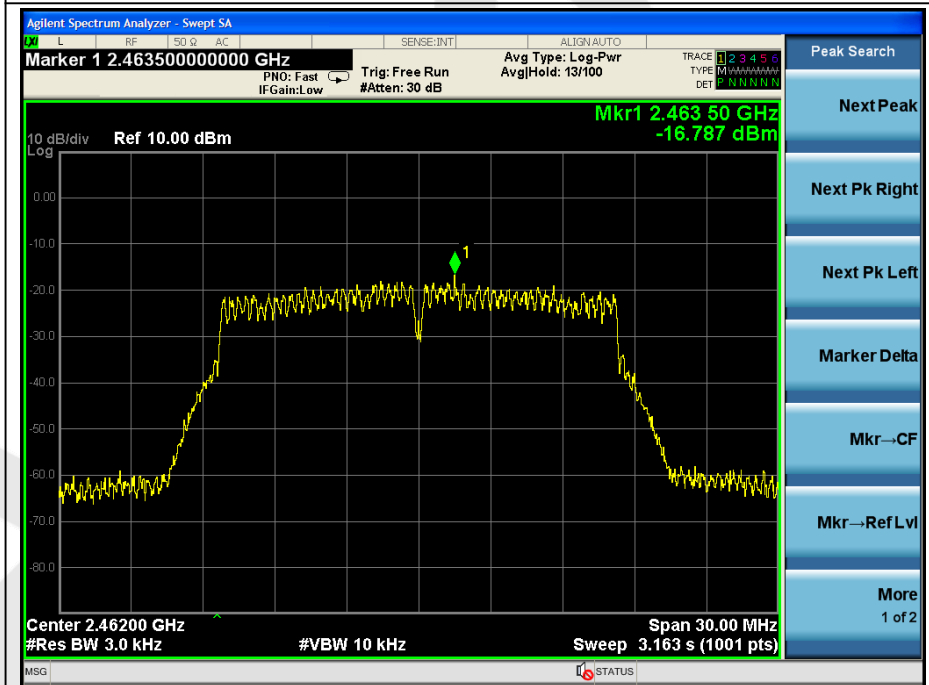

Test Mode: 802.11g---High

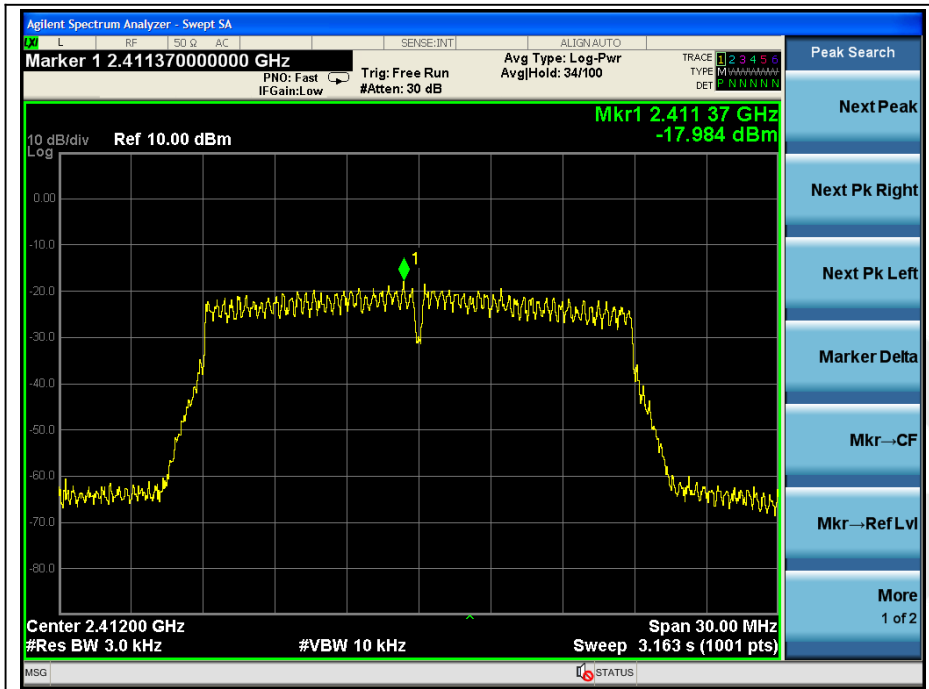

Test Mode: 802.11n20---Low

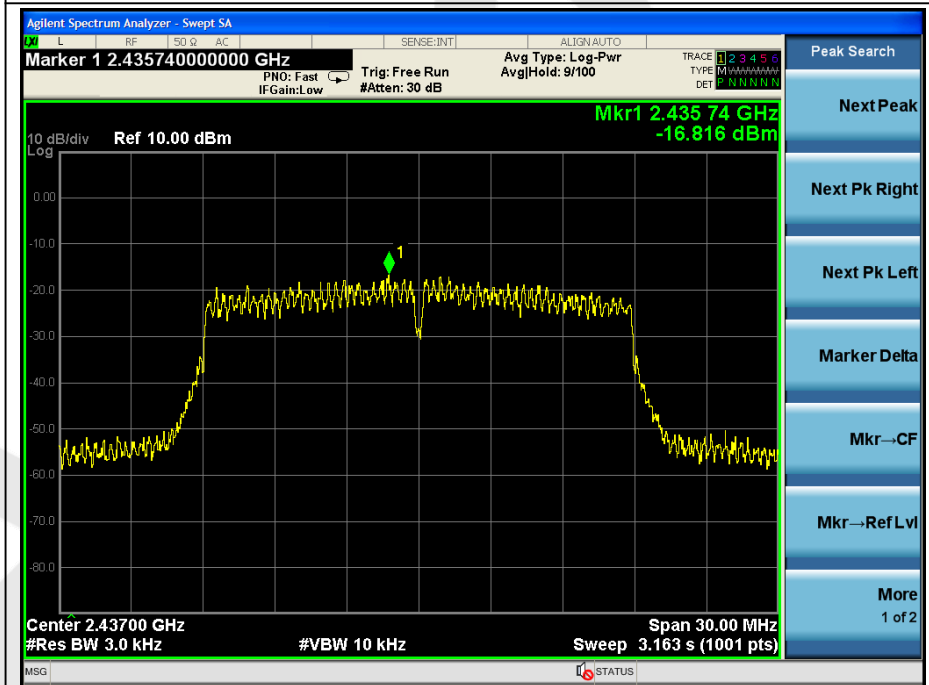

Test Mode: 802.11n20---Mid

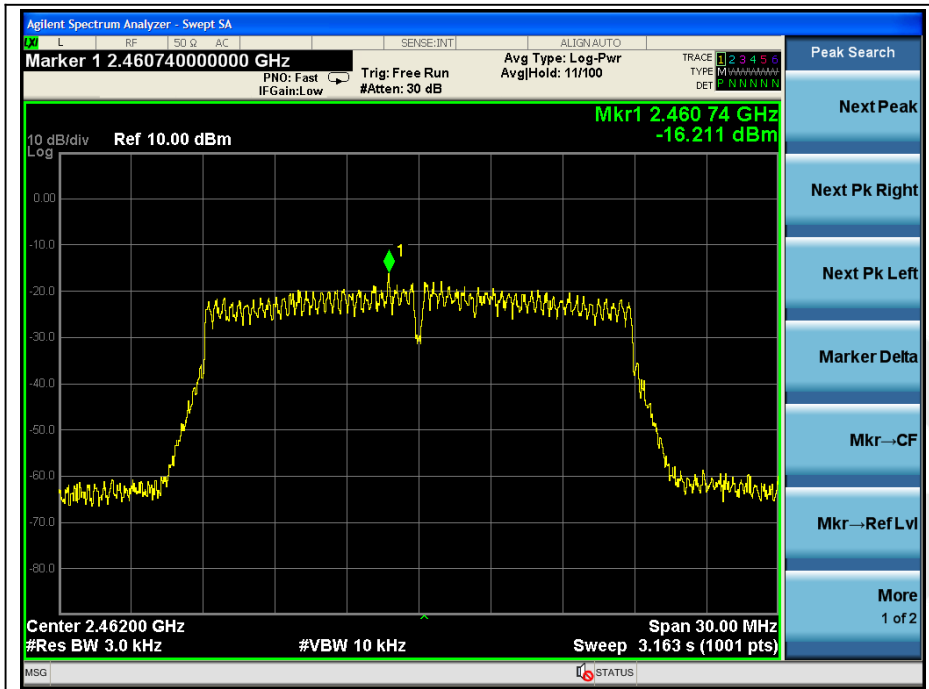

Test Mode: 802.11n20---High

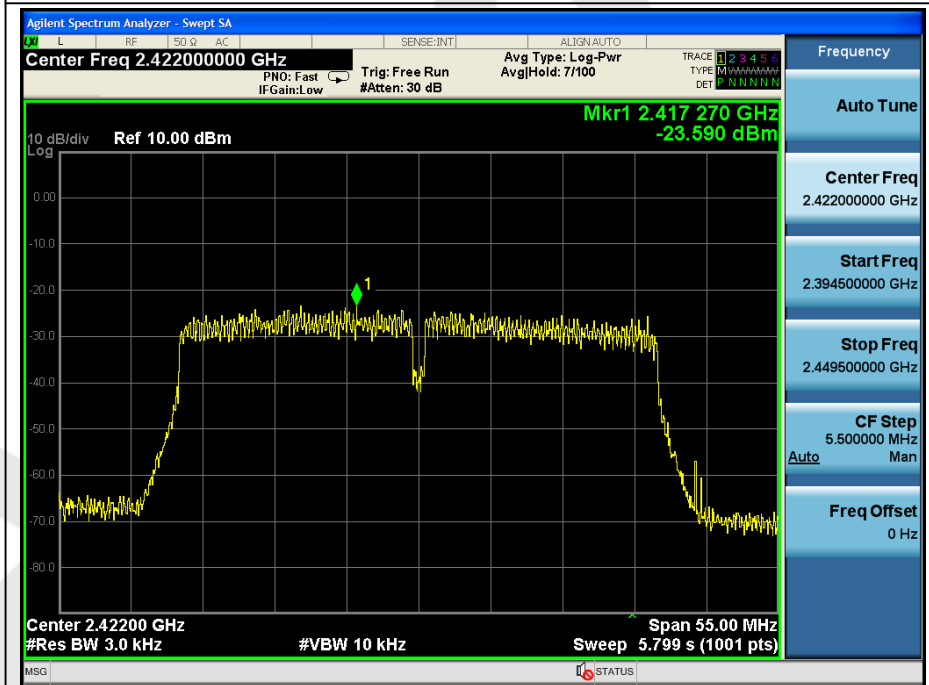

Test Mode: 802.11n40---Low

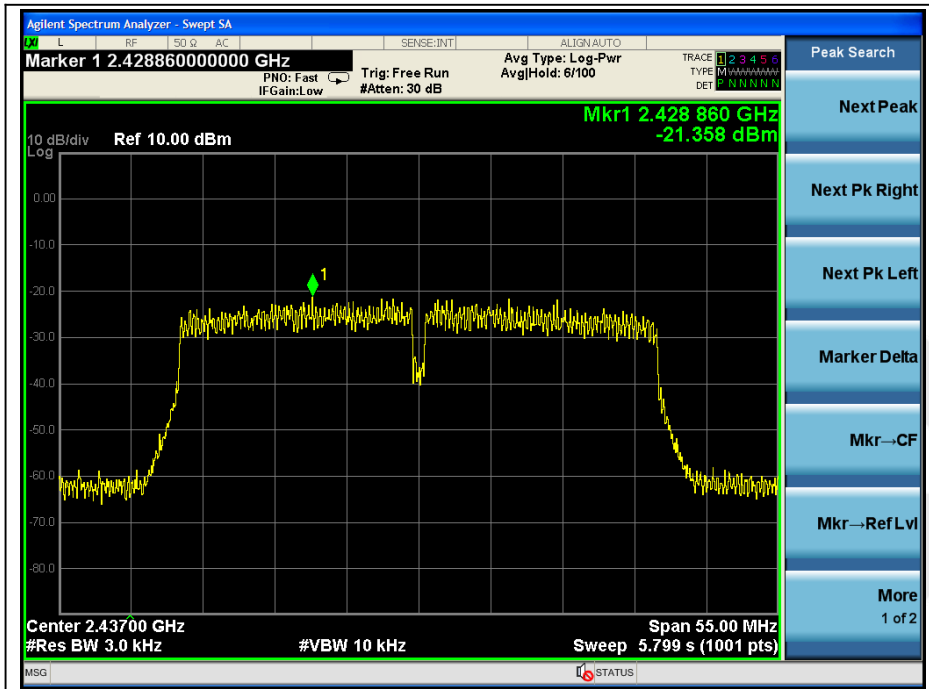

Test Mode: 802.11n40---Mid

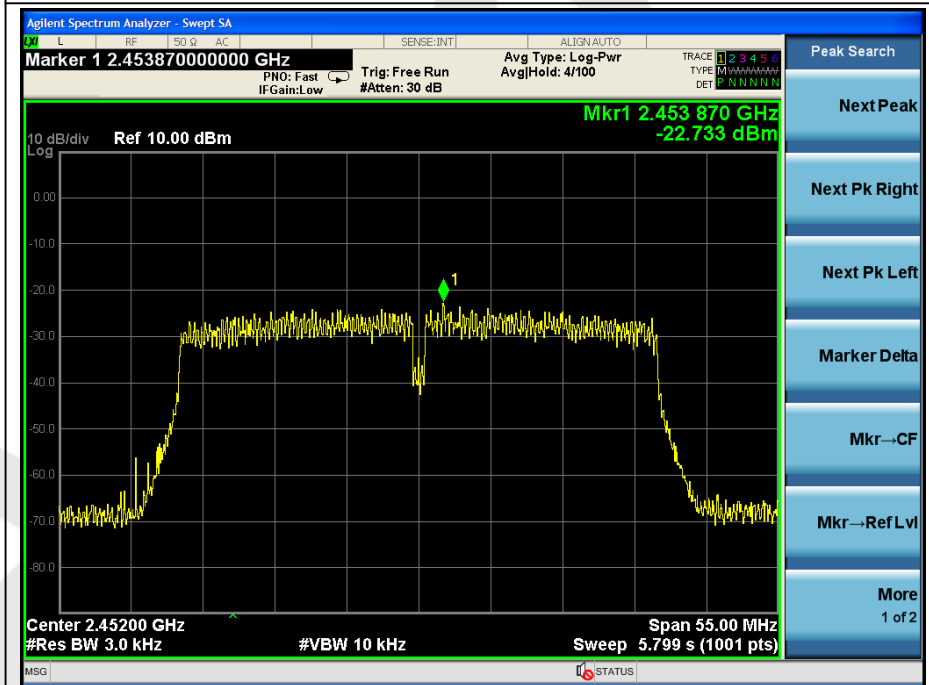

Test Mode: 802.11n40---High

4.6. Radiated Emissions and Band Edge Measurement

4.6.1.1. Test Limits (< 30 MHz)

Frequency (MHz)	Field Strength (microvolts/meter)	Measurement Distance (meter)
0.009-0.490	2400/F(kHz)	300
0.490-1.705	24000/F(kHz)	30
1.705-30.0	30	30

4.6.1.2. Test Limits (≥ 30 MHz)

FIELD STRENGTH of Fundamental: @3M	FIELD STRENGTH of Harmonics	S15.209 30 - 88 MHz	40 dBuV/m
902-928 MHz		88 - 216 MHz	43.5
2.4-2.4835 GHz		216 - 960 MHz	46
94 dBμV/m @3m	54 dBμV/m @3m	ABOVE 960 MHz	54dBuV/m

In any 100 kHz bandwidth outside the frequency band in which the spread spectrum or digitally modulated intentional radiator is operating, the radio frequency power that is produced by the intentional radiator shall be at least 20 dB below that in the 100 kHz bandwidth within the band that contains the highest level of the desired power, based on either an RF conducted or a radiated measurement. Attenuation below the general limits specified in Section 15.209(a) is not required. In addition, radiated emissions which fall in the restricted bands, as defined in Section 15.205(a), must also comply with the radiated emission limits specified in Section 15.209(a) (see Section 15.205(c)).

Test Equipment

Item	Equipment	Manufacturer	Model No.	Serial No.	Last Cal.	Cal. Interval
1.	Spectrum Analysis	Agilent	E4407B	US39390582	Jul. 12, 2016	1 Year
2.	Preamplifier	Instruments corporation	EMC011830	980100	Jun. 17, 2016	1 Year
3.	EMI Test Receiver	Rohde & Schwarz	ESPI	101604	Jun. 17, 2016	1 Year
4.	Double Ridged Horn Antenna	Instruments corporation	GTH-0118	351600	May 06, 2016	1 Year
5.	Bilog Broadband Antenna	Schwarzbeck	VULB9163	VULB 9163-289	May 06, 2016	1 Year
6.	Pre-amplifier	SONOMA	310N	186860	Jun. 17, 2016	1 Year
7.	EMI Test Software EZ-EMC	SHURPLE	N/A	N/A	N/A	N/A
8.	Power Sensor	Agilent	KFSW15050 2	15I00041SN045	Jun. 17, 2016	1 Year
9.	MXA Spectrum Analysis	Agilent	N9020A	MY51170037	Jun. 17, 2016	1 Year
10.	MXG RF Vector Signal Generator	Agilent	N5182A	MY48180656	Jun. 17, 2016	1 Year
11.	Signal Generator	Agilent	E4421B	MY41000743	Jun. 17, 2016	1 Year
12.	DC Power supply	IV	IV-8080	YQSB0096	Jun. 17, 2016	1 Year
13.	TEMP&HUMI PROGRAMMABLE CHAMBER	Bell Group	BE-THK-15 0M8	SE-0137	Jun. 17, 2016	1 Year

4.6.2. Test Configuration:

4.6.2.1. 9k to 30MHz emissions:

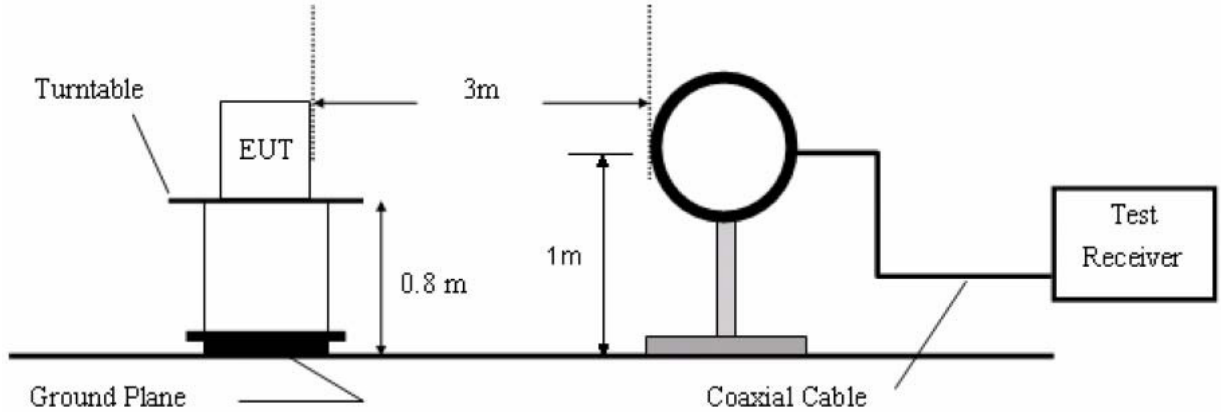

4.6.2.2. 30M to 1G emissions:

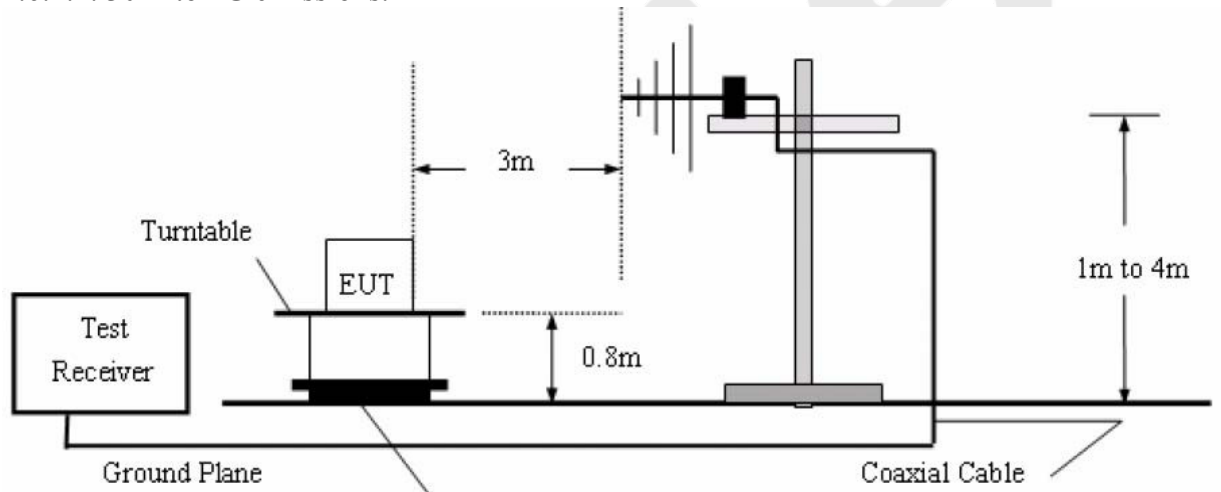

4.6.2.3. 1G to 40G emissions:

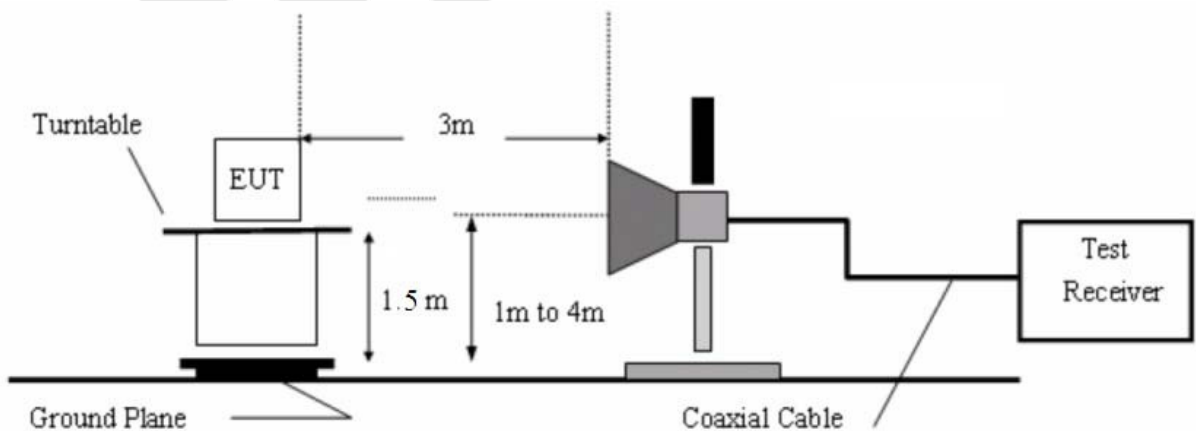

4.6.3. Test Procedure

For below 1GHz: The EUT is placed on a turntable, which is 0.8m above the ground plane.
For above 1GHz: The EUT is placed on a turntable, which is 1.5m above the ground plane.
The turn table can rotate 360 degrees to determine the position of the maximum emission level.
The EUT is set 3 meters away from the receiving antenna which is mounted on a antenna tower.
The antenna can be moved up and down from 1 to 4 meters to find out the maximum emission level. Both horizontal and vertical polarization of the antenna are set on test.

Measurements are made on 9KHz to 30MHz and 30MHz to 26GHz range with the transmitter set to the lowest, middle, and highest channels.

All readings from 30MHz to 1GHz are quasi-peak values with a resolution bandwidth of 120kHz. All reading are above 1GHz, peak & average values with a resolution bandwidth of 1MHz.

The EUT is tested in 9*6*6 Chamber. The device is evaluated in xyz orientation.

The test results are listed in Section 4.6.4.

4.6.4. Test Results

Please refer the following pages. Only the worst case (x orientation).

The test results of above 18000MHz are attenuated more than 20dB below the permissible limits, so the results don't record in the report.

Test Results (30~1000MHz)

Job No.:	0117020725W	Polarization:	Horizontal
Standard:	FCC PART15 C	Power Source:	DC 12V
Test item:	Radiation Test	Temp.(C)/Hum.(%RH):	24.3(C)/55% RH
Test Mode:	WiFi Mode	Distance:	3m

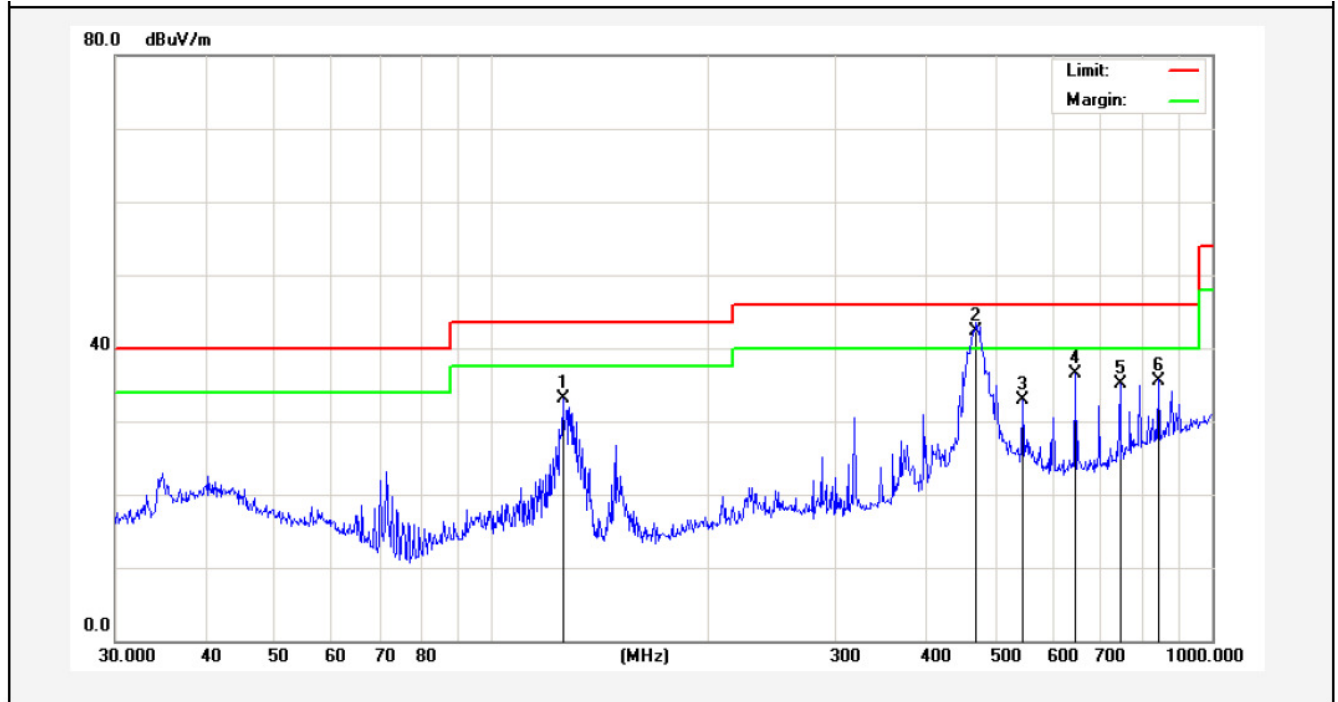

No.	Freq. (MHz)	Reading (dBuV/m)	Factor (dB/m)	Result (dBuV/m)	Limit (dBuV/)	Over Limit (dB)	Detector	Height (cm)	degree (deg)	Remark
1	125.4457	55.26	-22.14	33.12	43.50	-10.38	peak			
2	470.5231	54.11	-11.81	42.30	46.00	-3.70	QP	300	0	
3	545.1825	43.95	-11.08	32.87	46.00	-13.13	peak			
4	645.1195	46.44	-9.99	36.45	46.00	-9.55	peak			
5	744.8660	42.62	-7.60	35.02	46.00	-10.98	peak			
6	842.1295	41.37	-5.77	35.60	46.00	-10.40	peak			

Job No.:	0117020725W	Polarization:	Vertical
Standard:	FCC PART15 C	Power Source:	DC 12V
Test item:	Radiation Test	Temp.(C)/Hum.(%RH):	24.3(C)/55%RH
Test Mode:	WiFi Mode	Distance:	3m

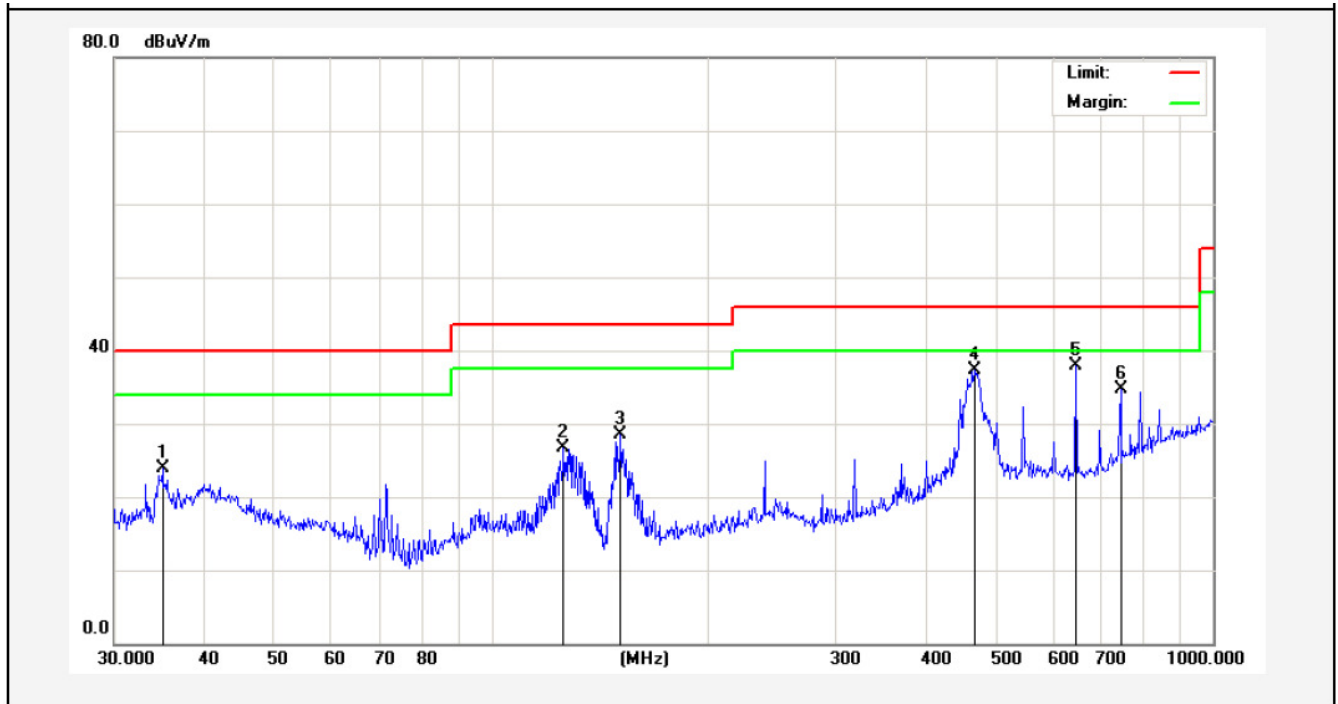

No.	Freq. (MHz)	Reading (dBuV/m)	Factor (dB/m)	Result (dBuV/m)	Limit (dBuV/)	Over Limit (dB)	Detector	Height (cm)	degree (deg)	Remark
1	35.0048	38.10	-14.29	23.81	40.00	-16.19	peak			
2	125.8863	43.86	-17.20	26.66	43.50	-16.84	peak			
3	151.0665	46.76	-18.30	28.46	43.50	-15.04	peak			
4	467.2348	49.12	-11.90	37.22	46.00	-8.78	peak			
5	645.1195	46.88	-8.89	37.99	46.00	-8.01	peak			
6	744.8660	41.77	-7.15	34.62	46.00	-11.38	peak			

Test Results (Above 1000MHz)

Test mode:	802.11b	Test channel:	Low CH
------------	---------	---------------	--------

Peak value:

Frequency (MHz)	Read Level (dBuV)	Antenna Factor (dB/m)	Cable Loss (dB)	Preamp Factor (dB)	Level (dBuV/m)	Limit Line (dBuV/m)	Over Limit (dB)	Polarization
4824.00	40.95	34.13	6.61	34.09	47.60	74.00	-26.40	Vertical
7236.00	34.63	37.14	7.74	34.51	45.00	74.00	-29.00	Vertical
9648.00	33.01	39.35	9.26	34.80	46.82	74.00	-27.18	Vertical
12060.00	*					74.00		Vertical
14472.00	*					74.00		Vertical
16884.00	*					74.00		Vertical
4824.00	39.52	34.13	6.61	34.09	46.17	74.00	-27.83	Horizontal
7236.00	34.33	37.14	7.74	34.51	44.70	74.00	-29.30	Horizontal
9648.00	32.57	39.35	9.26	34.80	46.38	74.00	-27.62	Horizontal
12060.00	*					74.00		Horizontal
14472.00	*					74.00		Horizontal
16884.00	*					74.00		Horizontal

Average value:

Frequency (MHz)	Read Level (dBuV)	Antenna Factor (dB/m)	Cable Loss (dB)	Preamp Factor (dB)	Level (dBuV/m)	Limit Line (dBuV/m)	Over Limit (dB)	Polarization
4824.00	29.98	34.13	6.61	34.09	36.63	54.00	-17.37	Vertical
7236.00	23.49	37.14	7.74	34.51	33.86	54.00	-20.14	Vertical
9648.00	23.34	39.35	9.26	34.80	37.15	54.00	-16.85	Vertical
12060.00	*					54.00		Vertical
14472.00	*					54.00		Vertical
16884.00	*					54.00		Vertical
4824.00	29.02	34.13	6.61	34.09	35.67	54.00	-18.33	Horizontal
7236.00	22.90	37.14	7.74	34.51	33.27	54.00	-20.73	Horizontal
9648.00	22.30	39.35	9.26	34.80	36.11	54.00	-17.89	Horizontal
12060.00	*					54.00		Horizontal
14472.00	*					54.00		Horizontal
16884.00	*					54.00		Horizontal

Note:

- 1, Final Level =Receiver Read level + Antenna Factor + Cable Loss – Preamplifier Factor
- 2, “*”, means this data is the too weak instrument of signal is unable to test.

Test mode:	802.11b	Test channel:	Mid CH
------------	---------	---------------	--------

Peak value:

Frequency (MHz)	Read Level (dBuV)	Antenna Factor (dB/m)	Cable Loss (dB)	Preamp Factor (dB)	Level (dBuV/m)	Limit Line (dBuV/m)	Over Limit (dB)	Polarization
4874.00	39.89	34.35	6.67	34.09	46.82	74.00	-27.18	Vertical
7311.00	34.63	37.21	7.77	34.53	45.08	74.00	-28.92	Vertical
9748.00	33.98	39.45	9.33	34.80	47.96	74.00	-26.04	Vertical
12185.00	*					74.00		Vertical
14622.00	*					74.00		Vertical
17059.00	*					74.00		Vertical
4874.00	40.29	34.35	6.67	34.09	47.22	74.00	-26.78	Horizontal
7311.00	33.23	37.21	7.77	34.53	43.68	74.00	-30.32	Horizontal
9748.00	33.85	39.45	9.33	34.80	47.83	74.00	-26.17	Horizontal
12185.00	*					74.00		Horizontal
14622.00	*					74.00		Horizontal
17059.00	*					74.00		Horizontal

Average value:

Frequency (MHz)	Read Level (dBuV)	Antenna Factor (dB/m)	Cable Loss (dB)	Preamp Factor (dB)	Level (dBuV/m)	Limit Line (dBuV/m)	Over Limit (dB)	Polarization
4874.00	30.70	34.35	6.67	34.09	37.63	54.00	-16.37	Vertical
7311.00	22.94	37.21	7.77	34.53	33.39	54.00	-20.61	Vertical
9748.00	23.22	39.45	9.33	34.80	37.20	54.00	-16.80	Vertical
12185.00	*					54.00		Vertical
14622.00	*					54.00		Vertical
17059.00	*					54.00		Vertical
4874.00	30.37	34.35	6.67	34.09	37.30	54.00	-16.70	Horizontal
7311.00	22.31	37.21	7.77	34.53	32.76	54.00	-21.24	Horizontal
9748.00	23.55	39.45	9.33	34.80	37.53	54.00	-16.47	Horizontal
12185.00	*					54.00		Horizontal
14622.00	*					54.00		Horizontal
17059.00	*					54.00		Horizontal

Note:

- 1, Final Level = Receiver Read level + Antenna Factor + Cable Loss – Pre-amplifier Factor
- 2, “*”, means this data is the too weak instrument of signal is unable to test.

Test mode:	802.11b	Test channel:	High CH
------------	---------	---------------	---------

Peak value:

Frequency (MHz)	Read Level (dBuV)	Antenna Factor (dB/m)	Cable Loss (dB)	Preamp Factor (dB)	Level (dBuV/m)	Limit Line (dBuV/m)	Over Limit (dB)	Polarization
4924.00	45.81	34.57	6.74	34.09	53.03	74.00	-20.97	Vertical
7386.00	35.56	37.29	7.80	34.55	46.10	74.00	-27.90	Vertical
9848.00	37.45	39.55	9.41	34.81	51.60	74.00	-22.40	Vertical
12310.00	*					74.00		Vertical
14772.00	*					74.00		Vertical
17234.00	*					74.00		Vertical
4924.00	44.97	34.57	6.74	34.09	52.19	74.00	-21.81	Horizontal
7386.00	34.38	37.29	7.80	34.55	44.92	74.00	-29.08	Horizontal
9848.00	33.59	39.55	9.41	34.81	47.74	74.00	-26.26	Horizontal
12310.00	*					74.00		Horizontal
14772.00	*					74.00		Horizontal
17234.00	*					74.00		Horizontal

Average value:

Frequency (MHz)	Read Level (dBuV)	Antenna Factor (dB/m)	Cable Loss (dB)	Preamp Factor (dB)	Level (dBuV/m)	Limit Line (dBuV/m)	Over Limit (dB)	Polarization
4924.00	36.66	34.57	6.74	34.09	43.88	54.00	-10.12	Vertical
7386.00	25.45	37.29	7.80	34.55	35.99	54.00	-18.01	Vertical
9848.00	25.94	39.55	9.41	34.81	40.09	54.00	-13.91	Vertical
12310.00	*					54.00		Vertical
14772.00	*					54.00		Vertical
17234.00	*					54.00		Vertical
4924.00	35.29	34.57	6.74	34.09	42.51	54.00	-11.49	Horizontal
7386.00	23.76	37.29	7.80	34.55	34.30	54.00	-19.70	Horizontal
9848.00	22.83	39.55	9.41	34.81	36.98	54.00	-17.02	Horizontal
12310.00	*					54.00		Horizontal
14772.00	*					54.00		Horizontal
17234.00	*					54.00		Horizontal

Note:

- 1, During the test, pre-scan the 802.11b,g,n(HT20N/40N) mode, and found the 802.11b mode is worse case, , the report only record this mode.
- 2, Final Level =Receiver Read level + Antenna Factor + Cable Loss – Preamplifier Factor
- 3, “*”, means this data is the too weak instrument of signal is unable to test.

Radiated band edge:

Test mode:	802.11b	Test channel:	Low CH
------------	---------	---------------	--------

Peak value:

Frequency (MHz)	Read Level (dBuV)	Antenna Factor (dB/m)	Cable Loss (dB)	Preamp Factor (dB)	Level (dBuV/m)	Limit Line (dBuV/m)	Over Limit (dB)	Polarization
2390.00	51.80	29.15	3.41	34.01	50.35	74.00	-23.65	Horizontal
2400.00	60.87	29.16	3.43	34.01	59.45	74.00	-14.55	Horizontal
2390.00	53.50	29.15	3.41	34.01	52.05	74.00	-21.95	Vertical
2400.00	62.71	29.16	3.43	34.01	61.29	74.00	-12.71	Vertical

Average value:

Frequency (MHz)	Read Level (dBuV)	Antenna Factor (dB/m)	Cable Loss (dB)	Preamp Factor (dB)	Level (dBuV/m)	Limit Line (dBuV/m)	Over Limit (dB)	Polarization
2390.00	38.52	29.15	3.41	34.01	37.07	54.00	-16.93	Horizontal
2400.00	46.83	29.16	3.43	34.01	45.41	54.00	-8.59	Horizontal
2390.00	40.35	29.15	3.41	34.01	38.90	54.00	-15.10	Vertical
2400.00	47.97	29.16	3.43	34.01	46.55	54.00	-7.45	Vertical

Test mode:	802.11b	Test channel:	High CH
------------	---------	---------------	---------

Peak value:

Frequency (MHz)	Read Level (dBuV)	Antenna Factor (dB/m)	Cable Loss (dB)	Preamp Factor (dB)	Level (dBuV/m)	Limit Line (dBuV/m)	Over Limit (dB)	Polarization
2483.50	52.53	29.28	3.53	34.03	51.31	74.00	-22.69	Horizontal
2500.00	48.30	29.30	3.56	34.03	47.13	74.00	-26.87	Horizontal
2483.50	54.82	29.28	3.53	34.03	53.60	74.00	-20.40	Vertical
2500.00	50.84	29.30	3.56	34.03	49.67	74.00	-24.33	Vertical

Average value:

Frequency (MHz)	Read Level (dBuV)	Antenna Factor (dB/m)	Cable Loss (dB)	Preamp Factor (dB)	Level (dBuV/m)	Limit Line (dBuV/m)	Over Limit (dB)	Polarization
2483.50	38.91	29.28	3.53	34.03	37.69	54.00	-16.31	Horizontal
2500.00	34.98	29.30	3.56	34.03	33.81	54.00	-20.19	Horizontal
2483.50	40.87	29.28	3.53	34.03	39.65	54.00	-14.35	Vertical
2500.00	36.87	29.30	3.56	34.03	35.70	54.00	-18.30	Vertical

Test mode:	802.11g	Test channel:	Low CH
------------	---------	---------------	--------

Peak value:

Frequency (MHz)	Read Level (dBuV)	Antenna Factor (dB/m)	Cable Loss (dB)	Preamp Factor (dB)	Level (dBuV/m)	Limit Line (dBuV/m)	Over Limit (dB)	Polarization
2390.00	50.40	27.53	5.47	33.92	49.48	74.00	-24.52	Horizontal
2400.00	58.99	27.55	5.49	29.93	62.10	74.00	-11.90	Horizontal
2390.00	52.00	27.53	5.47	33.92	51.08	74.00	-22.92	Vertical
2400.00	60.46	27.55	5.49	29.93	63.57	74.00	-10.43	Vertical

Average value:

Frequency (MHz)	Read Level (dBuV)	Antenna Factor (dB/m)	Cable Loss (dB)	Preamp Factor (dB)	Level (dBuV/m)	Limit Line (dBuV/m)	Over Limit (dB)	Polarization
2390.00	37.52	27.53	5.47	33.92	36.60	54.00	-17.40	Horizontal
2400.00	45.68	27.55	5.49	29.93	48.79	54.00	-5.21	Horizontal
2390.00	39.24	27.53	5.47	33.92	38.32	54.00	-15.68	Vertical
2400.00	46.71	27.55	5.49	29.93	49.82	54.00	-4.18	Vertical

Test mode:	802.11g	Test channel:	High CH
------------	---------	---------------	---------

Peak value:

Frequency (MHz)	Read Level (dBuV)	Antenna Factor (dB/m)	Cable Loss (dB)	Preamp Factor (dB)	Level (dBuV/m)	Limit Line (dBuV/m)	Over Limit (dB)	Polarization
2483.50	50.52	29.28	3.53	34.03	49.30	74.00	-24.70	Horizontal
2500.00	46.75	29.30	3.56	34.03	45.58	74.00	-28.42	Horizontal
2483.50	52.53	29.28	3.53	34.03	51.31	74.00	-22.69	Vertical
2500.00	49.02	29.30	3.56	34.03	47.85	74.00	-26.15	Vertical

Average value:

Frequency (MHz)	Read Level (dBuV)	Antenna Factor (dB/m)	Cable Loss (dB)	Preamp Factor (dB)	Level (dBuV/m)	Limit Line (dBuV/m)	Over Limit (dB)	Polarization
2483.50	37.70	29.28	3.53	34.03	36.48	54.00	-17.52	Horizontal
2500.00	34.04	29.30	3.56	34.03	32.87	54.00	-21.13	Horizontal
2483.50	39.53	29.28	3.53	34.03	38.31	54.00	-15.69	Vertical
2500.00	35.87	29.30	3.56	34.03	34.70	54.00	-19.30	Vertical

Test mode:	802.11n (HT20)	Test channel:	Low CH
------------	----------------	---------------	--------

Peak value:

Frequency (MHz)	Read Level (dBuV)	Antenna Factor (dB/m)	Cable Loss (dB)	Preamp Factor (dB)	Level (dBuV/m)	Limit Line (dBuV/m)	Over Limit (dB)	Polarization
2390.00	50.47	27.53	5.47	33.92	49.55	74.00	-24.45	Horizontal
2400.00	59.09	27.55	5.49	29.93	62.20	74.00	-11.80	Horizontal
2390.00	52.07	27.53	5.47	33.92	51.15	74.00	-22.85	Vertical
2400.00	60.57	27.55	5.49	29.93	63.68	74.00	-10.32	Vertical

Average value:

Frequency (MHz)	Read Level (dBuV)	Antenna Factor (dB/m)	Cable Loss (dB)	Preamp Factor (dB)	Level (dBuV/m)	Limit Line (dBuV/m)	Over Limit (dB)	Polarization
2390.00	37.57	27.53	5.47	33.92	36.65	54.00	-17.35	Horizontal
2400.00	45.74	27.55	5.49	29.93	48.85	54.00	-5.15	Horizontal
2390.00	39.30	27.53	5.47	33.92	38.38	54.00	-15.62	Vertical
2400.00	46.77	27.55	5.49	29.93	49.88	54.00	-4.12	Vertical

Test mode:	802.11n (HT20)	Test channel:	High CH
------------	----------------	---------------	---------

Peak value:

Frequency (MHz)	Read Level (dBuV)	Antenna Factor (dB/m)	Cable Loss (dB)	Preamp Factor (dB)	Level (dBuV/m)	Limit Line (dBuV/m)	Over Limit (dB)	Polarization
2483.50	50.62	29.28	3.53	34.03	49.40	74.00	-24.60	Horizontal
2500.00	46.83	29.30	3.56	34.03	45.66	74.00	-28.34	Horizontal
2483.50	52.64	29.28	3.53	34.03	51.42	74.00	-22.58	Vertical
2500.00	49.11	29.30	3.56	34.03	47.94	74.00	-26.06	Vertical

Average value:

Frequency (MHz)	Read Level (dBuV)	Antenna Factor (dB/m)	Cable Loss (dB)	Preamp Factor (dB)	Level (dBuV/m)	Limit Line (dBuV/m)	Over Limit (dB)	Polarization
2483.50	37.76	29.28	3.53	34.03	36.54	54.00	-17.46	Horizontal
2500.00	34.08	29.30	3.56	34.03	32.91	54.00	-21.09	Horizontal
2483.50	39.60	29.28	3.53	34.03	38.38	54.00	-15.62	Vertical
2500.00	35.92	29.30	3.56	34.03	34.75	54.00	-19.25	Vertical

Test mode:	802.11n (HT40)	Test channel:	Low CH
------------	----------------	---------------	--------

Peak value:

Frequency (MHz)	Read Level (dBuV)	Antenna Factor (dB/m)	Cable Loss (dB)	Preamp Factor (dB)	Level (dBuV/m)	Limit Line (dBuV/m)	Over Limit (dB)	Polarization
2390.00	49.77	27.53	5.47	33.92	48.85	74.00	-25.15	Horizontal
2400.00	58.15	27.55	5.49	29.93	61.26	74.00	-12.74	Horizontal
2390.00	51.32	27.53	5.47	33.92	50.40	74.00	-23.60	Vertical
2400.00	59.45	27.55	5.49	29.93	62.56	74.00	-11.44	Vertical

Average value:

Frequency (MHz)	Read Level (dBuV)	Antenna Factor (dB/m)	Cable Loss (dB)	Preamp Factor (dB)	Level (dBuV/m)	Limit Line (dBuV/m)	Over Limit (dB)	Polarization
2390.00	37.07	27.53	5.47	33.92	36.15	54.00	-17.85	Horizontal
2400.00	45.16	27.55	5.49	29.93	48.27	54.00	-5.73	Horizontal
2390.00	38.74	27.53	5.47	33.92	37.82	54.00	-16.18	Vertical
2400.00	46.15	27.55	5.49	29.93	49.26	54.00	-4.74	Vertical

Test mode:	802.11n (HT40)	Test channel:	High CH
------------	----------------	---------------	---------

Peak value:

Frequency (MHz)	Read Level (dBuV)	Antenna Factor (dB/m)	Cable Loss (dB)	Preamp Factor (dB)	Level (dBuV/m)	Limit Line (dBuV/m)	Over Limit (dB)	Polarization
2483.50	49.62	29.28	3.53	34.03	48.40	74.00	-25.60	Horizontal
2500.00	46.05	29.30	3.56	34.03	44.88	74.00	-29.12	Horizontal
2483.50	51.50	29.28	3.53	34.03	50.28	74.00	-23.72	Vertical
2500.00	48.21	29.30	3.56	34.03	47.04	74.00	-26.96	Vertical

Average value:

Frequency (MHz)	Read Level (dBuV)	Antenna Factor (dB/m)	Cable Loss (dB)	Preamp Factor (dB)	Level (dBuV/m)	Limit Line (dBuV/m)	Over Limit (dB)	Polarization
2483.50	37.15	29.28	3.53	34.03	35.93	54.00	-18.07	Horizontal
2500.00	33.61	29.30	3.56	34.03	32.44	54.00	-21.56	Horizontal
2483.50	38.93	29.28	3.53	34.03	37.71	54.00	-16.29	Vertical
2500.00	35.42	29.30	3.56	34.03	34.25	54.00	-19.75	Vertical

5. ANTENNA APPLICATION

5.1. Antenna requirement

The EUT'S antenna is met the requirement of FCC part 15C section 15.203.

An intentional radiator shall be designed to ensure that no antenna other than that furnished by the responsible party shall be used with the device. The use of a permanently attached antenna or of an antenna that uses a unique coupling to the intentional radiator shall be considered sufficient to comply with the provisions of this section. The manufacturer may design the unit so that a broken antenna can be replaced by the user, but the use of a standard antenna jack or electrical connector is prohibited. This requirement does not apply to carrier current devices or to devices operated under the provisions of §15.211, §15.213, §15.217, §15.219, or §15.221. Further, this requirement does not apply to intentional radiators that must be professionally installed, such as perimeter protection systems and some field disturbance sensors, or to other intentional radiators which, in accordance with §15.31(d), must be measured at the installation site. However, the installer shall be responsible for ensuring that the proper antenna is employed so that the limits in this part are not exceeded.

5.2. Result

The EUT's antenna used a PIFA antenna which is permanently attached, The antenna's gain is 2dBi and meets the requirement.

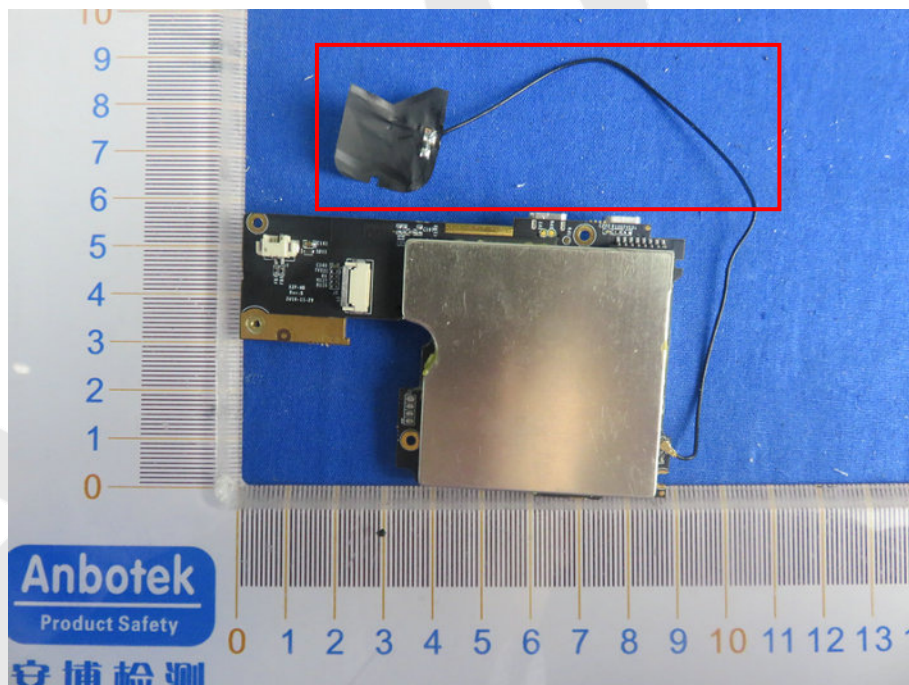

6. PHOTOGRAPH

6.1. Photo of Conducted Emission Measurement

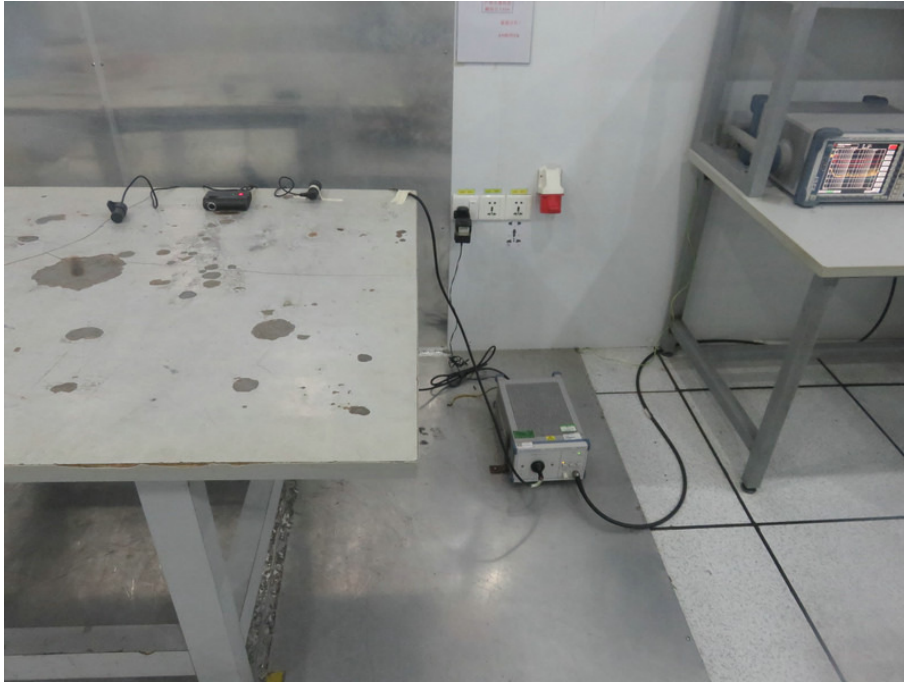

6.2. Photo of Radiation Emission Test

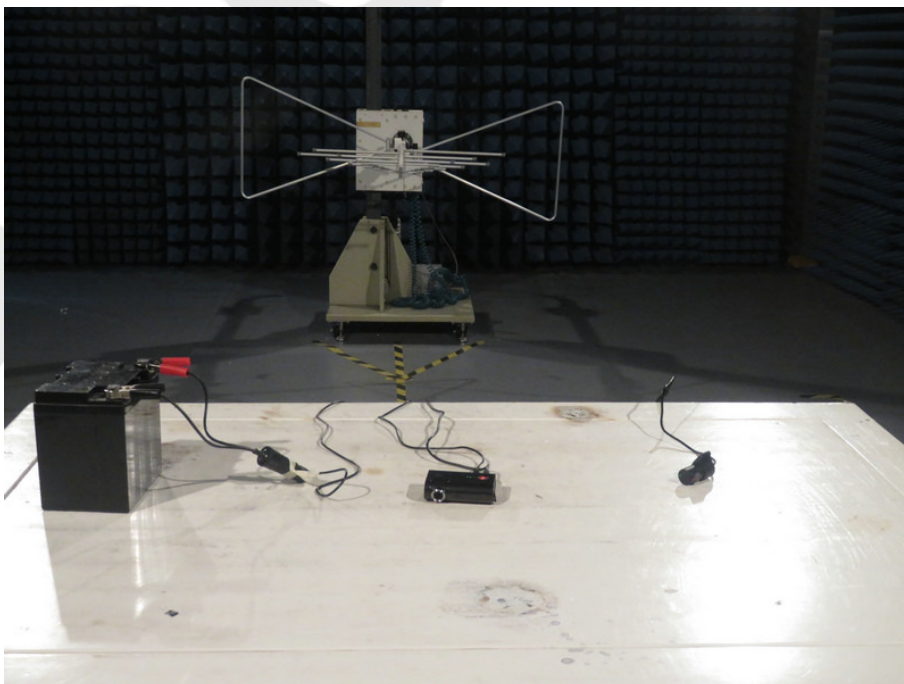

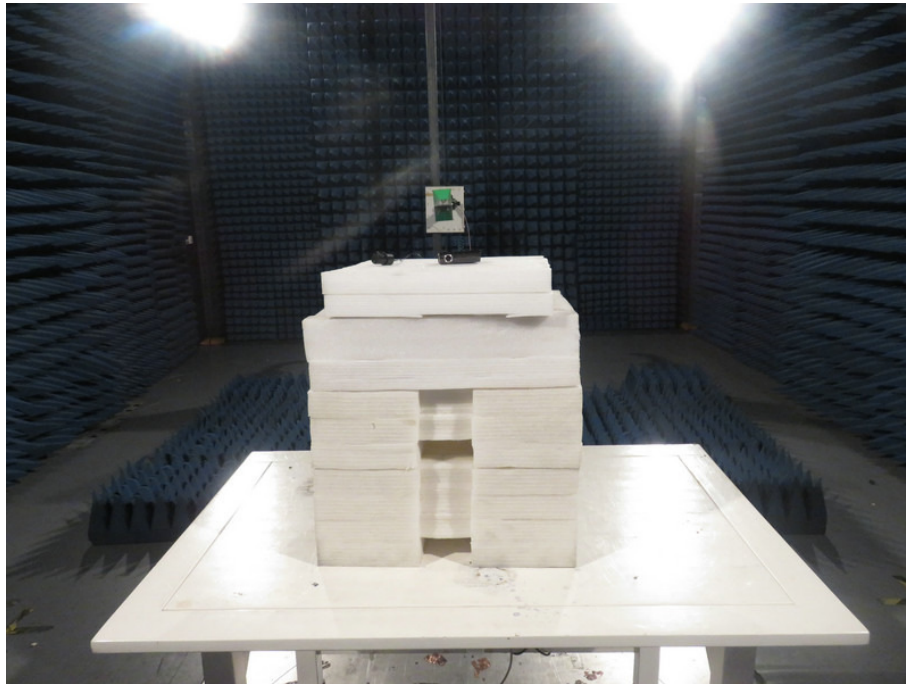

Anbotek

APPENDIX II (EXTERNAL PHOTOS)











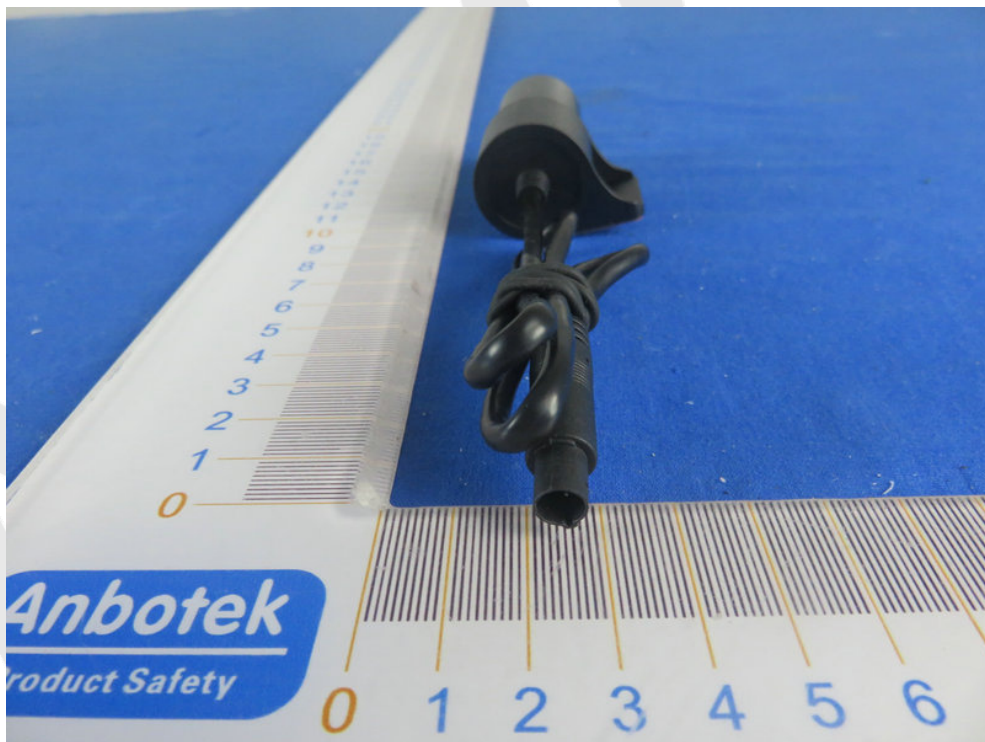
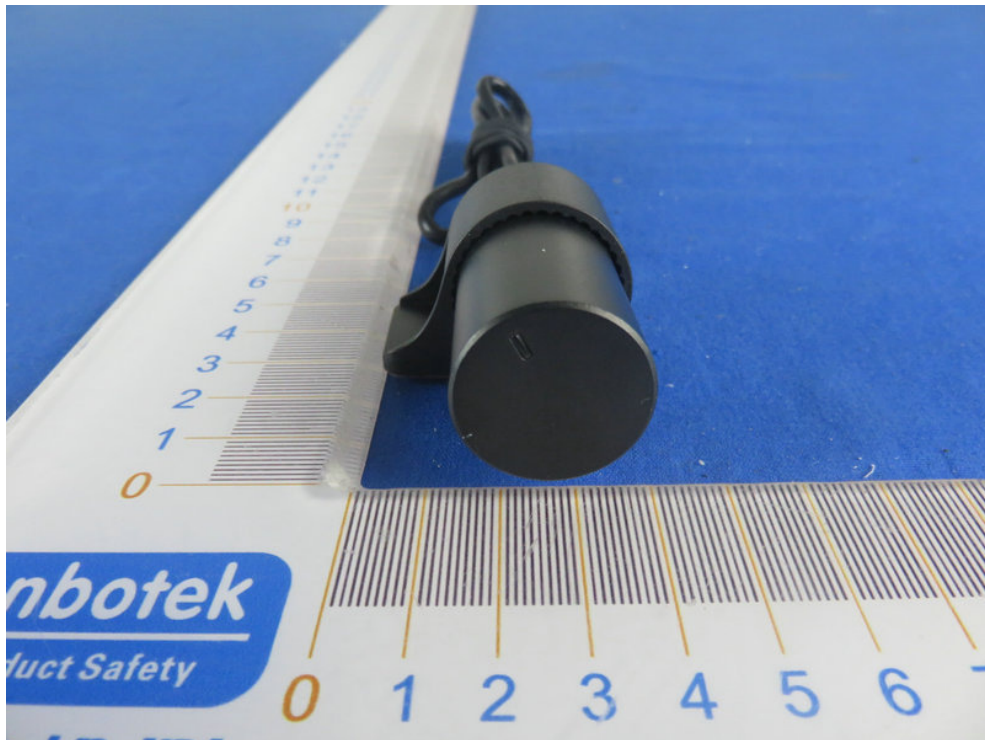



APPENDIX III(INTERNAL PHOTOS)

