



**FCC 47 CFR PART 15 SUBPART C
INDUSTRY CANADA RSS-210 ISSUE 9**

CERTIFICATION TEST REPORT

FOR

URBAN ACTIVE VEHICLE MODULE

MODEL NUMBER: 561107

**FCC ID: 2AJFG561107
IC: 21819-561107**

REPORT NUMBER: 12707015-E1V4

ISSUE DATE: MAY 06, 2019

Prepared for
**VAST PRODUCTION SERVICES
307 ROBBINS DRIVE
TROY, MI 48083, U.S.A.**

Prepared by

**UL VERIFICATION SERVICES INC.
47173 BENICIA STREET
FREMONT, CA 94538, U.S.A.
TEL: (510) 319-4000
FAX: (510) 661-0888**



NVLAP LAB CODE 200065-0

Revision History

<u>Rev.</u>	<u>Issue Date</u>	<u>Revisions</u>	<u>Revised By</u>
V1	04/09/2019	Initial Issue	Chin Pang
V2	04/24/2019	Address TCB Questions	Chin Pang
V3	04/24/2019	Address TCB Questions	Chin Pang
V4	05/06/2019	Address TCB Questions on page 14-19	Chin Pang

TABLE OF CONTENTS

1. ATTESTATION OF TEST RESULTS	4
2. TEST METHODOLOGY	5
3. FACILITIES AND ACCREDITATION	5
4. CALIBRATION AND UNCERTAINTY	5
4.1. <i>MEASURING INSTRUMENT CALIBRATION</i>	<i>5</i>
4.2. <i>SAMPLE CALCULATION</i>	<i>5</i>
4.3. <i>MEASUREMENT UNCERTAINTY.....</i>	<i>6</i>
5. EQUIPMENT UNDER TEST	7
5.1. <i>DESCRIPTION OF EUT</i>	<i>7</i>
5.2. <i>MAXIMUM OUTPUT E-FIELD STRENGTH.....</i>	<i>7</i>
5.3. <i>DESCRIPTION OF AVAILABLE ANTENNA.....</i>	<i>7</i>
5.4. <i>WORST-CASE CONFIGURATION AND MODE.....</i>	<i>7</i>
5.5. <i>DESCRIPTION OF TEST SETUP.....</i>	<i>8</i>
6. TEST AND MEASUREMENT EQUIPMENT	10
7. ANTENNA PORT TEST RESULTS	11
7.1. <i>20 dB AND 99% BW.....</i>	<i>11</i>
7.2. <i>DUTY CYCLE.....</i>	<i>14</i>
7.3. <i>TRANSMISSION TIME.....</i>	<i>17</i>
8. RADIATED EMISSION TEST RESULTS.....	18
8.1. <i>TX RADIATED SPURIOUS EMISSION</i>	<i>18</i>
8.1.1. <i>TX SPURIOUS EMISSION BELOW 30 MHz</i>	<i>20</i>
8.1.2. <i>FUNDAMENTAL, HARMONICS AND TX SPURIOUS EMISSION (30 – 1000 MHz)</i> <i>21</i>	
8.1.3. <i>HARMONICS AND TX SPURIOUS EMISSIONS ABOVE 1GHz.....</i>	<i>23</i>
9. SETUP PHOTOS.....	25

1. ATTESTATION OF TEST RESULTS

COMPANY NAME: Vast Production Services
307 Robbins Drive
Troy, MI 48083, U.S.A.

EUT DESCRIPTION: Urban Active Vehicle Module

MODEL: 561107

SERIAL NUMBER: 2066571

DATE TESTED: MARCH 11-17, 2019

APPLICABLE STANDARDS	
STANDARD	TEST RESULTS
FCC PART 15 SUBPART C	Complies
INDUSTRY CANADA RSS-210 Issue 9, Annex A	Complies
INDUSTRY CANADA RSS-GEN Issue 5	Complies

UL Verification Services Inc. tested the above equipment in accordance with the requirements set forth in the above standards. The test results show that the equipment tested is capable of demonstrating compliance with the requirements as documented in this report.

The results documented in this report apply only to the tested sample, under the conditions and modes of operation as described herein. It is the manufacturer's responsibility to assure that additional production units of this model are manufactured with identical electrical and mechanical components. All samples tested were in good operating condition throughout the entire test program. Measurement Uncertainties are published for informational purposes only and were not taken into account unless noted otherwise.

This document may not be altered or revised in any way unless done so by UL Verification Services Inc. and all revisions are duly noted in the revisions section. Any alteration of this document not carried out by UL Verification Services Inc. will constitute fraud and shall nullify the document. This report must not be used by the client to claim product certification, approval, or endorsement by NVLAP, NIST, any agency of the Federal Government, or any agency of the U.S. government.

Approved & Released For
UL Verification Services Inc. By:

Prepared By:



Chin Pang
Senior Engineer
CONSUMER TECHNOLOGY DIVISION
UL Verification Services Inc.

WU Guangliang
Test Engineer
CONSUMER TECHNOLOGY DIVISION
UL Verification Services Inc.

2. TEST METHODOLOGY

The tests documented in this report were performed in accordance with ANSI C63.10-2013, FCC CFR 47 Part 2, FCC CFR 47 Part 15, RSS-GEN Issue 5, and RSS-210 Issue 9.

3. FACILITIES AND ACCREDITATION

The test sites and measurement facilities used to collect data are located at 47173 and 47266 Benicia Street, and 47658 Kato Road, Fremont, California, USA. Line conducted emissions are measured only at the 47173 address. The following table identifies which facilities were utilized for radiated emission measurements documented in this report. Specific facilities are also identified in the test results sections.

47173 Benicia Street	47266 Benicia Street	47658 Kato Rd.
<input type="checkbox"/> Chamber A (IC:2324B-1)	<input type="checkbox"/> Chamber D (IC:22541-1)	<input type="checkbox"/> Chamber I (IC: 2324A-5)
<input type="checkbox"/> Chamber B (IC:2324B-2)	<input type="checkbox"/> Chamber E (IC:22541-2)	<input checked="" type="checkbox"/> Chamber J (IC: 2324A-6)
<input type="checkbox"/> Chamber C (IC:2324B-3)	<input type="checkbox"/> Chamber F (IC:22541-3)	<input checked="" type="checkbox"/> Chamber K (IC: 2324A-1)
	<input type="checkbox"/> Chamber G (IC:22541-4)	<input type="checkbox"/> Chamber L (IC: 2324A-3)
	<input type="checkbox"/> Chamber H (IC:22541-5)	

The above test sites and facilities are covered under FCC Test Firm Registration # 208313. Chambers above are covered under Industry Canada company address and respective code.

UL Verification Services Inc. is accredited by NVLAP, Laboratory Code 200065-0.

4. CALIBRATION AND UNCERTAINTY

4.1. MEASURING INSTRUMENT CALIBRATION

The measuring equipment utilized to perform the tests documented in this report has been calibrated in accordance with the manufacturer's recommendations, and is traceable to recognized national standards.

4.2. SAMPLE CALCULATION

RADIATED EMISSIONS

Where relevant, the following sample calculation is provided:

$$\begin{aligned} \text{Field Strength (dBuV/m)} &= \text{Measured Voltage (dBuV)} + \text{Antenna Factor (dB/m)} + \text{Cable Loss (dB)} - \text{Preamp Gain (dB)} \\ 36.5 \text{ dBuV} + 18.7 \text{ dB/m} + 0.6 \text{ dB} - 26.9 \text{ dB} &= 28.9 \text{ dBuV/m} \end{aligned}$$

MAINS CONDUCTED EMISSIONS

Where relevant, the following sample calculation is provided:

$$\begin{aligned} \text{Final Voltage (dBuV)} &= \text{Measured Voltage (dBuV)} + \text{Cable Loss (dB)} + \text{Limiter Factor (dB)} + \text{LISN Insertion Loss} \\ 36.5 \text{ dBuV} + 0 \text{ dB} + 10.1 \text{ dB} + 0 \text{ dB} &= 46.6 \text{ dBuV} \end{aligned}$$

4.3. MEASUREMENT UNCERTAINTY

Where relevant, the following measurement uncertainty levels have been estimated for tests performed on the apparatus:

PARAMETER	UNCERTAINTY
Conducted Disturbance, 9KHz to 0.15 MHz	3.84 dB
Conducted Disturbance, 0.15 to 30 MHz	3.65 dB
Radiated Disturbance, 9KHz to 30 MHz	2.52 dB
Radiated Disturbance, 30 to 1000 MHz	4.88 dB
Radiated Disturbance, 1000 to 18000 MHz	4.24 dB
Radiated Disturbance, 18000 to 26000 MHz	4.37 dB
Radiated Disturbance, 26000 to 40000 MHz	5.17 dB

Uncertainty figures are valid to a confidence level of 95%.

5. EQUIPMENT UNDER TEST

5.1. DESCRIPTION OF EUT

Each Variant has a built in Bluetooth module and may contain a key fob radio that transmits in the ASK modulation mode, see table below. It is powered by a DC vehicle battery. The transmitters are used for electronic access and as an authorization system of the vehicle. The device is manufactured by Vast Production Services

EUT	Mode	Frequency (MHz)
Variant 1	ASK + BLE	315

5.2. MAXIMUM OUTPUT E-FIELD STRENGTH

The transmitter has a maximum output peak E-field as follow:

Frequency Range (MHz)	Mode	Output AV E-Field Strength (dBuV/m)
315	ASK	72.33

5.3. DESCRIPTION OF AVAILABLE ANTENNA

The fey fob radio use trace antennas.

5.4. WORST-CASE CONFIGURATION AND MODE

The EUT was set in the worst axis as found in the baseline testing at Z axis.

5.5. DESCRIPTION OF TEST SETUP

SUPPORT EQUIPMENT

Support Equipment List				
Description	Manufacturer	Model	Serial Number	FCC ID
CAN/LIN Interface	Vector	VN1630A	-	NA
Laptop	DELL	E6410	82563381124	-
Power Supply	Sorensen	XT15-4	1319A02779	NA
Tablet	Samsung	SM-T560NU	R52H61DFSFT	-

I/O CABLES

I/O Cable List						
Cable No	Port	# of identical	Connector Type	Cable Type	Cable Length (m)	Remarks
1	DC	1	Wire	DC	>3m	EUT to power supply and CAN.
2	USB	1	Wire	I/O	<3m	Service port only. Not accessible to the end user.

TEST SETUP

The EUT is programmed for continuous TX mode for Radiated and Bandwidth measurements. For timing tests, the EUT is programmed for manual TX operation. The EUT was programmed through the USB port. The USB port was left unpopulated during testing since it is only used for factory programming and the USB port will remain inaccessible by the user after it is installed into the vehicle.

SETUP DIAGRAM FOR TESTS

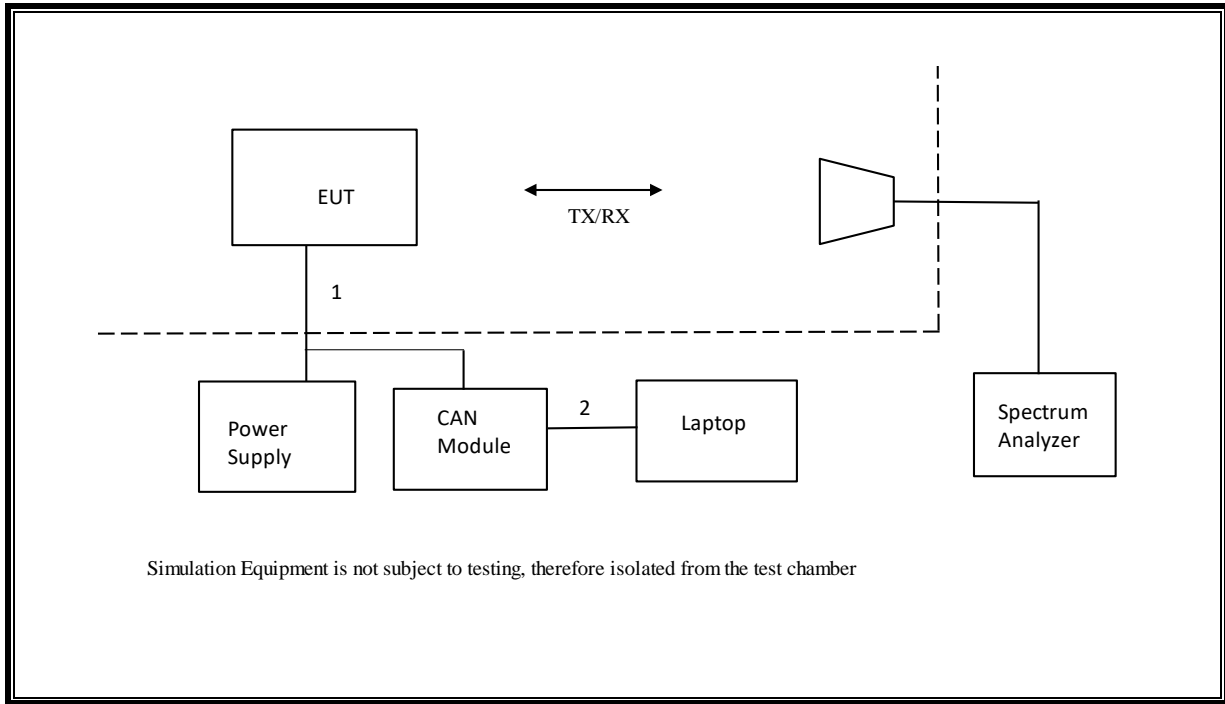

6. TEST AND MEASUREMENT EQUIPMENT

The following test and measurement equipment was utilized for the tests documented in this report:

TEST EQUIPMENT LIST					
Description	Manufacturer	Model	ID Num	Cal Due	Last Cal
Amplifier, 9KHz to 1GHz, 32dB	SONOMA INSTRUMENT	310	PRE0180174	05/31/2019	05/31/2018
Antenna, Horn 1-18GHz	ETS-Lindgren	3117	T344	04/30/2019	04/30/2018
EMI TEST RECEIVER	Rohde & Schwarz	ESW44	PRE0179372	05/04/2019	05/04/2018
EMI TEST RECEIVER	Rohde & Schwarz	ESW44	PRE0179375	05/08/2019	05/08/2018
Spectrum Analyzer, PXA, 3Hz to 44GHz	Agilent (Keysight) Technologies	N9030A	T1450	01/23/2020	01/23/2019
Hybrid Antenna, 30MHz to 3GHz	SunAR rf motion	JB3	PRE0181575	08/01/2019	08/01/2018
Amplifier, 1 to 18GHz, 35dB	AMPLICAL	AMP1G18--35	T1569	06/03/2019	06/03/2018
Antenna, Passive Loop 30Hz to 1MHz	ELETRO METRICS	EM-6871	PRE0179465	05/22/2019	05/22/2018
Antenna, Passive Loop 100kHz to 30MHz	ELETRO METRICS	EM-6872	PRE0179467	05/22/2019	05/22/2018
Radiated Software	UL	UL EMC	Ver 9.5, June 22, 2018		

7. ANTENNA PORT TEST RESULTS

7.1. 20 dB AND 99% BW

LIMITS

FCC §15.231 (c)

The bandwidth of the emission shall be no wider than 0.25% of the center frequency for devices operating above 70 MHz and below 900 MHz. For devices operating above 900 MHz, the emission shall be no wider than 0.5% of the center frequency. Bandwidth is determined at the points 20 dB down from the modulated carrier.

IC A1.3

For the purpose of Section A1.1, the 99% Bandwidth shall be no wider than 0.25% of the center frequency for devices operating between 70-900 MHz. For devices operating above 900 MHz, the emission shall be no wider than 0.5% of the center frequency.

TEST PROCEDURE

ANSI C63.10

The transmitter output is connected to the spectrum analyzer.

20dB and 99% Bandwidth: The RBW is set to 1% to 3% of the 99 % bandwidth. The VBW is set to 3 times the RBW. The sweep time is coupled. The spectrum analyzer internal 99% bandwidth function is utilized.

Note: Because the measured signal is CW or CW-like adjusting the RBW per C63.10 would not be practical since measured bandwidth will always follow the RBW and the result will be approximately twice the RBW

RESULTS

No non-compliance noted:

20dB Bandwidth

Frequency (MHz)	20dB Bandwidth (kHz)	Limit (kHz)	Margin (kHz)
315	50.83	787.5	-736.67

99% Bandwidth

Frequency (MHz)	99% Bandwidth (kHz)	Limit (kHz)	Margin (kHz)
315	232.12	787.5	-555.38

99% AND 20dB BANDWIDTH

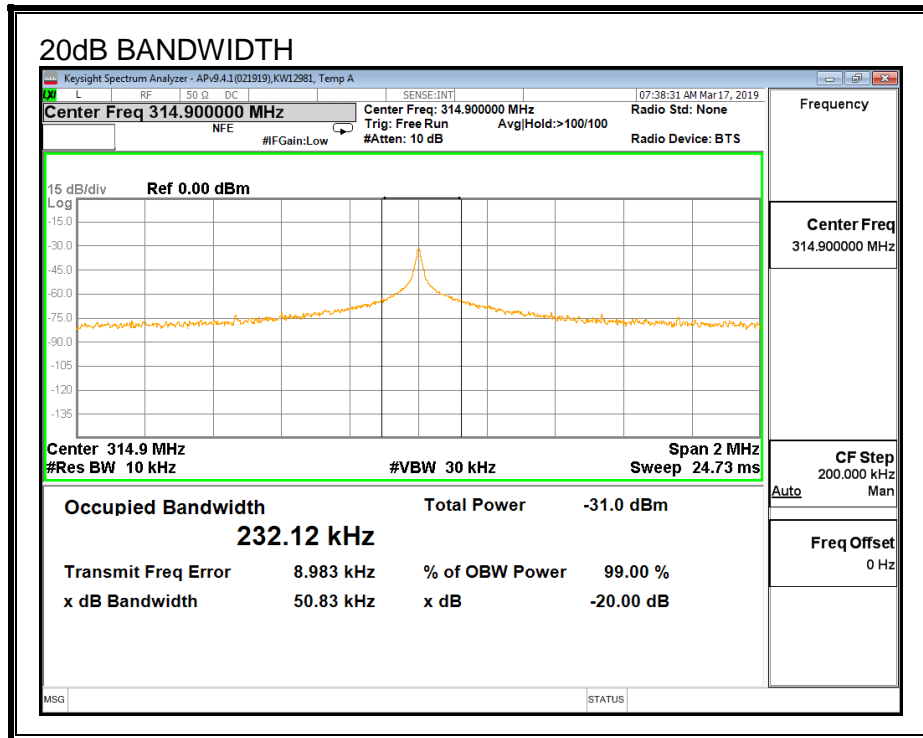

7.2. DUTY CYCLE

LIMITS

FCC §15.35 (c)

The measurement field strength shall be determined by averaging over one complete pulse train, including blanking intervals, as long as the pulse train does not exceed 0.1 seconds. As an alternative (provided the transmitter operates for longer than 0.1 seconds) or in cases where the pulse train exceeds 0.1 seconds, the measured field strength shall be determined from the average absolute voltage during a 0.1 second interval during which the field strength is at its maximum value. The exact method of calculating the average field strength shall be submitted with any application for certification or shall be retained in the measurement data file for equipment subject to notification or verification.

TEST PROCEDURE

The transmitter output is connected to a spectrum analyzer or radiated field strength. The RBW is set to 3MHz and the VBW is set to 50MHz. The sweep time is coupled and the span is set to 0 Hz. The number of pulses is measured and calculated in a 100 ms scan.

CALCULATION

Average Reading = Peak Reading (dBuV/m) + 20log (Duty Cycle), Where Duty Cycle is (# of long pulses * long pulse width) + (# of short pulses * short pulse width) / 100 or T

RESULTS

No non-compliance noted:

One Period (ms)	Long Pulse Width (ms)	# of Long Pulses	Short Width (ms)	# of Short Pulses	Duty Cycle	20*Log Duty Cycle (dB)
100	0.24	45	0.12	54	0.173	-15.25

ONE PERIOD



SHORT AND LONG PULSE WIDTH

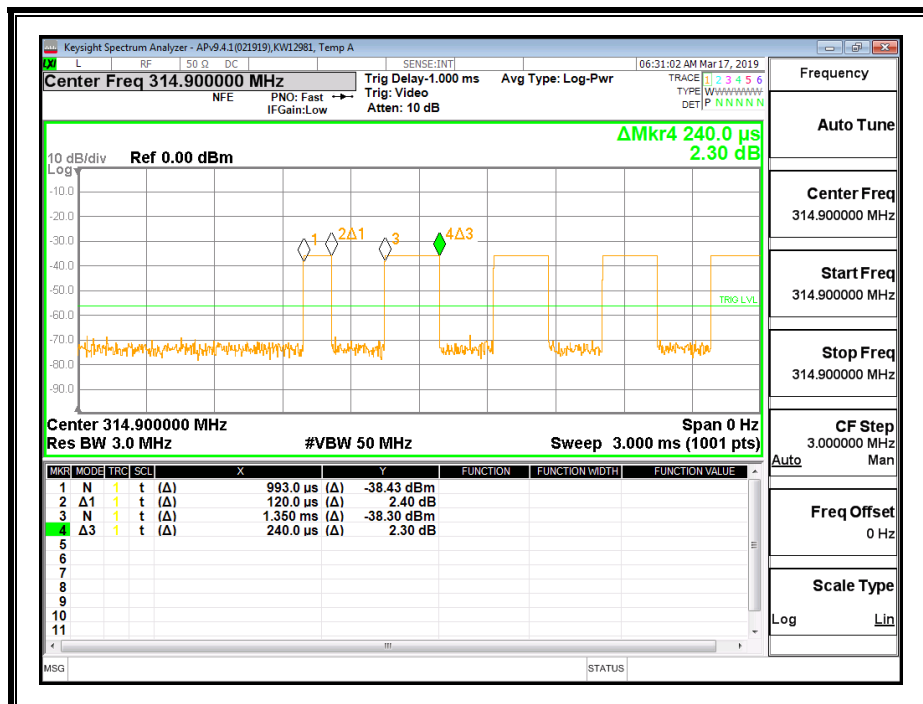

SHORT AND LONG PULSES

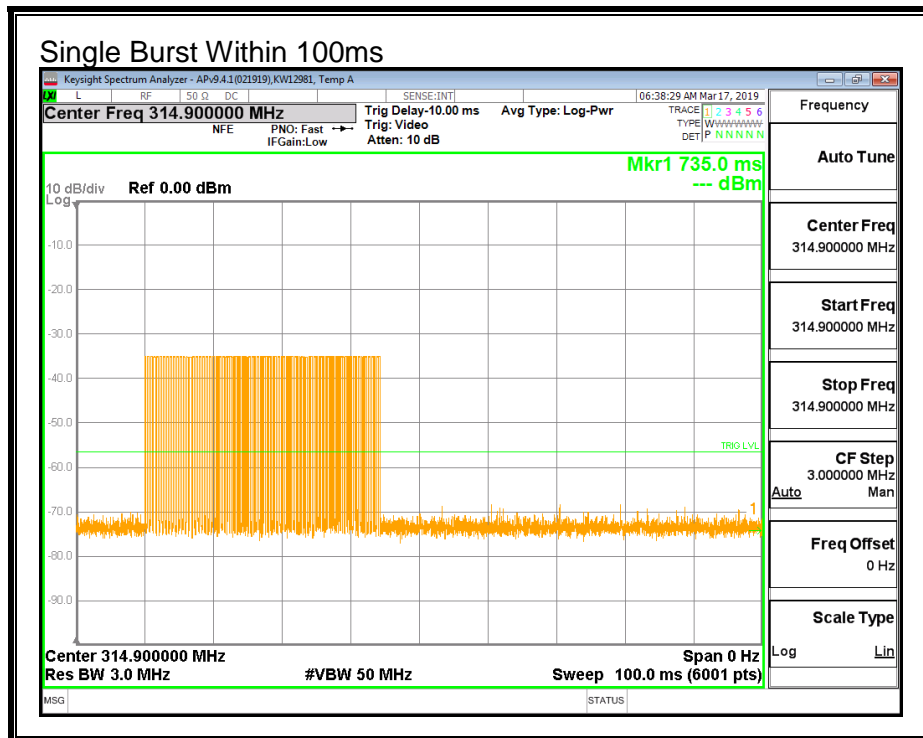
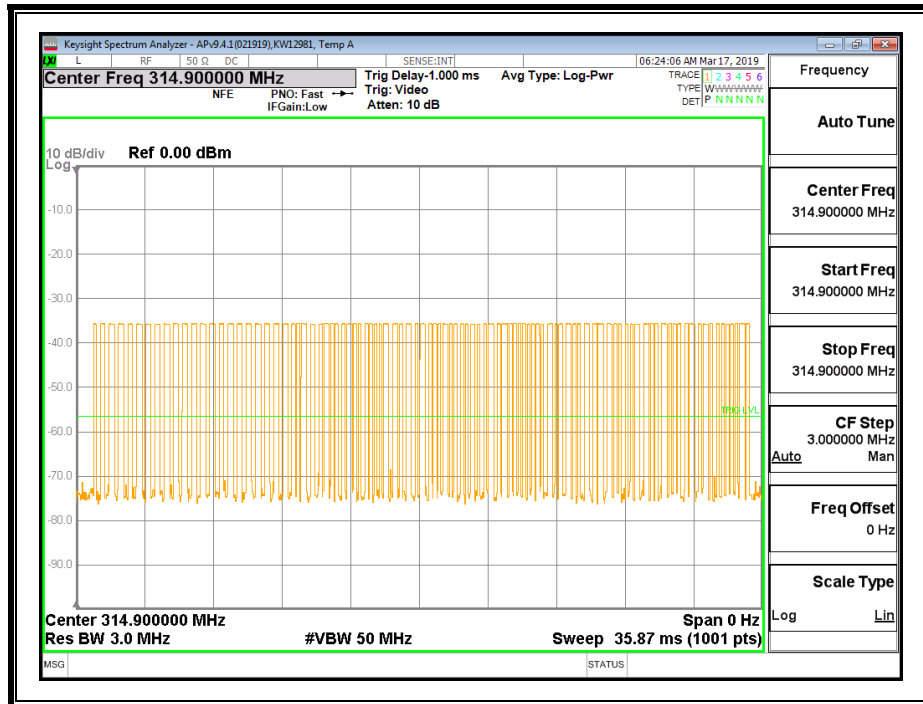

7.3. TRANSMISSION TIME

LIMITS

FCC §15.231 (a) (2)

IC A1.1

A transmitter activated automatically shall cease transmission within 5 seconds after activation.

TEST PROCEDURE

The transmitter output is connected to a spectrum analyzer or radiated field strength. The RBW is set to 3MHz and the VBW is set to 50MHz. The sweep time is set to 10 seconds and the span is set to 0 Hz.

RESULTS

No non-compliance noted:

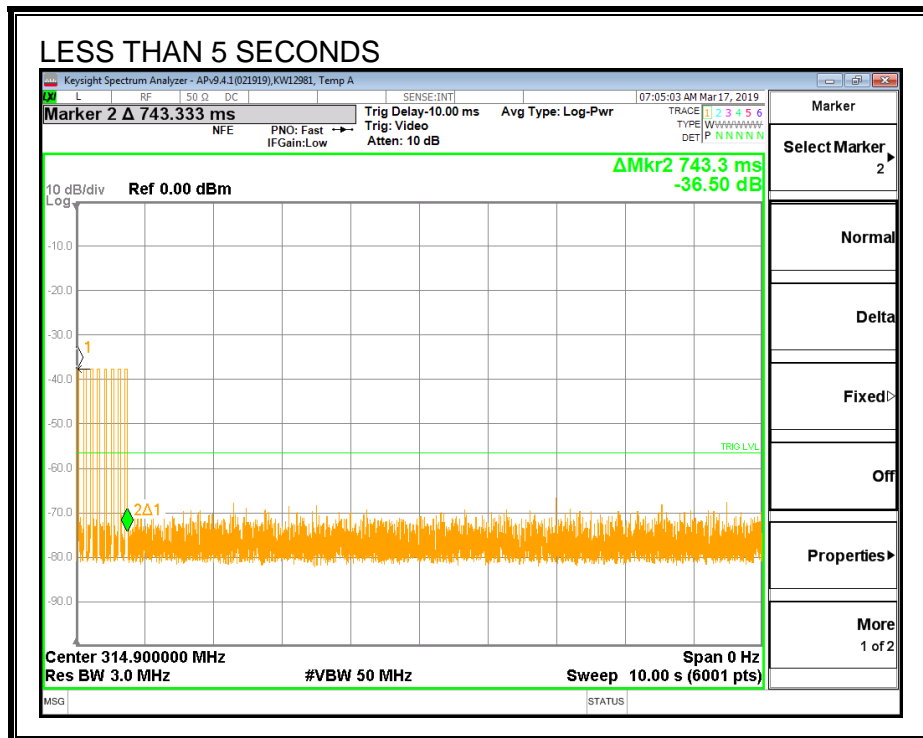

8. RADIATED EMISSION TEST RESULTS

8.1. TX RADIATED SPURIOUS EMISSION

LIMITS

FCC §15.231 (b)
 IC A1.2

In addition to the provisions of § 15.205, the field strength of emissions from Intentional radiators operated under this section shall not exceed the following:

Fundamental Frequency (MHz)	Field Strength of Fundamental Frequency (microvolts/meter)	Field Strength of Spurious Emissions (microvolts/meter)
40.66 - 40.70	2,250	225
70 - 130	1,250	125
130 - 174	1,250 to 3,750 ¹	125 to 375 ¹
174 - 260	3,750	375
260 - 470	3,750 to 12,500 ¹	375 to 1,250 ¹
Above 470	12,500	1,250

¹ Linear interpolation

§15.205 (a) Except as shown in paragraph (d) of this section, only spurious emissions are permitted in any of the frequency bands listed below:

MHz	MHz	MHz	GHz
0.090 - 0.110	16.42 - 16.423	399.9 - 410	4.5 - 5.15
¹ 0.495 - 0.505	16.69475 - 16.69525	608 - 614	5.35 - 5.46
2.1735 - 2.1905	16.80425 - 16.80475	960 - 1240	7.25 - 7.75
4.125 - 4.128	25.5 - 25.67	1300 - 1427	8.025 - 8.5
4.17725 - 4.17775	37.5 - 38.25	1435 - 1626.5	9.0 - 9.2
4.20725 - 4.20775	73 - 74.6	1645.5 - 1646.5	9.3 - 9.5
6.215 - 6.218	74.8 - 75.2	1660 - 1710	10.6 - 12.7
6.26775 - 6.26825	108 - 121.94	1718.8 - 1722.2	13.25 - 13.4
6.31175 - 6.31225	123 - 138	2200 - 2300	14.47 - 14.5
8.291 - 8.294	149.9 - 150.05	2310 - 2390	15.35 - 16.2
8.362 - 8.366	156.52475 -	2483.5 - 2500	17.7 - 21.4
8.37625 - 8.38675	156.52525	2655 - 2900	22.01 - 23.12
8.41425 - 8.41475	156.7 - 156.9	3260 - 3267	23.6 - 24.0
12.29 - 12.293	162.0125 - 167.17	3332 - 3339	31.2 - 31.8
12.51975 - 12.52025	167.72 - 173.2	3345.8 - 3358	36.43 - 36.5
12.57675 - 12.57725	240 - 285	3600 - 4400	(²)
13.36 - 13.41	322 - 335.4		

1 Until February 1, 1999, this restricted band shall be 0.490-0.510 MHz.
 2 Above 38.6

§15.205 (b) Except as provided in paragraphs (d) and (e), the field strength of emissions appearing within these frequency bands shall not exceed the limits shown in Section 15.209. At frequencies equal to or less than 1000 MHz, compliance with the limits in Section 15.209 shall be demonstrated using measurement instrumentation employing a CISPR quasi peak detector. Above 1000 MHz, compliance with the emission limits in Section 15.209 shall be demonstrated based on the average value of the measured emissions. The provisions in Section 15.35 apply to these measurements.

§15.209 (a) Except as provided elsewhere in this Subpart, the emissions from an intentional radiator shall not exceed the field strength levels specified in the following table:

Frequency (MHz)	Field Strength (microvolts/meter)	Measurement Distance (meters)
30-88	100 **	3
88-216	150 **	3
216-960	200 **	3
Above 960	500	3

** Except as provided in paragraph (g), fundamental emissions from intentional radiators operating under this Section shall not be located in the frequency bands 54 72 MHz, 76 88 MHz, 174 216 MHz or 470 806 MHz. However, operation within these frequency bands is permitted under other sections of this Part, e.g., Sections 15.231 and 15.241.

§15.209 (b) In the emission table above, the tighter limit applies at the band edges.

Fundamental Frequency Limits and Non-restricted band Harmonic Limits		
Frequency (MHz)	Limit (dBuV/m @ 3m distance All harmonic except those in restricted bands must be attenuated by 20dB or more	
	Average Fundamental	Peak Fundamental
315	75.62	95.62
Supplementary Information: See section 7.2 for duty cycle information		

RESULTS

8.1.1. TX SPURIOUS EMISSION BELOW 30 MHz

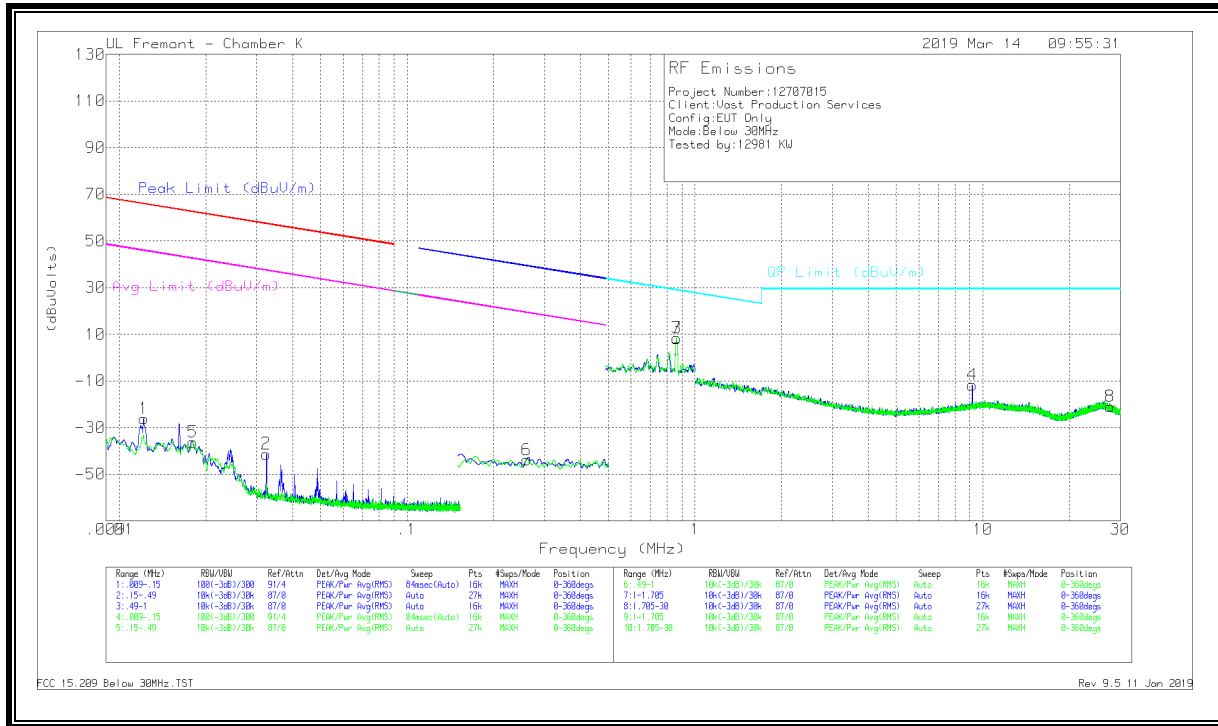

DATA

Marker	Frequency (MHz)	Meter Reading (dBuV)	Det	Loop Antenna (ACF)	Cables w/ PRE0186650	Dist Corr 300m	Corrected Reading (dBuVolts)	Peak Limit (dBuV/m)	Margin (dB)	Avg Limit (dBuV/m)	Margin (dB)	Azimuth (Degs)
1	.01216	25.73	Pk	60	-31.8	-80	-26.07	65.89	-91.96	45.89	-71.96	0-360
2	.03249	13.26	Pk	57.7	-32.2	-80	-41.24	57.35	-98.59	37.35	-78.59	0-360
5	.01797	16.37	Pk	59.3	-32	-80	-36.33	62.49	-98.82	42.49	-78.82	0-360
6	.26018	11.87	Pk	56.3	-32.1	-80	-43.93	39.31	-83.24	19.31	-63.24	0-360

Marker	Frequency (MHz)	Meter Reading (dBuV)	Det	Loop Antenna (ACF)	Cables w/ PRE0186650	Dist Corr 30m (dB) 40Log	Corrected Reading (dBuVolts)	QP Limit (dBuV/m)	Margin (dB)	Azimuth (Degs)
3	.86189	24.1	Pk	56.3	-32.1	-40	8.3	28.91	-20.61	0-360
7	.86256	24.21	Pk	56.3	-32.1	-40	8.41	28.9	-20.49	0-360
4	9.18667	25.47	Pk	34.5	-31.8	-40	-11.83	29.5	-41.33	0-360
8	27.62309	17.45	Pk	33.1	-31.6	-40	-21.05	29.5	-50.55	0-360

Pk - Peak detector

Radiated Emissions

FCC 15.209 Below 30MHz.TST
 Rev 9.5 11 Jan 2019

8.1.2. FUNDAMENTAL, HARMONICS AND TX SPURIOUS EMISSION (30 – 1000 MHz)

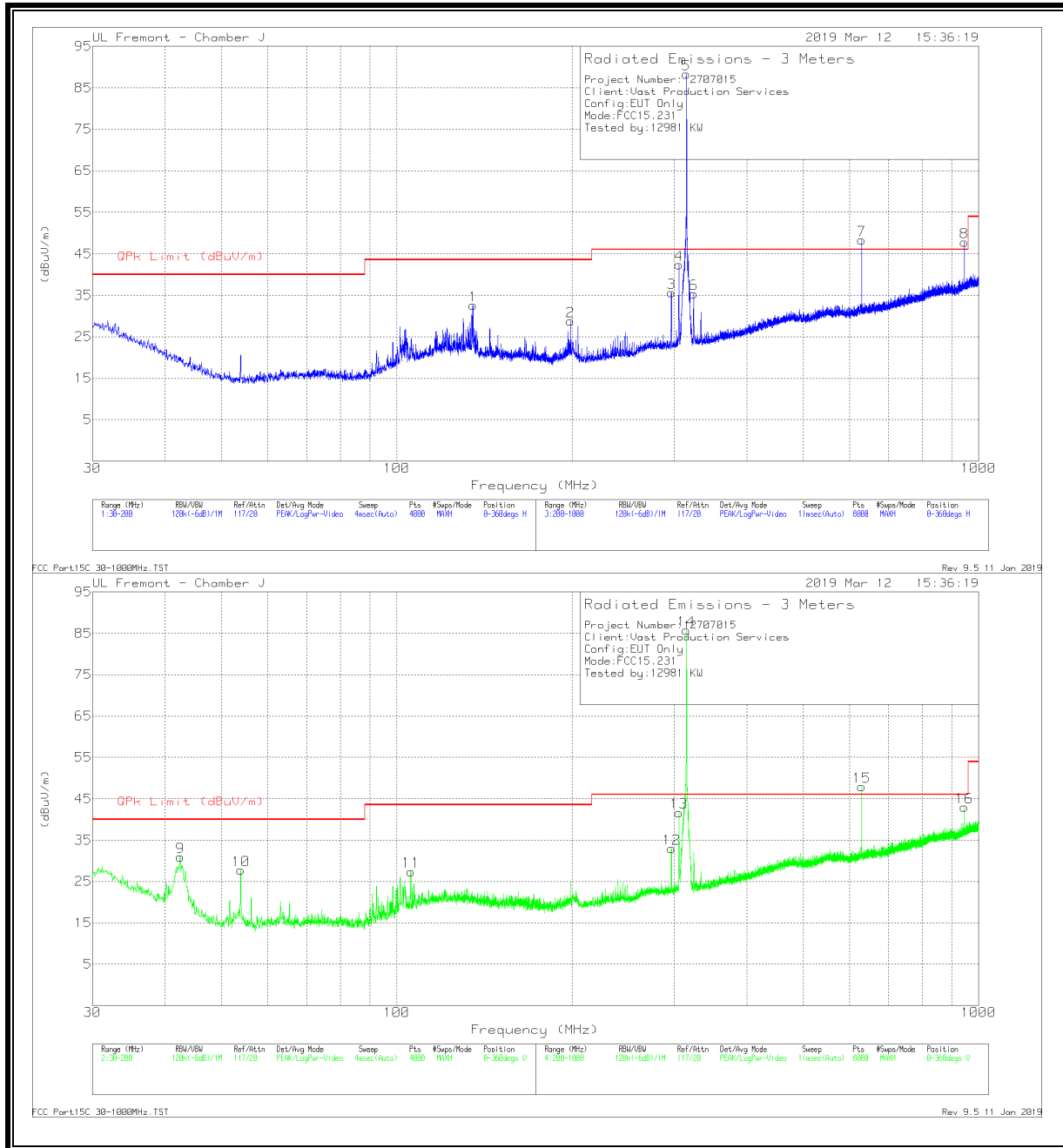

RESULT:

Marker	Frequency (MHz)	Meter Reading (dBuV)	Det	AF PRE0181575 (dB/m)	Amp Cbl (dB)	Corrected Reading (dBuV/m)	QP Limit (dBuV/m)	Margin (dB)	Azimuth (Degs)	Height (cm)	Polarity
1	* 135.1722	43.99	Pk	19.3	-30.7	32.59	43.52	-10.93	175	198	H
2	198.9812	40.83	Pk	18.4	-30.4	28.83	43.52	-14.69	150	198	H
9	42.4557	44.78	Pk	17.6	-31.4	30.98	40	-9.02	220	101	V
10	53.9337	45.99	Pk	13.1	-31.3	27.79	40	-12.21	210	101	V
11	105.7121	40.54	Pk	17.8	-30.9	27.44	43.52	-16.08	235	101	V
3	296.5125	46.39	Pk	19.2	-30	35.59	46.02	-10.43	242	101	H
4	305.6914	54.71	Pk	19.5	-30	44.21	46.02	-1.81	204	116	H
	305.6914	51.80	QP	19.5	-30	41.3	46.02	-4.72	204	116	H
6	* 323.8161	45.46	Pk	19.8	-29.9	35.36	46.02	-10.66	320	101	H
12	296.5125	43.79	Pk	19.2	-30	32.99	46.02	-13.03	270	198	V
13	305.6137	52.57	Pk	19.5	-30	42.07	46.02	-3.95	197	115	V
	305.6137	48.66	QP	19.5	-30	38.16	46.02	-7.86	197	115	V

Radiated Emissions

Marker	Frequency (MHz)	Meter Reading (dBuV)	Det	AF PRE0181575 (dB/m)	Amp Cbl (dB)	Peak Reading (dBuV/m)	Peak Limit (dBuV/m)	Pk Margin (dBuV/m)	Av Limit (dBuV/m)	DC Factory (dB)	Av Margin (dBuV/m)	Azimuth (Degs)	Height (cm)	Polarity
5	314.9	97.68	Pk	19.8	-29.9	87.58	95.62	-8.04	75.62	-15.25	-3.29	196	141	H
7	629.8	52.15	Pk	25.4	-29.2	45.34	75.62	-30.28	55.62	-15.25	-25.53	107	187	H
8	944.7	45.45	Pk	28.7	-26.8	47.35	75.62	-28.27	55.62	-15.25	-25.52	281	100	H
14	314.9	92.17	Pk	19.8	-29.9	82.07	95.62	-13.55	75.62	-15.25	-8.8	104	145	V
15	629.8	52.70	Pk	25.4	-29.2	48.90	75.62	-26.72	55.62	-15.25	-21.97	139	178	V
16	944.7	41.63	Pk	28.7	-26.8	43.53	75.62	-32.09	55.62	-15.25	-27.34	241	144	V

Pk - Peak detector

QP-Quasi Peak

* Average Reading = Peak Reading (dBuV/m) + 20log (Duty Cycle), Where Duty Cycle is -15.25dB

(# of long pulses * long pulse width) + (# of ,medium pulses * medium pulse width) + (# of short pulses * short pulse width) / 100 or T

Refer to section 7.2 for duty cycle factor calculation (-15.25dB)

Note: Radiated peak result is based on 100% duty cycle sample; average reading = peak reading + DCCF

** Harmonics of fundamental 315MHz

8.1.3. HARMONICS AND TX SPURIOUS EMISSIONS ABOVE 1GHz

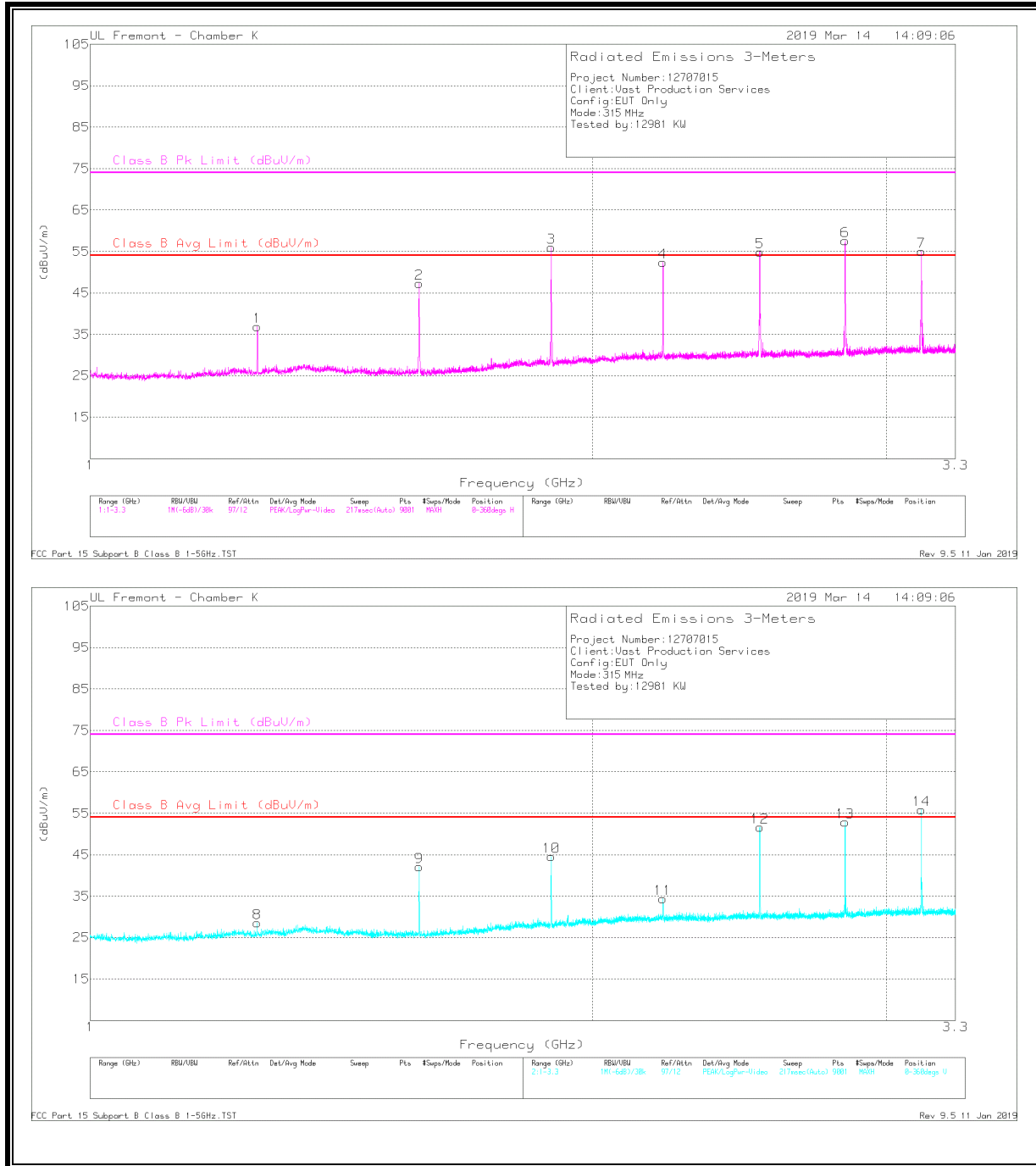

RESULTS:

Marker	Frequency (GHz)	Meter Reading (dBuV)	Det	AF T344 (dB/m)	Amp/Cbi (dB)	Peak Reading (dBuV/m)	DC Factor (dB)	Corrected Reading with DC Factor	PK Limit (dBuV/m)	Margin (dB)	Avg Limit (dBuV/m)	Margin (dB)	Azimuth (Degs)	Height (cm)	Polarity
3	1.889	63.61	Pk	30.4	-35.4	58.61	-15.25	43.36	74	-30.64	54	-10.64	188	157	H
1	1.26	47.44	Pk	28.7	-35.4	40.74	-15.25	25.49	74	-48.51	54	-28.51	224	212	H
2	1.575	58.82	Pk	28.1	-35.5	51.42	-15.25	36.17	74	-37.83	54	-17.83	22	175	H
4	2.204	56.03	Pk	31.8	-35.4	52.43	-15.25	37.18	74	-36.82	54	-16.82	8	130	H
5	2.519	61.95	Pk	32.3	-35.4	58.85	-15.25	43.6	74	-30.4	54	-10.4	179	256	H
6	2.834	66.37	Pk	32.3	-34.9	63.77	-15.25	48.52	74	-25.48	54	-5.48	183	168	H
7	3.149	63.5	Pk	32.9	-34	62.4	-15.25	47.15	74	-26.85	54	-6.85	203	231	H
8	1.26	44.02	Pk	28.7	-35.4	37.32	-15.25	22.07	74	-51.93	54	-31.93	75	155	V
9	1.575	54.16	Pk	28.1	-35.5	46.76	-15.25	31.51	74	-42.49	54	-22.49	17	292	V
10	1.889	56.18	Pk	30.4	-35.4	51.18	-15.25	35.93	74	-38.07	54	--18.07	337	398	V
11	2.204	49.79	Pk	31.8	-35.4	46.19	-15.25	30.94	74	-43.06	54	--23.06	270	103	V
12	2.519	56.37	Pk	32.3	-35.4	53.27	-15.25	38.02	74	-35.98	54	-15.98-	355	104	V
13	2.834	60.22	Pk	32.3	-34.9	57.62	-15.25	42.37	74	-31.63	54	-11.63-	218	237	V
14	3.149	55.97	Pk	32.9	-34	54.87	-15.25	39.62	74	-34.38	54	-14.38-	243	375	V

* Average Reading = Peak Reading (dBuV/m) + 20log (Duty Cycle), Where Duty Cycle is -15.25dB
 (# of long pulses * long pulse width) + (# of ,medium pulses * medium pulse width) + (# of short pulses * short pulse width) /
 100 or T
 Refer to section 7.2 for duty cycle factor calculation (-15.25dB)
 Note: Radiated peak result is based on 100% duty cycle sample; average reading = peak reading + DCCF
 ** Harmonics of fundamental 315MHz

END OF TEST REPORT

9. SETUP PHOTOS

Please refer to 12707015-EP1V1