

# TEST REPORT

**Product Name** : Bluetooth Earphones  
**Model Number** : T10M,T10E  
**FCC ID** : 2AJEO-T10MR

Prepared for : Xiamen Padmate Technology Co.,LTD  
Address : RM 201, Huli Park No.37, Industrial Zone, Tong'an District,  
Xiamen, China

Prepared by : EMTEK (SHENZHEN) CO., LTD.  
Address : Building 69, Majialong Industry Zone, Nanshan District,  
Shenzhen, Guangdong, China

Tel: (0755) 26954280  
Fax: (0755) 26954282

Report Number : ES201225091W02  
Date(s) of Tests : December 29, 2020 to January 19, 2021  
Date of issue : January 19, 2021

## Table of Contents

<b>TEST REPORT</b> .....	1
1 TEST RESULT CERTIFICATION .....	3
2 EUT TECHNICAL DESCRIPTION .....	5
3 SUMMARY OF TEST RESULT .....	6
4 TEST METHODOLOGY .....	7
4.1 GENERAL DESCRIPTION OF APPLIED STANDARDS .....	7
4.2 MEASUREMENT EQUIPMENT USED .....	7
4.3 DESCRIPTION OF TEST MODES .....	9
5 FACILITIES AND ACCREDITATIONS .....	10
5.1 FACILITIES .....	10
5.2 LABORATORY ACCREDITATIONS AND LISTINGS .....	10
5.3 TEST SOFTWARE .....	10
6 TEST SYSTEM UNCERTAINTY .....	11
7 SETUP OF EQUIPMENT UNDER TEST .....	12
7.1 RADIO FREQUENCY TEST SETUP 1 .....	12
7.2 RADIO FREQUENCY TEST SETUP 2 .....	12
7.3 CONDUCTED EMISSION TEST SETUP .....	13
7.4 BLOCK DIAGRAM CONFIGURATION OF TEST SYSTEM .....	14
7.5 SUPPORT EQUIPMENT .....	14
8 FREQUENCY HOPPING SYSTEM REQUIREMENTS .....	15
8.1 STANDARD APPLICABLE .....	15
8.2 EUT PSEUDORANDOM FREQUENCY HOPPING SEQUENCE .....	15
8.3 EQUAL HOPPING FREQUENCY USE .....	16
8.4 FREQUENCY HOPPING SYSTEM .....	16
9 TEST REQUIREMENTS .....	17
9.1 20DB BANDWIDTH .....	17
9.2 CARRIER FREQUENCY SEPARATION .....	23
9.3 NUMBER OF HOPPING FREQUENCIES .....	29
9.4 AVERAGE TIME OF OCCUPANCY (DWELL TIME) .....	31
9.5 MAXIMUM PEAK CONDUCTED OUTPUT POWER .....	34
9.6 CONDUCTED SPURIOUS EMISSION .....	40
9.7 RADIATED SPURIOUS EMISSION .....	47
9.8 CONDUCTED EMISSION TEST .....	60
9.9 ANTENNA APPLICATION .....	63

# 1 TEST RESULT CERTIFICATION

Applicant : Xiamen Padmate Technology Co.,LTD  
 Address : RM 201, Huli Park No.37, Industrial Zone, Tong'an District, Xiamen, China  
 Manufacturer : Xiamen Padmate Technology Co.,LTD  
 Address : RM 201, Huli Park No.37, Industrial Zone, Tong'an District, Xiamen, China  
 Trade Mark : Padmate  
 EUT : Bluetooth Earphones  
 Model No. : T10M,T10E

Measurement Procedure Used:

APPLICABLE STANDARDS	
STANDARD	TEST RESULT
FCC 47 CFR Part 2, Subpart J FCC 47 CFR Part 15, Subpart C	PASS

The above equipment was tested by EMTEK (SHENZHEN) CO., LTD. The test data, data evaluation, test procedures, and equipment configurations shown in this report were made in accordance with the procedures given in ANSI C63.10 (2013) and the energy emitted by the sample EUT tested as described in this report is in compliance with the requirements of FCC Rules Part 2 and Part 15.247.

This report applies to above tested sample only and shall not be reproduced in part without written approval of EMTEK (SHENZHEN) CO., LTD.

Date of Test : December 29, 2020 to January 15, 2021

Prepared by : Jessica Lao  
Jessica Lao /Editor

Reviewer : Sewen Guo  
Sewen Guo /Supervisor

Approve & Authorized Signer : Lisa Wang  
Lisa Wang/Manager



## Modified Information

Version	Report No.	Revision Data	Summary
Ver.1.0	ES201225091W02	/	Original Version



## 2 EUT TECHNICAL DESCRIPTION

Characteristics	Description
<b>Product</b>	Bluetooth Earphones
<b>Model Number</b>	T10M,T10E
<b>Sample</b>	2#
<b>Data Rate</b>	1Mbps for GFSK modulation 2Mbps for pi/4-DQPSK modulation 3Mbps for 8DPSK modulation
<b>Modulation:</b>	GFSK, pi/4-DQPSK, 8DPSK
<b>Operating Frequency Range(s):</b>	2402-2480MHz
<b>Number of Channels:</b>	79 channels
<b>Transmit Power Max:</b>	3.74 dBm
<b>Antenna Type:</b>	LDS antenna
<b>Antenna Gain:</b>	1.12 dBi
<b>Power supply</b>	DC5V form USB port DC 3.7V from Battery
<b>Battery information</b>	Earphone Model : WD1240 Rating : 3.7V 45mAh 0.167Wh Charging box Model : 602535 Rating : 3.7V 500mAh 1.85Wh
<b>Date of Received:</b>	December 28, 2020.
<b>Temperature Range:</b>	-10°C ~ +55°C

**Note:** for more details, please refer to the User's manual of the EUT.

### 3 SUMMARY OF TEST RESULT

FCC Part Clause	Test Parameter	Verdict	Remark
15.247(a)(1)	20 dB Bandwidth	PASS	
15.247(a)(1)	Carrier Frequency Separation	PASS	
15.247(a)(1)	Number of Hopping Frequencies	PASS	
15.247(a)(1)	Average Time of Occupancy (Dwell Time)	PASS	
15.247(b)(1)	Maximum Peak Conducted Output Power	PASS	
15.247(c)	Conducted Spurious Emissions	PASS	
15.247(d) 15.209	Radiated Spurious Emissions	PASS	
15.207	Conducted Emission	PASS	
15.203	Antenna Application	PASS	
NOTE1: N/A (Not Applicable)			

RELATED SUBMITTAL(S) / GRANT(S):

This submittal(s) (test report) is intended for FCC ID: 2AJEO-T10MR filing to comply with Section 15.247 of the FCC Part 15, Subpart C Rules.



## 4 TEST METHODOLOGY

### 4.1 GENERAL DESCRIPTION OF APPLIED STANDARDS

According to its specifications, the EUT must comply with the requirements of the following standards:

FCC 47 CFR Part 2, Subpart J

FCC 47 CFR Part 15, Subpart C

KDB 558074 D01 MEAS GUIDANCE V05r02

### 4.2 MEASUREMENT EQUIPMENT USED

#### 4.2.1 Conducted Emission Test Equipment

EQUIPMENT TYPE	MFR	MODEL NUMBER	SERIAL NUMBER	LAST CAL.	DUE CAL.
Test Receiver	Rohde & Schwarz	ESCS30	828985/018	05/16/2020	05/17/2021
L.I.S.N.	Schwarzbeck	NNLK8129	8129203	05/16/2020	05/17/2021
50Ω Coaxial Switch	Anritsu	MP59B	M20531	05/16/2020	05/17/2021
Pulse Limiter	Rohde & Schwarz	ESH3-Z2	100006	05/16/2020	05/17/2021
Voltage Probe	Rohde & Schwarz	TK9416	N/A	05/16/2020	05/17/2021
I.S.N	Rohde & Schwarz	ENY22	1109.9508.02	05/16/2020	05/17/2021

#### 4.2.2 For 3m Radiated Emission Measurement 30M-1G (3m chamber 1#)

Equipment	Manufacturer	Model No.	Serial No.	Last Cal.	Cal. Interval
EMI Test Receiver	Rohde & Schwarz	ESU	1302.6005.26	05/16/2020	05/17/2021
Pre-Amplifier	HP	8447F	2944A07999	05/16/2020	05/17/2021
Bilog Antenna	Schwarzbeck	VULB9163	142	05/16/2020	05/17/2021
Cable	Schwarzbeck	AK9513	ACRX1	05/16/2020	05/17/2021
Cable	Rosenberger	N/A	FP2RX2	05/16/2020	05/17/2021
Cable	Schwarzbeck	AK9513	CRPX1	05/16/2020	05/17/2021
Cable	Schwarzbeck	AK9513	CRRX2	05/16/2020	05/17/2021

#### 4.2.3 For 3m Radiated Emission Measurement 1G-18G (3m chamber 1#)

Equipment	Manufacturer	Model No.	Serial No.	Last Cal.	Cal. Interval
EMI Test Receiver	Rohde & Schwarz	ESU	1302.6005.26	05/16/2020	05/17/2021
Pre-Amplifier	A.H.	PAM-0126	1415261	05/16/2020	05/17/2021
Horn Antenna	Schwarzbeck	BBHA 9120	707	05/16/2020	05/17/2021
Cable	H+B	0.5M SF104-26.5	289147/4	05/16/2020	05/17/2021
Cable	H+B	3M SF104-26.5	295838/4	05/16/2020	05/17/2021
Cable	H+B	6M SF104-26.5	295840/4	05/16/2020	05/17/2021

**4.2.4 For 3m Radiated Emission Measurement 18G-26.5G (3m chamber 1#)**

Equipment	Manufacturer	Model No.	Serial No.	Last Cal.	Cal. Interval
EMI Test Receiver	Rohde & Schwarz	ESU	1302.6005.26	05/16/2020	05/17/2021
Pre-Amplifier	A.H.	PAM-0126	1415261	05/16/2020	05/17/2021
Horn Antenna	Schwarzbeck	BBHA 9170	BBHA9170399	05/16/2020	05/17/2021
Cable	H+B	0.5M SF104-26.5	289147/4	05/16/2020	05/17/2021
Cable	H+B	3M SF104-26.5	295838/4	05/16/2020	05/17/2021
Cable	H+B	6M SF104-26.5	295840/4	05/16/2020	05/17/2021

**4.2.5 Radio Frequency Test Equipment**

EQUIPMENT TYPE	MFR	MODEL NUMBER	SERIAL NUMBER	LAST CAL.	DUE CAL.
Spectrum Analyzer	Agilent	E4407B	88156318	05/16/2020	05/17/2021
Signal Analyzer	Agilent	N9010A	My53470879	05/16/2020	05/17/2021
Power meter	Anritsu	ML2495A	0824006	05/16/2020	05/17/2021
Power sensor	Anritsu	MA2411B	0738172	05/16/2020	05/17/2021
Spectrum Analyzer	Rohde & Schwarz	FSV40	100967	05/16/2020	05/17/2021

**Remark:** Each piece of equipment is scheduled for calibration once a year.



### 4.3 DESCRIPTION OF TEST MODES

The EUT has been tested under its typical operating condition.

The EUT configuration for testing is installed on RF field strength measurement to meet the Commissions requirement and operating in a manner which intends to maximize its emission characteristics in a continuous normal application.

The Transmitter was operated in the normal operating mode. The TX frequency was fixed which was for the purpose of the measurements.

Test of channel included the lowest and middle and highest frequency to perform the test, then record on this report.

Those data rates (1Mbps for Bluetooth BR GFSK modulation; 2Mbps for Bluetooth EDR pi/4-DQPSK modulation; 3Mbps for Bluetooth EDR 8DPSK modulation ) were used for all test.

Pre-defined engineering program for regulatory testing used to control the EUT for staying in continuous transmitting and receiving mode is programmed.

Frequency and Channel list for Bluetooth with classic mode:

Channel	Frequency (MHz)	Channel	Frequency (MHz)	Channel	Frequency (MHz)
0	2402	39	2441	...	...
1	2403	40	2442	76	2478
2	2404	41	2443	77	2479
...	...	...	...	78	2480
Note: $f_c = 2402\text{MHz} + (k-1) \times 1\text{MHz}$ k=1 to 79					

Test Frequency and channel for Bluetooth with classic mode:

Lowest Frequency		Middle Frequency		Highest Frequency	
Channel	Frequency (MHz)	Channel	Frequency (MHz)	Channel	Frequency (MHz)
0	2402	39	2441	78	2480

## 5 FACILITIES AND ACCREDITATIONS

### 5.1 FACILITIES

All measurement facilities used to collect the measurement data are located at

Building 69, Majialong Industry Zone District, Nanshan District, Shenzhen, China

The sites are constructed in conformance with the requirements of ANSI C63.7, ANSI C63.10 and CISPR Publication 22.

### 5.2 LABORATORY ACCREDITATIONS AND LISTINGS

Site Description

EMC Lab.

: **Accredited by CNAS**

The Certificate Registration Number is L2291.

The Laboratory has been assessed and proved to be in compliance with CNAS-CL01 (identical to ISO/IEC 17025:2017)

**Accredited by FCC**

Designation Number: CN1204

Test Firm Registration Number: 882943

**Accredited by A2LA**

The Certificate Number is 4321.01.

**Accredited by Industry Canada**

The Conformity Assessment Body Identifier is CN0008

Name of Firm : EMTEK (SHENZHEN) CO., LTD.

Site Location : Building 69, Majialong Industry Zone, Nanshan District, Shenzhen, Guangdong, China

### 5.3 TEST SOFTWARE

Item Software

RF conducted: : ETSI Certification of Regulations Test Solution(V1.04.01)

Radiated Emission : EMTEK(Ver.RA-03A1)-Shenzhen

## 6 TEST SYSTEM UNCERTAINTY

The following measurement uncertainty levels have been estimated for tests performed on the apparatus:

Parameter	Uncertainty
Radio Frequency	$\pm 1 \times 10^{-5}$
Maximum Peak Output Power Test	$\pm 1.0\text{dB}$
Conducted Emissions Test	$\pm 2.0\text{dB}$
Radiated Emission Test	$\pm 2.0\text{dB}$
Occupied Bandwidth Test	$\pm 1.0\text{dB}$
Band Edge Test	$\pm 3\text{dB}$
All emission, radiated	$\pm 3\text{dB}$
Antenna Port Emission	$\pm 3\text{dB}$
Temperature	$\pm 0.5^\circ\text{C}$
Humidity	$\pm 3\%$

Measurement Uncertainty for a level of Confidence of 95%



## 7 SETUP OF EQUIPMENT UNDER TEST

### 7.1 RADIO FREQUENCY TEST SETUP 1

The Bluetooth with classic mode component's antenna ports(s) of the EUT are connected to the measurement instrument per an appropriate attenuator. The EUT is controlled by PC/software to emit the specified signals for the purpose of measurements.

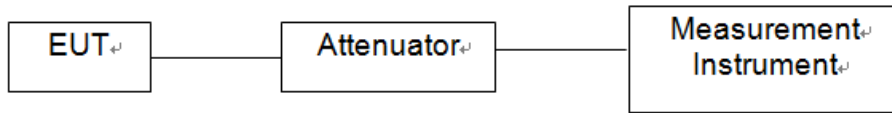

### 7.2 RADIO FREQUENCY TEST SETUP 2

The test site semi-anechoic chamber has met the requirement of NSA tolerance 4 dB according to the standards: ANSI C63.10. The test distance is 3m. The setup is according to the requirements in Section 13.1.4.1 of ANSI C63.10-2013

Below 30MHz:

The EUT is placed on a turntable 0.8meters above the ground in the chamber, 3 meter away from the antenna (loop antenna). The Antenna should be positioned with its plane vertical at the specified distance from the EUT and rotated about its vertical axis for maximum response at each azimuth about the EUT. The center of the loop shall be 1 m above the ground. For certain applications, the loop antenna plane may also need to be positioned horizontally at the specified distance from the EUT.

Above 30MHz:

The EUT is placed on a turntable 0.8meters above the ground in the chamber, 3 meter away from the antenna. The maximal emission value is acquired by adjusting the antenna height, polarisation and turntable azimuth. Normally, the height range of antenna is 1 m to 4 m, the azimuth range of turntable is 0° to 360°, and the receive antenna has two polarizations Vertical (V) and Horizontal (H).

Above 1GHz:

(Note: the FCC's permission to use 1.5m as an alternative per TCBC Conf call of Dec. 2, 2014.)

The EUT is placed on a turntable 1.5 meters above the ground in the chamber, 3 meter away from the antenna. The maximal emission value is acquired by adjusting the antenna height, polarisation and turntable azimuth. Normally, the height range of antenna is 1 m to 4 m, the azimuth range of turntable is 0° to 360°, and the receive antenna has two polarizations Vertical (V) and Horizontal (H).

(a) Radiated Emission Test Set-Up, Frequency Below 30MHz

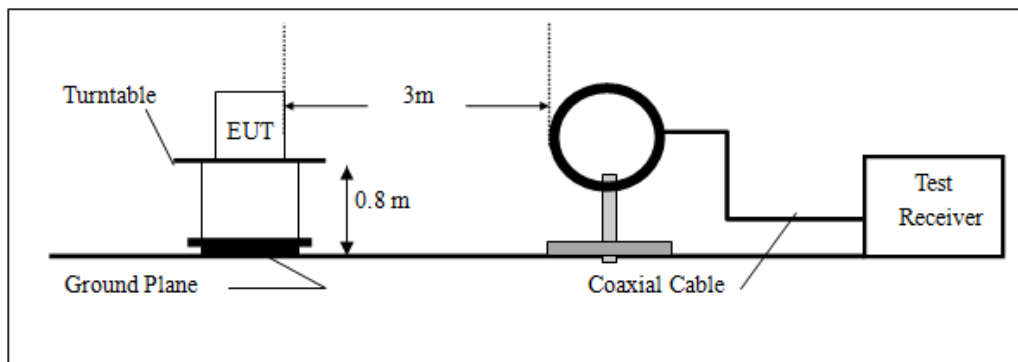

(b) Radiated Emission Test Set-Up, Frequency Below 1000MHz

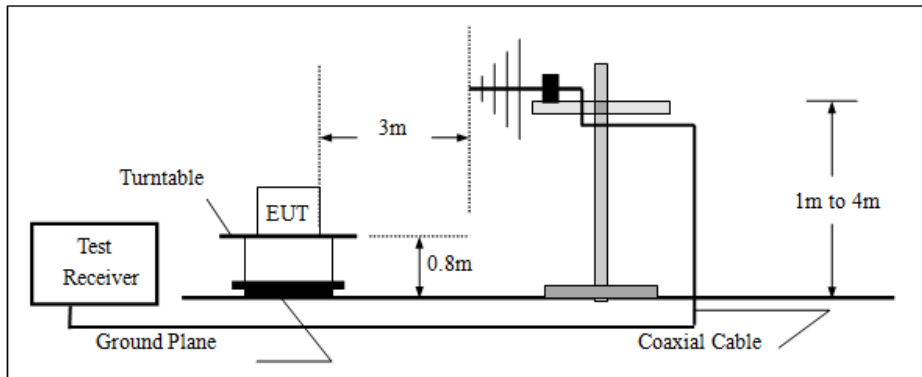

(c) Radiated Emission Test Set-Up, Frequency above 1000MHz

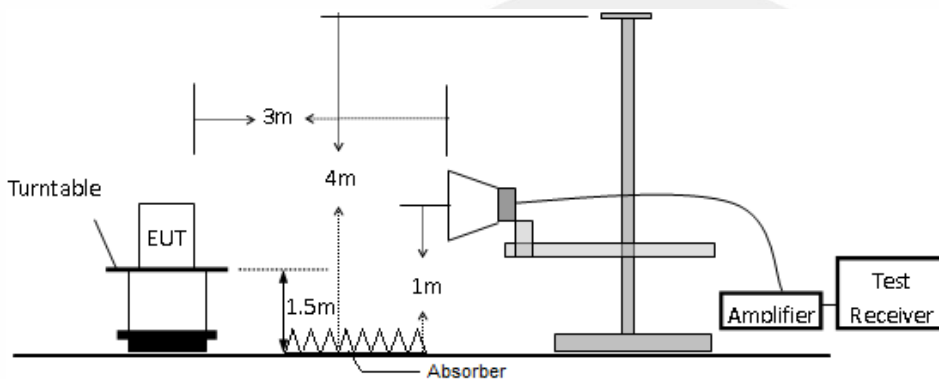

### 7.3 CONDUCTED EMISSION TEST SETUP

The mains cable of the EUT (Perfect Share Mini) must be connected to LISN. The LISN shall be placed 0.8m from the boundary of EUT and bonded to a ground reference plane for LISN mounted on top of the ground reference plane. This distance is between the closest points of the LISN and the EUT. All other units of the EUT and associated equipment shall be at least 0.8m from the LISN.

Ground connections, where required for safety purposes, shall be connected to the reference ground point of the LISN and, where not otherwise provided or specified by the manufacturer, shall be of same length as the mains cable and run parallel to the mains connection at a separation distance of not more than 0.8m.

According to the requirements in Section 13.1.4.1 of ANSI C63.10-2013 Conducted emissions from the EUT measured in the frequency range between 0.15 MHz and 30 MHz using CISPR Quasi-Peak and average detector mode.

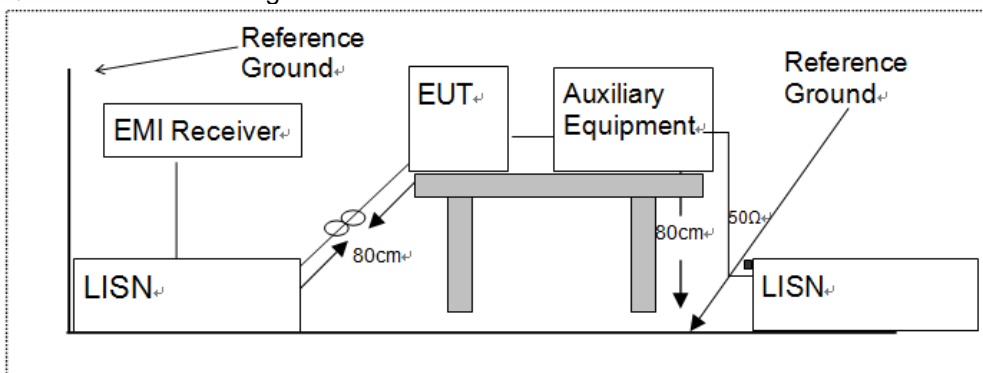

#### 7.4 BLOCK DIAGRAM CONFIGURATION OF TEST SYSTEM

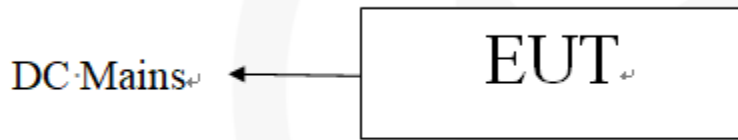

#### 7.5 SUPPORT EQUIPMENT

Description	Manufacturer	Model	Note
/	/	/	/

**Notes:**

1. All the equipment/cables were placed in the worst-case configuration to maximize the emission during the test.
2. Grounding was established in accordance with the manufacturer's requirements and conditions for the intended use.

## 8 FREQUENCY HOPPING SYSTEM REQUIREMENTS

### 8.1 Standard Applicable

According to FCC Part 15.247(a)(1), The system shall hop to channel frequencies that are selected at the system hopping rate from a pseudo randomly ordered list of hopping frequencies. Each frequency must be used equally on the average by each transmitter. The system receivers shall have input bandwidths that match the hopping channel bandwidths of their corresponding transmitters and shall shift frequencies in synchronization with the transmitted signals.

(g) Frequency hopping spread spectrum systems are not required to employ all available hopping channels during each transmission. However, the system, consisting of both the transmitter and the receiver, must be designed to comply with all of the regulations in this section should the transmitter be presented with a continuous data (or information) stream. In addition, a system employing short transmission bursts must comply with the definition of a frequency hopping system and must distribute its transmissions over the minimum number of hopping channels specified in this section.

(h) The incorporation of intelligence within a frequency hopping spread spectrum system that permits the system to recognize other users within the spectrum band so that it individually and independently chooses and adapts its hopsets to avoid hopping on occupied channels is permitted. The coordination of frequency hopping systems in any other manner for the express purpose of avoiding the simultaneous occupancy of individual hopping frequencies by multiple transmitters is not permitted.

### 8.2 EUT Pseudorandom Frequency Hopping Sequence

The channel is represented by a pseudo-random hopping sequence hopping through the 79 RF channels. The hopping sequence is unique for the piconet and is determined by the Bluetooth device address of the master; the phase in the hopping sequence is determined by the Bluetooth clock of the master. The channel is divide into time slots where each slot corresponds to an RF hop frequency. Consecutive hops correspond to different RF hop frequencies. The normal hop is 1 600 hops/s.

The pseudorandom sequence may be generated in a nine-stage shift register whose 5th and 9th stage outputs are added in a modulo-two addition stage, and the result is fed back to the input of the first stage. The sequence begins with the first ONE of 9 consecutive ONES; i.e. the shift register is initialized with nine ones.

Number of shift register stages: 9  
 Length of pseudo-random sequence:  $2^9 - 1 = 511$  bits  
 Longest sequence of zeros: 8 (non-inverted signal)

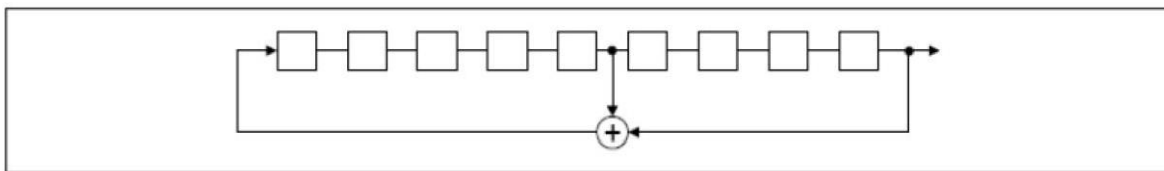

*Linear Feedback Shift Register for Generation of the PRBS sequence*

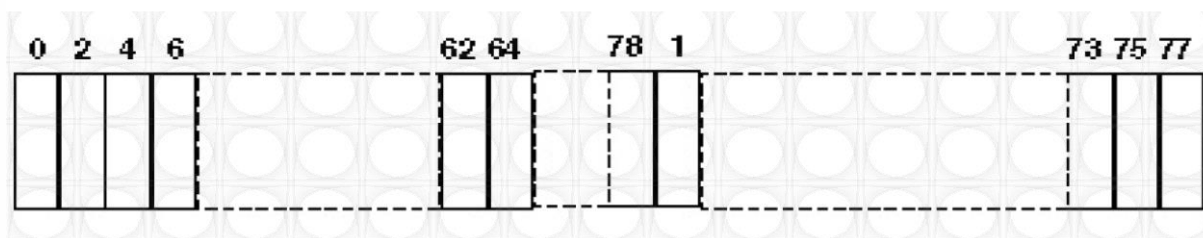

Each frequency used equally on the average by each transmitter.

The system receiver have input bandwidths that match the hopping channel bandwidths of their corresponding transmitters and shift frequencies in synchronization with the transmitted signals.

### 8.3 Equal Hopping Frequency Use

All Bluetooth units participating in the piconet are time and hop-synchronized to the channel.

Example of a 79 hopping sequence in data mode:

35, 27, 6, 44, 14, 61, 74, 32, 1, 11, 23, 2, 55, 65, 29, 3, 9, 52, 78, 58, 40, 25, 0, 7, 18, 26, 76, 60, 47, 50, 2, 5, 16, 37, 70, 63, 66, 54, 20, 13, 4, 8, 15, 21, 26, 10, 73, 77, 67, 69, 43, 24, 57, 39, 46, 72, 48, 33, 17, 31, 75, 19, 41, 62, 68, 28, 51, 66, 30, 56, 34, 59, 71, 22, 49, 64, 38, 45, 36, 42, 53

Each Frequency used equally on the average by each transmitter

### 8.4 Frequency Hopping System

This transmitter device is frequency hopping device, and complies with FCC part 15.247 rule.

This device uses Bluetooth radio which operates in 2400-2483.5 MHz band. Bluetooth uses a radio technology called frequency-hopping spread spectrum, which chops up the data being sent and transmits chunks of it on up to 79 bands (1 MHz each; centred from 2402 to 2480 MHz) in the range 2,400-2,483.5 MHz. The transmitter switches hop frequencies 1,600 times per second to assure a high degree of data security. All Bluetooth devices participating in a given piconet are synchronized to the frequency-hopping channel for the piconet. The frequency hopping sequence is determined by the master's device address and the phase of the hopping sequence (the frequency to hop at a specific time) is determined by the master's internal clock. Therefore, all slaves in a piconet must know the master's device address and must synchronize their clocks with the master's clock.

Adaptive Frequency Hopping (AFH) was introduced in the Bluetooth specification to provide an effective way for a Bluetooth radio to counteract normal interference. AFH identifies "bad" channels, where either other wireless devices are interfering with the Bluetooth signal or the Bluetooth signal is interfering with another device. The AFH-enabled Bluetooth device will then communicate with other devices within its piconet to share details of any identified bad channels. The devices will then switch to alternative available "good" channels, away from the areas of interference, thus having no impact on the bandwidth used.



## 9 TEST REQUIREMENTS

### 9.1 20DB BANDWIDTH

#### 9.1.1 Applicable Standard

According to FCC Part 15.247(a)(1) and KDB 558074 D01 MEAS GUIDANCE V05r02

#### 9.1.2 Conformance Limit

No limit requirement.

#### 9.1.3 Test Configuration

Test according to clause 7.1 radio frequency test setup 1

#### 9.1.4 Test Procedure

The EUT was operating in Bluetooth with classic mode mode and controlled its channel. Printed out the test result from the spectrum by hard copy function.

The RF output of EUT was connected to the spectrum analyzer by RF cable and attenuator. The path loss was compensated to the results for each measurement.

Set to the maximum power setting and enable the EUT transmit continuously

Set RBW = 30 kHz.

Set the video bandwidth (VBW) =100 kHz.

Set Span= approximately 2 to 3 times the 20 dB bandwidth

Set Detector = Peak.

Set Trace mode = max hold.

Set Sweep = auto couple.

The EUT should be transmitting at its maximum data rate. Allow the trace to stabilize. Use the marker-to-peak function to set the marker to the peak of the emission. Use the marker-delta function to measure 20 dB down one side of the emission. Reset the markerdelta function, and move the marker to the other side of the emission, until it is (as close as possible to) even with the reference marker level. The marker-delta reading at this point is the 20 dB bandwidth of the emission.

If this value varies with different modes of operation (e.g., data rate, modulation format, etc.), repeat this test for each variation.

Measure and record the results in the test report.

#### Test Results

Temperature:	26° C
Relative Humidity:	54%
ATM Pressure:	1011 mbar

Modulation Mode	Channel Number	Channel Frequency (MHz)	Measurement Bandwidth (kHz)	Limit (kHz)	Verdict
GFSK	0	2402	937.8	N/A	PASS
	39	2441	942.1	N/A	PASS
	78	2480	942.1	N/A	PASS
pi/4-DQPSK	0	2402	1224.3	N/A	PASS
	39	2441	1224.3	N/A	PASS
	78	2480	1224.3	N/A	PASS
8DPSK	0	2402	1224.3	N/A	PASS
	39	2441	1220.0	N/A	PASS
	78	2480	1220.0	N/A	PASS

Note: N/A (Not Applicable)

**Test Model**      20dB Bandwidth  
 Bluetooth with classic mode  
 Channel 0: 2402MHz      GFSK Modulation

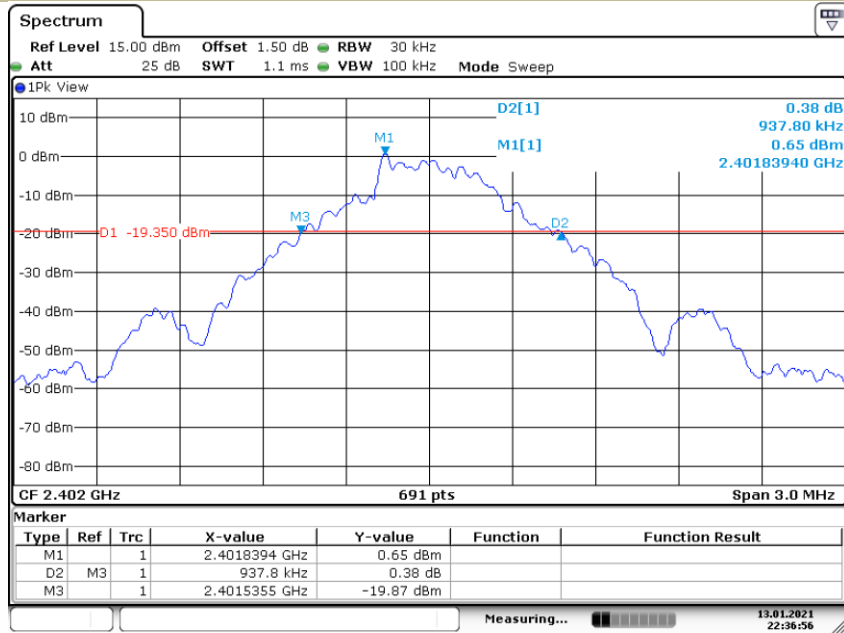

Date: 13.JAN.2021 22:36:56

**Test Model**      20dB Bandwidth  
 Bluetooth with classic mode  
 Channel 39: 2441MHz      GFSK Modulation

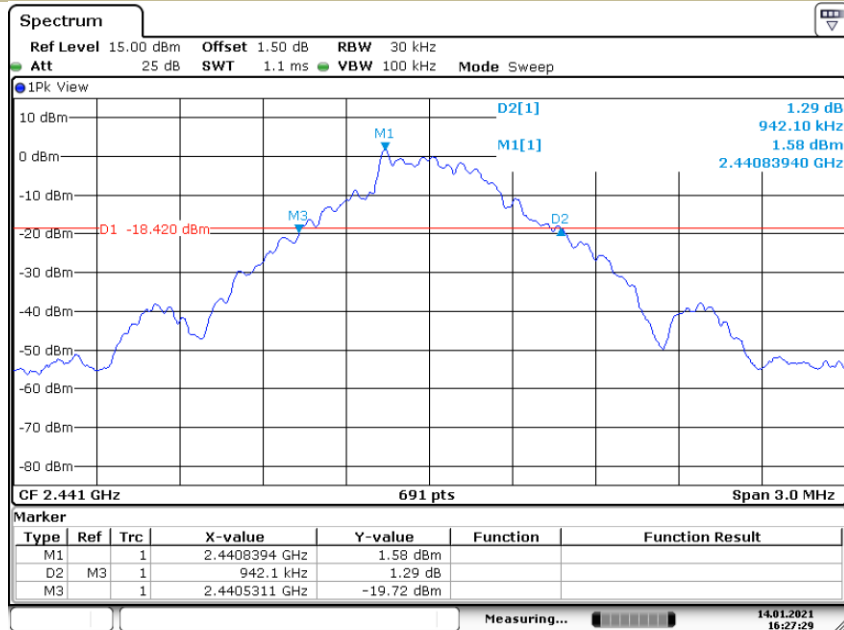

Date: 14.JAN.2021 16:27:29

Test Model      20dB Bandwidth  
 Bluetooth with classic mode  
 Channel 78: 2480MHz      GFSK Modulation

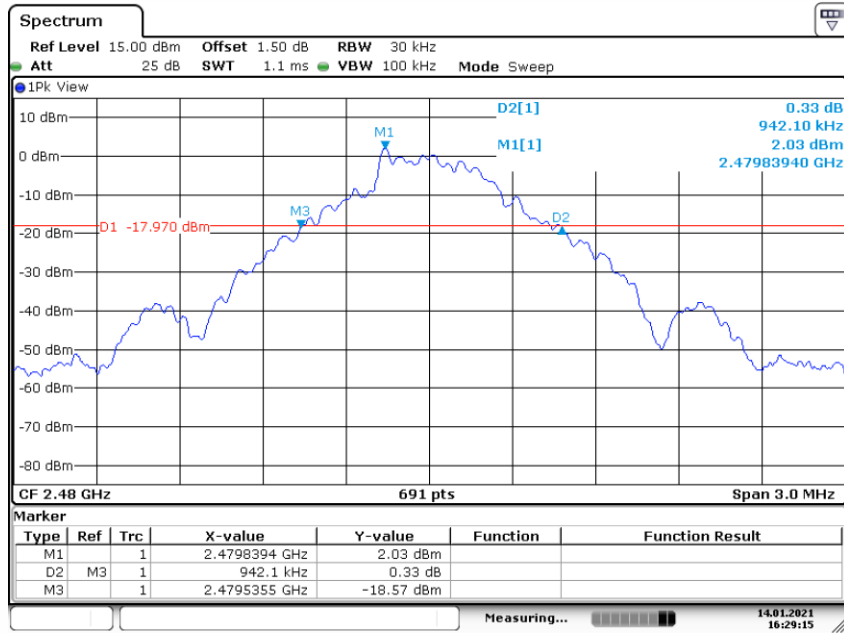

Date: 14. JAN 2021 16:29:15

Test Model      20dB Bandwidth  
 Bluetooth with classic mode  
 Channel 0: 2402MHz      pi/4-DQPSK Modulation

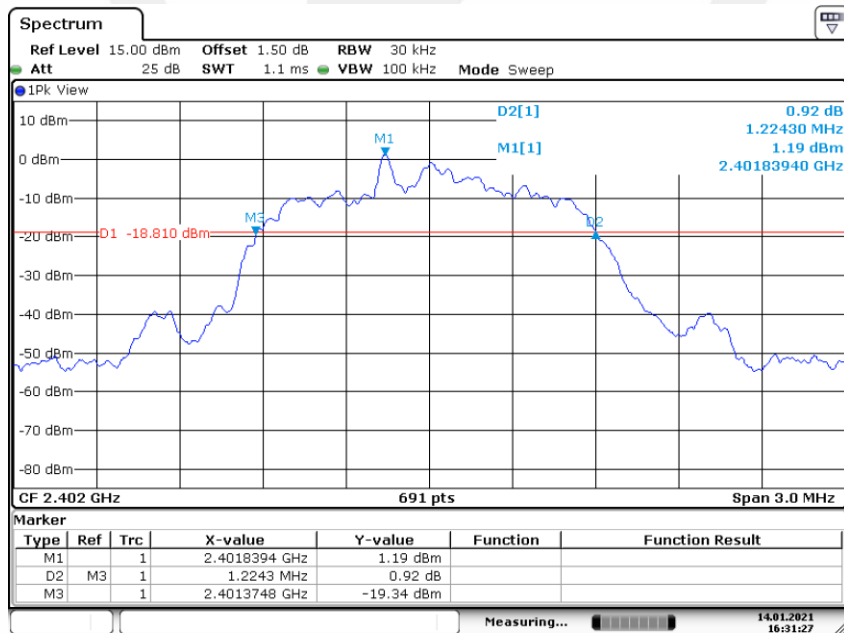

Date: 14. JAN 2021 16:31:27

Test Model      20dB Bandwidth  
 Bluetooth with classic mode  
 Channel 39: 2441MHz      pi/4-DQPSK Modulation

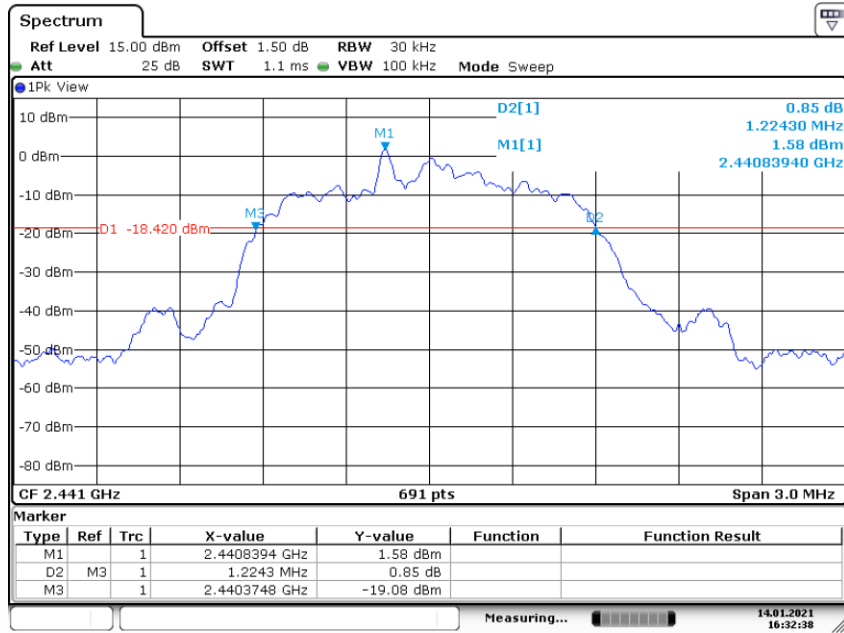

Date: 14.JAN.2021 16:32:38

Test Model      20dB Bandwidth  
 Bluetooth with classic mode  
 Channel 78: 2480MHz      pi/4-DQPSK Modulation

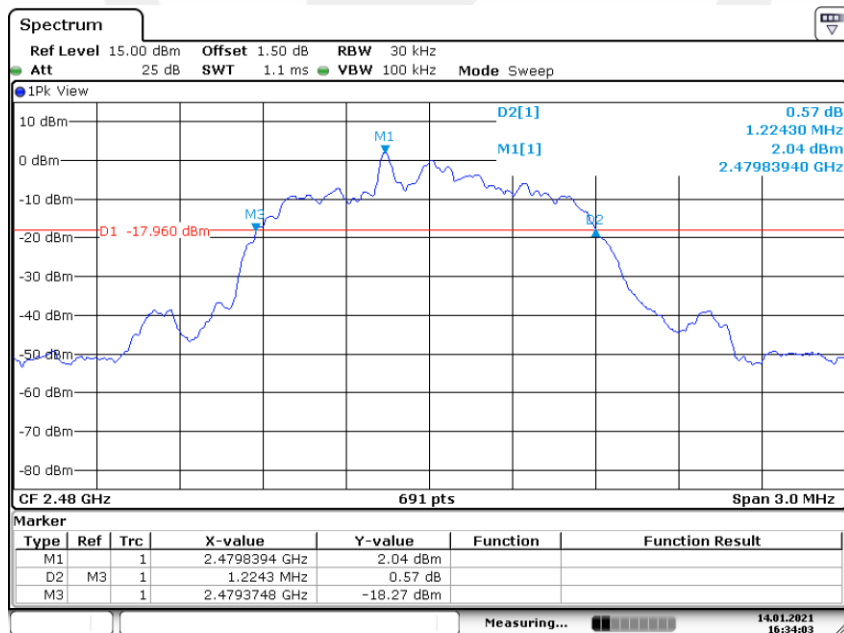

Date: 14.JAN.2021 16:34:04

Test Model      20dB Bandwidth  
 Bluetooth with classic mode  
 Channel 0: 2402MHz      8DPSK Modulation

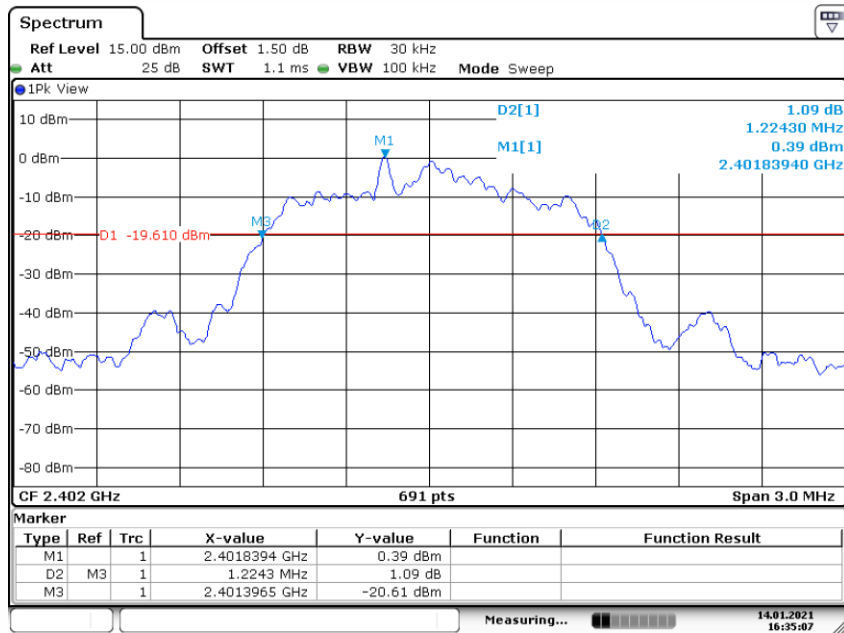

Date: 14. JAN 2021 16:35:07

Test Model      20dB Bandwidth  
 Bluetooth with classic mode  
 Channel 39: 2441MHz      8DPSK Modulation

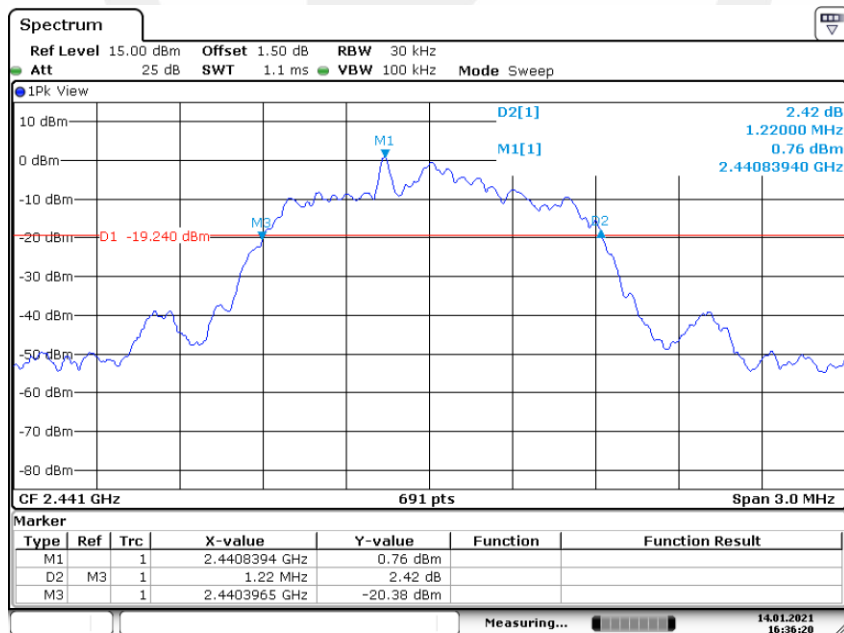

Date: 14. JAN 2021 16:36:20

Test Model      20dB Bandwidth  
 Bluetooth with classic mode  
 Channel 78: 2480MHz      8DPSK Modulation

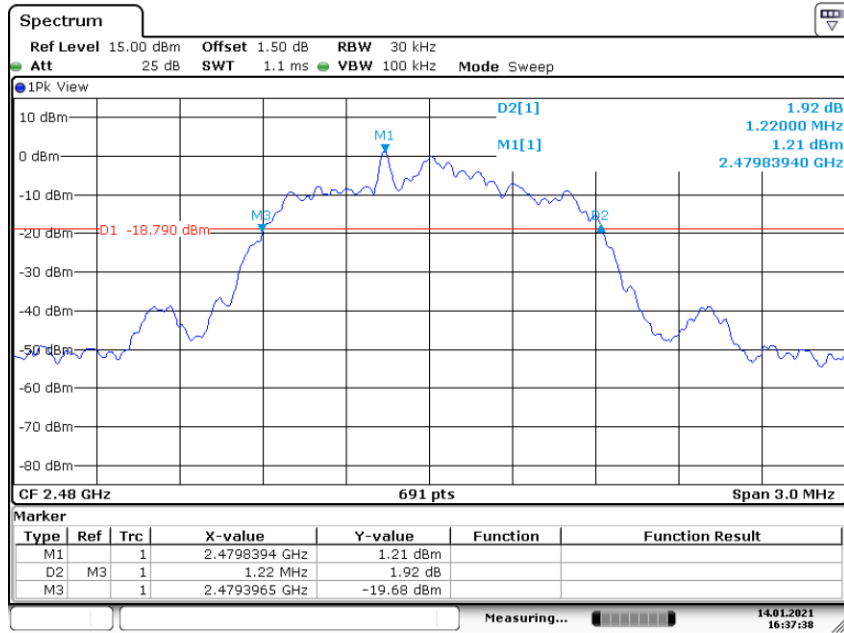

Date: 14. JAN 2021 16:37:38

## 9.2 CARRIER FREQUENCY SEPARATION

### 9.2.1 Applicable Standard

According to FCC Part 15.247(a)(1) and KDB 558074 D01 MEAS GUIDANCE V05r02

### 9.2.2 Conformance Limit

Frequency hopping systems operating in the 2400-2483.5MHz band shall have hopping channel carrier frequencies separated by a minimum of 25kHz or the 20dB bandwidth of the hopping channel, whichever is greater.

In case of an output power less than 125mW, the frequency hopping system may have channels separated by a minimum of 25kHz or two-thirds of the 20dB bandwidth of the hopping channel, whichever is greater.

### 9.2.3 Test Configuration

Test according to clause 7.1 radio frequency test setup 1

### 9.2.4 Test Procedure

■ According to FCC Part15.247(a)(1)

The EUT must have its hopping function enabled. Use the following spectrum analyzer settings:

Set the RBW =100kHz. Set VBW =300kHz.

Set the span = wide enough to capture the peaks of two adjacent channels

Set Sweep time = auto couple.

Set Detector = peak. Set Trace mode = max hold.

Allow the trace to stabilize. Use the marker-delta function to determine the separation between the peaks of the adjacent channels. The limit is specified in one of the subparagraphs of this Section. Submit this plot.

### Test Results

Temperature:	26° C
Relative Humidity:	54%
ATM Pressure:	1011 mbar

Modulation Mode	Channel Number	Channel Frequency (MHz)	Measurement Bandwidth (kHz)	Limit (kHz)	Verdict
GFSK	0	2402	994.2	>625.2	PASS
	39	2441	1002.9	>628.07	PASS
	78	2480	998.6	>628.07	PASS
$\pi/4$ -DQPSK	0	2402	998.6	>816.2	PASS
	39	2441	998.6	>816.2	PASS
	78	2480	994.2	>816.2	PASS
8DPSK	0	2402	998.6	>816.2	PASS
	39	2441	998.6	>813.3	PASS
	78	2480	1002.9	>813.3	PASS

Note: Limit = 20dB bandwidth\*2/3 for GFSK,  $\pi/4$ -DQPSK, 8DPSK modulation, if it is greater than 25kHz and the output power is less than 125mW (21dBm).

**Test Model** Carrier Frequency Separation  
Bluetooth with classic mode  
Channel 0: 2402MHz GFSK Modulation

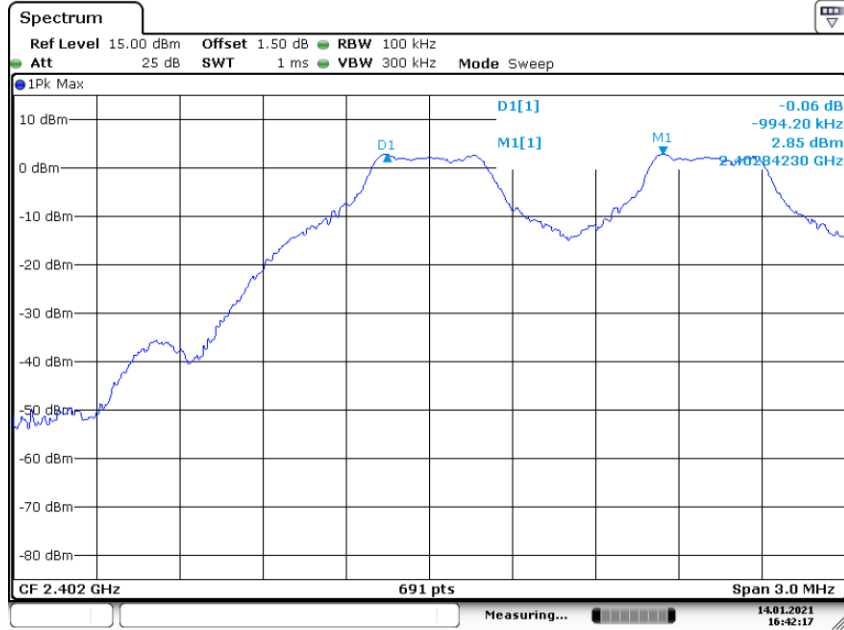

Date: 14. JAN 2021 16:42:17

**Test Model** Carrier Frequency Separation  
Bluetooth with classic mode  
Channel 39: 2441MHz GFSK Modulation

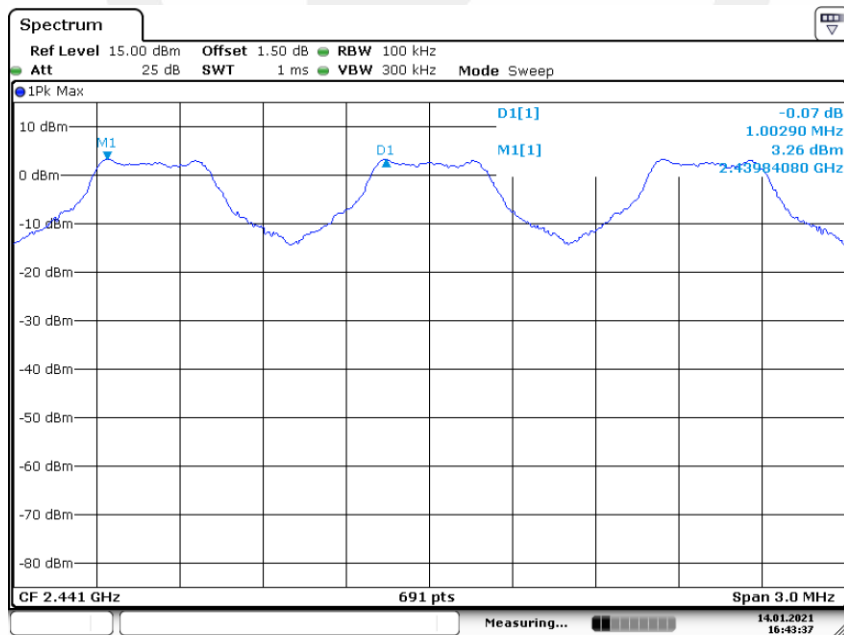

Date: 14. JAN 2021 16:43:37



**Test Model**      **Carrier Frequency Separation**  
**Bluetooth with classic mode**  
**Channel 78: 2480MHz**                      **GFSK Modulation**

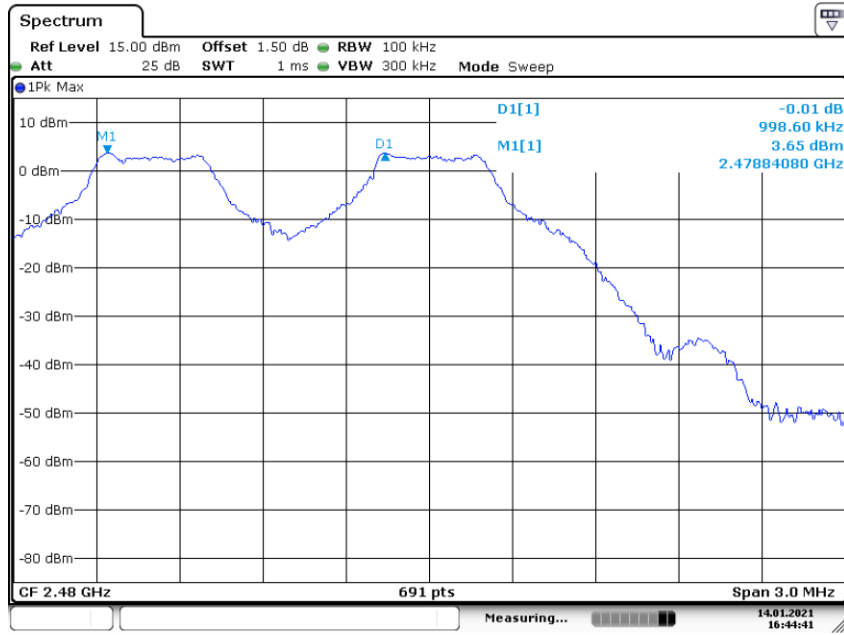

Date: 14. JAN 2021 16:44:41

**Test Model**      **Carrier Frequency Separation**  
**Bluetooth with classic mode**  
**Channel 0: 2402MHz**                      **pi/4-DQPSK Modulation**

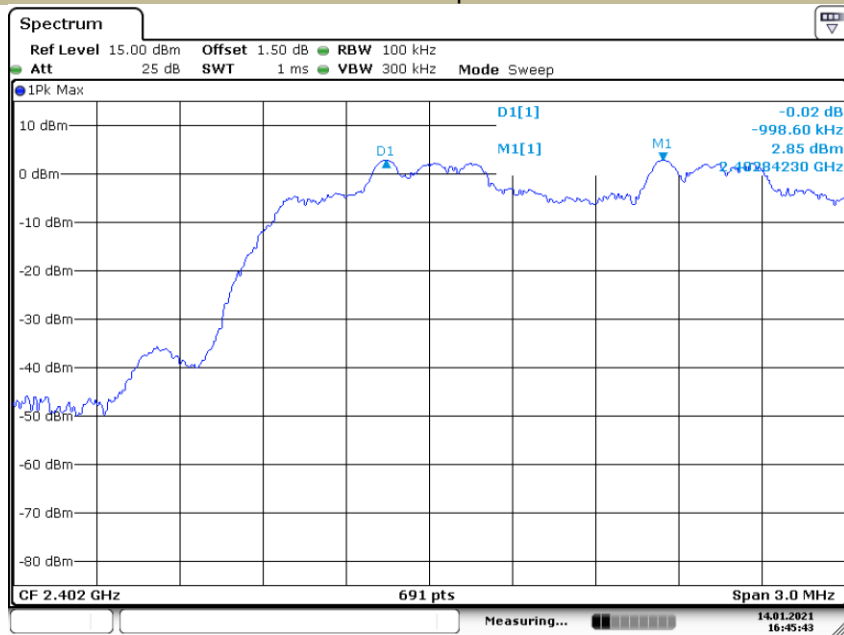

Date: 14. JAN 2021 16:45:43

Test Model Carrier Frequency Separation  
 Bluetooth with classic mode  
 Channel 39: 2441MHz pi/4-DQPSK Modulation

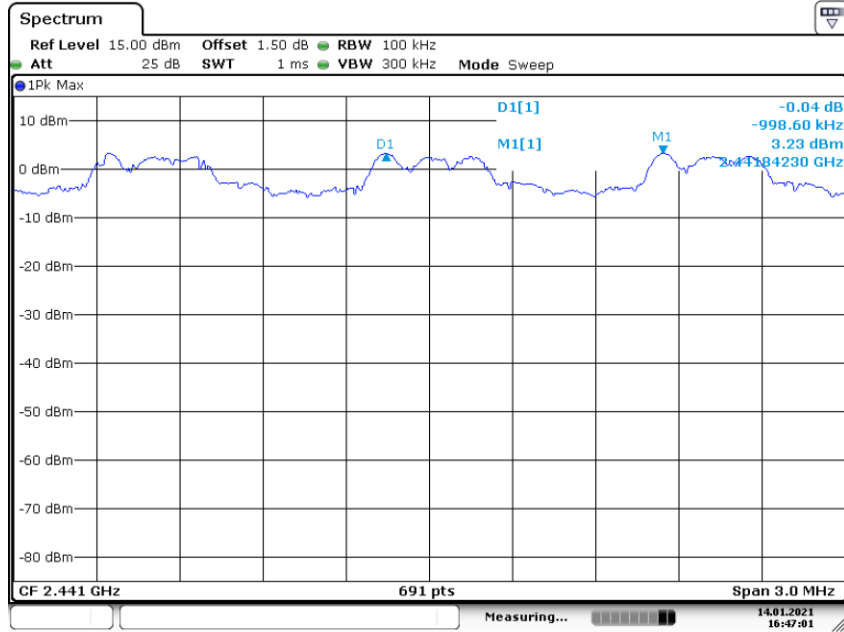

Date: 14. JAN.2021 16:47:01

Test Model Carrier Frequency Separation  
 Bluetooth with classic mode  
 Channel 78: 2480MHz pi/4-DQPSK Modulation

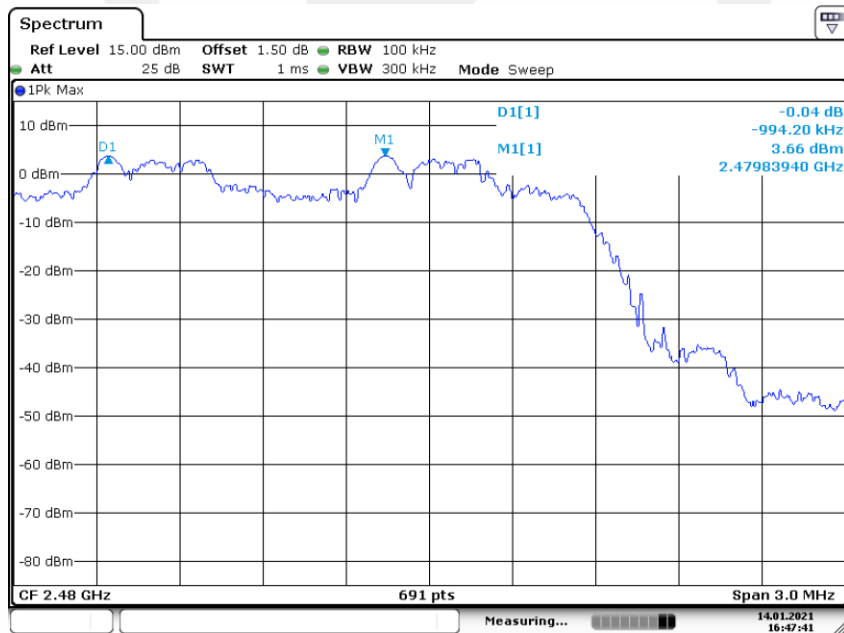

Date: 14. JAN.2021 16:47:41

**Test Model** Carrier Frequency Separation  
Bluetooth with classic mode  
Channel 0: 2402MHz 8DPSK Modulation

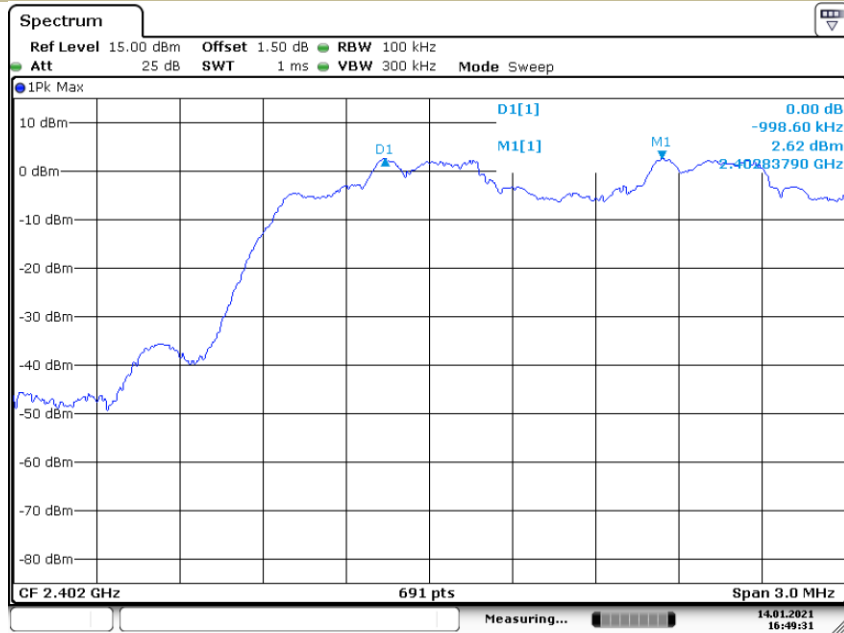

Date: 14. JAN 2021 16:49:31

**Test Model** Carrier Frequency Separation  
Bluetooth with classic mode  
Channel 39: 2441MHz 8DPSK Modulation

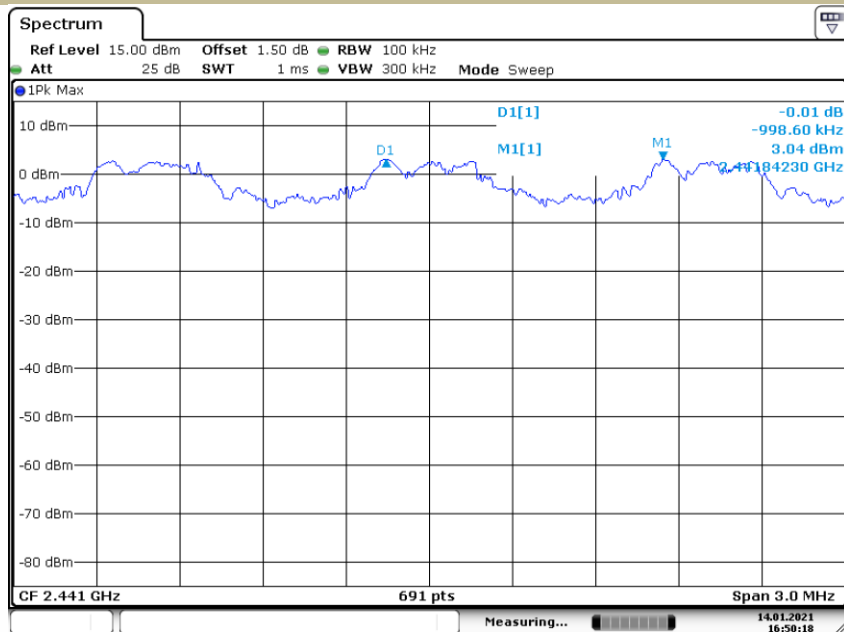

Date: 14. JAN 2021 16:50:18

Test Model Carrier Frequency Separation  
 Bluetooth with classic mode  
 Channel 78: 2480MHz 8DPSK Modulation

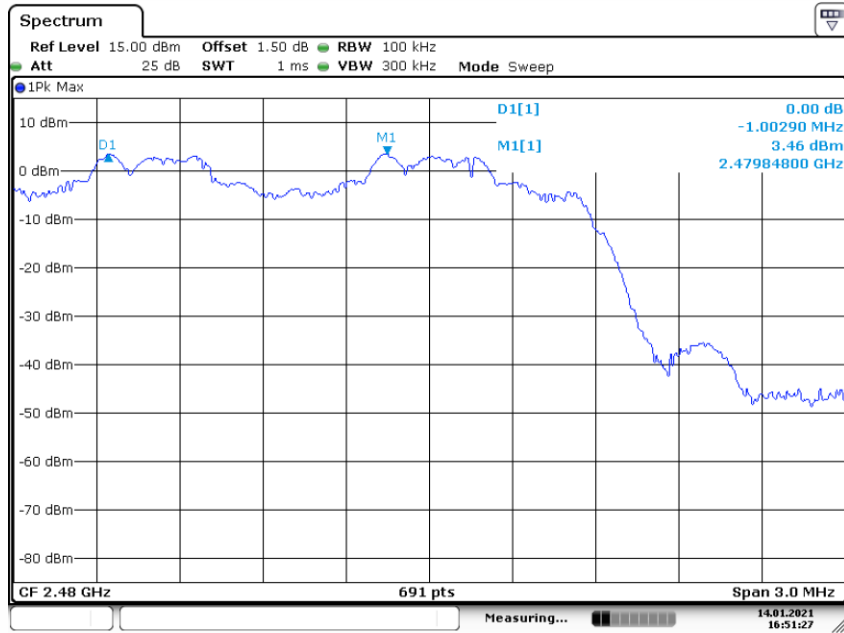

Date: 14. JAN 2021 16:51:27



### 9.3 NUMBER OF HOPPING FREQUENCIES

#### 9.3.1 Applicable Standard

According to FCC Part 15.247(a)(1) (iii) and KDB 558074 D01 MEAS GUIDANCE V05r02

#### 9.3.2 Conformance Limit

Frequency hopping systems operating in the 2400-2483.5MHz band shall use at least 15 channels.

#### 9.3.3 Test Configuration

Test according to clause 7.1 radio frequency test setup 1

#### 9.3.4 Test Procedure

- According to FCC Part 15.247(a)(1)(iii)

The EUT must have its hopping function enabled. Use the following spectrum analyzer settings:

Span = the frequency band of operation (2400-2483.5MHz)

RBW  $\geq$  100KHz

VBW  $\geq$  RBW

Sweep = auto

Detector function = peak

Trace = max hold

Allow the trace to stabilize. It may prove necessary to break the span up to sections, in order to clearly show all of the hopping frequencies.

#### Test Results

Temperature:	26° C
Relative Humidity:	54%
ATM Pressure:	1011 mbar

Modulation Mode	Hopping Channel Frequency Range	Quantity of Hopping Channel	Quantity of Hopping Channel limit
GFSK	2402-2480	79	> 15
pi/4-DQPSK	2402-2480	79	> 15
8DPSK	2402-2480	79	> 15

Test Model      Number Of Hopping Frequencies  
 Bluetooth with classic mode  
 Span: 2400-2483.5MHz

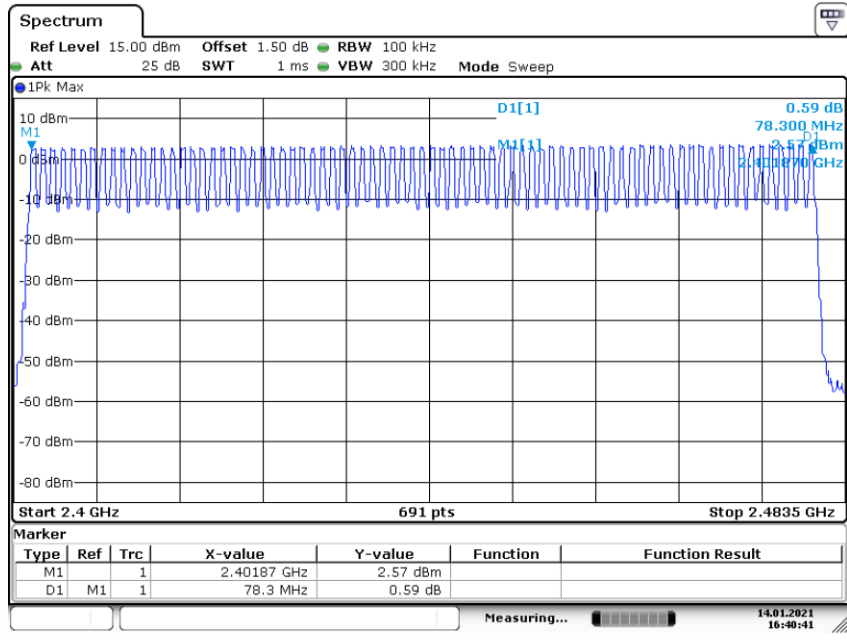

Date: 14. JAN 2021 16:40:41



## 9.4 AVERAGE TIME OF OCCUPANCY (DWELL TIME)

### 9.4.1 Applicable Standard

According to FCC Part 15.247(a)(1)(iii) and KDB 558074 D01 MEAS GUIDANCE V05r02

### 9.4.2 Conformance Limit

For frequency hopping systems operating in the 2400-2483.5MHz band, the average time of occupancy on any channel shall not be greater than 0.4s within a period of 0.4s multiplied by the number of hopping channels employed.

### 9.4.3 Test Configuration

Test according to clause 7.1 radio frequency test setup 1

### 9.4.4 Test Procedure

- According to FCC Part 15.247(a)(1)(iii)

The EUT must have its hopping function enabled. Use the following spectrum analyzer settings:

Span = zero span, centered on a hopping channel

RBW = 1 MHz

VBW ≥ RBW

Sweep = as necessary to capture the entire dwell time per hopping channel

Detector function = peak

Trace = max hold

If possible, use the marker-delta function to determine the dwell time. If this value varies with different modes of operation (e.g., data rate, modulation format, etc.), repeat this test for each variation. The limit is specified in one of the subparagraphs of this Section.

### 9.4.5 Test Results

Temperature:	26° C
Relative Humidity:	54%
ATM Pressure:	1011 mbar

Bluetooth (GFSK, pi/4-DQPSK, 8DPSK) mode have been tested, and the worst result(GFSK) was report as below:

Modulation Mode	Channel Number	Packet type	Pluse width (ms)	Dwell Time (ms)	Limit (ms)	Verdict
GFSK	0	DH1	0.371	118.72	<400	PASS
	0	DH3	1.6232	259.712	<400	PASS
	0	DH5	2.8696	306.091	<400	PASS
Note: Dwell Time(DH1)=PW*(1600/2/79)*31.6 Dwell Time(DH3)=PW*(1600/4/79)*31.6 Dwell Time(DH5)=PW*(1600/6/79)*31.6						

Test Model Average Time Of Occupancy (Dwell Time)  
Bluetooth with classic mode  
CH 0: 2402MHz GFSK DH1

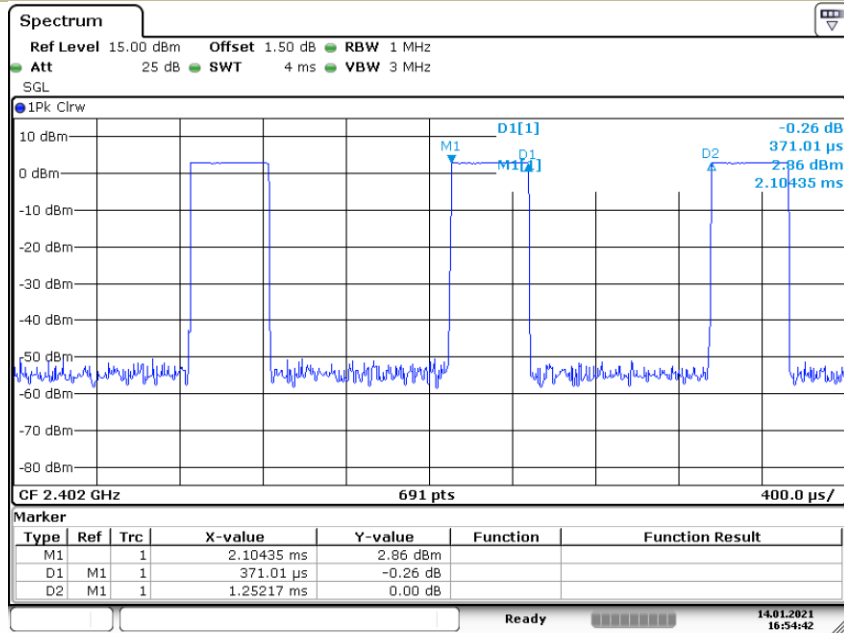

Date: 14.JAN.2021 16:54:43

Test Model Average Time Of Occupancy (Dwell Time)  
Bluetooth with classic mode  
CH 0: 2402MHz GFSK DH3

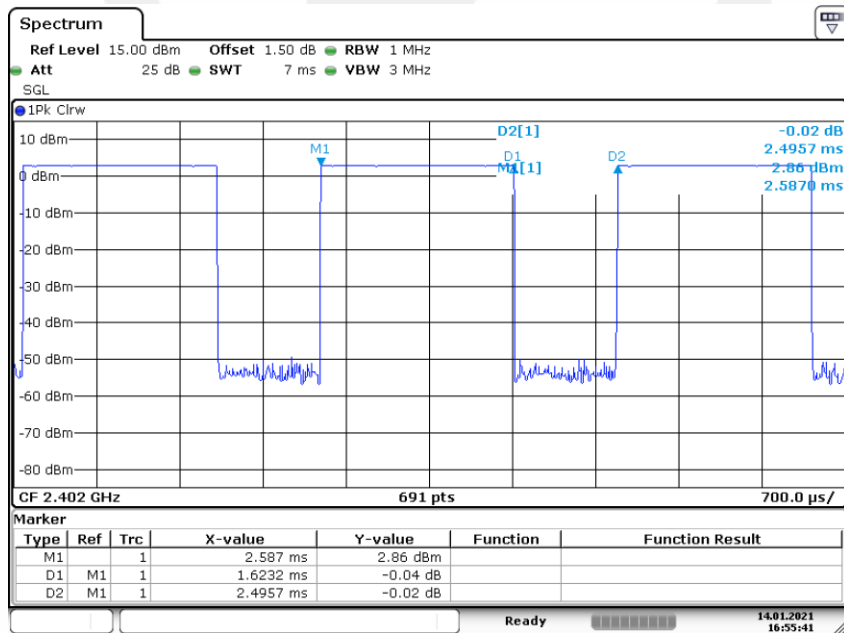

Date: 14.JAN.2021 16:55:41



Test Model Average Time Of Occupancy (Dwell Time)  
 Bluetooth with classic mode  
 CH 0: 2402MHz GFSK DH5

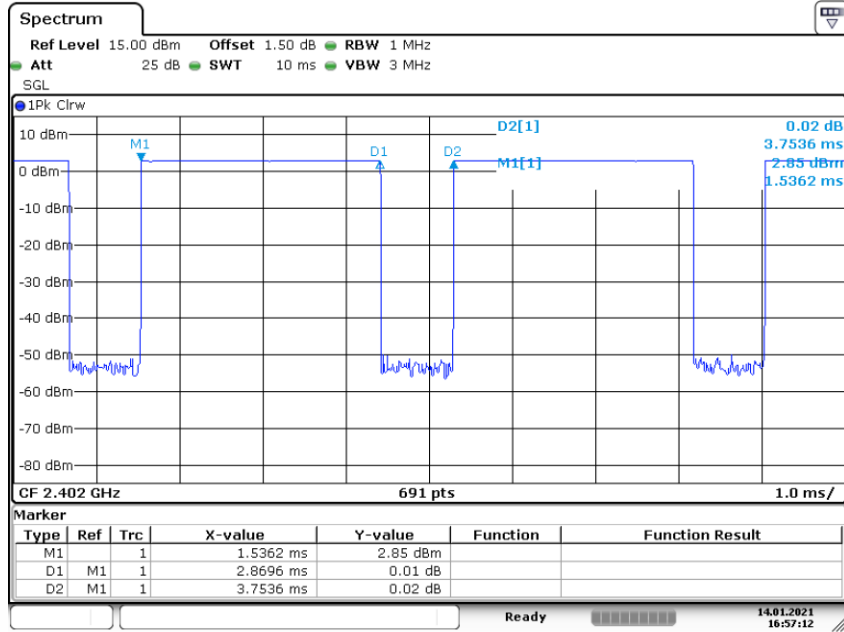

Date: 14.JAN.2021 16:57:11

## 9.5 MAXIMUM PEAK CONDUCTED OUTPUT POWER

### 9.5.1 Applicable Standard

According to FCC Part 15.247(b)(1) and KDB 558074 D01 MEAS GUIDANCE V05r02

### 9.5.2 Conformance Limit

The max For frequency hopping systems operating in the 2400-2483.5 MHz band employing at least 75 non-overlapping hopping channels: 1 watt. For all other frequency hopping systems in the 2400-2483.5 MHz band: 0.125 watts.

### 9.5.3 Test Configuration

Test according to clause 7.1 radio frequency test setup 1

### 9.5.4 Test Procedure

■ According to FCC Part15.247(b)(1)

As an alternative to a peak power measurement, compliance with the limit can be based on a measurement of the maximum conducted output power.

Use the following spectrum analyzer settings:

Set Span = approximately 5 times the 20 dB bandwidth, centered on a hopping channel (about 10MHz)

Set RBW > the 20 dB bandwidth of the emission being measured (about 3MHz)

Set VBW ≥ RBW

Set Sweep = auto

Set Detector function = peak

Set Trace = max hold

Allow the trace to stabilize. Use the marker-to-peak function to set the marker to the peak of the emission to determine the peak amplitude level.

### Test Results

Temperature:	26° C
Relative Humidity:	54%
ATM Pressure:	1011 mbar

Operation Mode	Channel Number	Channel Frequency (MHz)	Measurement Level (dBm)	Limit (dBm)	Verdict
GFSK	0	2402	2.73	30	PASS
	39	2441	3.12	30	PASS
	78	2480	3.58	30	PASS
pi/4-DQPSK	0	2402	2.72	30	PASS
	39	2441	3.09	30	PASS
	78	2480	3.55	30	PASS
8DPSK	0	2402	2.91	30	PASS
	39	2441	3.28	30	PASS
	78	2480	3.74	30	PASS
Note: N/A					

**Test Model** Maximum Peak Conducted Output Power  
Bluetooth with classic mode  
Channel 0: 2402MHz GFSK

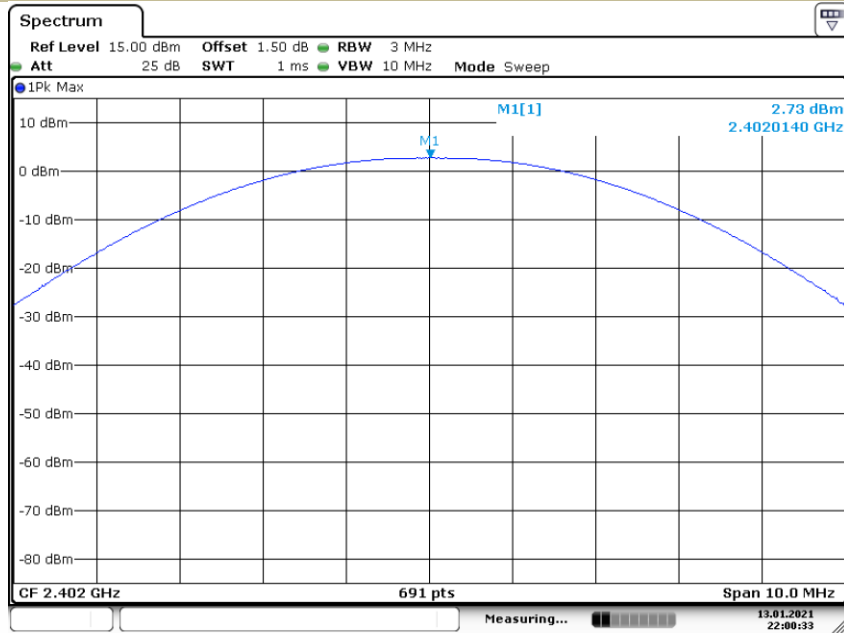

Date: 13. JAN 2021 22:00:33

**Test Model** Maximum Peak Conducted Output Power  
Bluetooth with classic mode  
Channel 39: 2441MHz GFSK

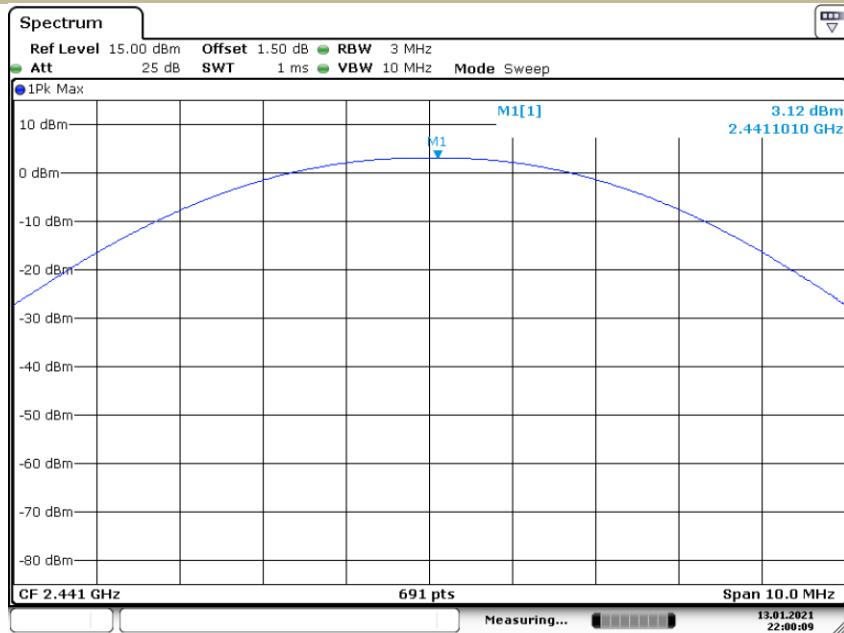

Date: 13. JAN 2021 22:00:08

**Test Model** Maximum Peak Conducted Output Power  
Bluetooth with classic mode  
Channel 78: 2480MHz GFSK

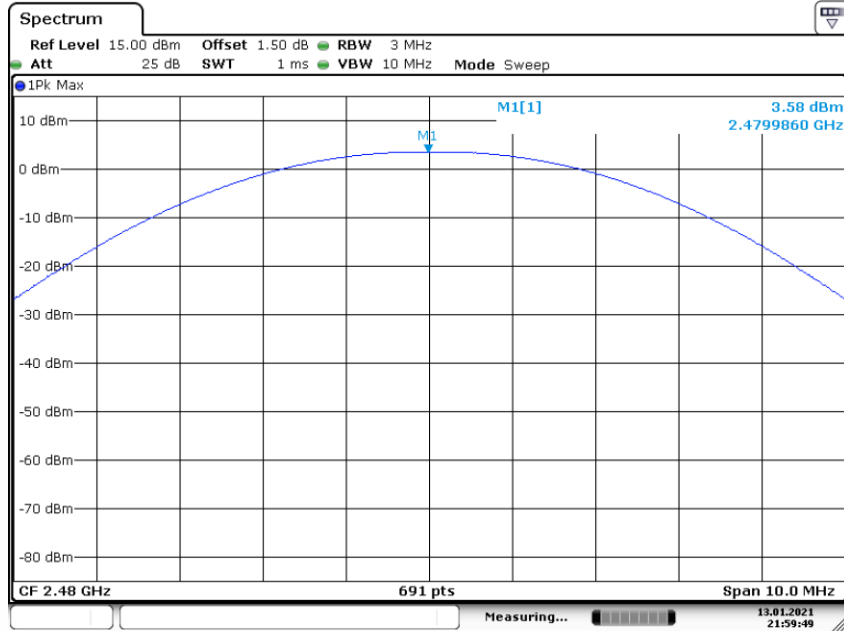

Date: 13. JAN 2021 21:59:49

**Test Model** Maximum Peak Conducted Output Power  
Bluetooth with classic mode  
Channel 0: 2402MHz pi/4-DQPSK

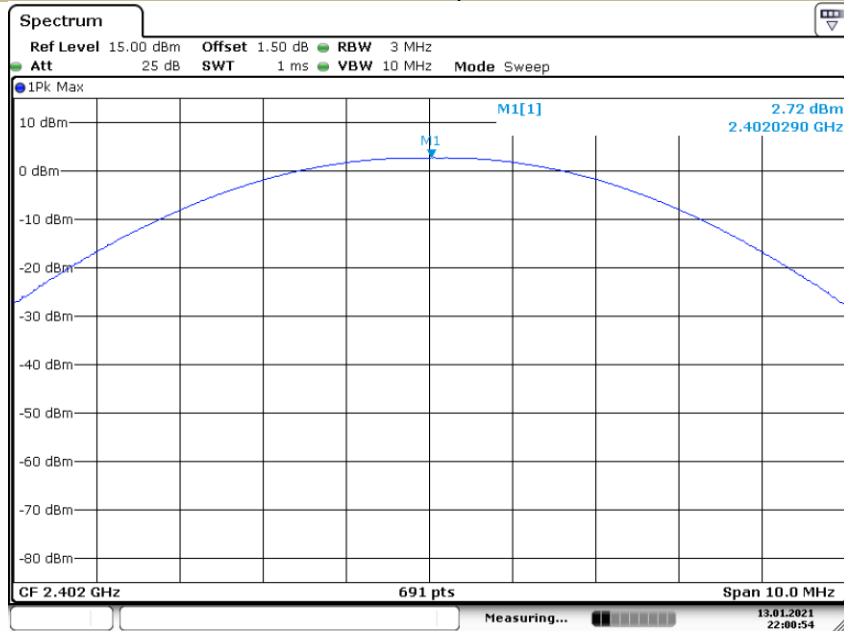

Date: 13. JAN 2021 22:00:54

**Test Model** Maximum Peak Conducted Output Power  
 Bluetooth with classic mode  
 Channel 39: 2441MHz pi/4-DQPSK

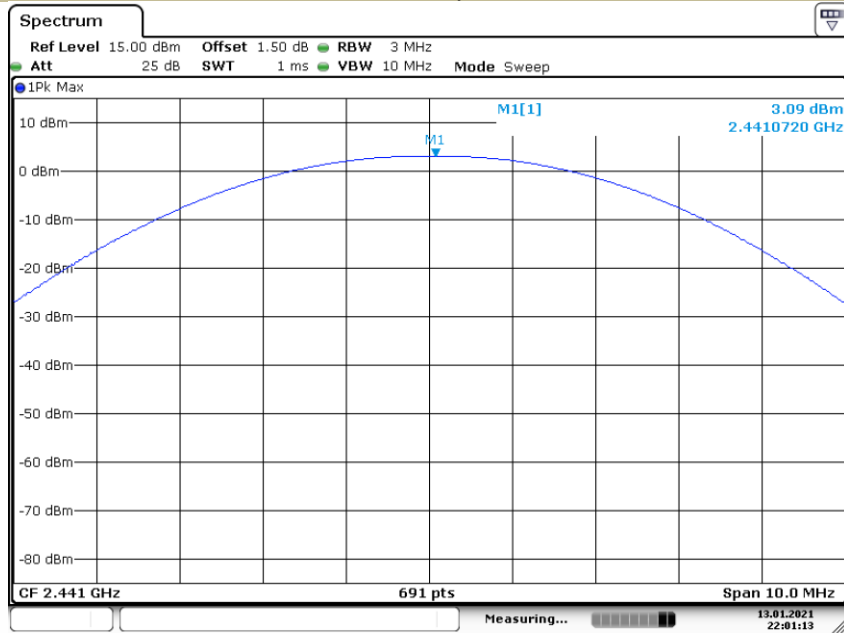

Date: 13. JAN 2021 22:01:13

**Test Model** Maximum Peak Conducted Output Power  
 Bluetooth with classic mode  
 Channel 78: 2480MHz pi/4-DQPSK

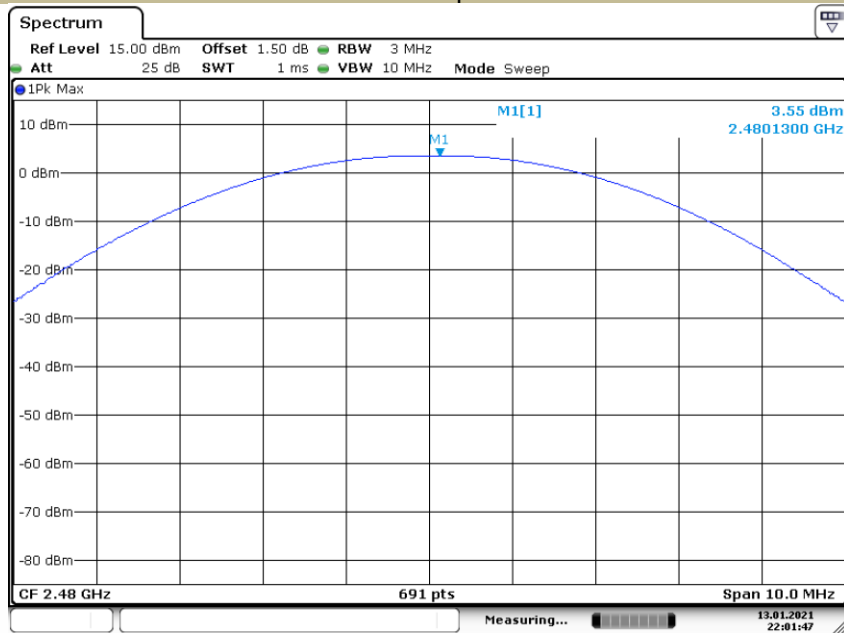

Date: 13. JAN 2021 22:01:47

**Test Model** Maximum Peak Conducted Output Power  
Bluetooth with classic mode  
Channel 0: 2402MHz 8DPSK

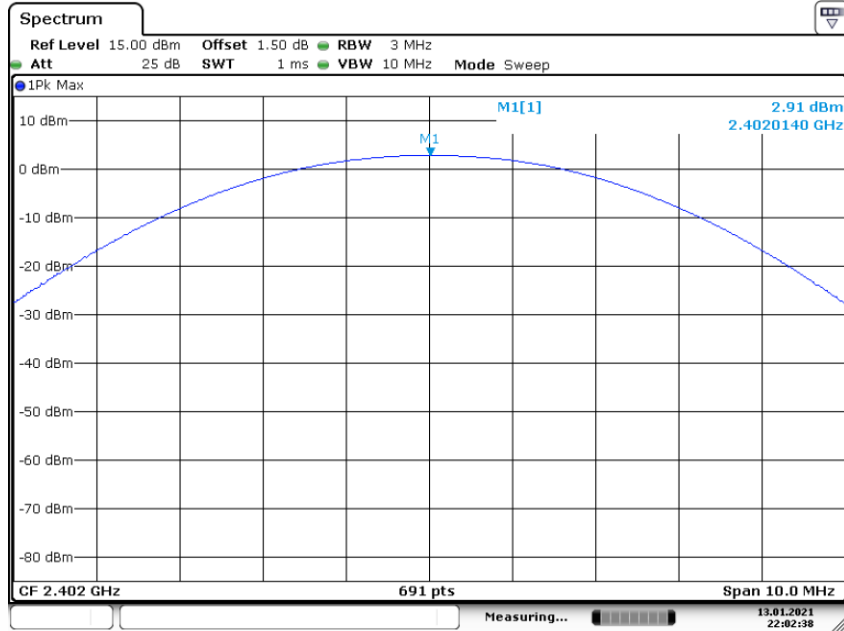

Date: 13. JAN 2021 22:02:38

**Test Model** Maximum Peak Conducted Output Power  
Bluetooth with classic mode  
Channel 39: 2441MHz 8DPSK

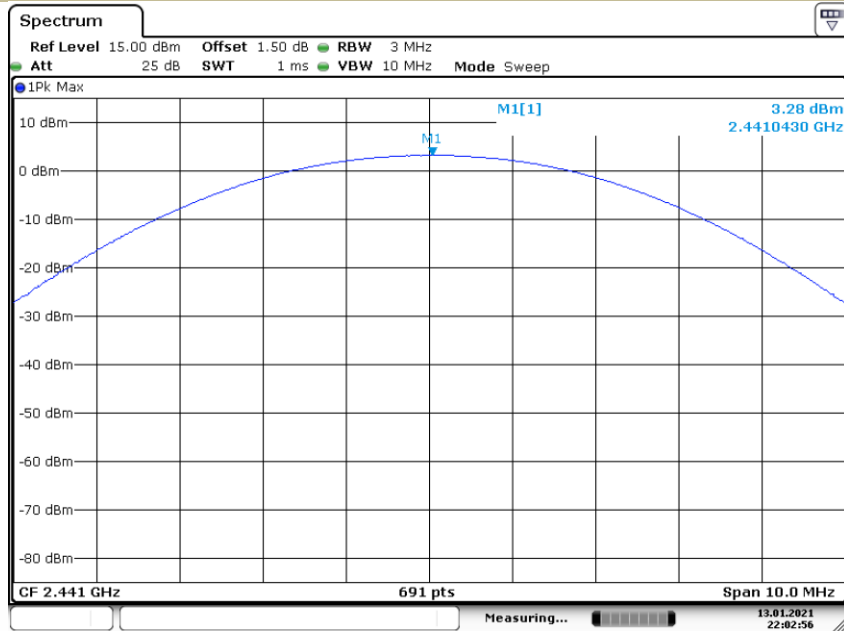

Date: 13. JAN 2021 22:02:56

**Test Model**      **Maximum Peak Conducted Output Power**  
**Bluetooth with classic mode**  
**Channel 78: 2480MHz**                      **8DPSK**

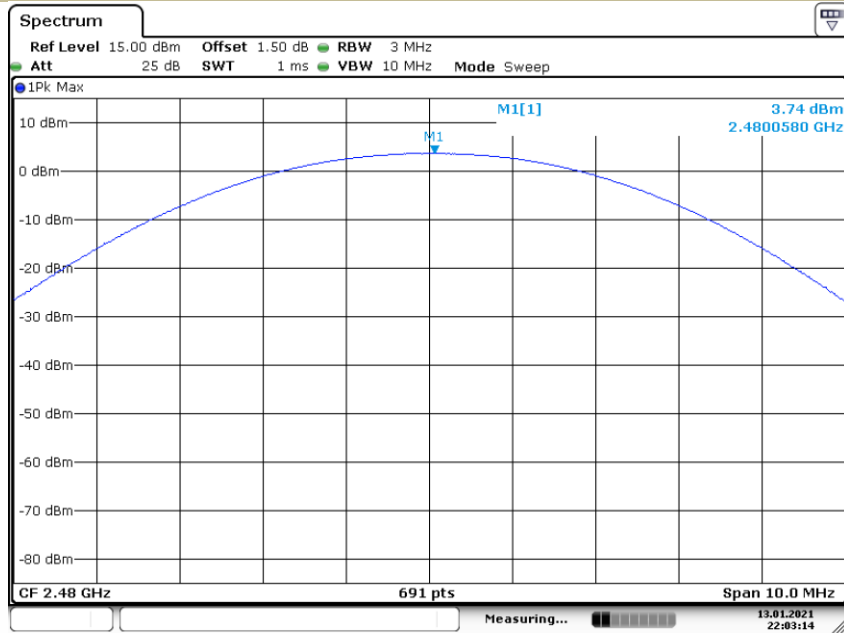

Date: 13. JAN 2021 22:03:14



## 9.6 CONDUCTED SPURIOUS EMISSION

### 9.6.1 Applicable Standard

According to FCC Part 15.247(d) and KDB 558074 D01 MEAS GUIDANCE V05r02

### 9.6.2 Conformance Limit

According to FCC Part 15.247(d):

In any 100 kHz bandwidth outside the frequency band in which the spread spectrum intentional radiator is operating, the radio frequency power that is produced by the intentional radiator shall be at least 20 dB below that in the 100 kHz bandwidth within the band that contains the highest level of the desired power, based on either an RF conducted, provided the transmitter demonstrates compliance with the peak conducted power limits.

### 9.6.3 Test Configuration

Test according to clause 7.1 radio frequency test setup 1

### 9.6.4 Test Procedure

The transmitter output (antenna port) was connected to the spectrum analyzer

#### ■ Reference level measurement

Establish a reference level by using the following procedure:

Set instrument center frequency to DSS channel center frequency.

Set Span = approximately 5 times the 20 dB bandwidth, centered on a hopping channel.

Set the RBW = 100 kHz. Set the VBW  $\geq 3 \times$  RBW.

Set Detector = peak. Set Sweep time = auto couple.

Set Trace mode = max hold. Allow trace to fully stabilize.

Use the peak marker function to determine the maximum Maximum conducted level.

Note that the channel found to contain the maximum conducted level can be used to establish the reference level.

#### ■ Band-edge Compliance of RF Conducted Emissions

Use the following spectrum analyzer settings:

Span = wide enough to capture the peak level of the emission operating on the channel closest to the band-edge, as well as any modulation products which fall outside of the authorized band of operation

Set RBW  $\geq 1\%$  of the span=100kHz Set VBW  $\geq$  RBW

Set Sweep = auto Set Detector function = peak Set Trace = max hold

Allow the trace to stabilize. Set the marker on the emission at the bandedge, or on the highest modulation product outside of the band, if this level is greater than that at the bandedge. Enable the marker-delta function, then use the marker-to-peak function to move the marker to the peak of the in-band emission. The marker-delta value now displayed must comply with the limit specified in this Section.

Now, using the same instrument settings, enable the hopping function of the EUT. Allow the trace to stabilize. Follow the same procedure listed above to determine if any spurious emissions caused by the hopping function also comply with the specified limit.

#### ■ Conducted Spurious RF Conducted Emission

Use the following spectrum analyzer settings:

Span = wide enough to capture the peak level of the in-band emission and all spurious emissions (e.g., harmonics) from the lowest frequency generated in the EUT up through the 10th harmonic.(30MHz to 25GHz). Set RBW = 100 kHz Set VBW  $\geq$  RBW

Set Sweep = auto Set Detector function = peak Set Trace = max hold

Allow the trace to stabilize. Set the marker on the peak of any spurious emission recorded. The level displayed must comply with the limit specified in this Section.



### 9.6.5 Test Results

Bluetooth (GFSK, pi/4-DQPSK, 8DPSK) mode have been tested, and the worst result(GFSK) was report as below:

Test Model	Maximum Conduced Level RBW=100kHz
	Bluetooth with classic mode
	Channel 0: 2402MHz GFSK

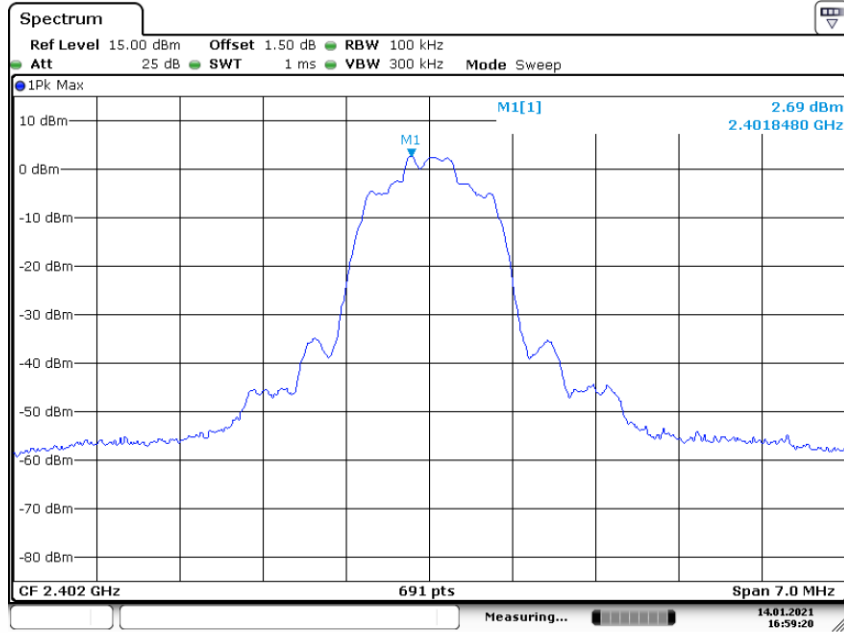

Date: 14 JAN 2021 16:59:20

Test Model	Conduced Spurious RF Conduced Emission
	Bluetooth with classic mode
	Channel 0: 2402MHz GFSK

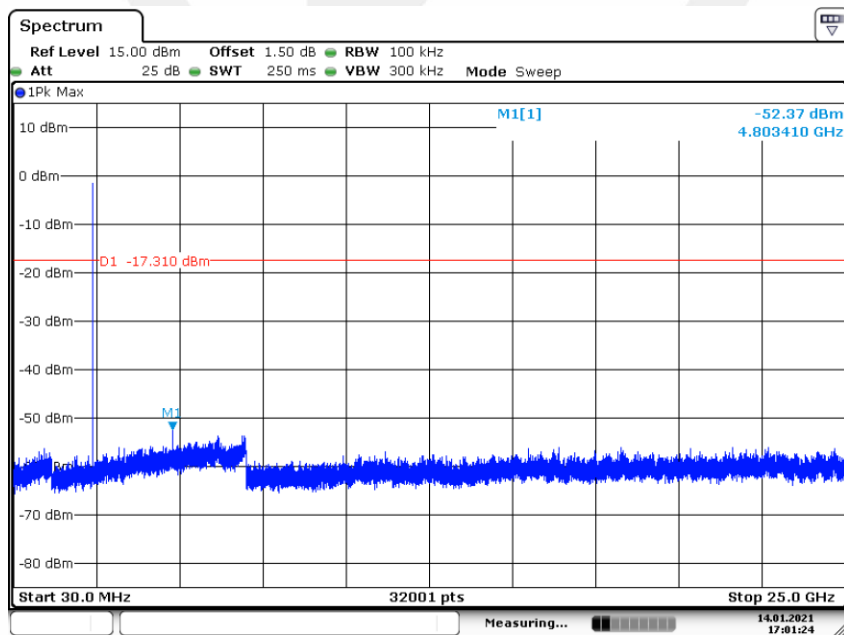

Date: 14 JAN 2021 17:01:24

**Test Model**      **Band-edge Conducted Emissions**  
**Bluetooth with classic mode**  
**Channel 0: 2402MHz**                      **GFSK**

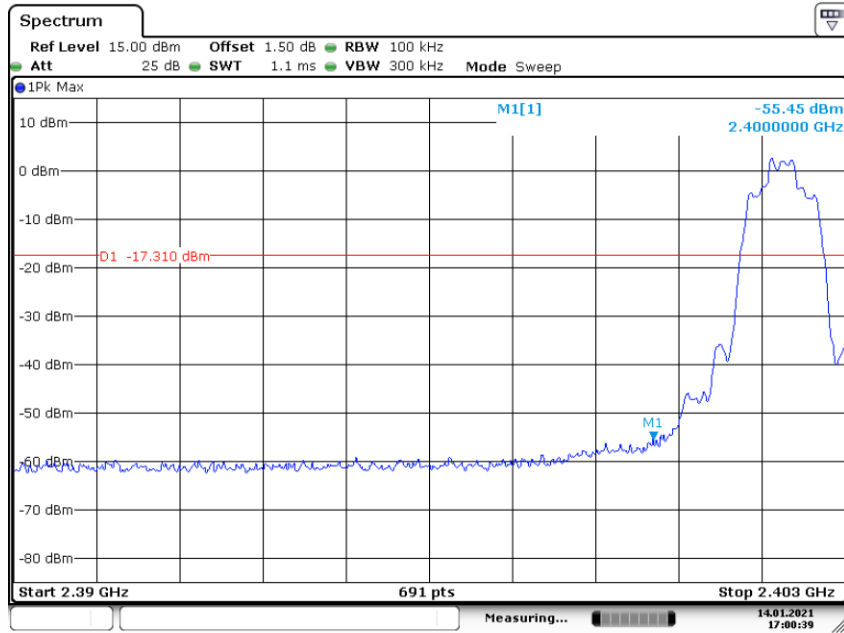

Date: 14. JAN 2021 17:00:40

**Test Model**      **Maximum Conduced Level RBW=100kHz**  
**Bluetooth with classic mode**  
**Channel 39: 2441MHz**                      **GFSK**

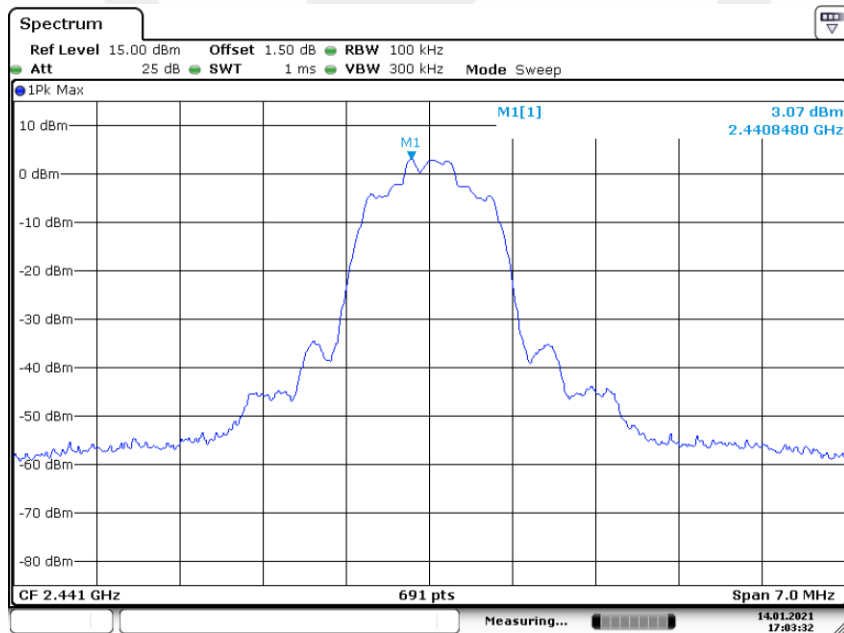

Date: 14. JAN 2021 17:03:32

Test Model Conducted Spurious RF Conducted Emission  
Bluetooth with classic mode  
Channel 39: 2441MHz GFSK

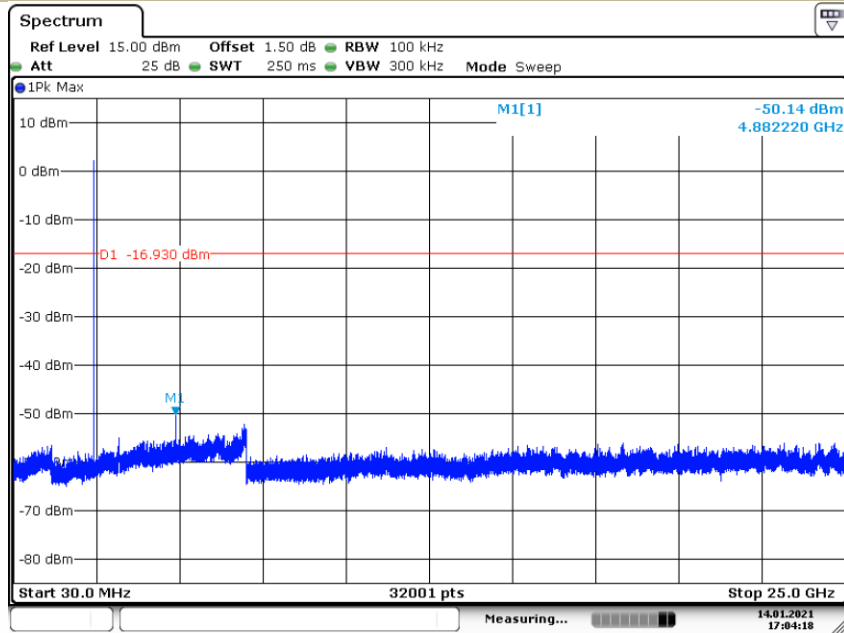

Date: 14 JAN 2021 17:04:18

Test Model Maximum Conducted Level RBW=100kHz  
Bluetooth with classic mode  
Channel 78: 2480MHz GFSK

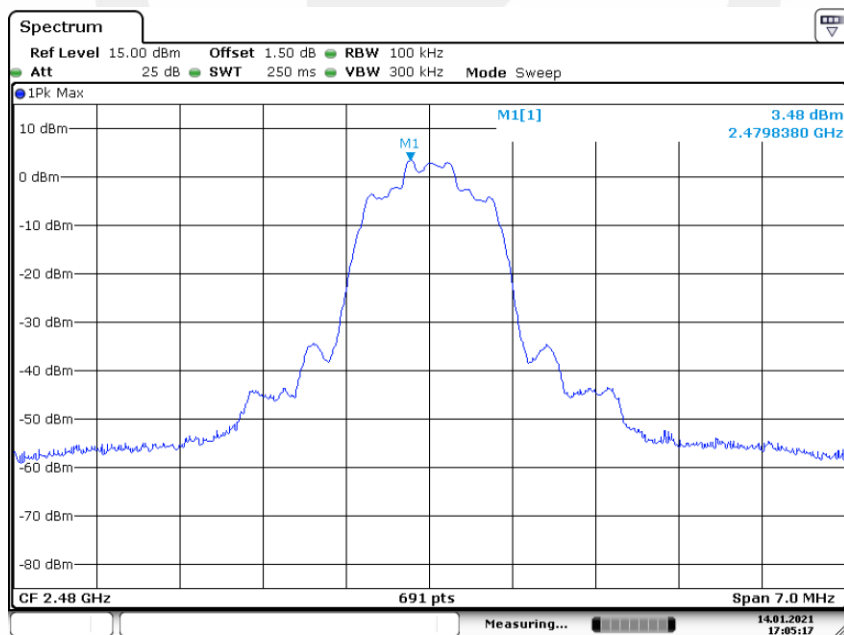

Date: 14 JAN 2021 17:05:17

**Test Model**      **Conducted Spurious RF Conducted Emission**  
**Bluetooth with classic mode**  
**Channel 78: 2480MHz**                      **GFSK**

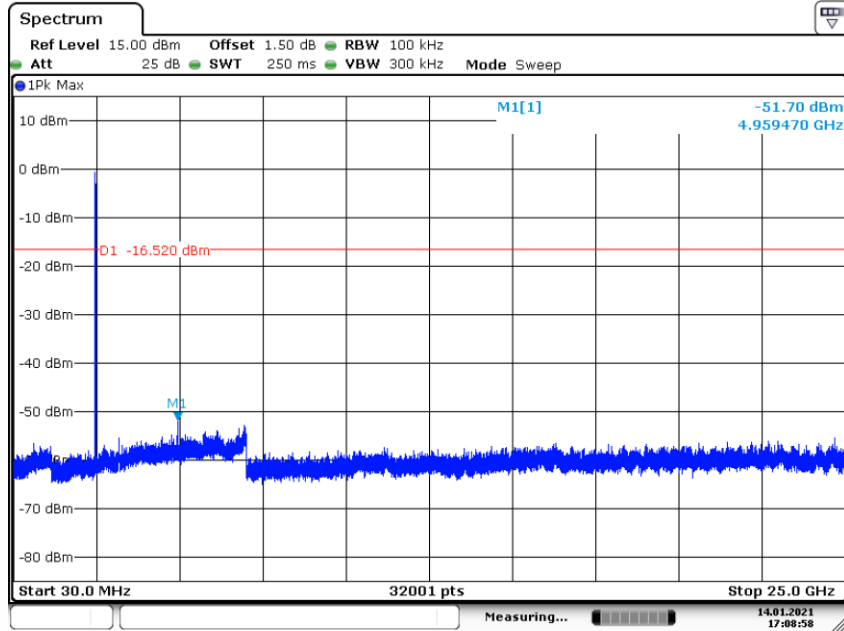

Date: 14 JAN 2021 17:08:59

**Test Model**      **Band-edge Conducted Emissions**  
**Bluetooth with classic mode**  
**Channel 78: 2480MHz**                      **GFSK**

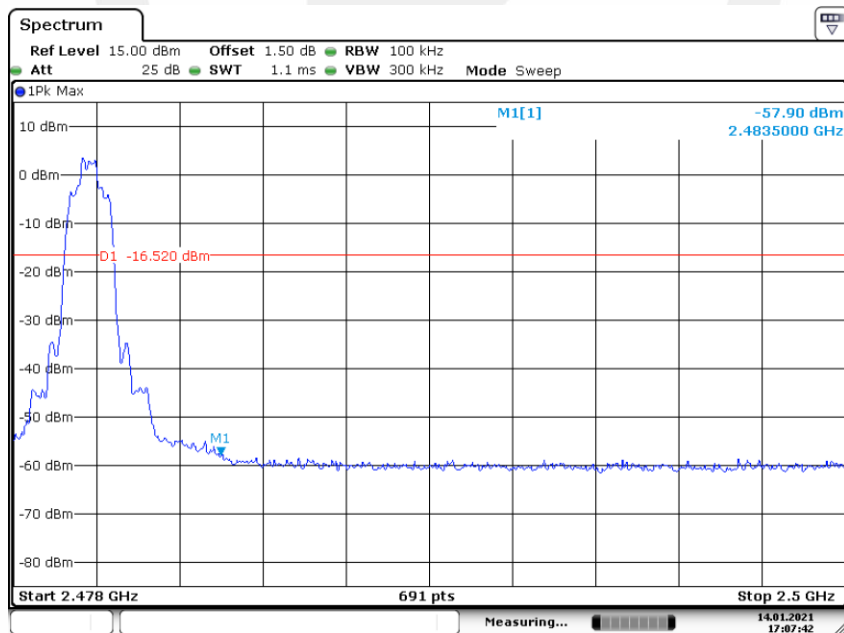

Date: 14 JAN 2021 17:07:42

**Test Model** Maximum Conducted Level RBW=100kHz  
 Bluetooth with classic mode  
 Hopping GFSK

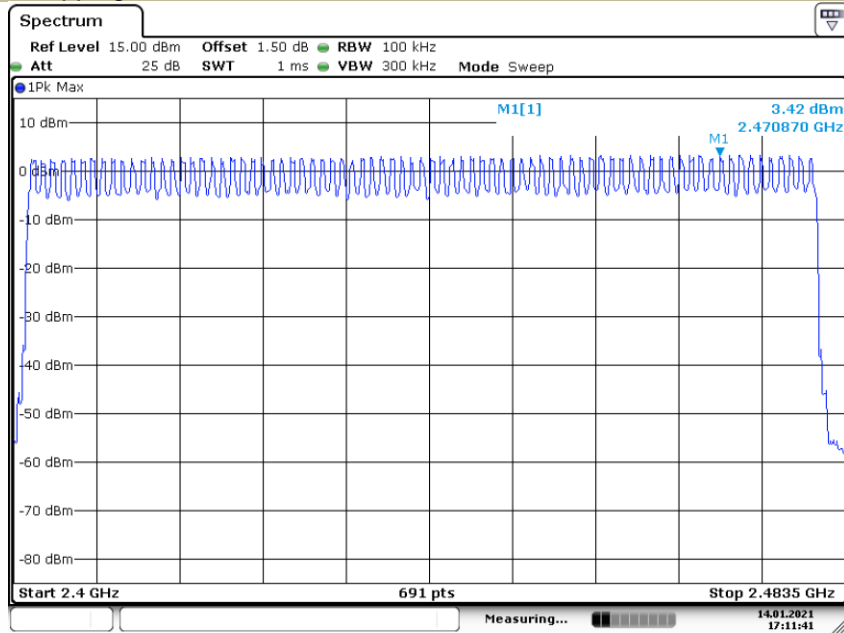

Date: 14.JAN.2021 17:11:41

**Test Model** Conducted Spurious RF Conducted Emission  
 Bluetooth with classic mode  
 Hopping GFSK

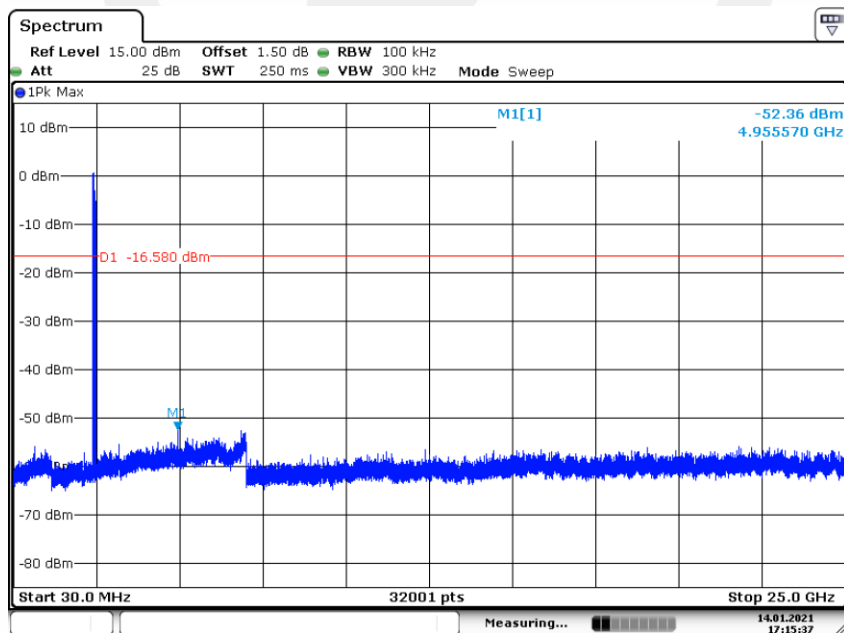

Date: 14.JAN.2021 17:15:36

Test Model Band-edge Conducted Emissions  
Bluetooth with classic mode  
Hopping GFSK

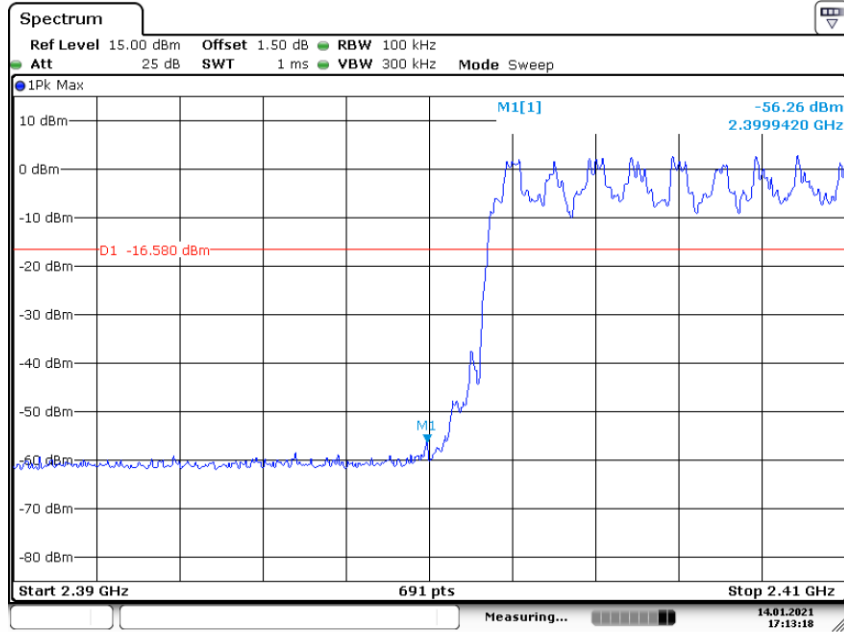

Date: 14. JAN.2021 17:13:18

Test Model Band-edge Conducted Emissions  
Bluetooth with classic mode  
Hopping GFSK

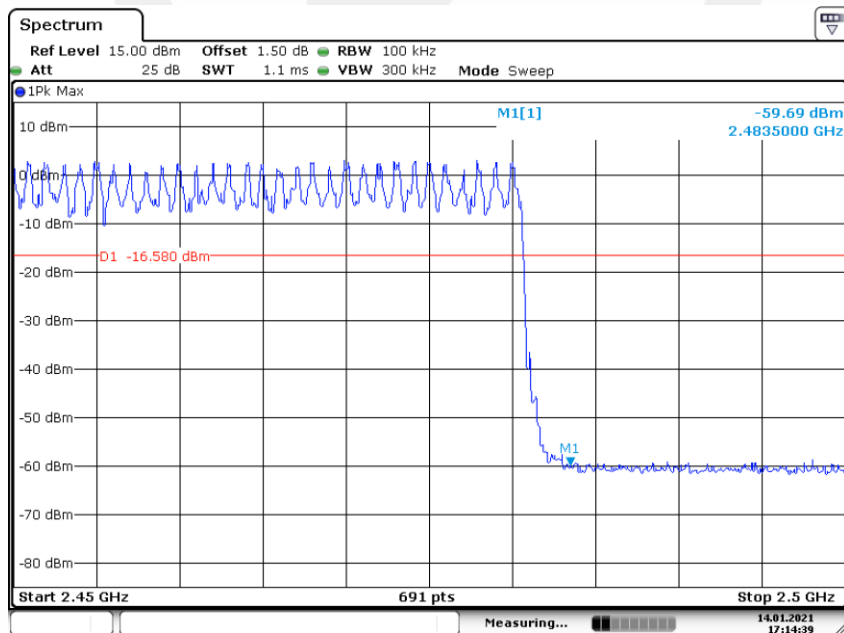

Date: 14. JAN.2021 17:14:39

## 9.7 RADIATED SPURIOUS EMISSION

### 9.7.1 Applicable Standard

According to FCC Part 15.247(d) and 15.209 and KDB 558074 D01 MEAS GUIDANCE V05r02

### 9.7.2 Conformance Limit

According to FCC Part 15.247(d): radiated emissions which fall in the restricted bands, as defined in §15.205(a), must also comply with the radiated emission limits specified in §15.209(a) (see §15.205(c)).

According to FCC Part 15.205, Restricted bands

MHz	MHz	MHz	GHz
0.090-0.110	16.42-16.423	399.9-410	4.5-5.15
10.495-0.505	16.69475-16.69525	608-614	5.35-5.46
2.1735-2.1905	16.80425-16.80475	960-1240	7.25-7.75
4.125-4.128	25.5-25.67	1300-1427	8.025-8.5
4.17725-4.17775	37.5-38.25	1435-1626.5	9.0-9.2
4.20725-4.20775	73-74.6	1645.5-1646.5	9.3-9.5
6.215-6.218	74.8-75.2	1660-1710	10.6-12.7
6.26775-6.26825	123-138	2200-2300	14.47-14.5
8.291-8.294	149.9-150.05	2310-2390	15.35-16.2
8.362-8.366	156.52475-156.52525	2483.5-2500	17.7-21.4
8.37625-8.38675	156.7-156.9	2690-2900	22.01-23.12
8.41425-8.41475	162.0125-167.17	3260-3267	23.6-24.0
12.29-12.293	167.72-173.2	3332-3339	31.2-31.8
12.51975-12.52025	240-285	3345.8-3358	36.43-36.5
12.57675-12.57725	322-335.4	3600-4400	(2)
13.36-13.41			

According to FCC Part 15.205, the level of any transmitter spurious emission in Restricted bands shall not exceed the level of the emission specified in the following table

Restricted Frequency(MHz)	Field Strength (μV/m)	Field Strength (dBμV/m)	Measurement Distance
0.009-0.490	2400/F(KHz)	20 log (uV/m)	300
0.490-1.705	24000/F(KHz)	20 log (uV/m)	30
1.705-30	30	29.5	30
30-88	100	40	3
88-216	150	43.5	3
216-960	200	46	3
Above 960	500	54	3

### 9.7.3 Test Configuration

Test according to clause 7.2 radio frequency test setup 2

### 9.7.4 Test Procedure

This test is required for any spurious emission that falls in a Restricted Band, as defined in Section 15.205. It must be performed with the highest gain of each type of antenna proposed for use with the EUT. Use the following spectrum analyzer settings:

For Above 1GHz:

The EUT was placed on a turn table which is 1.5m above ground plane.

Maximum procedure was performed on the highest emissions to ensure EUT compliance.

Span = wide enough to fully capture the emission being measured

RBW = 1 MHz

VBW ≥ RBW

Sweep = auto

Detector function = peak

Trace = max hold

For Below 1GHz:

The EUT was placed on a turn table which is 0.8m above ground plane.

Maximum procedure was performed on the highest emissions to ensure EUT compliance.

Span = wide enough to fully capture the emission being measured

RBW = 100 kHz for

VBW ≥ RBW

Sweep = auto

Detector function = peak

Trace = max hold

For Below 30MHz:

The EUT was placed on a turn table which is 0.8m above ground plane.

Maximum procedure was performed on the highest emissions to ensure EUT compliance.

Span = wide enough to fully capture the emission being measured

RBW = 9kHz

VBW ≥ RBW

Sweep = auto

Detector function = peak

Trace = max hold

For Below 150KHz:

The EUT was placed on a turn table which is 0.8m above ground plane.

Maximum procedure was performed on the highest emissions to ensure EUT compliance.

Span = wide enough to fully capture the emission being measured

RBW = 200Hz

VBW ≥ RBW

Sweep = auto

Detector function = peak

Trace = max hold

Follow the guidelines in ANSI C63.10-2013 with respect to maximizing the emission by rotating the EUT, measuring the emission while the EUT is situated in three orthogonal planes (if appropriate), adjusting the measurement antenna height and polarization, etc. A pre-amp and a high pass filter are required for this test, in order to provide the measuring system with sufficient sensitivity. Allow the trace to stabilize. The peak reading of the emission, after being corrected by the antenna factor, cable loss, pre-amp gain, etc., is the peak field strength, which must comply with the limit specified in Section 15.35(b). Submit this data.

Now set the VBW to 10 Hz, while maintaining all of the other instrument settings. This peak level, once corrected, must comply with the limit specified in Section 15.209. If the dwell time per channel of the hopping signal is less than 100 ms, then the reading obtained with the 10 Hz VBW may be further adjusted by a "duty cycle correction factor", derived from  $20\log(\text{dwell time}/100 \text{ ms})$ , in an effort to demonstrate compliance with the 15.209 limit. Submit this data.

Repeat above procedures until all frequency measured was complete.

### 9.7.5 Test Results

#### ■ Spurious Emission below 30MHz (9KHz to 30MHz)

Temperature:	26°C
Relative Humidity:	54%
ATM Pressure:	1011 mbar

Freq. (MHz)	Ant.Pol. H/V	Emission Level(dBuV/m)		Limit 3m(dBuV/m)		Over(dB)	
		PK	AV	PK	AV	PK	AV
--	--	--	--	--	--	--	--

Note: the amplitude of spurious emission that is attenuated by more than 20dB below the permissible limit has no need to be reported.

Distance extrapolation factor =  $40\log(\text{Specific distance}/ \text{test distance})(\text{dB})$ ;



Limit line=Specific limits(dBuV) + distance extrapolation factor

■ Spurious Emission Above 1GHz (1GHz to 25GHz)

Bluetooth (GFSK, pi/4-DQPSK, 8DPSK) mode have been tested, and the worst result(GFSK) was report as below:

Test mode: GFSK Frequency: Channel 0: 2402MHz

Freq. (MHz)	Ant.Pol. H/V	Emission Level(dBuV/m)		Limit 3m(dBuV/m)		Over(dB)	
		PK	AV	PK	AV	PK	AV
5090.01	V	46.64	31.90	74	54	-27.36	-22.10
7875.25	V	52.89	35.60	74	54	-21.11	-18.40
12079.38	V	56.38	37.40	74	54	-17.62	-16.60
3693.03	H	43.28	27.60	74	54	-30.72	-26.40
5680.92	H	48.26	33.80	74	54	-25.74	-20.20
9781.60	H	54.10	36.00	74	54	-19.90	-18.00

Test mode: GFSK Frequency: Channel 39: 2441MHz

Freq. (MHz)	Ant.Pol. H/V	Emission Level(dBuV/m)		Limit 3m(dBuV/m)		Over(dB)	
		PK	AV	PK	AV	PK	AV
3693.03	42.13	43.28	27.60	74	54	-30.72	-26.40
5680.92	48.26	48.26	33.80	74	54	-25.74	-20.20
9781.60	57.02	54.10	36.00	74	54	-19.90	-18.00
5551.07	41.75	48.10	33.70	74	54	-25.90	-20.30
8013.02	44.55	52.85	35.80	74	54	-21.15	-18.20
12326.27	57.53	56.17	37.20	74	54	-17.83	-16.80

Test mode: GFSK Frequency: Channel 78: 2480MHz

Freq. (MHz)	Ant.Pol. H/V	Emission Level(dBuV/m)		Limit 3m(dBuV/m)		Over(dB)	
		PK	AV	PK	AV	PK	AV
4721.52	V	46.23	31.40	74	54	-27.77	-22.60
7673.03	V	53.37	36.20	74	54	-20.63	-17.80
12044.52	V	56.54	37.50	74	54	-17.46	-16.50
5209.08	H	47.43	33.10	74	54	-26.57	-20.90
7695.24	H	52.69	35.60	74	54	-21.31	-18.40
12397.73	H	56.69	37.30	74	54	-17.31	-16.70

- Note:**
- (1) All Readings are Peak Value (VBW=3MHz) and Average Value (VBW=10Hz).
  - (2) Emission Level= Reading Level+Correct Factor.
  - (3) Correct Factor= Ant\_F + Cab\_L - Preamp
  - (4) The reading of emissions are attenuated more than 20dB below the permissible limits or the field strength is too small to be measured.

■ Spurious Emission in Restricted Band 2310-2390MHz and 2483.5-2500MHz  
 Bluetooth (GFSK, pi/4-DQPSK, 8DPSK, Hopping) mode have been tested, and the worst result(GFSK, Hopping)  
 was report as below:

Test mode: GFSK Frequency: Channel 0: 2402MHz

Frequency (MHz)	Polarity H/V	PK(dBuV/m) (VBW=3MHz)	Limit 3m (dBuV/m)	Over(dB)	AV(dBuV/m) (VBW=10Hz)	Limit 3m (dBuV/m)	Over(dB)
2387.04	H	48.46	74	-25.54	34.20	54	-19.80
2384.720	V	48.81	74	-25.19	33.80	54	-20.20

Test mode: GFSK Frequency: Channel 78: 2480MHz

Frequency (MHz)	Polarity H/V	PK(dBuV/m) (VBW=3MHz)	Limit 3m (dBuV/m)	Over(dB)	AV(dBuV/m) (VBW=10Hz)	Limit 3m (dBuV/m)	Over(dB)
2483.517	H	61.84	74	-12.16	41.00	54	-13.00
2483.500	V	57.22	74	-16.78	38.30	54	-15.70

Test mode: GFSK Frequency: Hopping

Frequency (MHz)	Polarity H/V	PK(dBuV/m) (VBW=3MHz)	Limit 3m (dBuV/m)	Over(dB)	AV(dBuV/m) (VBW=10Hz)	Limit 3m (dBuV/m)	Over(dB)
2390.000	H	43.86	74	-30.14	29.10	54	-24.90
2483.500	H	63.69	74	-10.31	43.60	54	-10.40
2390.000	V	40.67	74	-33.33	27.50	54	-26.50
2483.500	V	62.69	74	-11.31	40.70	54	-13.30

- Note:**
- (1) All Readings are Peak Value (VBW=3MHz) and Average Value (VBW=10Hz).
  - (2) Emission Level= Reading Level+Correct Factor.
  - (3) Correct Factor= Ant\_F + Cab\_L - Preamp
  - (4) The reading of emissions are attenuated more than 20dB below the permissible limits or the field strength is too small to be measured.

Test Model	Spurious Emission in Restricted Band 2310-2390MHz		
	Bluetooth with classic mode		
	Channel 0: 2402MHz	GFSK	H
		Test By: XW	

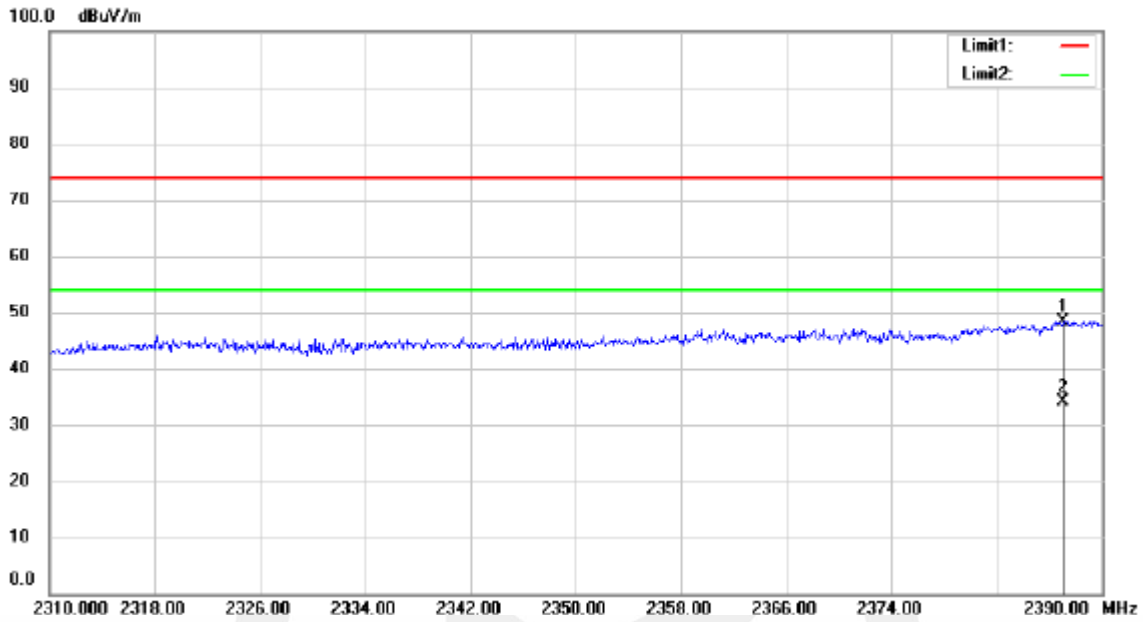

Test Model	Spurious Emission in Restricted Band 2310-2390MHz		
	Bluetooth with classic mode		
	Channel 0: 2402MHz	GFSK	V
		Test By: XW	

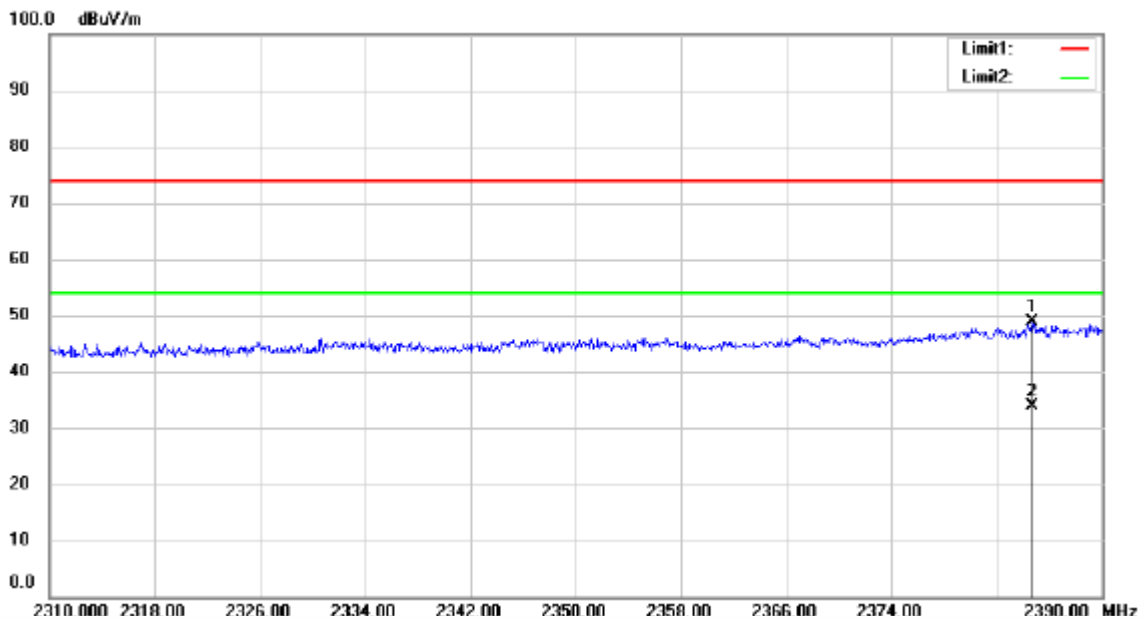

Test Model	Spurious Emission in Restricted Band 2483.5-2500MHz Bluetooth with classic mode Channel 78: 2480MHz	GFSK	H
		Test By: XW	

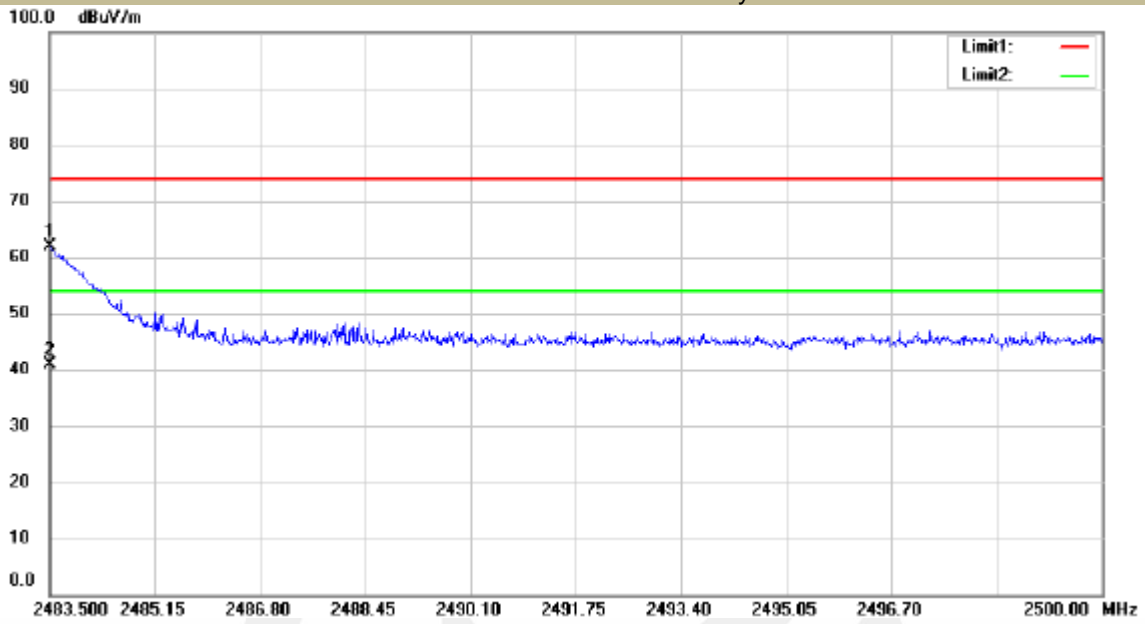

Test Model	Spurious Emission in Restricted Band 2483.5-2500MHz Bluetooth with classic mode Channel 78: 2480MHz	GFSK	V
		Test By: XW	

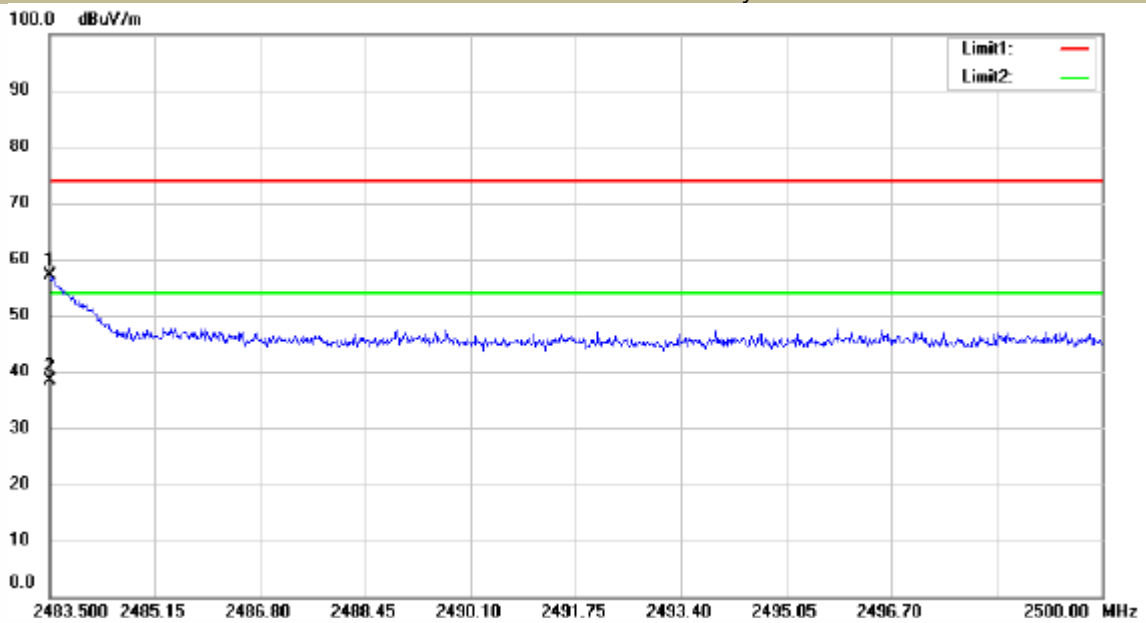

Test Model	Spurious Emission in Restricted Band 2310-2390MHz and 2400-2483.5MHz	GFSK	H
	Bluetooth with classic mode Hopping		

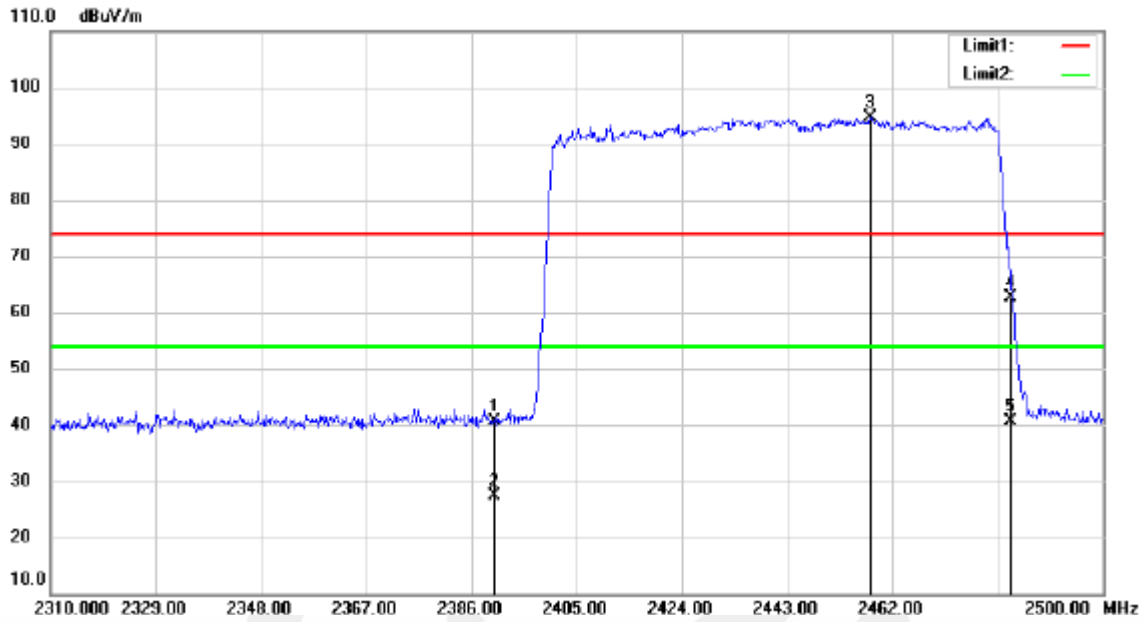

Test Model	Spurious Emission in Restricted Band 2310-2390MHz and 2400-2483.5MHz	GFSK	V
	Bluetooth with classic mode Hopping		

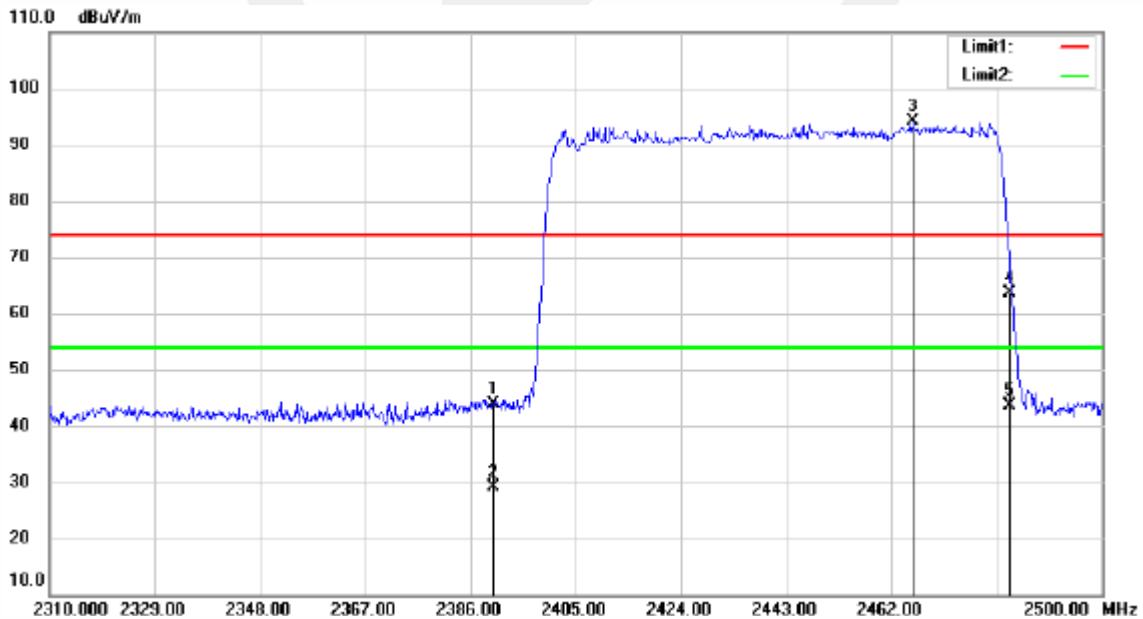

■ Spurious Emission below 1GHz(30MHz to 1GHz)

All Bluetooth (GFSK, pi/4-DQPSK, 8DPSK) modes have been tested, and the worst results has been recorded on the follow page.

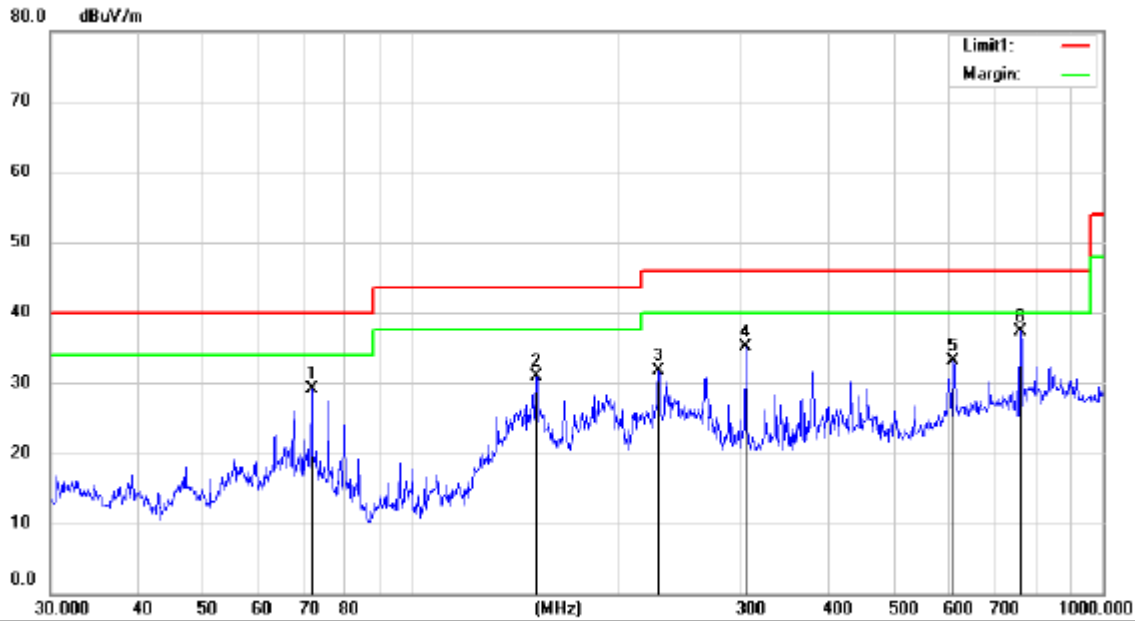

Site 3m Chamber #3

Polarization: *Horizontal*

Temperature: 22.5 C

Limit: (RE)FCC PART 15 CLASS B

Power: DC 3.7V

Humidity: 45 %

Mode:BT 2402MHZ

Note:

No.	Mk.	Freq.	Reading Level	Correct Factor	Measurement	Limit	Over	Antenna Height	Table Degree	
		MHz	dBuV	dB	dBuV/m	dBuV/m	dB	cm	degree	Comment
1		71.5805	44.50	-15.45	29.05	40.00	-10.95	QP		
2		151.5971	47.26	-16.31	30.95	43.50	-12.55	QP		
3		227.6904	46.87	-15.17	31.70	46.00	-14.30	QP		
4		304.6100	46.87	-11.71	35.16	46.00	-10.84	QP		
5		607.7866	36.36	-3.17	33.19	46.00	-12.81	QP		
6	*	760.7033	36.84	0.51	37.35	46.00	-8.65	QP		

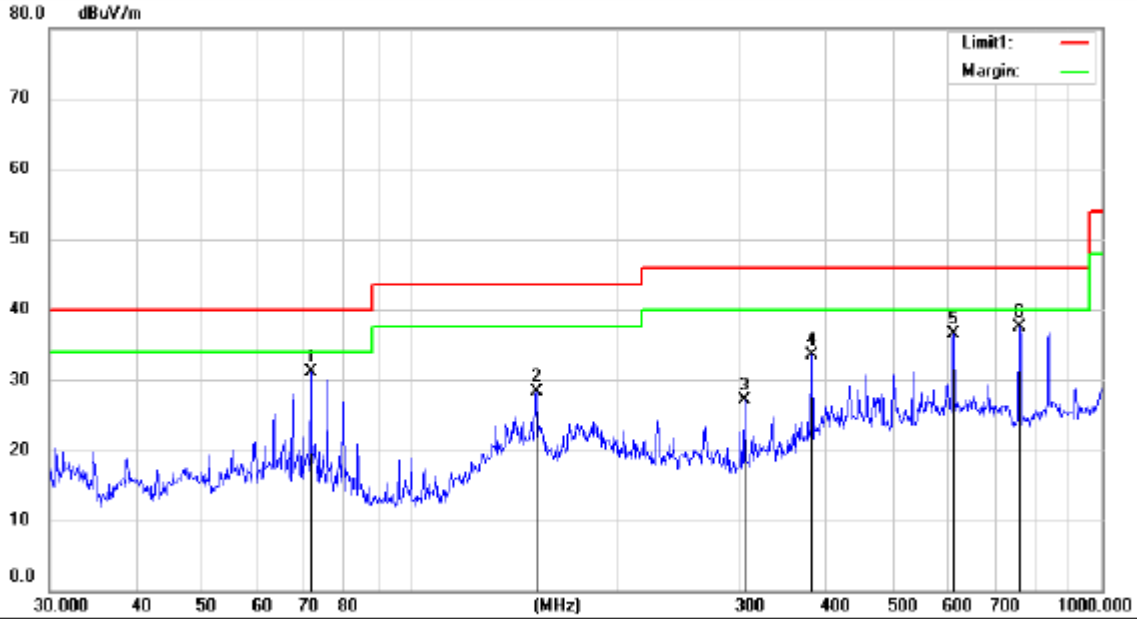

Site 3m Chamber #3

Polarization: *Vertical*

Temperature: 22.5 C

Limit: (RE)FCC PART 15 CLASS B

Power: DC 3.7V

Humidity: 45 %

Mode: BT 2402MHZ

Note:

No.	Mk.	Freq.	Reading Level	Correct Factor	Measurement	Limit	Over	Antenna Height	Table Degree
		MHz	dBuV	dB	dBuV/m	dBuV/m	dB	cm	degree
1		71.5805	46.53	-15.45	31.08	40.00	-8.92	QP	
2		152.1297	44.70	-16.34	28.36	43.50	-15.14	QP	
3		303.5437	38.78	-11.69	27.09	46.00	-18.91	QP	
4		381.2485	42.40	-8.97	33.43	46.00	-12.57	QP	
5		609.9215	39.58	-3.12	36.46	46.00	-9.54	QP	
6	*	760.7033	36.96	0.51	37.47	46.00	-8.53	QP	

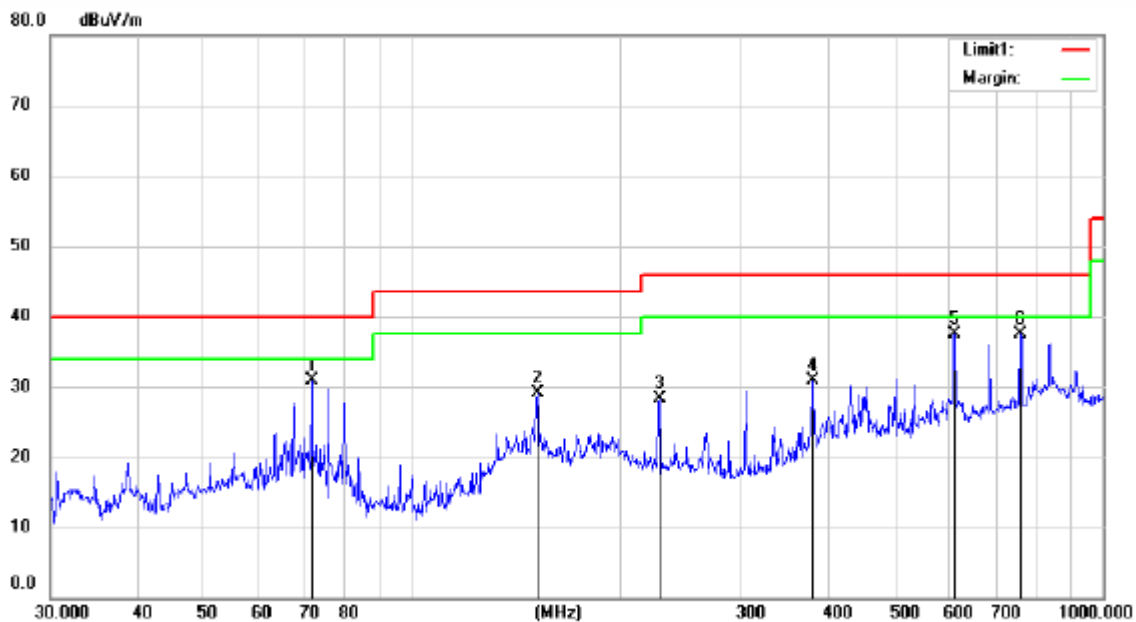

Site: 3m Chamber #3

Polarization: *Vertical*

Temperature: 22.5 C

Limit: (RE)FCC PART 15 CLASS B

Power: DC 3.7V

Humidity: 45 %

Mode: BT 2440MHZ

Note:

No.	Mk.	Freq.	Reading Level	Correct Factor	Measurement	Limit	Over	Antenna Height	Table Degree	
		MHz	dBuV	dB	dBuV/m	dBuV/m	dB	cm	degree	Comment
1		71.5805	46.36	-15.45	30.91	40.00	-9.09	QP		
2		152.1297	45.50	-16.34	29.16	43.50	-14.34	QP		
3		228.4903	43.43	-15.15	28.28	46.00	-17.72	QP		
4		379.9141	39.92	-9.03	30.89	46.00	-15.11	QP		
5		609.9215	40.57	-3.12	37.45	46.00	-8.55	QP		
6	*	760.7034	36.98	0.51	37.49	46.00	-8.51	QP		



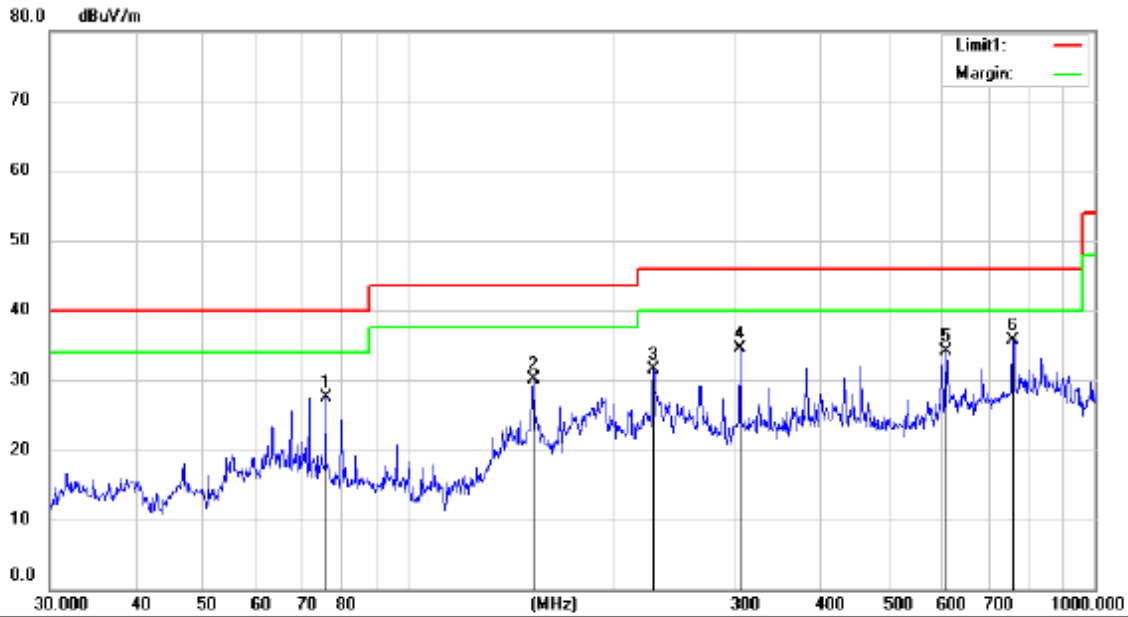

Site 3m Chamber #3

Polarization: *Horizontal*

Temperature: 22.5 C

Limit: (RE)FCC PART 15 CLASS B

Power: DC 3.7V

Humidity: 45 %

Mode: BT 2440MHZ

Note:

No.	Mk.	Freq.	Reading Level	Correct Factor	Measurement	Limit	Over	Antenna Height	Table Degree	
		MHz	dBuV	dB	dBuV/m	dBuV/m	dB	cm	degree	Comment
1		75.7112	43.88	-16.28	27.60	40.00	-12.40	QP		
2		152.1297	46.45	-16.34	30.11	43.50	-13.39	QP		
3		227.6905	46.64	-15.17	31.47	46.00	-14.53	QP		
4		303.5437	46.29	-11.69	34.60	46.00	-11.40	QP		
5		607.7866	37.18	-3.17	34.01	46.00	-11.99	QP		
6	*	760.7034	35.17	0.51	35.68	46.00	-10.32	QP		

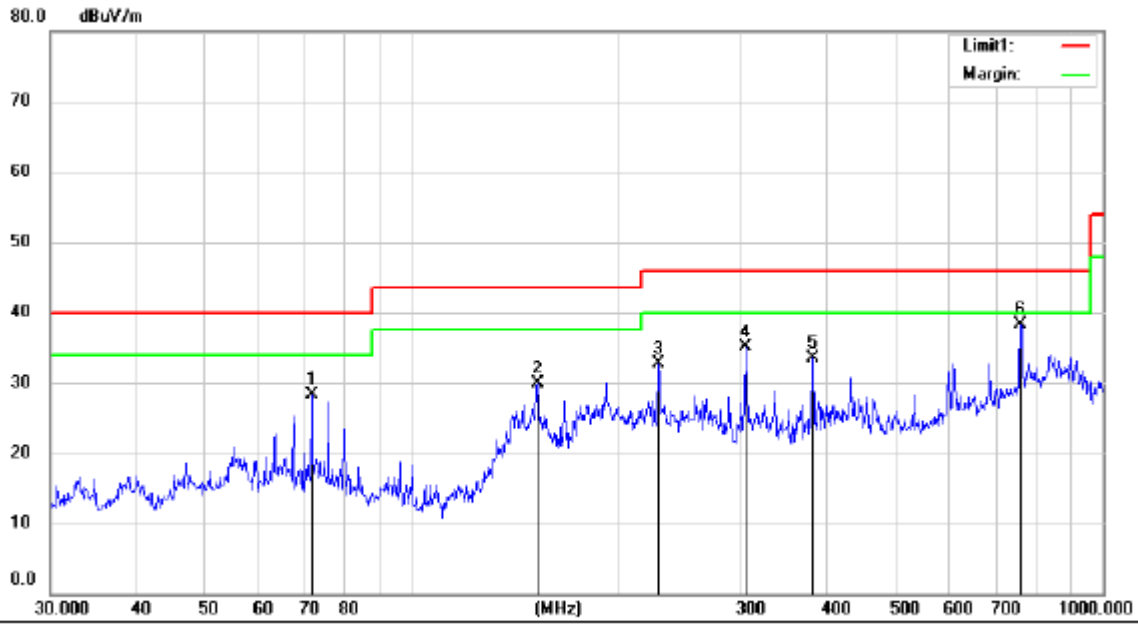

Site 3m Chamber #3

Polarization: *Horizontal*

Temperature: 22.5 C

Limit: (RE)FCC PART 15 CLASS B  
Mode: BT 2480MHZ

Power: DC 3.7V

Humidity: 45 %

Note:

No.	Mk.	Freq.	Reading Level	Correct Factor	Measurement	Limit	Over	Antenna Height	Table Degree	
		MHz	dBuV	dB	dBuV/m	dBuV/m	dB	cm	degree	Comment
1		71.5805	43.73	-15.45	28.28	40.00	-11.72	QP		
2		152.1297	46.26	-16.34	29.92	43.50	-13.58	QP		
3		227.6905	47.92	-15.17	32.75	46.00	-13.25	QP		
4		303.5437	46.86	-11.69	35.17	46.00	-10.83	QP		
5		381.2485	42.43	-8.97	33.46	46.00	-12.54	QP		
6	*	760.7034	37.76	0.51	38.27	46.00	-7.73	QP		

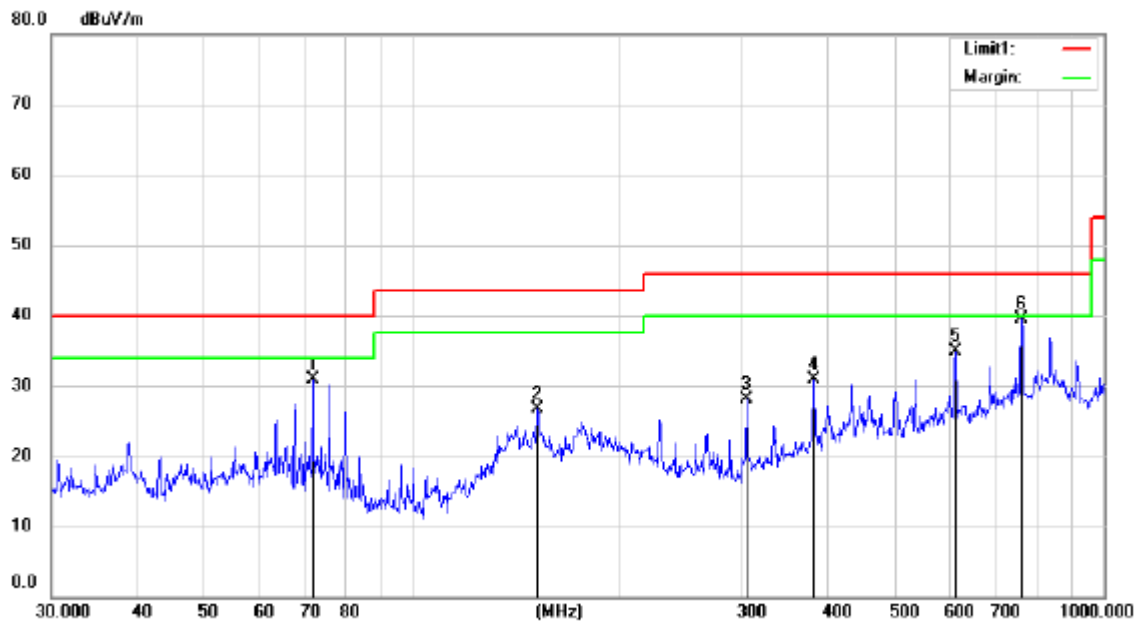

Site: 3m Chamber #3      Polarization: *Vertical*      Temperature: 22.5 C  
 Limit: (RE)FCC PART 15 CLASS B      Power: DC 3.7V      Humidity: 45 %  
 Mode: BT 2480MHZ  
 Note:

No.	Mk.	Freq.	Reading Level	Correct Factor	Measurement	Limit	Over	Antenna Height	Table Degree	
		MHz	dBuV	dB	dBuV/m	dBuV/m	dB	cm	degree	Comment
1		71.5805	46.41	-15.45	30.96	40.00	-9.04			QP
2		151.5971	42.95	-16.31	26.64	43.50	-16.86			QP
3		303.5437	39.89	-11.69	28.20	46.00	-17.80			QP
4		379.9141	39.96	-9.03	30.93	46.00	-15.07			QP
5		609.9215	37.93	-3.12	34.81	46.00	-11.19			QP
6	*	760.7034	39.08	0.51	39.59	46.00	-6.41			QP

**9.8 CONDUCTED EMISSION TEST**

**9.8.1 Applicable Standard**

According to FCC Part 15.207(a)

**9.8.2 Conformance Limit**

Conducted Emission Limit		
Frequency(MHz)	Quasi-peak	Average
0.15-0.5	66-56	56-46
0.5-5.0	56	46
5.0-30.0	60	50

Note: 1. The lower limit shall apply at the transition frequencies  
 2. The limit decreases in line with the logarithm of the frequency in the range of 0.15 to 0.50MHz.

**9.8.3 Test Configuration**

Test according to clause 7.3 conducted emission test setup

**9.8.4 Test Procedure**

The EUT was placed on a table which is 0.8m above ground plane.  
 Maximum procedure was performed on the highest emissions to ensure EUT compliance.  
 Repeat above procedures until all frequency measured were complete.

**9.8.5 Test Results**

Pass

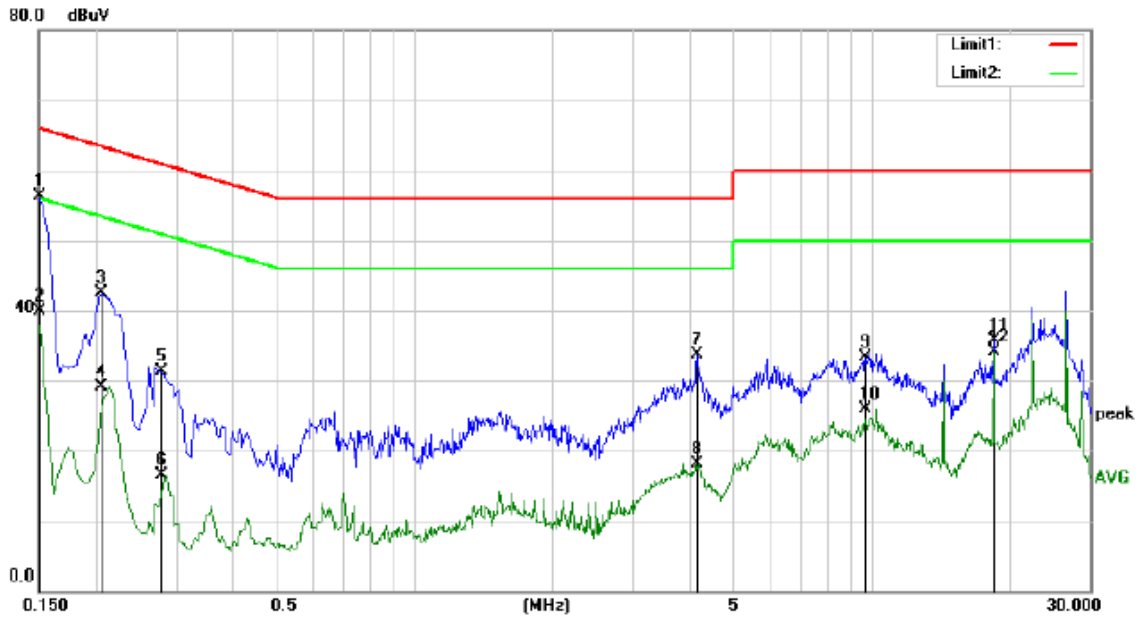

Site Conduction #1

Phase: **L1**

Temperature: 24.7

Limit: (CE)FCC PART 15 class B QP

Power: AC 120V/60Hz

Humidity: 38 %

Mode: charging

Note: A2

No.	Mk.	Freq. MHz	Reading Level dBuV	Correct Factor dB	Measure- ment dBuV	Limit dBuV	Over dB	Detector	Comment
1	*	0.1500	46.90	9.44	56.34	66.00	-9.66	QP	
2		0.1500	30.45	9.44	39.89	56.00	-16.11	AVG	
3		0.2060	33.15	9.43	42.58	63.37	-20.79	QP	
4		0.2060	19.64	9.43	29.07	53.37	-24.30	AVG	
5		0.2780	21.97	9.32	31.29	60.88	-29.59	QP	
6		0.2780	7.12	9.32	16.44	50.88	-34.44	AVG	
7		4.1540	23.82	9.83	33.65	56.00	-22.35	QP	
8		4.1540	8.35	9.83	18.18	46.00	-27.82	AVG	
9		9.6900	23.26	10.05	33.31	60.00	-26.69	QP	
10		9.6900	15.91	10.05	25.96	50.00	-24.04	AVG	
11		18.4340	25.52	10.17	35.69	60.00	-24.31	QP	
12		18.4340	23.91	10.17	34.08	50.00	-15.92	AVG	

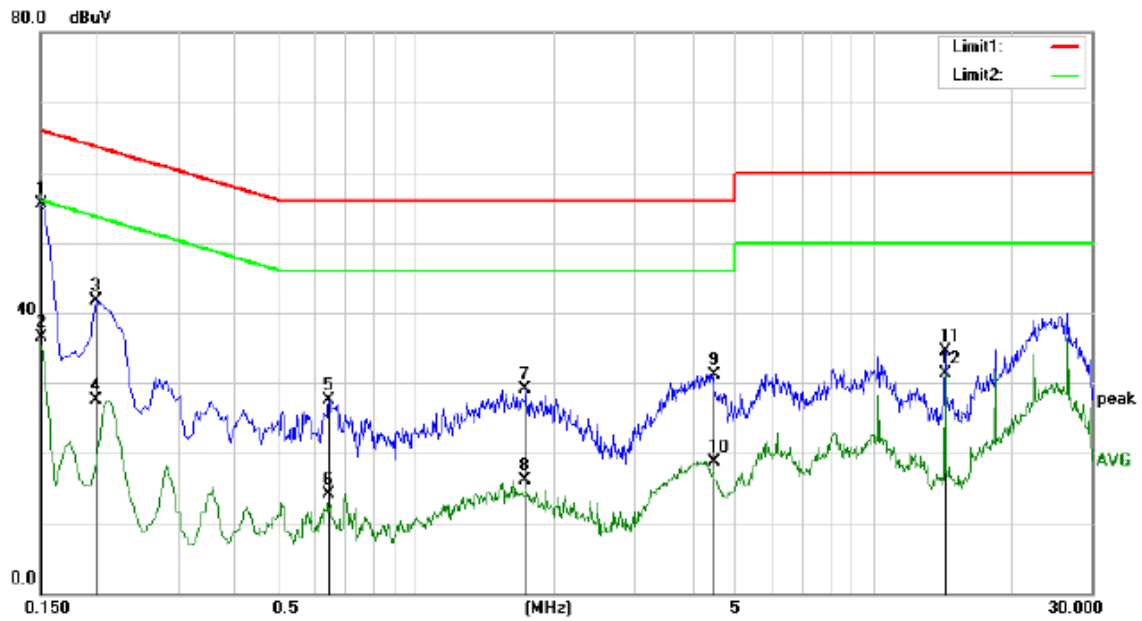

Site Conduction #1

Phase: **N**

Temperature: 24.7

Limit: (CE)FCC PART 15 class B\_QP

Power: AC 120V/60Hz

Humidity: 38 %

Mode: charging

Note: A2

No.	Mk.	Freq. MHz	Reading Level dBuV	Correct Factor dB	Measure- ment dBuV	Limit dBuV	Over dB	Detector	Comment
1	*	0.1500	46.14	9.44	55.58	66.00	-10.42	QP	
2		0.1500	27.09	9.44	36.53	56.00	-19.47	AVG	
3		0.1986	32.31	9.44	41.75	63.67	-21.92	QP	
4		0.1986	18.02	9.44	27.46	53.67	-26.21	AVG	
5		0.6420	18.13	9.28	27.41	56.00	-28.59	QP	
6		0.6420	4.84	9.28	14.12	46.00	-31.88	AVG	
7		1.7260	19.26	9.80	29.06	56.00	-26.94	QP	
8		1.7260	6.31	9.80	16.11	46.00	-29.89	AVG	
9		4.4660	21.31	9.84	31.15	56.00	-24.85	QP	
10		4.4660	8.95	9.84	18.79	46.00	-27.21	AVG	
11		14.3380	24.48	10.09	34.57	60.00	-25.43	QP	
12		14.3380	21.12	10.09	31.21	50.00	-18.79	AVG	

## 9.9 ANTENNA APPLICATION

### 9.9.1 Antenna Requirement

Standard	Requirement
FCC CRF Part 15.203	An intentional radiator shall be designed to ensure that no antenna other than that furnished by the responsible party shall be used with the device. The use of a permanently attached antenna or of an antenna that uses a unique coupling to the intentional radiator shall be considered sufficient to comply with the provisions of this section. The manufacturer may design the unit so that a broken antenna can be replaced by the user, but the use of a standard antenna jack or electrical connector is prohibited. This requirement does not apply to carrier current devices or to devices operated under the provisions of §15.211, §15.213, §15.217, §15.219, or §15.221. Further, this requirement does not apply to intentional radiators that must be professionally installed, such as perimeter protection systems and some field disturbance sensors, or to other intentional radiators which, in accordance with §15.31(d), must be measured at the installation site. However, the installer shall be responsible for ensuring that the proper antenna is employed so that the limits in this part are not exceeded.

For intentional device, according to FCC 47 CFR Section 15.203, an intentional radiator shall be designed to ensure that no antenna other than that furnished by the responsible party shall be used with the device. And according to FCC 47 CFR Section 15.247 (b), if transmitting antennas of directional gain greater than 6dBi are used, the power shall be reduced by the amount in dB that the directional gain of the antenna exceeds 6dBi.

### 9.9.2 Result

PASS.

The EUT is LDS antenna for BT, the gain is 1.12 dBi.

- Note:
- Antenna use a permanently attached antenna which is not replaceable.
  - Not using a standard antenna jack or electrical connector for antenna replacement
  - The antenna has to be professionally installed (please provide method of installation)

which in accordance to section 15.203, please refer to the internal photos.

\*\*\* End of Report \*\*\*