



TEST REPORT

FCC Part 95 & RSS 210

Report Reference No.: **CTL1612138201-WF**

Compiled by:
(position+printed name+signature)

Allen Wang
(File administrators)

Allen Wang

Tested by:
(position+printed name+signature)

Nice Nong
(Test Engineer)

Nice Nong

Approved by:
(position+printed name+signature)

Tracy Qi
(Manager)

Tracy Qi

Product Name.....: Intercom system

Model/Type reference: HY777

List Model(s).....: N/A

FCC ID.....: 2AJEM-HY777

Trade Mark.....: HOSMART

Applicant's name: **Shenzhen Macross Industrial Co., Ltd.**

Address of applicant: Huang Jia Mei Long buliding B1106, Min Zhi Block, Mei Long Road, Long Hua District, Shenzhen, Guangdong, China

Test Firm: **Shenzhen CTL Testing Technology Co., Ltd.**

Address of Test Firm: Floor 1-A, Baisha Technology Park, No.3011, ShaheXi Road, Nanshan District, Shenzhen, China 518055

Test specification.....:

Standard.....: **FCC Part 95
RSS 210 Issue 8**

TRF Originator: Shenzhen CTL Testing Technology Co., Ltd.

Master TRF: Dated 2011-01

Date of Receipt.....: Dec. 13, 2016

Date of Test Date.....: Dec. 14, 2016 –Dec. 27, 2016

Data of Issue.....: Dec. 28, 2016

Result.....: Pass

Shenzhen CTL Testing Technology Co., Ltd. All rights reserved.

This publication may be reproduced in whole or in part for non-commercial purposes as long as the Shenzhen CTL Testing Technology Co., Ltd. is acknowledged as copyright owner and source of the material. Shenzhen CTL Testing Technology Co., Ltd. takes no responsibility for and will not assume liability for damages resulting from the reader's interpretation of the reproduced material due to its placement and context.

TEST REPORT

Test Report No. :	CTL1612138201-WF	Dec. 28, 2016 Date of issue
--------------------------	-------------------------	--------------------------------

Equipment under Test : Intercom system

Model /Type : HY777

Listed Models : N/A

Applicant : **Shenzhen Macross Industrial Co., Ltd.**

Address : Huang Jia Mei Long buliding B1106, Min Zhi Block, Mei Long Road, Long Hua District, Shenzhen, Guangdong, China

Manufacturer : **Shenzhen Macross Industrial Co., Ltd.**

Address : Huang Jia Mei Long buliding B1106, Min Zhi Block, Mei Long Road, Long Hua District, Shenzhen, Guangdong, China

Test result	Pass *
--------------------	---------------

* In the configuration tested, the EUT complied with the standards specified page 5.

The test report merely corresponds to the test sample.

It is not permitted to copy extracts of these test result without the written permission of the test laboratory.

**** Modified History ****

Revision	Description	Issued Data	Report No.	Remark
Version 1.0	Initial Test Report Release	2016-12-28	CTL1612138201-WF	Tracy Qi



Table of Contents

Page

- 1. SUMMARY
- 1.1. TEST STANDARDS
- 1.2. TEST DESCRIPTION
- 1.3. TEST FACILITY
- 1.4. STATEMENT OF THE MEASUREMENT UNCERTAINTY
- 2. GENERAL INFORMATION
- 2.1. ENVIRONMENTAL CONDITIONS
- 2.2. GENERAL DESCRIPTION OF EUT
- 2.3. DESCRIPTION OF TEST MODES AND TEST FREQUENCY
- 2.4. MEASUREMENT INSTRUMENTS LIST
- 2.5. RELATED SUBMITTAL(S) / GRANT(S)
- 2.6. MODIFICATIONS
- 3. TEST CONDITIONS AND RESULTS
- 3.1. MAXIMUM TRANSMITTER POWER
- 3.2. OCCUPIED BANDWIDTH AND EMISSION MASK
- 3.3. MODULATION CHARACTERISTIC
- 3.4. FREQUENCY STABILITY
- 3.5. TRANSMITTER RADIATED SPURIOUS EMISSION
- 4. TEST SETUP PHOTOS OF THE EUT
- 5. EXTERNAL AND INTERNAL PHOTOS OF THE EUT

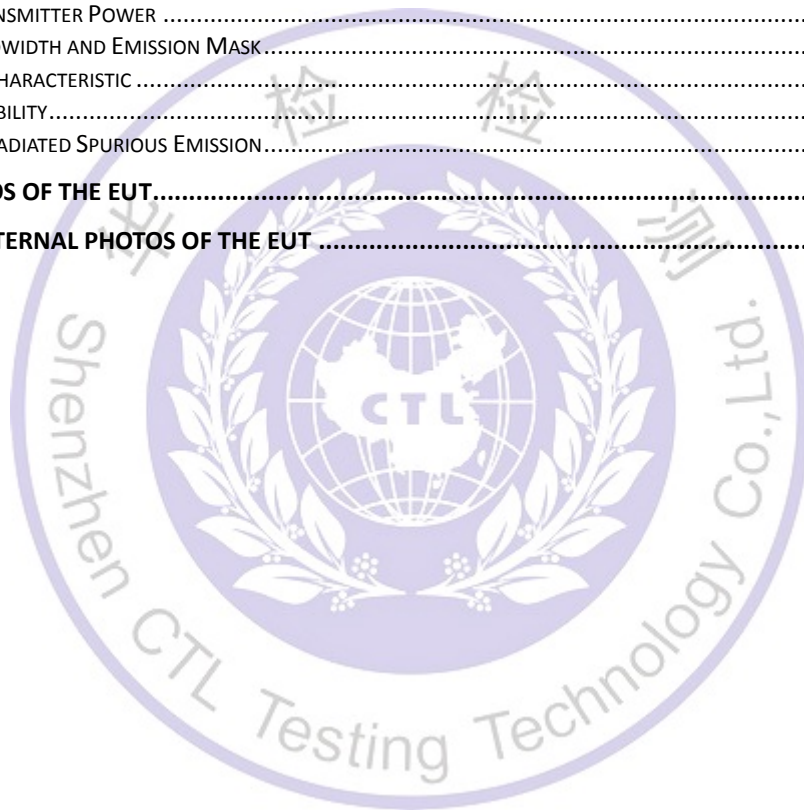

1. SUMMARY

1.1. TEST STANDARDS

The tests were performed according to following standards:

[FCC Rules Part 95](#) : PERSONAL RADIO SERVICES

[TIA/EIA 603 D:June 2010](#): Land Mobile FM or PM Communications Equipment Measurement and Performance Standards.

[FCC Part 2](#): FREQUENCY ALLOCATIONS AND RADIO TREATY MATTERS; GENERAL RULES AND REGULATIONS

[RSS-Gen Issue 4](#): General Requirements for Compliance of Radio Apparatus

[RSS-210 Issue 8](#): Licence-exempt Radio Apparatus (All Frequency Bands): Category I Equipment

[ANSI C63.10:2013](#) : American National Standard for Testing Unlicensed Wireless Devices

[ANSI C63.4: 2014](#): –American National Standard for Methods of Measurement of Radio-Noise Emissions from Low-Voltage Electrical and Electronic Equipment in the Range of 9 kHz to 40GHz

1.2. Test Description

Description of Test Item	Standard clause	Verdict
Maximum Transmitter Power	FCC Part 95.639 RSS-210 A6.2.4	PASS
Modulation Characteristic	FCC Part 2.1047 FCC Part 95.637 RSS-210 A6.2.2	PASS
Occupied Bandwidth and Emission Mask	FCC Part 2.1049 FCC Part 95.633 FCC Part 95.635 RSS-210 A6.2.3 RSS-210 A6.2.5	PASS
Radiated Spurious Emission	FCC Part 95.635 RSS-201 A6.2.5	PASS
Frequency Stability	FCC Part 2.1055 FCC Part 95.621 FCC Part 95.626 RSS-201 A6.2.6	PASS

1.3. Test Facility

1.3.1 Address of the test laboratory

Shenzhen CTL Testing Technology Co., Ltd.

Floor 1-A, Baisha Technology Park, No. 3011, Shahexi Road, Nanshan, Shenzhen 518055 China

There is one 3m semi-anechoic chamber and two line conducted labs for final test. The Test Sites meet the requirements in documents ANSI C63.4 and CISPR 22/EN 55022 requirements.

1.3.2 Laboratory accreditation

The test facility is recognized, certified, or accredited by the following organizations:

IC Registration No.: 9618B

The 3m alternate test site of Shenzhen CTL Testing Technology Co., Ltd. EMC Laboratory has been registered by Certification and Engineer Bureau of Industry Canada for the performance of with Registration No.: 9618B on November 13, 2013.

FCC-Registration No.: 970318

Shenzhen CTL Testing Technology Co., Ltd. EMC Laboratory has been registered and fully described in a report filed with the (FCC) Federal Communications Commission. The acceptance letter from the FCC is maintained in our files. Registration 970318, December 19, 2013.

1.4. Statement of the measurement uncertainty

The data and results referenced in this document are true and accurate. The reader is cautioned that there may be errors within the calibration limits of the equipment and facilities. The measurement uncertainty was calculated for all measurements listed in this test report acc. to CISPR 16 - 4 „Specification for radio disturbance and immunity measuring apparatus and methods – Part 4: Uncertainty in EMC Measurements“ and is documented in the Shenzhen CTL Testing Technology Co., Ltd. quality system acc. to DIN EN ISO/IEC 17025. Furthermore, component and process variability of devices similar to that tested may result in additional deviation. The manufacturer has the sole responsibility of continued compliance of the device.

Hereafter the best measurement capability for Shenzhen CTL Testing Technology Co., Ltd. is reported

Test Items	Measurement Uncertainty	Notes
Frequency error	25 Hz	(1)
Transmitter power conducted	0.57 dB	(1)
Transmitter power Radiated	2.20 dB	(1)
Adjacent and alternate channel power Conducted	1.20 dB	(1)
Conducted spurious emission 9KHz-12.75 GHz	1.60 dB	(1)
Radiated spurious emission 9KHz-12.75 GHz	2.20 dB	(1)
Intermodulation attenuation	1.00 dB	(1)
Maximum useable receiver sensitivity	2.80 dB	(1)
Co-channel rejection	2.80 dB	(1)
Adjacent channel selectivity	2.80 dB	(1)
Spurious response rejection	2.80 dB	(1)
Intermodulation response rejection	2.80 dB	(1)
Blocking or desensitization	2.80 dB	(1)

- (1) This uncertainty represents an expanded uncertainty expressed at approximately the 95% confidence level using a coverage factor of k=2.

2. GENERAL INFORMATION

2.1. Environmental conditions

During the measurement the environmental conditions were within the listed ranges:

Normal Temperature:	25°C
Relative Humidity:	55 %
Air Pressure:	101 kPa

2.2. General Description of EUT

Name of EUT	Intercom system
Model Number	HY777
Power Supply	DC 5V from adapter
Rate Power	0.5W
Modulation Type	FM
Channel Separation	12.5KHz
Antenna Type	Integral antenna
Antennal Gain	2.0dBi

Note 1: For more details, please refer to the user's manual of the EUT.

2.3. Description of Test Modes and Test Frequency

The EUT has been tested under typical operating condition. As, test modes selected as below by the technical parameters of the EUT:

Operation Mode No.	Modulation	Channel Separation	Condition	
	FM	12.5KHz	TX	RX
1	<input checked="" type="checkbox"/>	<input checked="" type="checkbox"/>	<input checked="" type="checkbox"/>	
2	<input checked="" type="checkbox"/>	<input checked="" type="checkbox"/>		<input checked="" type="checkbox"/>

Frequency list

Channel	Frequency(MHz)	Type
1	462.5625	FRS
2	462.5875	FRS
3	462.6125	FRS
4	462.6375	FRS
5	462.6625	FRS
6	462.6875	FRS
7	462.7125	FRS

Note: The line display in grey were the channel selected for testing

2.4. Measurement Instruments List

Test Equipment	Manufacturer	Model No.	Serial No.	Calibration Date	Calibration Due Date
Bilog Antenna	Sunol Sciences Corp.	JB1	A061713	2016/06/02	2017/06/01
Bilog Antenna	Sunol Sciences Corp.	JB1	A061714	2016/06/02	2017/06/01
EMI Test Receiver	R&S	ESCI	103710	2016/06/02	2017/06/01
Spectrum Analyzer	Agilent	E4407B	MY41440676	2016/05/21	2017/05/20
Spectrum Analyzer	Agilent	N9020	US46220290	2016/01/17	2017/01/16
Controller	EM Electronics	Controller EM 1000	N/A	2016/05/21	2017/05/20
Horn Antenna	Sunol Sciences Corp.	DRH-118	A062013	2016/05/19	2017/05/18
Horn Antenna	Sunol Sciences Corp.	DRH-118	A062014	2016/05/19	2017/05/18
Active Loop Antenna	SCHWARZBEC K	FMZB1519	1519-037	2016/05/19	2017/05/18
Amplifier	Agilent	8349B	3008A02306	2016/05/19	2017/05/18
Amplifier	Agilent	8447D	2944A10176	2016/05/19	2017/05/18
Temperature/Humidity Meter	Gangxing	CTH-608	02	2016/05/20	2017/05/19
Radio Communication Tester	HP	8920A	116250	2016/10/11	2017/10/10
Storage Oscilloscope	Tektronix	TDS3054B	B033027	2016/10/11	2017/10/10
High-Pass Filter	K&L	9SH10-2700/X1 2750-O/O	N/A	2016/05/20	2017/05/19
High-Pass Filter	K&L	41H10-1375/U12 750-O/O	N/A	2016/05/20	2017/05/19
Climate Chamber	ESPEC	EL-10KA	A20120523	2016/05/20	2017/05/19
SIGNAL GENERATOR	Agilent	E4421B	US40051744	2016/05/20	2017/05/19
Directional Coupler	Agilent	87300B	3116A03638	2016/05/20	2017/05/19
Coaxial Cables	HUBER+SUHNER	SUCOFLEX 104PEA-10M	10m	2016/06/02	2017/06/01
Coaxial Cables	HUBER+SUHNER	SUCOFLEX 104PEA-3M	3m	2016/06/02	2017/06/01
Coaxial Cables	HUBER+SUHNER	SUCOFLEX 104PEA-3M	3m	2016/06/02	2017/06/01
RF Cable	Megalon	RF-A303	N/A	2016/06/02	2017/06/01

The Cal. Interval was one year

2.5. Related Submittal(s) / Grant(s)

This submittal(s) (test report) is intended to comply with FCC Part 95 Rules.

2.6. Modifications

No modifications were implemented to meet testing criteria.

3. TEST CONDITIONS AND RESULTS

3.1. Maximum Transmitter Power

LIMITS

According to FCC Part 95.639:

No FRS unit, under any condition of modulation, shall exceed 0.500 W effective radiated power (ERP).

No GMRS transmitter, under any condition of modulation, shall exceed:

1. 50 W Carrier power (average TP during one unmodulated RF cycle) when transmitting emission type A1D, F1D, G1D, A3E, F3E or G3E.
2. 50 W peak envelope TP when transmitting emission type H1D, J1D, R1D, H3E, J3E or R3E.

According to RSS-210 A6.1.4:

For FRS transmitter the maximum permissible transmitter output power under any operating conditions is 0.5 W effective radiated power(e.r.p.). The radio shall be equipped with an integral antenna.

According to RSS-210 A6.2.4:

A GMRS transmitter may transmit with a maximum power of 2 W e.r.p.

TEST CONFIGURATION

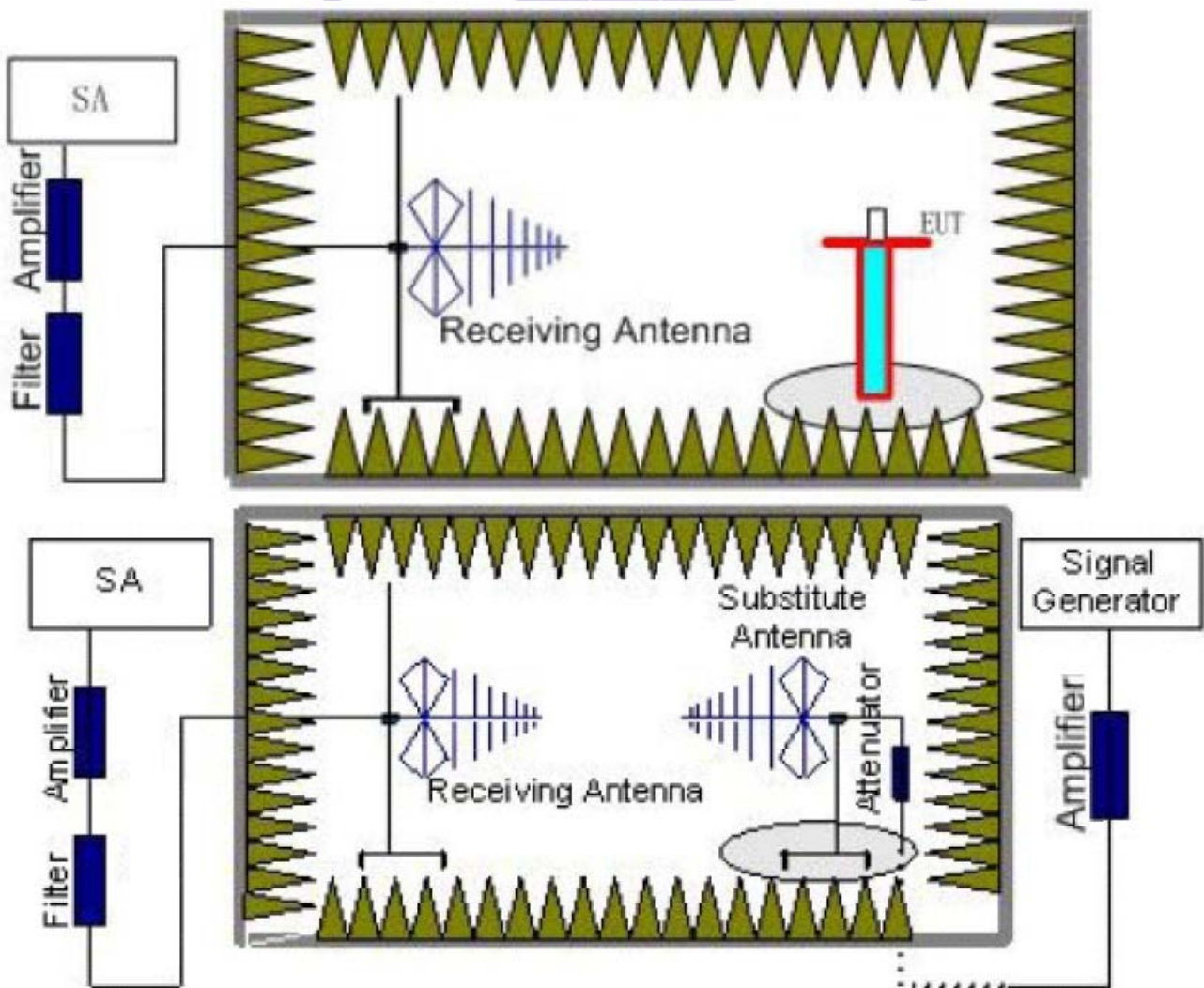

Measurement Procedure

1. EUT was placed on a 0.8 meter high non-conductive stand at a 3 meter test distance from the receive antenna. A receiving antenna was placed on the antenna mast 3 meters from the EUT for emission measurements. The height of receiving antenna is 1.0m. Detected emissions were maximized at each frequency by rotating the EUT through 360° and adjusting the receiving antenna polarization. The radiated emission measurements of all test transmit frequencies were measured with peak detector.
2. A log-periodic antenna or double-ridged waveguide horn antenna shall be substituted in place of the EUT. The log-periodic antenna will be driven by a signal generator and the level will be adjusted till the same power value on the spectrum analyzer or receiver. The level of the spurious emissions can be calculated through the level of the signal generator, cable loss, the gain of the substitution antenna and the reading of the spectrum analyzer or receiver.
3. The EUT is then put into continuously transmitting mode at its maximum power level during the test. Set Test Receiver or Spectrum RBW=1MHz, VBW=3MHz, And the maximum value of the receiver should be recorded as (P_r).
4. The EUT shall be replaced by a substitution antenna. In the chamber, an substitution antenna for the frequency band of interest is placed at the reference point of the chamber. An RF Signal source for the frequency band of interest is connected to the substitution antenna with a cable that has been constructed to not interfere with the radiation pattern of the antenna. A power (P_{Mea}) is applied to the input of the substitution antenna, and adjust the level of the signal generator output until the value of the receiver reach the previously recorded (P_r). The power of signal source (P_{Mea}) is recorded. The test should be performed by rotating the test item and adjusting the receiving antenna polarization.
5. An amplifier may be connected to the Signal Source output port. And the cable should be connect between the Amplifier and the Substitution Antenna. The cable loss (P_{cl}), the Substitution Antenna Gain (G_a) and the Amplifier Gain (P_{Ag}) should be recorded after test. The measurement results are obtained as described below:
Power(EIRP)= $P_{Mea}+P_{Ag}-P_{cl}+G_a$
6. This value is EIRP since the measurement is calibrated using an antenna of known gain (2.15 dBi) and known input power.
7. ERP can be calculated from EIRP by subtracting the gain of the dipole, $ERP = EIRP-2.15dBi$.

TEST RESULTS

Remark;

The field strength of radiation emission was measured in the following position: EUT stand-up position (Z axis), lie-down position (X, Y axis). The data show in this report only with the worst case setup. After exploratory measurement the worst case of Z axis and receiver antenna at vertical polarization was reported.

Test Frequency (MHz)	P _{Mea} (dBm)	P _{cl} (dB)	G _a Antenna Gain(dBi)	Correction (dB)	P _{Ag} (dB)	ERP (dBm)	ERP (W)	Limit (W)	Polarization
462.6375	-11.20	2.08	7.69	2.15	34.59	26.85	0.4842	0.5W	V

Remark:

1. $EIRP = P_{Mea}(dBm) + P_{Ag}(dB) - P_{cl}(dB) + G_a(dBi)$
2. $ERP = EIRP - 2.15dBi$ as EIRP by subtracting the gain of the dipole.



3.2. Occupied Bandwidth and Emission Mask

LIMITS

According to FCC 95.633 & RSS-210 A6.1.3, A6.2.3:

For GMRS: the authorized bandwidth for emission type A1D or A3E is 8 KHz, The authorized bandwidth for emission type F1D, G1D, F3E or G3E is 20 KHz.

For FRS: the authorized bandwidth for emission type F3E or F2D is 12.5 KHz

According to FCC 95.635 & RSS-210 A6.1.5, A6.2.5:

At least 25dB (decibels) on any frequency removed from the center of the authorized bandwidth by more than 50 % up to and including 100 % of the authorized bandwidth.

At least 35 dB on any frequency removed from the center of the authorized bandwidth by more than 100 % up to and including 250 % of the authorized bandwidth.

At least $43 + 10 \log_{10}(T)$ dB on any frequency removed from the center of the authorized bandwidth by more than 250 %.

TEST CONFIGURATION

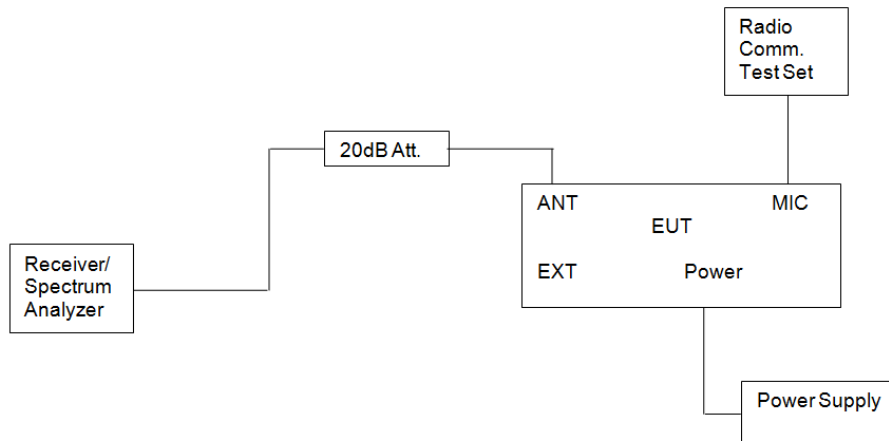

TEST PROCEDURE

- 1 The EUT was modulated by 2.5 KHz Sine wave audio signal; the level of the audio signal employed is 16 dB greater than that necessary to produce 50% of rated system deviation. Rated system deviation is 2.5 kHz (12.5 kHz channel spacing) and 5 kHz (25 kHz channel spacing).
- 2 Set SPA Center Frequency = fundamental frequency, RBW=300Hz, VBW= 3 KHz, span =50 KHz.
- 3 Set SPA Max hold. Mark peak, Set 99% Occupied Bandwidth and 26dB Occupied Bandwidth.

TEST RESULTS

Occupied Bandwidth:

Modulation	Frequency (MHz)	99% OBW (kHz)	26dB bandwidth (kHz)	Limit (KHz)	Result
FM	462.6375	9.80	10.40	12.5	Pass

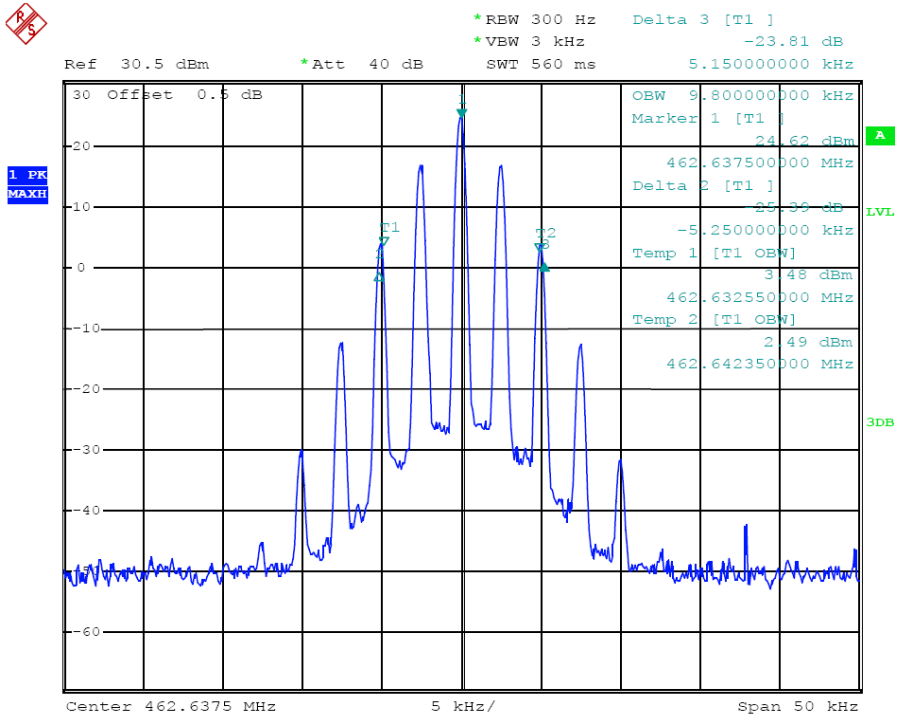

Emission Mask:

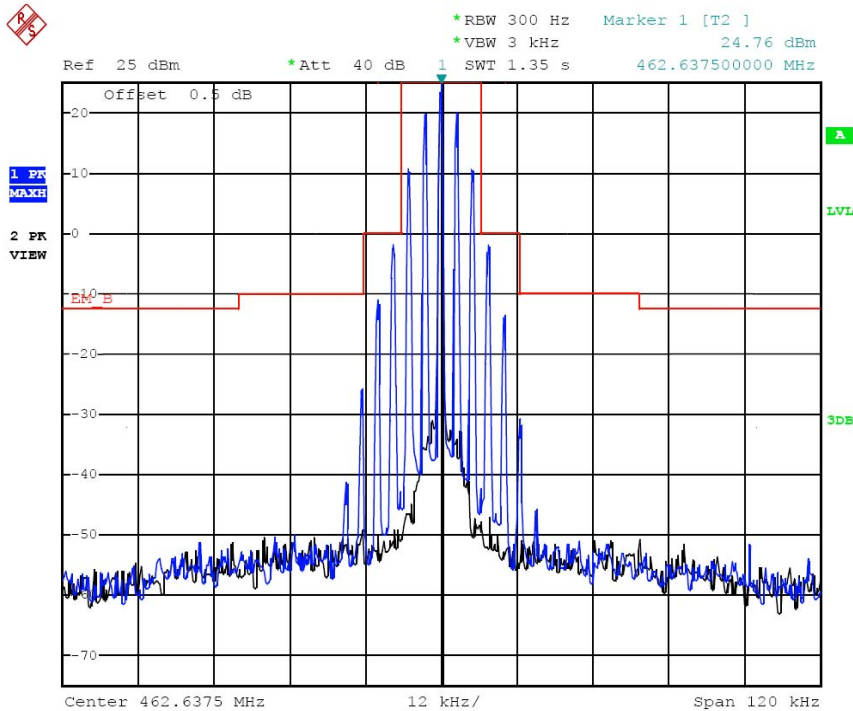

3.3. Modulation Characteristic

TEST APPLICABLE

According to CFR47 section 2.1047(a), for Voice Modulation Communication Equipment, the frequency response of the audio modulation circuit over a range of 100 to 5000Hz shall be measured.

TEST PROCEDURE

Modulation Limit

- 1 Configure the EUT as shown in figure 1, adjust the audio input for 60% of rated system deviation at 1 KHz using this level as a reference (0dB) and vary the input level from -20 to +20dB. Record the frequency deviation obtained as a function of the input level.
- 2 Repeat step 1 with input frequency changing to 300, 1004, 1500 and 2500Hz in sequence.

Audio Frequency Response

- 1 Configure the EUT as shown in figure 1.
- 2 Adjust the audio input for 20% of rated system deviation at 1 KHz using this level as a reference (0dB).
- 3 Vary the Audio frequency from 100 Hz to 3 KHz and record the frequency deviation.
- 4 Audio Frequency Response = $20\log_{10} (\text{Deviation of test frequency} / \text{Deviation of 1 KHz reference})$.

TEST CONFIGURATION

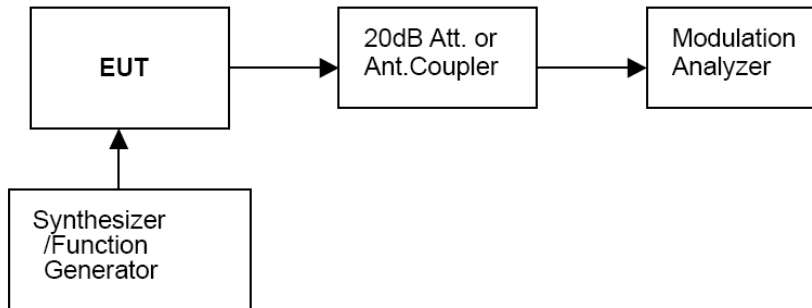

TEST RESULTS

Modulation Limit:

Modulation Level(dB)	Peak Freq. Deviation At 300 Hz(KHz)	Peak Freq. Deviation At 1004 Hz(KHz)	Peak Freq. Deviation At 1500 Hz(KHz)	Peak Freq. Deviation At 2500 Hz(KHz)
-20	0.08	0.19	0.26	0.4
-15	0.11	0.30	0.44	0.68
-10	0.18	0.51	0.76	1.19
-5	0.29	0.88	1.33	1.77
0	0.48	1.52	1.87	1.92
+5	0.74	1.83	1.92	2.01
+10	0.79	1.85	1.94	2.12
+15	0.8	1.85	1.94	2.14
+20	0.87	1.86	1.94	2.13

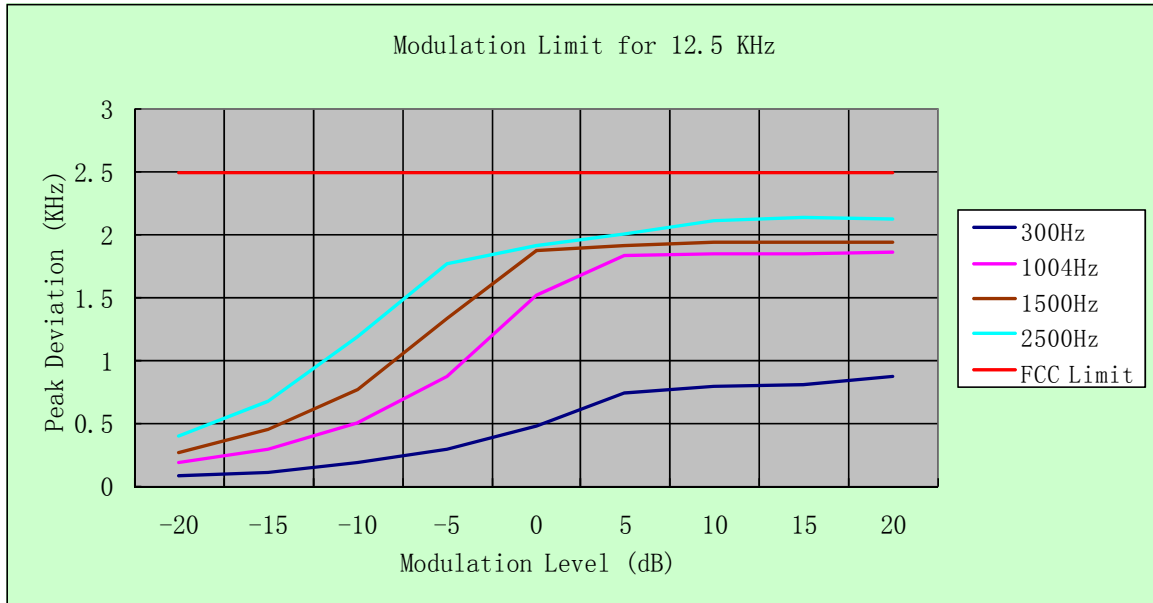

Audio Frequency Response:

Frequency (KHz)	Frequency Deviation (KHz)	1KHz Reference Deviation (KHz)	Audio Frequency Response (dB)
0.1	0.10	0.70	-16.90
0.2	0.12	0.70	-15.32
0.3	0.13	0.70	-14.62
0.4	0.14	0.70	-13.98
0.5	0.35	0.70	-6.02
0.6	0.40	0.70	-4.86
0.7	0.45	0.70	-3.84
0.8	0.50	0.70	-2.92
0.9	0.51	0.70	-2.75
1.0	0.70	0.70	0.00
1.2	0.79	0.70	1.05
1.4	0.93	0.70	2.47
1.6	1.04	0.70	3.44
1.8	1.09	0.70	3.85
2.0	1.21	0.70	4.75
2.2	1.29	0.70	5.31
2.4	1.37	0.70	5.83
2.6	1.41	0.70	6.08
2.7	1.49	0.70	6.56
2.8	1.58	0.70	7.07
3.0	1.57	0.70	7.02
3.5	0.05	0.70	-22.92
4.0	0.05	0.70	-22.92
4.5	0.04	0.70	-24.86
5.0	0.03	0.70	-27.36

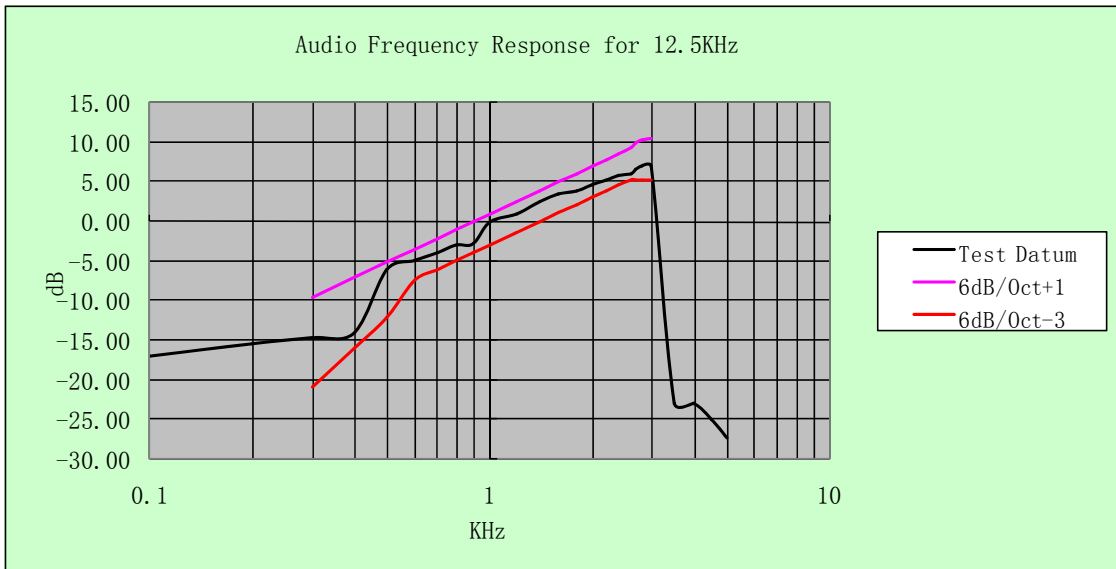

3.4. Frequency Stability

LIMITS

According to FCC 95.621(b)

Each GMRS transmitter for mobile station, small base station and control station operation must be maintained within a frequency tolerance of 0.0005%. Each GMRS transmitter for base station (except small base), mobile relay station or fixed station operation must be maintained within a frequency tolerance of 0.00025%.

According to FCC 95.627(b)

Each FRS unit must be maintained within a frequency tolerance of 0.00025%.

According to RSS-210 A6.1.6

FRS Devices: Carrier frequency tolerance shall be better than ± 5 ppm

According to RSS-210 A6.2.6

GMRS Devices: Carrier frequency tolerance shall be better than ± 5 ppm

TEST CONFIGURATION

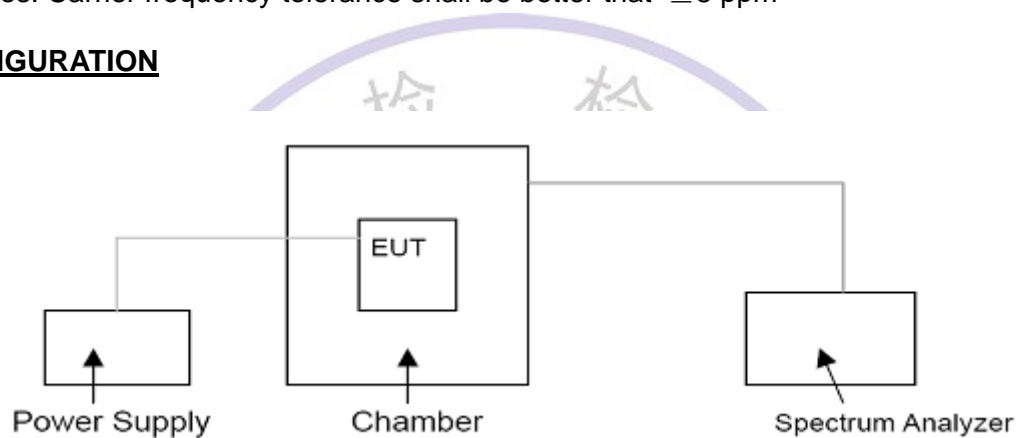

TEST PROCEDURE

The EUT was set in the climate chamber and connected to an external DC power supply. The RF output was directly connected to Spectrum Analyzer. The coupling loss of the additional cables was recorded and taken in account for all the measurements. After temperature stabilization (approx. 20 min for each stage), the frequency for the lower, the middle and the highest frequency range was recorded. For Frequency stability Vs. Voltage the EUT was connected to a DC power supply and the voltage was adjusted in the required ranges. The result was recorded.

TEST RESULTS

Reference Frequency: 462.6375MHz					
Voltage (V)	Temperature (°C)	Frequency error (Hz)	Frequency Tolerance (%)	Limit (%)	Result
5.00	-30	624	0.00013	0.00025%	Pass
	-20	515	0.00011		
	-10	612	0.00013		
	0	552	0.00012		
	10	523	0.00011		
	20	469	0.00010		
	30	588	0.00013		
	40	601	0.00013		
	50	579	0.00013		
5.75	25	687	0.00015		
4.25	25	635	0.00014		

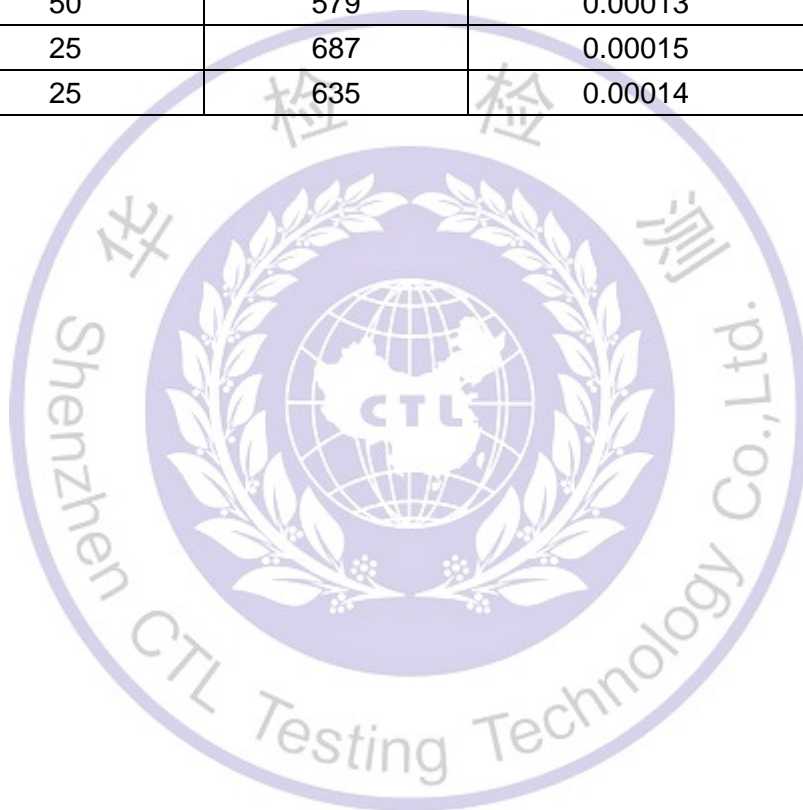

3.5. Transmitter Radiated Spurious Emission

Limit

The unwanted emission should be attenuated below TP by at least $43+10\log(\text{Transmit Power})$ dB and unwanted emissions falling within the restricted bands of RSS-Gen shall be attenuated to the limits provided in this section or to the general field strength limits shown in RSS-Gen, whichever are less stringent.

TEST CONFIGURATION

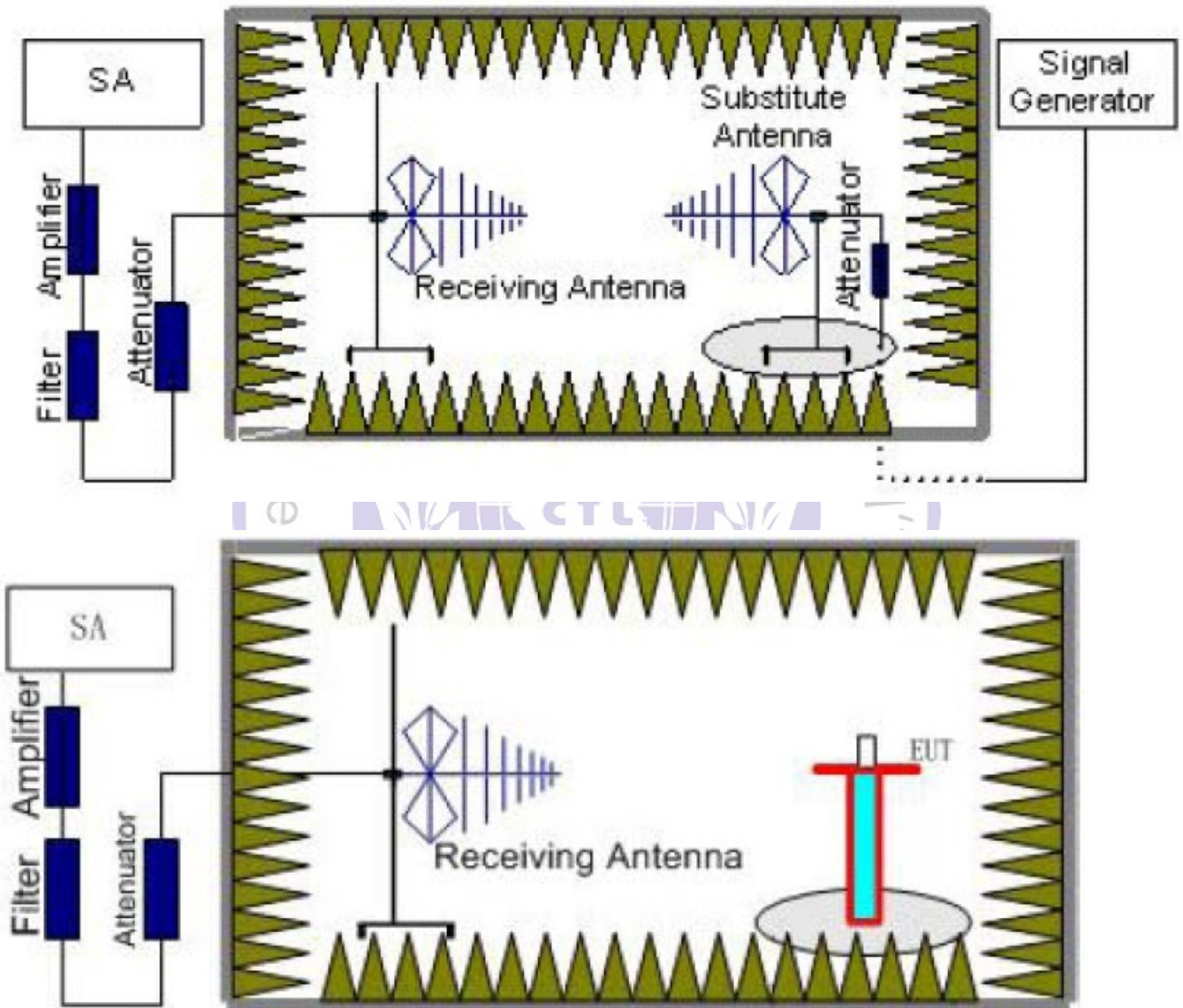

TEST PROCEDURE

- a. EUT was placed on a 0.8 meter high non-conductive stand at a 3 meter test distance from the receive antenna. A receiving antenna was placed on the antenna mast 3 meters from the EUT for emission measurements. The height of receiving antenna is 1.0m. Detected emissions were maximized at each frequency by rotating the EUT through 360° and adjusting the receiving antenna polarization. The radiated emission measurements of all test transmit frequencies were measured with peak detector.
- b. A log-periodic antenna or double-ridged waveguide horn antenna shall be substituted in place of the EUT. The log-periodic antenna will be driven by a signal generator and the level will be adjusted till the same power value on the spectrum analyzer or receiver. The level of the spurious emissions can be calculated through the level of the signal generator, cable loss, the gain of the substitution antenna and the reading of the spectrum analyzer or receiver.
- c. The EUT is then put into continuously transmitting mode at its maximum power level during the test. Set Test Receiver or Spectrum 100 kHz below 1GHz and 1MHz above 1GHz, Sweep from 30MHz to the 10th harmonic of the fundamental frequency; and recorded the level of the concerned spurious emission point as (P_r).
- d. The EUT then replaced by a substitution antenna. In the chamber, an substitution antenna for the frequency band of interest is placed at the reference point of the chamber. An RF Signal source for the frequency band of interest is connected to the substitution antenna with a cable that has been constructed to not interfere with the radiation pattern of the antenna. A power (P_{Mea}) is applied to the input of the substitution antenna, and adjust the level of the signal generator output until the value of the receiver reach the previously recorded (P_r). The power of signal source (P_{Mea}) is recorded. The test should be performed by rotating the test item and adjusting the receiving antenna polarization. The measurement results are obtained as described below:

$$\text{Power}_{(EIRP)} = P_{Mea} - P_{cl} + G_a$$

Where;

- P_{Mea} is the recorded signal generator level
- P_{cl} is the cable loss connect between instruments
- G_a Substitution Antenna Gain

- e. This value is EIRP since the measurement is calibrated using an antenna of known gain (2.15 dBi) and known input power.
- f. ERP can be calculated from EIRP by subtracting the gain of the dipole, $ERP = EIRP - 2.15\text{dBi}$.
- g. Test site anechoic chamber refer to ANSI C63.

TEST RESULTS

Remark: The measurement frequency range is from 30MHz to the 10th harmonic of the fundamental frequency; and worst spurious emissions recorded as below:

Test Frequency (MHz)	Frequency (MHz)	P _{Mea} (dBm)	P _{cl} (dB)	Distance (m)	G _a Antenna Gain(dBi)	Peak EIRP (dBm)	Limit (dBm)	Margin (dB)	Pol.
462.6375	925.50	-27.58	3.54	3.00	12.87	-18.25	-13.00	5.25	V
	1387.75	-32.79	4.21	3.00	15.48	-21.52	-13.00	8.52	V
	1850.25	-37.13	4.52	3.00	17.32	-24.33	-13.00	11.33	V
	2313.50	-42.50	5.24	3.00	18.76	-28.98	-13.00	15.98	V
	--	--	--	--	--	--	--	--	--

Remark:

1. $EIRP = P_{Mea}(dBm) - P_{cl}(dB) + G_a(dBi)$
2. -- Means other points for values lower than limits and not recorded.
3. $Margin = Limit - EIRP$



4. Test Setup Photos of the EUT

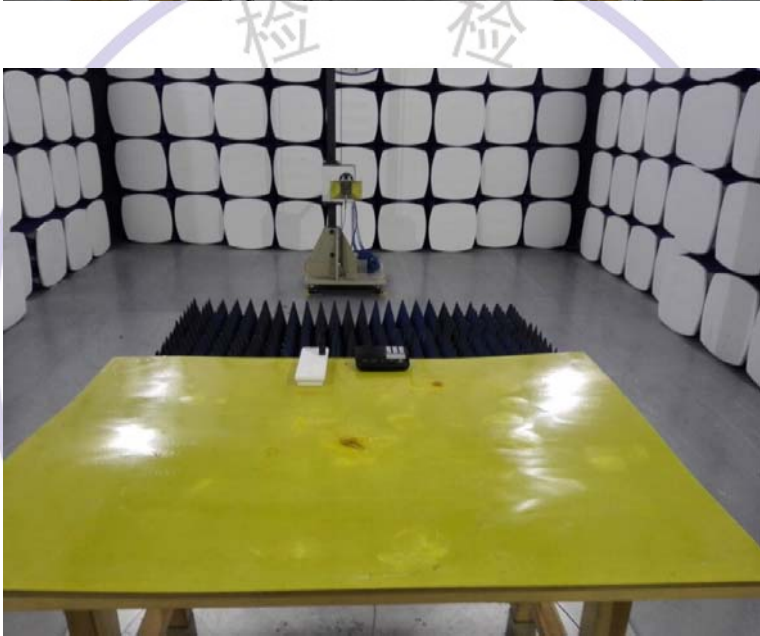
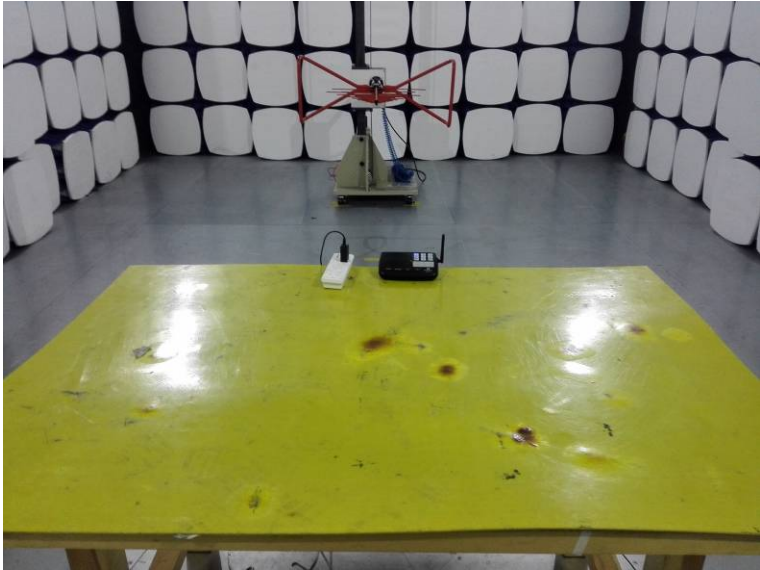

检 验

Testing Tech

5. External and Internal Photos of the EUT

External Photos of EUT







Internal Photos of EUT

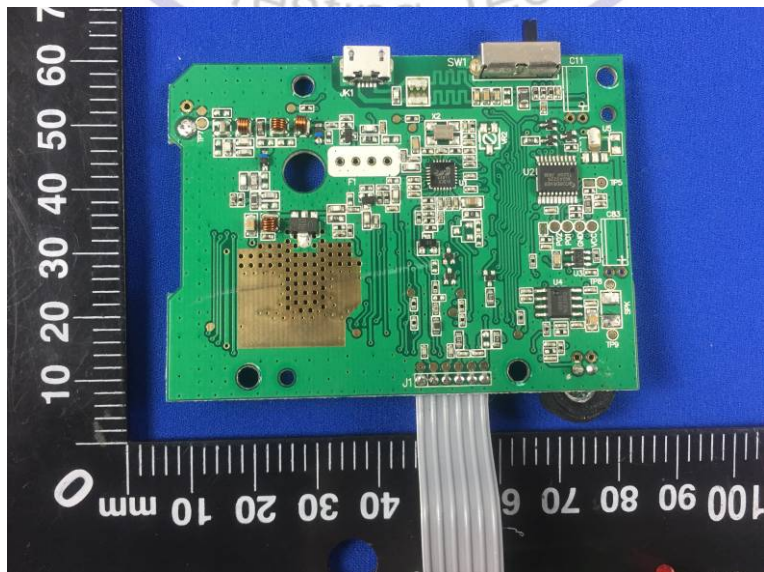
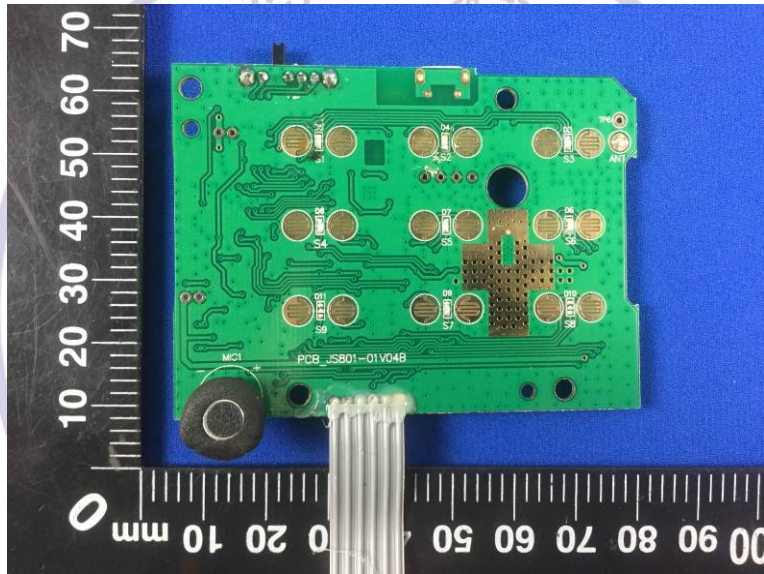

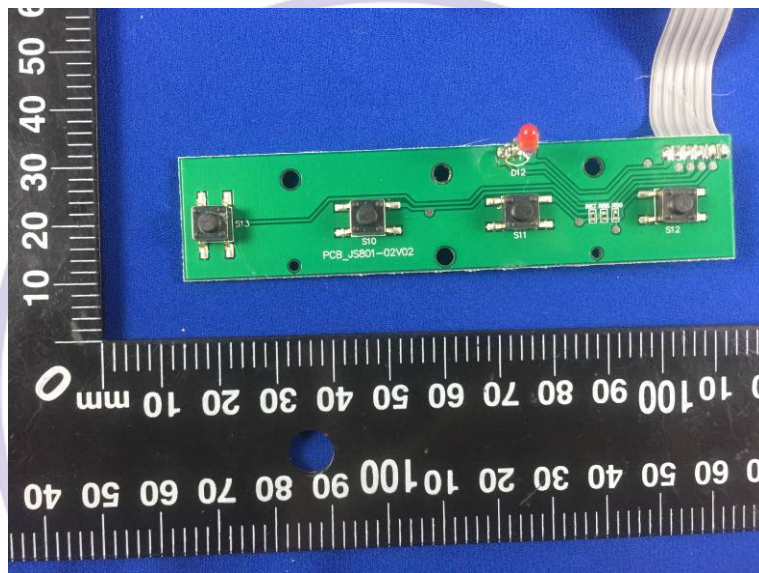
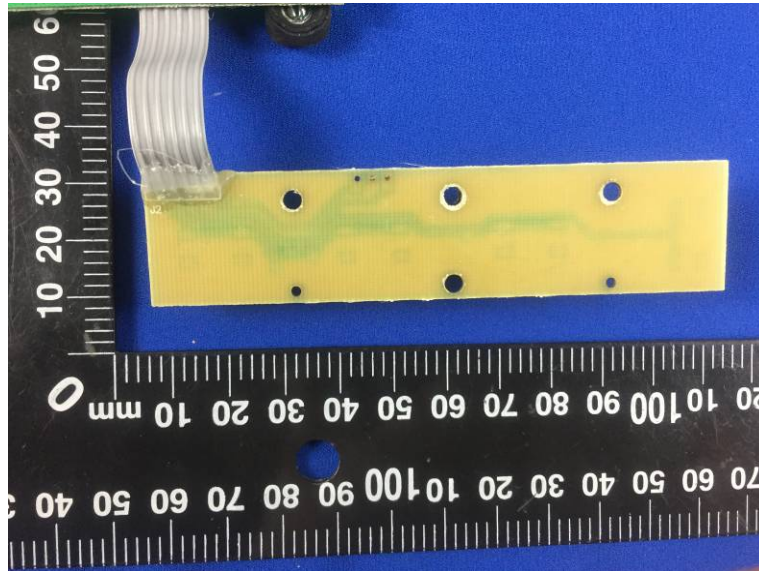

***** End of Report *****

