

# NFC Reader/Writer Operation Manual



EXW1-NT1

P/N: CIR315C-01



FCC ID: 2AJE7SMC-WEX06

IC ID: 21344-WEX06

CAN ICES-3 (B)/NMB-3(B)

U.S.

Canada



IFETEL:xxx-xxx

Mexico



Brazil



H - 26043

Argentina



Europe



UK



Russia



UA.TR.YYY

Ukraine



South Africa

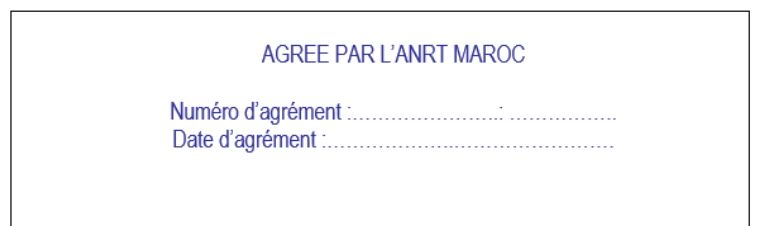

Morocco



Australia Newzealand

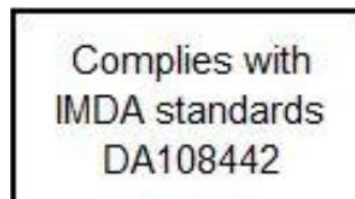

Singapore



Malaysia

[ Nomor Sertifikat ]  
[ Nomor PLG ID ]

Indonesia

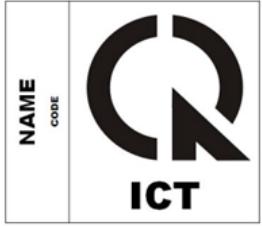

Vietnam



R-R-OZK-NT1

EXW1-NT1 Made in China  
Korea



総務省指定  
第 AC-20094 号

Japan



CCXX20XXXXXXXXX

Taiwan

Thank you for purchasing an SMC NFC Reader/Writer for SMC wireless system.  
Please read this manual carefully before operating the product and make sure you understand its capabilities and limitations.  
Please keep this manual handy for future reference.

**To obtain the operation manual about this product,  
please refer to the SMC website  
(URL <https://www.smcworld.com>) or contact SMC directly.**

## Safety Instructions

These safety instructions are intended to prevent hazardous situations and/or equipment damage. These instructions indicate the level of potential hazard with the labels of "Caution", "Warning" or "Danger". They are all important notes for safety and must be followed in addition to International standards (ISO/IEC) and other safety regulations.



### **Caution:**

CAUTION indicates a hazard with a low level of risk which, if not avoided, could result in minor or moderate injury.



### **Warning:**

WARNING indicates a hazard with a medium level of risk which, if not avoided, could result in death or serious injury.



### **Danger:**

DANGER indicates a hazard with a high level of risk which, if not avoided, will result in death or serious injury.

## Operator

- ◆The operation manual is intended for those who have knowledge of machinery using pneumatic equipment, and have sufficient knowledge of assembly, operation and maintenance of such equipment. Only those persons are allowed to perform assembly, operation and maintenance.
- ◆Read and understand the operation manual carefully before assembling, operating or providing maintenance to the product.

## ■ Safety Instructions

### **Warning**

■ **Do not disassemble, modify (including changing the printed circuit board) or repair.**

An injury or failure can result.

■ **Do not operate the product outside of the specifications.**

Do not use for flammable or harmful fluids.

Fire, malfunction, or damage to the product can result.

Verify the specifications before use.

■ **Do not operate in an atmosphere containing flammable or explosive gases.**

Fire or an explosion can result.

This product is not designed to be explosion proof.

■ **The following instructions must be followed during maintenance:**

• **Turn off the power supply.**

• **Stop the air supply, exhaust the residual pressure and verify that the air is released before performing maintenance.**

Otherwise an injury can result.

### **Caution**

■ **Make sure not to spill liquid on the product, use a wet card, or let metal or flammable substance into the product. Otherwise, it may cause fire, electric shock, malfunction, or other accidents.**

■ **If foreign matter has entered into the product or smoke comes out, remove the product from the PC or other connected device immediately.**

■ **After maintenance is complete, perform appropriate functional inspections.**

Stop operation if the equipment does not function properly.

Safety cannot be assured in the case of unexpected malfunction.

## Limited warranty and Disclaimer

- 1. The warranty period of the product is 1 year in service or 1.5 years after the product is delivered, whichever is first.\*2)**
- 2. For any failure or damage reported within the warranty period which is clearly our responsibility, a replacement product or necessary parts will be provided.  
This limited warranty applies only to our product independently, and not to any other damage incurred due to the failure of the product.**
- 3. Prior to using SMC products, please read and understand the warranty terms and disclaimers noted in the specified catalog for the particular products.**

■ **Important**

● This product communicates using radio waves, and the communication may stop instantaneously due to the ambient environment and operating methods. SMC will not be responsible for any secondary failure which may cause an accident or cause damage to other devices or equipment.

■Precautions for connecting the USB terminal of the NFC reader / writer

●Use the USB terminal at the back of the product for connecting the PC for the NFC reader / writer. Do not use the USB terminal on the front of the product.

\* It has been reported that the operation becomes unstable when the USB terminal on the side or the front of the PC is used depending on the type of the PC.

●Use a hub with power adapter when a USB hub is used.

■Upgrade of the firmware

●The firmware of the EXW1-NT1 may need to be upgraded depending on the OS and IC card. Refer to the SMC website for further details.

■Precaution for static electricity

●When the air is dry such as at wintertime, a large amount of static electricity is generated in the human body, etc., and it will be applied to the product, which may cause malfunction or operation failure. Before using the product, discharge static electricity from the human body, IC card, etc.

# Maintenance

●Disconnect the NFC reader / writer from the connection port before maintenance.

●Clean the product with a dry cloth.

●Do not use chemicals such as alcohol or glass cleaner.

This may cause discoloration or change the properties.

■Handling Precautions

●The read/write function may not function properly depending on the operating environment. In that case, remove and then insert the USB cable.

●Use of scan targets (cards) for the NFC reader/writer is the responsibility of the user.

●It may not function properly on a desk made of metal, such as iron.

●If multiple scan targets (cards) are set, this product does not function properly.

●Do not apply excessive shock to the product, such as dropping or hitting the product or pulling the cable with force.

●SMC accepts no responsibility whatsoever for any damage or loss resulting from data loss or corruption during the use of this product.

This device is class B information technology equipment. Although this device is for use in a home environment, using this device near a radio or television may cause poor reception. Follow the operation manual to handle the product correctly. VCCI-B

This product is a designated specified induction type read/write communication system based on the Radio Act. The frequency used is the 13.56 MHz band. Modifying and disassembling this product and erasing the model number on the back of this product are punishable by law. To use multiple NFC readers/writers close to one another, leave a one-meter space or more between them. In addition, make sure that there is no other wireless equipment around that uses the same frequency band before using this product.

## **FEDERAL COMMUNICATIONS COMMISSION INTERFERENCE STATEMENT**

This equipment has been tested and found to comply with the limits for a Class B digital device, pursuant to part 15 of the FCC Rules. These limits are designed to provide reasonable protection against harmful interference in a residential installation. This equipment generates, uses and can radiate radio frequency energy and, if not installed and used in accordance with the instructions, may cause harmful interference to radio communications. However, there is no guarantee that interference will not occur in a particular installation. If this equipment does cause harmful interference to radio or television reception, which can be determined by turning the equipment off and on, the user is encouraged to try to correct the interference by one or more of the following measures:

- Reorient or relocate the receiving antenna.
- Increase the separation between the equipment and receiver.
- Connect the equipment into an outlet on a circuit different from that to which the receiver is connected.
- Consult the dealer or an experienced radio/ TV technician for help.

### **CAUTION:**

Any changes or modifications not expressly approved by the grantee of this device could void the user's authority to operate the equipment.

This device complies with Part 15 of the FCC Rules. Operation is subject to the following two conditions:

- (1) this device may not cause harmful interference, and
- (2) this device must accept any interference received, including interference that may cause undesired operation.

### **RF exposure warning**

This equipment must be installed and operated in accordance with provided instructions and the antenna(s) used for this transmitter must be installed to provide a separation distance of at least 20 cm from all persons and must not be co-located or operating in conjunction with any other antenna or transmitter. End-users and installers must be provided with antenna installation instructions and transmitter operating conditions for satisfying RF exposure compliance.

### **Canada, Industry Canada (IC) Notices**

This device complies with Canada licence-exempt RSS standard(s).

Operation is subject to the following two conditions:

- (1) this device may not cause interference, and
- (2) this device must accept any interference, including interference that may cause undesired operation of the device.

### **Canada, avis d'Industrie Canada (IC)**

Cet appareil est conforme avec Industrie Canada exemptes de licence RSS standard(s).

Son fonctionnement est soumis aux deux conditions suivantes :

- (1) cet appareil ne doit pas causer d'interférence et
- (2) cet appareil doit accepter toute interférence, notamment les interférences qui peuvent affecter son fonctionnement.

### **Radio Frequency (RF) Exposure Information**

The radiated output power of the Wireless Device is below the Industry Canada (IC) radio frequency exposure limits. The Wireless Device should be used in such a manner such that the potential for human contact during normal operation is minimized.

This device has also been evaluated and shown compliant with the IC RF Exposure limits under mobile exposure conditions. (antennas are greater than 20cm from a person's body).

**Informations concernant l'exposition aux fréquences radio (RF)**

La puissance de sortie émise par l'appareil de sans fil est inférieure à la limite d'exposition aux fréquences radio d'Industry Canada (IC). Utilisez l'appareil de sans fil de façon à minimiser les contacts humains lors du fonctionnement normal.

Ce périphérique a également été évalué et démontré conforme aux limites d'exposition aux RF d'IC dans des conditions d'exposition à des appareils mobiles (antennes sont supérieures à 20 cm à partir du corps d'une personne).

When product comply with IFETEL inquire below warning statement has to be contained in user manual.

*La operación de este equipo está sujeta a las siguientes dos condiciones:*

*(1) es posible que este equipo o dispositivo no cause interferencia perjudicial y*

*(2) este equipo o dispositivo debe aceptar cualquier interferencia, incluyendo la que pueda causar su operación no deseada.*

Este equipamento opera em caráter secundário, isto é, não tem direito a proteção contra interferência prejudicial, mesmo de estações do mesmo tipo, e não pode causar interferência a sistemas operando em caráter primário.



**Para maiores informações, consulte o site da ANATEL – [www.anatel.gov.br](http://www.anatel.gov.br)**

Este equipamento não tem direito à proteção contra interferência prejudicial e não pode causar interferência em sistemas devidamente autorizados

取得審驗證明之低功率射頻器材，非經核准，公司、商號或使用者均不得擅自變更頻率、加大功率或變更原設計之特性及功能。低功率射頻器材之使用不得影響飛航安全及干擾合法通信；經發現有干擾現象時，應立即停用，並改善至無干擾時方得繼續使用。前述合法通信，指依電信管理法規定作業之無線電通信。低功率射頻器材須忍受合法通信或工業、科學及醫療用電波輻射性電機設備之干擾。

เครื่องโทรคมนาคมและอุปกรณ์นี้มีความสอดคล้องตามมาตรฐานหรือข้อกำหนดทางเทคนิคของ กสทช.

## Contents of package

Description	Qty.
 NFC Reader/Writer	1
 USB extension cable (2.95 m)	1
 Operation Manual (this document)	1

## Downloading and Installation of the driver software

Windows OS has a general-purpose NFC reader/writer driver software installed. However, for the use of the SMC NFC reader / writer, please install the driver software in accordance with the procedure described in this document and operation manual before use.

# Downloading and installation of the driver software

### • Downloading of the driver software

Obtain the driver software of the NFC reader/writer from the SMC website. On the SMC website (<http://www.smcworld.com>), select [Documents/Download] and click [Instruction Manuals].

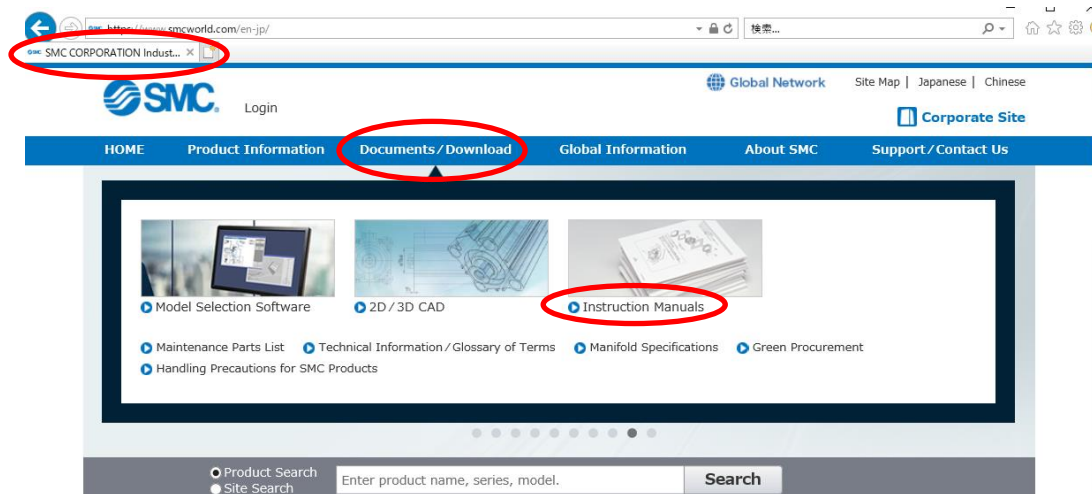

On the product search form of [Instruction Manuals], type "EXW1-NT" to search.

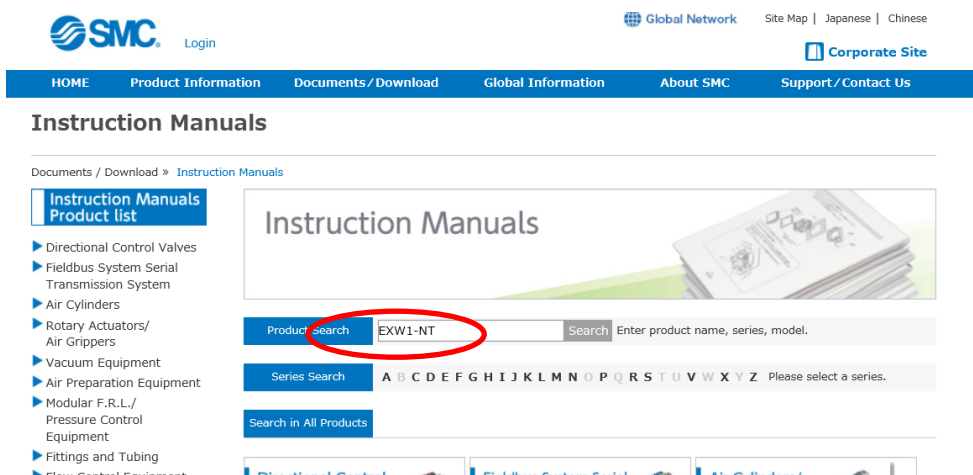



● **Installation of the driver software**

○ Windows 8.1 / Windows 10

When the PC is connected to the Internet, the driver software is automatically installed.

Install the driver software again following the steps below.

The Windows OS starts installation of the driver by connecting the EXW1-NT1 to the USB port of the PC.

(1) Windows 8.1 / 10 displays the identified devices in the task bar at the bottom of the screen.

The icon in the red circle automatically disappears when the installation of the driver software is complete.



(2) The display below appears in the Device Manager while the EXW1-NT1 is connected to the PC and is operating correctly.

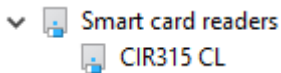

[Display of the Device Manager is incorrect]

When an exclamation mark (!) is attached to the CIR315 CL is displayed in “other device in the Device Manager”, follow the steps below.

- Right-click on the CIR315 CL, and then left-click on “driver update”.

- When the screen “start hardware update wizard ” appears, select “yes, connect only this time”, and then click “Next”.

(3) Click “automatic search for the latest driver software” for “how to search the driver software?”.

(4) When the installation does not complete successfully, take the following steps.

• Installation does not start automatically.

- (1) Download the driver software and manual referring to “Downloading of the driver software”.
- (2) Select language and press the “OK” button.

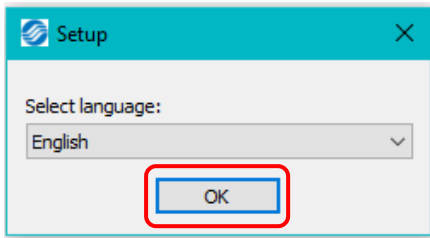

(3) Screen below appears. Press the “Next (N)” button.

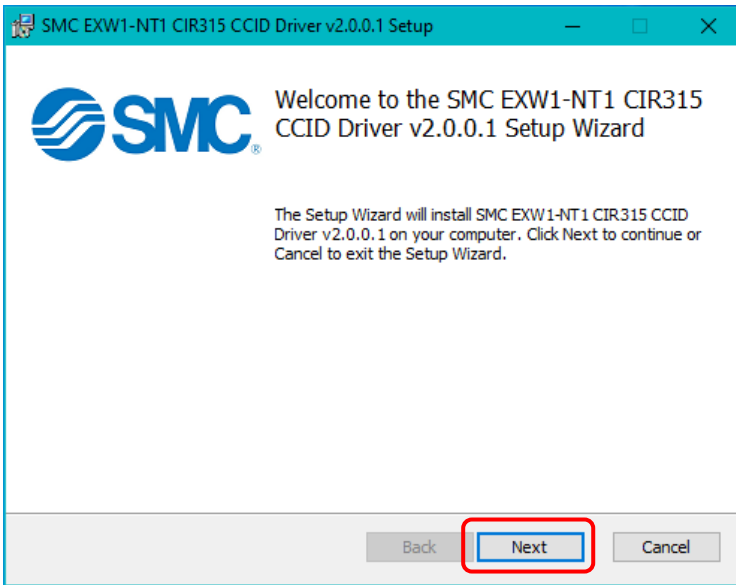

(4) Screen below appears. Press the “Next (N)” button.

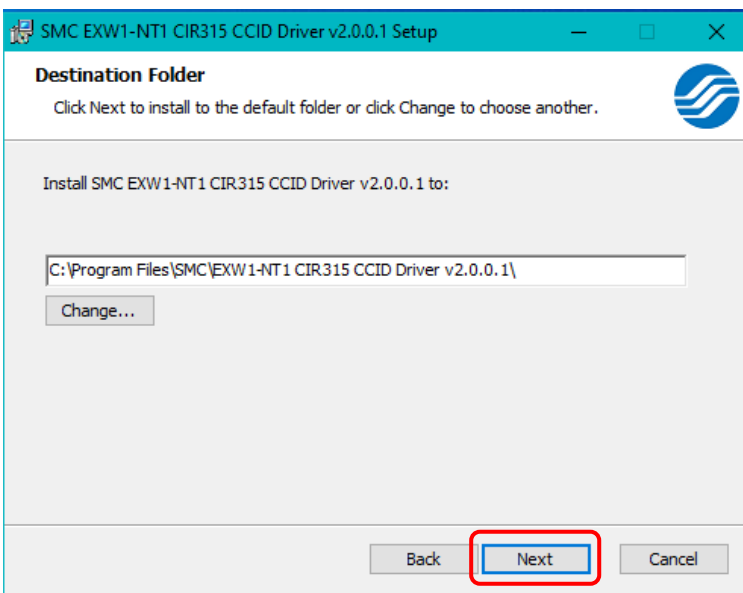

(5) Screen below appears. Press the “Install (I)” button.

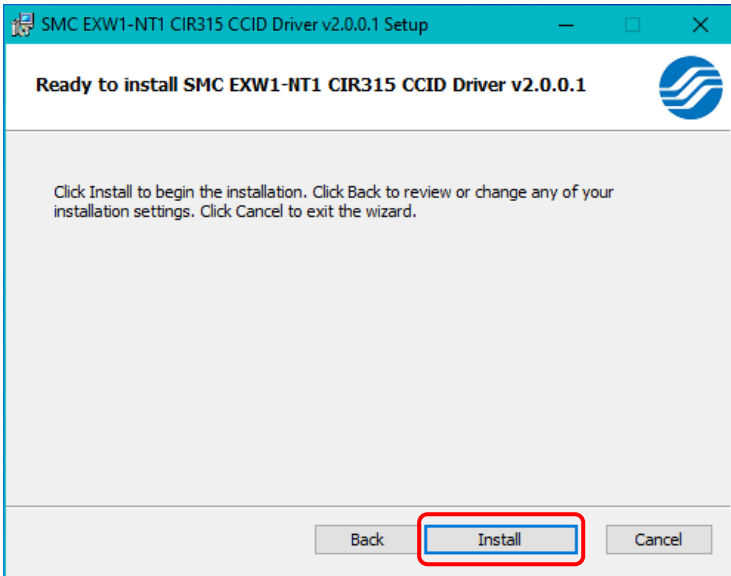

(6) The screen below appears and installation starts. Please wait.

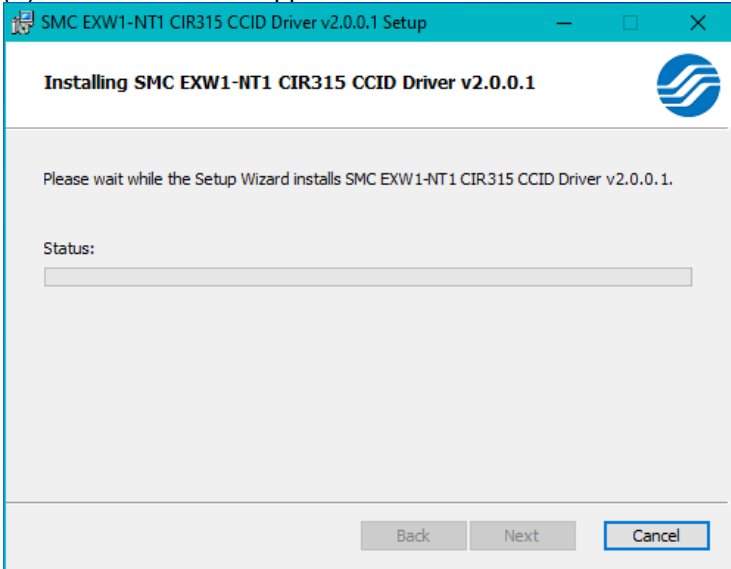

(7) The screen below appears when the installation is complete. Press the 「 Finish (F)」 button.

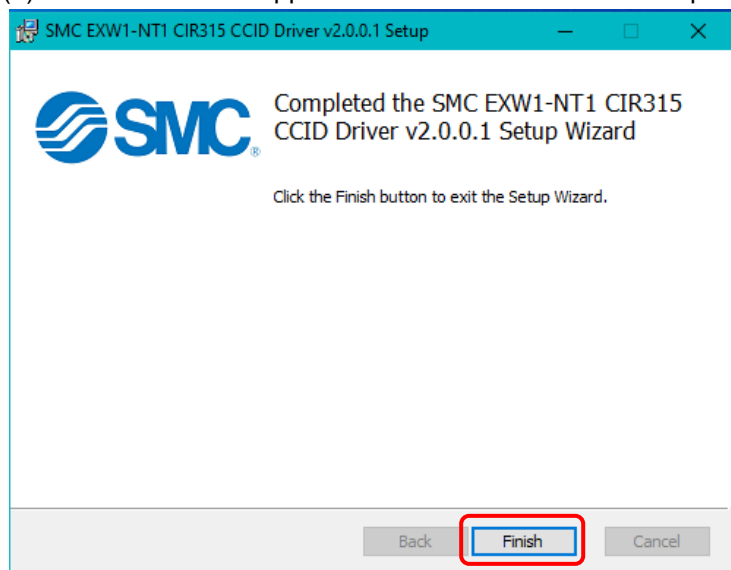

\* When the screen requires restarting of the PC, restart the PC.

# Check the operation of the NFC reader/ writer

Check the operating condition of the LED of the NFC reader / writer referring to “Usage”.

\* The NFC reader/ writer is not displayed in the desktop or micro-computer even when it is correctly identified by the OS.

## Usage

### # Name of individual

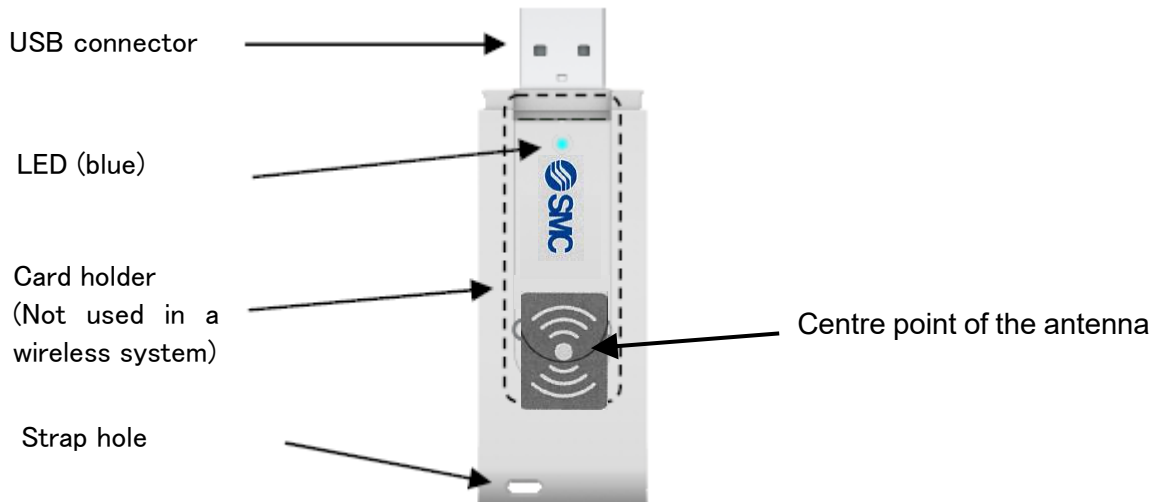

LED status	Definition
Flashing rapidly	- The wireless unit is recognized and the NFC reader / writer is communicating with PC.
ON	- The wireless unit is recognized.
OFF	- The wireless unit is not recognized. - Connection failure of the USB connector. Malfunction of the NFD reader / writer. Abnormality is present.

### # Installation

Connect the USB connector of the NFC Reader/Writer to the female connector of the USB extension cable and then connect the male connector of the USB extension cable to the PC. Hold the NFC Reader/Writer near the wireless unit with the side on which the center point of the antenna is printed facing up and then place it onto the wireless unit with the center point of the NFC Reader/Writer antenna positioned at the center point of the wireless unit antenna.

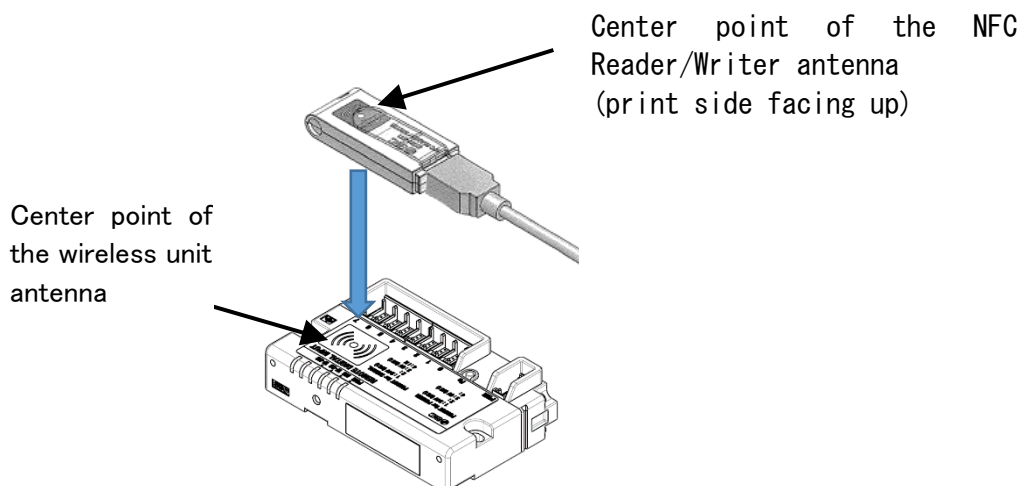

### # SMC Wireless Communication System I/O Configurator (NFC version)

The "I/O Configurator (NFC version)" can be used to check the parameter setting of the wireless unit and the contents and status of the constructed wireless system, using an NFC reader/writer and a PC.

Refer to the product operation manual and "I/O Configurator (NFC version)" operation manual for details of the "I/O Configurator (NFC version)."

(URL <https://www.smcworld.com>)

## Product Specifications

The table below shows the specifications of the product.

Description of the model	EXW1-NT1 (NFC Reader/ Writer)
Applicable models	Wireless System EXW1 series Wireless System EX600-W series
Corresponding card	ISO 14443 compliant, Type B
Interface	USB2.0 Full speed (12Mbps) * USB3.0, operable with 1.1
Power supply	USB bus power
Voltage	5 V
Power consumption	Maximum 250 mA
Dimension [mm]	72 (L) × 24 (W) × 10 (H)
Weight	Approx. 12.5 g
Operating temperature	-10°C to 70°C
Operating humidity	to 95% (No condensation)
Accreditation body	RoHS, REACH
Compatible OS	Windows 8.1 / Windows 10 * Please visit the official SMC website for the latest OS.

# Fixing brackets

## Model Indication and Part Number

To fix the NFC Reader/Writer onto a wireless unit and perform Read/Write, please purchase the following brackets

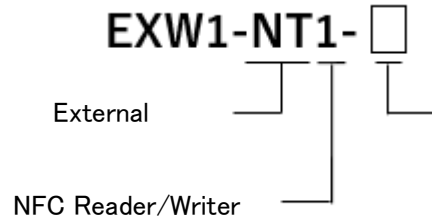

Fixing brackets

Symbol	Contents
xx	For the following EX600-W models EX600-WEN1/2 EX600-WPN1/2 EX600-WSV1/2
xx	For the EXW1 series

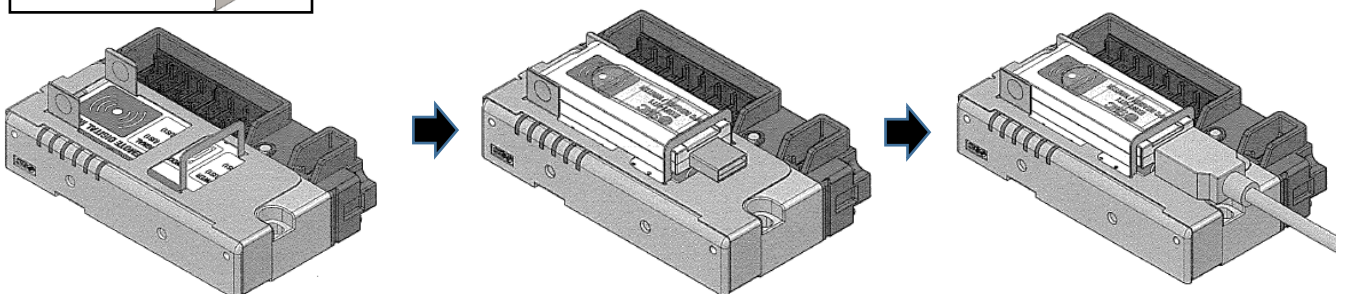
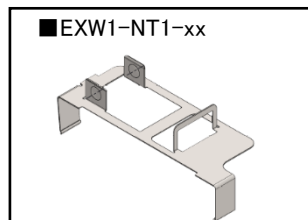
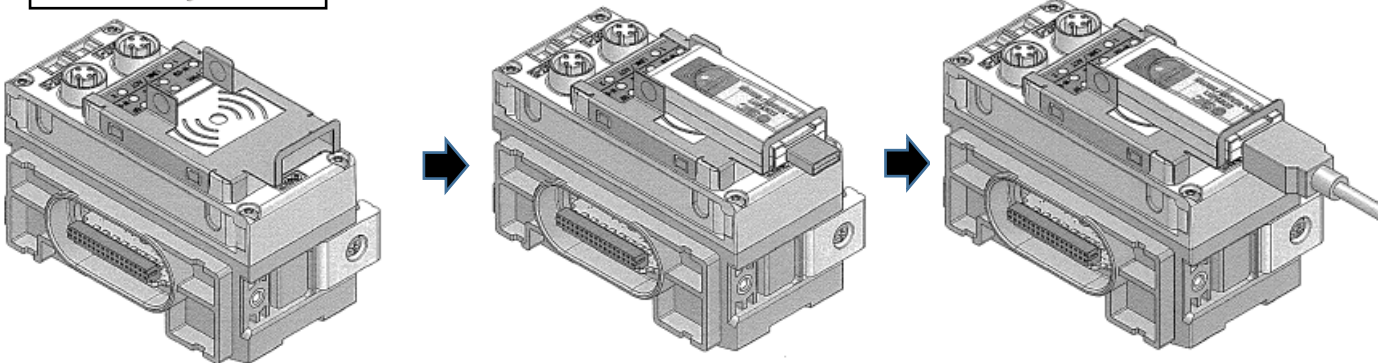
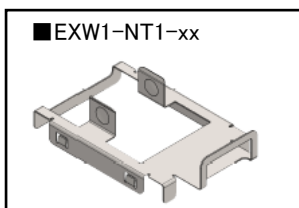

- As the brackets and the NFC Reader/Writer worsen the performance of wireless communication in the 2.4 GHz band, use them only during configuration and remove them during normal use.

## Contacts

AUSTRIA (43) 2262 62 280  
Girakstrasse 8, AT-2100 Korneuburg, Austria

BELGIUM (32) 03 355 1464  
Temesselei 232, 2160 Wommelgem, Belgium

BULGARIA (359) 2 9744492  
Business Park Sofia, Building 8c, 6th floor, BG-1766 Sofia, Bulgaria

CROATIA (385) 1 370 72 88  
Zagrebačka Avenija 104, HR-10000 Zagreb, Croatia

CZECH REP. (420) 5 414 24611  
Hudcova 78a, CZ-61200 Brno, Czech Republic

DENMARK (45) 70252900  
Egeskovvej 1, DK-8700 Horsens, Denmark

ESTONIA (372) 651 0370  
Laki 12, EE-10621 Tallinn, Estonia

FINLAND (358) 207 513513  
PB72, 02231, Espoo, Finland

FRANCE (33) 1 6476 1000  
1, Boulevard de Strasbourg, Parc Gustave Eiffel Bussy Saint Georges F-77607  
Marne La Vallee Cedex 3, France

GERMANY (49) 6103 402 0  
Boschring 13-15, 63329 Egelsbach, Germany

GREECE (30) 210 271 7265  
Anagenniseos 7-9-P.C. 14342 N. Philadelphia, Athens, Greece

HUNGARY (36) 23 513 000  
Torbágy u. 15-19, 2045 Törökbálint, Hungary

IRELAND (353) 1 403 9000  
2002 Citywest Road, Citywest Business Campus, Citywest, Dublin 24, Ireland

ITALY (39) 02 92711  
Via Garibaldi 62, 20061 Carugate, (Milano), Italy

LATVIA (371) 781 77 00  
Dzelzavas str. 120g, Riga, LV-1021, Latvia

LITHUANIA (370) 5 264 81 26  
Oslo g. 1, LT-04123 Vilnius, Lithuania

NETHERLANDS (31) 020 5318888  
De Ruyterkade 120, NL-1011 AB Amsterdam, the Netherlands

NORWAY (47) 67 12 90 20  
Vollsveien 13 C, Granfos Næringspark N-1366 Lysaker, Norway

POLAND (48) 22 211 96 00  
ul. Poloneza 89, 02-826 Warszawa, Poland

PORTUGAL (351) 21 472 45 00  
Alameda dos Moinhos, 9G, 2720-381 Alfragide Portugal

ROMANIA (40) 213205111  
Str Frunzei 29, Sector 2, Bucharest, Romania

SLOVAKIA (421) 41 321321 1  
Fantranská 1223, 01301 Teplice nad Váhom, Slovakia

SLOVENIA (386) 7388 5412  
Mirnska cesta 7, SL0-8210 Trebnje, Slovenia

SPAIN (34) 945 184 100  
Zuazobidea 14, 01015 Vitoria, Spain

SWEDEN (46) 8 603 12 00  
Ekhagsvägen 29-31, SE-141 71 Segeltorp, Sweden

SWITZERLAND (41) 052 396 31 31  
Dorfstrasse 7, CH-8484, Weisslingen, Switzerland

UNITED KINGDOM (44) 0845 121 5122  
Vincent Avenue, Crownhill, Milton Keynes, Buckinghamshire MK8 0AN, United Kingdom

**SMC Corporation** URL <https://www.smcworld.com>

Akihabara UDX 15F, 4-14-1, Sotokanda, Chiyoda-ku, Tokyo 101-0021, JAPAN

Phone: +81 3-5207-8249 Fax: +81 3-5298-5362

---

Note: Specifications are subject to change without prior notice and any obligation on the part of the manufacturer.

© 2021 SMC Corporation All Rights Reserved

EX※※-OMX000x