

### Statement

- This manual is designed for the use of FCAR products; it cannot be copied or stored in any form (electronic, mechanical, photocopying, recording or otherwise) without prior written permission being secured from Shenzhen FCAR Technology Co., Ltd.
- This manual is intended for professional vehicle repair technicians.
- This manual provides the operation methods for FCAR products only, and the company accepts no responsibility for the consequences caused by attempting to use the operation methods on other equipment.
- The company shall not accept any responsibility for accidents caused either by the user personally or anyone else, or costs and expenses due to equipment damages including equipment loss caused by the user's abuse or misuse, arbitrary changes or repairs or operation of the equipment in a manner not in accordance with the manual requirements.
- This manual is written in accordance with the existing configuration and functions of the product, and is subject to change without notice if the product adds new configurations and functions.
- The company has registered the  trademark in mainland China. The company declares that the ownership of the registered trademark, service mark, domain name, logo, and company name in countries in which they have not yet been registered belongs to the company. Other products and their company name trademarks mentioned in this manual belong to the original registered company. The trademarks, service marks, domain names, logos, company names or other companies mentioned may not be used without prior written permission of the owner.
- This device complies with part 15 of the FCC Rules. Operation is subject to the following two conditions: (1) This device may not cause harmful interference. (2) This device must accept any interference received, including interference that may cause undesired operation.

**If you have any questions, please contact us by the following ways:**

Headquarters: 8F, Chuangyi Bldg., No. 3025 Nanhai Ave., Nanshan, Shenzhen, China 518060

Factory: West 1F, Bldg. B, Hengchao Industrial Park, Tangtou North Ave., Bao'an, Shenzhen, China 518108

Tel: 0086-755-82904730

Fax: 0086-755-83147605

E-mail: [marketing@szfcar.com](mailto:marketing@szfcar.com)

Website: <http://www.fcar.com>

---

## Registered Trademark

Shenzhen FCAR Technology Co., Ltd (short form FCAR) has registered the trademark  in China and several foreign countries. In countries where any of the FCAR trademarks, service marks, domain names, logos and company names etc. are not registered, FCAR claims all rights associated with non-registered trademarks, service marks, domain names, logos and company names etc. Other products or company names, logos, service marks etc. referred to in this manual still belong to their respective owners. Use of any trademarks, service marks, domain names, logos of FCAR or any third company without the written permission from the owner of the applicable trademarks, service marks, domain names, logos or company names is prohibited.

## FCAR Series Product Operation Manual Instruction

Before using FCAR series products, please read this manual carefully.

This manual is based on the current product functions and configurations and it will subsequently be amended if any new functions or configurations are added. New specifications can be downloaded at the FCAR website (<http://www.fc.com> )

**Please carefully read the "Note" "Remark" and "Description" of the user manual to ensure that the user will use our products properly and safely.**

## FCAR Series Main Unit Maintenance and Use Cautions

- Do not allow unauthorized disassembly.
- Avoid strong impacts to the equipment.
- Avoid proximity to any magnetic field.
- Do not keep this machine in a high temperature environment for any length of time.
- Do not keep this machine in a low temperature environment for any length of time.
- Do not forcefully click on the screen or click the screen with sharp tools.
- Do not use water and chemical solvents to clean the machine, use a soft clean cloth and neutral detergent instead.

## Automobile Inspection Notes

- Follow the standard safety rules of the auto repair industry to operate. Be especially careful to avoid impact or damage caused by environmental factors such as the surrounding pH, poison gas or high pressure environment. ?
- Vehicle battery fluid contains sulfuric acid, which is corrosive to the skin. During the

operation, avoid direct contact with the battery fluid, in particular being careful not to splash into the eyes. Keep away from fire.

- The engine exhaust gas contains a variety of toxic compounds, which one should avoid breathing in. . During the operation, park the vehicle in a well-ventilated place.
- When the engine is running, the temperature is very high; please avoid contact with the water tank, exhaust pipe and other high temperature components.
- Before starting the engine, apply the handbrake and place the shift lever in Neutral (Manual Transmission) or P range (Automatic Transmission) to avoid sudden movements of the vehicle when starting the engine.
- Before repairing the vehicle, apply the parking brake, engage the Neutral or P range, and lower the driver seat's glass doors.
- If the engine can be started, warm-up to normal temperature (water temperature at about 80 °C), and turn off the auxiliary electrical appliances (such as air conditioning, lighting, sound, etc.).
- Find the diagnostic socket of this car; check and confirm the diagnostic socket lines are in good condition, connecting the main unit for diagnosis. Otherwise, do not test, to avoid damage to the main unit. If necessary, use a multimeter to measure the voltage of the diagnostic socket.

#### **Instrument Use Notes**

- When using FCAR series products for testing, please be gentle and keep them away from heat and electromagnetic fields, to avoid interference to the main unit.
- Do not use sharp tools to click the screen; the matched touch pen is recommended.
- When electrical components are energized do not disconnect the circuit, to prevent self-inductance and mutual inductance current damaging the sensors and automotive ECU.
- When electrical components are working normally, magnetic objects are forbidden near the automotive control unit, otherwise the vehicle control unit may be damaged.
- Before disassembling the vehicle control unit or electrical components, turn off the ignition switch for 1 minute.

---

**Contents**

<b>CHAPTER I PRODUCT INTRODUCTION .....</b>	<b>5</b>
1.1 INTRODUCTION.....	5
1.2 FEATURES.....	5
1.3 CARE AND MAINTENANCE .....	6
1.4 HELP.....	7
<b>CHAPTER II PRODUCT STRUCTURE.....</b>	<b>8</b>
2.1 F7S HOST STRUCTURE DESCRIPTION.....	8
2.2 VCI BOX STRUCTURE DESCRIPTION .....	10
<b>CHAPTER III F7S HOST MENU PRESENTATION .....</b>	<b>12</b>
3.1 DIAGNOSIS.....	13
3.2 VCI CONNECTION .....	14
3.3 DATA MANAGEMENT .....	15
3.4 REMOTE DIAGNOSIS.....	16
3.5 REFERENCE GUIDE .....	16
3.6 UPGRADE .....	17
3.7 SETTINGS .....	18
<b>CHAPTER IV VEHICLE DIAGNOSIS .....</b>	<b>23</b>
4.1 HOST AND VCI BOX CONNECTION METHOD .....	23
4.2 VEHICLE DIAGNOSIS .....	27
<b>CHAPTER V UPGRADE AND ACTIVATION.....</b>	<b>33</b>
5.1 UPGRADE .....	33
5.2 ACTIVATION .....	35
<b>CHAPTER VI WARRANTY CLAUSE .....</b>	<b>38</b>

## Chapter I Product Introduction

### 1.1 Introduction

According to the National 863 R & D program, the FCAR F7S series product is an integrated automotive fault diagnostic computer aimed at gasoline, diesel, natural gas and other electronic control systems testing and diagnosis. The product is applicable to large and small service companies, training institutions, automobile manufacturers, repair stations, diesel engine manufacturers, mining machinery, petrochemical and other energy enterprises.

Software of F7S is comprehensively configured and vehicle data and information in it are authoritative and fully meet the strict requirements of customers' detection breadth and depth. The software covers thousands of domestic and imported vehicle model data, and provides a powerful help system with maintenance information, enabling users to deal with the problems in practical work easily and quickly, thereby increasing the efficiency and technical level and reflecting the advantage of professional level quality.

### 1.2 Features

The hardcore of the FCAR auto diagnostic computer adopts the international advanced modular design concept, equipped with the excellent performance characteristics of high speed, stability, data collection accuracy, etc.

With the open structure design and the independent operating system, the future upgrade of the system software and diagnostic software becomes more convenient.

Its working power is supplied by any vehicle storage battery which can meet the voltage change between 9~27V. The internal power supply adopts a separating power supply design which can avoid product damage when the vehicle voltage is abnormal.

The FCAR product has good extensibility. Its communication interface adopts a flexible drive circuit which satisfies not only the current auto bus type test, but also future auto bus type tests. The built-in high speed and low speed CAN-BUS are used to support the electronic control system with CAN-BUS. With one diagnostic interface, all vehicles with CAN-BUS can be tested. The products support all OBD-II protocols.

Our multi-language operation edition is adapted for use in different countries and areas.

### 1.3 Care and Maintenance

#### 1.3.1 Storage Environment

- 1) Store the product in a flat and dry place with suitable temperature.
- 2) Never put the product in direct sunlight or near to any heat source.
- 3) Never put the product in a magnetic field.
- 4) Avoid smoke erosion, and water or oil splashing.
- 5) Avoid shock, dust, moisture and extremely high temperature.
- 6) If main unit is dirty, power off the machine, then clean the housing case with a soft cloth.
- 7) Periodically start up the FCAR main unit to avoid moisture accumulation if it is not in use for a long period of time.

#### 1.3.2 Main Unit Protection

- 1) Handle it with care and avoid impact.
- 2) Be careful when plugging and unplugging the main cable and diagnostic connector. Tighten the screw before operation to avoid unexpected disconnection and/or damage to the diagnostic port.
- 3) Return the test cable, connectors and other accessories to the box to avoid loss.

#### 1.3.3 Touch screen Care

- 1) Dust may accumulate on the LCD screen due to electrostatic attraction. It is suggested to buy a special LCD screen wiper to clean the screen gently;
- 2) Avoid touching the screen with bare hands to avoid fingerprint deposition. Never use chemicals to clean the screen.
- 3) Never put the FCAR product close to any electromagnetic wave products to avoid any harmful effect on the screen.
- 4) Never put the FCAR product in direct sunlight or ultraviolet radiation for any length of time to avoid shortening the service life of the screen.

#### 1.3.4 Precaution on operation

- 1) Do not switch the main unit on and off frequently or cut off the power suddenly, as power supply instability and abnormal power supply may result.
- 2) Unplug the power after usage to slow down aging of the product.
- 3) Avoid using this product in an environment with air which has volatile alkali chemical, so as to avoid host hardware corrosion.
- 4) Never clean the product with chemical solvent reagents like banana water, engine cleaning agents, gasoline etc.
- 5) Don't put anything on the screen. To avoid any damage, please don't place objects on the

screen.

6) Periodically start the FCAR main unit if not operated for a long time in order to avoid moisture accumulation.

## 1.4 Help

With the help of our support service, the FCAR series product is easy and simple to maintain. The marketing network that covers various regions provides you with the most convenient and efficient service from purchase through usage, upgrade and maintenance.

FCAR provides users with online help. If you want to view the company's latest products, or automotive diagnostic information, you can log on "FCAR" Website via the Internet: <http://www.fcar.com> and contact us.

Chapter II Product Structure

2.1 F7S Host Structure Description

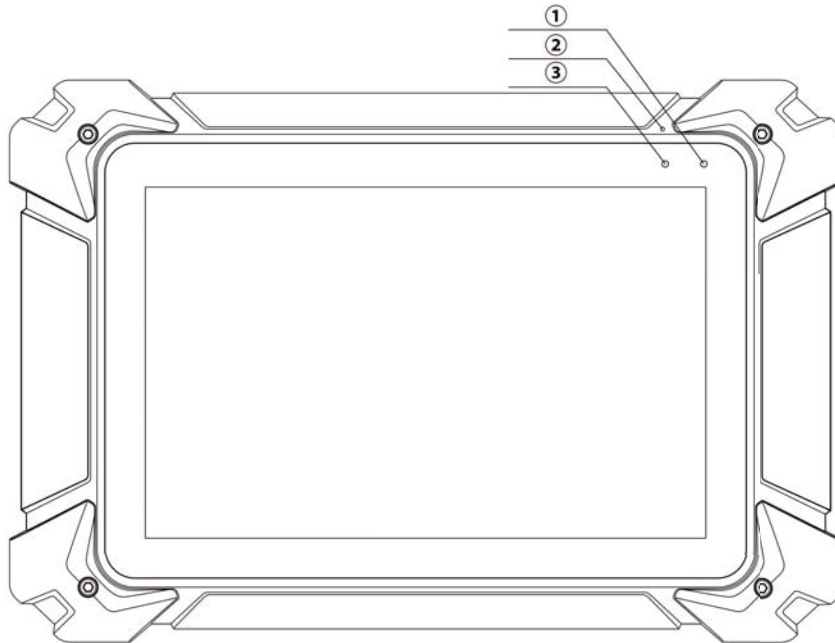

No.	Name	Description
①	Power Indicator	Charging Indicator
②	Microphone port	Voice input
③	Light-sensitive sensor	External light intensity sensor

Host parameters

<b>System</b>	Based on Android 4.3 and above multi-tasking operating system
<b>Processor</b>	Freescale Industrial 4 core 1.2GHz processor architecture
<b>Display</b>	IPS 10.1 "Resolution: 1280 * 800 PPI
<b>TouchScreen</b>	10.1 "multi-touch capacitive screen
<b>RAM</b>	2GB RAM & 32GB On-board Memory
<b>Connection</b>	WiFi (802.11 a/b/g/n) &Bluetooth 2.0/4.0
<b>Camera</b>	500 million pixels, auto focus
<b>Interface</b>	RJ45, HDMI, USB2.0, TF card slot (expandable up to 128G), headphone jack, microphone
<b>Dimension</b>	323mm×218mm×42mm



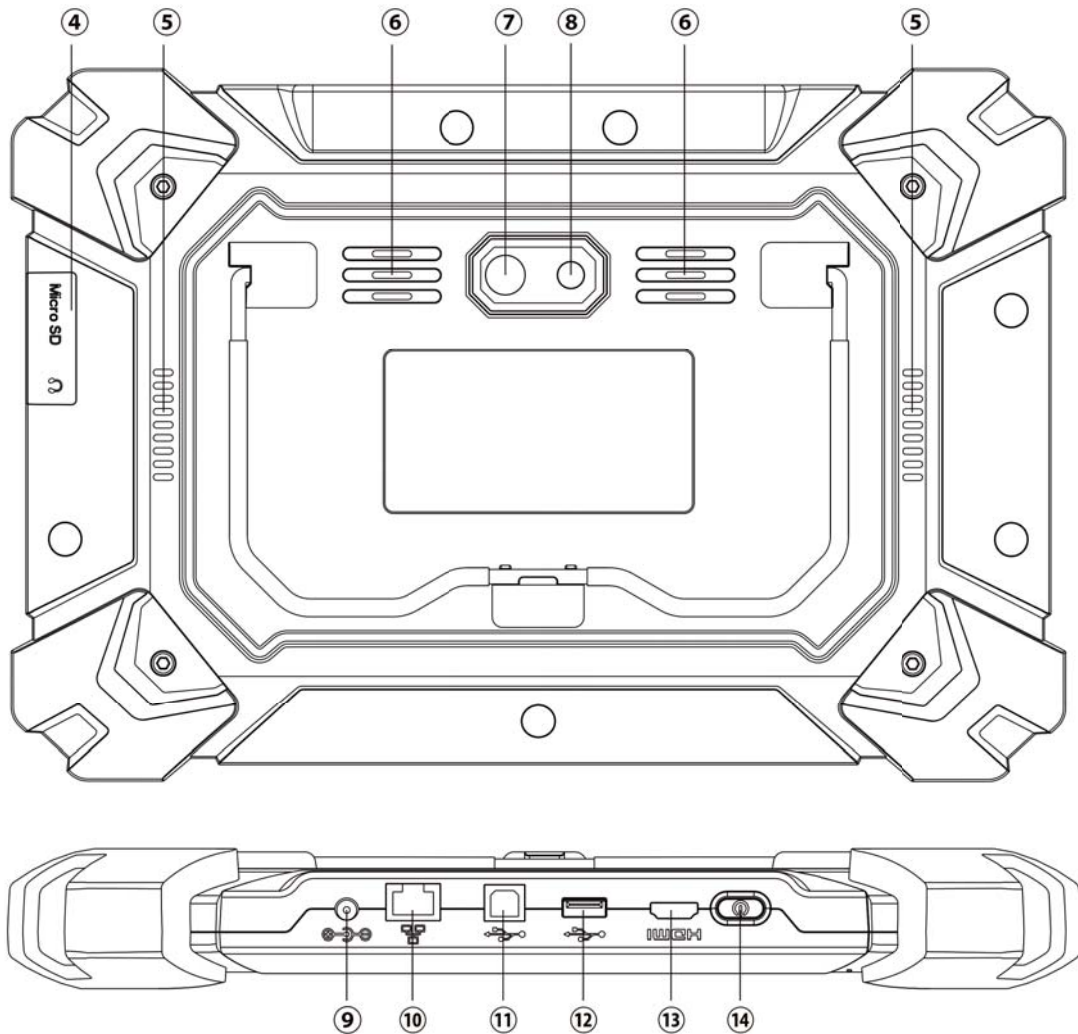

No.	Name	Description
④	TF card slot /3.5 headphone jack	TF memory card location / headphone jack
⑤	Vents	For Tablet PC cooling, avoid overheating
⑥	Loud speaker hole	For external audio player
⑦	Camera	For taking pictures or recording video
⑧	Flash lamp	For lighting at low light
⑨	DC power port	For Tablet PC charging or power supply
⑩	RJ45 interface	For network connection
⑪	USB interface (B shape)	Device Interface: for connecting computers as U disk
⑫	USB Interface	Host Interface: for Tablet PC and VCI connection, or connecting U disk

①	HDMI Interface	Standard HDMI interface: for connecting high-definition TV output
②	Power switch	Forturning the tablet ON and OFF, or LOCK screen.

**2.2 VCI Box Structure Description**

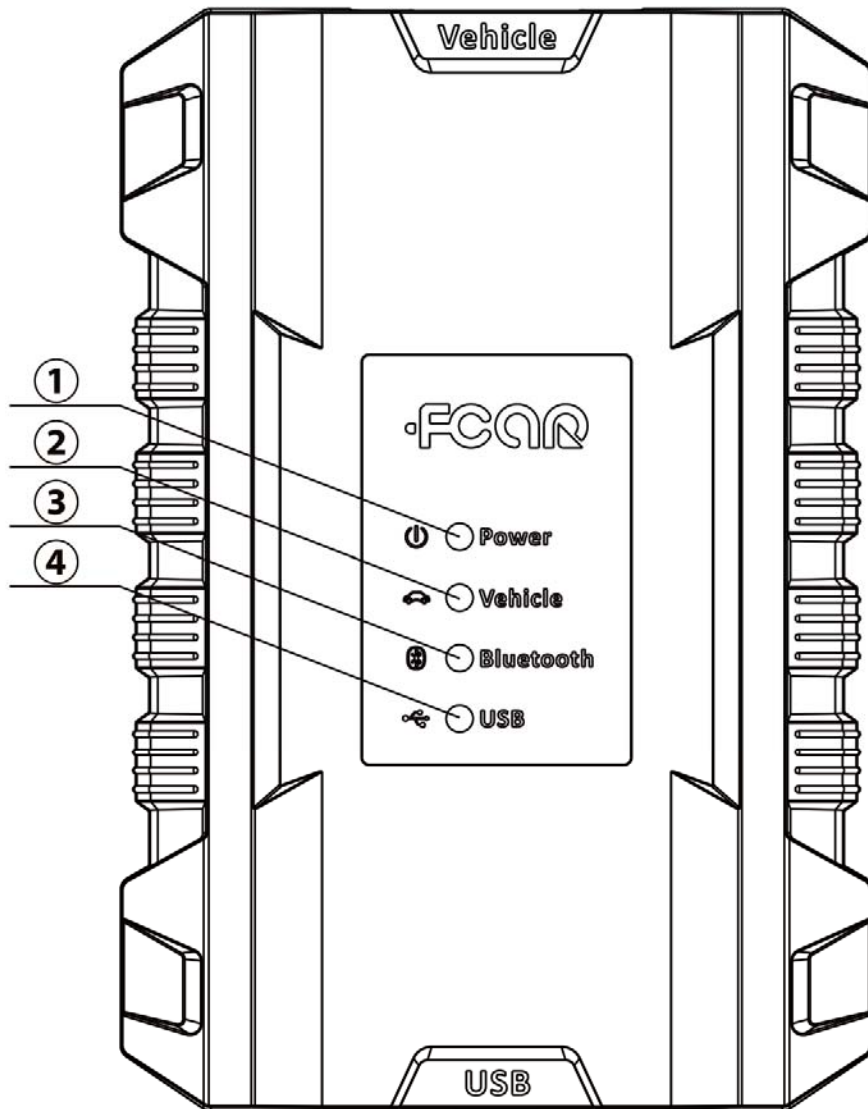

No.	Name	Description
①	Power Indicator	Lights up when powered (connected to the car)
②	Diagnostic light	Lights up when connected to vehicle
③	Bluetooth indicator	Lights up when connected to tablet PC
④	USB indicator	Lights up when connected to tablet PC

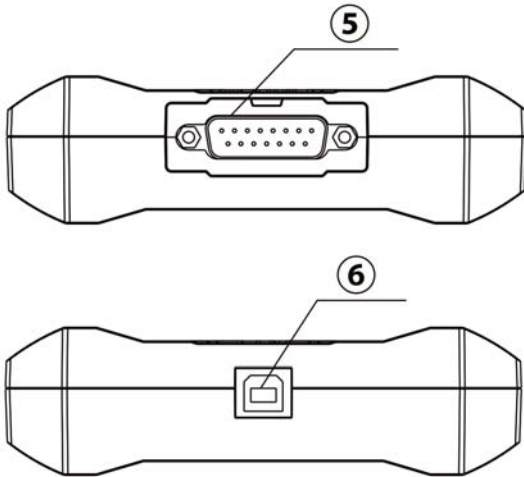

No.	Name	Description
⑤	DB15 Interface	Connect to the main testing line, connect to the vehicle through the diagnostic connector
⑥	USB interface (B shape)	Connect to tablet PC or upgrade VCI box

**VCI Box Parameters**

<b>Processor</b>	Cortex-M3 Micro controller
<b>Frequency</b>	100MHz
<b>Processor Type</b>	LPC1768
<b>Flash Memory</b>	512KB
<b>RAM</b>	64KB
<b>Bluetooth</b>	Bluetooth 2.0, Bluetooth 4.0

### Chapter III F7S Host menu presentation

Turn on the machine through the above-described power switch. The initial Welcome interface (see below) will appear.



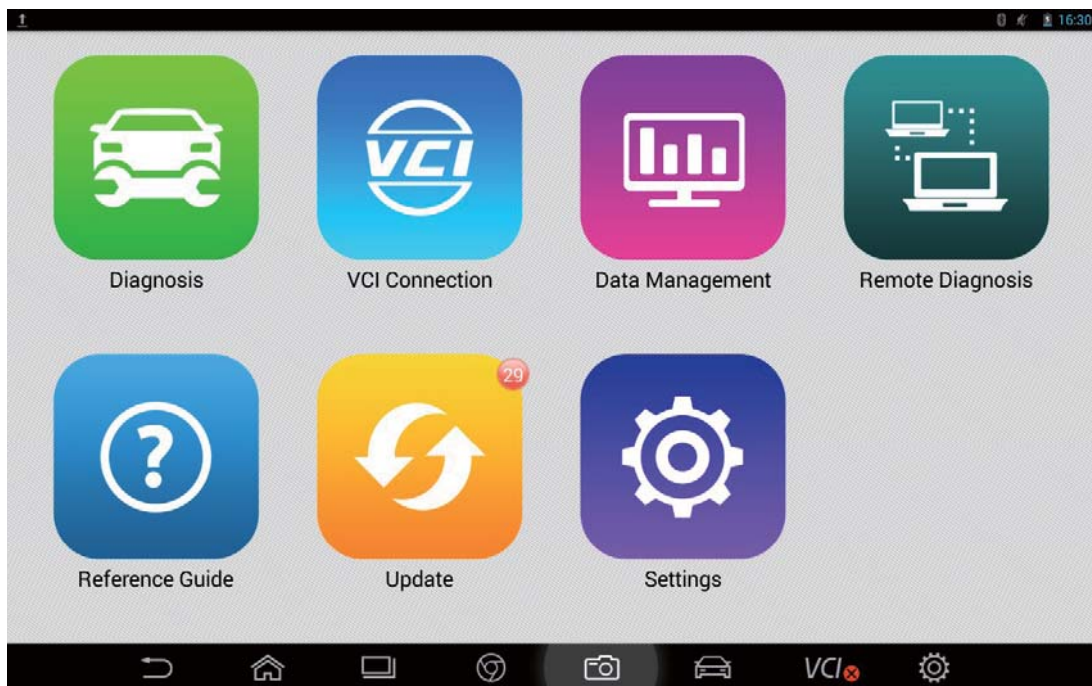

### 3.1 Diagnosis

Enter from this menu to perform vehicle diagnostics. A series of vehicle fault diagnosis operations can be carried out.

Since there are different models of the product, such as petrol version and diesel version, please refer to the actual display menu for specific applications.



### 3.2 VCI Connection

1. [Diagnostic connection method]- Bluetooth;

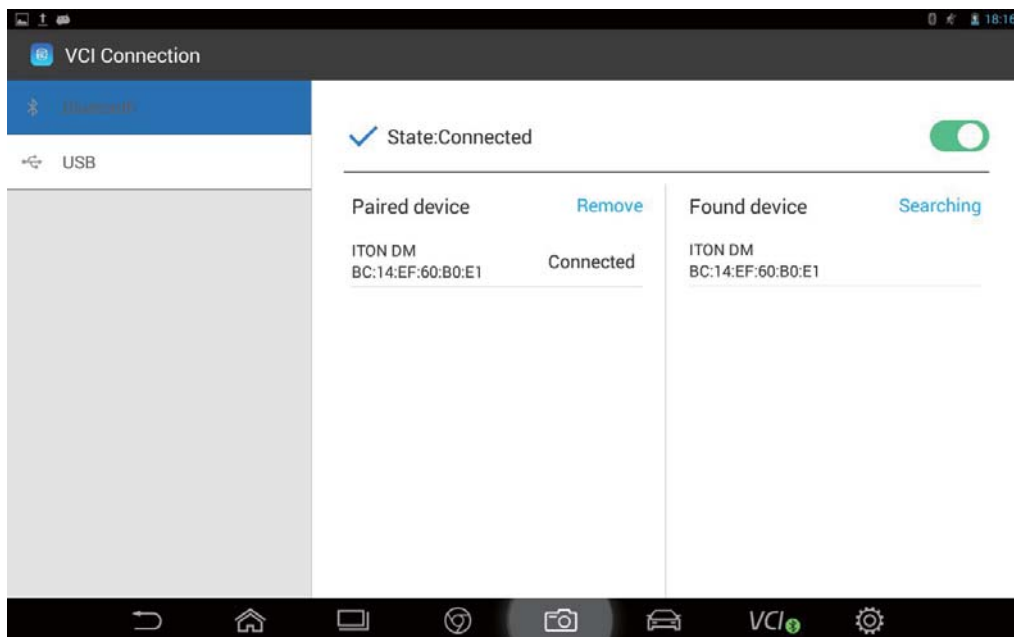

2. [Diagnostic connection method]-USB;

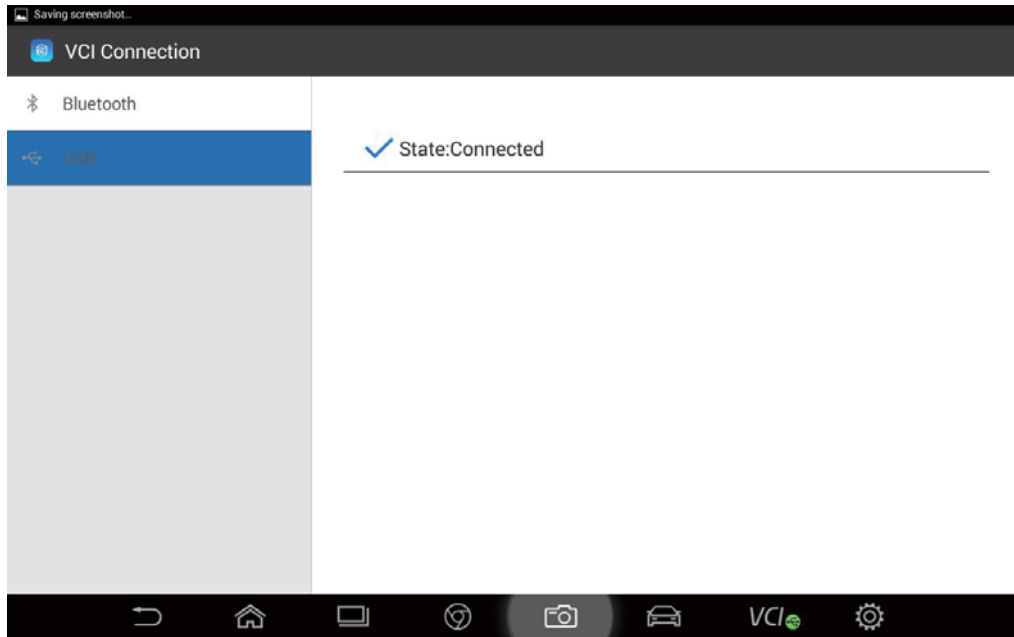

3.3 Data Management

Data Management: storage location for screenshots and video recording and for reference use.

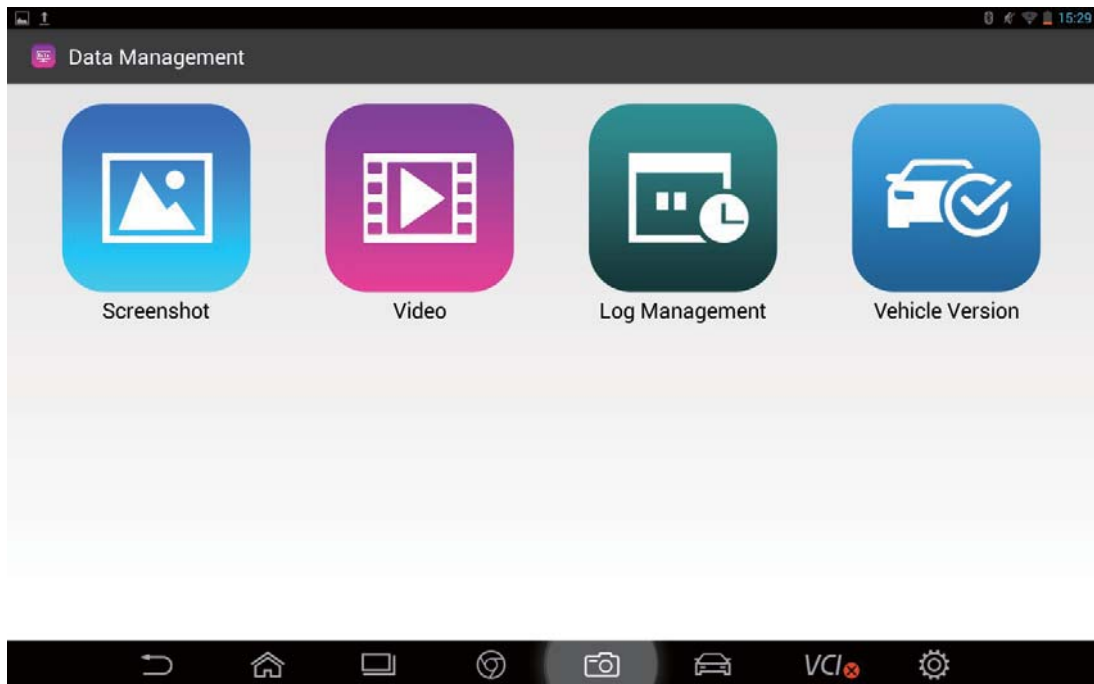

### 3.4 Remote Diagnosis

This function allows our technical staff to connect to your host through the network remotely to help you diagnose the vehicle.

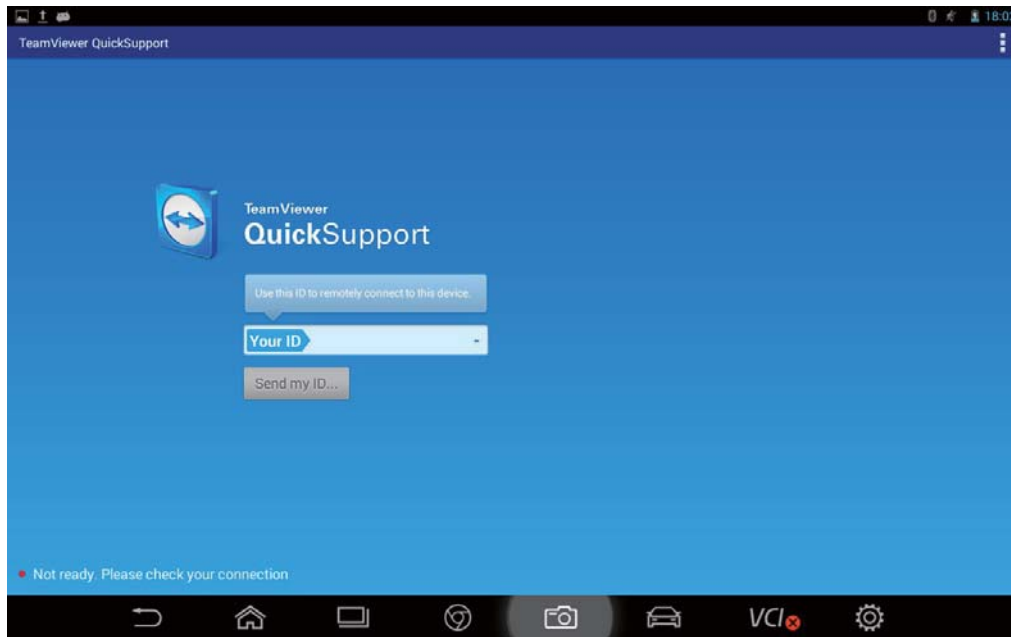

### 3.5 Reference Guide

Here we have built-in product instructions, maintenance information, circuit diagrams and other information for the user to access.



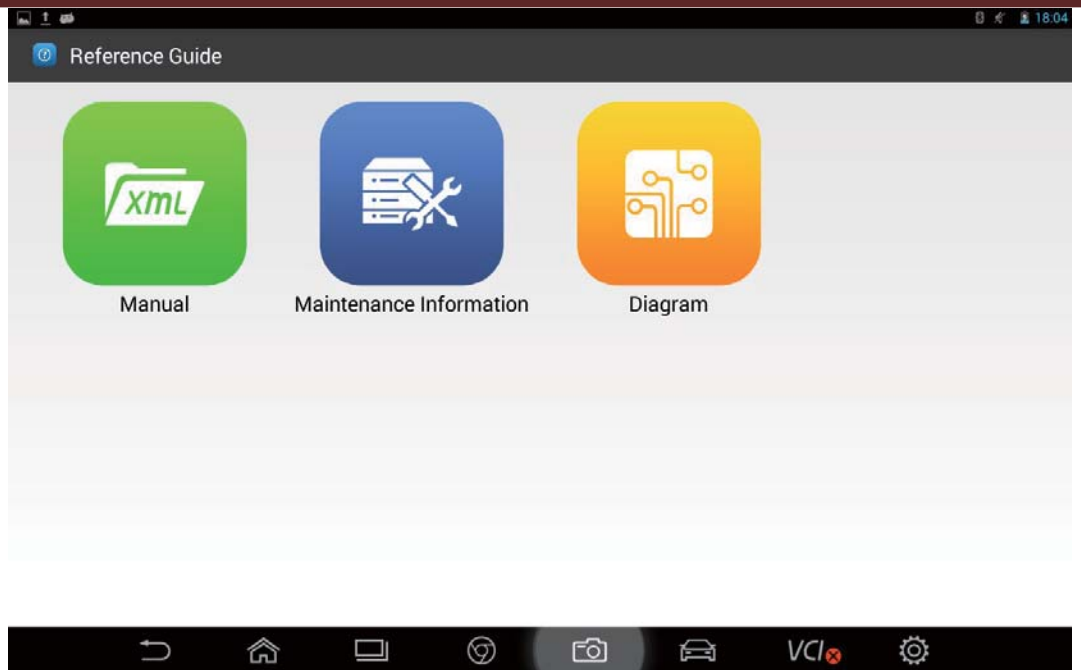

### 3.6 Upgrade

When connected to the Internet via Wi-Fi or cable interface, to upgrade the diagnostic software to improve the functions of the system.

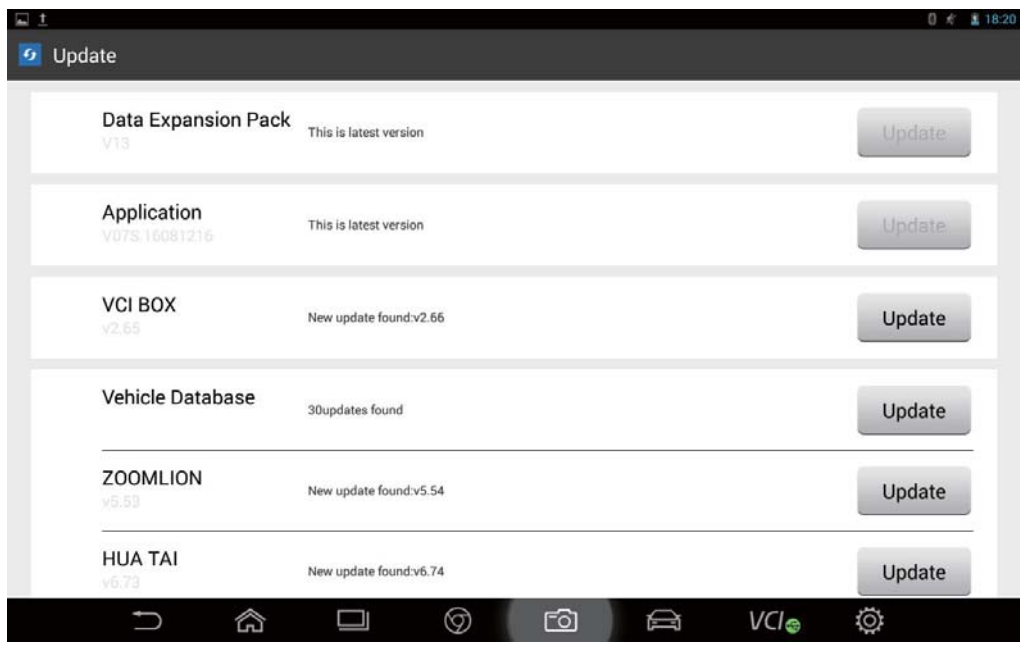

### 3.7 Settings

Set the system Language, Units, User Info, Self-Test, Activation, Print Settings, Push Notification, About Us and other functions.

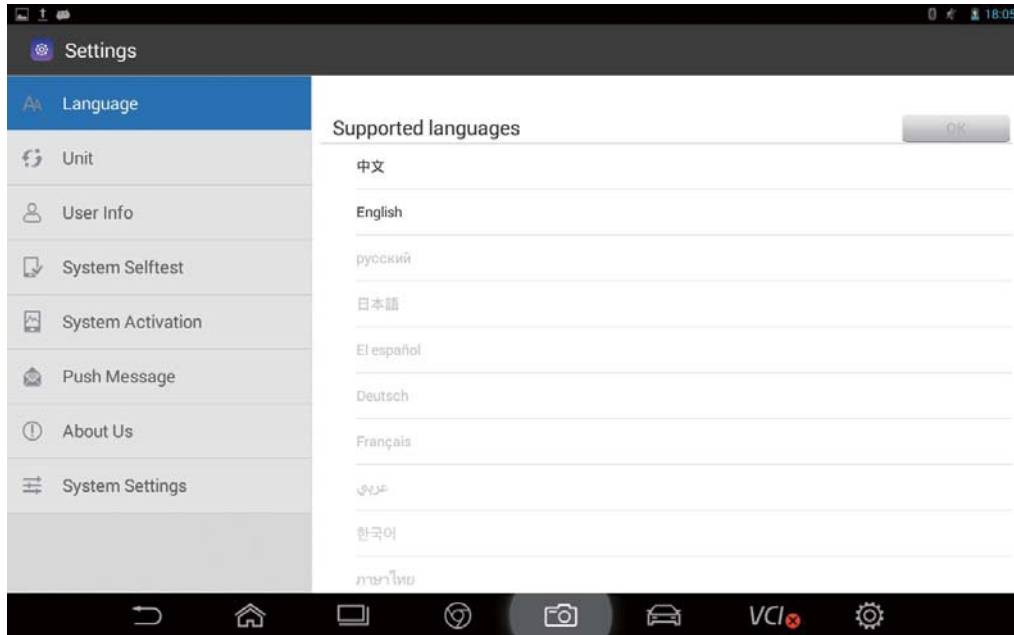

#### 1. Language Settings

Our products support multiple languages. You can use the application to reflect the languages you have purchased.

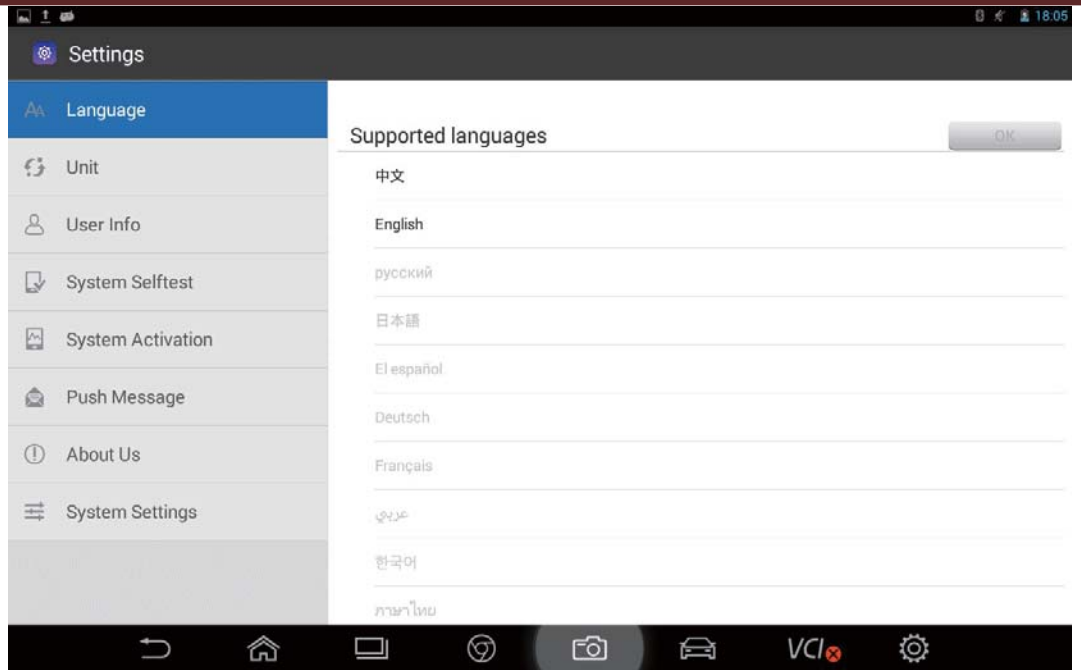

**2. Unit**

Set the live data unit in the diagnostic software. You can select Metric or English as needed.

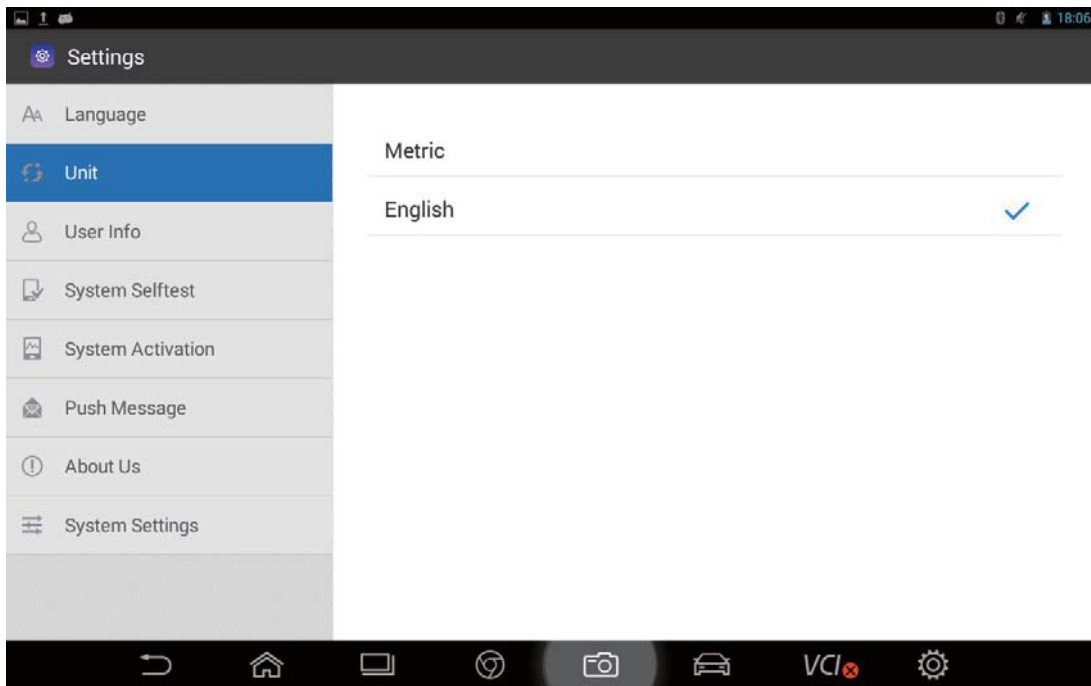

**3. User Info**

Set your personal information: name, phone, email, address, and so on.

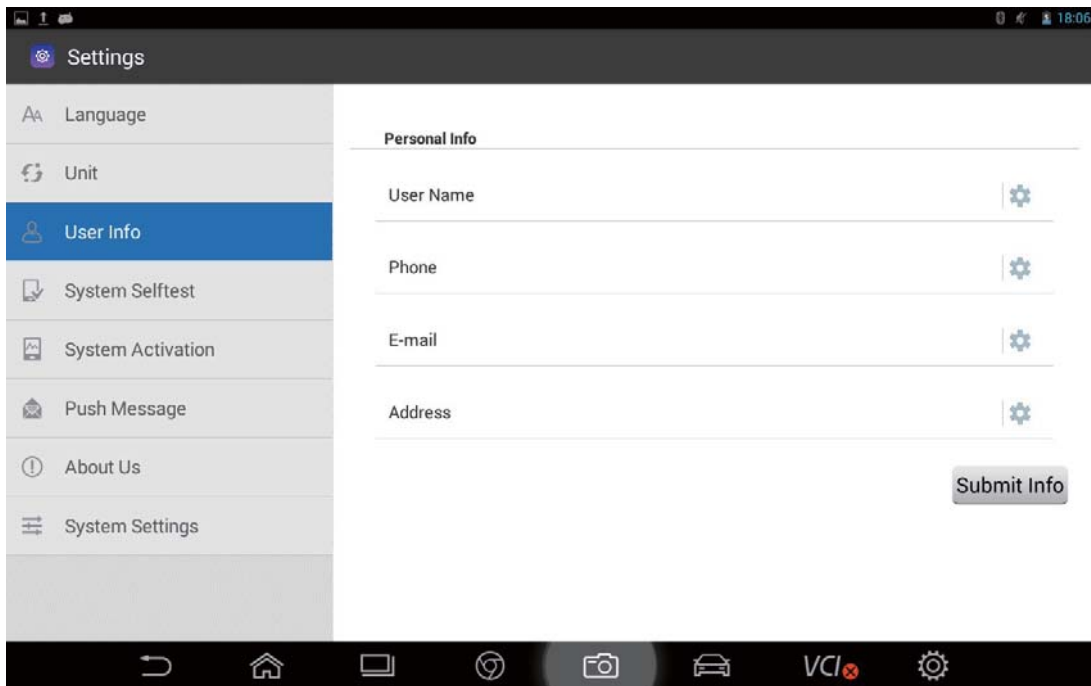

#### 4. Self-Test

You can check the open circuit or short circuit of the main test line and OBD-II connector.

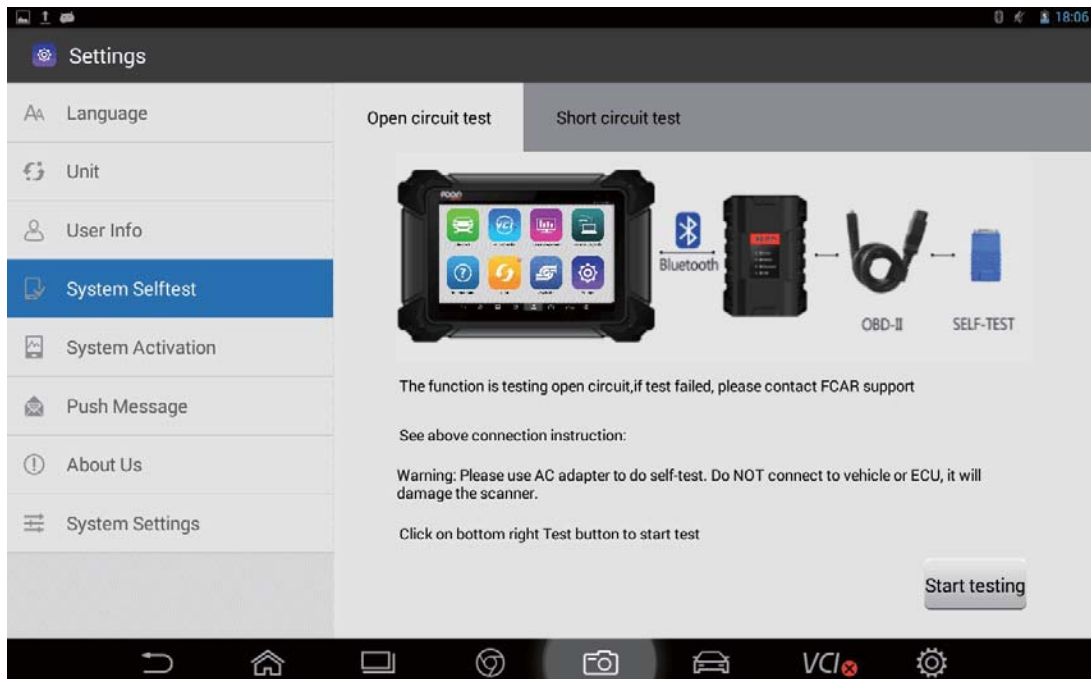

#### 5. Activation

The product is shipped with a time-limited usage restriction. After your purchase, you must permanently activate the product.

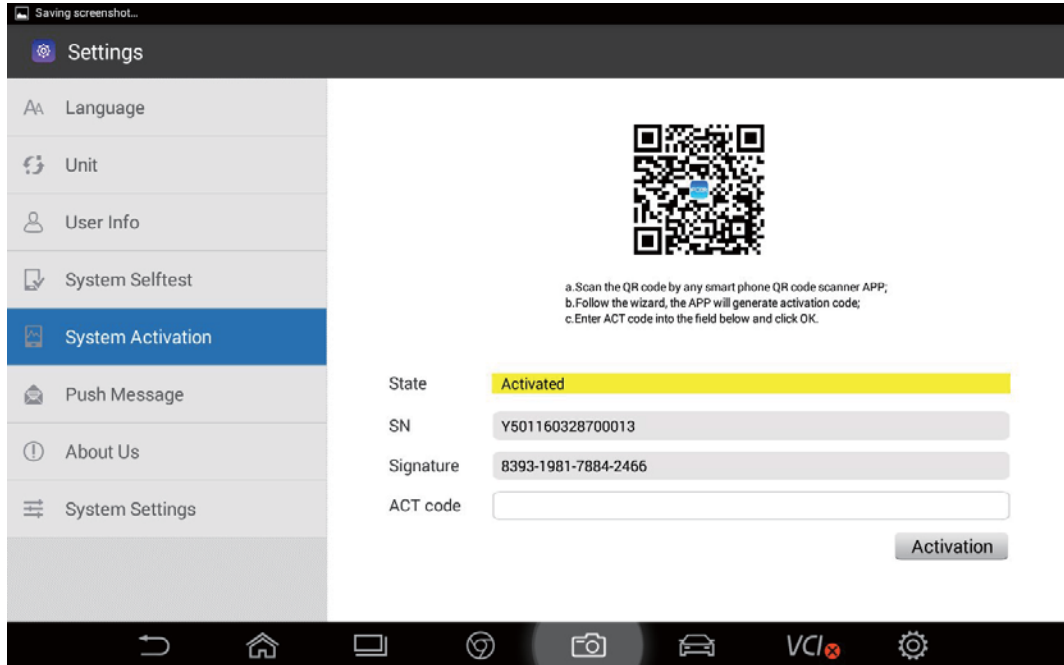

### 6. Push Notification

This function provides you with industry dynamics, company training information, technical data and other services.

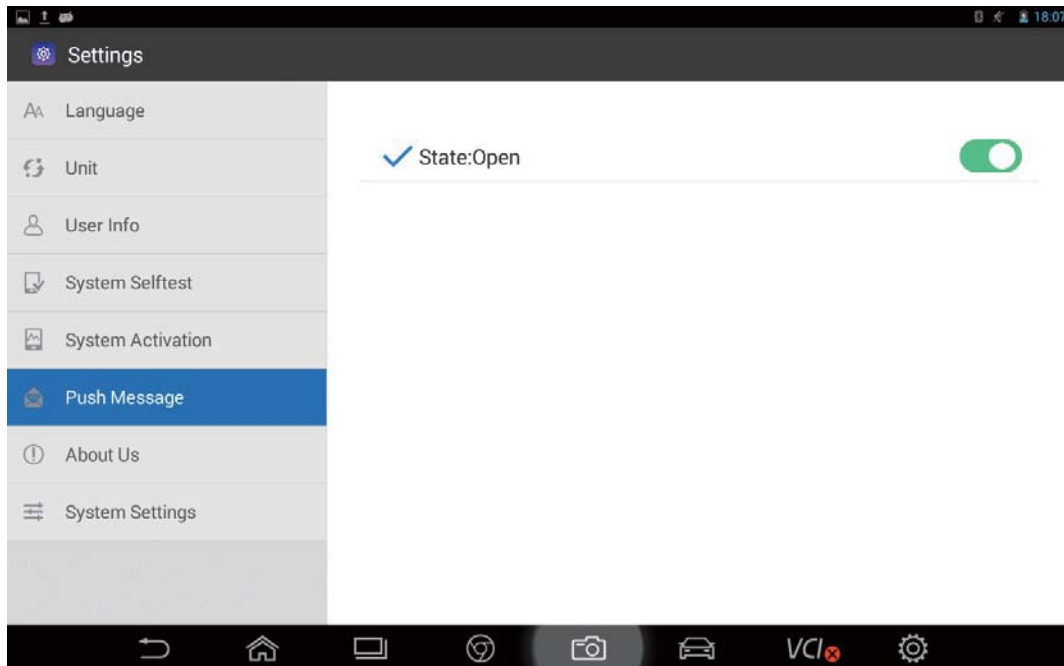

## 7. About Us

This screen shows system information, activation status, storage status, etc.

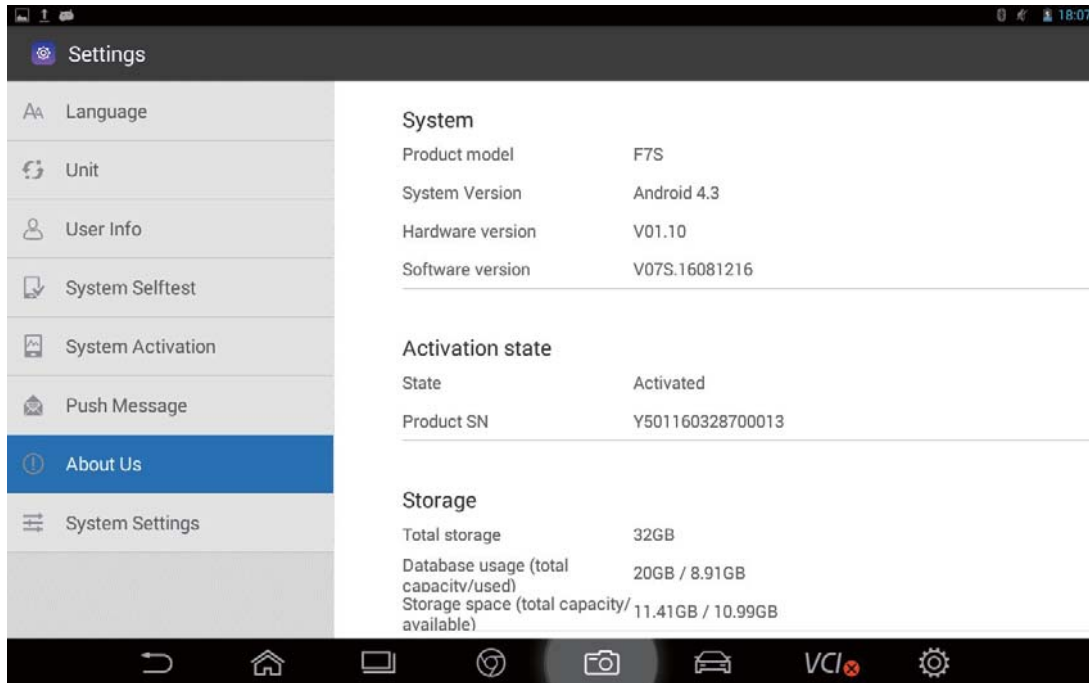

## 8. System Settings

F7S system settings.

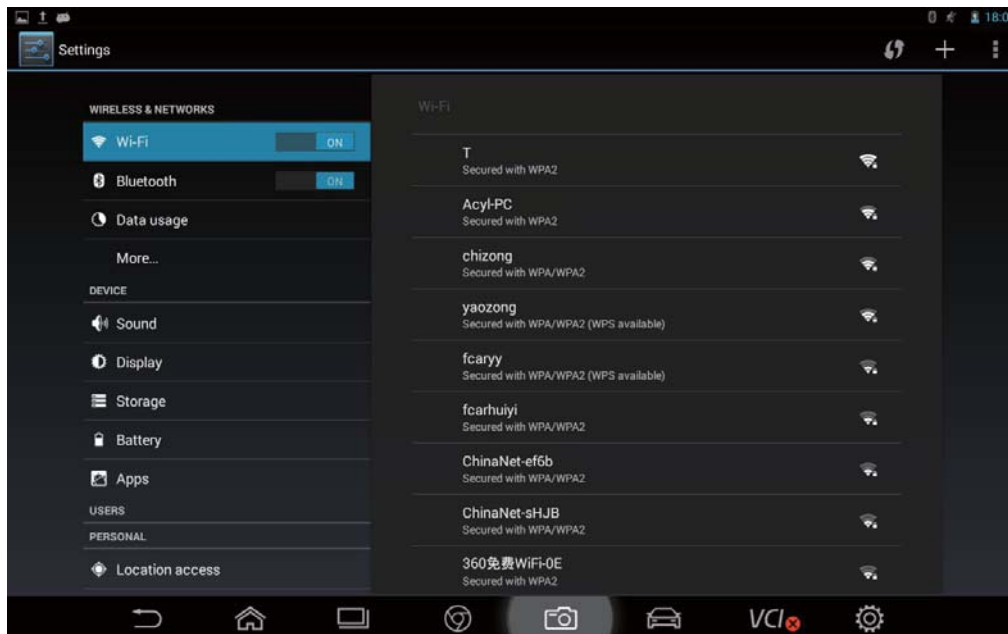

Chapter IV Vehicle Diagnosis

4.1 Host and VCI Box Connection Method

Connect the VCI box to the vehicle to be diagnosed via the main test line and diagnostic connector:



Then turn on the machine, enter [Settings]-[VCI connection]. It can be connected via Bluetooth and USB cable:

**First: Connect the host with the VCI box via Bluetooth**

1. The host and the VCI box are default paired, and will automatically connect when used. If the VCI indicator is not connected, click "Search";

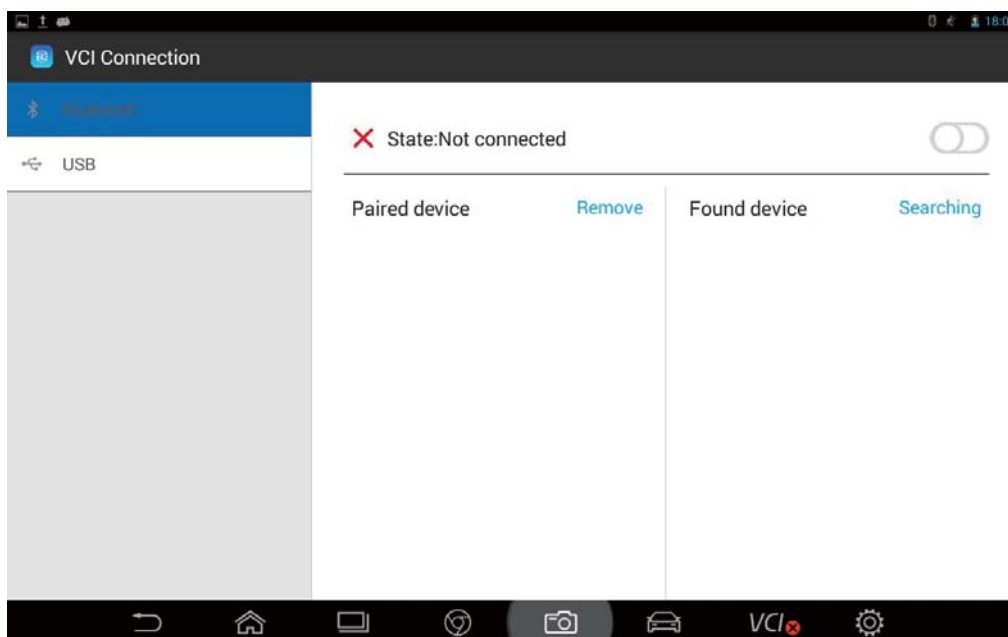

2. After approximately one minute, you can search for the ID of the VCI box connected to the vehicle. Click Connect to pair.

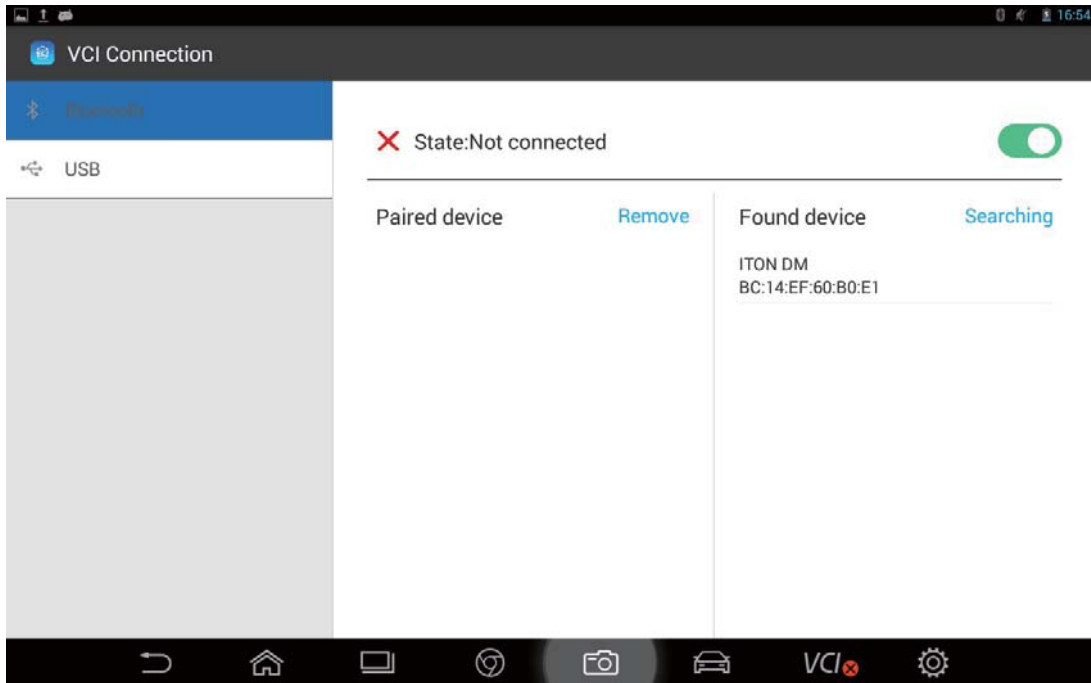

3. Click "Pair".

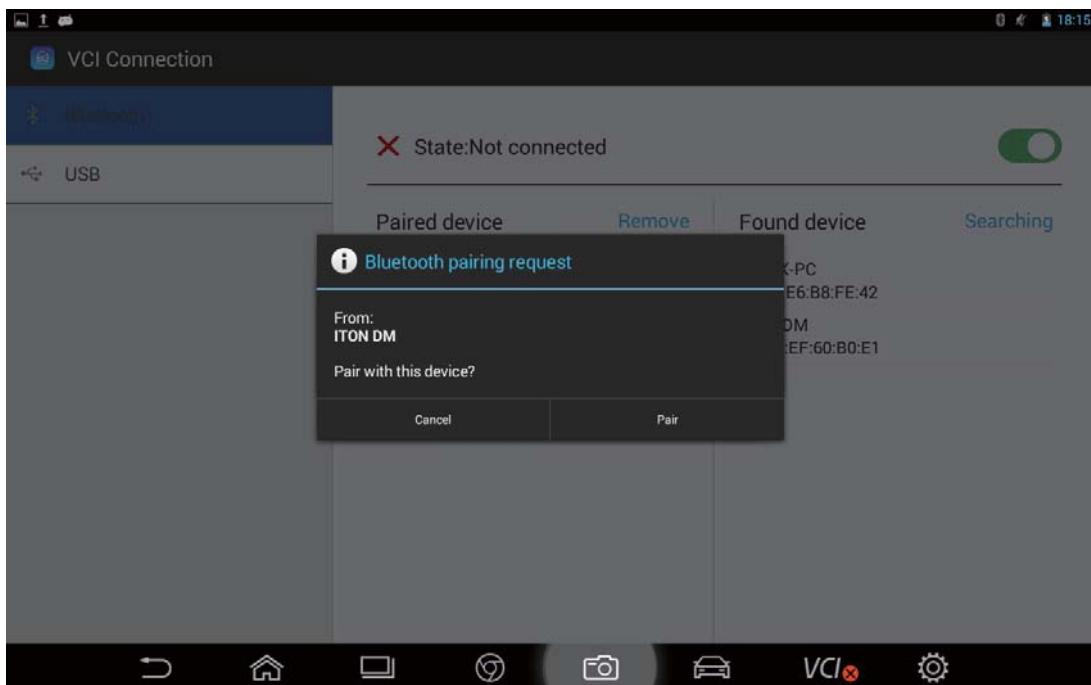



4. After the pairing is successful, the VCI Bluetooth lamp on the host will light, and the Bluetooth indicator on the VCI box will also light, which means successful connection has been achieved.

Note: It will automatically pair next time you use it, and you do not need to set it again.

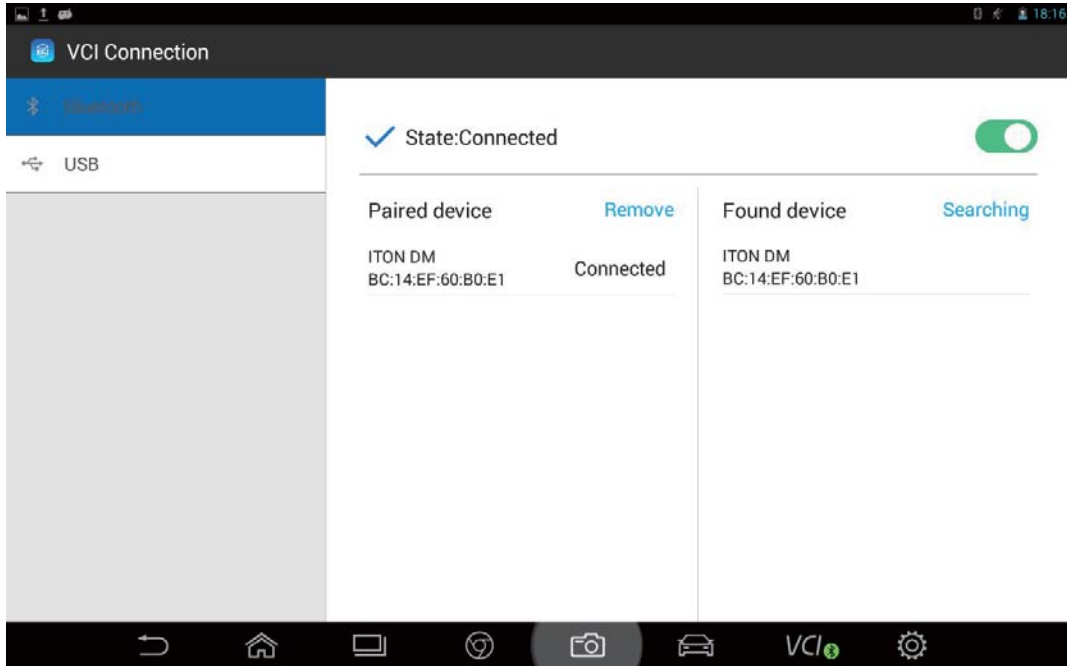

**Second. Connect the host and VCI box via USB data cable**

1. Select USB, status is "open".

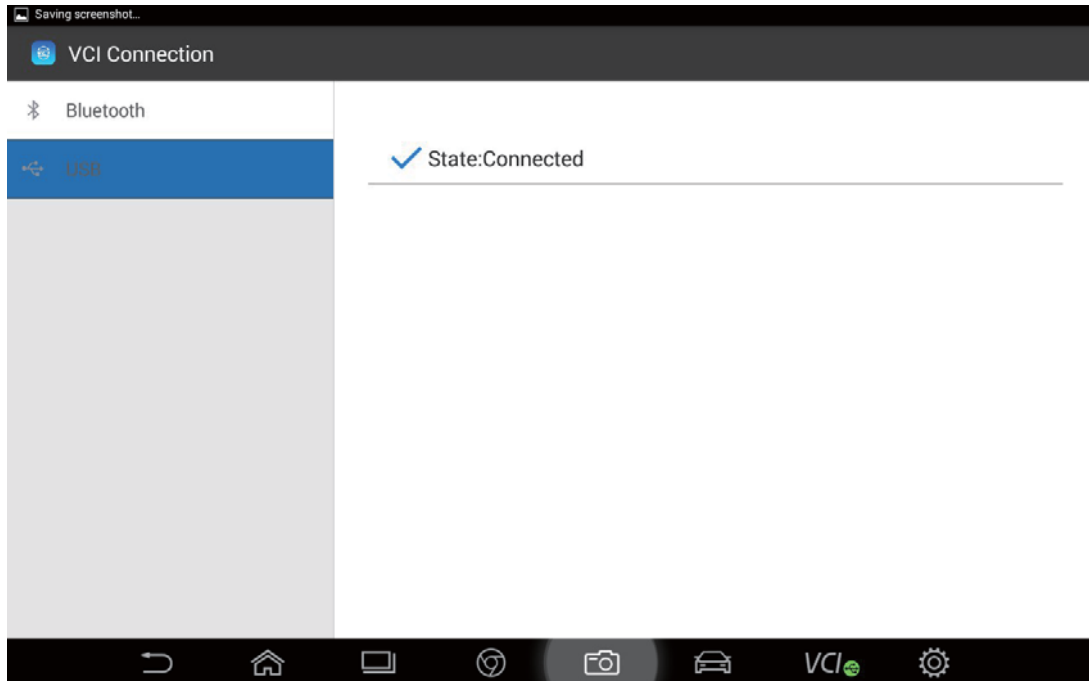

2. You will be prompted whether to connect F7S with the USB, click "OK".

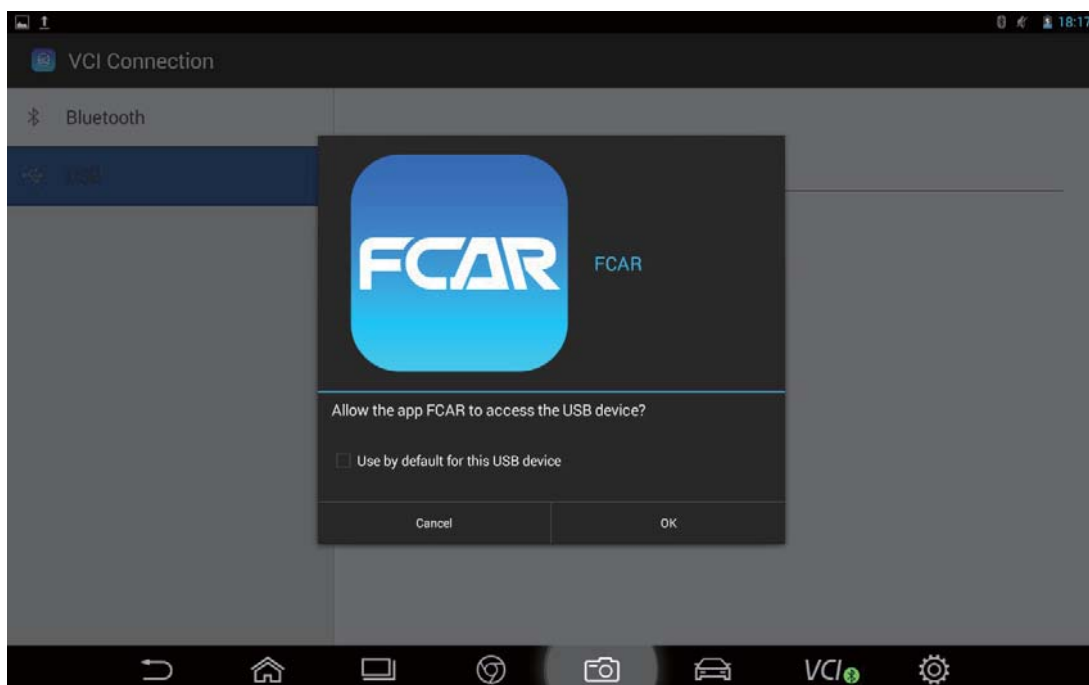

3. The USB indicator (green) on the VCI box will light, indicating successful connection.



## 4.2 Vehicle Diagnosis

Here we use the diesel version menu as an example. For actual situations, your purchased host program will be followed. Take the Yuchai Delphi Unit Pump I electronic control system as an example:

1. Open [Diagnosis] menu, and select [Diesel Engine] on the top.



2. Select the software version.

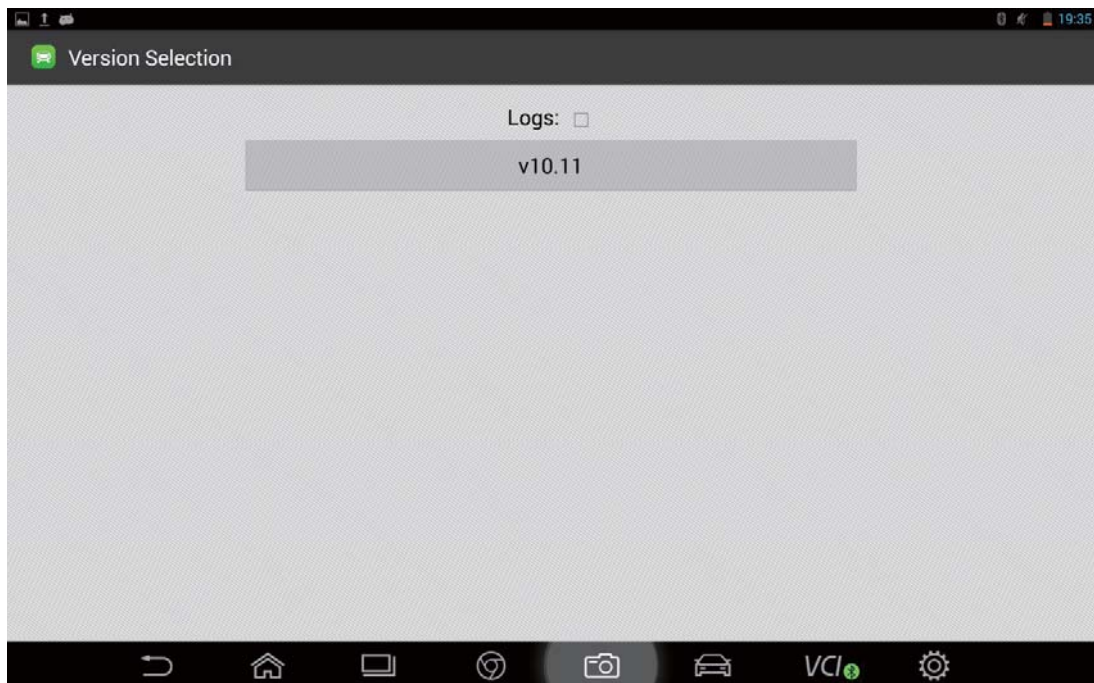

3. Select [Diesel Engine], since the Yuchai Delphi Unit Pump is diesel engine.

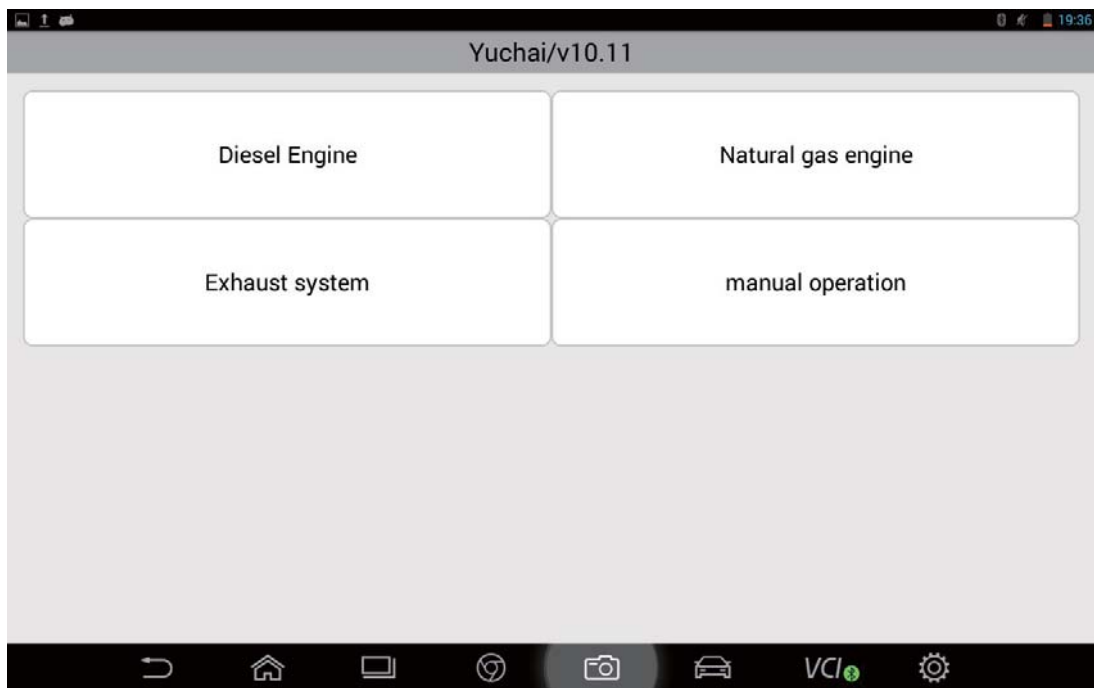

4. Select [Delphi system].

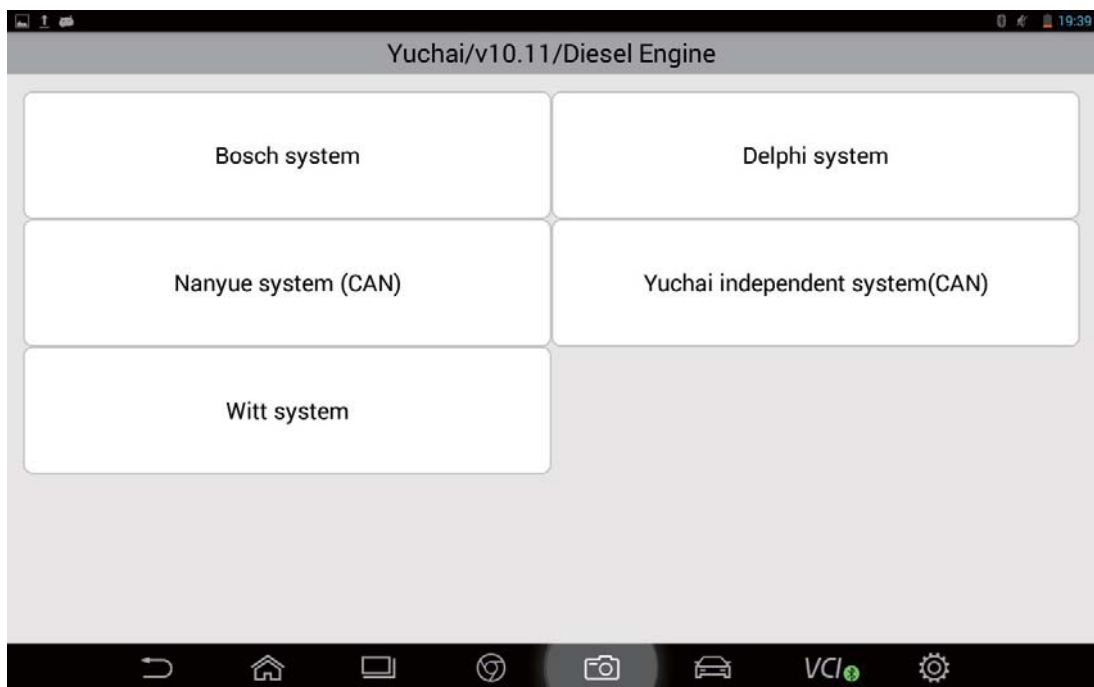

5. Click [Delphi Unit Pump].



6. Select [Delphi Unit Pump I].

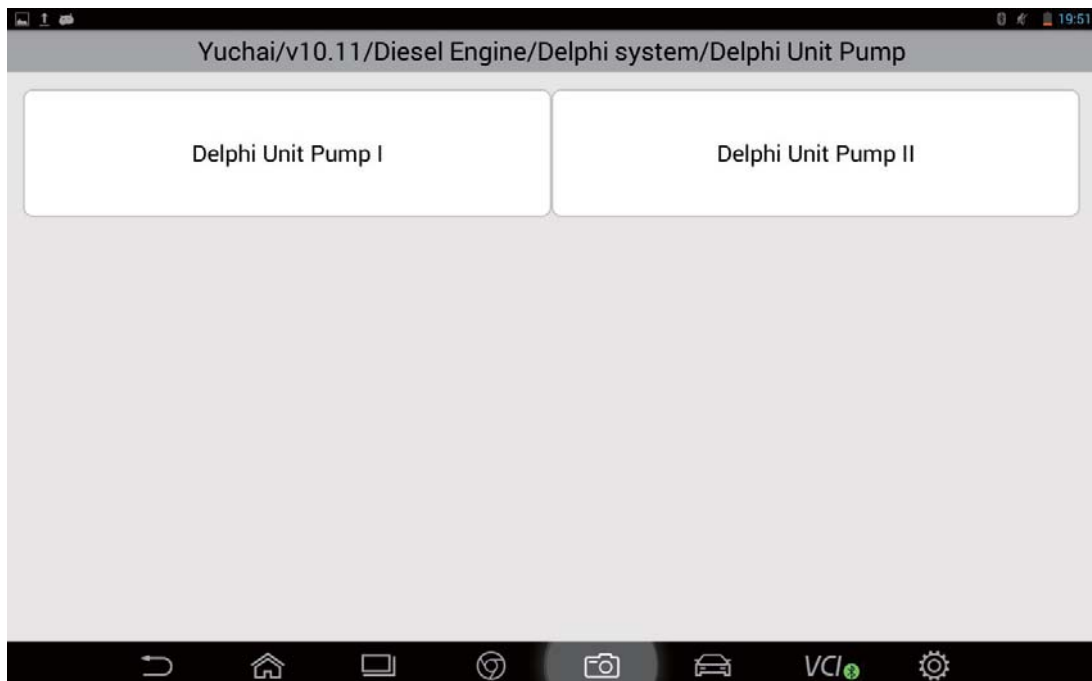

7. Click [Enter the System]. Being initialized, please wait.

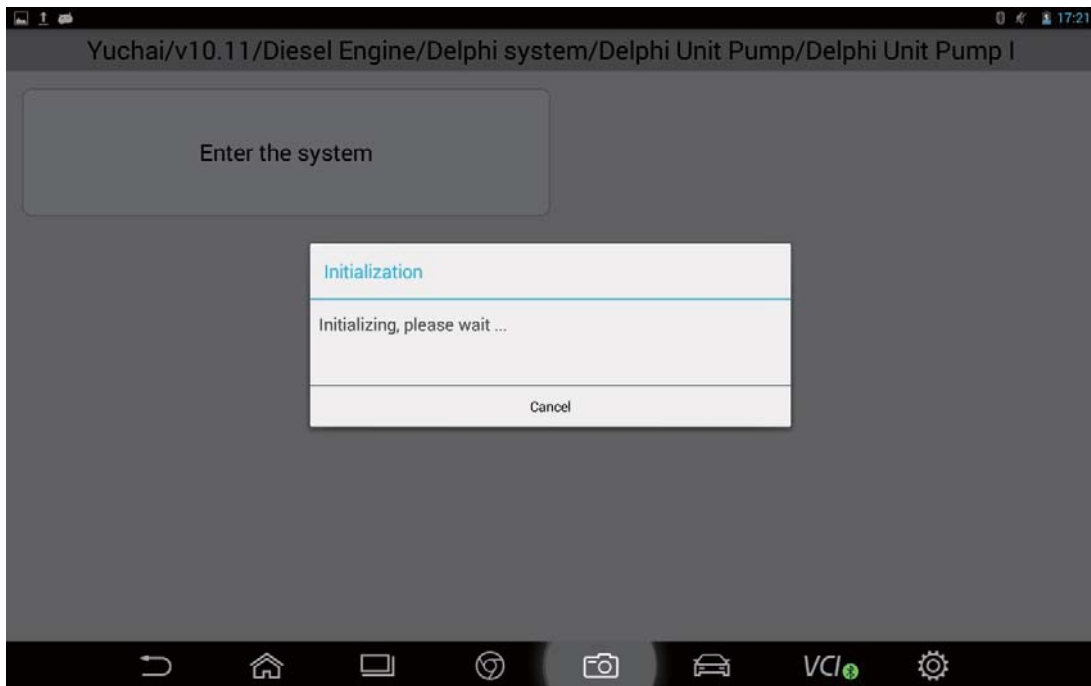

8. After that, Read ECU Information, Read Fault code, Erase Fault Code, Read Data Stream can be seen.

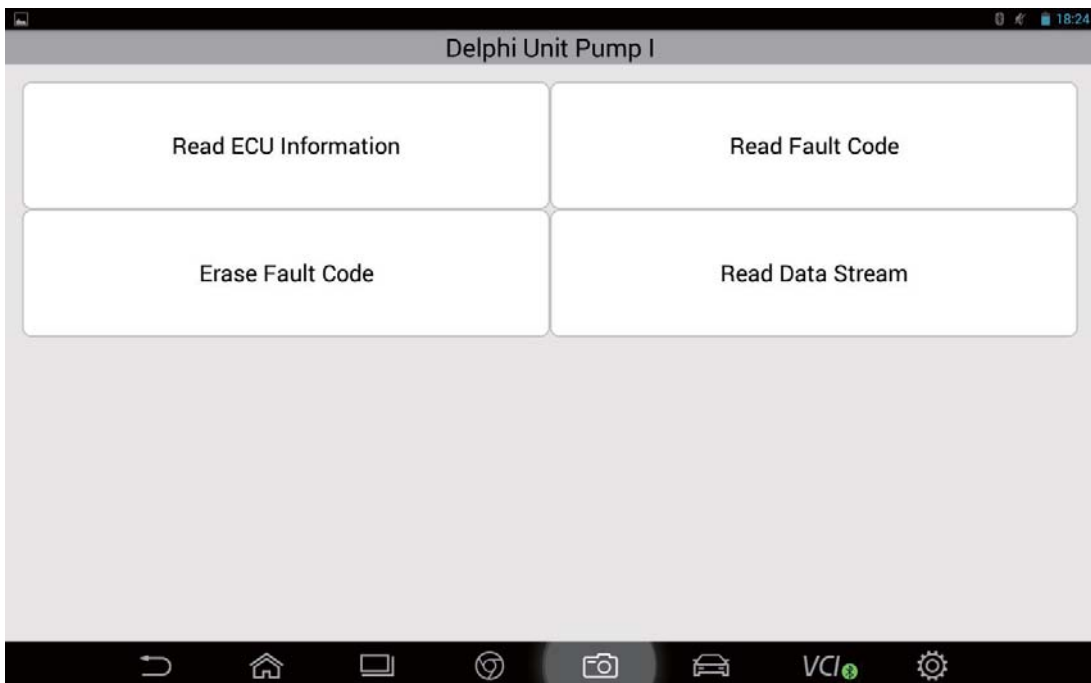

9. Function - Read Fault Code.

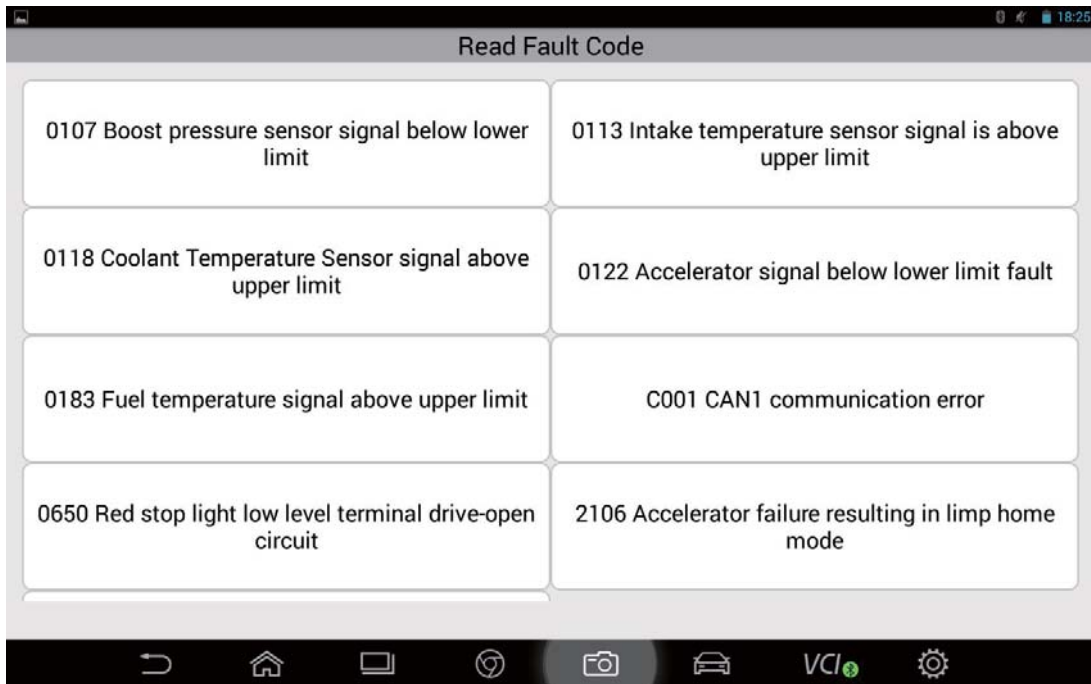

10. Function – Read Data Stream.

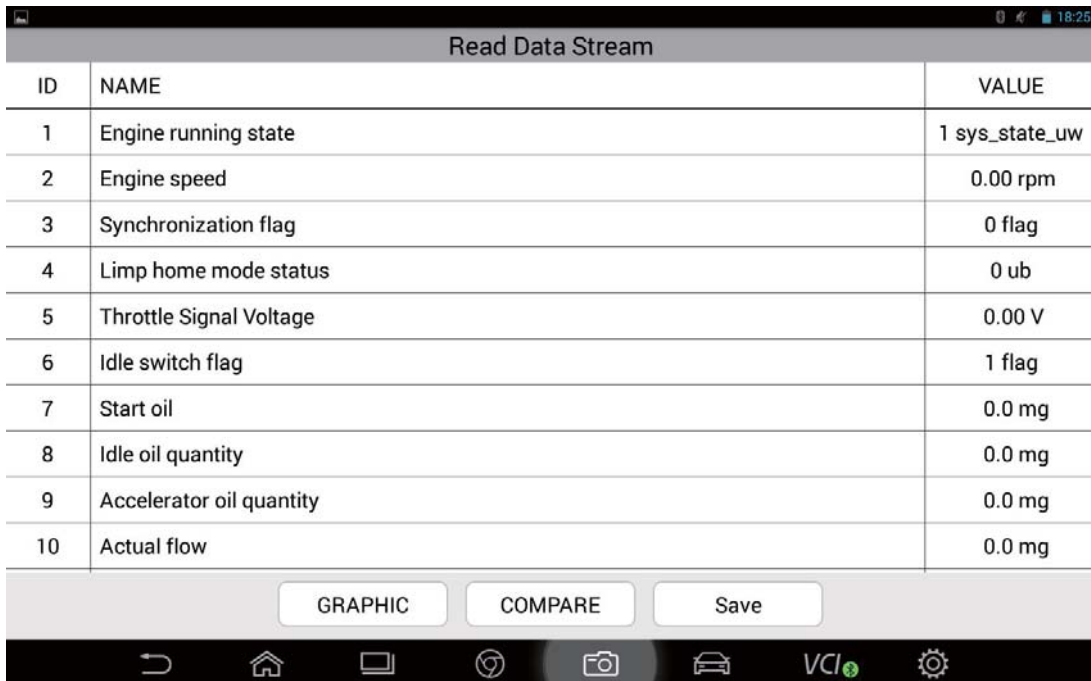



## Chapter V Upgrade and Activation

Customers who have purchased the FCAR product will need to activate the machine and regularly upgrade it and complete their personal information.

### 5.1 Upgrade

1. Click [Update].

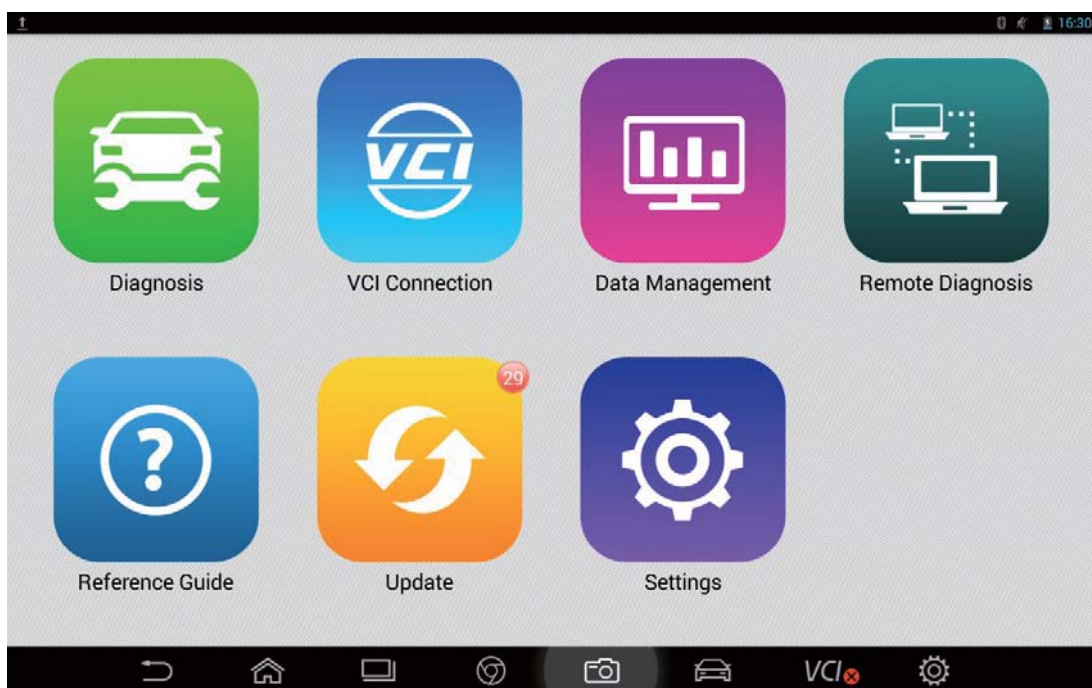

2. Click the Update icon to check whether a new model version is available.

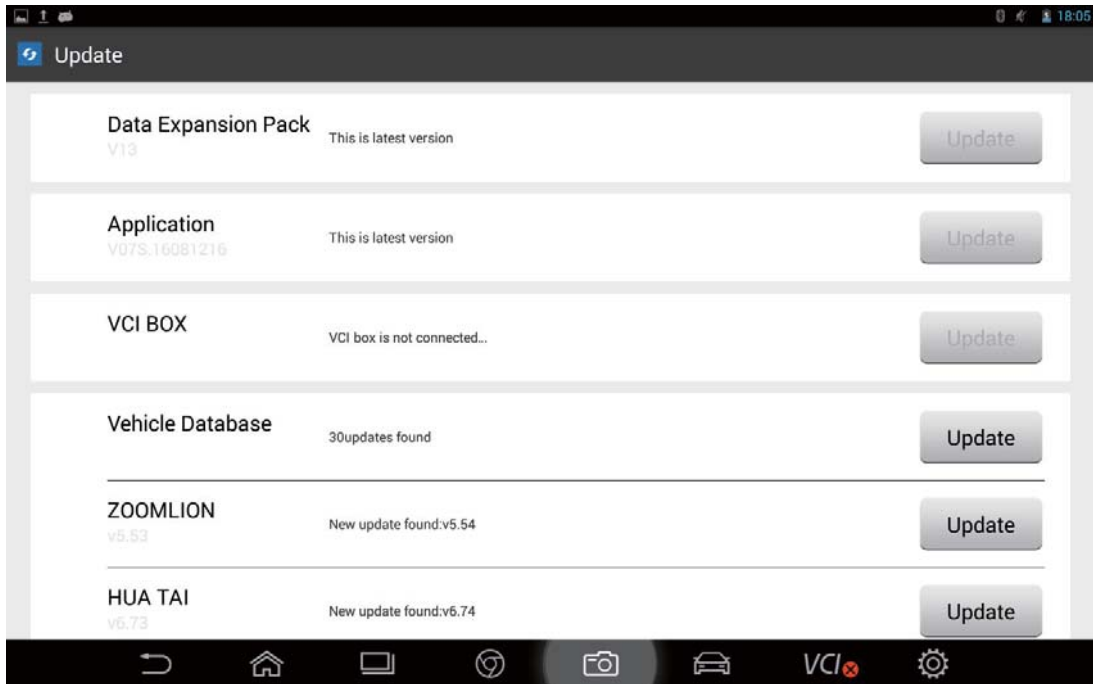

3. Click Update for the corresponding items.

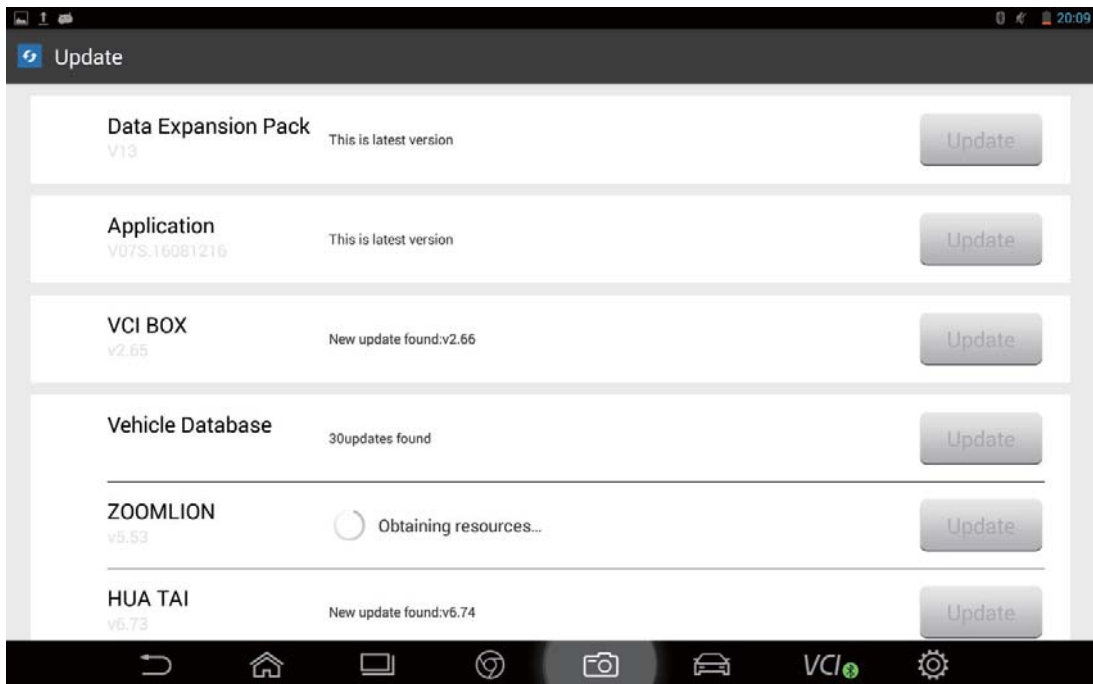

## 5.2 Activation

FCAR products have not yet been permanently activated when they leave the factory. After you power on the machine and select the model, you will be prompted: "You are using the trial version, \*\* time left ", Click [Activate] to enter the activation interface. Use the most convenient two-dimensional code to activate. The method is as follows:

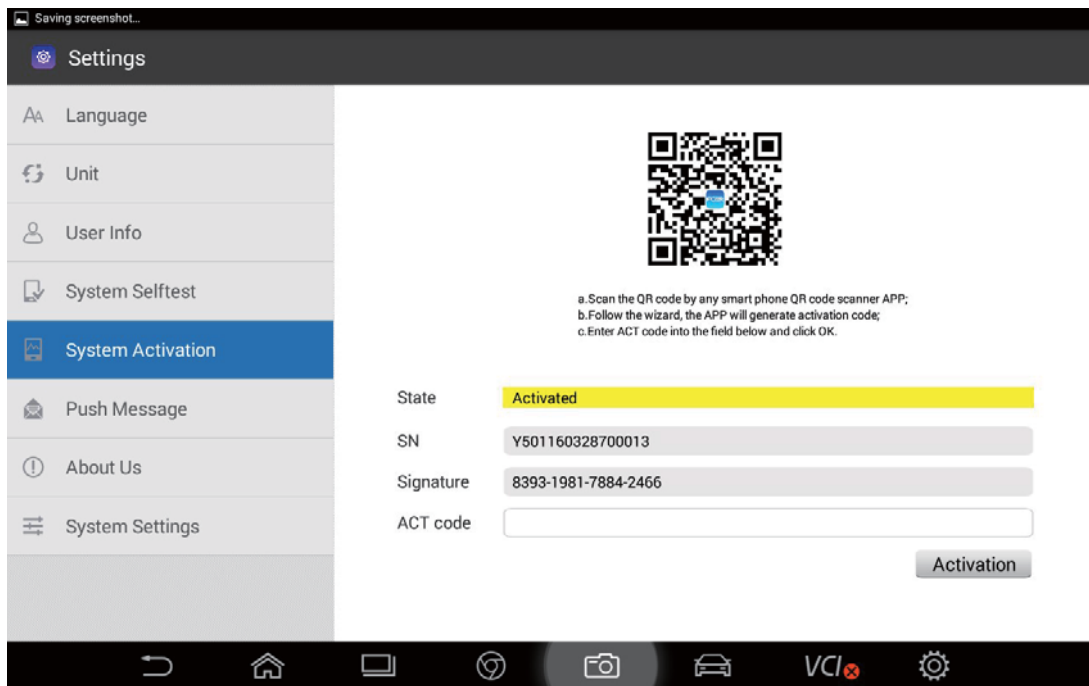

1. Open your WeChat or two-dimensional code tools. Select [Find] - [Scan].

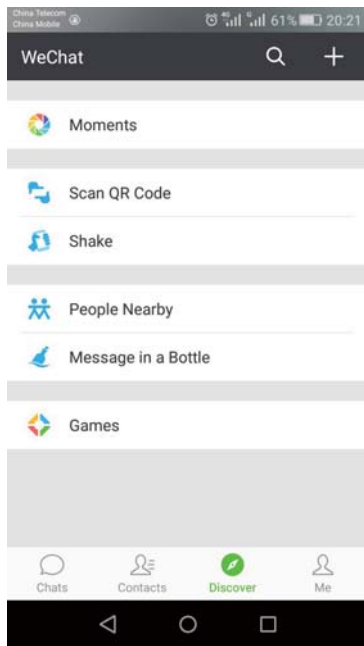

2. Scan the two-dimensional code in the machine interface.



3. Upon completion, the activation code will be displayed.

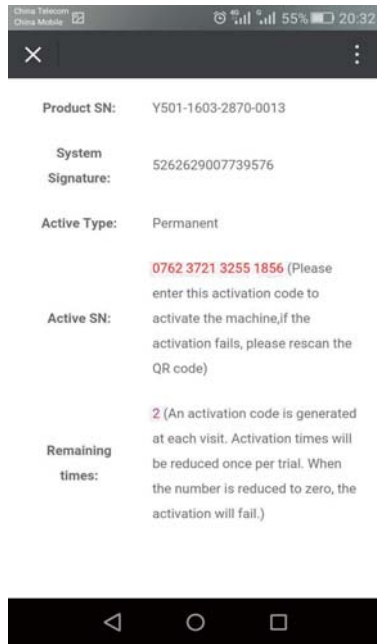

4. Fill in the activation code to the machine and click [Activate].

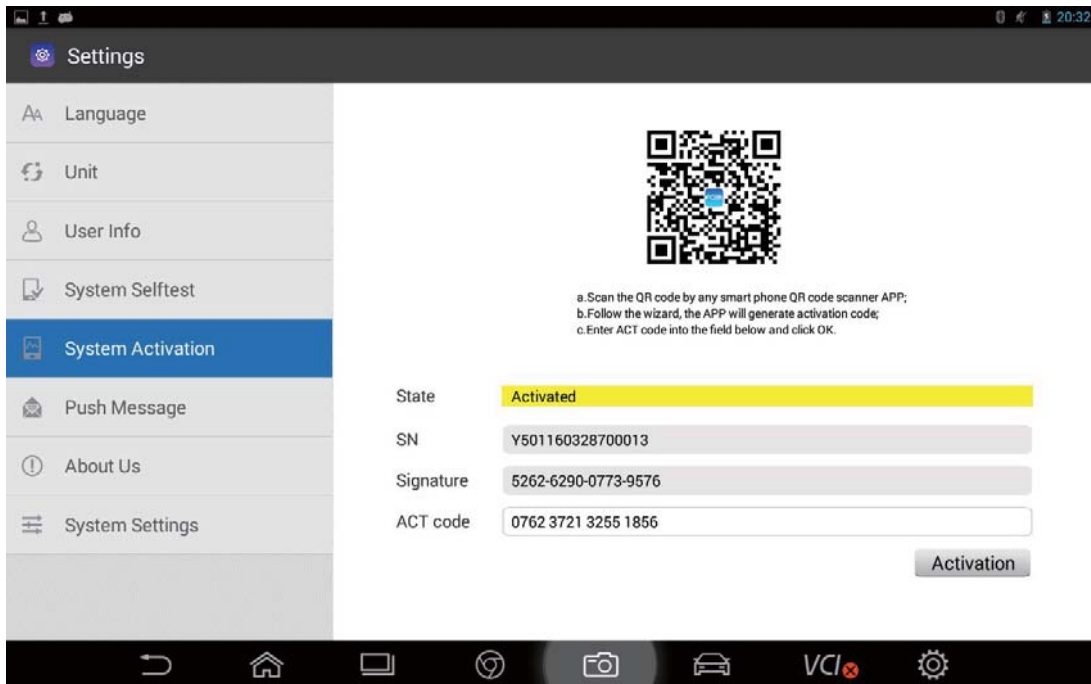

9. Activation successful.

If you are prompted with “Activation Failed”, start again.

## Chapter VI Warranty Clause

Thank you for choosing the FCAR F7S. In order to make the best use of the product, we recommend that you follow all recommendations for maintenance, storage, and operation in accordance with the user manual's instructions at all times. These requirements have been formulated to maximize the useful life of the product.

1. Under the following terms and conditions, and under the premise that you have activated our products and registered on the website of Shenzhen FCAR Technology Co., Ltd. (hereinafter referred to as "FCAR"), we will provide free product warranty services if there are defects in materials or workmanship of hardware.

2. Confirm that you have carefully read the product warranty clause. You will be considered to have agreed to and accepted the terms of this warranty clause when you have registered and completed your profile on our official website ([www.fcar.com](http://www.fcar.com)).

3. Your product must be purchased from a product dealer that has been authorized by FCAR. If products are purchased from anyone other than a FCAR authorized product dealer, buyers will be solely responsible for the cost of product maintenance services and will not be eligible to obtain any warranty from FCAR.

4. The following items are not included under the warranty: Items that are readily subject to wear and tear such as product instructions, inner and outer package box, promotional giveaways, SD card, card reader, touch pen, printing supplies etc.

5. Beginning on the date of purchase (subject to valid purchase proof and effective warranty card of the product), if the product suffers performance failure within one month which is not caused by deviation from the recommended operation or by uncontrollable environmental events, you can choose to have evaluation via our maintenance service or replacement of the product with the same model. After that, there is one year warranty service for the main unit, connectors and power adapter.

6. You will not be entitled to free warranty service under any of the following situations:

A.) Failures, defects or flaws not directly related to the quality of the FCAR products, including but not limited to failing to use the product according to the user manual's instructions, crash, fall, disassembly by anyone other than a FCAR approved service person, , connecting improper accessories, damage owing to impact because of improper transport or storage of the

---

product, erosion and/or corrosion caused by infiltration of liquid or food, etc.

B.) Natural wear and tear of the product: including but not limited to cover, keypad, touch screen, accessories etc.

C.) Main unit serial number and warranty card serial number discrepancy, product quality inspection tag or bar code removed, altered or damaged.

D.) Maintenance and modification without the approval of FCAR or FCAR distributors.7. Within the warranty period, you can take the following measures if product quality problems or failure occurred:

A.) You can inspect the product yourself based on product help information. If there are no hardware quality problems, try to upgrade the product program.

B.) You can dial FCAR customer service hotline (0086-755-82904730) to obtain the correct service information.

C.) After obtaining the company's authorization, the product must be sent to the designated address (See the official website) for repair and maintenance. Otherwise, your product can not receive timely repair and maintenance. Losses caused by customer negligence or failure to follow company instructions are at your peril.

8. During the product warranty repair process, you will bear the costs associated with delivering the product to the repair place designated by FCAR: Including product packaging, transportation, insurance and other expenses.

9. Within the product warranty period and under this warranty clause, you can obtain free warranty service for losses due to product defects. FCAR shall not be liable for your direct or indirect loss.

10. All product warranty information, product functions and specification changes will be posted on FCAR latest promotional materials and the official website. Changes may be made to the website or promotional materials without further notice.

**FCC Statement**

This equipment has been tested and found to comply with the limits for a Class B digital device, pursuant to Part 15 of the FCC Rules. These limits are designed to provide reasonable protection against harmful interference in a residential installation. This equipment generates uses and can radiate radio frequency energy and, if not installed and used in accordance with the instructions, may cause harmful interference to radio communications. However, there is no guarantee that interference will not occur in a particular installation. If this equipment does cause harmful interference to radio or television reception, which can be determined by turning the equipment off and on, the user is encouraged to try to correct the interference by one or more of the following measures:

- Reorient or relocate the receiving antenna.
- Increase the separation between the equipment and receiver.
- Connect the equipment into an outlet on a circuit different from that to which the receiver is connected.
- Consult the dealer or an experienced radio/TV technician for help.

Changes or modifications not expressly approved by the party responsible for compliance could void the user's authority to operate the equipment.

**Caution:**

(i) the device for operation in the band 5150 - 5250 MHz is only for indoor use to reduce the potential for harmful interference to co-channel mobile satellite systems.

**RF Exposure Information (SAR)**

This device meets the government's requirements for exposure to radio waves. This device is designed and manufactured not to exceed the emission limits for exposure to radio frequency (RF) energy set by the Federal Communications Commission of the U.S. Government.

For body worn operation, this device has been tested and meets the FCC RF exposure.

Shenzhen Fcar Technology Co., Ltd.

Headquarters: 8F, Chuangyi Bldg., No. 3025 Nanhai Ave., Nanshan, Shenzhen, China 518060

Factory: West 1F, Bldg. B, Hengchao Industrial Park, Tangtou North Ave., Bao'an, Shenzhen, China 518108

Tel: 0086-755-82904730

Fax: 0086-755-83147605

E-mail: [marketing@szfcar.com](mailto:marketing@szfcar.com)





Shenzhen Fcar Technology Co., Ltd.



Shenzhen Fcar Technology Co., Ltd.



## Certification

**This product has been strictly inspected as qualified products and met the company standards.**

Product name	
Product serial number	
Date of production	
Inspector	



## Warranty card

Product name	
Product serial number	
Purchase date	

**Company name:** \_\_\_\_\_

**User address:** \_\_\_\_\_

**Contact person:** \_\_\_\_\_

**Contact number:** \_\_\_\_\_

