

**FCC TEST REPORT**  
**FOR**  
**Urbanista AB**  
**Urbanista Berlin**  
**Model No.: Urbanista Madrid**  
**Additional Model No.: Please refer to page 6**

Prepared for : Urbanista AB  
Address : Master Samuelsgatan 10, 111 44, Stockholm, Sweden

Prepared by : Shenzhen LCS Compliance Testing Laboratory Ltd.  
Address : 1/F., Xingyuan Industrial Park, Tongda Road, Bao'an Avenue,  
Bao'an District, Shenzhen, Guangdong, China

Tel : (+86)755-82591330  
Fax : (+86)755-82591332  
Web : www.LCS-cert.com  
Mail : webmaster@LCS-cert.com

Date of receipt of test sample : August 15, 2017  
Number of tested samples : 2  
Serial number : Prototype  
Date of Test : August 15, 2017~September 15, 2017  
Date of Report : September 15, 2017

**FCC TEST REPORT**  
**FCC CFR 47 PART 15 C(15.247): 2016**

**Report Reference No.** ..... : **LCS170815122AE**  
Date of Issue ..... : September 15, 2017

**Testing Laboratory Name** ..... : **Shenzhen LCS Compliance Testing Laboratory Ltd.**  
Address ..... : 1/F., Xingyuan Industrial Park, Tongda Road, Bao'an Avenue,  
Bao'an District, Shenzhen, Guangdong, China  
Testing Location/ Procedure..... : Full application of Harmonised standards ■  
Partial application of Harmonised standards □  
Other standard testing method □

**Applicant's Name** ..... : **Urbanista AB**  
Address ..... : Master Samuelsgatan 10, 111 44, Stockholm, Sweden

**Test Specification**  
Standard..... : FCC CFR 47 PART 15 C(15.247): 2016  
Test Report Form No. .... : LCSEMC-1.0  
TRF Originator ..... : Shenzhen LCS Compliance Testing Laboratory Ltd.  
Master TRF ..... : Dated 2011-03

**Shenzhen LCS Compliance Testing Laboratory Ltd. All rights reserved.**  
This publication may be reproduced in whole or in part for non-commercial purposes as long as the Shenzhen LCS Compliance Testing Laboratory Ltd. is acknowledged as copyright owner and source of the material. Shenzhen LCS Compliance Testing Laboratory Ltd. takes no responsibility for and will not assume liability for damages resulting from the reader's interpretation of the reproduced material due to its placement and context.

**Test Item Description.** ..... : **Urbanista Berlin**  
Trade Mark..... : Urbanista  
Model/ Type reference..... : Urbanista Madrid  
Ratings ..... : DC 3.7V by Lithium ion polymer battery (70mAh)  
Recharge Voltage: DC 5V  
**Result** ..... : **Positive**

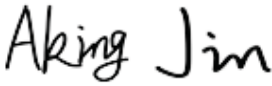
**Compiled by:**  
  
Aking Jin/ File administrators

**Supervised by:**  
  
Dick Su/ Technique principal

**Approved by:**  
  
Gavin Liang/ Manager

### FCC -- TEST REPORT

<b>Test Report No. :</b> LCS170815122AE	<u>September 15, 2017</u> Date of issue
---	--

EUT.....	: Urbanista Berlin
Type / Model.....	: Urbanista Madrid
<b>Applicant.....</b>	<b>: Urbanista AB</b>
Address.....	: Master Samuelsgatan 10, 111 44, Stockholm, Sweden
Telephone.....	: /
Fax.....	: /
<b>Manufacturer.....</b>	<b>: Iglory Limited</b>
Address.....	: 4 floor, No 2223, C buiding, Xuegang road, Bantian street, Longgang, Shenzhen, Guangdong, China
Telephone.....	: /
Fax.....	: /
<b>Factory.....</b>	<b>: Iglory Limited</b>
Address.....	: 4 floor, No 2223, C buiding, Xuegang road, Bantian street, Longgang, Shenzhen, Guangdong, China
Telephone.....	: /
Fax.....	: /

<b>Test Result</b>	<b>Positive</b>
--------------------	-----------------

The test report merely corresponds to the test sample.  
It is not permitted to copy extracts of these test result without the written permission of the test laboratory.

## Revision History

Revision	Issue Date	Revisions	Revised By
00	September 15, 2017	Initial Issue	Gavin Liang

## TABLE OF CONTENTS

Description	Page
<b>1. GENERAL INFORMATION .....</b>	<b>6</b>
1.1 Description of Device (EUT).....	6
1.2. Host System Configuration List and Details .....	6
1.3. External I/O Cable.....	6
1.4. Description of Test Facility .....	6
1.5. Statement of the Measurement Uncertainty .....	7
1.6. Measurement Uncertainty.....	7
1.7 Description of Test Modes .....	7
<b>2. TEST METHODOLOGY.....</b>	<b>8</b>
2.1 EUT Configuration.....	8
2.2 EUT Exercise .....	8
2.3 General Test Procedures.....	8
<b>3. SYSTEM TEST CONFIGURATION .....</b>	<b>9</b>
3.1 Justification.....	9
3.2 EUT Exercise Software .....	9
3.3 Special Accessories.....	9
3.4 Block Diagram/Schematics.....	9
3.5 Equipment Modifications .....	9
3.6 Test Setup .....	9
<b>4. SUMMARY OF TEST RESULTS.....</b>	<b>10</b>
<b>5. SUMMARY OF TEST EQUIPMENT .....</b>	<b>11</b>
<b>6. ANTENNA PORT MEASUREMENT .....</b>	<b>12</b>
6.1 Peak Power .....	12
6.2 Frequency Separation and 20 dB Bandwidth .....	15
6.3 Number of Hopping Frequency.....	22
6.4 Time of Occupancy (Dwell Time) .....	24
6.5 Conducted Spurious Emissions and Band Edges Test .....	27
<b>7. RADIATED MEASUREMENT .....</b>	<b>33</b>
<b>8. POWER LINE CONDUCTED EMISSIONS .....</b>	<b>41</b>
<b>9. BAND-EDGE MEASUREMENTS FOR RADIATED EMISSIONS .....</b>	<b>44</b>
<b>10. ANTENNA REQUIREMENT.....</b>	<b>48</b>
<b>11. TEST SETUP PHOTOGRAPHS OF EUT.....</b>	<b>50</b>
<b>12. EXTERIOR PHOTOGRAPHS OF THE EUT.....</b>	<b>50</b>
<b>13. INTERIOR PHOTOGRAPHS OF THE EUT .....</b>	<b>50</b>

# 1. GENERAL INFORMATION

## 1.1 Description of Device (EUT)

EUT : Urbanista Berlin  
 Model Number : Urbanista Madrid Fluffy Cloud, Urbanista Madrid Blue Petroleum, Urbanista Madrid Dark Clown, Urbanista Madrid Rose Gold, Urbanista Madrid  
 Model Declaration : PCB board, structure and internal of these model(s) are the same, So no additional models were tested.  
 Test Model : Urbanista Madrid  
 Hardware version : V1.0  
 Software version : V1.0  
 Power Supply : DC 3.7V by Lithium ion polymer battery (70mAh)  
 Recharge Voltage: DC 5V

Bluetooth Technology  
 Operation frequency : 2402MHz-2480MHz  
 Modulation Type : GFSK,  $\pi/4$ -DQPSK, 8-DPSK for Bluetooth 4.0 DSS  
 GFSK for Bluetooth 4.0 DTS

Bluetooth Version : 4.0  
 Channel Number : 79 channels for Bluetooth 4.0 DSS  
 40 channels for Bluetooth 4.0 DTS

Channel Spacing : 1MHz for Bluetooth 4.0 DSS  
 2MHz for Bluetooth 4.0 DTS

Antenna Type : Ceramic Antenna  
 Antenna Gain : 0dBi (Max.)  
 Extreme temp. Tolerance : -20°C to +45°C

## 1.2. Host System Configuration List and Details

Manufacturer	Description	Model	Serial Number	Certificate
--	--	--	--	--

## 1.3. External I/O Cable

I/O Port Description	Quantity	Cable
Micro USB	1	N/A

## 1.4. Description of Test Facility

CNAS Registration Number. is L4595.  
 FCC Registration Number. is CN5024.  
 Industry Canada Registration Number. is 9642A-1.  
 ESMD Registration Number. is ARCB0108.  
 UL Registration Number. is 100571-492.  
 TUV SUD Registration Number. is SCN1081.  
 TUV RH Registration Number. is UA 50296516-001  
 NVLAP Registration Code is 600167-0.  
 The 3m-Semi anechoic test site fulfils CISPR 16-1-4 according to ANSI C63.4:2014 and CISPR 16-1-4:2010 SVSWR requirement for radiated emission above 1GHz.

### 1.5. Statement of the Measurement Uncertainty

The data and results referenced in this document are true and accurate. The reader is cautioned that there may be errors within the calibration limits of the equipment and facilities. The measurement uncertainty was calculated for all measurements listed in this test report acc. To CISPR 16 – 4 “Specification for radio disturbance and immunity measuring apparatus and methods – Part 4: Uncertainty in EMC Measurements” and is documented in the LCS quality system acc. To DIN EN ISO/IEC 17025. Furthermore, component and process variability of devices similar to that tested may result in additional deviation. The manufacturer has the sole responsibility of continued compliance of the device.

### 1.6. Measurement Uncertainty

Test Item	Frequency Range	Uncertainty	Note
Radiation Uncertainty :	9KHz~30MHz	±3.10dB	(1)
	30MHz~200MHz	±2.96dB	(1)
	200MHz~1000MHz	±3.10dB	(1)
	1GHz~26.5GHz	±3.80dB	(1)
	26.5GHz~40GHz	±3.90dB	(1)
Conduction Uncertainty :	150kHz~30MHz	±1.63dB	(1)
Power disturbance :	30MHz~300MHz	±1.60dB	(1)

(1). This uncertainty represents an expanded uncertainty expressed at approximately the 95% confidence level using a coverage factor of k=2.

### 1.7 Description of Test Modes

Bluetooth operates in the unlicensed ISM Band at 2.4GHz. With basic data rate feature, the data rates can be up to 1 Mb/s by modulating the RF carrier using GFSK techniques. The EUT works in the X-axis, Y-axis, Z-axis. The following operating modes were applied for the related test items. All test modes were tested, only the result of the worst case was recorded in the report.

Mode of Operations	Frequency Range (MHz)	Data Rate (Mbps)
BT V4.0 DSS	2402	1/2/3
	2441	1/2/3
	2480	1/2/3
For Conducted Emission		
Test Mode	TX Mode	
For Radiated Emission		
Test Mode	TX Mode	

Worst-case mode and channel used for 150 KHz-30 MHz power line conducted emissions was the mode and channel with the highest output power that was determined to be TX (1Mbps).

Worst-case mode and channel used for 9 KHz-1000 MHz radiated emissions was the mode and channel with the highest output power, that was determined to be TX(1Mbps-Low Channel).

AC conducted emission pre-test at both at AC 120V/60Hz and AC 240V/50Hz modes, recorded worst case;

## 2. TEST METHODOLOGY

The tests documented in this report were performed in accordance with ANSI C63.10-2013, FCC CFR PART 15C 15.207, 15.209, 15.247 and DA 00-705.

### 2.1 EUT Configuration

The EUT configuration for testing is installed on RF field strength measurement to meet the Commissions requirement and operating in a manner that intends to maximize its emission characteristics in a continuous normal application.

### 2.2 EUT Exercise

The EUT was operated in the normal operating mode for Hopping Numbers and Dwell Time test and a continuous transmits mode for other tests.

According to its specifications, the EUT must comply with the requirements of the Section 15.207, 15.209, 15.247 under the FCC Rules Part 15 Subpart C.

### 2.3 General Test Procedures

#### 2.3.1 Conducted Emissions

The EUT is directly placed on the ground. According to the requirements in Section 6.2.1 of ANSI C63.10-2013 Conducted emissions from the EUT measured in the frequency range between 0.15 MHz and 30MHz using Quasi-peak and average detector modes.

#### 2.3.2 Radiated Emissions

The EUT is placed on a turntable, which is directly placed on the ground. The turntable shall rotate 360 degrees to determine the position of maximum emission level. EUT is set 3m away from the receiving antenna, which varied from 1m to 4m to find out the highest emission. And also, each emission was to be maximized by changing the polarization of receiving antenna both horizontal and vertical. In order to find out the maximum emissions, exploratory radiated emission measurements were made according to the requirements in Section 6.3 of ANSI C63.10-2013

### 2.4. Test Sample

The application provides 2 samples to meet requirement;

Sample Number	Description
Sample 1	Engineer sample – continuous transmit
Sample 2	Normal sample – Intermittent transmit



### 3. SYSTEM TEST CONFIGURATION

#### 3.1 Justification

The system was configured for testing in a continuous transmits condition.

#### 3.2 EUT Exercise Software

The system was configured for Bluetooth testing in a continuous transmits condition and change test channels by software (InstallBlueSuite2\_4\_8) provided by application.

#### 3.3 Special Accessories

No.	Equipment	Manufacturer	Model No.	Serial No.	Length	shielded/ unshielded	Notes
1	PC	Lenovo	Ideapad	A131101550	/	/	DOC
2	Power adapter	Lenovo	CPA-A090	36200414	1.00m	unshielded	DOC

#### 3.4 Block Diagram/Schematics

Please refer to the related document.

#### 3.5 Equipment Modifications

Shenzhen LCS Compliance Testing Laboratory Ltd. has not done any modification on the EUT.

#### 3.6 Test Setup

Please refer to the test setup photo.

#### 4. SUMMARY OF TEST RESULTS

Applied Standard: FCC Part 15 Subpart C			
FCC Rules	Description of Test	Test Sample	Result
§15.247(b)(1)	Maximum Conducted Output Power	Sample 1	Compliant
§15.247(c)	Frequency Separation And 20 dB Bandwidth	Sample 1	Compliant
§15.247(a)(1)(ii)	Number Of Hopping Frequency	Sample 2	Compliant
§15.247(a)(1)(iii)	Time Of Occupancy (Dwell Time)	Sample 2	Compliant
§15.209, §15.247(d)	Radiated and Conducted Spurious Emissions	Sample 1	Compliant
§15.205	Emissions at Restricted Band	Sample 1	Compliant
§15.207(a)	Conducted Emissions	Sample 1	Compliant
§15.203	Antenna Requirements	Sample 1	Compliant
§15.247(i)§2.1093	RF Exposure	N/A	Compliant

## 5. SUMMARY OF TEST EQUIPMENT

Item	Equipment	Manufacturer	Model No.	Serial No.	Last Cal.	Next Cal.
1	Power Sensor	R&S	NRV-Z81	100458	2017-06-17	2018-06-16
2	Power Sensor	R&S	NRV-Z32	10057	2017-06-17	2018-06-16
3	Power Meter	R&S	NRVS	100444	2017-06-17	2018-06-16
4	DC Filter	MPE	23872C	N/A	2017-06-17	2018-06-16
5	RF Cable	Harbour Industries	1452	N/A	2017-06-17	2018-06-16
6	SMA Connector	Harbour Industries	9625	N/A	2017-06-17	2018-06-16
7	Spectrum Analyzer	Agilent	N9020A	MY50510140	2016-10-27	2017-10-26
8	Signal analyzer	Agilent	E4448A(External mixers to 40GHz)	US44300469	2017-06-15	2018-06-14
9	RF Cable	Hubersuhne	Sucoflex104	FP2RX2	2017-06-17	2018-06-16
10	3m Semi Anechoic Chamber	SIDT FRANKONIA	SAC-3M	03CH03-HY	2017-06-17	2018-06-16
11	Amplifier	SCHAFFNER	COA9231A	18667	2017-06-17	2018-06-16
12	Amplifier	Agilent	8449B	3008A02120	2017-06-15	2018-06-14
13	Amplifier	MITEQ	AMF-6F-260400	9121372	2017-06-15	2018-06-14
14	Loop Antenna	R&S	HFH2-Z2	860004/001	2017-06-17	2018-06-16
15	By-log Antenna	SCHWARZBECK	VULB9163	9163-470	2017-06-09	2018-06-08
16	Horn Antenna	EMCO	3115	6741	2017-06-09	2018-06-08
17	Horn Antenna	SCHWARZBECK	BBHA9170	BBHA9170154	2017-06-09	2018-06-08
18	RF Cable-R03m	Jye Bao	RG142	CB021	2017-06-17	2018-06-16
19	RF Cable-HIGH	SUHNER	SUCOFLEX 106	03CH03-HY	2017-06-17	2018-06-16
20	EMI Test Receiver	R&S	ESCI	101142	2017-06-17	2018-06-16
21	Artificial Mains	R&S	ENV216	101288	2017-06-17	2018-06-16
22	EMI Test Software	AUDIX	E3	N/A	2017-06-17	2018-06-16
23	Spectrum Analyzer	R&S	FSP	100503	2017-06-17	2018-06-16

## 6. ANTENNA PORT MEASUREMENT

### 6.1 Peak Power

#### 6.1.1 Block Diagram of Test Setup

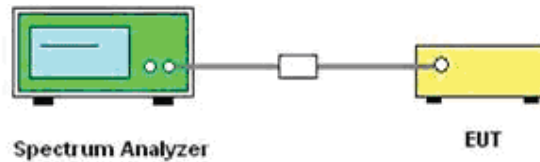

#### 6.1.2 Limit

According to §15.247(b)(1), For frequency hopping systems operating in the 2400–2483.5 MHz band employing at least 75 non-overlapping hopping channels, and all frequency hopping systems in the 5725–5850 MHz band: 1 watt. For all other frequency hopping systems in the 2400–2483.5 MHz band: 0.125 watts.

#### 6.1.3 Test Procedure

Use the following spectrum analyzer settings:

Span = approximately 5 times the 20 dB bandwidth, centered on a hopping channel

RBW > the 20 dB bandwidth of the emission being measured

VBW ≥ RBW

Sweep = auto

Detector function = peak

Trace = max hold

Allow the trace to stabilize. Use the marker-to-peak function to set the marker to the peak of the emission. The indicated level is the peak output power

#### 6.1.4 Test Results

Test Mode	Channel	Frequency (MHz)	Measured Maximum Power (dBm)	Limits (dBm)	Verdict
GFSK	0	2402	4.595	30.00	PASS
	39	2441	4.145		
	78	2480	3.633		
π/4DQPSK	0	2402	3.475	21.00	PASS
	39	2441	3.221		
	78	2480	2.704		
8DPSK	0	2402	3.578	21.00	PASS
	39	2441	3.327		
	78	2480	2.790		

**Remark:**

1. Test results including cable loss;
2. Measured output power at difference Packet Type for each mode and recorded worst case for each mode.
3. Worst case data at DH5 for GFSK, 2DH5 for π/4DQPSK, 3DH5 for 8DPSK modulation type;
4. Please refer to following test plots;

Peak Output Power

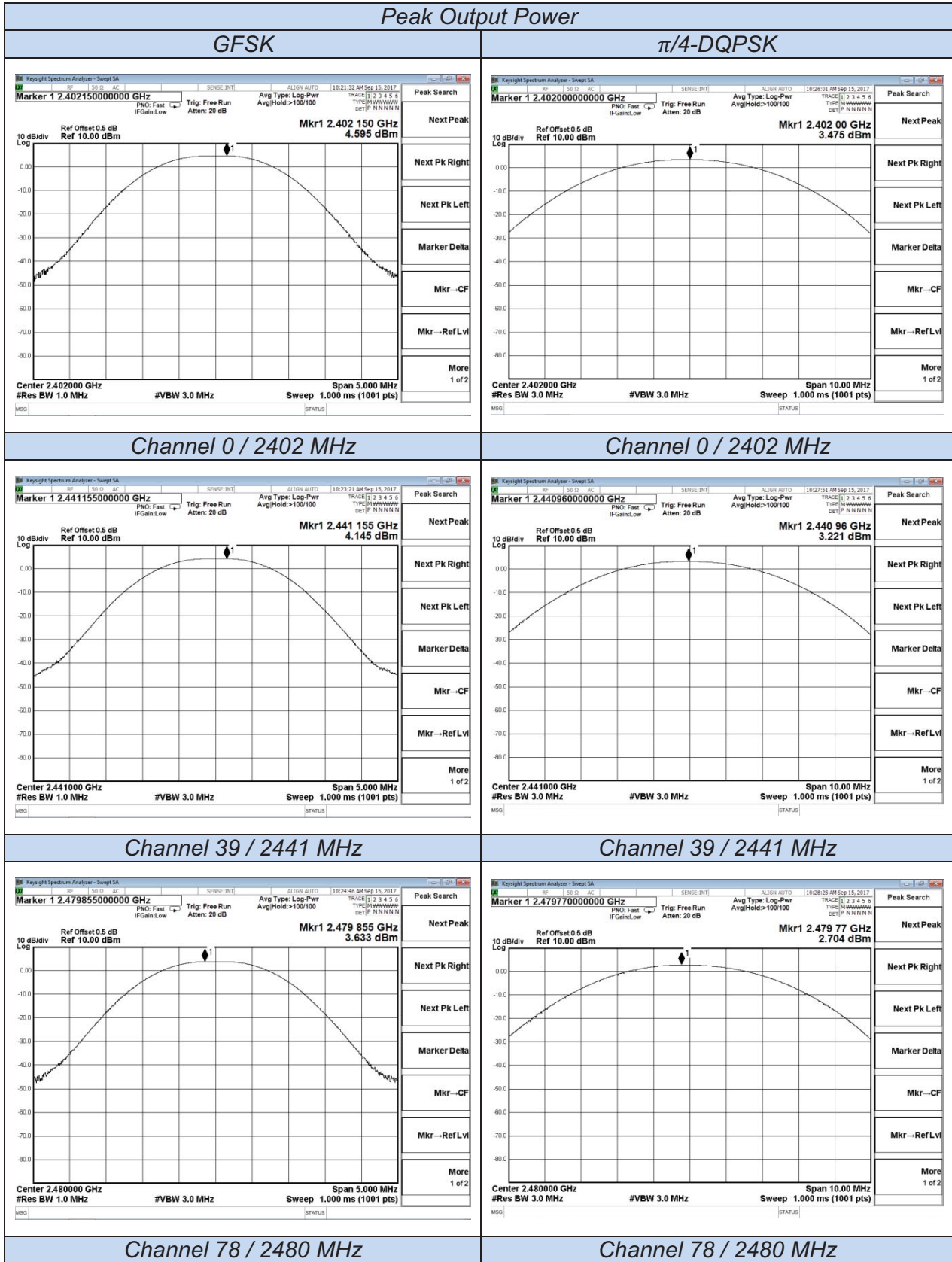

Peak Output Power

8DPSK

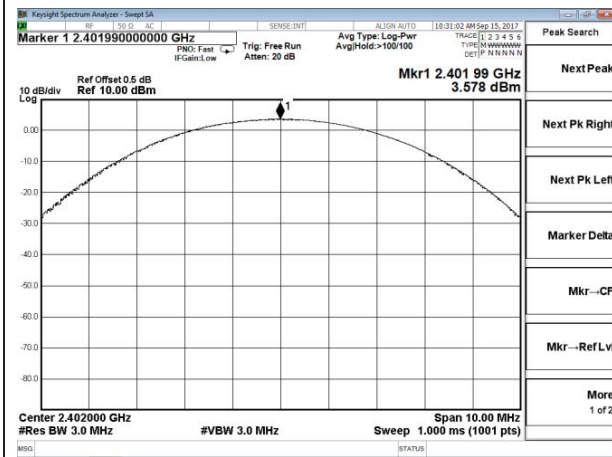

- Peak Search
- Next Peak
- Next Pk Right
- Next Pk Left
- Marker Delta
- Mkr--CF
- Mkr--RefLvl
- More 1 of 2

Channel 0 / 2402 MHz

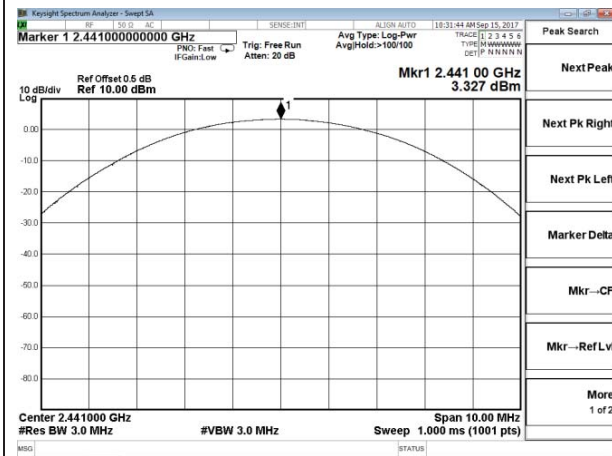

- Peak Search
- Next Peak
- Next Pk Right
- Next Pk Left
- Marker Delta
- Mkr--CF
- Mkr--RefLvl
- More 1 of 2

Channel 39 / 2441 MHz

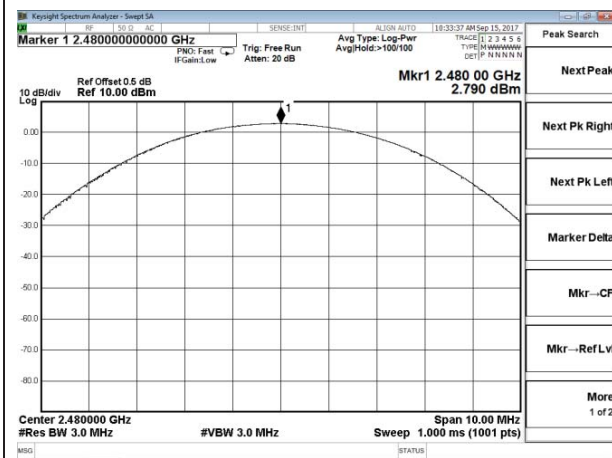

- Peak Search
- Next Peak
- Next Pk Right
- Next Pk Left
- Marker Delta
- Mkr--CF
- Mkr--RefLvl
- More 1 of 2

Channel 78 / 2480 MHz

## 6.2 Frequency Separation and 20 dB Bandwidth

### 6.2.1 Limit

According to §15.247(c) or A8.1(a), in any 100 kHz bandwidth outside the frequency bands in which the spread spectrum intentional radiator is operating, the radio frequency power that is produced by the intentional radiator shall be at least 20dB below that in the 100kHz bandwidth within the band that contains the highest level of the desired power, In addition, radiated emissions which fall in the restricted bands, as defined in §15.205(a), must also comply with the radiated emission limits specified in 15.209(a).

### 6.2.2 Block Diagram of Test Setup

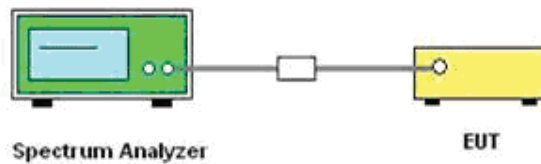

### 6.2.3 Test Procedure

Frequency separation test procedure :

- 1). Place the EUT on the table and set it in transmitting mode.
- 2). Remove the antenna from the EUT and then connect a low loss RF cable from the antenna port to the Spectrum Analyzer.
- 3). Set center frequency of Spectrum Analyzer = middle of hopping channel.
- 4). Set the Spectrum Analyzer as RBW = 100 KHz, VBW = 300 KHz, Span = wide enough to capture the peaks of two adjacent channels, Sweep = auto.
- 5). Max hold, mark 2 peaks of hopping channel and record the 2 peaks frequency.

20dB bandwidth test procedure :

- 1). Span = approximately 2 to 3 times the 20 dB bandwidth, centered on a hopping channel.
- 2). RBW = 30 KHz, VBW = 100 KHz.
- 3). Detector function = peak.
- 4). Trace = max hold.

6.2.4 Test Results

6.2.4.1 20dB Bandwidth

Test Mode	Channel	Frequency (MHz)	Measured 20dB Bandwidth (KHz)	Limits (KHz)	Verdict
GFSK	0	2402	861.80	No Limits	PASS
	39	2441	929.10		
	78	2480	903.00		
$\pi/4$ DQPSK	0	2402	1117.00	No Limits	PASS
	39	2441	1118.00		
	78	2480	1118.00		
8DPSK	0	2402	1164.00	No Limits	PASS
	39	2441	1163.00		
	78	2480	1162.00		

Remark:

1. Test results including cable loss;
2. Measured 20dB Bandwidth at difference Packet Type for each mode and recorded worst case for each mode.
3. Worst case data at DH5 for GFSK, 2DH5 for  $\pi/4$ DQPSK, 3DH5 for 8DPSK modulation type;
4. Please refer following test plots;



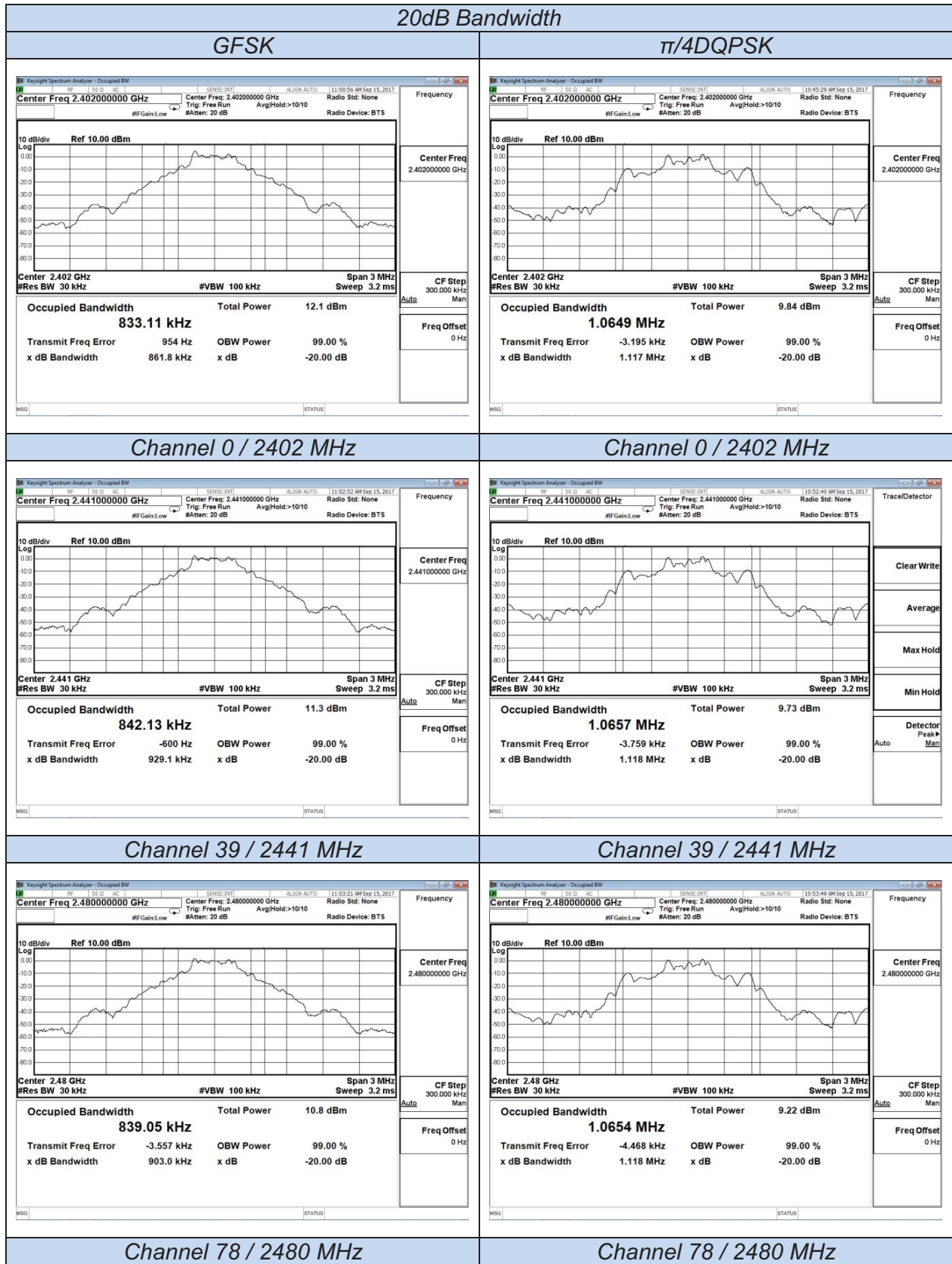

20dB Bandwidth	
<p><b>8DPSK</b></p> <p>Center Freq 2.402000000 GHz #Res BW 30 kHz #VBW 100 kHz Span 3 MHz Sweep 3.2 ms</p> <p><b>Occupied Bandwidth</b> 1.1037 MHz</p> <p>Total Power 9.36 dBm</p> <p>Transmit Freq Error -2.858 kHz OBW Power 99.00 %</p> <p>x dB Bandwidth 1.164 MHz x dB -20.00 dB</p>	<p>Trace/Detector</p> <p>Clear Write</p> <p>Average</p> <p>Max Hold</p> <p>Min Hold</p> <p>Detector Peak</p> <p>Auto Man</p>
Channel 0 / 2402 MHz	
<p>Center Freq 2.441000000 GHz #Res BW 30 kHz #VBW 100 kHz Span 3 MHz Sweep 3.2 ms</p> <p><b>Occupied Bandwidth</b> 1.1058 MHz</p> <p>Total Power 9.27 dBm</p> <p>Transmit Freq Error -3.355 kHz OBW Power 99.00 %</p> <p>x dB Bandwidth 1.163 MHz x dB -20.00 dB</p>	<p>Frequency</p> <p>Center Freq 2.441000000 GHz</p> <p>CF Step 300.000 kHz</p> <p>Auto Man</p> <p>Freq Offset 0 Hz</p>
Channel 39 / 2441 MHz	
<p>Center Freq 2.480000000 GHz #Res BW 30 kHz #VBW 100 kHz Span 3 MHz Sweep 3.2 ms</p> <p><b>Occupied Bandwidth</b> 1.1037 MHz</p> <p>Total Power 8.57 dBm</p> <p>Transmit Freq Error -4.812 kHz OBW Power 99.00 %</p> <p>x dB Bandwidth 1.162 MHz x dB -20.00 dB</p>	<p>Trace/Detector</p> <p>Clear Write</p> <p>Average</p> <p>Max Hold</p> <p>Min Hold</p> <p>Detector Peak</p> <p>Auto Man</p>
Channel 78 / 2480 MHz	

6.2.4.2 Frequency Separation

The Measurement Result With 1Mbps For GFSK Modulation				
Channel	20dB Bandwidth (KHz)	Channel Separation (MHz)	Limit (KHz)	Result
Low	861.80	1.000	861.80	Pass
Middle	929.10		929.10	Pass
High	903.00		903.00	Pass
The Measurement Result With 2Mbps For $\pi/4$ -DQPSK Modulation				
Channel	20dB Bandwidth (KHz)	Channel Separation (MHz)	Limit (KHz)	Result
Low	1117.00	1.000	744.67	Pass
Middle	1118.00		745.33	Pass
High	1118.00		745.33	Pass
The Measurement Result With 3Mbps For 8-DPSK Modulation				
Channel	20dB Bandwidth (KHz)	Channel Separation (MHz)	Limit (KHz)	Result
Low	1164.00	1.000	776.00	Pass
Middle	1163.00		775.33	Pass
High	1162.00		774.67	Pass

Remark:

1. Test results including cable loss;
2. Please refer to following plots;
3. Measured at difference Packet Type for each mode and recorded worst case for each mode.
4. Worst case data at DH5 for GFSK, 2DH5 for  $\pi/4$ -DQPSK, 3DH5 for 8DPSK modulation type;

### Frequency Separation

#### GFSK

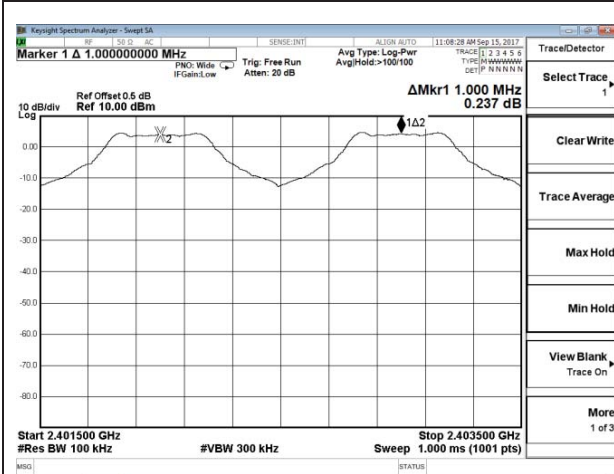

#### $\pi/4$ DQPSK

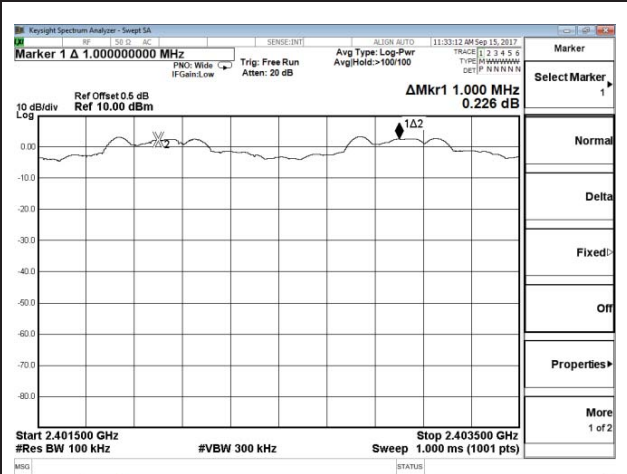

#### Channel 0 / 2402 MHz

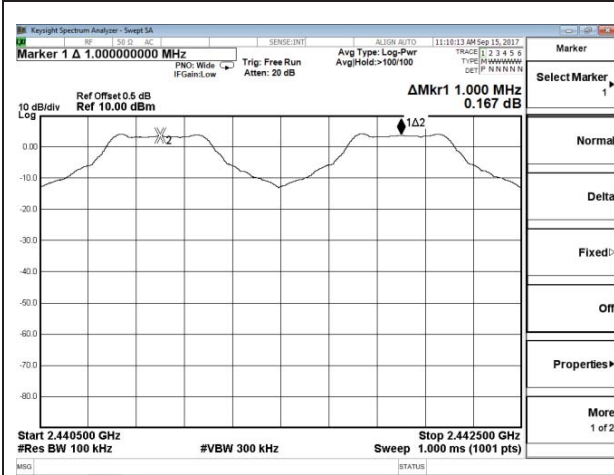

#### Channel 0 / 2402 MHz

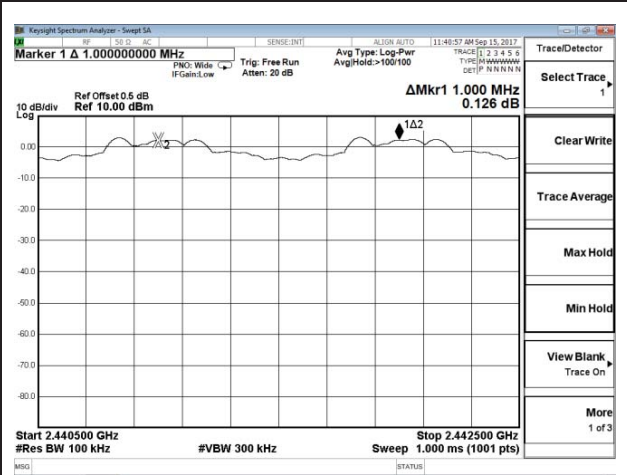

#### Channel 39 / 2441 MHz

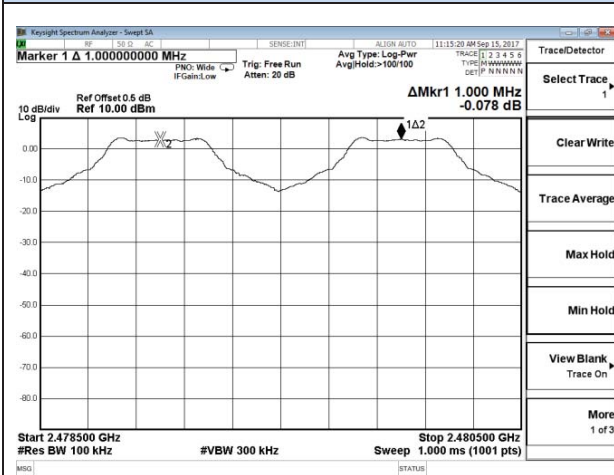

#### Channel 39 / 2441 MHz

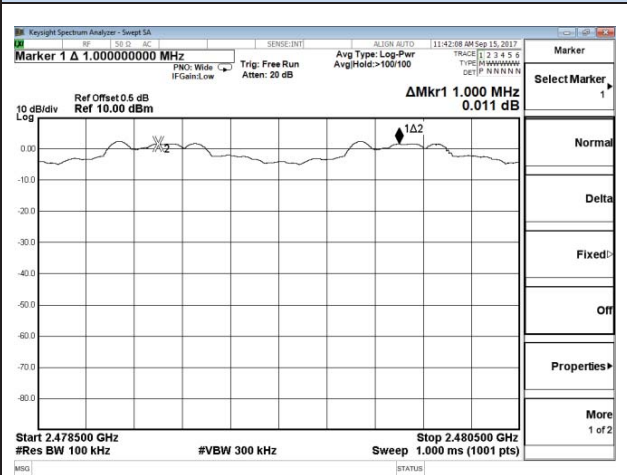

#### Channel 78 / 2480 MHz



#### Channel 78 / 2480 MHz



### Frequency Separation

#### 8DPSK

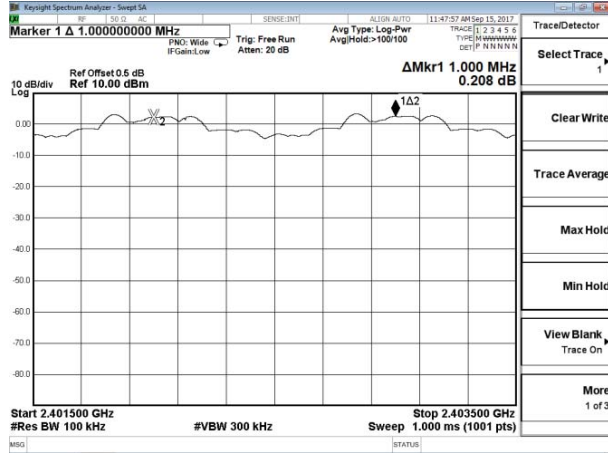

#### Channel 0 / 2402 MHz

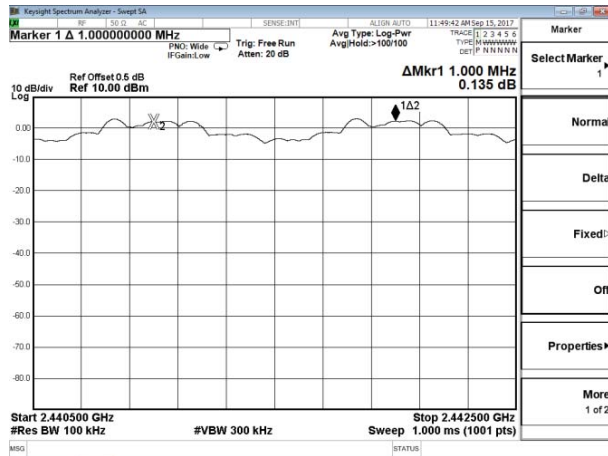

#### Channel 39 / 2441 MHz

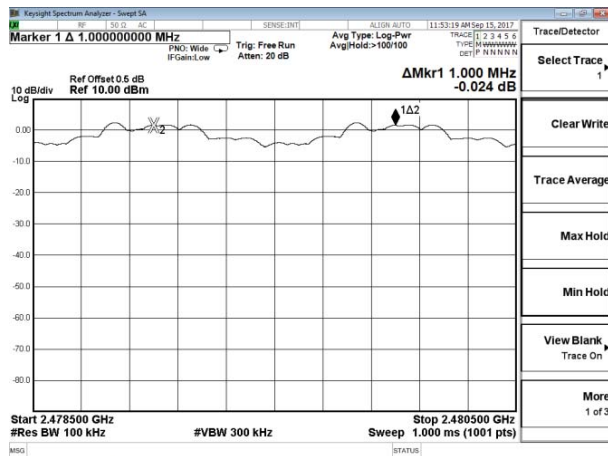

#### Channel 78 / 2480 MHz

### 6.3 Number of Hopping Frequency

#### 6.3.1 Limit

According to §15.247(a)(1)(ii) or A8.1 (d), Frequency hopping systems operating in the band 2400-2483.5 MHz shall use at least 15 hopping channels.

#### 6.3.2 Block Diagram of Test Setup

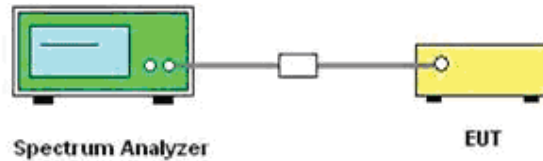

#### 6.3.3 Test Procedure

- 1). Place the EUT on the table and set it in transmitting mode.
- 2). Remove the antenna from the EUT and then connect a low loss RF cable from the antenna port to the Spectrum Analyzer.
- 3). Set Spectrum Analyzer Start=2400MHz, Stop = 2483.5MHz, Sweep = auto.
- 4). Set the Spectrum Analyzer as RBW = 1 MHz, VBW=1MHz.
- 5). Max hold, view and count how many channel in the band.

#### 6.3.4 Test Results

Test Mode	Measurement Result (No. of Channels)	Limit (No. of Channels)	Result
GFSK	79	≥15	PASS
$\pi/4$ DQPSK	79	≥15	PASS
8DPSK	79	≥15	PASS

**Remark:**

1. Test results including cable loss;
2. Measured number of hopping channels at difference Packet Type for each mode and recorded worst case for each mode.
3. Worst case data at DH5 for GFSK, 2DH5 for  $\pi/4$ DQPSK, 3DH5 for 8DPSK modulation type;
4. Record test plots only for GFSK;
5. Please refer following test plots;

### Number of Hopping Frequency

#### GFSK

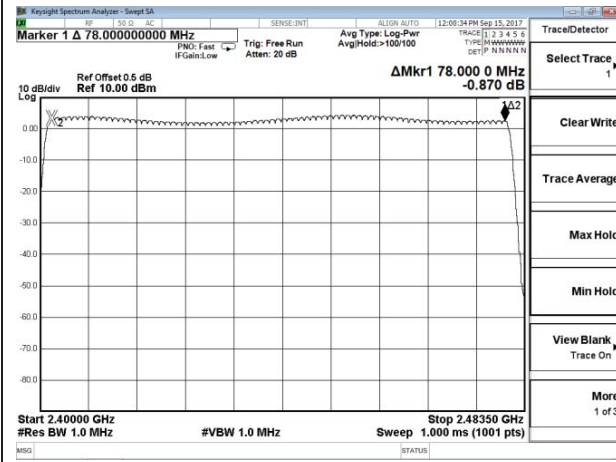

## 6.4 Time of Occupancy (Dwell Time)

### 6.4.1 Limit

According to §15.247(a)(1)(iii) or A8.1 (d), Frequency hopping systems operating in the 2400MHz-2483.5 MHz bands. The average time of occupancy on any channels shall not greater than 0.4 s within a period 0.4 s multiplied by the number of hopping channels employed.

### 6.4.2 Block Diagram of Test Setup

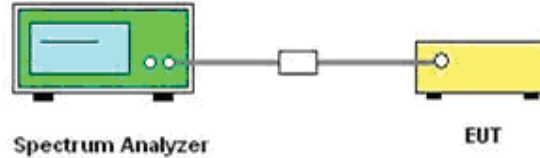

### 6.4.3 Test Procedure

- 1). Place the EUT on the table and set it in transmitting mode.
- 2). Remove the antenna from the EUT and then connect a low loss RF cable from the antenna port to the Spectrum Analyzer.
- 3). Set center frequency of Spectrum Analyzer = operating frequency.
- 4). Set the Spectrum Analyzer as RBW, VBW=1MHz, Span = 0Hz, Sweep = auto.
- 5). Repeat above procedures until all frequency measured was complete.

### 6.4.4 Test Results

The Dwell Time=Burst Width\*Total Hops. The detailed calculations are showed as follows:

The duration for dwell time calculation:  $0.4[s]*\text{hopping number}=0.4[s]*79[\text{ch}]=31.6[s*\text{ch}]$ ;

The burst width [ms/hop/ch], which is directly measured, refers to the duration on one channel hop.

The hops per second for all channels: The selected EUT Conf uses a slot type of 5-Tx&1-Rx and a hopping rate of 1600 [ch\*hop/s] for all channels. So the final hopping rate for all channels is  $1600/6=266.67$  [ch\*hop/s]

The hops per second on one channel:  $266.67$  [ch\*hops/s]/79 [ch]=3.38 [hop/s];

The total hops for all channels within the dwell time calculation duration:  $3.38$  [hop/s]\* $31.6[s*\text{ch}]$ =106.67 [hop\*ch];

The dwell time for all channels hopping:  $106.67$  [hop\*ch]\*Burst Width [ms/hop/ch].

Mode	Frequency (MHz)	Burst Type	Pulse Width (ms)	Dwell Time (S)	Limit (S)	Verdict
GFSK	2441	DH1	0.374	0.1197	0.4	PASS
		DH3	1.623	0.2597	0.4	PASS
		DH5	2.870	0.3061	0.4	PASS
π/4-DQPSK	2441	2DH1	0.368	0.1178	0.4	PASS
		2DH3	1.624	0.2598	0.4	PASS
		2DH5	2.860	0.3051	0.4	PASS
8DPSK	2441	3DH1	0.375	0.1200	0.4	PASS
		3DH3	1.617	0.2587	0.4	PASS
		3DH5	2.871	0.3062	0.4	PASS

#### Remark:

1. Test results including cable loss;
2. Please refer to following plots;
3. Measured at difference Packet Type for each mode and recorded worst case for each mode.
4. Dwell Time Calculate formula:  
 DH1: Dwell time=Pulse time (ms) × (1600 ÷ 2 ÷ 79) ×31.6 Second  
 DH3: Dwell time=Pulse time (ms) × (1600 ÷ 4 ÷ 79) ×31.6 Second  
 DH5: Dwell time=Pulse Time (ms) × (1600 ÷ 6 ÷ 79) ×31.6 Second
5. Measured at low, middle and high channel, recorded worst at middle channel;



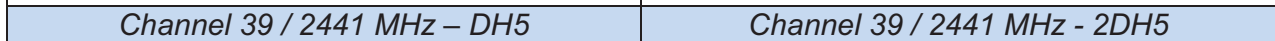
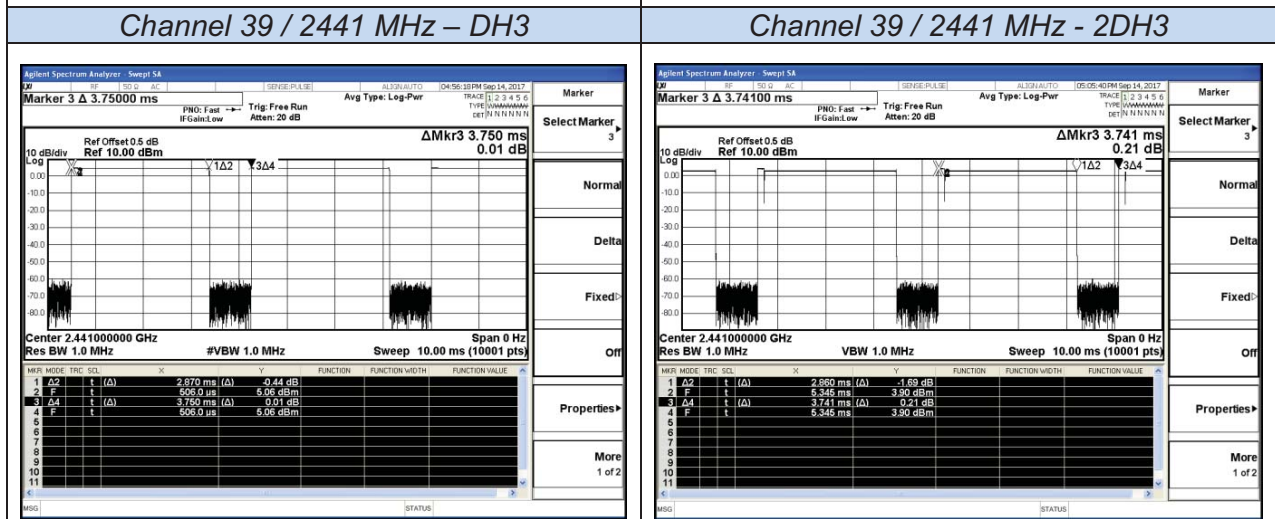
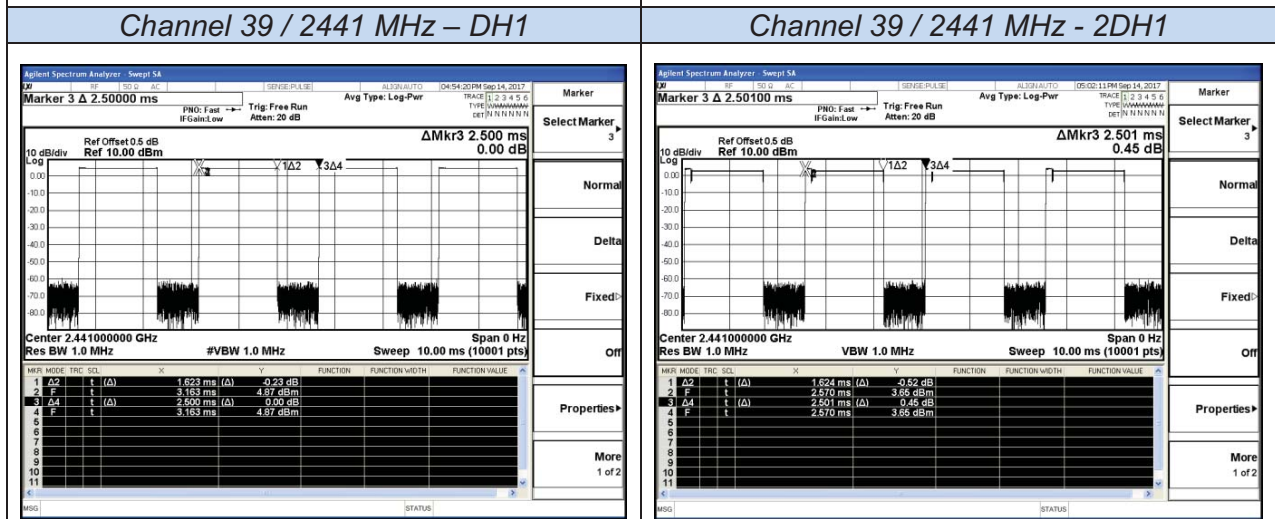
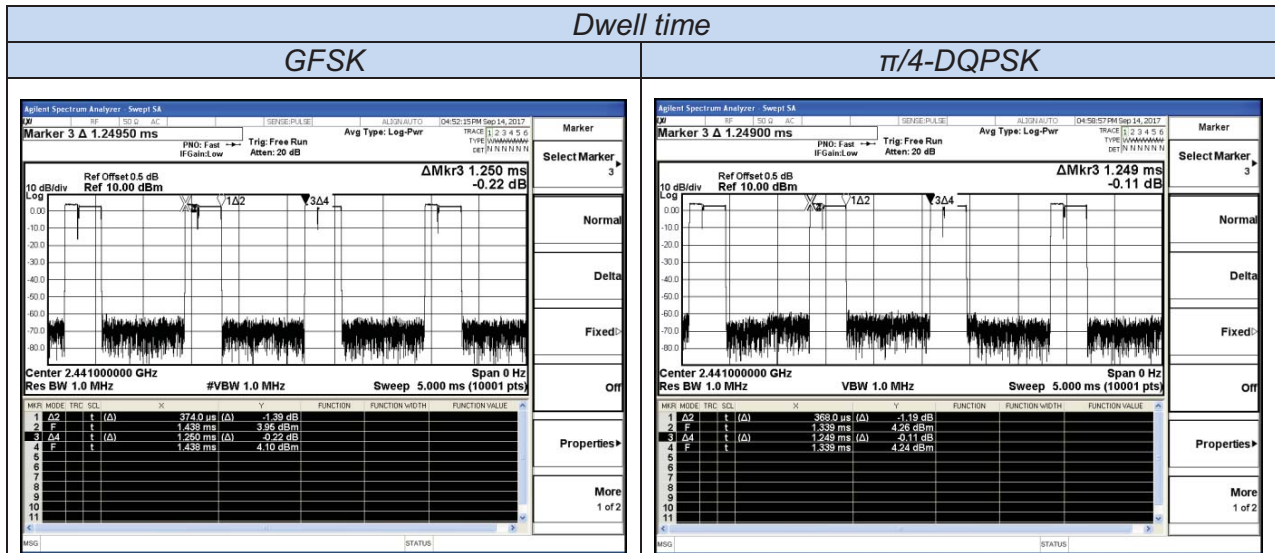

**Dwell time**

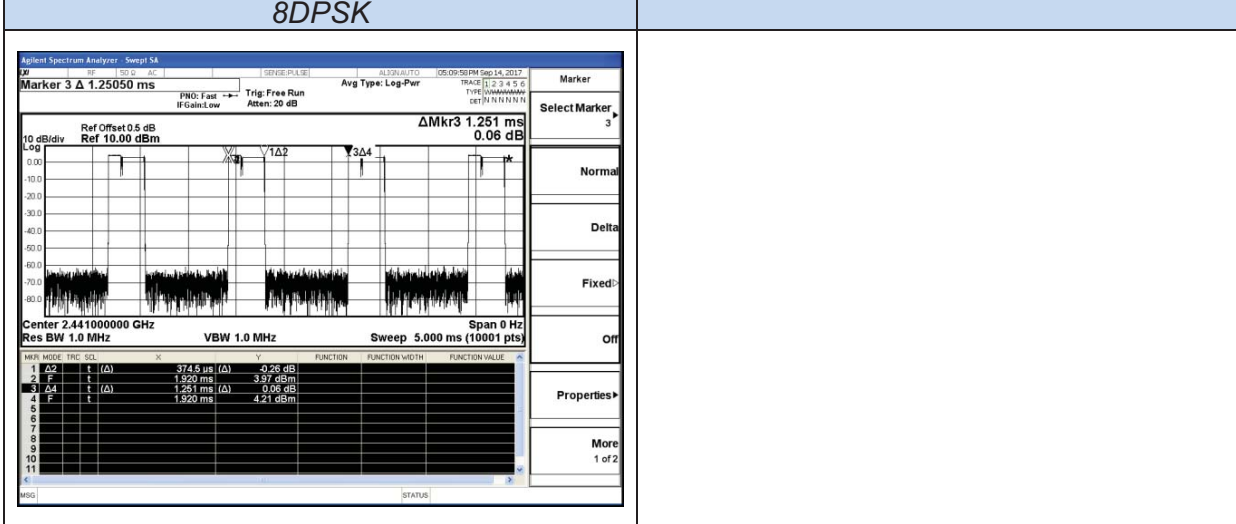

**Channel 39 / 2441 MHz – 3DH1**

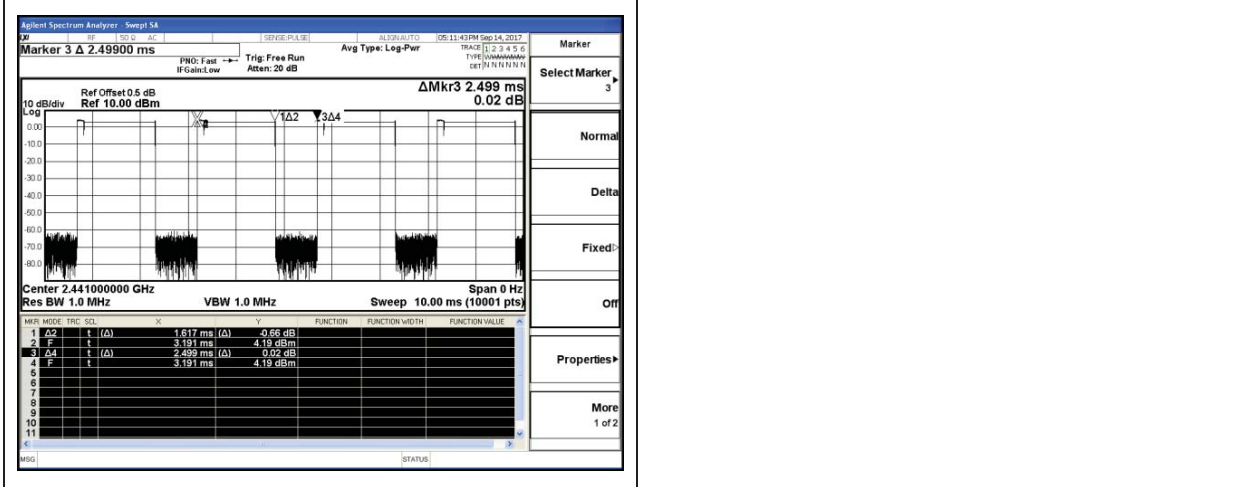

**Channel 39 / 2441 MHz – 3DH3**

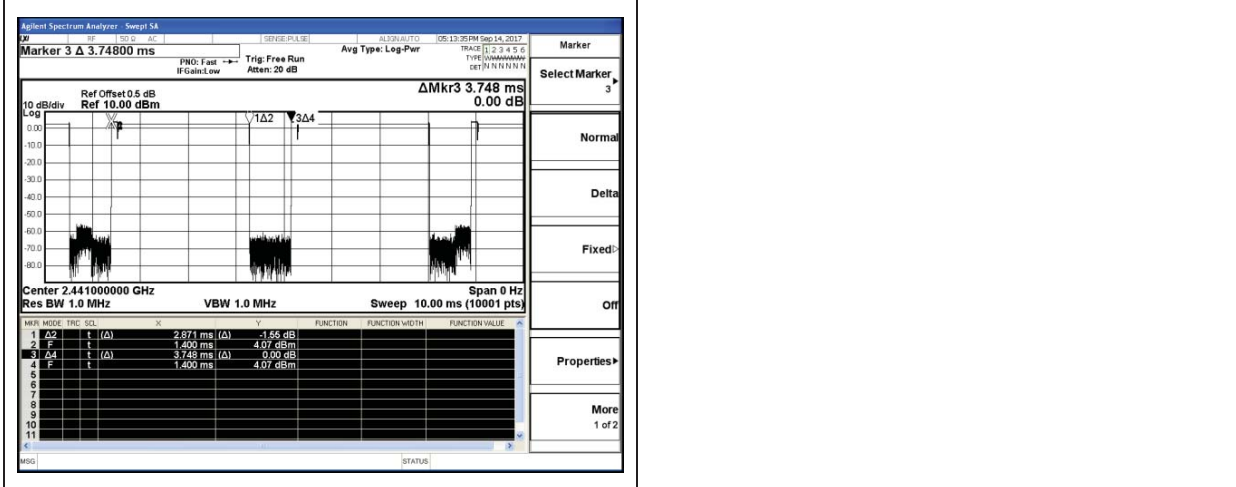

**Channel 39 / 2441 MHz – 3DH5**

## 6.5 Conducted Spurious Emissions and Band Edges Test

### 6.5.1 Limit

In any 100 kHz bandwidth outside the frequency band in which the spread spectrum or digitally modulated intentional radiator is operating, the radio frequency power that is produced by the intentional radiator shall be at least 20 dB below that in the 100 kHz bandwidth within the band that contains the highest level of the desired power, based on either an RF conducted or a radiated measurement. Attenuation below the general limits specified in Section 15.209(a) is not required.

### 6.5.2 Block Diagram of Test Setup

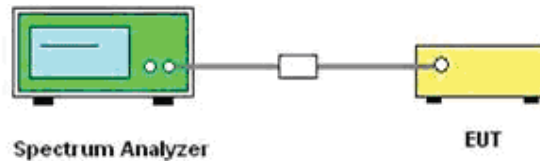

### 6.5.3 Test Procedure

Conducted RF measurements of the transmitter output were made to confirm that the EUT antenna port conducted emissions meet the specified limit and to identify any spurious signals that require further investigation or measurements on the radiated emissions site.

The transmitter output is connected to the spectrum analyzer. The resolution bandwidth is set to 100 KHz. The video bandwidth is set to 300 KHz.

Measurements are made over the 9 KHz to 26.5GHz range with the transmitter set to the lowest, middle, and highest channels

### 6.5.4 Test Results of Conducted Spurious Emissions

No non-compliance noted. Only record the worst test result (TX-GFSK) in this report. The test data refer to the following page.

Test Mode	Channel	Frequency (MHz)	Spurious RF Conducted Emission (dBc)	Limits (dBc)	Verdict
GFSK	0	2402	<-20	-20	PASS
	39	2441	<-20		
	78	2480	<-20		
$\pi/4$ -DQPSK	0	2402	<-20	-20	PASS
	39	2441	<-20		
	78	2480	<-20		
8DPSK	0	2402	<-20	-20	PASS
	39	2441	<-20		
	78	2480	<-20		

**Remark:**

1. Test results including cable loss;
2. Please refer to following plots;
3. Measured at difference Packet Type for each mode and recorded worst case for each mode.
4. Worst case data at DH5 for GFSK, 2DH5 for  $\pi/4$ -DQPSK, 3DH5 for 8DPSK modulation type;

### RF Conducted Spurious Emissions GFSK – Channel 0 / 2402 MHz

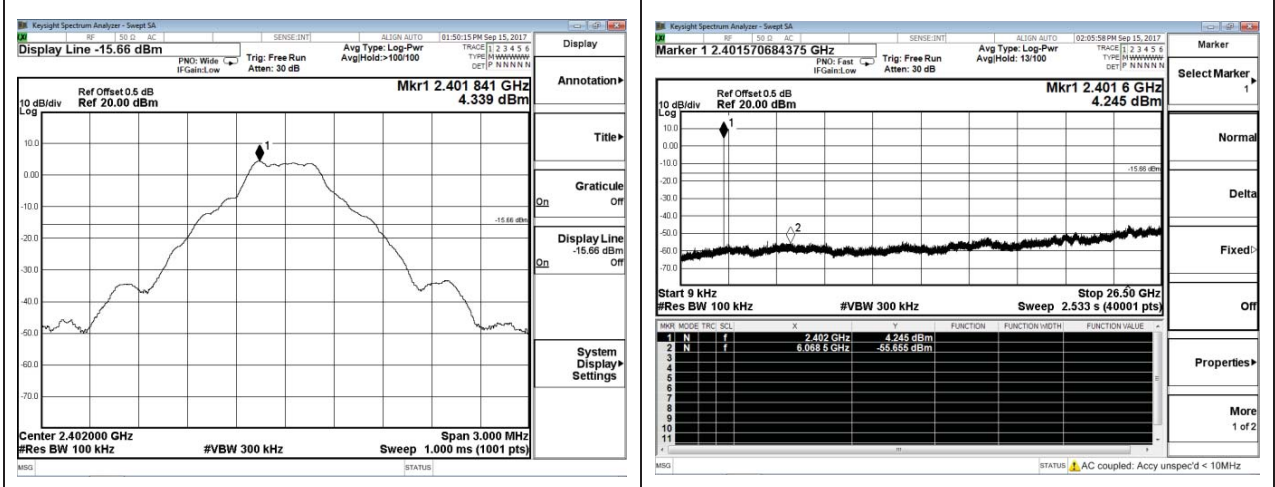

2399.5 – 2404.5 MHz

9 KHz – 26.5 GHz

### GFSK – Channel 39 / 2441 MHz

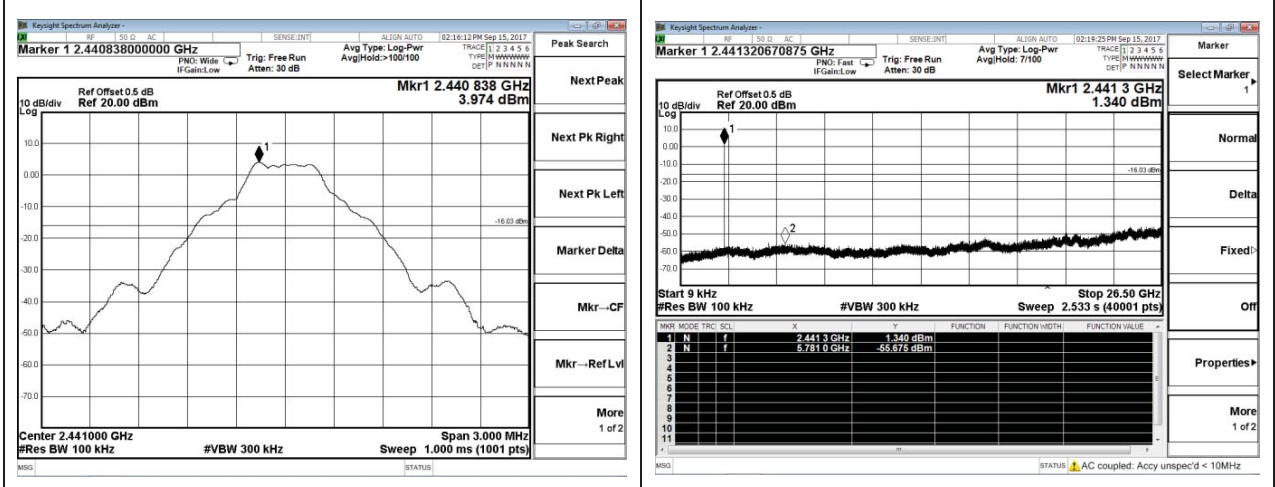

2438.5 – 2443.5 MHz

9 KHz – 26.5 GHz

### GFSK – Channel 78 / 2480 MHz

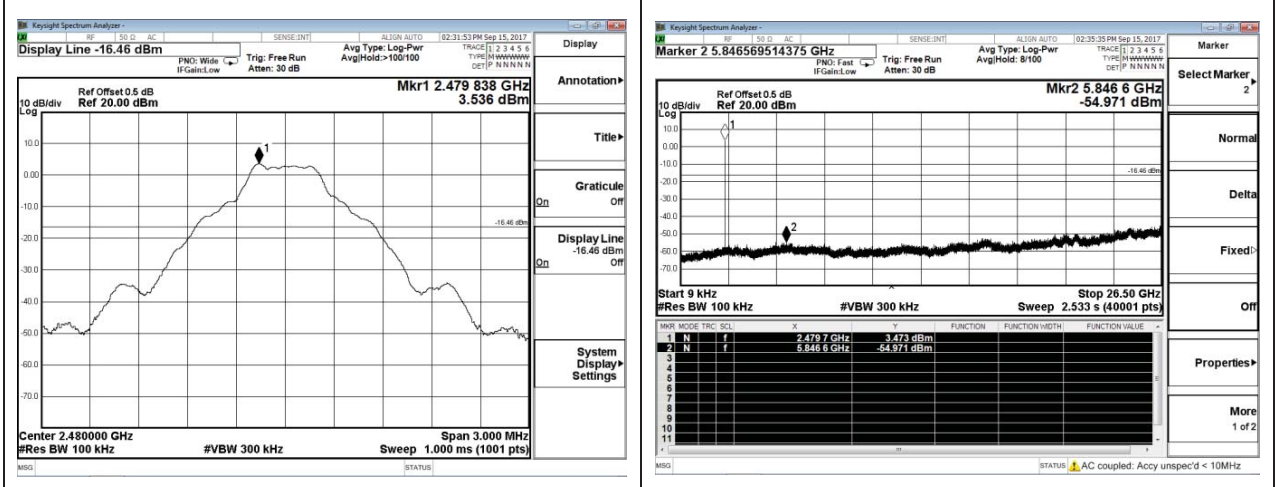

2477.5 – 2482.5 MHz

9 KHz – 26.5 GHz

**RF Conducted Spurious Emissions**  
 $\pi/4$ -DQPSK – Channel 0 / 2402 MHz

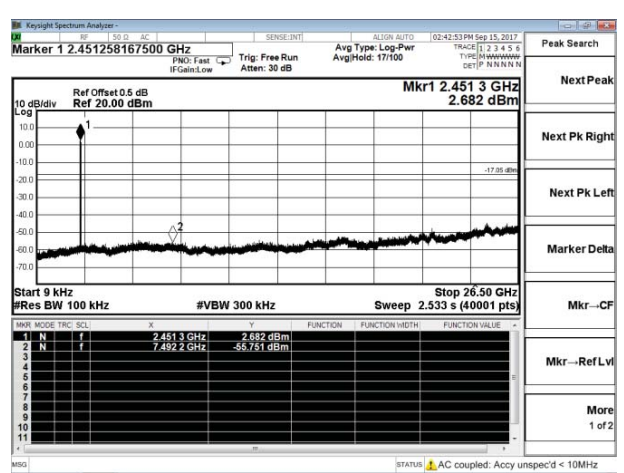
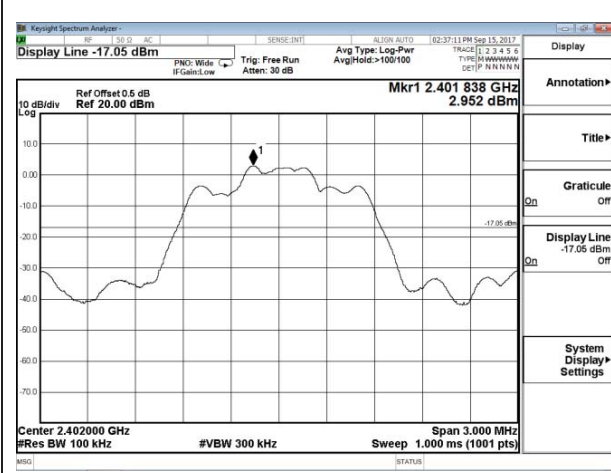

2399.5 – 2404.5 MHz

9 KHz – 26.5 GHz

$\pi/4$ -DQPSK – Channel 39 / 2441 MHz

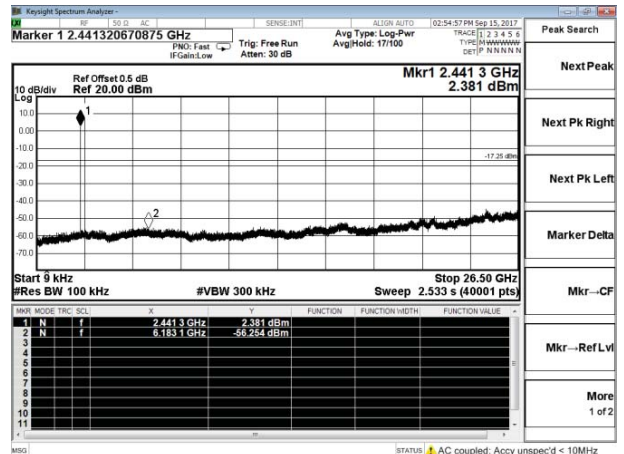
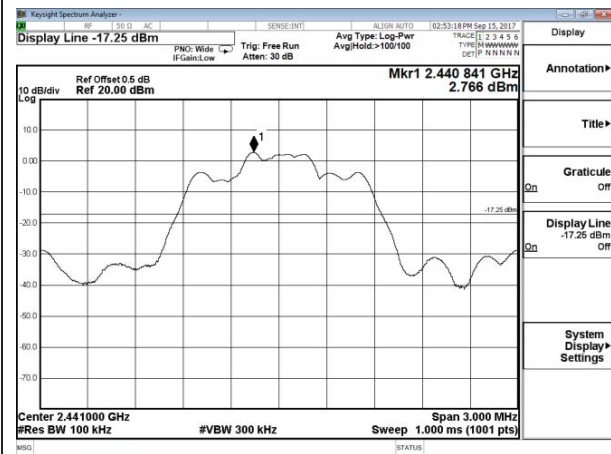

2438.5 – 2443.5 MHz

9 KHz – 26.5 GHz

$\pi/4$ -DQPSK – Channel 78 / 2480 MHz

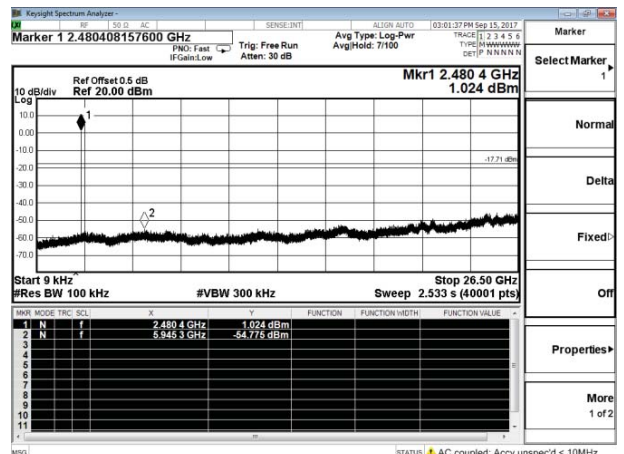
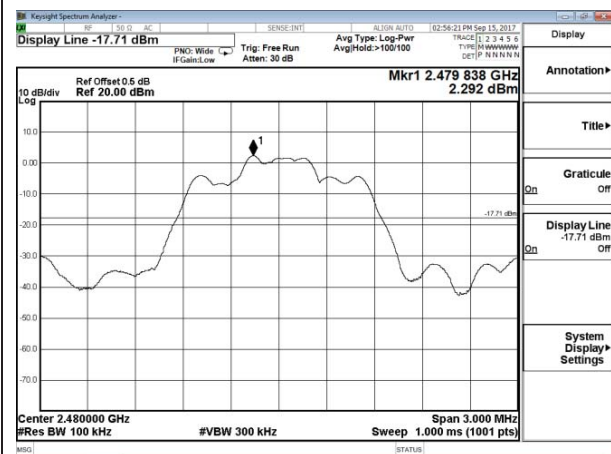

2477.5 – 2482.5 MHz

9 KHz – 26.5 GHz

### RF Conducted Spurious Emissions 8DPSK – Channel 0 / 2402 MHz

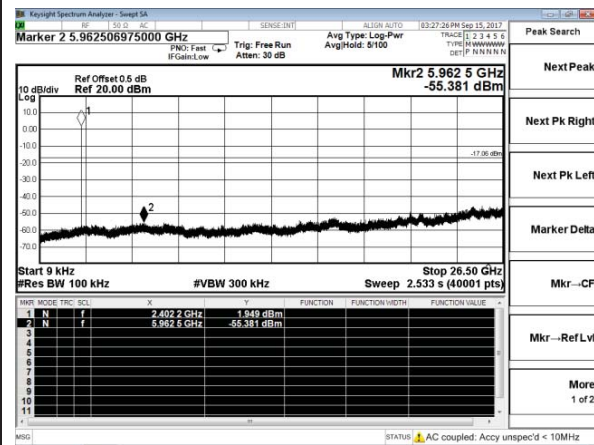
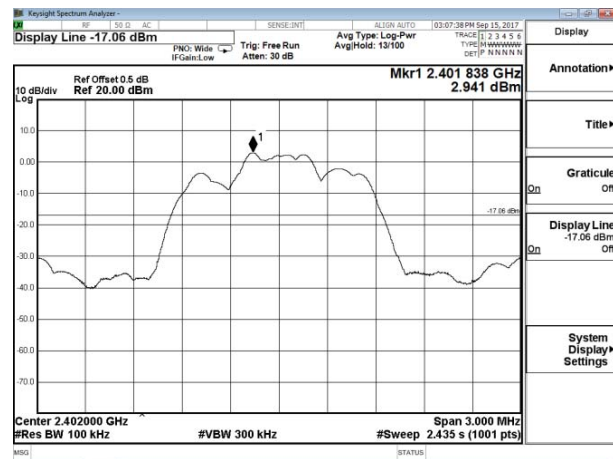

2399.5 – 2404.5 MHz

9 KHz – 26.5 GHz

### 8DPSK – Channel 39 / 2441 MHz

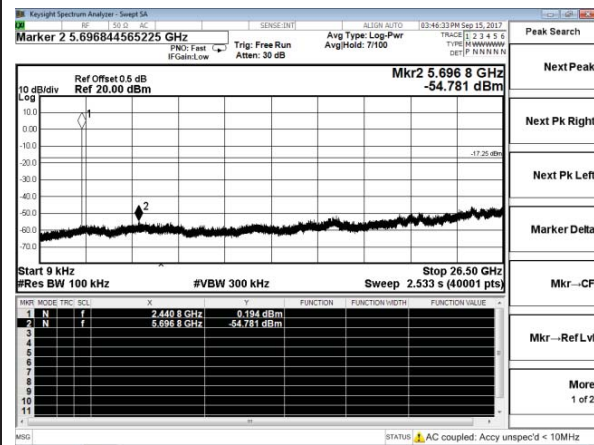
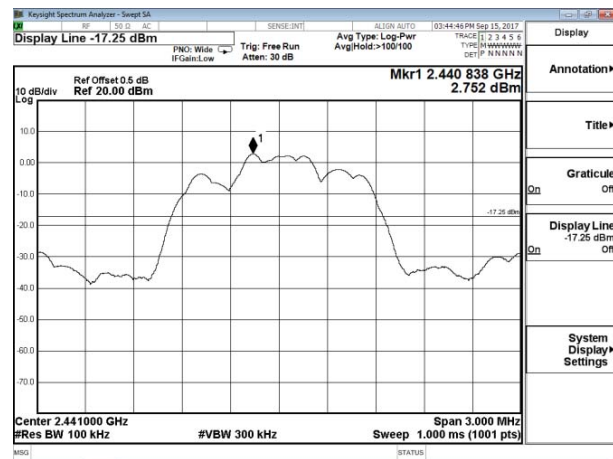

2438.5 – 2443.5 MHz

9 KHz – 26.5 GHz

### 8DPSK – Channel 78 / 2480 MHz

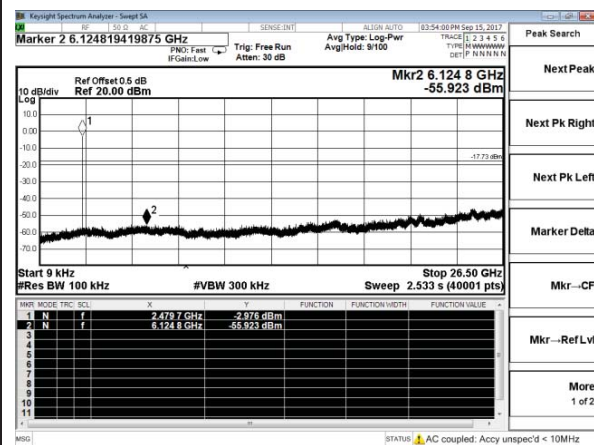
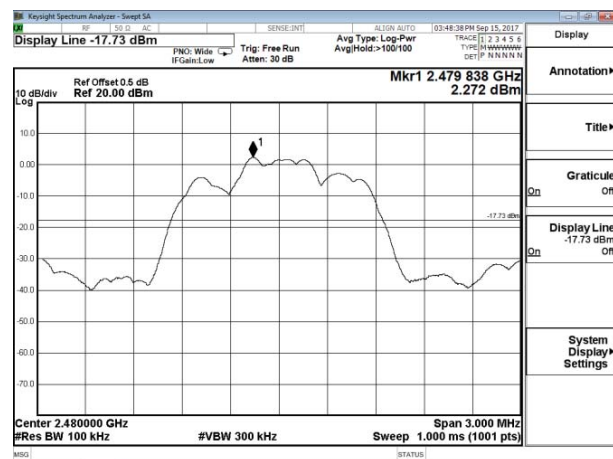

2477.5 – 2482.5 MHz

9 KHz – 26.5 GHz

Band-edge for RF conducted emissions

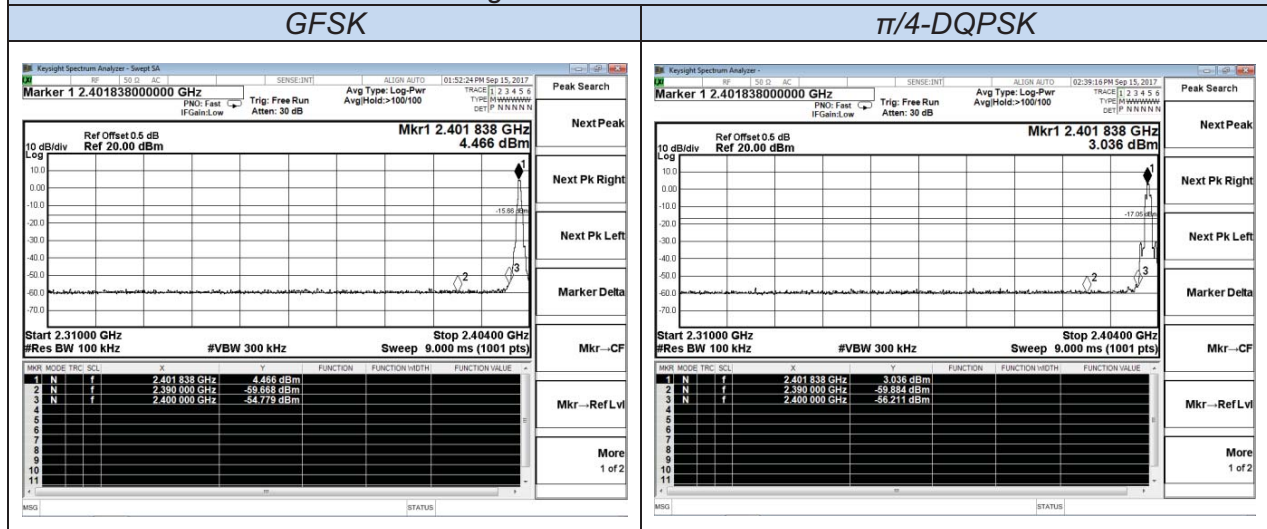

Channel 0 / 2402 MHz – Non-Hopping

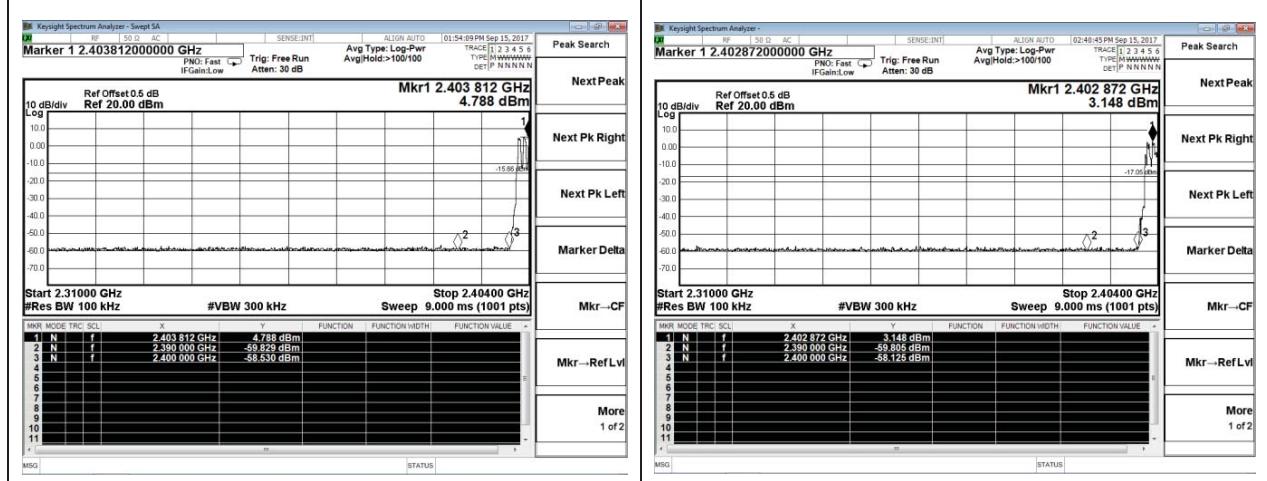

Channel 0 / 2402 MHz – Hopping

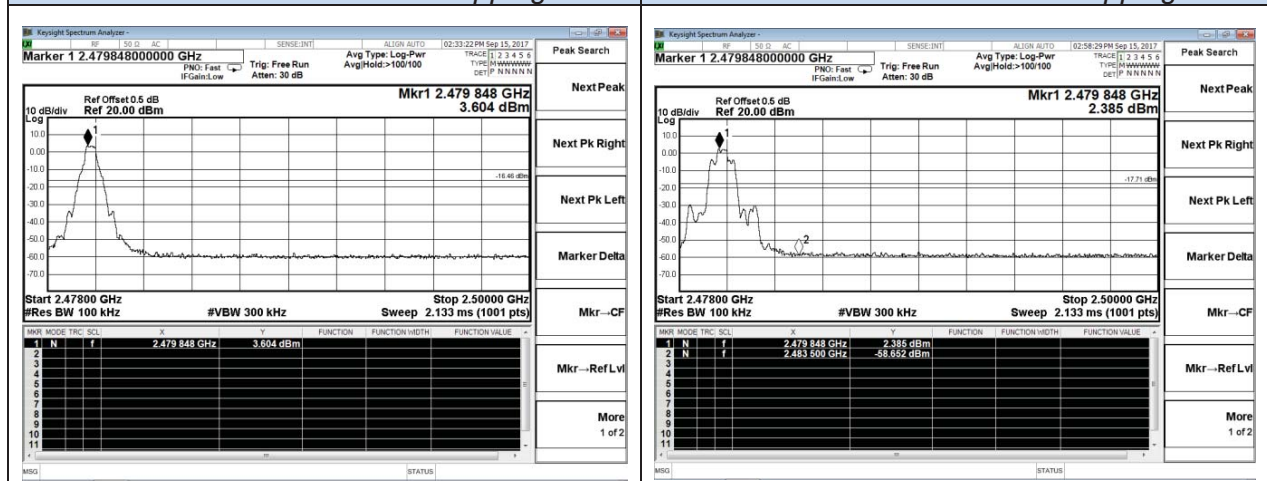

Channel 78 / 2480 MHz – Non-Hopping

Band-edge for RF conducted emissions

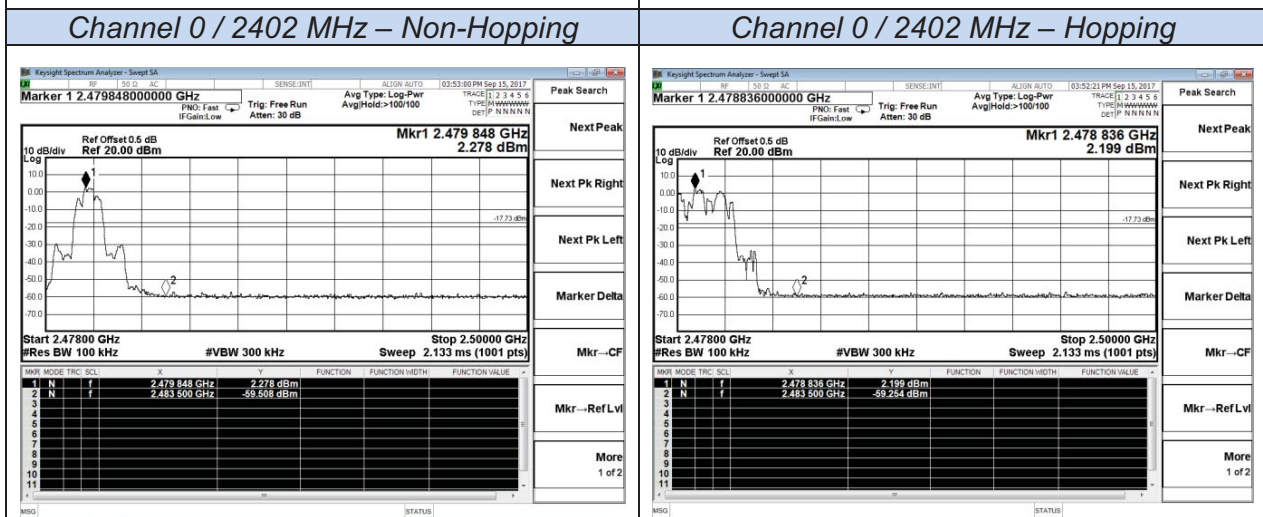
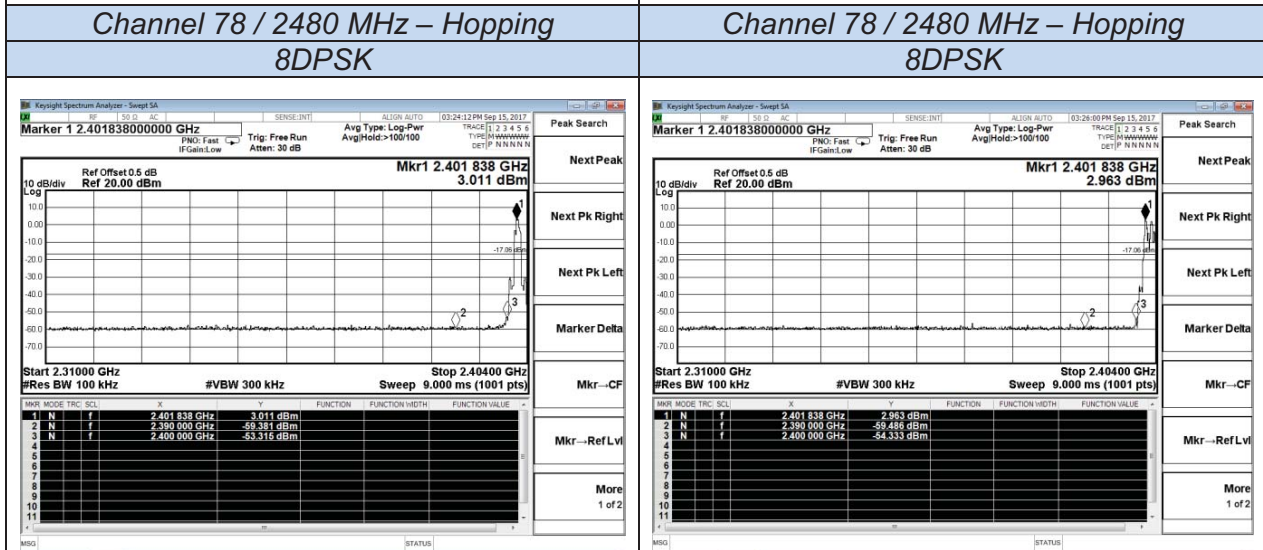
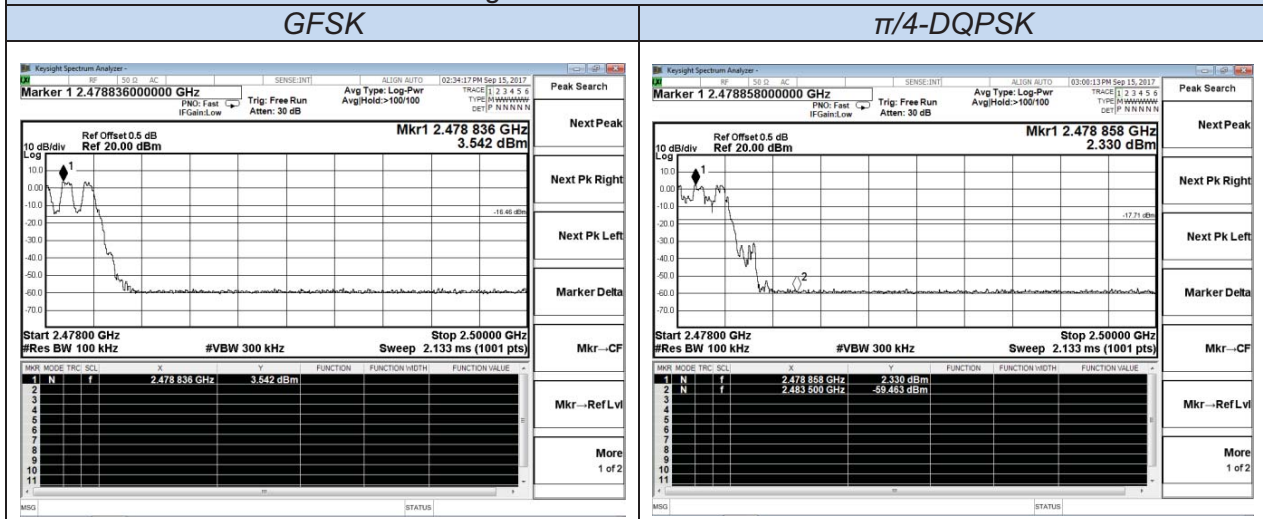



## 7. RADIATED MEASUREMENT

### 7.1 Block Diagram of Test Setup

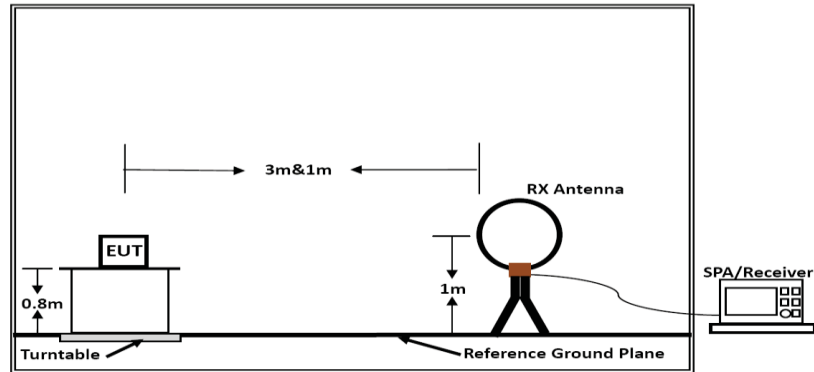

Below 30MHz

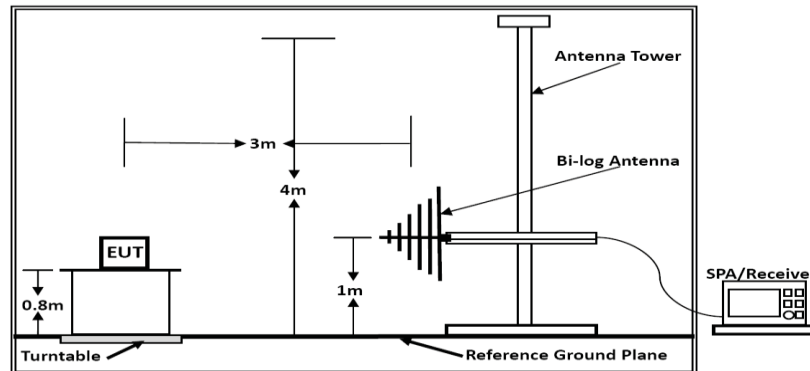

Below 1GHz

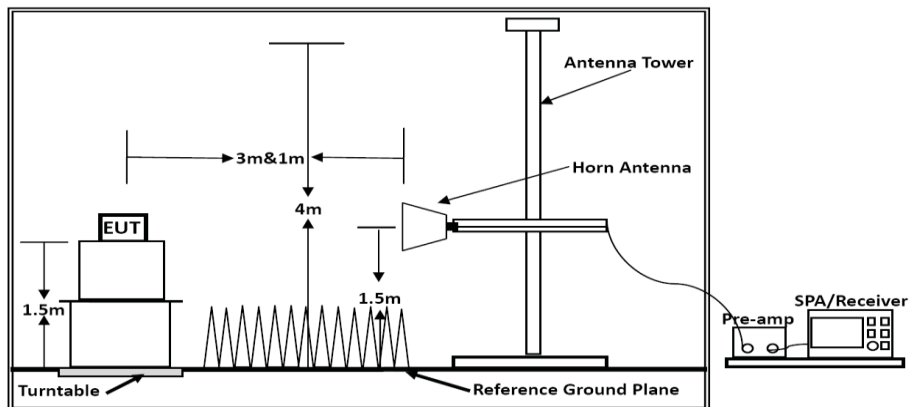

Above 1GHz

Above 18 GHz shall be extrapolated to the specified distance using an extrapolation factor of 20 dB/decade from 3m to 1m.

Distance extrapolation factor =  $20 \log(\text{specific distance [3m]} / \text{test distance [1.5m]})$  (dB);

Limit line = specific limits (dBuV) + distance extrapolation factor [6 dB].

7.2 Restricted Band Emission Limit

15.205 (a) Except as shown in paragraph (d) of this section, only spurious emissions are permitted in any of the frequency bands listed below:

MHz	MHz	MHz	GHz
0.090-0.110	16.42-16.423	399.9-410	4.5-5.15
\1\ 0.495-0.505	16.69475-16.69525	608-614	5.35-5.46
2.1735-2.1905	16.80425-16.80475	960-1240	7.25-7.75
4.125-4.128	25.5-25.67	1300-1427	8.025-8.5
4.17725-4.17775	37.5-38.25	1435-1626.5	9.0-9.2
4.20725-4.20775	73-74.6	1645.5-1646.5	9.3-9.5
6.215-6.218	74.8-75.2	1660-1710	10.6-12.7
6.26775-6.26825	108-121.94	1718.8-1722.2	13.25-13.4
6.31175-6.31225	123-138	2200-2300	14.47-14.5
8.291-8.294	149.9-150.05	2310-2390	15.35-16.2
8.362-8.366	156.52475-156.52525	2483.5-2500	17.7-21.4
8.37625-8.38675	156.7-156.9	2690-2900	22.01-23.12
8.41425-8.41475	162.0125-167.17	3260-3267	23.6-24.0
12.29-12.293.	167.72-173.2	3332-3339	31.2-31.8
12.51975-12.52025	240-285	3345.8-3358	36.43-36.5
12.57675-12.57725	322-335.4	3600-4400	(\2)
13.36-13.41			

\1\ Until February 1, 1999, this restricted band shall be 0.490-0.510 MHz.

\2\ Above 38.6

According to §15.247 (d): 20dBc in any 100 kHz bandwidth outside the operating frequency band. In case the emission fall within the restricted band specified on 15.205(a), then the 15.209(a) limit in the table below has to be followed.

Frequencies (MHz)	Field Strength (microvolts/meter)	Measurement Distance (meters)
0.009~0.490	2400/F(KHz)	300
0.490~1.705	24000/F(KHz)	30
1.705~30.0	30	30
30~88	100	3
88~216	150	3
216~960	200	3
Above 960	500	3

7.3 Instruments Setting

Please refer to section 6 of equipment list in this report. The following table is the setting of spectrum analyzer and receiver.

Spectrum Parameter	Setting
Attenuation	Auto
Start Frequency	1000 MHz
Stop Frequency	10 <sup>th</sup> carrier harmonic
RB / VB (Emission in restricted band)	1MHz / 1MHz for Peak, 1 MHz / 1/B kHz for Average
RB / VB (Emission in non-restricted band)	1MHz / 1MHz for Peak, 1 MHz / 1/B kHz for Average

Receiver Parameter	Setting
Attenuation	Auto
Start ~ Stop Frequency	9kHz~150kHz / RB/VB 200Hz/1KHz for QP/AVG
Start ~ Stop Frequency	150kHz~30MHz / RB/VB 9kHz/30KHz for QP/AVG
Start ~ Stop Frequency	30MHz~1000MHz / RB/VB 120kHz/1MHz for QP

#### 7.4 Test Procedures

##### 1) Sequence of testing 9 kHz to 30 MHz

###### Setup:

- The equipment was set up to simulate a typical usage like described in the user manual or described by manufacturer.
- If the EUT is a tabletop system, a rotatable table with 0.8 m height is used.
- If the EUT is a floor standing device, it is placed on the ground.
- Auxiliary equipment and cables were positioned to simulate normal operation conditions.
- The AC power port of the EUT (if available) is connected to a power outlet below the turntable.
- The measurement distance is 3 meter.
- The EUT was set into operation.

###### Premeasurement:

- The turntable rotates from 0° to 315° using 45° steps.
- The antenna height is 0.8 meter.
- At each turntable position the analyzer sweeps with peak detection to find the maximum of all emissions

###### Final measurement:

- Identified emissions during the premeasurement the software maximizes by rotating the turntable position (0° to 360°) and by rotating the elevation axes (0° to 360°).
- The final measurement will be done in the position (turntable and elevation) causing the highest emissions with QPK detector.
- The final levels, frequency, measuring time, bandwidth, turntable position, correction factor, margin to the limit and limit will be recorded. Also a plot with the graph of the premeasurement and the limit will be stored.

## 2) Sequence of testing 30 MHz to 1 GHz

### Setup:

- The equipment was set up to simulate a typical usage like described in the user manual or described by manufacturer.
- If the EUT is a tabletop system, a table with 0.8 m height is used, which is placed on the ground plane.
- If the EUT is a floor standing device, it is placed on the ground plane with insulation between both.
- Auxiliary equipment and cables were positioned to simulate normal operation conditions
- The AC power port of the EUT (if available) is connected to a power outlet below the turntable.
- The measurement distance is 3 meter.
- The EUT was set into operation.

### Premeasurement:

- The turntable rotates from 0° to 315° using 45° steps.
- The antenna is polarized vertical and horizontal.
- The antenna height changes from 1 to 3 meter.
- At each turntable position, antenna polarization and height the analyzer sweeps three times in peak to find the maximum of all emissions.

### Final measurement:

- The final measurement will be performed with minimum the six highest peaks.
- According to the maximum antenna and turntable positions of premeasurement the software maximize the peaks by changing turntable position ( $\pm 45^\circ$ ) and antenna movement between 1 and 4 meter.
- The final measurement will be done with QP detector with an EMI receiver.
- The final levels, frequency, measuring time, bandwidth, antenna height, antenna polarization, turntable angle, correction factor, margin to the limit and limit will be recorded. Also a plot with the graph of the premeasurement with marked maximum final measurements and the limit will be stored.

### 3) Sequence of testing 1 GHz to 18 GHz

#### Setup:

- The equipment was set up to simulate a typical usage like described in the user manual or described by manufacturer.
- If the EUT is a tabletop system, a rotatable table with 1.5 m height is used.
- If the EUT is a floor standing device, it is placed on the ground plane with insulation between both.
- Auxiliary equipment and cables were positioned to simulate normal operation conditions
- The AC power port of the EUT (if available) is connected to a power outlet below the turntable.
- The measurement distance is 3 meter.
- The EUT was set into operation.

#### Premeasurement:

- The turntable rotates from 0° to 315° using 45° steps.
- The antenna is polarized vertical and horizontal.
- The antenna height scan range is 1 meter to 2.5 meter.
- At each turntable position and antenna polarization the analyzer sweeps with peak detection to find the maximum of all emissions.

#### Final measurement:

- The final measurement will be performed with minimum the six highest peaks.
- According to the maximum antenna and turntable positions of premeasurement the software maximize the peaks by changing turntable position ( $\pm 45^\circ$ ) and antenna movement between 1 and 4 meter. This procedure is repeated for both antenna polarizations.
- The final measurement will be done in the position (turntable, EUT-table and antenna polarization) causing the highest emissions with Peak and Average detector.
- The final levels, frequency, measuring time, bandwidth, turntable position, EUT-table position, antenna polarization, correction factor, margin to the limit and limit will be recorded. Also a plot with the graph of the premeasurement with marked maximum final measurements and the limit will be stored.

**4) Sequence of testing above 18 GHz**

**Setup:**

- The equipment was set up to simulate a typical usage like described in the user manual or described by manufacturer.
- If the EUT is a tabletop system, a rotatable table with 1.5 m height is used.
- If the EUT is a floor standing device, it is placed on the ground plane with insulation between both.
- Auxiliary equipment and cables were positioned to simulate normal operation conditions
- The AC power port of the EUT (if available) is connected to a power outlet below the turntable.
- The measurement distance is 1 meter.
- The EUT was set into operation.

**Premeasurement:**

- The antenna is moved spherical over the EUT in different polarizations of the antenna.

**Final measurement:**

- The final measurement will be performed at the position and antenna orientation for all detected emissions that were found during the premeasurements with Peak and Average detector.
- The final levels, frequency, measuring time, bandwidth, correction factor, margin to the limit and limit will be recorded. Also a plot with the graph of the premeasurement and the limit will be stored.

7.5 EUT Operation during Test

The EUT was programmed to be in continuously transmitting mode.

7.6 Test Results

Radiated Emissions (9 KHz~30MHz)

Temperature	25°C	Humidity	60%
Test Engineer	Aking Jin	Configurations	BT

Freq. (MHz)	Level (dBuV)	Over Limit (dB)	Over Limit (dBuV)	Remark
-	-	-	-	See Note

*Note:*

*The amplitude of spurious emissions which are attenuated by more than 20 dB below the permissible value has no need to be reported.*

*Distance extrapolation factor = 40 log (specific distance / test distance) (dB);*

*Limit line = specific limits (dBuV) + distance extrapolation factor.*

**PASS.**

Pre-scan all modes and recorded the worst case results in this report (TX-Low Channel (1Mbps)).  
The test data please refer to following page.

**Below 1GHz (Low Channel)**

Vertical:

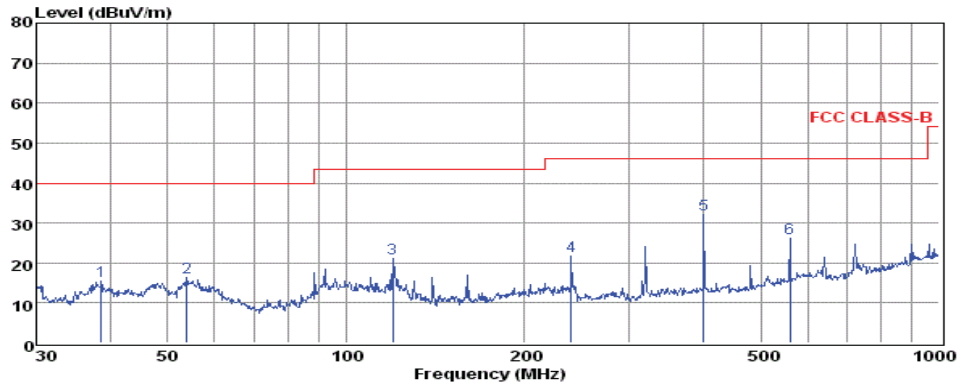

pol: VERTICAL

	Freq	Reading	CabLos	Antfac	Measured	Limit	Over	Remark
	MHz	dBuV	dB	dB/m	dBuV/m	dBuV/m	dB	
1	38.62	1.77	0.38	13.23	15.38	40.00	-24.62	QP
2	53.88	2.78	0.46	13.07	16.31	40.00	-23.69	QP
3	119.86	9.88	0.64	10.51	21.03	43.50	-22.47	QP
4	239.99	8.58	1.01	12.09	21.68	46.00	-24.32	QP
5	400.43	15.94	1.20	15.07	32.21	46.00	-13.79	QP
6	560.69	7.10	1.43	17.71	26.24	46.00	-19.76	QP

Note: 1. All readings are Quasi-peak values.  
 2. Measured= Reading + Antenna Factor + Cable Loss  
 3. The emission that are 20db below the official limit are not reported

Horizontal:

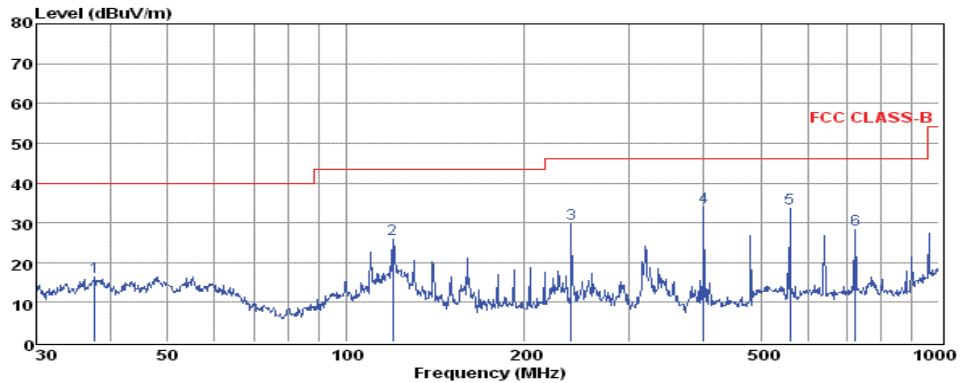

pol: HORIZONTAL

	Freq	Reading	CabLos	Antfac	Measured	Limit	Over	Remark
	MHz	dBuV	dB	dB/m	dBuV/m	dBuV/m	dB	
1	37.68	3.05	0.38	12.99	16.42	40.00	-23.58	QP
2	119.86	14.81	0.64	10.51	25.96	43.50	-17.54	QP
3	239.99	16.49	1.01	12.09	29.59	46.00	-16.41	QP
4	400.43	17.65	1.20	15.07	33.92	46.00	-12.08	QP
5	560.69	14.34	1.43	17.71	33.48	46.00	-12.52	QP
6	721.73	7.43	1.63	19.08	28.14	46.00	-17.86	QP

Note: 1. All readings are Quasi-peak values.  
 2. Measured= Reading + Antenna Factor + Cable Loss  
 3. The emission that are 20db below the official limit are not reported

**Above 1GHz**

Note: Only recorded the worst test result.

The worst test result for GFSK, Channel 0 / 2402 MHz:

Freq. MHz	Reading dBuV	Ant. Fac dB/m	Pre. Fac. dB	Cab. Loss dB	Measured dBuV/m	Limit dBuV/m	Margin dB	Remark	Pol.
4804.00	52.46	33.06	35.04	3.94	54.42	74.00	-19.58	Peak	Horizontal
4804.00	39.31	33.06	35.04	3.94	41.27	54.00	-12.73	Average	Horizontal
4804.00	54.44	33.06	35.04	3.94	56.40	74.00	-17.60	Peak	Vertical
4804.00	40.10	33.06	35.04	3.94	42.06	54.00	-11.94	Average	Vertical

The worst test result for GFSK, Channel 39 / 2441 MHz:

Freq. MHz	Reading dBuV	Ant. Fac dB/m	Pre. Fac. dB	Cab. Loss dB	Measured dBuV/m	Limit dBuV/m	Margin dB	Remark	Pol.
4882.00	54.18	33.16	35.15	3.96	56.15	74.00	-17.85	Peak	Horizontal
4882.00	40.10	33.16	35.15	3.96	42.07	54.00	-11.93	Average	Horizontal
4882.00	52.45	33.16	35.15	3.96	54.42	74.00	-19.58	Peak	Vertical
4882.00	38.69	33.16	35.15	3.96	40.66	54.00	-13.34	Average	Vertical

The worst test result for GFSK, Channel 78 / 2480 MHz:

Freq. MHz	Reading dBuV	Ant. Fac dB/m	Pre. Fac. dB	Cab. Los dB	Measured dBuV/m	Limit dBuV/m	Margin dB	Remark	Pol.
4960.00	53.82	33.26	35.14	3.98	55.92	74.00	-18.08	Peak	Horizontal
4960.00	39.19	33.26	35.14	3.98	41.29	54.00	-12.71	Average	Horizontal
4960.00	51.99	33.26	35.14	3.98	54.09	74.00	-19.91	Peak	Vertical
4960.00	41.10	33.26	35.14	3.98	43.20	54.00	-10.80	Average	Vertical

Notes:

- 1). Measuring frequencies from 9 KHz - 10<sup>th</sup> harmonic (ex. 26GHz), No emission found between lowest internal used/generated frequency to 30 MHz.
- 2). Radiated emissions measured in frequency range from 9 KHz - 10<sup>th</sup> harmonic (ex. 26GHz) were made with an instrument using Peak detector mode.
- 3). 18~25GHz at least have 20dB margin. No recording in the test report.



## 8. POWER LINE CONDUCTED EMISSIONS

### 8.1 Standard Applicable

According to §15.207 (a): For an intentional radiator which is designed to be connected to the public utility (AC) power line, the radio frequency voltage that is conducted back onto the AC power line on any frequency or frequencies within the band 150 kHz to 30 MHz shall not exceed 250 microvolts (The limit decreases linearly with the logarithm of the frequency in the range 0.15 MHz to 0.50 MHz). The limits at specific frequency range are listed as follows:

Frequency Range (MHz)	Limits (dB $\mu$ V)	
	Quasi-peak	Average
0.15 to 0.50	66 to 56	56 to 46
0.50 to 5	56	46
5 to 30	60	50

\* Decreasing linearly with the logarithm of the frequency

### 8.2 Block Diagram of Test Setup

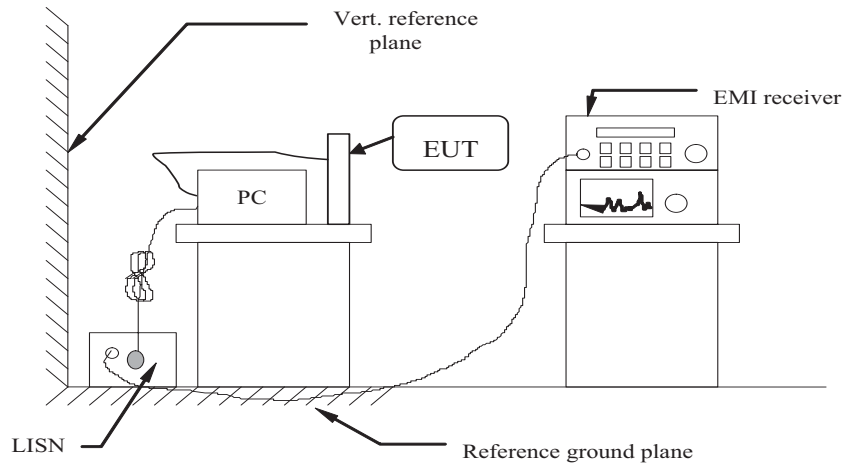

### 8.3 Test Results

**PASS.**

The test data please refer to following page.

AC Conducted Emission of power adapter @ AC 120V/60Hz @ GFSK (worst case)

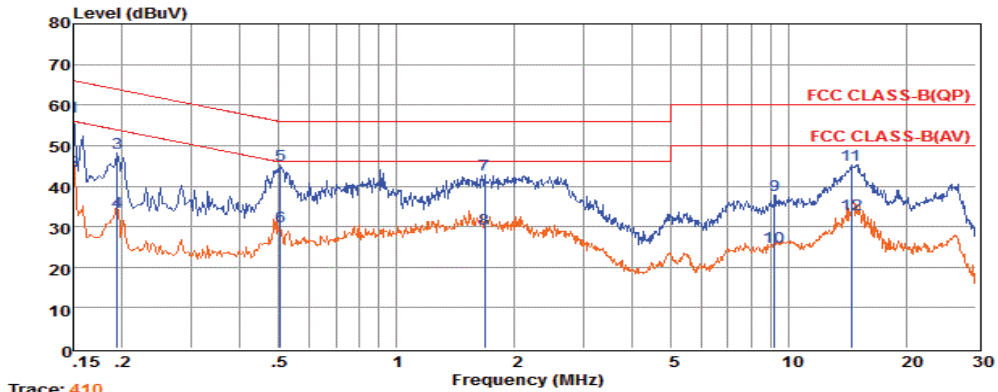

Trace: 410  
Pol:

NEUTRAL									
	Freq	Reading	LISNFac	CabLos	Aux2Fac	Measured	Limit	Over	Remark
	MHz	dBuV	dB	dB	dB	dB	dBuV	dBuV	dB
1	0.15	37.40	9.70	0.02	10.00	57.12	66.00	-8.88	QP
2	0.15	24.02	9.70	0.02	10.00	43.74	55.99	-12.25	Average
3	0.19	28.54	9.60	0.02	10.00	48.16	63.84	-15.68	QP
4	0.19	14.08	9.60	0.02	10.00	33.70	53.84	-20.14	Average
5	0.50	25.47	9.62	0.04	10.00	45.13	56.00	-10.87	QP
6	0.50	10.28	9.62	0.04	10.00	29.94	46.00	-16.06	Average
7	1.68	23.15	9.63	0.05	10.00	42.83	56.00	-13.17	QP
8	1.68	9.63	9.63	0.05	10.00	29.31	46.00	-16.69	Average
9	9.20	18.04	9.71	0.08	10.00	37.83	60.00	-22.17	QP
10	9.21	5.07	9.71	0.08	10.00	24.86	50.00	-25.14	Average
11	14.44	25.51	9.74	0.10	10.00	45.35	60.00	-14.65	QP
12	14.44	13.07	9.74	0.10	10.00	32.91	50.00	-17.09	Average

Remarks: 1. Measured = Reading + LISNFac + Cable Loss + Aux2 Fac.  
2. The emission levels that are 20dB below the official limit are not reported.

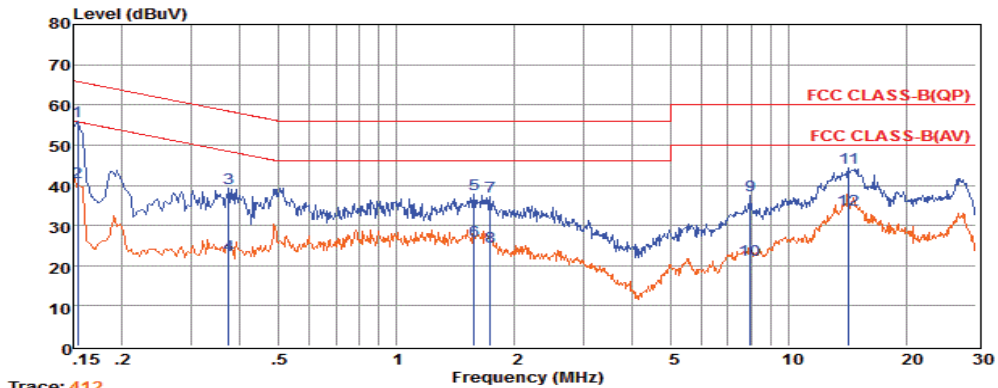

Trace: 412  
Pol:

LINE									
	Freq	Reading	LISNFac	CabLos	Aux2Fac	Measured	Limit	Over	Remark
	MHz	dBuV	dB	dB	dB	dB	dBuV	dBuV	dB
1	0.15	36.32	9.58	0.02	10.00	55.92	65.78	-9.86	QP
2	0.15	21.16	9.58	0.02	10.00	40.76	55.77	-15.01	Average
3	0.37	19.71	9.62	0.04	10.00	39.37	58.43	-19.06	QP
4	0.37	3.01	9.62	0.04	10.00	22.67	48.43	-25.76	Average
5	1.58	18.09	9.64	0.05	10.00	37.78	56.00	-18.22	QP
6	1.58	6.44	9.64	0.05	10.00	26.13	46.00	-19.87	Average
7	1.73	17.39	9.64	0.05	10.00	37.08	56.00	-18.92	QP
8	1.74	4.92	9.64	0.05	10.00	24.61	46.00	-21.39	Average
9	7.98	17.63	9.68	0.07	10.00	37.38	60.00	-22.62	QP
10	7.98	1.69	9.68	0.07	10.00	21.44	50.00	-28.56	Average
11	14.21	24.36	9.71	0.10	10.00	44.17	60.00	-15.83	QP
12	14.21	14.04	9.71	0.10	10.00	33.85	50.00	-16.15	Average

Remarks: 1. Measured = Reading + LISNFac + Cable Loss + Aux2 Fac.  
2. The emission levels that are 20dB below the official limit are not reported.

AC Conducted Emission of power adapter @ AC 240V/50Hz @ GFSK (worst case)

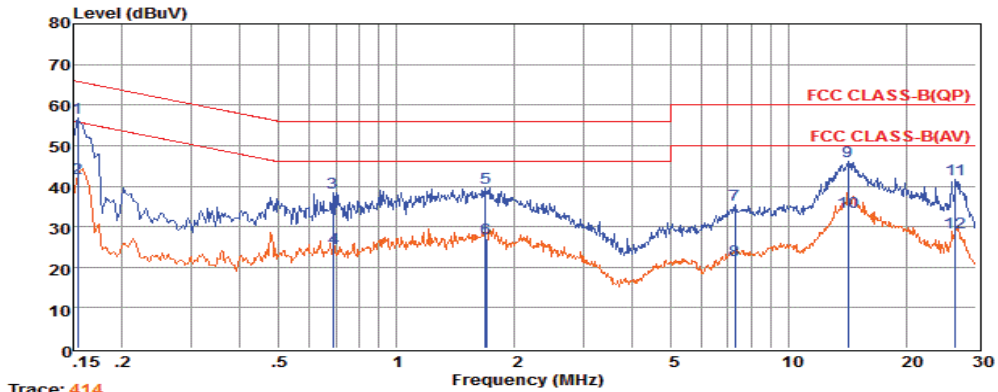

Trace: 414  
Pol:

LINE									
	Freq	Reading	LISNFac	CabLos	Aux2Fac	Measured	Limit	Over	Remark
	MHz	dBuV	dB	dB	dB	dB	dBuV	dBuV	dB
1	0.15	37.08	9.58	0.02	10.00	56.68	65.78	-9.10	QP
2	0.15	22.29	9.58	0.02	10.00	41.89	55.77	-13.88	Average
3	0.69	18.83	9.64	0.04	10.00	38.51	56.00	-17.49	QP
4	0.69	4.97	9.64	0.04	10.00	24.65	46.00	-21.35	Average
5	1.69	19.94	9.64	0.05	10.00	39.63	56.00	-16.37	QP
6	1.69	7.38	9.64	0.05	10.00	27.07	46.00	-18.93	Average
7	7.29	15.62	9.68	0.07	10.00	35.37	60.00	-24.63	QP
8	7.29	1.88	9.68	0.07	10.00	21.63	50.00	-28.37	Average
9	14.14	26.27	9.71	0.10	10.00	46.08	60.00	-13.92	QP
10	14.14	13.75	9.71	0.10	10.00	33.56	50.00	-16.44	Average
11	26.56	21.81	9.71	0.13	10.00	41.65	60.00	-18.35	QP
12	26.56	8.65	9.71	0.13	10.00	28.49	50.00	-21.51	Average

Remarks: 1. Measured = Reading + LISNFac + Cable Loss + Aux2 Fac.  
2. The emission levels that are 20dB below the official limit are not reported.

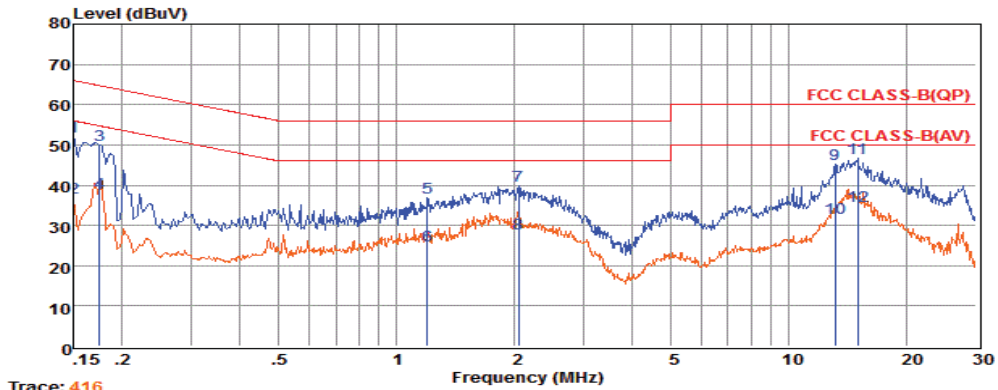

Trace: 416  
Pol:

NEUTRAL									
	Freq	Reading	LISNFac	CabLos	Aux2Fac	Measured	Limit	Over	Remark
	MHz	dBuV	dB	dB	dB	dB	dBuV	dBuV	dB
1	0.15	32.37	9.70	0.02	10.00	52.09	66.00	-13.91	QP
2	0.15	17.16	9.70	0.02	10.00	36.88	55.99	-19.11	Average
3	0.17	30.34	9.64	0.02	10.00	50.00	64.72	-14.72	QP
4	0.18	18.48	9.64	0.02	10.00	38.14	54.72	-16.58	Average
5	1.20	17.31	9.63	0.05	10.00	36.99	56.00	-19.01	QP
6	1.20	5.24	9.63	0.05	10.00	24.92	46.00	-21.08	Average
7	2.04	20.30	9.63	0.05	10.00	39.98	56.00	-16.02	QP
8	2.05	8.22	9.63	0.05	10.00	27.90	46.00	-18.10	Average
9	13.13	25.53	9.73	0.09	10.00	45.35	60.00	-14.65	QP
10	13.13	11.93	9.73	0.09	10.00	31.75	50.00	-18.25	Average
11	14.99	26.74	9.74	0.10	10.00	46.58	60.00	-13.42	QP
12	14.99	15.08	9.74	0.10	10.00	34.92	50.00	-15.08	Average

Remarks: 1. Measured = Reading + LISNFac + Cable Loss + Aux2 Fac.  
2. The emission levels that are 20dB below the official limit are not reported.

\*\*\*Note: Pre-scan all modes and recorded the worst case results in this report;

## 9. BAND-EDGE MEASUREMENTS FOR RADIATED EMISSIONS

### 9.1 Standard Applicable

In any 100 kHz bandwidth outside the frequency band in which the spread spectrum or digitally modulated intentional radiator is operating, the radio frequency power that is produced by the intentional radiator shall be at least 20 dB below that in the 100 kHz bandwidth within the band that contains the highest level of the desired power, based on either an RF conducted or a radiated measurement, provided the transmitter demonstrates compliance with the peak conducted power limits. If the transmitter complies with the conducted power limits based on the use of RMS averaging over a time interval, as permitted under paragraph (b)(3) of this section, the attenuation required under this paragraph shall be 30 dB instead of 20 dB. Attenuation below the general limits specified in §15.209(a) is not required. In addition, radiated emissions which fall in the restricted bands, as defined in §15.205(a), must also comply with the radiated emission limits specified in §15.209(a) (see §15.205(c)).

### 9.2 Block Diagram of Test Setup

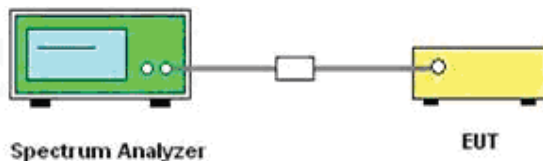

### 9.3 Measuring Instruments and Setting

Please refer to section 6 of equipment list in this report. The following table is the setting of Spectrum Analyzer.

### 9.4. Test Procedures

According to KDB 412172 section 1.1 Field Strength Approach (linear terms):

$$\text{eirp} = p_t \times g_t = (E \times d)^2 / 30$$

Where:

$p_t$  = transmitter output power in watts,

$g_t$  = numeric gain of the transmitting antenna (unitless),

$E$  = electric field strength in V/m,

$d$  = measurement distance in meters (m).

$$\text{erp} = \text{eirp} / 1.64 = (E \times d)^2 / (30 \times 1.64)$$

Where all terms are as previously defined.

1. Check the calibration of the measuring instrument using either an internal calibrator or a known signal from an external generator.
2. Remove the antenna from the EUT and then connect to a low loss RF cable from the antenna port to a EMI test receiver, then turn on the EUT and make it operate in transmitting mode. Then set it to Low Channel and High Channel within its operating range, and make sure the instrument is operated in its linear range.
3. Set both RBW and VBW of spectrum analyzer to 100 kHz with a convenient frequency span including 100kHz bandwidth from band edge, for Radiated emissions restricted band RBW=1MHz, VBW=3MHz for peak detector and RBW=1MHz, VBW=1/B for Peak detector.
4. Measure the highest amplitude appearing on spectral display and set it as a reference level. Plot the graph with marking the highest point and edge frequency.
5. Repeat above procedures until all measured frequencies were complete.
6. Measure the conducted output power (in dBm) using the detector specified by the appropriate regulatory agency for guidance regarding measurement procedures for determining quasi-peak, peak, and average conducted output power, respectively).

7. Add the maximum transmit antenna gain (in dBi) to the measured output power level to determine the EIRP level (see 12.2.5 for guidance on determining the applicable antenna gain)
8. Add the appropriate maximum ground reflection factor to the EIRP level (6 dB for frequencies ≤ 30 MHz, 4.7 dB for frequencies between 30 MHz and 1000 MHz, inclusive and 0 dB for frequencies > 1000 MHz).
9. For devices with multiple antenna-ports, measure the power of each individual chain and sum the EIRP of all chains in linear terms (e.g., Watts, mW).
10. Compare the resultant electric field strength level to the applicable regulatory limit.
11. Perform radiated spurious emission test duress until all measured frequencies were complete.

9.5. Test Results

<b>GFSK – Non-Hopping</b>							
Frequency (MHz)	Conducted Power (dBm)	Antenna Gain (dBi)	Ground Reflection Factor (dB)	Covert Radiated E Level At 3m (dBuV/m)	Detector	Limit (dBuV/m)	Verdict
2310.000	-48.840	2.00	0.000	48.390	Peak	54.00	PASS
2390.000	-48.801	2.00	0.000	48.429	Peak	54.00	PASS
2483.500	-49.258	2.00	0.000	47.972	Peak	54.00	PASS
2500.000	-50.255	2.00	0.000	46.975	Peak	54.00	PASS

<b><math>\pi/4</math>DQPSK – Non-Hopping</b>							
Frequency (MHz)	Conducted Power (dBm)	Antenna Gain (dBi)	Ground Reflection Factor (dB)	Covert Radiated E Level At 3m (dBuV/m)	Detector	Limit (dBuV/m)	Verdict
2310.000	-49.848	2.00	0.000	47.382	Peak	54.00	PASS
2390.000	-50.455	2.00	0.000	46.775	Peak	54.00	PASS
2483.500	-49.102	2.00	0.000	48.128	Peak	54.00	PASS
2500.000	-50.274	2.00	0.000	46.956	Peak	54.00	PASS

<b>8DPSK – Non-Hopping</b>							
Frequency (MHz)	Conducted Power (dBm)	Antenna Gain (dBi)	Ground Reflection Factor (dB)	Covert Radiated E Level At 3m (dBuV/m)	Detector	Limit (dBuV/m)	Verdict
2310.000	-50.490	2.00	0.000	46.740	Peak	54.00	PASS
2390.000	-50.444	2.00	0.000	46.786	Peak	54.00	PASS
2483.500	-46.956	2.00	0.000	50.274	Peak	54.00	PASS
2500.000	-50.157	2.00	0.000	47.073	Peak	54.00	PASS

Remark:

1. Measured at difference Packet Type for each mode and recorded worst case for each mode.
2. Worst case data at DH5 for GFSK, 2DH5 for  $\pi/4$ DQPSK, 3DH5 for 8DPSK modulation type;
3. Measured at Hopping and Non-Hopping mode, recorded worst at Non-Hopping mode.
4. The other emission levels were very low against the limit.
5. The average measurement was not performed when the peak measured data under the limit of average detection.
6. Detector AV is setting spectrum/receiver. RBW=1MHz/VBW=330KHz/Sweep time=Auto/Detector=Peak;
7. Since the out-of-band characteristics of the EUT transmit antenna will often be unknown, the use of a conservative antenna gain value is necessary. Thus, when determining the EIRP based on the measured conducted power, the upper bound on antenna gain for a device with a single RF output shall be selected as the maximum in-band gain of the antenna across all operating bands, or 2 dBi, whichever is greater. However, for devices that operate in multiple frequency bands while using the same transmit antenna, the highest gain of the antenna within the operating band nearest in frequency to the restricted

*band emission being measured may be used in lieu of the overall highest gain when the emission is at a frequency that is within 20 percent of the nearest band edge frequency, but in no case shall a value less than 2 dBi be used.*

8. *Please refer to following test plots;*

Band-edge measurements for radiated emissions

GFSK

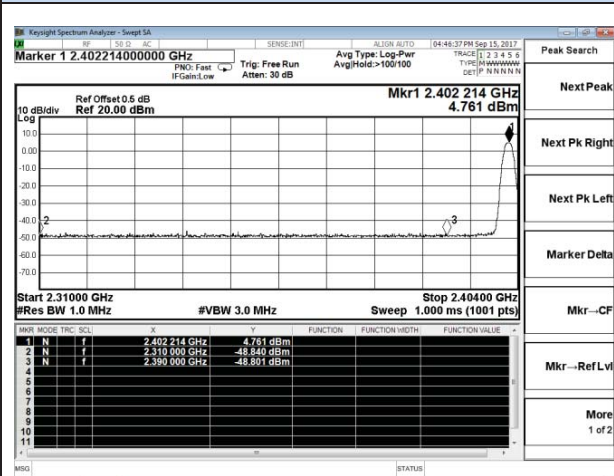

$\pi/4$ DQPSK

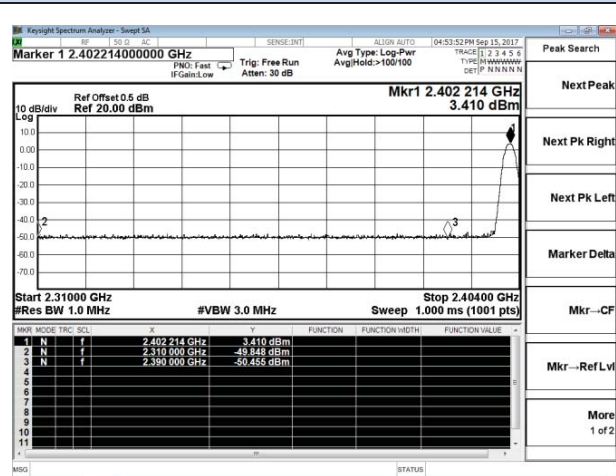

Channel 0 / 2402 MHz – Non-Hopping – Peak

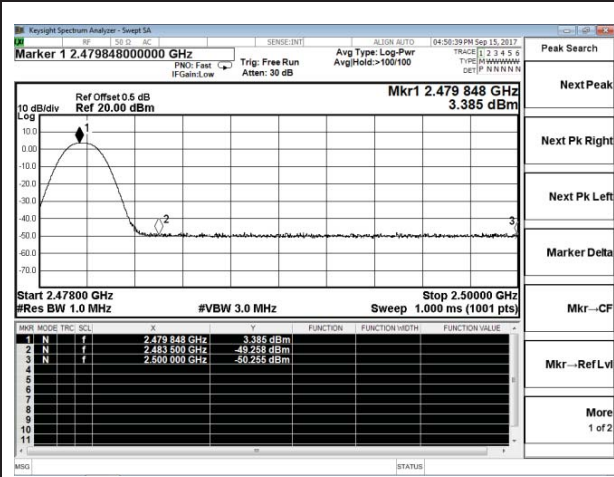

Channel 0 / 2402 MHz – Non-Hopping – Peak

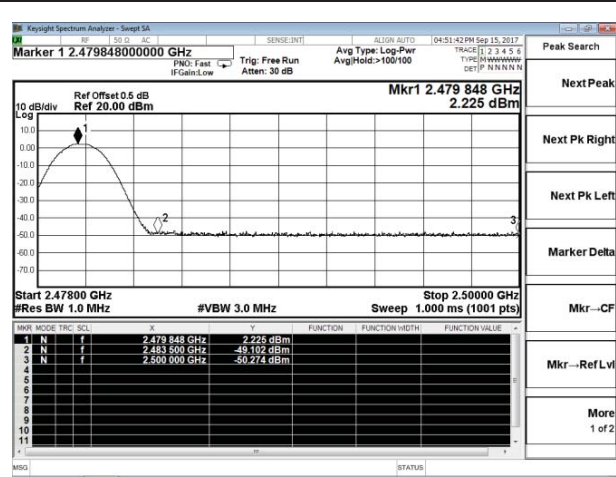

Channel 78 / 2480 MHz – Non-Hopping – Peak

8DPSK

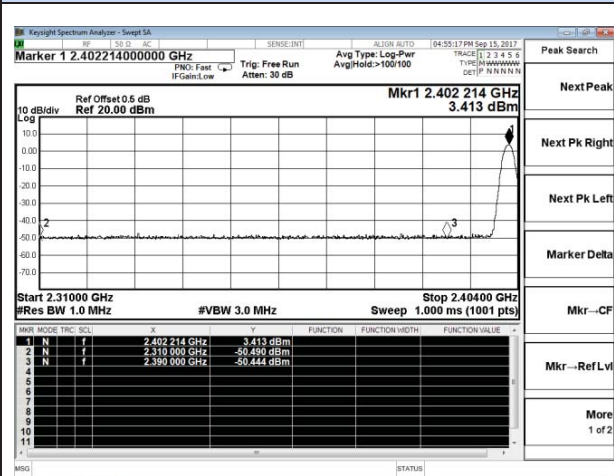

Channel 78 / 2480 MHz – Non-Hopping – Peak

8DPSK

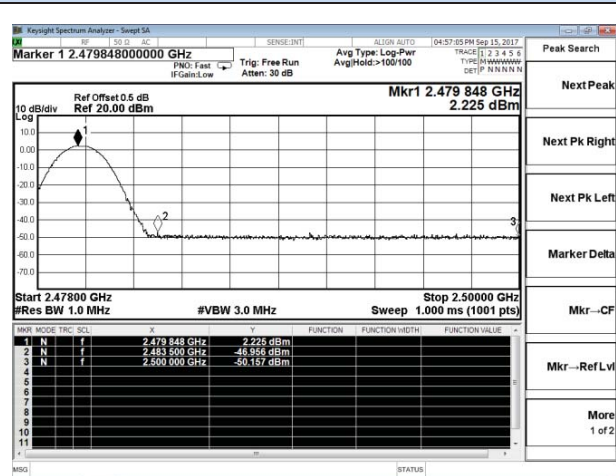

Channel 0 / 2402 MHz – Non-Hopping – Peak

Channel 78 / 2480 MHz – Non-Hopping – Peak

## 10. ANTENNA REQUIREMENT

### 10.1 Standard Applicable

According to antenna requirement of §15.203.

An intentional radiator shall be designed to ensure that no antenna other than that furnished by the responsible party shall be used with the device. The use of a permanently attached antenna or of an antenna that uses a unique coupling to the intentional radiator shall be considered sufficient to comply with the provisions of this Section. The manufacturer may design the unit so that a broken antenna can be re-placed by the user, but the use of a standard antenna jack or electrical connector is prohibited. This requirement does not apply to carrier current devices or to devices operated under the provisions of Sections 15.211, 15.213, 15.217, 15.219, or 15.221. Further, this requirement does not apply to intentional radiators that must be professionally installed, such as perimeter protection systems and some field disturbance sensors, or to other intentional radiators which, in accordance with Section 15.31(d), must be measured at the installation site. However, the installer shall be responsible for ensuring that the proper antenna is employed so that the limits in this Part are not exceeded.

And according to §15.247(4)(1), system operating in the 2400-2483.5MHz bands that are used exclusively for fixed, point-to-point operations may employ transmitting antennas with directional gain greater than 6dBi provided the maximum peak output power of the intentional radiator is reduced by 1 dB for every 3 dB that the directional gain of the antenna exceeds 6dBi.

### 10.2 Antenna Connected Construction

#### 10.2.1. Standard Applicable

According to § 15.203 & RSS-Gen, an intentional radiator shall be designed to ensure that no antenna other than that furnished by the responsible party shall be used with the device.

#### 10.2.2. Antenna Connector Construction

The directional gains of antenna used for transmitting is 0dBi, and the antenna is a Ceramic antenna connect to PCB board and no consideration of replacement. Please see EUT photo for details.

#### 10.2.3. Results: Compliance.

### Measurement

The antenna gain of the complete system is calculated by the difference of radiated power in EIRP and the conducted power of the module.

Conducted power refers ANSI C63.10:2013 Output power test procedure for FHSS devices.

Radiated power refers to ANSI C63.10:2013 Radiated emissions tests.

### Measurement parameters

Measurement parameter	
Detector:	Peak
Sweep Time:	Auto
Resolution bandwidth:	1MHz
Video bandwidth:	3MHz
Trace-Mode:	Max hold

Note: The antenna gain of the complete system is calculated by the difference of radiated power in EIRP and the conducted power of the module. For FHSS devices, the GFSK mode is used;



**Limits**

FCC	ISED
Antenna Gain	
6 dBi	

Tnom	Vnom	Lowest Channel 2402 MHz	Middle Channel 2441 MHz	Highest Channel 2480 MHz
Conducted power [dBm] Measured with GFSK modulation		4.595	4.145	3.633
Radiated power [dBm] Measured with GFSK modulation		4.445	4.055	3.503
Gain [dBi] Calculated		-0.15	-0.09	-0.13
Measurement uncertainty			$\pm 1.6$ dB (cond.) / $\pm 3.8$ dB (rad.)	

## **11. TEST SETUP PHOTOGRAPHS OF EUT**

Please refer to separated files for Test Setup Photos of the EUT.

## **12. EXTERIOR PHOTOGRAPHS OF THE EUT**

Please refer to separated files for External Photos of the EUT.

## **13. INTERIOR PHOTOGRAPHS OF THE EUT**

Please refer to separated files for Internal Photos of the EUT.

-----THE END OF REPORT-----