

## INSTRUCTION MANUAL

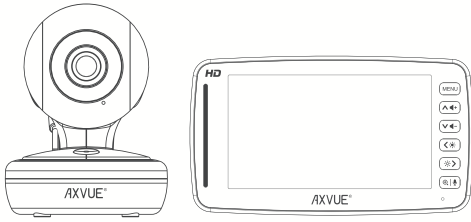

**AXVUE HD960 Video Baby Monitor**  
with 5.0" LCD Screen and Pan Tilt Camera

Please read the following instructions and warnings carefully  
Tools required for wall mount: Screwdriver and drill (not included)  
Keep this instruction manual for future reference.  
For technical support see FAQ page.  
For adult use only.

Get to know us at: [www.axvue.com](http://www.axvue.com)

### WARNING

#### WARNING

**THIS PRODUCT CANNOT REPLACE RESPONSIBLE ADULT SUPERVISION.**

-Strangulation Hazard - Children have STRANGLED in cords. Keep this cord out of reach of children (more than 3 feet away from the crib). Use enclosed Security Clips to help secure cord away from baby's reach. Never use extension cords with AC adapters. Only use the AC adapters provided.

- When an adapter is plugged into an electrical outlet, do not touch the exposed end.
- Test monitor before first use, periodically, and when changing location of the camera.
- Do not use monitor near water (such as bathtub, sink, etc.).
- Keep monitor away from heat sources (such as stoves, radiators, etc).
- Make sure there is proper ventilation around all monitor components. Do not place on sofas, cushions, beds, etc. which may block ventilation.
- This product is not a toy. Do not allow children to play with it. This product contains small parts. Adult assembly required. Exercise care when unpacking and assembling the product.

#### BATTERY WARNING

- Use only the original rechargeable battery provided. Please contact AXVUE INC. for replacement battery. Contact information can be found on last page of these instructions.
- Clean battery and product contacts prior to battery installation.
- Do not short-circuit supply terminals.
- Remove battery when product is stored for long periods of time or when battery is exhausted.
- Keep all batteries away from children.
- Dispose of exhausted battery properly.

### WARNING:



**STRANGULATION HAZARD** - Children have STRANGLED in cords. Keep this cord out of reach of children (more than 3 feet away from the crib). Use enclosed Security Clips to help secure cord away from baby's reach. Never use extension cords with AC adapters. Only use the AC adapters provided.

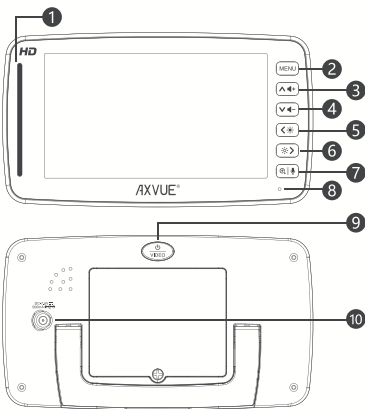

1. LED Indicator\*
2. Menu
3. UP / Volume Up
4. Down / Volume Down
5. Left / Brightness Low
6. Right / Brightness High
7. Zoom / Talk Back
8. Microphone
9. Power / Video Switch
10. DC Jack

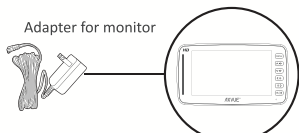
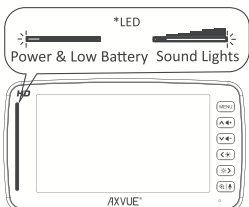

## Features and components (continued)

### CAMERA

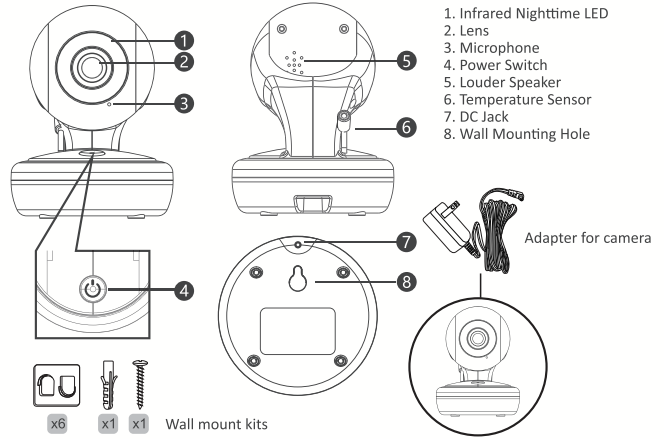

1. Infrared Nighttime LED
2. Lens
3. Microphone
4. Power Switch
5. Louder Speaker
6. Temperature Sensor
7. DC Jack
8. Wall Mounting Hole

**WARNING**

**STRANGULATION HAZARD** - Children have STRANGLED in cords. Keep this cord out of reach of children (more than 3 feet away from the crib). Use enclosed Security Clips to help secure cord away from baby's reach. Never use extension cords with AC adapters. Only use the AC adapters provided.

## Setup & use

### Charge the monitor for about 6-8 hours before first use.

Step 1: Test whether the monitor can receive image. Choose the properest place in the baby's room and then set up the camera, keep the camera plugged in and turned on.

Step 2: Long press the Power button (⏻) on the monitor for 5 seconds until the "AXVUE" logo shows on the screen, and then the image that camera transmits will display on the screen immediately. If the image does not display on the screen, then please turn to "Pair camera with monitor" part. If the image displays on the screen, then the initial test is completed and then follow the instruction below to install the camera.

**Install Camera:** Place the camera on a flat surface, such as the table or the shelf (as is shown in figure 1), or mount the camera on the wall (as is shown in figure 2). Make sure that the camera is at least 3 feet away from the crib and the power line should be put behind the camera reasonably whether the camera is installed on the desk or the shelf, or mounted on the wall. Start to adjust the camera's angle until the crib display on the monitor screen completely, or adjust it to the best viewing angle you think.

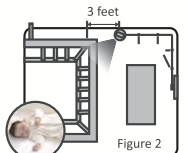
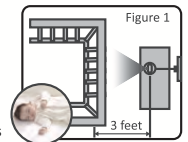

### WALL-MOUNTING

1. Drill a 3/16" (4.8mm) hole in the wall.
2. Insert the wall anchor into the hole and tap it gently with a hammer until the end of the anchor is flush with the wall.
3. Tighten the screw and keep 1/4 screw exposed outside the wall.
4. Connect the power adapter to the camera.
5. Fasten the camera's wall buckle on the exposed 1/4 screw and make sure that the camera is fixed on the wall.
6. Plug the camera's adapter into a standard power socket.
7. Use the safety clip to clamp the power line and fix it on the wall to avoid children's touching.

### HOW TO USE

- Step 1: Place the monitor in the living room, bedroom or anywhere else you're at. Connect the power adapter to the monitor and plug it into the power socket.
- Step 2: Long press the Power / Video Switch (⏻) for 5 seconds until the AXVUE logo and image shows on the screen completely to power on the monitor.
- Step 3: Just for sound and no video, press the power / Video Switch (⏻) on the top of the monitor screen to turn off the screen.
- Step 4: Long press the Power / Video Switch (⏻) for 5 seconds to power off the monitor screen completely.

### TO USE PORTABLE / BATTERY MODE

- Charge the battery for 6-8 hours before using the monitor in this default portable mode.
- Step 1: Charge the battery for 6 hours at least before using the monitor in default portable mode.
  - Step 2: Make sure the camera is plugged in.
  - Step 3: The battery life can be up to 8 hours if fully charged.

### PAIR CAMERA WITH MONITOR (ADD A CAMERA)

The monitor and camera have already been paired before shipment. If the monitor and camera are found not paired for some reason, follow the steps below to re-pair them.

- Step 1: Make sure the monitor and the camera are in the same space.
- Step 2: Make sure the camera is plugged in and long press the camera's Power Switch (⏻) for 3 seconds to turn on the camera, the green light should be on.
- Step 3: Long press the monitor's Power / Video Switch (⏻) for 5 seconds to turn on the monitor screen.
- Step 4: Press the Menu (☰) button to enter menu option.
- Step 5: Press the Down / Volume Down (⏮) button to choose CAMERA SETTING (📷) option.
- Step 6: Choose the camera marked with "+", then press OK button and then choose the numbered camera (1, 2) and then press OK button again to confirm it.



- Step 7: The icon (📷) indicates that the monitor is searching the camera's signal, then long press the camera's Power Switch (⏻) for 10 seconds and then a "beep" sound will be heard.
- Step 8: Then the camera and the monitor have been connected successfully, the real-time image will display on the screen.

The **SCAN**, **SELECT**, **ADD** and **DELETE CAMERA** menu options are only for multiple cameras. Purchase the extra cameras by visiting at <http://www.axvue.com>

### CAMERA ANGLE CONTROL



# Setup & use (continued)

## BRIGHTNESS ADJUSTMENT

Press the Menu button to enter menu option, press the Down / Volume Down button to choose BRIGHTNESS option and then press the OK button to confirm it, then press the Left / Brightness Low button or the Right / Brightness High button to adjust the brightness.



## VOX MODE

Press the Menu button to enter menu option, press the Down / Volume Down button to choose VOICE ACTIVATED VIDEO option and then press the OK button to enter the VOX mode, then press the Left / Brightness Low button or the Right / Brightness High button to choose VOX level. The higher level indicates that it need louder sound to activate the monitor screen under this mode, total three levels.



## LULLABIES

Press the Menu button to enter menu option, press the Down / Volume Down button to choose LULLABIES option and then press the OK button to confirm it, then press the Left / Brightness Low button or the Right / Brightness High button to choose a lullaby, total 5 lullabies.



## DELETE CAMERA

Press the Menu button to enter menu option, press the Down / Volume Down button to choose CAMERA SETTING option, then press the Right / Brightness High button to choose the camera marked with "2", then press OK button to confirm it and then delete the connected camera.



## TEMPERATURE UNIT

Press the Menu button to enter menu option, press the Down / Volume Down button to choose TEMPERATURE option and press the OK button to confirm it. Press the Left / Brightness Low button or the Right / Brightness High button to choose the temperature unit you need, Celsius or Fahrenheit.



## CAMERA SWITCHING

Press the Switch Camera button when you need to switch to the second camera's image. Press the Left / Brightness Low button or the Right / Brightness High button to choose the camera 2 icon, then press the OK button to switch it to the camera 2. If you want to watch both of the camera 1 and camera 2 at the same time, then choose to activate the split screen function. Choose to activate the auto-scanning function, camera 1 and camera 2 will take turns to display on the screen automatically every 10 seconds. (The above functions can only be activated when the monitor is paired with more than 2 cameras.)

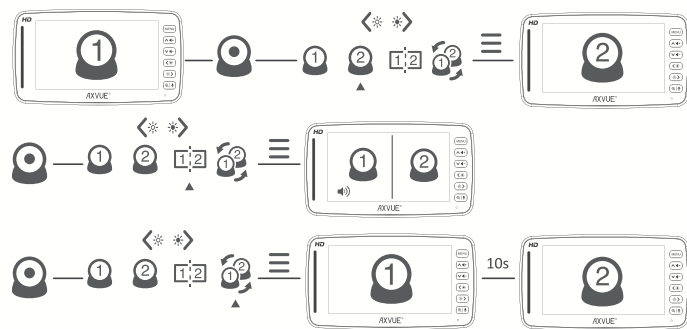

# Favorite features

## 6X DIGITAL ZOOM

The monitor displays the camera's image much closer and clearer under this mode. Press the Zoom / Talk Back button once and then the image will be zoomed in once, the image recovers to the original size after the seventh press.

## TWO-WAY COMMUNICATION

Your baby is always eager to your voice when crying. Press and hold the Zoom / Talk Back button on the monitor to activate two-way communication function.

## INFRARED NIGHT VISION

The optical sensor built in the camera enters the infrared night vision mode automatically when it senses the low light or darkness. The camera transmits clear black-and-white image to the monitor screen.

## SOUND INDICATOR

The LED light bar on the top of the monitor will light up as it picks up voices. Softer sounds will light up the green or amber LEDs. Louder noises will light up the all LEDs.

## VOLUME CONTROL

Turn up to volume to hear every little sound from baby, like cooing. You can also turn down the volume if baby makes a loud voice or cries. Press the UP / Volume Up button or Down / Volume Down button to adjust the volume to the proper level.

## POWER SAVING MODE

Press the Power / Video Switch button once to turn off the monitor screen to save battery if the monitor is not plugged in. The sound is still on the monitor when the monitor screen is off, press the Power / Video Switch button again to turn on the monitor screen.

# FAQ

## NO PICTURE OR SOUND

- Make sure the camera and handheld monitor unit are paired.
- Make sure the camera and handheld monitor unit are both turned on.
- Make sure the AC adapters are plugged in.
- Make sure the outlets are working.
- Make sure the battery is charged before working in portable mode.
- Keep the camera and monitor away from WiFi router (more than 10 feet off).

## SOUND BUT NO PICTURE

- Press the button once to turn on video mode.
- Check to make sure nothing is blocking the camera.
- Test reception by moving the monitor and / or camera to different locations.
- Pair the camera and monitor again.

## PICTURE BUT NO SOUND

- Power the monitor completely off, remove and re-insert the battery, then turn monitor back on.
- Turn up the volume using Volume Control.
- Make sure the camera and handheld monitor unit are paired.

## PICTURE NOT CLEAR

- Position the monitor closer to the camera, but not adjacent.
- Move the monitor away from other electronic devices, WiFi router, etc.
- Adjust the brightness using Brightness Control.
- Test reception by moving the monitor and / or camera to different locations.

## SQUEALING SOUND COMING FROM SPEAKER ON MONITOR

- Move the monitor and camera further away from each other.
- Turn the volume down using Volume Control.
- Power the monitor completely off, remove and re-insert the battery, then turn the monitor on again.

## CAUTION RISK OF ELECTRIC SHOCK DO NOT OPEN DO NOT EXPOSE TO RAIN OR MOISTURE

### IMPORTANT SAFETY INSTRUCTIONS

- Read safety and operating instructions before the product is operated.
- Retain instructions for future reference.
- Heed warnings on the product and in the operating instructions.
- Follow instructions and operate properly.
- Clean it after unplugging this product from the wall outlet. And use a damp cloth for cleaning.
- Use product manufacturer recommended attachments to avoid possible hazards.
- Do not use this product near humid place, for example, bath tub, wash bowl, kitchen sink, laundry tub, wet basement, swimming pool and the like.
- Ensure this product is installed securely on a stable cart, stand, tripod, bracket, or table. -Otherwise, The falling product may cause serious injury to a child or adult, and serious damage to the product.
- Use manufacturer recommended cart, stand, tripod, bracket, or table. Follow the manufacturer's instructions strictly and use recommended mounting kits to mount the product.
- The slots and openings in the cabinet are provided for ventilation and to ensure reliable operation of the product and to protect it from overheating, and keep these openings not blocked or covered.
- The openings should never be blocked by placing the product on a bed, sofa, rug, or other similar surfaces.
- This product should not be placed in a built-in installation such as a bookcase or rack unless proper ventilation is provided or the manufacturer's instructions have been adhered to.
- This product should be operated only from the type of power source indicated on the marking label. If you are not sure of the type of power supply to your home, consult your product dealer or local power company. For products intended to operate from battery power, or other sources, refer to the operating instructions.
- Power-supply cords should be routed so that they are not likely to be walked on or pinched by items placed upon or against them, paying particular attention to cords at plugs, convenience receptacles, and the point where they exit from the product.
- An outside antenna system should not be located in the vicinity of overhead power lines or other electric light or power circuits, or where it can fall into such power lines or circuits. When installing an outside antenna system, extreme care should be taken to keep from touching such power lines or circuits as contact with them might be fatal.
- Do not overload wall outlets, extension cords, or integral convenience receptacles as this can result in a risk of fire or electric shock.
- Never push objects of any kind into this product through openings as they may touch dangerous voltage points or short-out parts that could result in a fire or electric shock. Never spill liquid of any kind on the product.
- Do not attempt to service this product yourself as opening or removing covers may expose you to dangerous voltage or other hazards. Refer all servicing to qualified service personnel.
- Unplug this product from the wall outlet and refer servicing to qualified service personnel under the following conditions:
  - \*When the power-supply cord or plug is damaged.
  - \*If liquid has been spilled, or objects have fallen into the product.
  - \*If the product has been exposed to rain or water.
  - \*If the product does not operate normally by following the operating instructions. Adjusting only those controls that are covered by the operating instructions as an improper adjustment of other controls may result in damage and will often require extensive work by a qualified technician to restore the product to its normal operation.
  - \*If the product has been dropped or damaged in any way, or when the product exhibits a distinct change in performance - this indicated a need for service.
- Replacement Parts - When replacement parts are required, be sure the service technician has used replacement parts specified by the manufacturer or have the same characteristics as the original part. Unauthorized substitutions may result in fire, electric shock, or other hazards.
- Safety Check - Upon completion of any service or repairs to this product, ask the service technician to perform safety checks to determine that the product is in proper operating condition.
- The product should be mounted to a wall or ceiling only as recommended by the manufacturer.
- The product should be situated away from heat sources such as radiators, heat registers, stoves, or other products (including amplifiers) that produce heat.

# FCC Information

This device complies with part 15 of the FCC Rules. Operation is subject to the following two conditions: (1) This device may not cause harmful interference, and (2) This device must accept any interference received, including interference that may cause undesired operation.

## CAUTION

Changes or modifications not expressly approved by AXVUE may void the users authority to operate this equipment.

## NOTE

This equipment has been tested and found to comply with the limits for a Class B digital device, pursuant to Part 15 of the FCC Rules. These limits are designed to provide reasonable protection against harmful interference in a residential installation. This equipment generates, uses and can radiate radio frequency energy and, if not installed and used in accordance with the instructions, may cause harmful interference to radio communications. However, there is no guarantee that interference will not occur in a particular installation. If this equipment does cause harmful interference to radio or television reception, which can be determined by turning the equipment off and on, the user is encouraged to try to correct the interference by one or more of the following measures:

- Reorient or relocate the receiving antenna.
- Increase the separation between the equipment and receiver.
- Connect the equipment into an outlet on a circuit different from that to which the receiver is connected.
- Consult the dealer or an experienced radio / TV technician for help.

## CAUTION

1. To comply with FCC RF exposure compliance requirements, a separation distance of at least 20 cm must be maintained between the antenna of this device and all persons.
2. This transmitter must not be co-located or operating in conjunction with any other antenna or transmitter.

Get to know us at: [www.axvue.com](http://www.axvue.com)

Colors and styles may vary.

Please retain information for future reference.

# AXVUE®

AXVUE stands behind all of its products. If you are not completely satisfied or have any questions, please contact us at <http://www.axvue.com> connect with us:



AXVUE INC.  
19 W 34TH STREET SUITE 1018  
NEW YORK, NY 10001  
All rights Reserved.  
Model: HD960 03/18  
MADE IN CHINA

732-OHD9600-0100