

AXVUE E722 Video Baby Monitor with 2.8" LCD Screen and Two Cameras

Please read the following instructions and warnings carefully
Keep this instruction manual for future.
For technical support see FAQ page.
For adult use only.

Get to know us at: www.axvue.com

FEATURES & COMPONENTS

Camera:

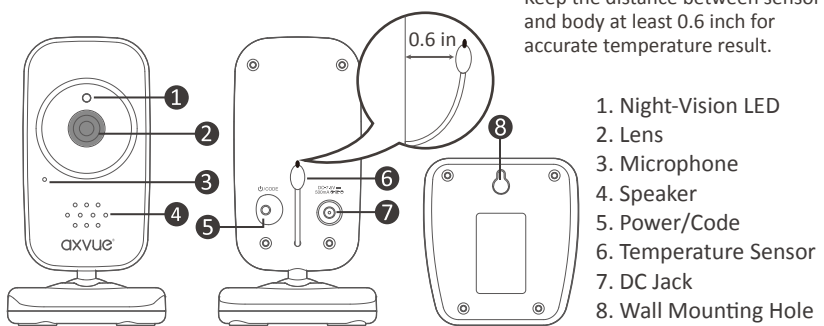

Keep the distance between sensor and body at least 0.6 inch for accurate temperature result.

1. Night-Vision LED
2. Lens
3. Microphone
4. Speaker
5. Power/Code
6. Temperature Sensor
7. DC Jack
8. Wall Mounting Hole

Monitor:

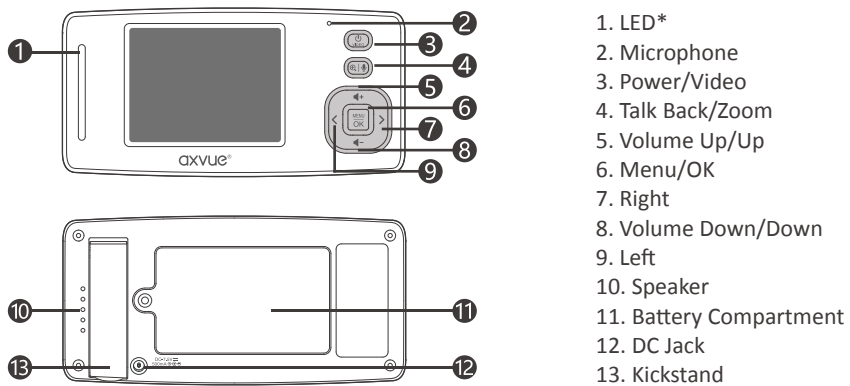

1. LED*
2. Microphone
3. Power/Video
4. Talk Back/Zoom
5. Volume Up/Up
6. Menu/OK
7. Right
8. Volume Down/Down
9. Left
10. Speaker
11. Battery Compartment
12. DC Jack
13. Kickstand

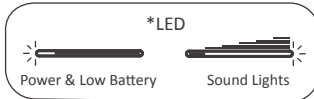

Adapters:

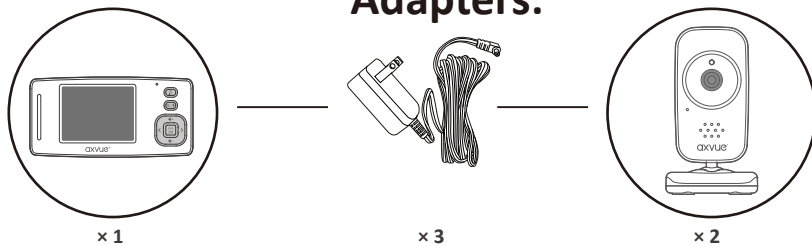

BATTERY WARNING

- Only use the recommended rechargeable battery. Please contact us if you need to change it. For the contact list, please refer to the last page of the instruction.
- Please clean the battery compartment before using it.
- Avoid short circuits the power supply terminal.
- Remove the battery when you are not using it or when running out of power.
- Keep the battery away from children.
- Dispose of the empty battery properly.

WARNING

THIS PRODUCT CAN NOT SUBSTITUTE PARENT'S SUPERVISION ON YOUR CHILD.



- Store this product out of the reach of babies (at least 3 feet (0.9 m) away from the crib). A strap wound around the baby's neck may result in asphyxiation. Use a safety clip to clamp the power cord and keep it out of baby's reach. Do not use other extension cords. Only use the power adapter provided.
- Do not touch the exposed part if the adapter is connected with power.
- Test regularly before initial use or when change the position of camera.
- Avoid placing the product in humid place or contacting with liquid. (such as bathtub, sink, etc.)
- Do not apply heat to the product (such as stoves, radiators, etc.)
- Using the product in ventilated place. Avoid placing it on sofas, cushions, beds or other places which may block ventilation.
- The product only can be operated by adult. Do not allow baby to play with it. Tiny accessories are contained, please be careful when unpack and install it.

SETUP & USE

Please charge the battery for at least 8 hours before using the product.

Step 1: Test reception first, put the camera in a suitable place that will provide you the best view of your baby in the crib (Note: Do not hang up the camera firmly until the initial installation test is completed). Plug the adapter into the wall outlet and turn on the camera.

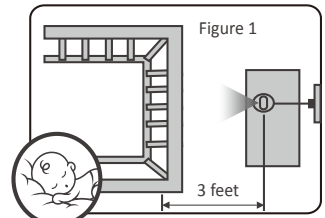

Step 2: Turn on the monitor by pressing and holding the Power/Video "⏻" button for 6 seconds until "axvue" shows up, then the video will show up on the screen immediately. If the video does not show up, please refer to "TO PAIR MONITOR AND CAMERA (ADD CAMERA)" on the next page. If the video shows up, the initial installation test is completed, then you can set up the camera according to the instruction below.

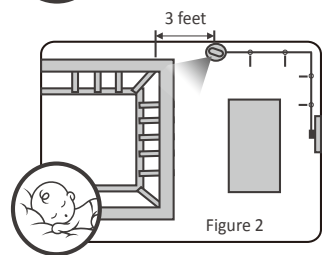

Set Up Camera: Place the camera on a flat surface, such as a wardrobe or shelf (Figure 1). Or hang it on the wall (Figure 2). No matter wherever to place the camera, please make sure to keep it away from the crib for at least 3 feet and all power cords should be placed behind the camera properly. Then adjust the angle of the camera lens until the entire crib shows up on the display, or adjust it to the best angle that you think to watch your baby.

TO USE PLUGGED-IN MODE

Step 1: Place the monitor display in living room, bedroom or any place you want to watch your baby. Use adapter to connect camera with electrical outlet.

Step 2: Turn on monitor by pressing Power/Video "⏻" button for 6 seconds until axvue logo or video shows up on the screen.

Step 3: Press Power/Video "⏻" button to turn off the video if you only need to hear the voice.

Step 4: Turn off the monitor completely by pressing and holding Power/Video "⏻" button for 5 seconds.

TO USE PORTABLE/BATTERY MODE

Please charge the battery for 6~8 hours before using the product.

Step 1: Charge the battery for at least 8 hours before using portable/battery mode.

Step 2: Make sure the adapter is plugged into camera.

Step 3: The battery life can be up to 10 hours if it is fully charged.

Battery life will be shortened if recharging it continuously. Unplug the power adapter when you are not using it for a long time.

TO PAIR MONITOR AND CAMERA (ADD CAMERA)

The monitor and camera are paired before shipment. If it is unpaired for some reason, please refer to the following steps:

Step 1: Make sure the camera and monitor are in the same place.

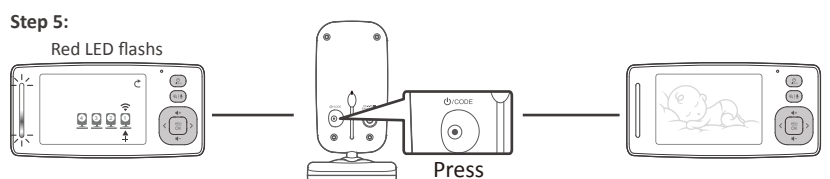
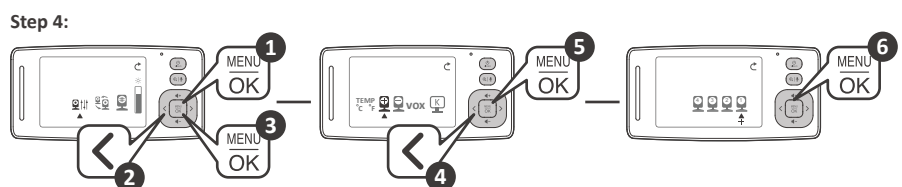
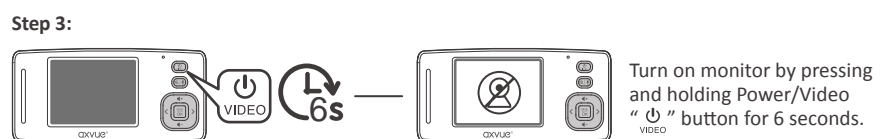
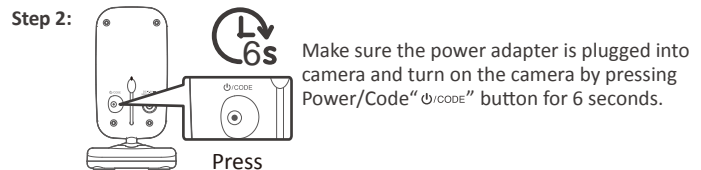

The SCAN, SELECT, ADD, DELETE, VIEW CAMERA options are only available when multiple cameras connected with the monitor. Order extra cameras by visiting us at www.axvue.com or search "Axvue Baby monitor" on Amazon.

SETUP & USE (continued)

TO DELETE A CAMERA

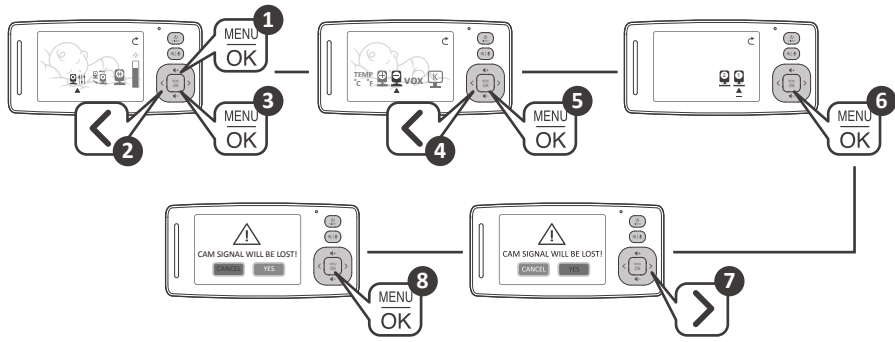

TO SET UP VOX - VIDEO ON CRYING

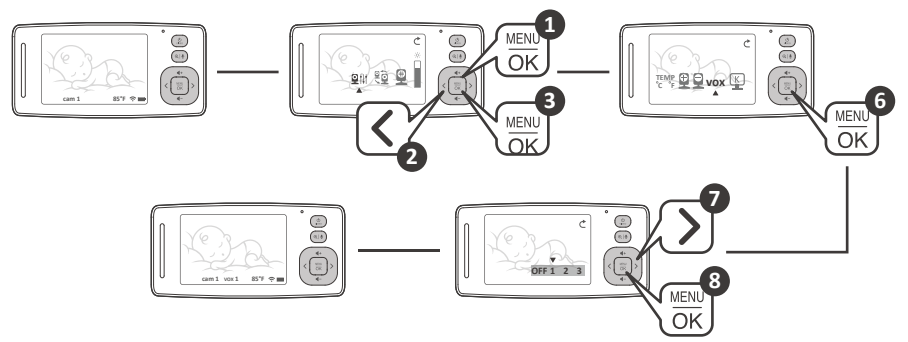

TO SELECT A CAMERA

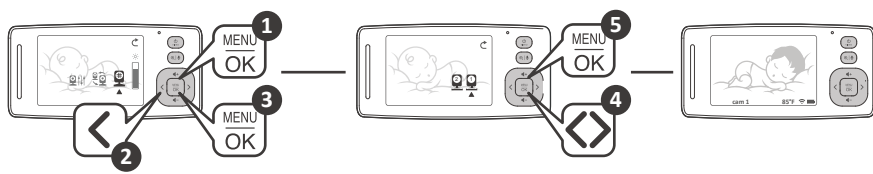

TO ADJUST SCREEN COLOR TEMPERATURE

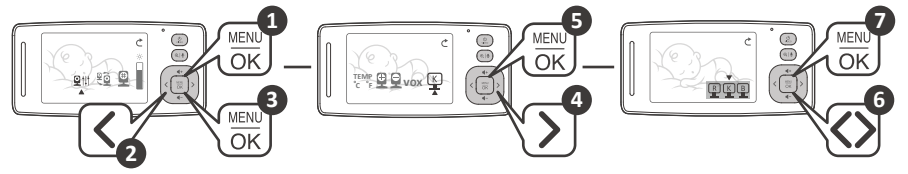

TO SCAN ALL CAMERAS (AUTO-SCAN)



Favorite Features

DIGITAL ZOOM IN & OUT

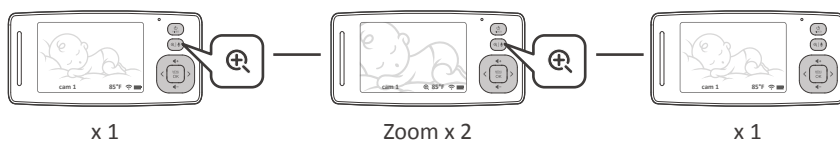

VOLUME CONTROL



BRIGHTNESS ADJUSTMENT

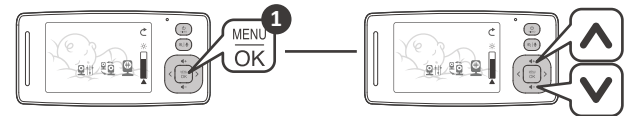

TWO-WAY COMMUNICATION

Press and hold the Talk Back/Zoom button on the monitor to activate two-way communication

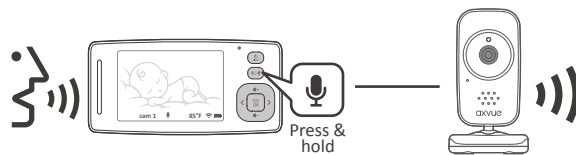

TEMPERATURE DISPLAY

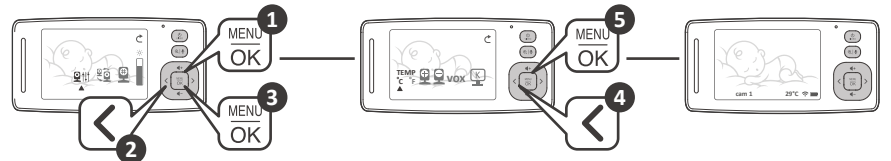

CAUTION RISK OF ELECTRIC SHOCK DO NOT OPEN

DO NOT EXPOSE TO RAIN OR MOISTURE

IMPORTANT SAFETY INSTRUCTIONS

- Make sure you read this instruction carefully before using the product.
- Store this instruction safely for your future reference.
- Ensure that you read the "Warning" section of the product package and this instruction carefully.
- Use the product properly by following this instruction.
- Wipe the product by wet towel after you take it down from the wall.
- Avoid possible danger by following manufacturer's instruction.
- Do not using the product in humid place or contact with liquid, like bathtub, hand washing sink, kitchen sink, laundry tub, humid basement, swimming pool, etc.
- Ensure the product is installed in a flat place. Otherwise, it will cause serious personal injury and product damage when dropped.
- Only follow this instruction and use installation tools provided by the manufacturer to set up the product.
- The slots and holes on the product are used for ventilation, please ensure that it is not covered or blocked by other objects.
- Do not place the product on bed, sofa, rug or other similar places, it will block or cover the slots and holes on the product. Do not place the product in a closed bookcase or shelf unless it has particular part for ventilation.
- This product should be connected with certain power supply unit, if you are not sure about the power supply system in your home, please contact with your product dealer and local power supply company. Please refer to the operating instruction if you want to operate the product in portable/battery mode or by connecting with other power supply sources.
- Power supply cords should be routed so that they are not likely to be walked on or pinched by items placed upon or against them, paying particular attention to cords at plugs, convenience receptacles, and the point where they exit from the product.
- An outside antenna system should not be located in the vicinity of overhead power lines or other electrical lines or power circuits, it will cause interference for the signal transmission. When installing an outside antenna system, extremely attention should be paid to avoid touching such power lines or circuits, otherwise, you will have possible danger of electrical shock.
- Do not overload wall outlet, extension cords or convenience receptacles, this can be cause a risk of fire or electrical shock.
- Do not insert any tiny objects into the product's inside, it may touch dangerous voltage point or cause short-circuit, this can be cause a risk of fire or electrical shock. Any kind of liquid spillage happens on the product should be avoid.
- Do not maintain the product by yourself as opening and removing the covering, this may expose you to dangerous voltage or other hazards. Please contact with qualified service personnel for maintaining.
- Unplug the product from wall outlet and contact with qualified service personnel if you have problems as below:
 - When the power-supply cord or plug has been damaged.
 - If liquid has been spilled, or objects have fallen into the product.
 - If the product has been exposed to rain or water.
 - If the product didn't operate normally by following the operating instructions, please only adjust those controls which are covered by the operating instructions. An improper adjustment of other controls may result in product damage, it will also require extensive work from qualified service personnel to restore the product to its normal operation mode.
 - If the products has been dropped or damaged in any way, or when the product shows a distinct change in performance
 - this indicated that the product need to be maintained.
- Replacement parts - When replacement parts are required, be sure the service technician has used replacement parts specified by the manufacturer or its have the same characteristics as the original part. Unauthorized substitutions may result in fire, electrical shock or other hazards.
- Safety Check - Upon completion of any service or repairs to this product, ask the service technician to run safety checks on the product to confirm that it is in a proper operating condition.
- The product only can be mounted on the wall or ceiling as recommended by the manufacturer.
- The product should be kept away from heat sources, such as radiator, heat registers, stoves or other products (including amplifier) which can produce heat.

FCC INFORMATION

This device complies with part 15 of FCC Rules. Operation is subject to the following two conditions: (1) The device may not cause harmful interference, and (2) This device must accept any interference received, including interference that may cause undesired operation.

CAUTION

Changes and modifications not expressly approved by AXVUE may void the users authority to operate this equipment.

NOTE

This equipment has been tested and found to comply with the limits for a Class B digital device, Pursuant to Part 15 of the FCC Rules. These limits are designed to provide reasonable protection against harmful interference in a residential installation. This equipment generates, uses and can radiate radio frequency energy and, if not installed and used in accordance with the instructions, may cause harmful interference to radio communications. However, there is no guarantee that interference will not occur in a particular installation. If this equipment does cause harmful interference to radio or television reception, which can be determined by turning the equipment off and on, the user is encouraged to try to correct the interference by one or more of the following measures:

- Reorient or relocate the receiving antenna.
- Increase the separation between the equipment and receiver.
- Connect the equipment into an outlet on a circuit different from that to which the receiver is connected.

CAUTION

1. To comply with the FCC RF exposure compliance requirement, a separation distance of 20 cm must be maintained between the antenna of this device and all persons.
2. This transmitter must not be co-located or operating in conjunction with any other antenna or transmitter.

axvue

AXVUE stands behind all of its products. If you are not completely satisfied or have any questions, please contact us at <https://www.axvue.com>
Connect with us:

AXVUE INC.

Revised at 12/2020

*Any updated or revised version please refer to axvue official website.

732-E72200-0700