

FCC 47 CFR PART 15 SUBPART C

CERTIFICATION TEST REPORT

For

Baby Monitor

MODEL No.: E610

FCC ID: 2AJD6-610R

Trademark: N/A

REPORT NO.: ES160729009E

ISSUE DATE: October 08, 2016

Prepared for

SHENZHEN LOFTYNN INTELLIGENCE TECHNOLOGY CO., LTD.

Room 301, Xindongxing Commercial Centre, Liuxian 2nd Road, Baoan,
Shenzhen, GD 518101, China

Prepared by

EMTEK (SHENZHEN) CO., LTD.

Bldg 69, Majialong Industry Zone, Nanshan District, Shenzhen,
Guangdong, China

TEL: 86-755-26954280

FAX: 86-755-26954282

Table of Contents

1 TEST RESULT CERTIFICATION 3

2 EUT TECHNICAL DESCRIPTION 4

3 SUMMARY OF TEST RESULT..... 5

4 TEST METHODOLOGY 6

 4.1 GENERAL DESCRIPTION OF APPLIED STANDARDS..... 6

 4.2 MEASUREMENT EQUIPMENT USED..... 6

 4.3 DESCRIPTION OF TEST MODES 7

5 FACILITIES AND ACCREDITATIONS 8

 5.1 FACILITIES..... 8

 5.2 LABORATORY ACCREDITATIONS AND LISTINGS 8

6 TEST SYSTEM UNCERTAINTY 9

7 SETUP OF EQUIPMENT UNDER TEST..... 10

 7.1 RADIO FREQUENCY TEST SETUP 1 10

 7.2 RADIO FREQUENCY TEST SETUP 2..... 10

 7.3 CONDUCTED EMISSION TEST SETUP..... 12

 7.4 BLOCK DIAGRAM CONFIGURATION OF TEST SYSTEM..... 13

 7.5 SUPPORT EQUIPMENT..... 13

8 TEST REQUIREMENTS..... 14

 8.1 20DB BANDWIDTH..... 14

 8.2 CARRIER FREQUENCY SEPARATION 17

 8.3 NUMBER OF HOPPING FREQUENCIES 20

 8.4 AVERAGE TIME OF OCCUPANCY (DWELL TIME)..... 22

 8.5 MAXIMUM PEAK CONDUCTED OUTPUT POWER..... 24

 8.6 CONDUCTED SUPRIOUS EMISSION..... 27

 8.7 RADIATED SPURIOUS EMISSION 34

 8.8 CONDUCTED EMISSION TEST 48

 8.9 ANTENNA APPLICATION 51

APPENDIX A-PHOTOGRAPHS OF EUT 52

1 TEST RESULT CERTIFICATION

Applicant:	SHENZHEN LOFTYNN INTELLIGENCE TECHNOLOGY CO., LTD. Room 301, Xindongxing Commercial Centre, Liuxian 2nd Road, Baoan, Shenzhen, GD 518101, China
Manufacturer:	SHENZHEN LOFTYNN INTELLIGENCE TECHNOLOGY CO., LTD. Room 301, Xindongxing Commercial Centre, Liuxian 2nd Road, Baoan, Shenzhen, GD 518101, China
Product Description:	Baby Monitor
Model Number:	E610
Trademark:	N/A
File Number:	ES160729009E

Measurement Procedure Used:

APPLICABLE STANDARDS	
STANDARD	TEST RESULT
FCC 47 CFR Part 2, Subpart J FCC 47 CFR Part 15, Subpart C	PASS

The above equipment was tested by EMTEK (SHENZHEN) CO., LTD. The test data, data evaluation, test procedures, and equipment configurations shown in this report were made in accordance with the procedures given in ANSI C63.10 (2013) and the energy emitted by the sample EUT tested as described in this report is in compliance with the requirements of FCC Rules Part 2 and Part 15.247

The test results of this report relate only to the tested sample identified in this report

Date of Test : July 30, 2016 to October 08, 2016

Prepared by : 
Sevin Li /Editor

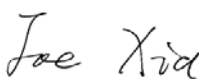
Reviewer : 
Joe Xia /Supervisor

Approve & Authorized Signer : 
Lisa Wang/Manager

2 EUT TECHNICAL DESCRIPTION

Characteristics	Description
Product:	Baby Monitor
Device Type:	DSS
Modulation:	GFSK
Operating Frequency Range(s):	2409-2469.8 MHz
Number of Channels:	18 Channels
Transmit Power Max:	DSS: 15.792 dBm
Antenna Type:	PiFa antenna
Antenna Gain:	0 dBi
Power supply:	DC 4.8V via Battery & DC 7.5V via Adapter
	Adapter information Model: P5 0750500 Input: AC 100-240V, 250mA Output: DC7.5V 500mA
Temperature Range:	0°C ~ +45°C

Note: for more details, please refer to the User's manual of the EUT.

3 SUMMARY OF TEST RESULT

FCC Part Clause	Test Parameter	Verdict	Remark
15.247(a)(1)	20 dB Bandwidth	PASS	
15.247(a)(1)	Carrier Frequency Separation	PASS	
15.247(a)(1)	Number of Hopping Frequencies	PASS	
15.247(a)(1)	Average Time of Occupancy (Dwell Time)	PASS	
15.247(b)(1)	Maximum Peak Conducted Output Power	PASS	
15.247(c)	Conducted Spurious Emissions	PASS	
15.247(d) 15.209	Radiated Spurious Emissions	PASS	
15.207	Conducted Emission	PASS	
15.203	Antenna Application	PASS	
NOTE1: N/A (Not Applicable)			

RELATED SUBMITTAL(S) / GRANT(S):

This submittal(s) (test report) is intended for FCC ID: 2AJD6-610R filing to comply with Section 15.247 of the FCC Part 15, Subpart C Rules.

4 TEST METHODOLOGY

4.1 GENERAL DESCRIPTION OF APPLIED STANDARDS

According to its specifications, the EUT must comply with the requirements of the following standards:
 FCC 47 CFR Part 2, Subpart J
 FCC 47 CFR Part 15, Subpart C
 DA 00-705

4.2 MEASUREMENT EQUIPMENT USED

4.2.1 Conducted Emission Test Equipment

EQUIPMENT TYPE	MFR	MODEL NUMBER	SERIAL NUMBER	LAST CAL.
Test Receiver	Rohde & Schwarz	ESCS30	828985/018	May 29, 2016
L.I.S.N.	Schwarzbeck	NNLK8129	8129203	May 28, 2016
50Ω Coaxial Switch	Anritsu	MP59B	M20531	May 29, 2016
Pulse Limiter	Rohde & Schwarz	ESH3-Z2	100006	May 28, 2016
Voltage Probe	Rohde & Schwarz	TK9416	N/A	May 28, 2016

4.2.2 Radiated Emission Test Equipment

EQUIPMENT TYPE	MFR	MODEL NUMBER	SERIAL NUMBER	LAST CAL.
EMI Test Receiver	Rohde & Schwarz	ESU	1302.6005.26	May 29, 2016
Pre-Amplifier	HP	8447D	2944A07999	May 28, 2016
Bilog Antenna	Schwarzbeck	VULB9163	142	May 28, 2016
Loop Antenna	ARA	PLA-1030/B	1029	May 28, 2016
Horn Antenna	Schwarzbeck	BBHA 9170	BBHA9170399	May 28, 2016
Horn Antenna	Schwarzbeck	BBHA 9120	D143	May 28, 2016
Cable	Schwarzbeck	AK9513	ACRX1	May 29, 2016
Cable	Rosenberger	N/A	FP2RX2	May 29, 2016
Cable	Schwarzbeck	AK9513	CRPX1	May 29, 2016
Cable	Schwarzbeck	AK9513	CRRX2	May 29, 2016

4.2.3 Radio Frequency Test Equipment

EQUIPMENT TYPE	MFR	MODEL NUMBER	SERIAL NUMBER	LAST CAL.
Spectrum Analyzer	Agilent	E4407B	88156318	May 28, 2016
Signal Analyzer	Agilent	N9010A	My53470879	May 28, 2016
Power meter	Anritsu	ML2495A	0824006	May 28, 2016
Power sensor	Anritsu	MA2411B	0738172	May 28, 2016

Remark: Each piece of equipment is scheduled for calibration once a year.

4.3 DESCRIPTION OF TEST MODES

The EUT has been tested under its typical operating condition.

The EUT configuration for testing is installed on RF field strength measurement to meet the Commissions requirement and operating in a manner which intends to maximize its emission characteristics in a continuous normal application.

The Transmitter was operated in the normal operating mode. The TX frequency was fixed which was for the purpose of the measurements.

Test of channel included the lowest and middle and highest frequency to perform the test, then record on this report.

Pre-defined engineering program for regulatory testing used to control the EUT for staying in continuous transmitting and receiving mode is programmed.

Frequency and Channel list :

Channel	Frequency (MHz)	Channel	Frequency (MHz)	Channel	Frequency (MHz)
0	2409.0	07	2433.8
1	2412.4	08	2437.2	15	2463.0
2	2415.8	09	2440.6	16	2466.4
...	17	2469.8

Test Frequency and channel:

Lowest Frequency		Middle Frequency		Highest Frequency	
Channel	Frequency (MHz)	Channel	Frequency (MHz)	Channel	Frequency (MHz)
00	2409.0	08	2437.2	17	2469.8

5 FACILITIES AND ACCREDITATIONS

5.1 FACILITIES

All measurement facilities used to collect the measurement data are located at

Bldg 69, Majialong Industry Zone District, Nanshan District, Shenzhen, China

The sites are constructed in conformance with the requirements of ANSI C63.7, ANSI C63.10 and CISPR Publication 22.

5.2 LABORATORY ACCREDITATIONS AND LISTINGS

Site Description

- EMC Lab.
- : Accredited by CNAS, 2013.10.29
The certificate is valid until 2016.10.28
The Laboratory has been assessed and proved to be in compliance with CNAS-CL01: 2006(identical to ISO/IEC17025: 2005)
The Certificate Registration Number is L2291
 - : Accredited by TUV Rheinland Shenzhen, 2010.5.25
The Laboratory has been assessed according to the requirements ISO/IEC 17025.
 - : Accredited by FCC, July 06, 2016
The Certificate Registration Number is 406365.
 - : Accredited by Industry Canada, November 24, 2015
The Certificate Registration Number is 4480A

6 TEST SYSTEM UNCERTAINTY

The following measurement uncertainty levels have been estimated for tests performed on the apparatus:

Parameter	Uncertainty
Radio Frequency	$\pm 1 \times 10^{-5}$
Maximum Peak Output Power Test	$\pm 1.0\text{dB}$
Conducted Emissions Test	$\pm 2.0\text{dB}$
Radiated Emission Test	$\pm 2.0\text{dB}$
Occupied Bandwidth Test	$\pm 1.0\text{dB}$
Band Edge Test	$\pm 3\text{dB}$
All emission, radiated	$\pm 3\text{dB}$
Antenna Port Emission	$\pm 3\text{dB}$
Temperature	$\pm 0.5^{\circ}\text{C}$
Humidity	$\pm 3\%$

Measurement Uncertainty for a level of Confidence of 95%

7 SETUP OF EQUIPMENT UNDER TEST

7.1 RADIO FREQUENCY TEST SETUP 1

The eut component's antenna port(s) of the EUT are connected to the measurement instrument per an appropriate attenuator. The EUT is controlled by PC/software to emit the specified signals for the purpose of measurements.

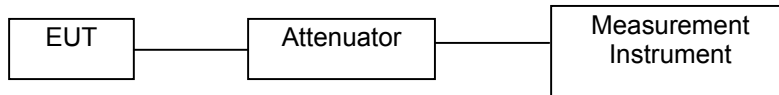

7.2 RADIO FREQUENCY TEST SETUP 2

The test site semi-anechoic chamber has met the requirement of NSA tolerance 4 dB according to the standards: ANSI C63.10. The test distance is 3m. The setup is according to the requirements in Section 13.1.4.1 of ANSI C63.10-2013 and CAN/CSA-CEI/IEC CISPR 22.

Below 30MHz:

The EUT is placed on a turntable 0.8 meters above the ground in the chamber, 3 meter away from the antenna (loop antenna). The Antenna should be positioned with its plane vertical at the specified distance from the EUT and rotated about its vertical axis for maximum response at each azimuth about the EUT. The center of the loop shall be 1 m above the ground. For certain applications, the loop antenna plane may also need to be positioned horizontally at the specified distance from the EUT.

Above 30MHz:

The EUT is placed on a turntable 0.8 meters above the ground in the chamber, 3 meter away from the antenna. The maximal emission value is acquired by adjusting the antenna height, polarisation and turntable azimuth. Normally, the height range of antenna is 1 m to 4 m, the azimuth range of turntable is 0° to 360°, and the receive antenna has two polarizations Vertical (V) and Horizontal (H).

Above 1GHz:

(Note: the FCC's permission to use 1.5m as an alternative per TCBC Conf call of Dec. 2, 2014.)

The EUT is placed on a turntable 1.5 meters above the ground in the chamber, 3 meter away from the antenna. The maximal emission value is acquired by adjusting the antenna height, polarisation and turntable azimuth. Normally, the height range of antenna is 1 m to 4 m, the azimuth range of turntable is 0° to 360°, and the receive antenna has two polarizations Vertical (V) and Horizontal (H).

(a) Radiated Emission Test Set-Up, Frequency Below 30MHz

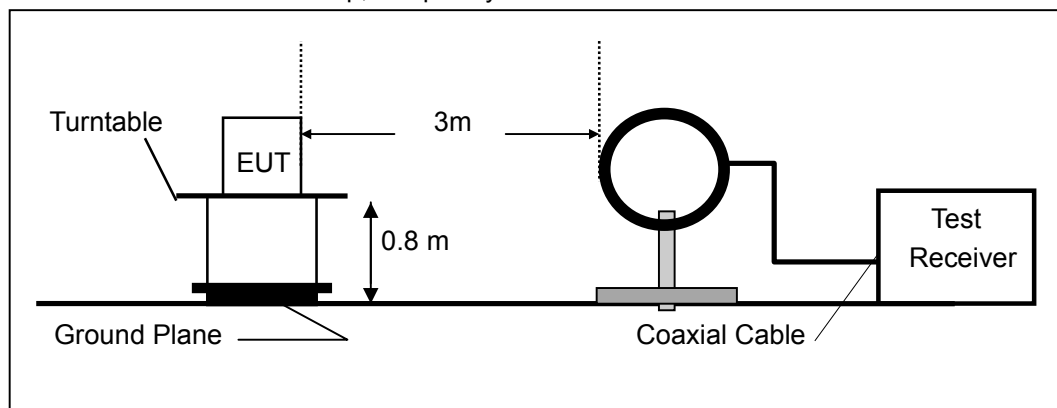

(b) Radiated Emission Test Set-Up, Frequency Below 1000MHz

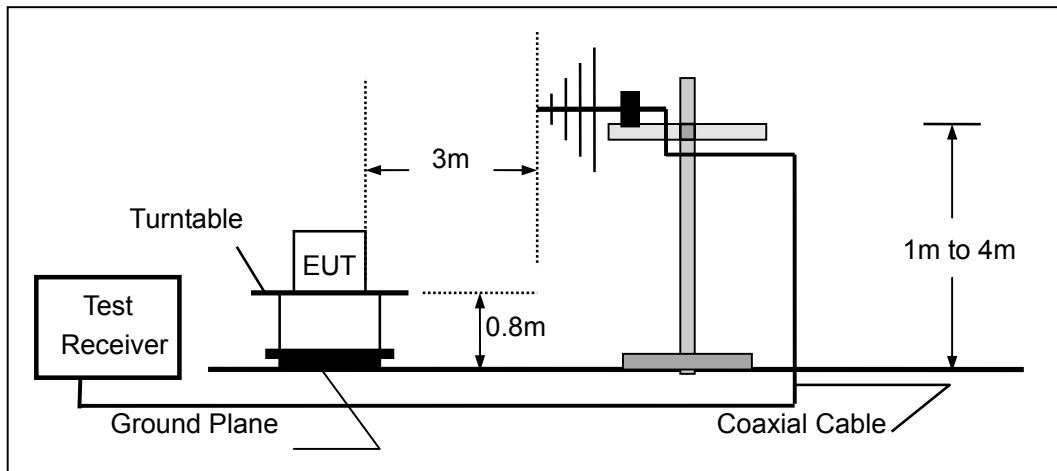

(c) Radiated Emission Test Set-Up, Frequency above 1000MHz

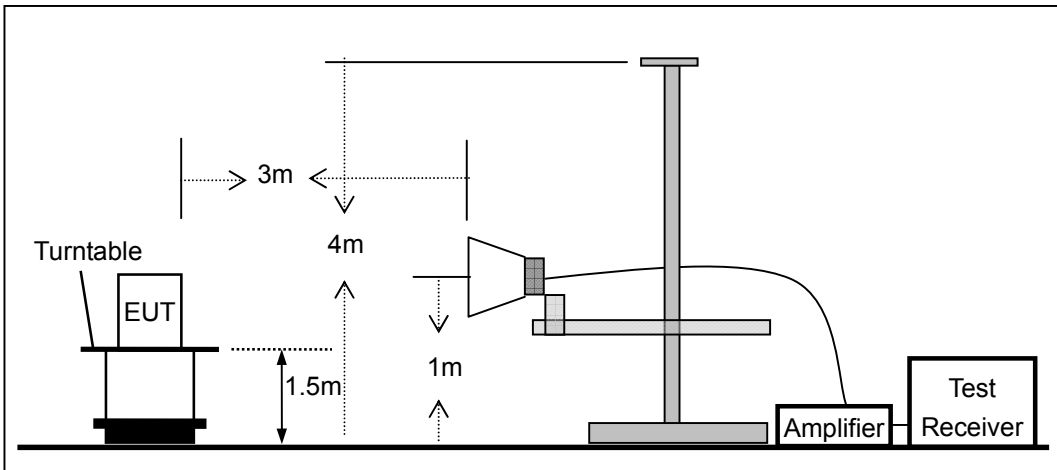

7.3 CONDUCTED EMISSION TEST SETUP

The mains cable of the EUT (Perfect Share Mini) must be connected to LISN. The LISN shall be placed 0.8 m from the boundary of EUT and bonded to a ground reference plane for LISN mounted on top of the ground reference plane. This distance is between the closest points of the LISN and the EUT. All other units of the EUT and associated equipment shall be at least 0.8m from the LISN.

Ground connections, where required for safety purposes, shall be connected to the reference ground point of the LISN and, where not otherwise provided or specified by the manufacturer, shall be of same length as the mains cable and run parallel to the mains connection at a separation distance of not more than 0.8 m.

According to the requirements in Section 13.1.4.1 of ANSI C63.10-2013 Conducted emissions from the EUT measured in the frequency range between 0.15 MHz and 30 MHz using CISPR Quasi-Peak and average detector mode.

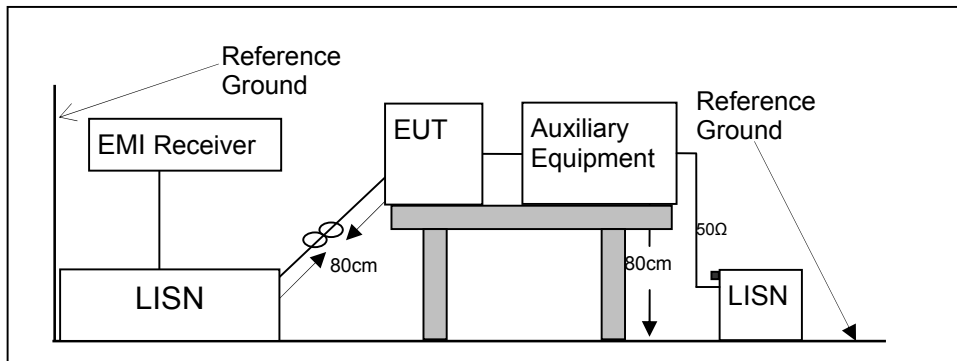

7.4 BLOCK DIAGRAM CONFIGURATION OF TEST SYSTEM

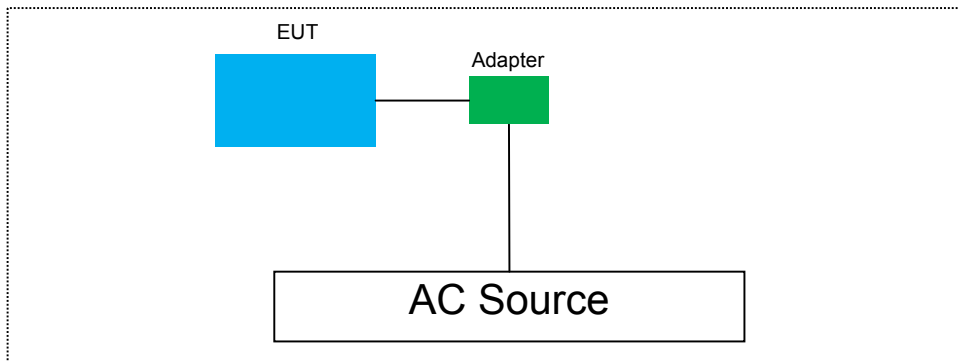

7.5 SUPPORT EQUIPMENT

Item	Equipment	Mfr/Brand	Model/Type No.	FCC ID	Note

Notes:

1. All the equipment/cables were placed in the worst-case configuration to maximize the emission during the test.
2. Grounding was established in accordance with the manufacturer's requirements and conditions for the intended use.

8 TEST REQUIREMENTS

8.1 20DB BANDWIDTH

8.1.1 Applicable Standard

According to FCC Part 15.247(a)(1) and DA 00-705

8.1.2 Conformance Limit

No limit requirement.

8.1.3 Test Configuration

Test according to clause 7.1 radio frequency test setup 1

8.1.4 Test Procedure

The RF output of EUT was connected to the spectrum analyzer by RF cable and attenuator. The path loss was compensated to the results for each measurement.

Set to the maximum power setting and enable the EUT transmit continuously

Set RBW = 1% of the 20 dB bandwidth.

Set the video bandwidth (VBW) ≥ RBW

Set Span= approximately 2 to 3 times the 20 dB bandwidth

Set Detector = Peak.

Set Trace mode = max hold.

Set Sweep = auto couple.

The EUT should be transmitting at its maximum data rate. Allow the trace to stabilize. Use the marker-to-peak function to set the marker to the peak of the emission. Use the marker-delta function to measure 20 dB down one side of the emission. Reset the markerdelta function, and move the marker to the other side of the emission, until it is (as close as possible to) even with the reference marker level. The marker-delta reading at this point is the 20 dB bandwidth of the emission.

If this value varies with different modes of operation (e.g., data rate, modulation format, etc.), repeat this test for each variation.

Measure and record the results in the test report.

Test Results

Temperature:	24 °C	Test Date:	Septemper 01, 2016
Humidity:	53 %	Test By:	King Kong

Modulation Mode	Channel Number	Channel Frequency (MHz)	Measurement Bandwidth (MHz)	Limit (kHz)	Verdict
GFSK	00	2409.0	3.318	N/A	PASS
	08	2437.2	3.393	N/A	PASS
	17	2469.8	3.233	N/A	PASS

Note: N/A (Not Applicable)

Test Model 20dB Bandwidth
Channel 0: 2409.0MHz GFSK Modulation

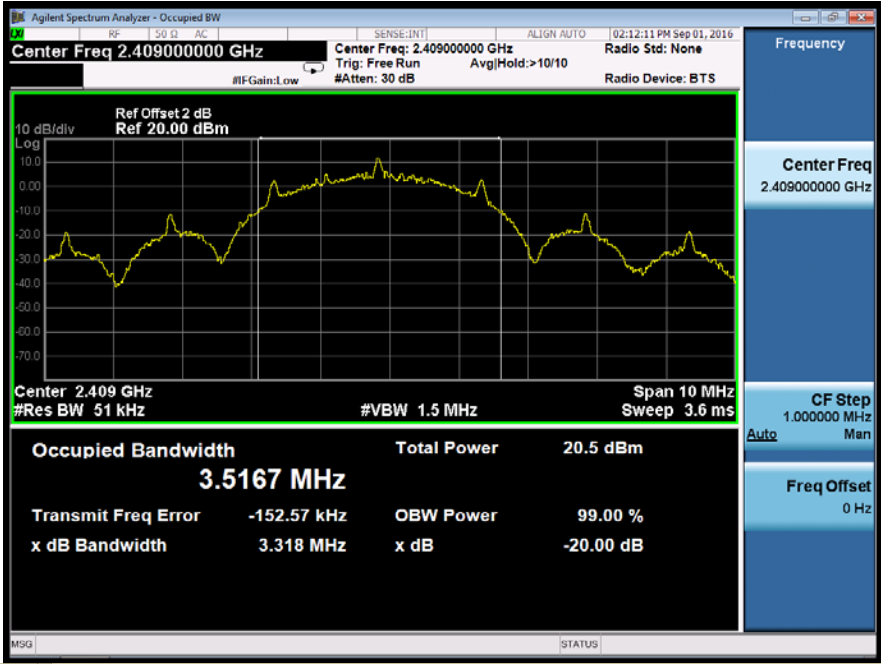

Test Model 20dB Bandwidth
Channel 08: 2437.2MHz GFSK Modulation

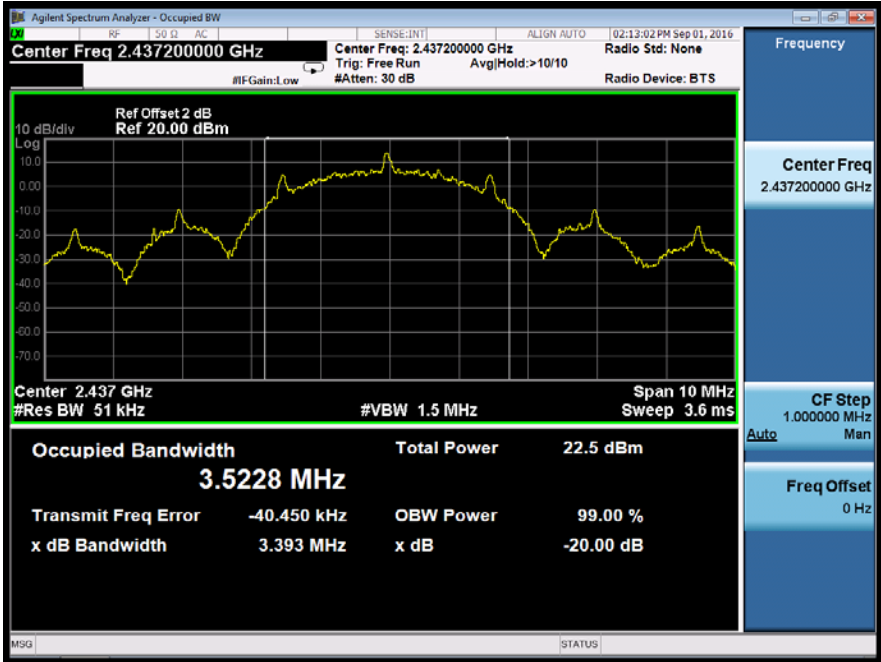

Test Model	20dB Bandwidth Channel 17: 2469.8MHz	GFSK Modulation
------------	---	-----------------

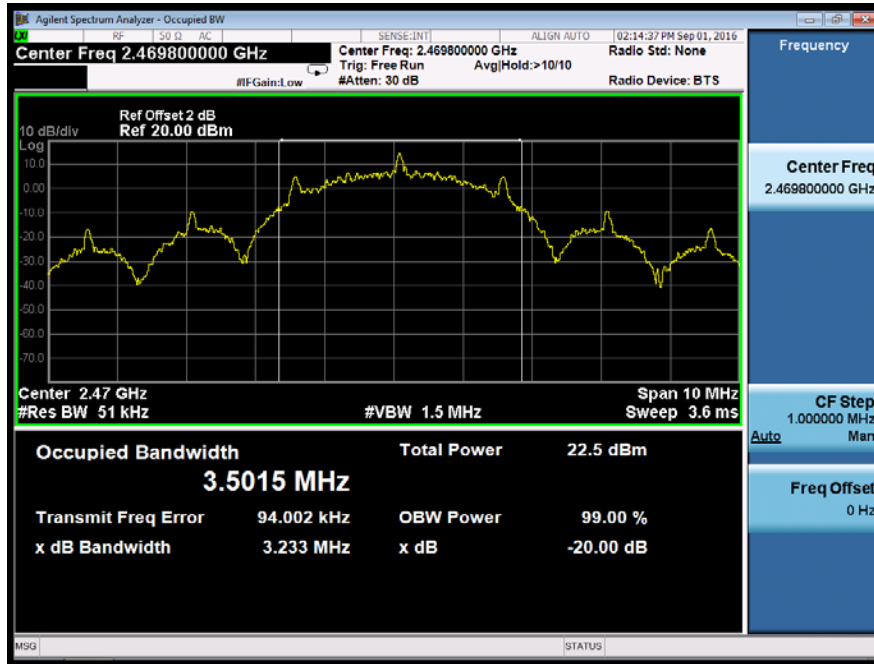

8.2 CARRIER FREQUENCY SEPARATION

8.2.1 Applicable Standard

According to FCC Part 15.247(a)(1) and DA 00-705

8.2.2 Conformance Limit

Frequency hopping systems operating in the 2400-2483.5MHz band shall have hopping channel carrier frequencies separated by a minimum of 25kHz or the 20dB bandwidth of the hopping channel, whichever is greater.

In case of an output power less than 125mW, the frequency hopping system may have channels separated by a minimum of 25kHz or two-thirds of the 20dB bandwidth of the hopping channel, whichever is greater.

8.2.3 Test Configuration

Test according to clause 7.1 radio frequency test setup 1

8.2.4 Test Procedure

- According to FCC Part 15.247(a)(1)
The EUT must have its hopping function enabled. Use the following spectrum analyzer settings:
Set the RBW = 1% of the span.
Set VBW ≥ RBW.
Set the span = wide enough to capture the peaks of two adjacent channels
Set Sweep time = auto couple.
Set Detector = peak. Set Trace mode = max hold.
Allow the trace to stabilize. Use the marker-delta function to determine the separation between the peaks of the adjacent channels. The limit is specified in one of the subparagraphs of this Section. Submit this plot.

Test Results

Temperature:	24 °C	Test Date:	Septemper 02, 2016
Humidity:	53 %	Test By:	King Kong

Modulation Mode	Channel Number	Channel Frequency (MHz)	Seperation Bandwidth (MHz)	Limit (MHz)	Verdict
GFSK	00	2409.0	3.37	>2.212	PASS
	08	2437.2	3.38	>2.262	PASS
	17	2469.8	3.37	>2.155	PASS

Note:
Limit = 20dB bandwidth * 2/3, if it is greater than 25kHz and the output power is less than 125mW (21dBm).

Test Model Carrier Frequency Separation
Channel 0: 2409.0MHz GFSK Modulation

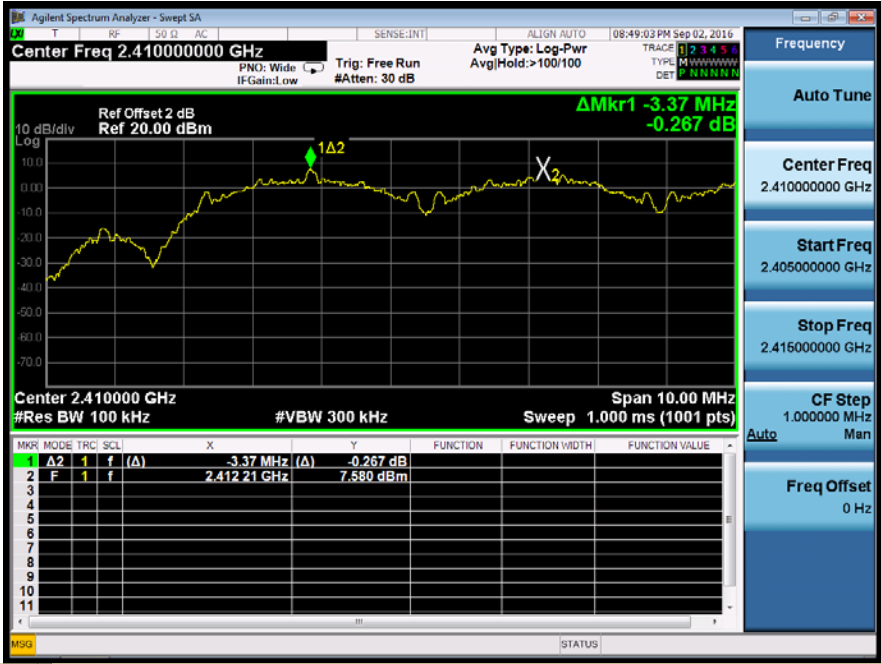

Test Model Carrier Frequency Separation
Channel 08: 2437.2MHz GFSK Modulation

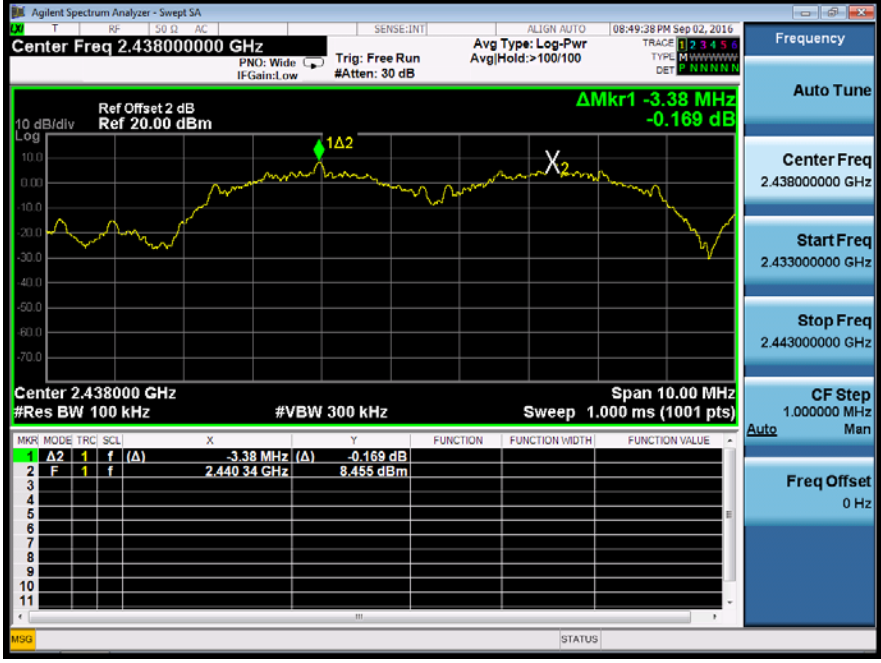

Test Model Carrier Frequency Separation
Channel 17: 2469.8MHz GFSK Modulation



8.3 NUMBER OF HOPPING FREQUENCIES

8.3.1 Applicable Standard

According to FCC Part 15.247(a)(1) (iii) and DA 00-705

8.3.2 Conformance Limit

Frequency hopping systems operating in the 2400-2483.5MHz band shall use at least 15 channels.

8.3.3 Test Configuration

Test according to clause 7.1 radio frequency test setup 1

8.3.4 Test Procedure

- According to FCC Part 15.247(a)(1)(iii)

The EUT must have its hopping function enabled. Use the following spectrum analyzer settings:

Span = the frequency band of operation (2390-2440MHz) and (2440-2490MHz)

RBW \geq 1% of the span

VBW \geq RBW

Sweep = auto

Detector function = peak

Trace = max hold

Allow the trace to stabilize. It may prove necessary to break the span up to sections, in order to clearly show all of the hopping frequencies.

Test Results

Temperature:	24 °C	Test Date:	August 23, 2016
Humidity:	53 %	Test By:	King Kong

Hopping Channel Frequency Range	Quantity of Hopping Channel	Quantity of Hopping Channel limit
2409.0-2469.8	18	> 15

Test Model | Number Of Hopping Frequencies

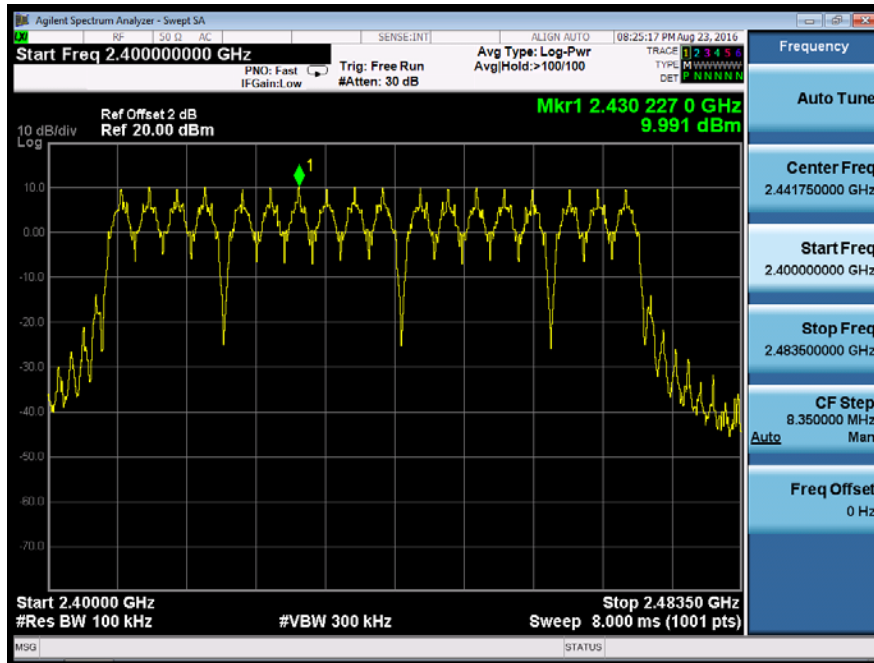

8.4 AVERAGE TIME OF OCCUPANCY (DWELL TIME)

8.4.1 Applicable Standard

According to FCC Part 15.247(a)(1)(iii) and DA 00-705

8.4.2 Conformance Limit

For frequency hopping systems operating in the 2400-2483.5MHz band, the average time of occupancy on any channel shall not be greater than 0.4s within a period of 0.4s multiplied by the number of hopping channels employed.

8.4.3 Test Configuration

Test according to clause 7.1 radio frequency test setup 1

8.4.4 Test Procedure

- According to FCC Part 15.247(a)(1)(iii)
The EUT must have its hopping function enabled. Use the following spectrum analyzer settings:
Span = zero span, centered on a hopping channel
RBW = 1 MHz
VBW ≥ RBW
Sweep = as necessary to capture the entire dwell time per hopping channel
Detector function = peak
Trace = max hold
If possible, use the marker-delta function to determine the dwell time. If this value varies with different modes of operation (e.g., data rate, modulation format, etc.), repeat this test for each variation. The limit is specified in one of the subparagraphs of this Section.

8.4.5 Test Result

Temperature:	24 °C	Humidity:	53 %
Test By:	King Kong		

Note: The Low, Mid, High Channel had been test , only the worst case was reprinted for this report.

Modulation Mode	Channel Number	Pulse width (ms)	Pulse Number Within 1s	Dwell Time (ms)	Limit (ms)	Verdict
GFSK	00	1.45	29	303	<400	PASS
Note: Dwell Time(ms)=0.4*18*1.45*29						

Test Model	Average Time Of Occupancy (Dwell Time) CH 0: 2409.0MHz	GFSK
------------	---	------

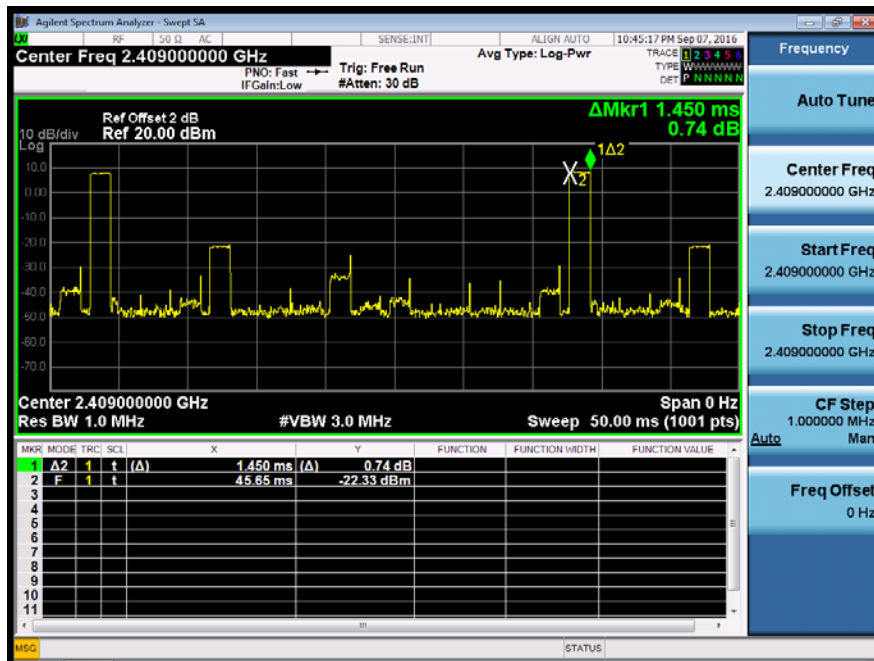
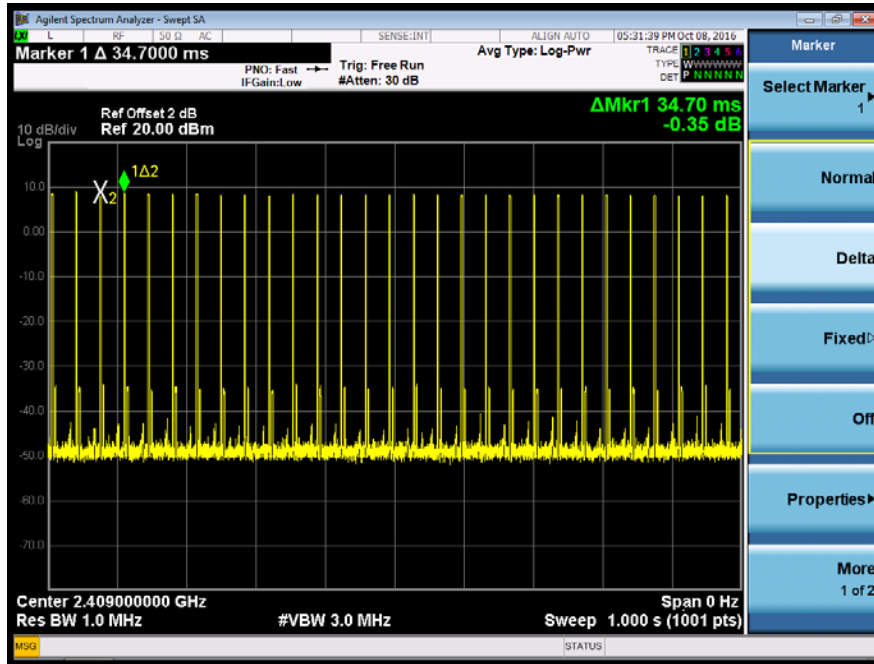

8.5 MAXIMUM PEAK CONDUCTED OUTPUT POWER

8.5.1 Applicable Standard

According to FCC Part 15.247(b)(1) and DA 00-705

8.5.2 Conformance Limit

The max For frequency hopping systems operating in the 2400-2483.5 MHz band employing at least 75 non-overlapping hopping channels: 1 watt. For all other frequency hopping systems in the 2400-2483.5 MHz band: 0.125 watts.

8.5.3 Test Configuration

Test according to clause 7.1 radio frequency test setup 1

8.5.4 Test Procedure

- According to FCC Part15.247(b)(1)

As an alternative to a peak power measurement, compliance with the limit can be based on a measurement of the maximum conducted output power.

Use the following spectrum analyzer settings:

Set Span = approximately 5 times the 20 dB bandwidth, centered on a hopping channel (about 10MHz)

Set RBW > the 20 dB bandwidth of the emission being measured

Set VBW ≥ RBW

Set Sweep = auto

Set Detector function = peak

Set Trace = max hold

Allow the trace to stabilize. Use the marker-to-peak function to set the marker to the peak of the emission to determine the peak amplitude level.

Test Results

Temperature:	24 °C	Test Date:	Septemper 01, 2016
Humidity:	53 %	Test By:	King Kong

Operation Mode	Channel Number	Channel Frequency (MHz)	Conducted Peak Power (dBm)	Limit (dBm)	Verdict
GFSK	00	2409.0	14.205	21	PASS
	08	2437.2	15.792	21	PASS
	17	2469.8	15.516	21	PASS
Note: N/A					

Test Model	Maximum Peak Conducted Output Power Channel 0: 2409.0MHz	GFSK
------------	---	------

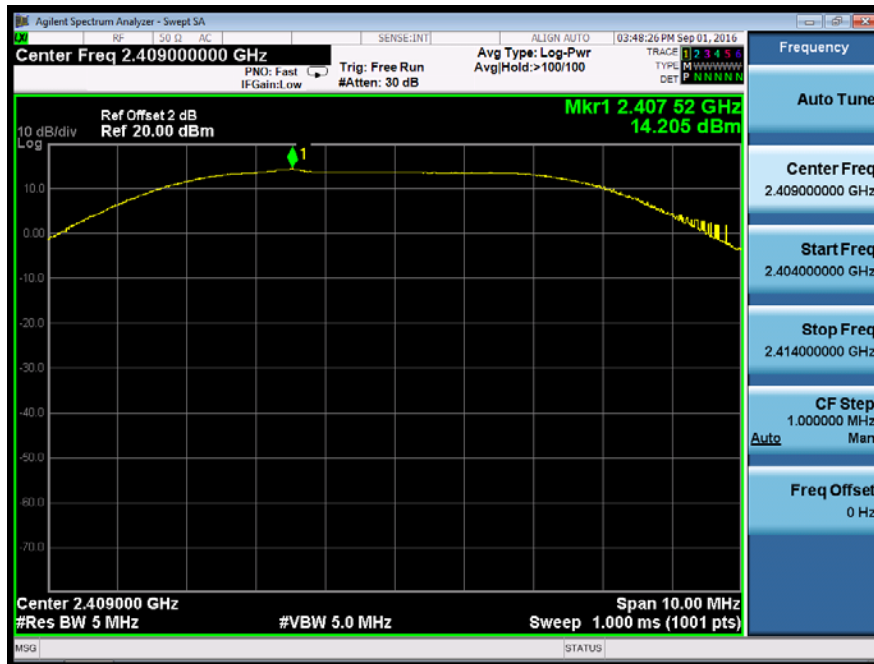

Test Model	Maximum Peak Conducted Output Power Channel 08: 2437.2MHz	GFSK
------------	--	------

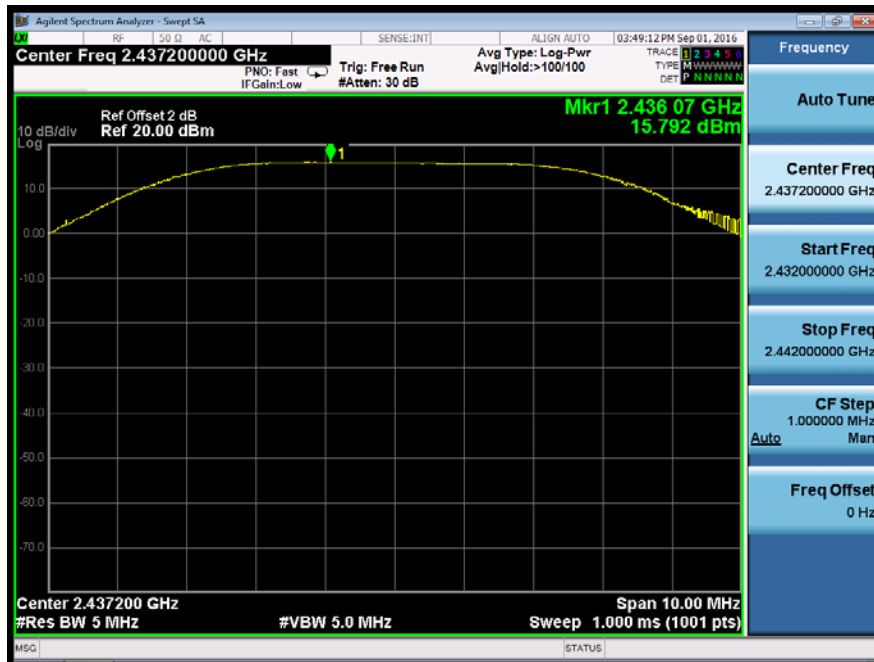

Test Model	Maximum Peak Conducted Output Power Channel 17: 2469.8MHz	GFSK
------------	--	------

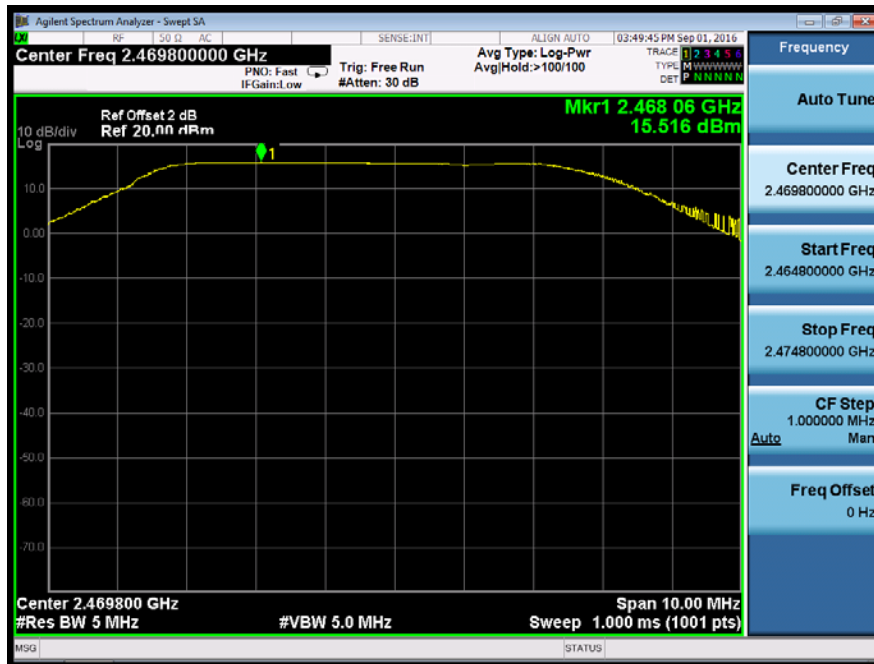

8.6 CONDUCTED SUPRIIOUS EMISSION

8.6.1 Applicable Standard

According to FCC Part 15.247(d) and DA 00-705

8.6.2 Conformance Limit

According to FCC Part 15.247(d):

In any 100 kHz bandwidth outside the frequency band in which the spread spectrum intentional radiator is operating, the radio frequency power that is produced by the intentional radiator shall be at least 20 dB below that in the 100 kHz bandwidth within the band that contains the highest level of the desired power, based on either an RF conducted, provided the transmitter demonstrates compliance with the peak conducted power limits.

8.6.3 Test Configuration

Test according to clause 7.1 radio frequency test setup 1

8.6.4 Test Procedure

The transmitter output (antenna port) was connected to the spectrum analyzer

■ Reference level measurement

Establish a reference level by using the following procedure:

Set instrument center frequency to DSS channel center frequency.

Set Span = approximately 5 times the 20 dB bandwidth, centered on a hopping channel.

Set the RBW = 100 kHz. Set the VBW $\geq 3 \times$ RBW.

Set Detector = peak. Set Sweep time = auto couple.

Set Trace mode = max hold. Allow trace to fully stabilize.

Use the peak marker function to determine the maximum Maximum conduceted level.

Note that the channel found to contain the maximum conduceted level can be used to establish the reference level.

■ Band-edge Compliance of RF Conducted Emissions

Use the following spectrum analyzer settings:

Span = wide enough to capture the peak level of the emission operating on the channel closest to the band-edge, as well as any modulation products which fall outside of the authorized band of operation

Set RBW $\geq 1\%$ of the span=100kHz Set VBW \geq RBW

Set Sweep = auto Set Detector function = peak Set Trace = max hold

Allow the trace to stabilize. Set the marker on the emission at the bandedge, or on the highest modulation product outside of the band, if this level is greater than that at the bandedge. Enable the marker-delta

function, then use the marker-to-peak function to move the marker to the peak of the in-band emission.

The marker-delta value now displayed must comply with the limit specified in this Section.

Now, using the same instrument settings, enable the hopping function of the EUT. Allow the trace to stabilize. Follow the same procedure listed above to determine if any spurious emissions caused by the hopping function also comply with the specified limit.

■ Conduceted Spurious RF Conducted Emission

Use the following spectrum analyzer settings:

Span = wide enough to capture the peak level of the in-band emission and all spurious emissions (e.g., harmonics) from the lowest frequency generated in the EUT up through the 10th harmonic.(30MHz to 25GHz). Set RBW = 100 kHz Set VBW \geq RBW

Set Sweep = auto Set Detector function = peak Set Trace = max hold

Set Sweep = auto Set Detector function = peak Set Trace = max hold

Allow the trace to stabilize. Set the marker on the peak of any spurious emission recorded. The level displayed must comply with the limit specified in this Section.

8.6.5 Test Results

Test Model	Maximum Conducted Level RBW=100kHz Channel 0: 2409.0MHz	GFSK
------------	--	------



Test Model	Maximum Conducted Level RBW=100kHz Channel 0: 2409.0MHz	GFSK
------------	--	------



Test Model Band-edge Conducted Emissions
Channel 0: 2409.0MHz GFSK

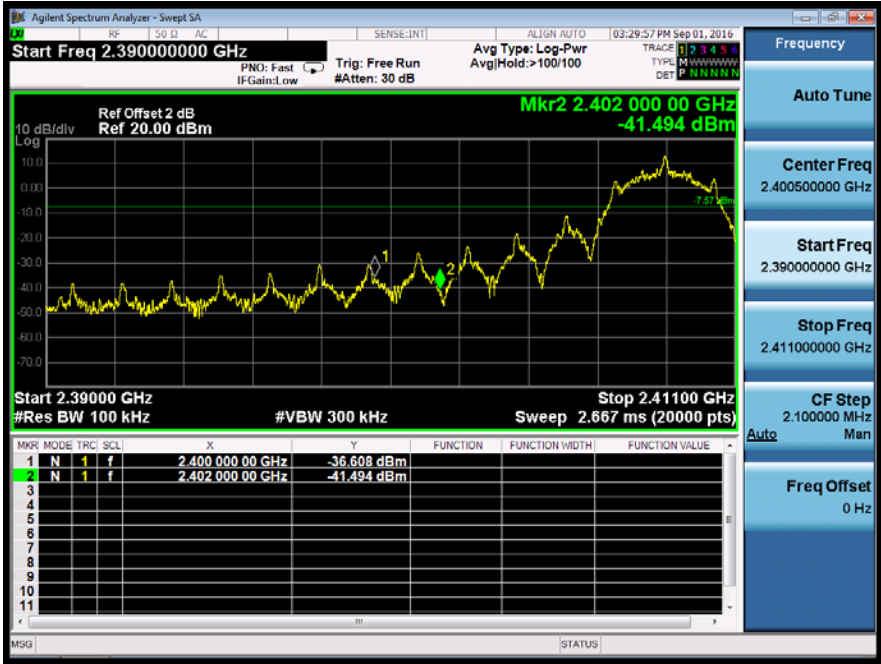

Test Model Maximum Conducted Level RBW=100kHz
Channel 08: 2437.2MHz GFSK



Test Model	Conduceted Spurious RF Conducted Emission Channel 08: 2437.2MHz	GFSK
------------	--	------

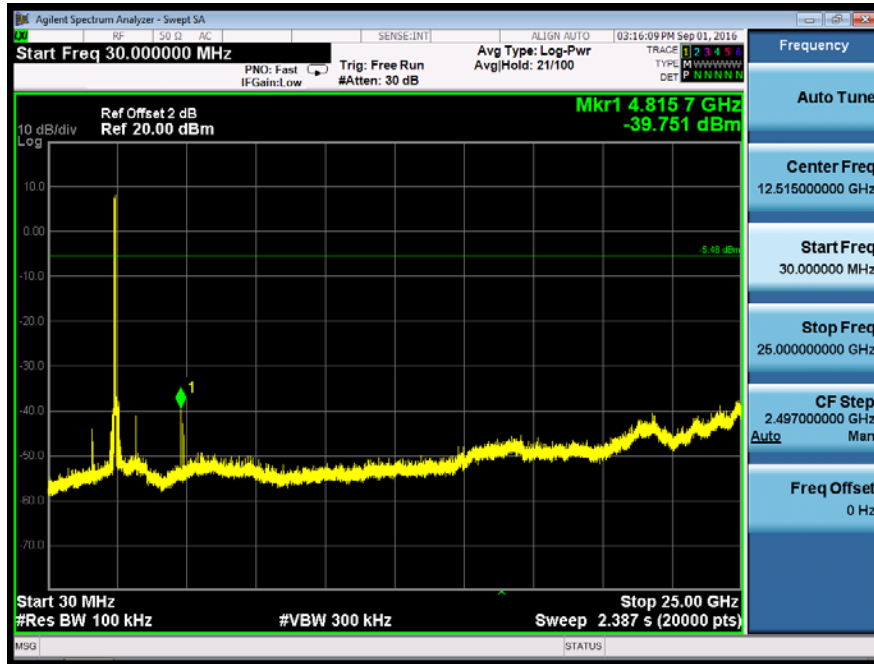

Test Model	Maximum Conduceted Level RBW=100kHz Channel 17: 2469.8MHz	GFSK
------------	--	------



Test Model Conduced Spurious RF Conducted Emission Emission
Channel 17: 2469.8MHz GFSK

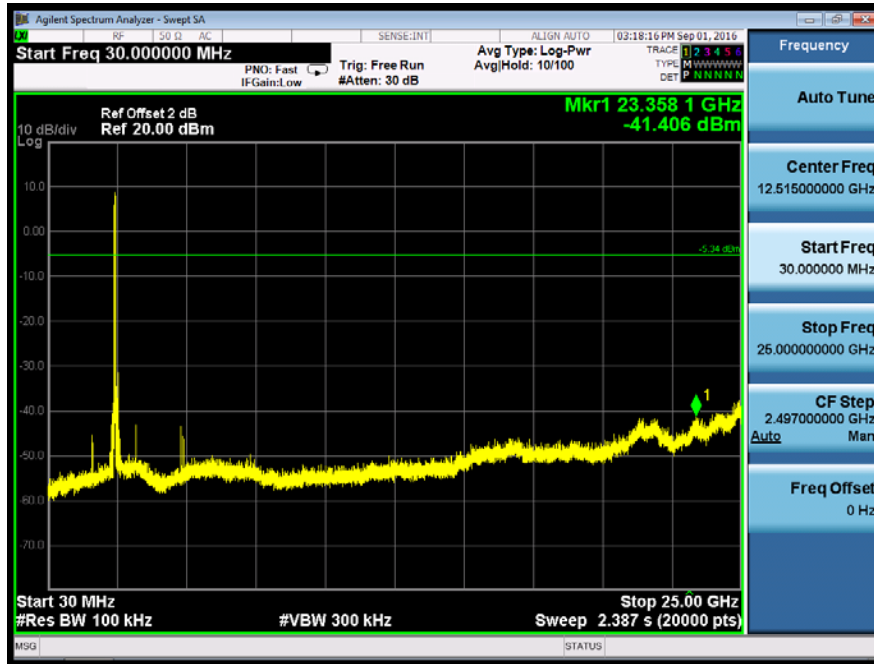

Test Model Band-edge Conducted Emissions GFSK
Channel 17: 2469.8MHz

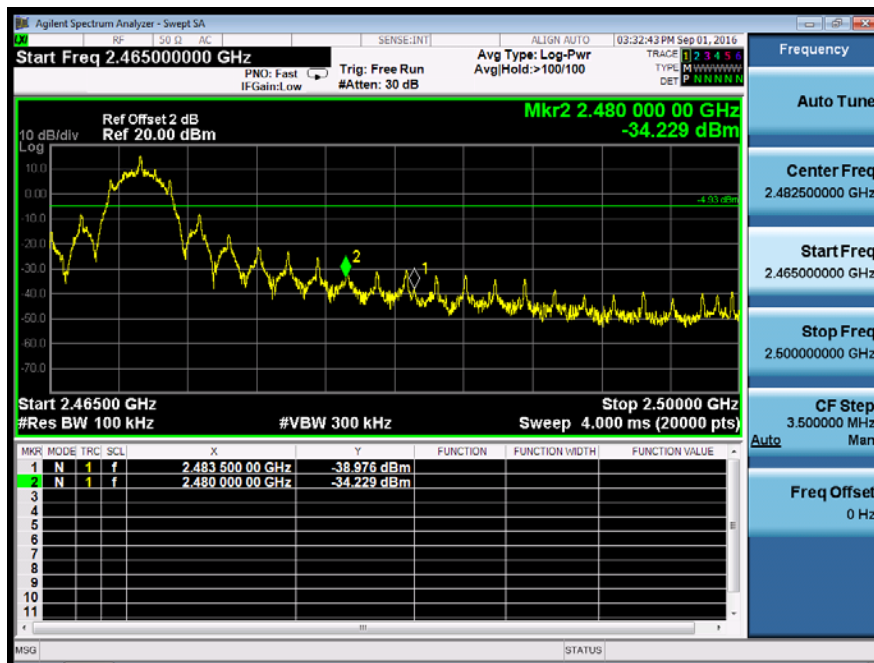

Test Model Maximum Conducted Level RBW=100kHz
Hopping GFSK

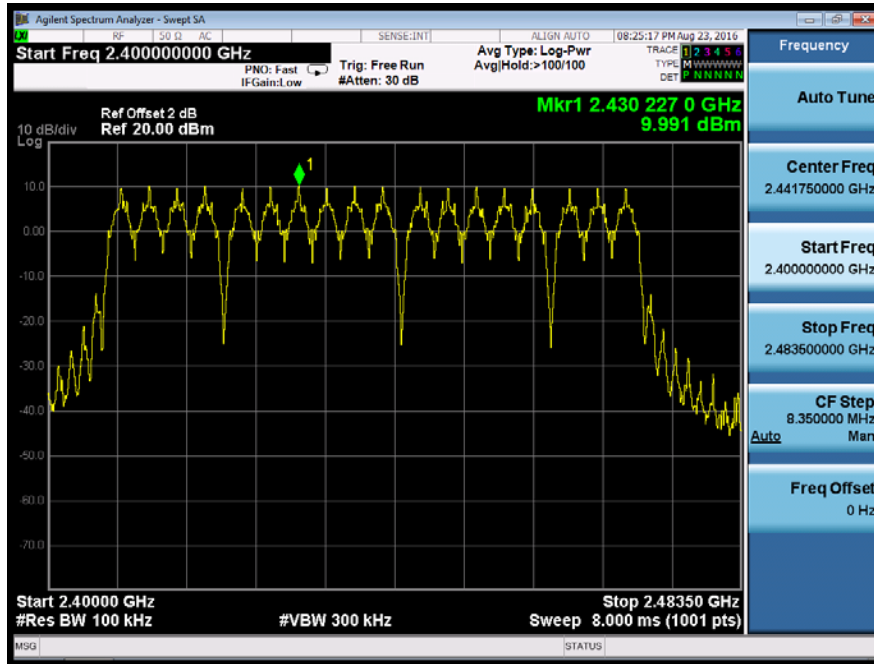

Test Model Conducted Spurious RF Conducted Emission Hopping
GFSK



Test Model Band-edge Conducted Emissions Hopping GFSK

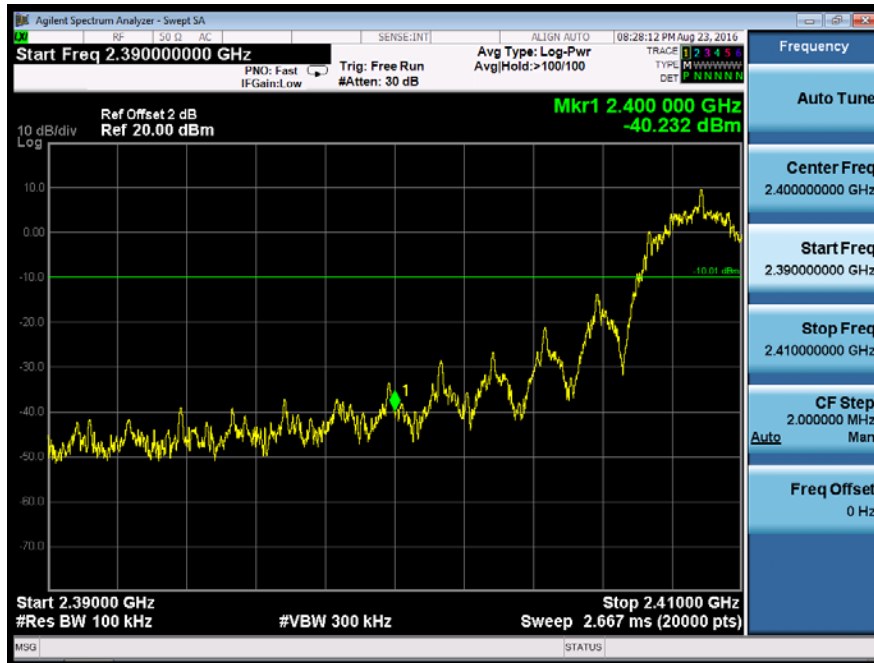

Test Model Band-edge Conducted Emissions Hopping GFSK

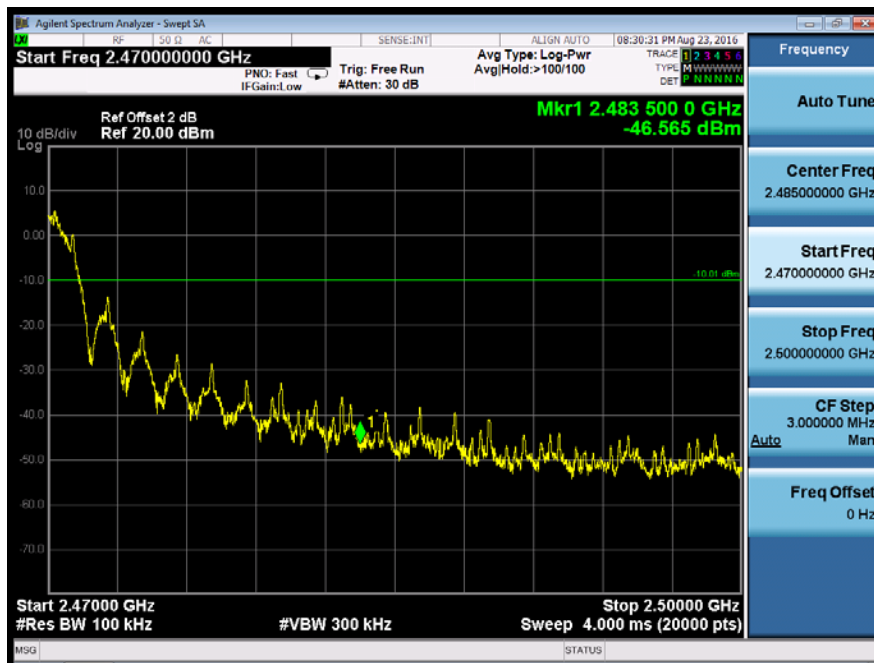

8.7 RADIATED SPURIOUS EMISSION

8.7.1 Applicable Standard

According to FCC Part 15.247(d) and 15.209 and DA 00-705

8.7.2 Conformance Limit

According to FCC Part 15.247(d): radiated emissions which fall in the restricted bands, as defined in §15.205(a), must also comply with the radiated emission limits specified in §15.209(a) (see §15.205(c)).
According to FCC Part 15.205, Restricted bands

MHz	MHz	MHz	GHz
0.090-0.110	16.42-16.423	399.9-410	4.5-5.15
10.495-0.505	16.69475-16.69525	608-614	5.35-5.46
2.1735-2.1905	16.80425-16.80475	960-1240	7.25-7.75
4.125-4.128	25.5-25.67	1300-1427	8.025-8.5
4.17725-4.17775	37.5-38.25	1435-1626.5	9.0-9.2
4.20725-4.20775	73-74.6	1645.5-1646.5	9.3-9.5
6.215-6.218	74.8-75.2	1660-1710	10.6-12.7
6.26775-6.26825	123-138	2200-2300	14.47-14.5
8.291-8.294	149.9-150.05	2310-2390	15.35-16.2
8.362-8.366	156.52475-156.52525	2483.5-2500	17.7-21.4
8.37625-8.38675	156.7-156.9	2690-2900	22.01-23.12
8.41425-8.41475	162.0125-167.17	3260-3267	23.6-24.0
12.29-12.293	167.72-173.2	3332-3339	31.2-31.8
12.51975-12.52025	240-285	3345.8-3358	36.43-36.5
12.57675-12.57725	322-335.4	3600-4400	(2)
13.36-13.41			

According to FCC Part 15.205, the level of any transmitter spurious emission in Restricted bands shall not exceed the level of the emission specified in the following table

Restricted Frequency(MHz)	Field Strength (µV/m)	Field Strength (dBµV/m)	Measurement Distance
0.009-0.490	2400/F(KHz)	20 log (uV/m)	300
0.490-1.705	24000/F(KHz)	20 log (uV/m)	30
1.705-30	30	29.5	30
30-88	100	40	3
88-216	150	43.5	3
216-960	200	46	3
Above 960	500	54	3

8.7.3 Test Configuration

Test according to clause 7.2 radio frequency test setup 2

8.7.4 Test Procedure

This test is required for any spurious emission that falls in a Restricted Band, as defined in Section 15.205. It must be performed with the highest gain of each type of antenna proposed for use with the EUT. Use the following spectrum analyzer settings:

For Above 1GHz:

The EUT was placed on a turn table which is 1.5m above ground plane.

Maximum procedure was performed on the highest emissions to ensure EUT compliance.

Span = wide enough to fully capture the emission being measured

RBW = 1 MHz

VBW ≥ RBW

Sweep = auto

Detector function = peak

Trace = max hold

For Below 1GHz:

The EUT was placed on a turn table which is 0.8m above ground plane.

Maximum procedure was performed on the highest emissions to ensure EUT compliance.

Span = wide enough to fully capture the emission being measured

RBW = 100 kHz for

VBW ≥ RBW

Sweep = auto

Detector function = peak

Trace = max hold

For Below 30MHz:

The EUT was placed on a turn table which is 0.8m above ground plane.

Maximum procedure was performed on the highest emissions to ensure EUT compliance.

Span = wide enough to fully capture the emission being measured

RBW = 9kHz

VBW ≥ RBW

Sweep = auto

Detector function = peak

Trace = max hold

For Below 150KHz:

The EUT was placed on a turn table which is 0.8m above ground plane.

Maximum procedure was performed on the highest emissions to ensure EUT compliance.

Span = wide enough to fully capture the emission being measured

RBW = 200Hz

VBW ≥ RBW

Sweep = auto

Detector function = peak

Trace = max hold

Follow the guidelines in ANSI C63.10-2013 with respect to maximizing the emission by rotating the EUT, measuring the emission while the EUT is situated in three orthogonal planes (if appropriate), adjusting the measurement antenna height and polarization, etc. A pre-amp and a high pass filter are required for this test, in order to provide the measuring system with sufficient sensitivity. Allow the trace to stabilize. The peak reading of the emission, after being corrected by the antenna factor, cable loss, pre-amp gain, etc., is the peak field strength, which must comply with the limit specified in Section 15.35(b). Submit this data.

Now set the VBW to 10 Hz, while maintaining all of the other instrument settings. This peak level, once corrected, must comply with the limit specified in Section 15.209. If the dwell time per channel of the hopping signal is less than 100 ms, then the reading obtained with the 10 Hz VBW may be further adjusted by a "duty cycle correction factor", derived from $20\log(\text{dwell time}/100 \text{ ms})$, in an effort to demonstrate compliance with the 15.209 limit. Submit this data.

Repeat above procedures until all frequency measured was complete.

Note: The EUT was pretested with 3 orientations placed on the table for the radiated emission measurement -X, Y, and Z-plane. The Y-plane results were found as the worst case and were shown in this report.

8.7.5 Test Results

■ Spurious Emission below 30MHz (9KHz to 30MHz)

Temperature:	24 °C	Test Date:	August 16, 2016
Humidity:	53 %	Test By:	KK
Test mode:	TX Mode		

Freq. (MHz)	Ant. Pol. H/V	Emission Level(dBuV/m)		Limit 3m(dBuV/m)		Over(dB)	
		PK	AV	PK	AV	PK	AV
--	--	--	--	--	--	--	--

Note: the amplitude of spurious emission that is attenuated by more than 20dB below the permissible limit has no need to be reported.

Distance extrapolation factor = $40\log(\text{Specific distance}/ \text{test distance})$ (dB);

Limit line = Specific limits(dBuV) + distance extrapolation factor

■ Spurious Emission Above 1GHz (1GHz to 25GHz)

Temperature:	24 °C	Test Date:	August 31, 2016
Humidity:	53 %	Test By:	King Kong
Test mode:	GFSK	Frequency:	Channel 0: 2409.0MHz

Freq. (MHz)	Ant.Pol. H/V	Emission Level(dBuV/m)		Limit 3m(dBuV/m)		Over(dB)	
		PK	AV	PK	AV	PK	AV
4818.67	V	62.98	41.64	74.00	54.00	-11.02	-12.36
7228.07	V	64.21	41.2	74.00	54.00	-9.79	-12.80
9637.08	V	51.24	34.87	74.00	54.00	-22.76	-19.13
--	--	--	--	--	--	--	--
--	--	--	--	--	--	--	--
4818.96	H	55.57	36.8	74.00	54.00	-18.43	-17.20
7228.80	H	64.33	42.8	74.00	54.00	-9.67	-11.20
9636.52	H	50.69	35.26	74.00	54.00	-23.31	-18.74

Temperature:	24 °C	Test Date:	August 31, 2016
Humidity:	53 %	Test By:	King Kong
Test mode:	GFSK	Frequency:	Channel 08: 2437.2MHz

Freq. (MHz)	Ant.Pol. I. H/V	Emission Level(dBuV/m)		Limit 3m(dBuV/m)		Over(dB)	
		PK	AV	PK	AV	PK	AV
4875.34	V	62.81	41.38	74.00	54.00	-11.19	-12.62
7312.33	V	65.14	40.43	74.00	54.00	-8.86	-13.57
9748.98	V	51.12	34.56	74.00	54.00	-22.88	-19.44
--	--	--	--	--	--	--	--
--	--	--	--	--	--	--	--
4875.30	H	55.59	36.25	74.00	54.00	-18.41	-17.75
7311.50	H	63.73	43.4	74.00	54.00	-10.27	-10.60
9748.70	H	50.41	35.79	74.00	54.00	-23.59	-18.21

Temperature:	24 °C	Test Date:	August 31, 2016
Humidity:	53 %	Test By:	King Kong
Test mode:	GFSK	Frequency:	Channel 17: 2469.8MHz

Freq. (MHz)	Ant.Pol. H/V	Emission Level(dBuV/m)		Limit 3m(dBuV/m)		Over(dB)	
		PK	AV	PK	AV	PK	AV
4940.93	V	61.88	41.03	74.00	54.00	-12.12	-12.97
7409.86	V	64.57	40.51	74.00	54.00	-9.43	-13.49
9879.97	V	51.81	34.94	74.00	54.00	-22.19	-19.06
--	--	--	--	--	--	--	--
--	--	--	--	--	--	--	--
4940.69	H	55.5	36.81	74.00	54.00	-18.50	-17.19
7410.31	H	65.24	42.00	74.00	54.00	-8.76	-12.00
9879.67	H	50.12	34.96	74.00	54.00	-23.88	-19.04

- Note:**
- (1) All Readings are Peak Value (VBW=3MHz) and Peak Value (VBW=10Hz).
 - (2) Emission Level= Reading Level+Probe Factor +Cable Loss.
 - (3) Data of measurement within this frequency range shown "--" in the table above means the reading of emissions are attenuated more than 20dB below the permissible limits or the field strength is too small to be measured.

■ Spurious Emission in Restricted Band 2310-2390MHz and 2483.5-2500MHz

Temperature:	24 °C	Test Date:	August 31, 2016
Humidity:	53 %	Test By:	King Kong
Test mode:	GFSK	Frequency:	Channel 0: 2409.0MHz

Frequency (MHz)	Polarity H/V	PK(dBuV/m) (VBW=3MHz)	Limit 3m (dBuV/m)	AV(dBuV/m) (VBW=10Hz)	Limit 3m (dBuV/m)
2389.20	H	64.90	74	42.75	54
2387.76	V	66.84	74	42.51	54

Temperature:	24 °C	Test Date:	August 31, 2016
Humidity:	53 %	Test By:	King Kong
Test mode:	GFSK	Frequency:	Channel 17: 2469.8MHz

Frequency (MHz)	Polarity H/V	PK(dBuV/m) (VBW=3MHz)	Limit 3m (dBuV/m)	AV(dBuV/m) (VBW=10Hz)	Limit 3m (dBuV/m)
2485.15	H	67.99	74	43.32	54
2484.47	V	66.03	74	41.87	54

Temperature:	24 °C	Test Date:	August 31, 2016
Humidity:	53 %	Test By:	KK
Test mode:	GFSK	Frequency:	Hopping

Frequency (MHz)	Polarity H/V	PK(dBuV/m) (VBW=3MHz)	Limit 3m (dBuV/m)	AV(dBuV/m) (VBW=10Hz)	Limit 3m (dBuV/m)
2390.00	H	66.99	74	42.32	54
2388.72	V	69.47	74	44.02	54
2483.60	H	69.38	74	43.87	54
2483.62	V	67.16	74	42.33	54

- Note:** (1) All Readings are Peak Value (VBW=3MHz) and Peak Value (VBW=10Hz).
 (2) Emission Level= Reading Level+Probe Factor +Cable Loss.
 (3) Data of measurement within this frequency range shown “ -- ” in the table above means the reading of emissions are attenuated more than 20dB below the permissible limits or the field strength is too small to be measured.

Test Model	Spurious Emission in Restricted Band 2310-2390MHz	GFSK	H
	Channel 0: 2409.0MHz	Test By: King Kong	

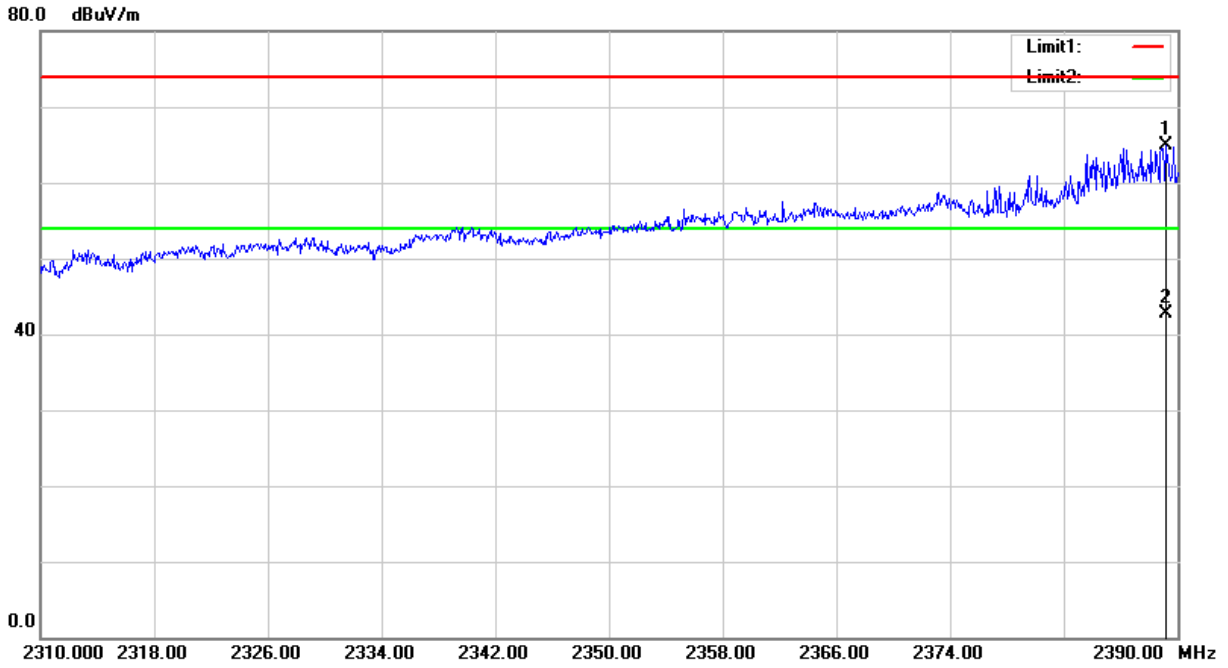

Test Model	Spurious Emission in Restricted Band 2310-2390MHz	GFSK	V
	Channel 0: 2409.0MHz	Test By: King Kong	

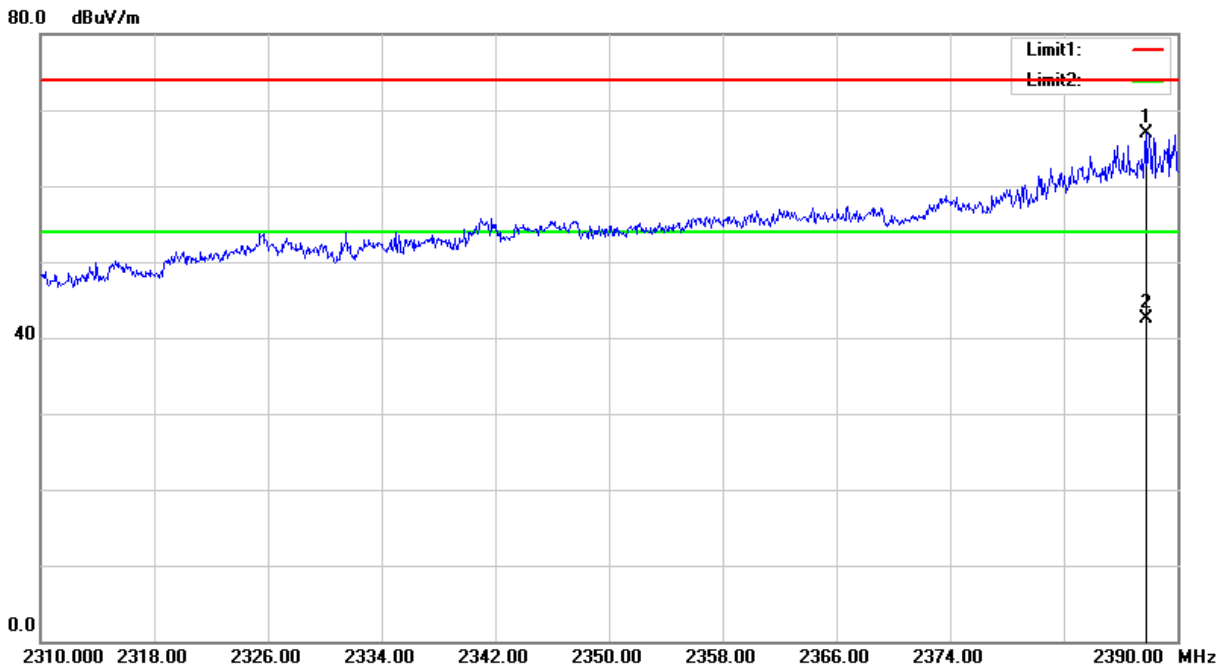

Test Model	Spurious Emission in Restricted Band 2483.5-2500MHz		
	Channel 17: 2469.8MHz	GFSK	H
		Test By: King Kong	

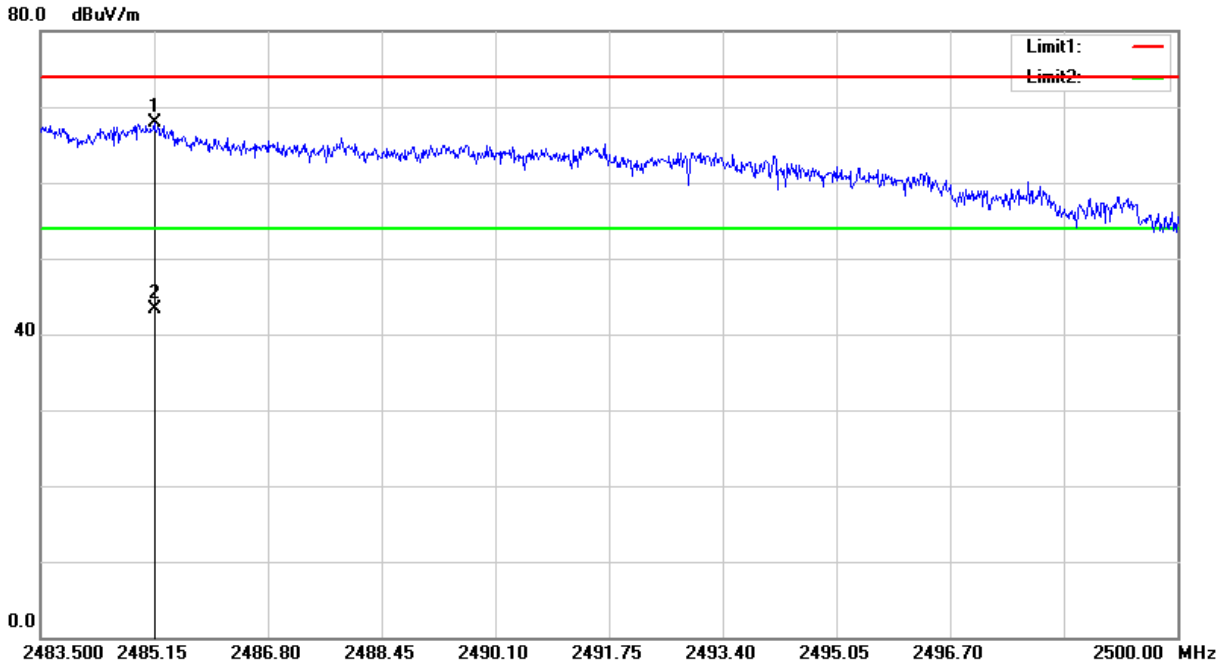

Test Model	Spurious Emission in Restricted Band 2483.5-2500MHz		
	Channel 17: 2469.8MHz	GFSK	V
		Test By: King Kong	

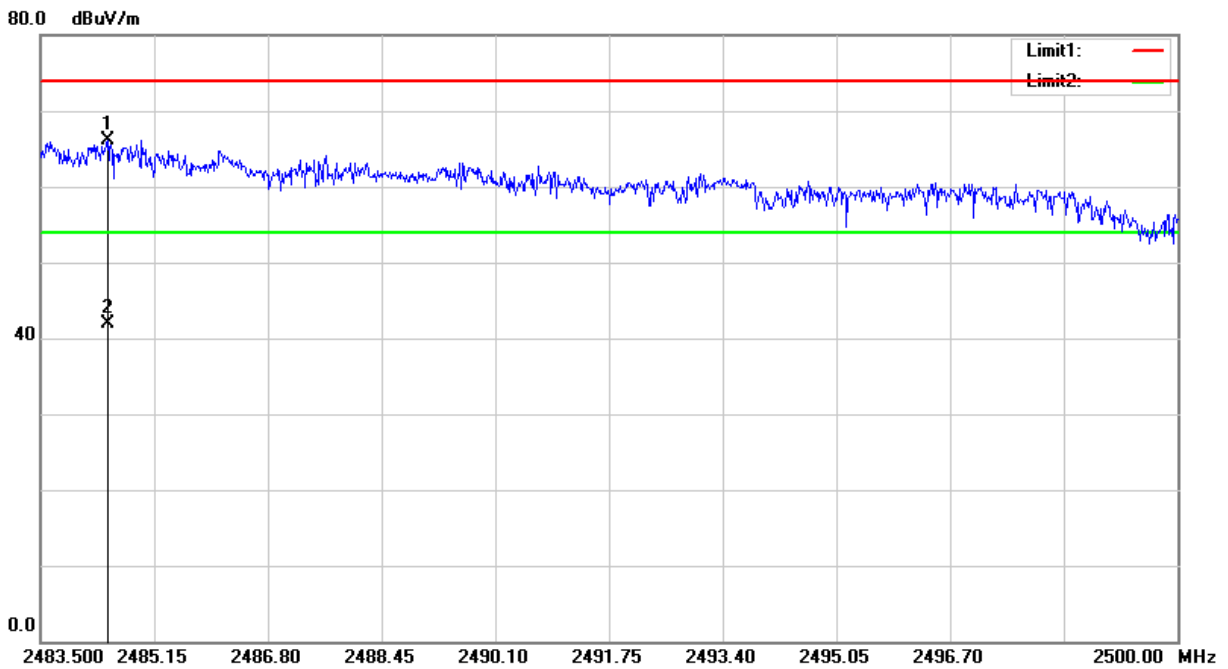

Test Model	Spurious Emission in Restricted Band 2310-2390MHz Hopping	GFSK	H
		Test By: King Kong	

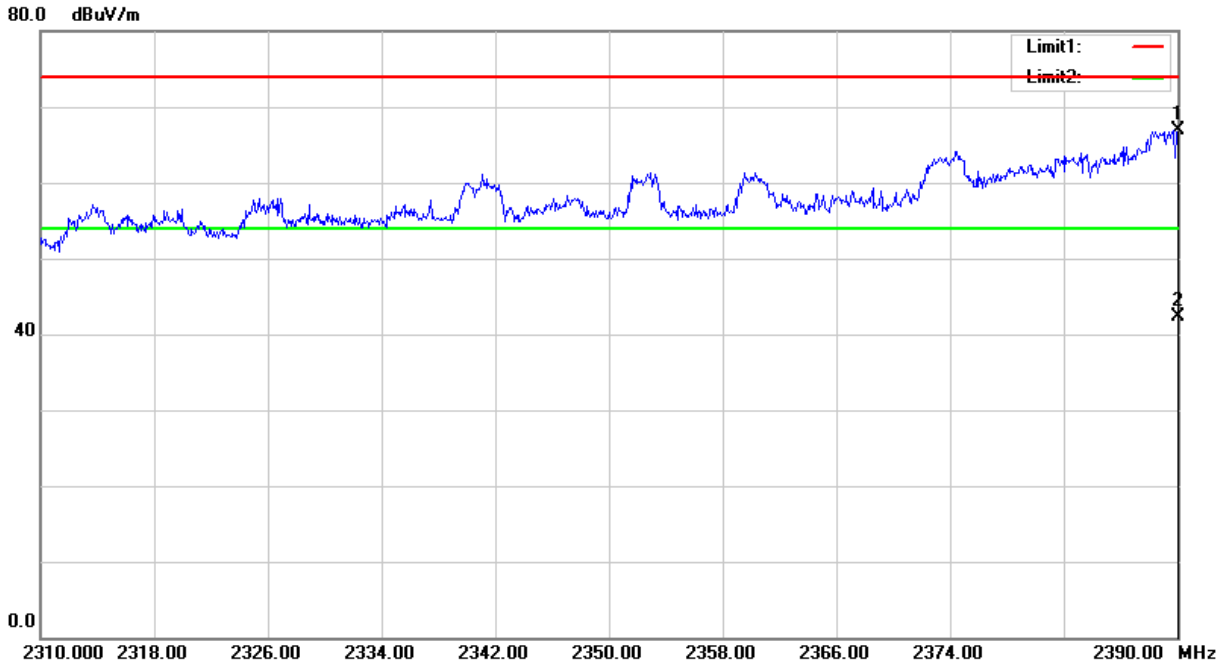

Test Model	Spurious Emission in Restricted Band 2310-2390MHz Hopping	GFSK	V
		Test By: King Kong	

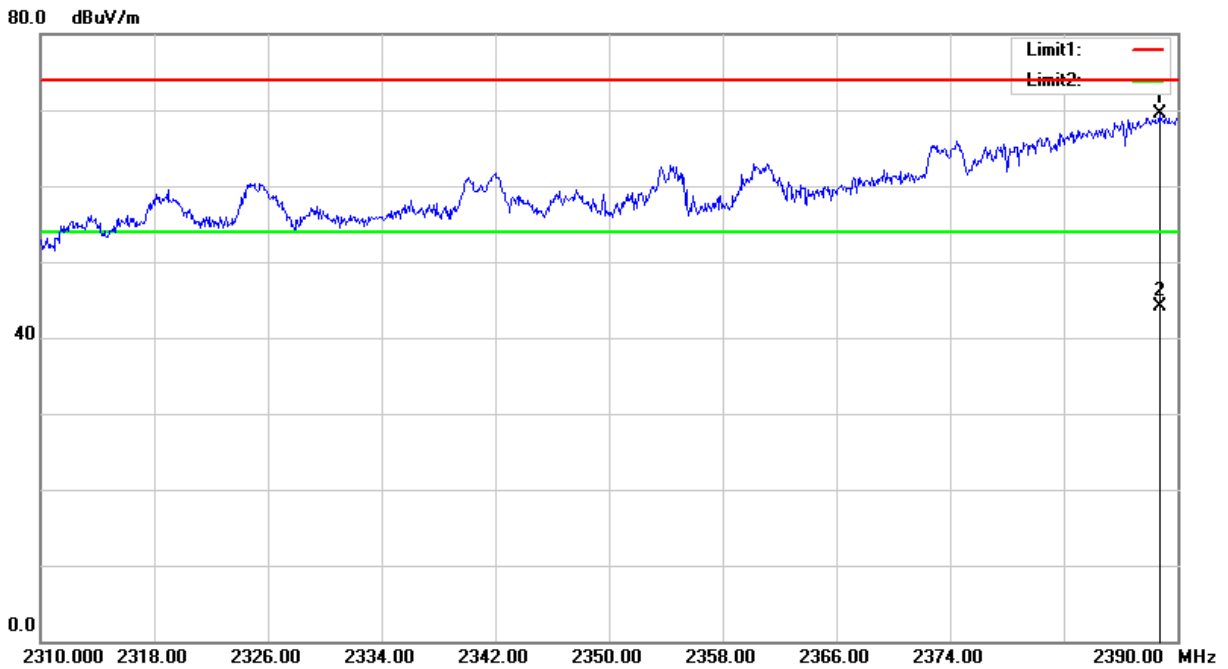

Test Model	Spurious Emission in Restricted Band 2400-2483.5MHz		
	Hopping	GFSK	H
		Test By: King Kong	

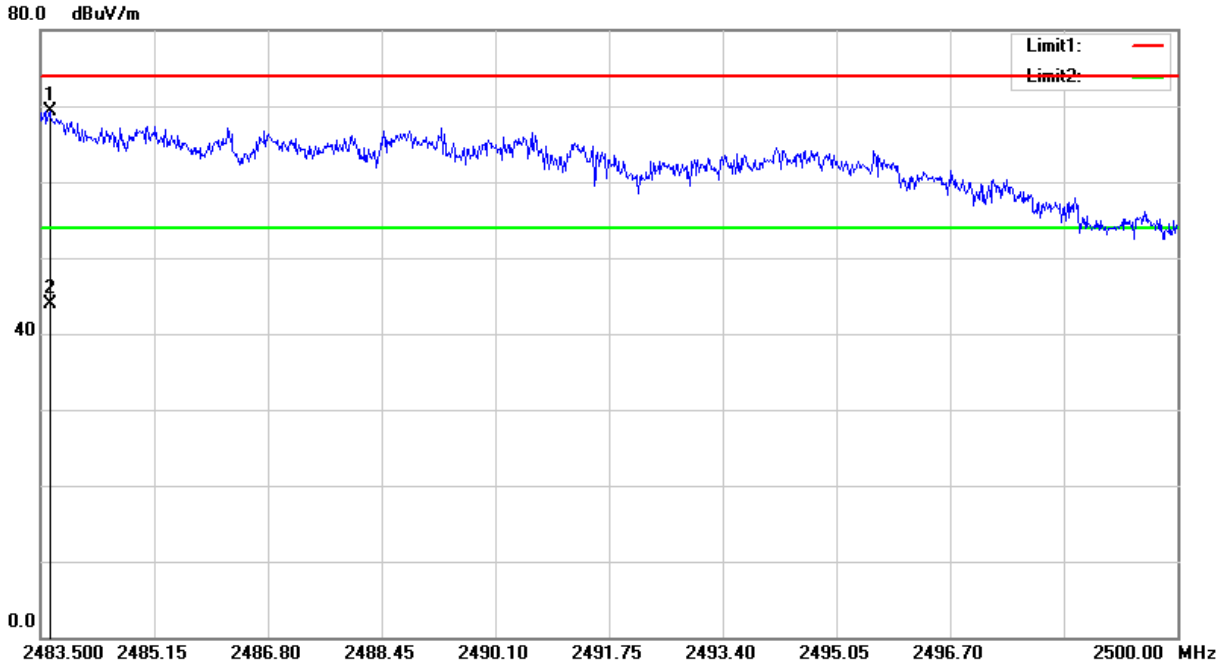

Test Model	Spurious Emission in Restricted Band 2400-2483.5MHz		
	Hopping	GFSK	V
		Test By: King Kong	

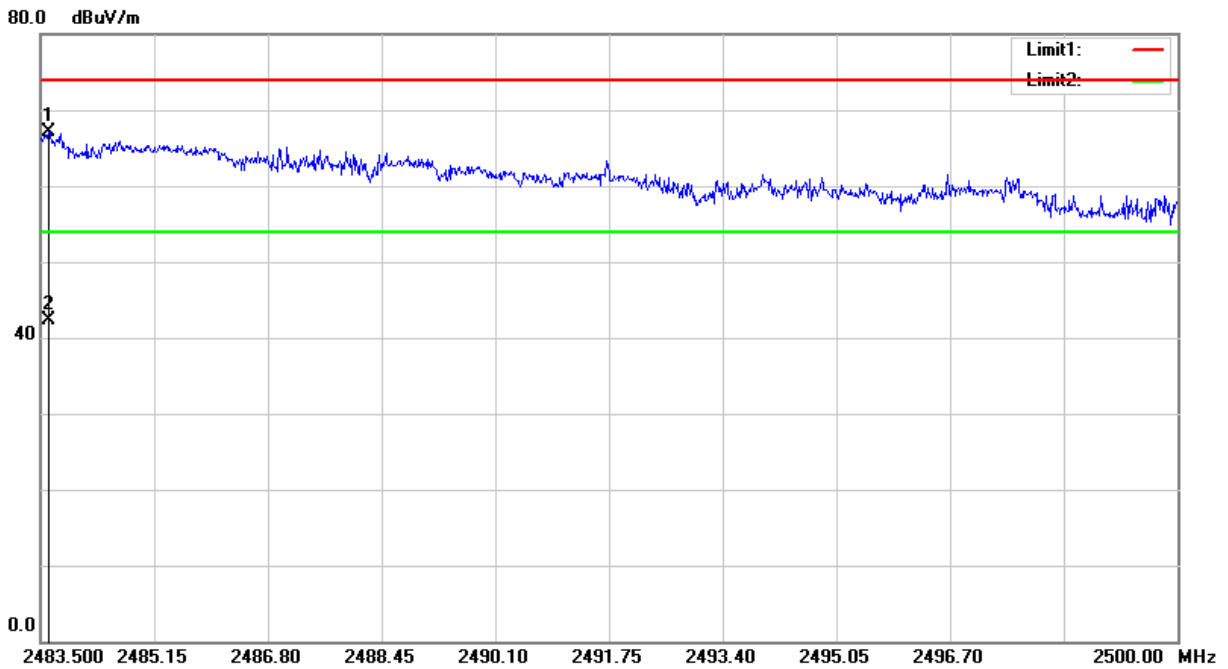

■ Spurious Emission below 1GHz (30MHz to 1GHz)

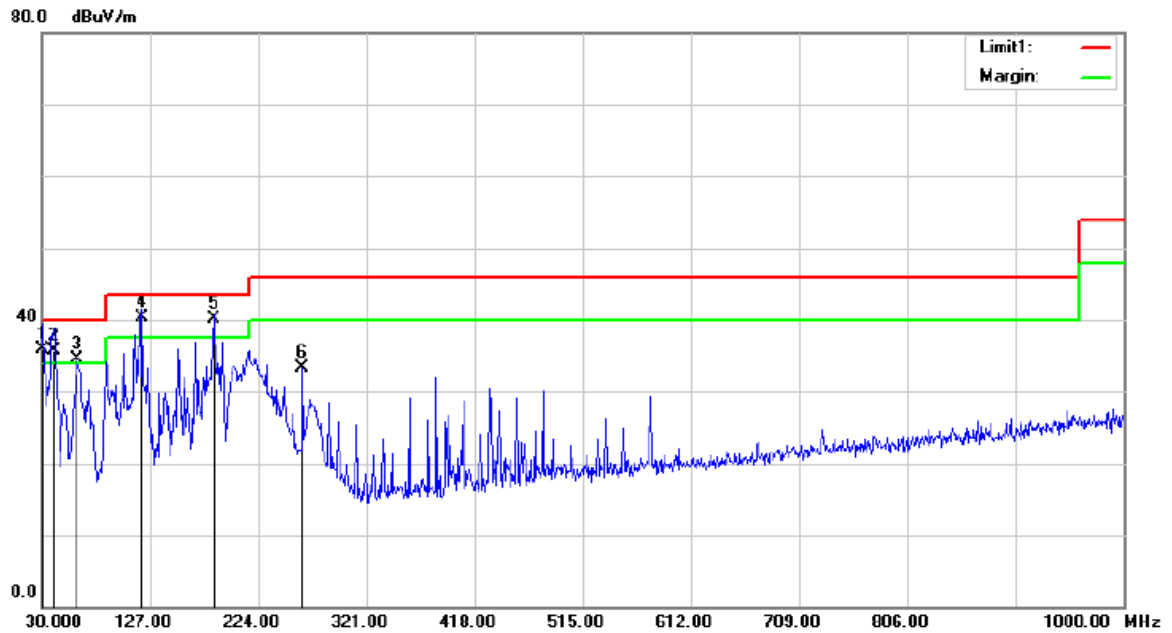

Site Conducted #3 Polarization: *Vertical* Temperature: 24
 Limit: (RE)FCC PART 15 CLASS B Power: AC 120V/60Hz Humidity: 53 %
 Mode: TX-Low Channel
 Note:

No.	Mk.	Freq.	Reading Level	Correct Factor	Measurement	Limit	Over	Antenna Height	Table Degree	
		MHz	dBuV	dB	dBuV/m	dBuV/m	dB	cm	degree	Comment
1	!	30.0000	53.38	-17.48	35.90	40.00	-4.10	QP	0	
2	!	40.6700	51.04	-15.34	35.70	40.00	-4.30	QP	0	
3	!	62.0100	50.49	-16.01	34.48	40.00	-5.52	QP	0	
4	*	120.2100	57.36	-17.06	40.30	43.50	-3.20	QP	0	
5	!	184.2300	57.11	-17.01	40.10	43.50	-3.40	QP	0	
6		263.7700	46.29	-12.89	33.40	46.00	-12.60	QP	0	

*:Maximum data x:Over limit !:over margin

Operator: CSL

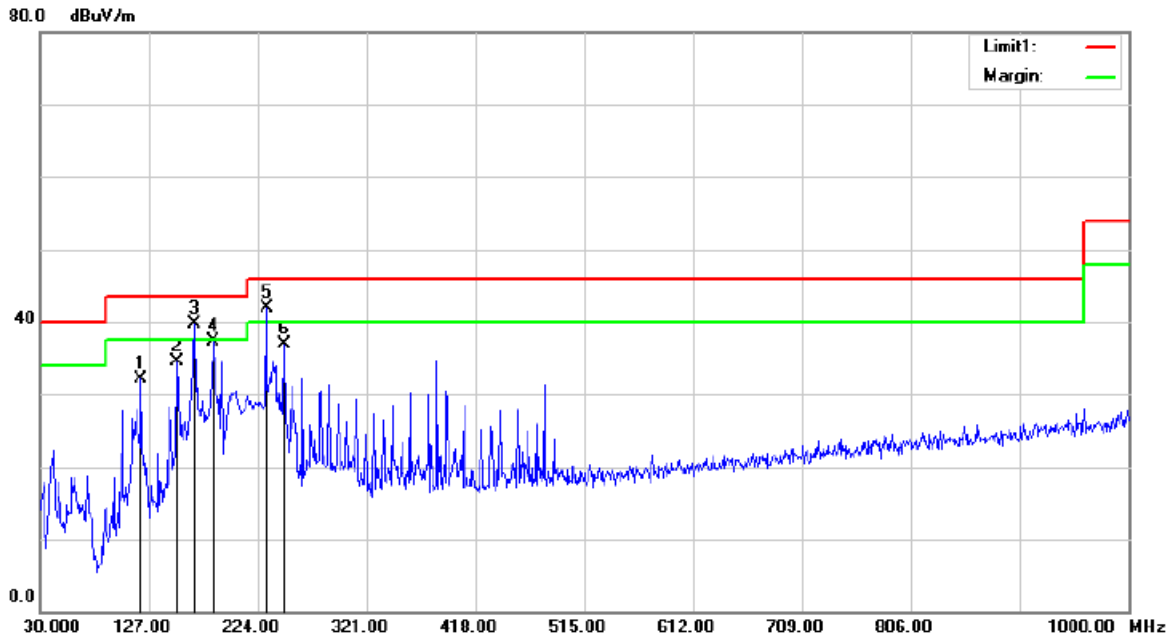

Site Conducted #3

Polarization: *Horizontal*

Temperature: 24

Limit: (RE)FCC PART 15 CLASS B
Mode:TX-Low Channel

Power: AC 120V/60Hz

Humidity: 53 %

Note:

No.	Mk.	Freq. MHz	Reading Level dBuV	Correct Factor dB	Measure- ment dBuV/m	Limit dBuV/m	Over dB	Detector	Antenna Height cm	Table Degree degree	Comment
1		120.2100	49.11	-17.06	32.05	43.50	-11.45	QP		0	
2		152.2200	53.15	-18.74	34.41	43.50	-9.09	QP		0	
3	*	167.7400	57.18	-17.48	39.70	43.50	-3.80	QP		0	
4		184.2300	54.34	-17.01	37.33	43.50	-6.17	QP		0	
5	!	231.7600	55.99	-14.17	41.82	46.00	-4.18	QP		0	
6		247.2800	50.55	-13.60	36.95	46.00	-9.05	QP		0	

*:Maximum data x:Over limit !:over margin

Operator: CSL

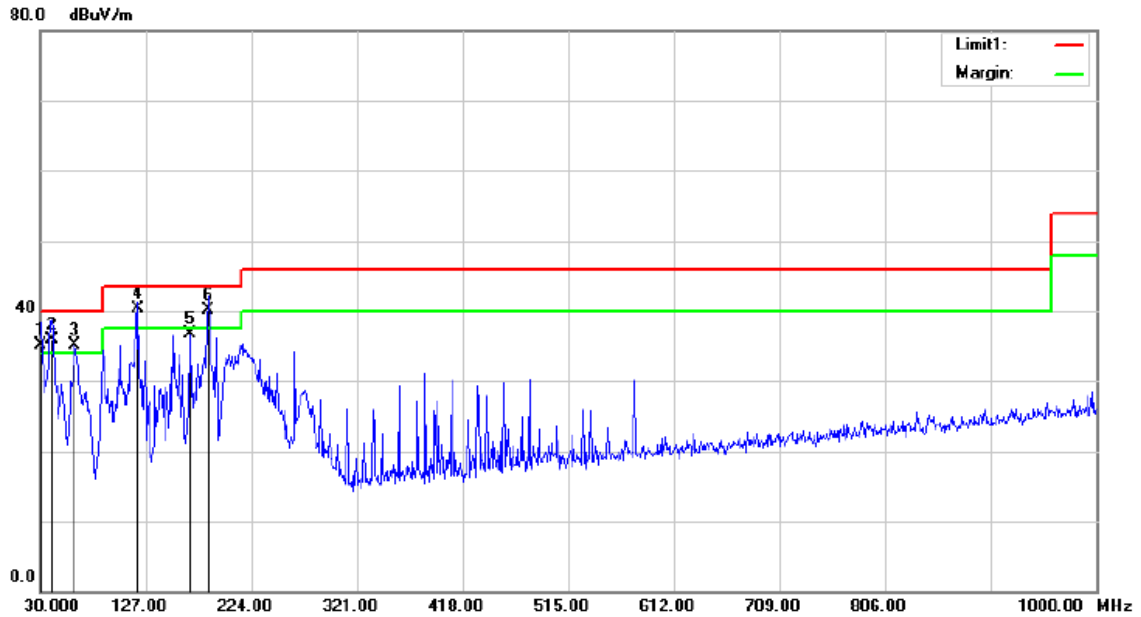

Site Conducted #3 Polarization: *Vertical* Temperature: 24
 Limit: (RE)FCC PART 15 CLASS B Power: AC 120V/60Hz Humidity: 53 %
 Mode: TX-Mid Channel
 Note:

No.	Mk.	Freq. MHz	Reading Level dBuV	Correct Factor dB	Measure- ment dBuV/m	Limit dBuV/m	Over dB	Antenna Height cm	Table Degree	Comment
1	!	30.0000	52.68	-17.48	35.20	40.00	-4.80	QP	0	
2	!	40.6700	51.24	-15.34	35.90	40.00	-4.10	QP	0	
3	!	62.0100	51.03	-16.01	35.02	40.00	-4.98	QP	0	
4	*	120.2100	57.36	-17.06	40.30	43.50	-3.20	QP	0	
5		167.7400	54.28	-17.48	36.80	43.50	-6.70	QP	0	
6	!	184.2300	57.11	-17.01	40.10	43.50	-3.40	QP	0	

*:Maximum data x:Over limit !:over margin

Operator: CSL

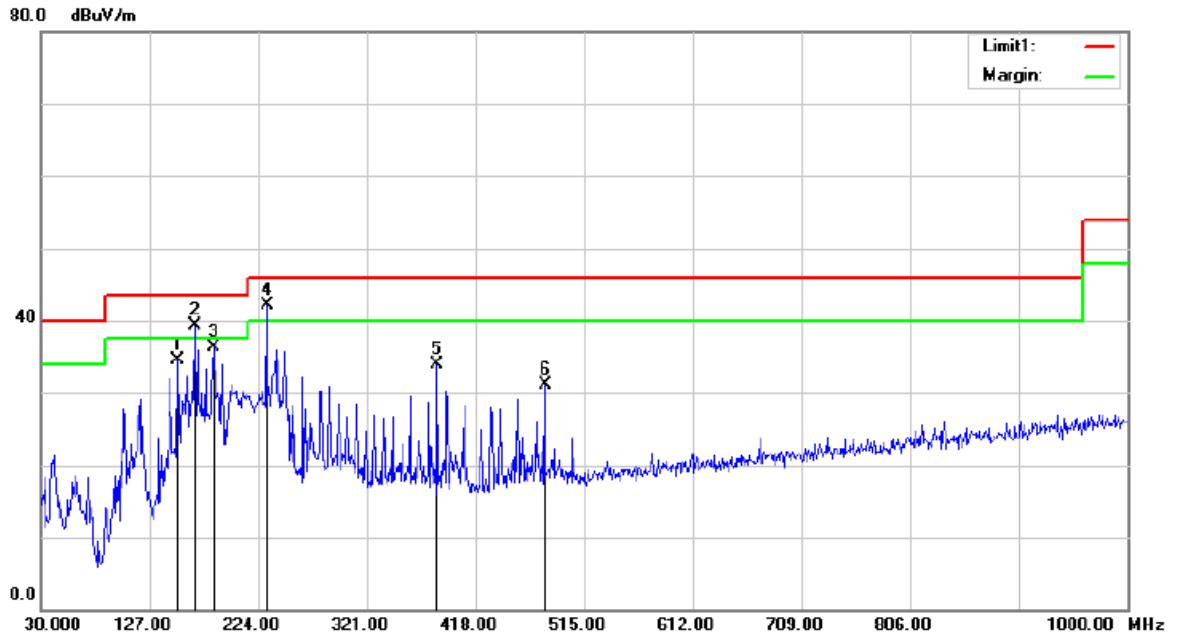

Site Conducted #3 Polarization: **Horizontal** Temperature: 24
 Limit: (RE)FCC PART 15 CLASS B Power: AC 120V/60Hz Humidity: 53 %
 Mode:TX-Mid Channel
 Note:

No.	Mk.	Freq. MHz	Reading Level dBuV	Correct Factor dB	Measure- ment dBuV/m	Limit dBuV/m	Over dB	Antenna Height cm	Table Degree	Comment
1		152.2200	53.30	-18.74	34.56	43.50	-8.94	QP	0	
2	!	167.7400	56.70	-17.48	39.22	43.50	-4.28	QP	0	
3		184.2300	53.38	-17.01	36.37	43.50	-7.13	QP	0	
4	*	231.7600	56.26	-14.17	42.09	46.00	-3.91	QP	0	
5		384.0500	43.85	-10.02	33.83	46.00	-12.17	QP	0	
6		480.0800	38.94	-7.79	31.15	46.00	-14.85	QP	0	

*:Maximum data x:Over limit !:over margin

Operator: CSL

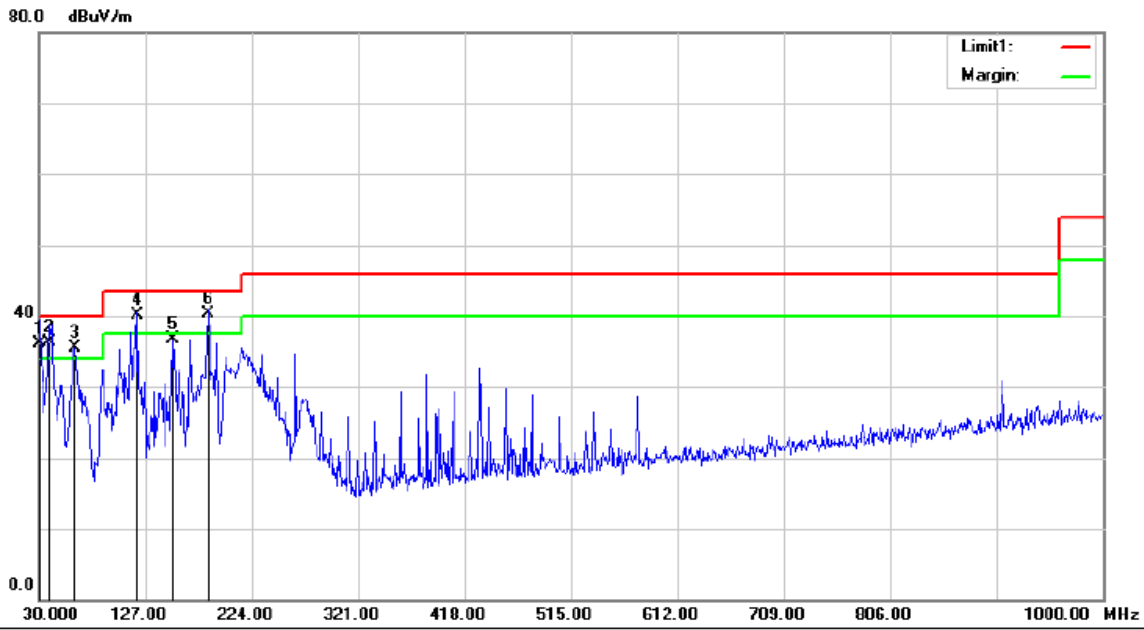

Site Conducted #3 Polarization: *Vertical* Temperature: 24
 Limit: (RE)FCC PART 15 CLASS B Power: AC 120V/60Hz Humidity: 53 %
 Mode:TX-High Channel
 Note:

No.	Mk.	Freq.	Reading Level	Correct Factor	Measurement	Limit	Over	Antenna Height	Table Degree	
		MHz	dBuV	dB	dBuV/m	dBuV/m	dB	cm	degree	Comment
1	!	30.0000	53.58	-17.48	36.10	40.00	-3.90	QP	0	
2	!	39.7000	51.99	-15.59	36.40	40.00	-3.60	QP	0	
3	!	62.9800	51.62	-16.16	35.46	40.00	-4.54	QP	0	
4	!	120.2100	57.16	-17.06	40.10	43.50	-3.40	QP	0	
5		152.2200	55.45	-18.74	36.71	43.50	-6.79	QP	0	
6	*	184.2300	57.31	-17.01	40.30	43.50	-3.20	QP	0	

*:Maximum data x:Over limit !:over margin

Operator: CSL

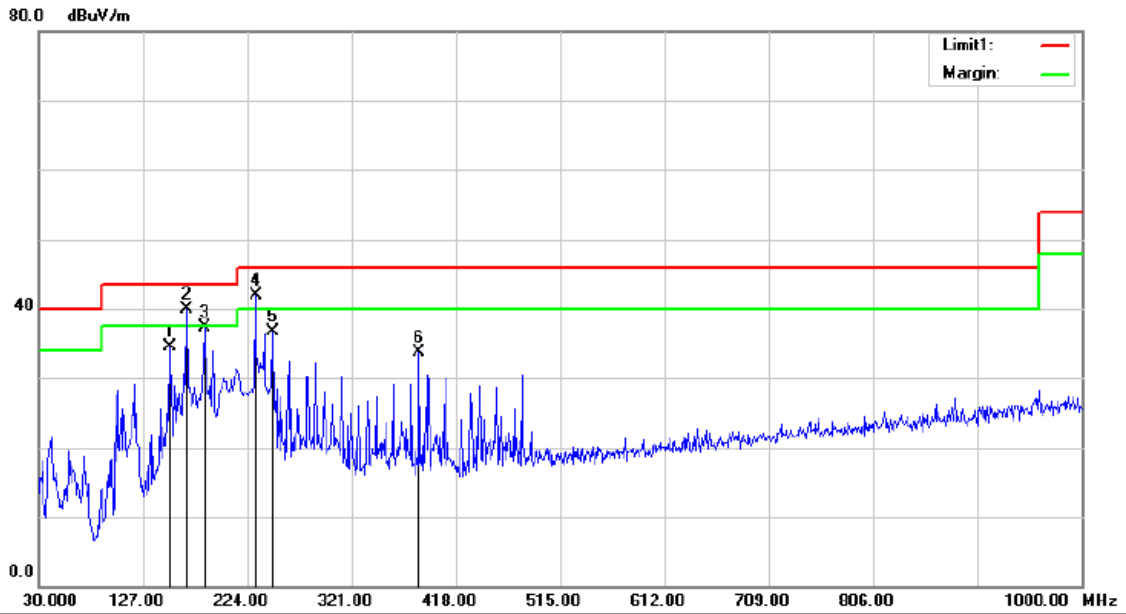

Site Conducted #3 Polarization: *Horizontal* Temperature: 24
 Limit: (RE)FCC PART 15 CLASS B Power: AC 120V/60Hz Humidity: 53 %
 Mode:TX-High Channel
 Note:

No.	Mk.	Freq.	Reading Level	Correct Factor	Measurement	Limit	Over	Antenna Height	Table Degree	Comment
		MHz	dBuV	dB	dBuV/m	dBuV/m	dB	cm	degree	
1		152.2200	53.23	-18.74	34.49	43.50	-9.01	QP	0	
2	*	167.7400	57.31	-17.48	39.83	43.50	-3.67	QP	0	
3		184.2300	54.41	-17.01	37.40	43.50	-6.10	QP	0	
4	!	231.7600	56.09	-14.17	41.92	46.00	-4.08	QP	0	
5		247.2800	50.34	-13.60	36.74	46.00	-9.26	QP	0	
6		384.0500	43.68	-10.02	33.66	46.00	-12.34	QP	0	

*:Maximum data x:Over limit !:over margin

Operator: CSL

8.8 CONDUCTED EMISSION TEST

8.8.1 Applicable Standard

According to FCC Part 15.207(a)

8.8.2 Conformance Limit

Conducted Emission Limit		
Frequency(MHz)	Quasi-peak	Average
0.15-0.5	66-56	56-46
0.5-5.0	56	46
5.0-30.0	60	50

Note: 1. The lower limit shall apply at the transition frequencies
 2. The limit decreases in line with the logarithm of the frequency in the range of 0.15 to 0.50MHz.

8.8.3 Test Configuration

Test according to clause 7.3 conducted emission test setup

8.8.4 Test Procedure

The EUT was placed on a table which is 0.8m above ground plane.
 Maximum procedure was performed on the highest emissions to ensure EUT compliance.
 Repeat above procedures until all frequency measured were complete.

8.8.5 Test Results

Pass

The 120V & 240V voltage have been tested, and the worst result recorded was report as below:

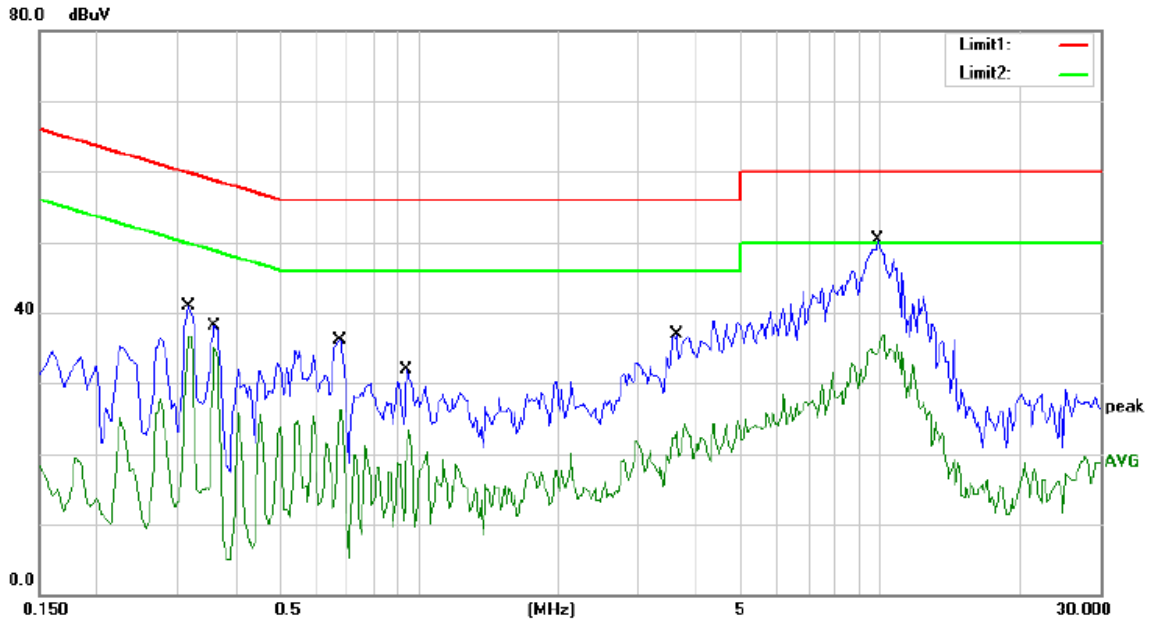

Site Conduction #1

Phase: **L1**

Temperature: 22

Limit: (CE)FCC PART 15 class B_QP

Power: AC 120V/60Hz

Humidity: 55 %

Mode: TX

Note:

No.	Mk.	Freq. MHz	Reading Level dBuV	Correct Factor dB	Measure- ment dBuV	Limit dBuV	Over dB	Detector	Comment
1		0.3150	40.81	0.00	40.81	59.84	-19.03	QP	
2		0.3150	36.62	0.00	36.62	49.84	-13.22	AVG	
3		0.3600	38.16	0.00	38.16	58.73	-20.57	QP	
4		0.3600	35.08	0.00	35.08	48.73	-13.65	AVG	
5		0.6750	36.08	0.00	36.08	56.00	-19.92	QP	
6		0.6750	26.32	0.00	26.32	46.00	-19.68	AVG	
7		0.9400	31.99	0.00	31.99	56.00	-24.01	QP	
8		0.9400	23.26	0.00	23.26	46.00	-22.74	AVG	
9		3.6050	36.96	0.00	36.96	56.00	-19.04	QP	
10		3.6050	24.37	0.00	24.37	46.00	-21.63	AVG	
11	*	9.8700	50.30	0.00	50.30	60.00	-9.70	QP	
12		9.8700	36.92	0.00	36.92	50.00	-13.08	AVG	

*:Maximum data x:Over limit !:over margin Comment: Factor build in receiver. Operator: csl

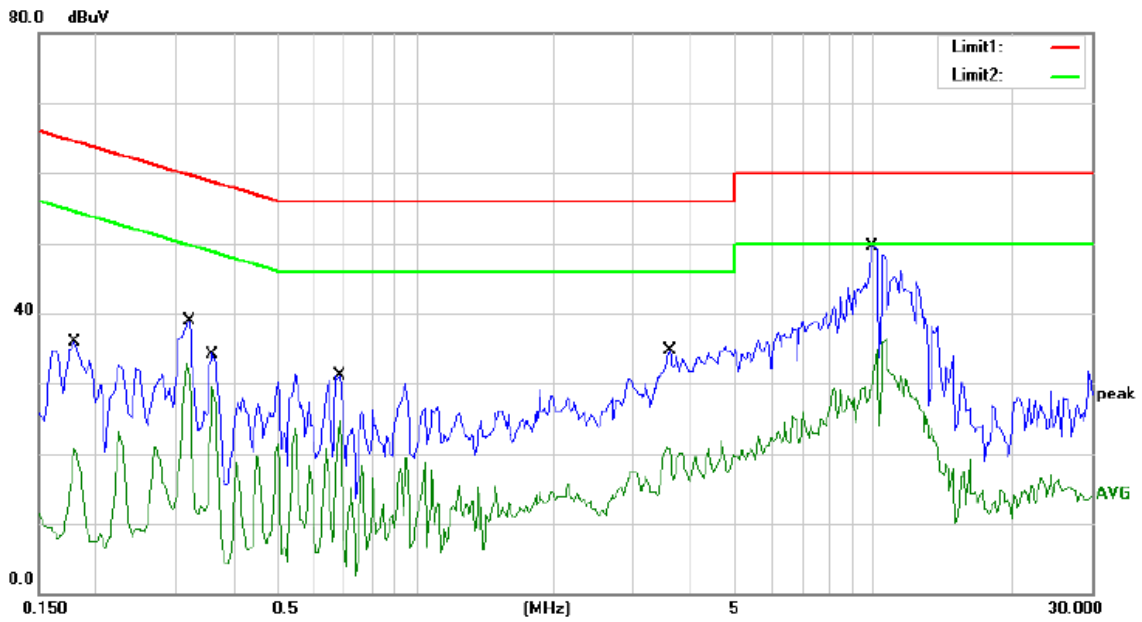

Site: Conduction #1 Phase: **N** Temperature: 22
 Limit: (CE)FCC PART 15 class B QP Power: AC 120V/60Hz Humidity: 55 %
 Mode: TX
 Note:

No.	Mk.	Freq. MHz	Reading Level dBuV	Correct Factor dB	Measure- ment dBuV	Limit dBuV	Over dB	Detector	Comment
1		0.1800	35.82	0.00	35.82	64.49	-28.67	QP	
2		0.1800	20.77	0.00	20.77	54.49	-33.72	AVG	
3		0.3200	38.90	0.00	38.90	59.71	-20.81	QP	
4		0.3200	33.00	0.00	33.00	49.71	-16.71	AVG	
5		0.3600	34.20	0.00	34.20	58.73	-24.53	QP	
6		0.3600	29.42	0.00	29.42	48.73	-19.31	AVG	
7		0.6850	31.19	0.00	31.19	56.00	-24.81	QP	
8		0.6850	24.62	0.00	24.62	46.00	-21.38	AVG	
9		3.5850	34.65	0.00	34.65	56.00	-21.35	QP	
10		3.5850	20.87	0.00	20.87	46.00	-25.13	AVG	
11	*	9.9500	49.53	0.00	49.53	60.00	-10.47	QP	
12		9.9500	36.32	0.00	36.32	50.00	-13.68	AVG	

*:Maximum data x:Over limit !:over margin Comment: Factor build in receiver. Operator: csl

8.9 ANTENNA APPLICATION

8.9.1 Antenna Requirement

Standard	Requirement
FCC CRF Part 15.203	An intentional radiator shall be designed to ensure that no antenna other than that furnished by the responsible party shall be used with the device. The use of a permanently attached antenna or of an antenna that uses a unique coupling to the intentional radiator shall be considered sufficient to comply with the provisions of this section. The manufacturer may design the unit so that a broken antenna can be replaced by the user, but the use of a standard antenna jack or electrical connector is prohibited. This requirement does not apply to carrier current devices or to devices operated under the provisions of §15.211, §15.213, §15.217, §15.219, or §15.221. Further, this requirement does not apply to intentional radiators that must be professionally installed, such as perimeter protection systems and some field disturbance sensors, or to other intentional radiators which, in accordance with §15.31(d), must be measured at the installation site. However, the installer shall be responsible for ensuring that the proper antenna is employed so that the limits in this part are not exceeded.

For intentional device, according to FCC 47 CFR Section 15.203, an intentional radiator shall be designed to ensure that no antenna other than that furnished by the responsible party shall be used with the device. And according to FCC 47 CFR Section 15.247 (b), if transmitting antennas of directional gain greater than 6dBi are used, the power shall be reduced by the amount in dB that the directional gain of the antenna exceeds 6dBi.

8.9.2 Result

PASS.

The EUT has 1 antenna: a PiFa antenna antenna, the gain is 0 dBi;

- Note:
- Antenna use a permanently attached antenna which is not replaceable.
 - Not using a standard antenna jack or electrical connector for antenna replacement
 - The antenna has to be professionally installed (please provide method of installation)

which in accordance to section 15.203, please refer to the internal photos.

APPENDIX A-PHOTOGRAPHS OF EUT









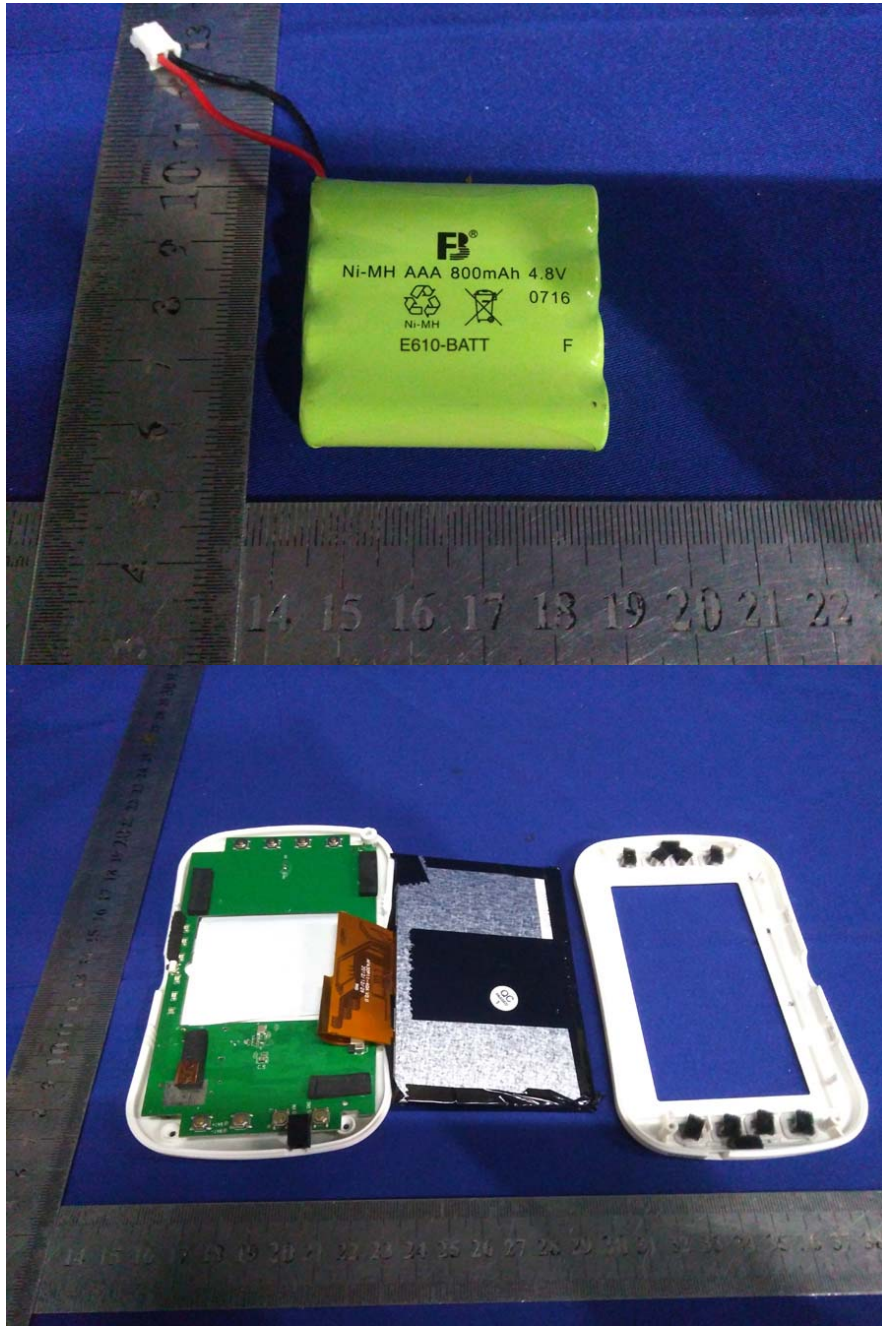

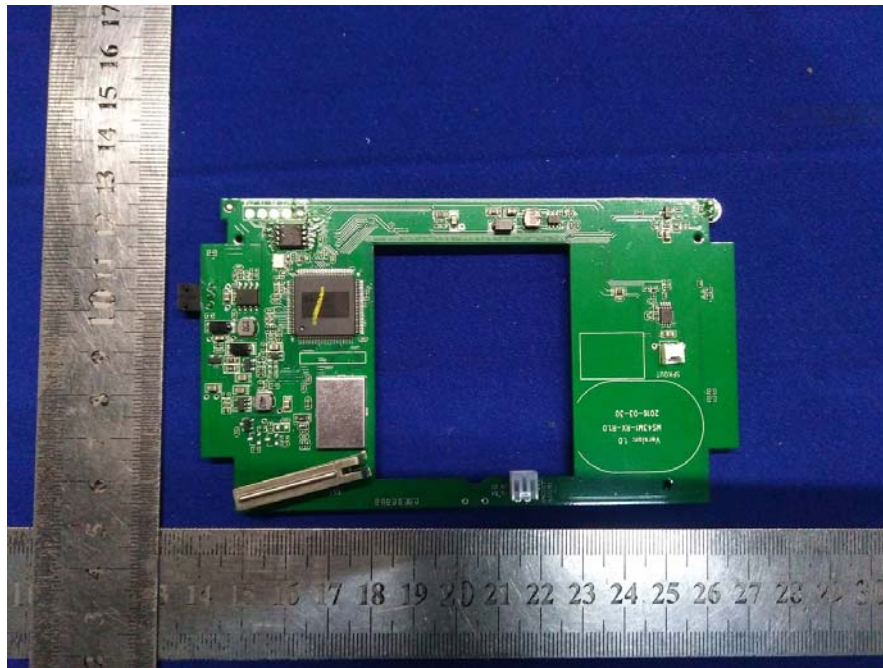
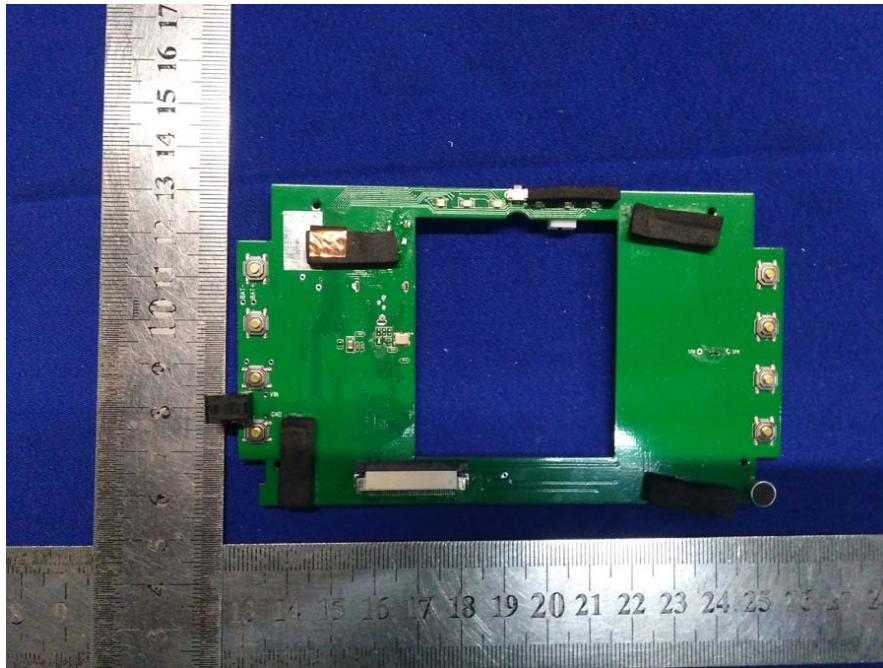



-----The end-----