



**FCC 47 CFR PART 15 SUBPART C**

**CERTIFICATION TEST REPORT**

*For*

**Bluetooth Gateway  
MODEL NUMBER: GTW0000BT0**

**FCC ID: 2AJCX-LEGWB**

**REPORT NUMBER: 4788097701-3**

**ISSUE DATE: September 29, 2017**

*Prepared for*

**CAREL INDUSTRIES S.p.A.  
via dell'Industria, 11 - 35020 Brugine, PD – ITALY**

*Prepared by*

**UL Verification Services (Guangzhou) Co., Ltd, Song Shan Lake Branch  
Room 101, Building 10, Innovation Technology Park,  
Song Shan Lake Hi tech Development Zone, Dongguan, 523808, China  
Tel: +86 769 33871725  
Fax: +86 769 33871725  
Website: www.ul.com**

The results reported herein have been performed in accordance with the laboratory's terms of accreditation. This report shall not be reproduced except in full without the written approval of the Laboratory. The results in this report apply to the test sample(s) mentioned above at the time of the testing period only and are not to be used to indicate applicability to other similar products. This report does not imply that the product(s) has met the criteria for certification.

Revision History

Rev.	Issue Date	Revisions	Revised By
--	09/29/2017	Initial Issue	

Summary of Test Results			
Clause	Test Items	FCC/IC Rules	Test Results
1	6db DTS Bandwidth	FCC 15.247 (a) (2)	Complied
2	Peak Conducted Power	FCC 15.247 (b) (3)	Complied
3	Power Spectral Density	FCC 15.247 (3)	Complied
4	Conducted Band edge And Spurious emission	FCC 15.247 (d)	Complied
5	Radiated Band edges and Spurious emission	FCC 15.247 (d) FCC 15.209 FCC 15.205	Complied
6	Conducted Emission Test For AC Power Port	FCC 15.207	Complied
7	Antenna Requirement	FCC 15.203	Complied

## TABLE OF CONTENTS

<b>1. ATTESTATION OF TEST RESULTS .....</b>	<b>6</b>
<b>2. TEST METHODOLOGY .....</b>	<b>7</b>
<b>3. FACILITIES AND ACCREDITATION .....</b>	<b>7</b>
<b>4. CALIBRATION AND UNCERTAINTY .....</b>	<b>8</b>
4.1. MEASURING INSTRUMENT CALIBRATION .....	8
4.2. MEASUREMENT UNCERTAINTY.....	8
<b>5. EQUIPMENT UNDER TEST .....</b>	<b>9</b>
5.1. DESCRIPTION OF EUT .....	9
5.2. MAXIMUM OUTPUT POWER.....	9
5.3. CHANNEL LIST.....	9
5.4. TEST CHANNEL CONFIGURATION.....	10
5.5. THE WORSE CASE POWER SETTING PARAMETER.....	10
5.6. DESCRIPTION OF AVAILABLE ANTENNAS .....	10
5.7. WORST-CASE CONFIGURATIONS.....	10
5.8. TEST ENVIRONMENT .....	10
5.9. DESCRIPTION OF TEST SETUP.....	11
5.10. MEASURING INSTRUMENT AND SOFTWARE USED .....	12
<b>6. MEASUREMENT METHODS .....</b>	<b>13</b>
<b>7. ANTENNA PORT TEST RESULTS .....</b>	<b>14</b>
7.1. ON TIME AND DUTY CYCLE.....	14
7.2. 6 dB DTS BANDWIDTH & 99% BANDWIDTH.....	15
7.3. PEAK CONDUCTED OUTPUT POWER.....	20
7.4. POWER SPECTRAL DENSITY .....	21
7.5. CONDUCTED BANDEDGE AND SPURIOUS EMISSIONS.....	24
<b>8. RADIATED TEST RESULTS.....</b>	<b>36</b>
8.1. RESTRICTED BANDEDGE.....	41
8.2. SPURIOUS EMISSIONS 1~18GHz .....	45
8.3. SPURIOUS EMISSIONS 18G ~ 26GHz.....	51
8.4. SPURIOUS EMISSIONS 30M ~ 1 GHz .....	53
8.5. SPURIOUS EMISSIONS BELOW 30M.....	55
<b>9. AC POWER LINE CONDUCTED EMISSIONS .....</b>	<b>59</b>



# 1. ATTESTATION OF TEST RESULTS

## Applicant Information

Company Name: CAREL INDUSTRIES S.p.A.  
Address: via dell'Industria, 11 - 35020 Brugine, PD – ITALY

## Manufacturer Information

Company Name: CAREL INDUSTRIES S.p.A.  
Address: via dell'Industria, 11 - 35020 Brugine, PD – ITALY

## Factory Information

Company Name: CAREL INDUSTRIES S.p.A.  
Address: via dell'Industria, 11 - 35020 Brugine, PD – ITALY

## EUT Description

Product Name Bluetooth Gateway  
Brand Name CAREL  
Model Name GTW0000BT0  
Date Tested September 01, 2017 ~ September 22, 2017

APPLICABLE STANDARDS	
STANDARD	TEST RESULTS
CFR 47 Part 15 Subpart C	PASS

Tested By:

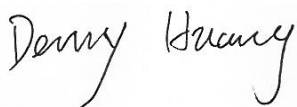

Denny Huang  
Engineer Project Associate

Checked By:



Shawn Wen  
Laboratory Leader

Approved By:



Stephen Guo  
Laboratory Manager

## 2. TEST METHODOLOGY

The tests documented in this report were performed in accordance with KDB414788 D01 Radiated Test Site v01, ANSI C63.10-2013, 558074 D01 DTS Meas Guidance v04, FCC CFR 47 Part 2, FCC CFR 47 Part 15.

## 3. FACILITIES AND ACCREDITATION

Test Location	UL Verification Services (Guangzhou) Co., Ltd. Song Shan Lake Branch.
Address	Building 10, Innovation Technology Park, Song Shan Lake Hi tech Development Zone, Dongguan, 523808, China
Accreditation Certificate	UL Verification Services (Guangzhou) Co., Ltd. Song Shan Lake Branch. EMC Laboratory has been accredited by A2LA for technical competence in the field of electrical testing, and proved to be in compliance with ISO/IEC 17025: 2005 General Requirements for the Competence of Testing and Calibration Laboratories and any additional program requirements in the identified field of testing. The Certificate Registration Number is 4102.01. UL Verification Services (Guangzhou) Co., Ltd. Song Shan Lake Branch. EMC Laboratory has been registered and fully described in a report filed with the FCC (Federal Communications Commission). The Designation Number is CN1187. UL Verification Services (Guangzhou) Co., Ltd. Song Shan Lake Branch. EMC Laboratory has been registered and fully described in a report filed with Industry Canada. The Company Number is 21320.

Note:

1. The test anechoic chamber in UL Verification Services (Guangzhou) Co., Ltd. Song Shan Lake Branch had been calibrated and compared to the open field sites and the test anechoic chamber is shown to be equivalent to or worst case from the open field site.
2. For below 30MHz, lab had performed measurements at test anechoic chamber and comparing to measurements obtained on an open field site. And these measurements below 30MHz had been correlated to measurements performed on an OATS.

## 4. CALIBRATION AND UNCERTAINTY

### 4.1. MEASURING INSTRUMENT CALIBRATION

The measuring equipment utilized to perform the tests documented in this report has been calibrated in accordance with the manufacturer's recommendations, and is traceable to recognize national standards.

### 4.2. MEASUREMENT UNCERTAINTY

Where relevant, the following measurement uncertainty levels have been estimated for tests performed on the apparatus:

Test Item	Uncertainty
Uncertainty for Conduction emission test	2.90dB
Uncertainty for Radiation Emission test(include Fundamental emission) (30MHz-1GHz)	4.52dB
Uncertainty for Radiation Emission test (1GHz to 26GHz)( include Fundamental emission)	5.04dB(1-6GHz)
	5.30dB (6GHz-18Gz)
	5.23dB (18GHz-26Gz)
Note: This uncertainty represents an expanded uncertainty expressed at approximately the 95% confidence level using a coverage factor of k=2.	



## 5. EQUIPMENT UNDER TEST

### 5.1. DESCRIPTION OF EUT

Equipment	Bluetooth Gateway		
Model Name	GTW0000BT0		
Product Description	Operation Frequency	2402 MHz ~ 2480 MHz	
	Modulation Type	Data Rate	
	GFSK	1Mbps	
Rated Input	DC 24V		
Bluetooth Version	BT 4.1		
Hardware Version	V1.000		
Software Version	C43037.01		

### 5.2. MAXIMUM OUTPUT POWER

Bluetooth Mode	Frequency (MHz)	Channel Number	Max Output Power (dBm)
BLE	2402-2480	0-39[40]	-2.99

### 5.3. CHANNEL LIST

Channel	Frequency (MHz)	Channel	Frequency (MHz)	Channel	Frequency (MHz)	Channel	Frequency (MHz)
0	2402	11	2424	22	2446	33	2468
1	2404	12	2426	23	2448	34	2470
2	2406	13	2428	24	2450	35	2472
3	2408	14	2430	25	2452	36	2474
4	2410	15	2432	26	2454	37	2476
5	2412	16	2434	27	2456	38	2478
6	2414	17	2436	28	2458	39	2480
7	2416	18	2438	29	2460		
8	2418	19	2440	30	2462		
9	2420	20	2442	31	2464		
10	2422	21	2444	32	2468		

### 5.4. TEST CHANNEL CONFIGURATION

Test Mode	Test Channel	Frequency
GFSK	CH 00, CH 19, CH 39	2402MHz, 2440MHz, 2480MHz

### 5.5. THE WORSE CASE POWER SETTING PARAMETER

The Worst Case Power Setting Parameter under 2400 ~ 2483.5MHz Band				
Test Software		CyBLE MTK Application		
Modulation Type	Transmit Antenna Number	Test Channel		
		CH 00	CH 19	CH 39
GFSK	1	0dBm	0dBm	0dBm

### 5.6. DESCRIPTION OF AVAILABLE ANTENNAS

Ant.	Frequency (MHz)	Antenna Type	Antenna Gain (dBi)
1	2402-2480	External Antenna	3.47

Test Mode	Transmit and Receive Mode	Description
GFSK	<input checked="" type="checkbox"/> 1TX, 1RX	Chain 1 can be used as transmitting/receiving antenna.

### 5.7. WORST-CASE CONFIGURATIONS

Bluetooth Mode	Modulation Technology	Modulation Type	Data Rate (Mbps)
BLE	DTS	GFSK	1Mbit/s

### 5.8. TEST ENVIRONMENT

Environment Parameter	Selected Values During Tests	
Relative Humidity	55 ~ 65%	
Atmospheric Pressure:	1025Pa	
Temperature	TN	23 ~ 28°C
	VL	N/A
Voltage :	VN	DC 24V
	VH	N/A

Note: VL= Lower Extreme Test Voltage  
 VN= Nominal Voltage, DC 24V from Adapter.  
 VH= Upper Extreme Test Voltage  
 TN= Normal Temperature

## 5.9. DESCRIPTION OF TEST SETUP

### SUPPORT EQUIPMENT

Item	Equipment	Brand Name	Model Name	P/N
1	Laptop	ThinkPad	T460S	SL10K24796 JS
2	Serial to USB Cable	N/A	N/A	N/A

### I/O CABLES

Cable No	Port	Connector Type	Cable Type	Cable Length(m)	Remarks
1	N/A	N/A	N/A	N/A	N/A

### ACCESSORY

Item	Accessory	Brand Name	Model Name	Description
1	Switching Power Supply	CAREL	PGTA00TRG0	Input: AC 100~240, 0.3A Output: DC 24V, 0.42A

### TEST SETUP

The EUT can work in an engineer mode with a software through a Laptop.

### SETUP DIAGRAM FOR TEST

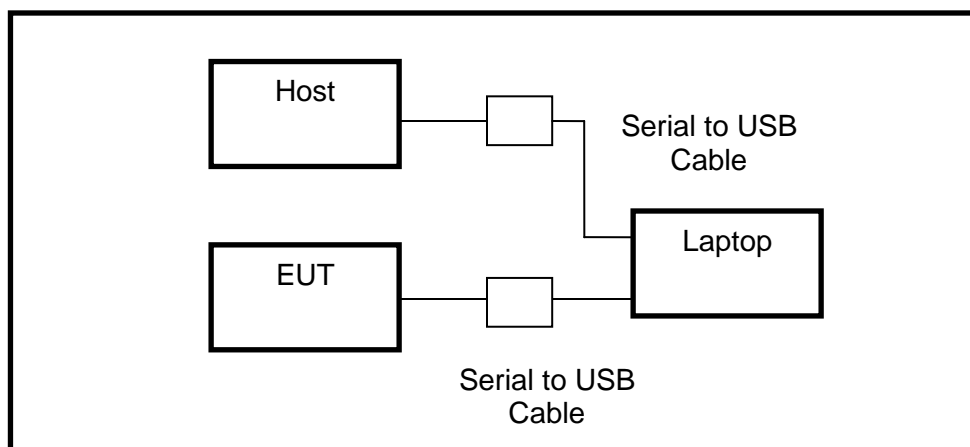

Note: The Host and the EUT are identical BLE device, the engineering mode need two BLE device work together.

**5.10. MEASURING INSTRUMENT AND SOFTWARE USED**

Conducted Emissions						
Instrument						
Used	Equipment	Manufacturer	Model No.	Serial No.	Last Cal.	Next Cal.
<input checked="" type="checkbox"/>	EMI Test Receiver	R&S	ESR3	101961	Dec.20, 2016	Dec.19, 2017
<input checked="" type="checkbox"/>	Two-Line V-Network	R&S	ENV216	101983	Dec.20, 2016	Dec.19, 2017
<input checked="" type="checkbox"/>	Artificial Mains Networks	Schwarzbeck	NSLK 8126	8126465	Feb.10, 2017	Feb.10, 2018
Software						
Used	Description	Manufacturer	Name	Version		
<input checked="" type="checkbox"/>	Test Software for Conducted disturbance	Farad	EZ-EMC	Ver. UL-3A1		
Radiated Emissions						
Instrument						
Used	Equipment	Manufacturer	Model No.	Serial No.	Last Cal.	Next Cal.
<input checked="" type="checkbox"/>	MXE EMI Receiver	KESIGHT	N9038A	MY56400036	Feb. 24, 2017	Feb. 24, 2018
<input checked="" type="checkbox"/>	Hybrid Log Periodic Antenna	TDK	HLP-3003C	130960	Jan.09, 2016	Jan.09, 2019
<input checked="" type="checkbox"/>	Preamplifier	HP	8447D	2944A09099	Feb. 13, 2017	Feb. 13, 2018
<input checked="" type="checkbox"/>	EMI Measurement Receiver	R&S	ESR26	101377	Dec. 20, 2016	Dec. 20, 2017
<input checked="" type="checkbox"/>	Horn Antenna	TDK	HRN-0118	130939	Jan. 09, 2016	Jan. 09, 2019
<input checked="" type="checkbox"/>	High Gain Horn Antenna	Schwarzbeck	BBHA-9170	691	Jan.06, 2016	Jan.06, 2019
<input checked="" type="checkbox"/>	Preamplifier	TDK	PA-02-0118	TRS-305-00066	Jan. 14, 2017	Jan. 14, 2018
<input checked="" type="checkbox"/>	Preamplifier	TDK	PA-02-2	TRS-307-00003	Dec. 20, 2016	Dec. 20, 2017
<input checked="" type="checkbox"/>	Loop antenna	Schwarzbeck	1519B	00008	Mar. 26, 2016	Mar. 25, 2019
Software						
Used	Description	Manufacturer	Name	Version		
<input checked="" type="checkbox"/>	Test Software for Radiated disturbance	Farad	EZ-EMC	Ver. UL-3A1		
Other instruments						
Used	Equipment	Manufacturer	Model No.	Serial No.	Last Cal.	Next Cal.
<input checked="" type="checkbox"/>	Spectrum Analyzer	Keysight	N9030A	MY55410512	Dec. 20, 2016	Dec. 20, 2017
<input checked="" type="checkbox"/>	Power Meter	Keysight	N1911A	MY55416024	Aug. 20, 2017	Aug. 20, 2018
<input checked="" type="checkbox"/>	Power Sensor	Keysight	N1921A	MY51100041	Feb. 13, 2017	Feb. 13, 2018
<input checked="" type="checkbox"/>	Spectrum Analyzer	R&S	FSV40	101117	Dec. 21, 2016	Dec. 20, 2017

## 6. MEASUREMENT METHODS

No.	Test Item	KDB Name	Section
1	6 dB Bandwidth	KDB 558074 D01 DTS Meas Guidance v04	8.0
2	Peak Output Power	KDB 558074 D01 DTS Meas Guidance v04	9.1.1
3	Power Spectral Density	KDB 558074 D01 DTS Meas Guidance v04	10.2
4	Out-of-band emissions in non-restricted bands	KDB 558074 D01 DTS Meas Guidance v04	11.0
5	Out-of-band emissions in restricted bands	KDB 558074 D01 DTS Meas Guidance v04	12.1
6	Band-edge	KDB 558074 D01 DTS Meas Guidance v04	13.3.2
7	Conducted Emission Test For AC Power Port	ANSI C63.10-2013	7.3

## 7. ANTENNA PORT TEST RESULTS

### 7.1. ON TIME AND DUTY CYCLE

#### LIMITS

None; for reporting purposes only

#### PROCEDURE

KDB 558074 Zero-Span Spectrum Analyzer Method

#### TEST SETUP

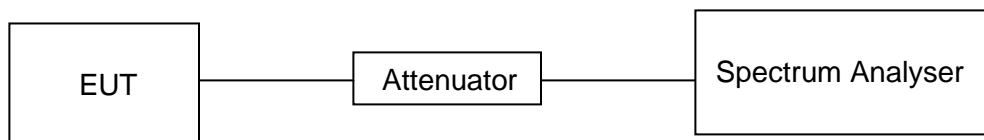

#### RESULTS

Mode	On Time (msec)	Period (msec)	Duty Cycle x (Linear)	Duty Cycle (%)	Duty Cycle Correction Factor (db)	1/T Minimum VBW (KHz)
GFSK	100	100	1	100	0	0.01

Note: Duty Cycle Correction Factor=10log(1/x).  
 Where: x is Duty Cycle(Linear)  
 Where: T is On Time (transmit duration)

#### ON TIME AND DUTY CYCLE MID CH

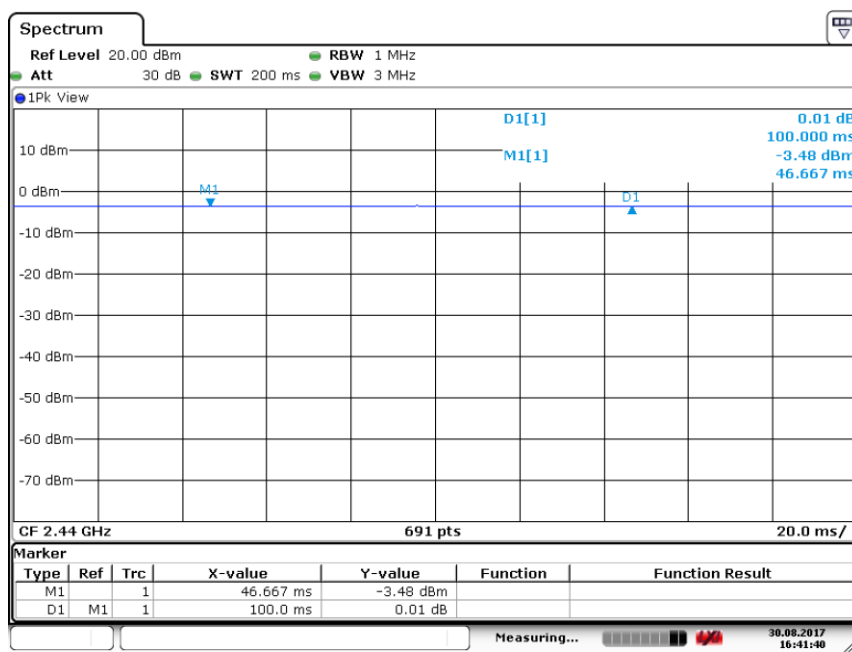

Date: 30.AUG.2017 16:41:41

## 7.2. 6 dB DTS BANDWIDTH & 99% BANDWIDTH

### LIMITS

FCC Part15 (15.247) Subpart C			
Section	Test Item	Limit	Frequency Range (MHz)
FCC 15.247(a)(2)	6dB Bandwidth	$\geq 500\text{KHz}$	2400-2483.5

### TEST PROCEDURE

Connect the UUT to the spectrum analyser and use the following settings:

Center Frequency	The centre frequency of the channel under test
Detector	Peak
RBW	For 6 dB Bandwidth :100K For 99% Bandwidth :1% to 5% of the occupied bandwidth
VBW	For 6dB Bandwidth : $\geq 3 \times \text{RBW}$ For 99% Bandwidth : approximately $3 \times \text{RBW}$
Trace	Max hold
Sweep	Auto couple

Allow the trace to stabilize and measure the maximum width of the emission that is constrained by the frequencies associated with the two outermost amplitude points (upper and lower frequencies) that are attenuated by 6 dB and 99% relative to the maximum level measured in the fundamental emission.

### TEST SETUP

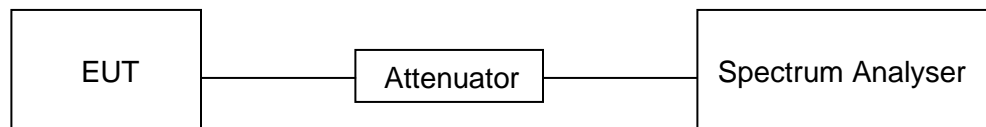

Channel	Frequency (MHz)	6dB bandwidth (MHz)	Limit (kHz)	Result
Low	2402	0.7265	500	Pass
Middle	2440	0.7381	500	Pass
High	2480	0.7294	500	Pass

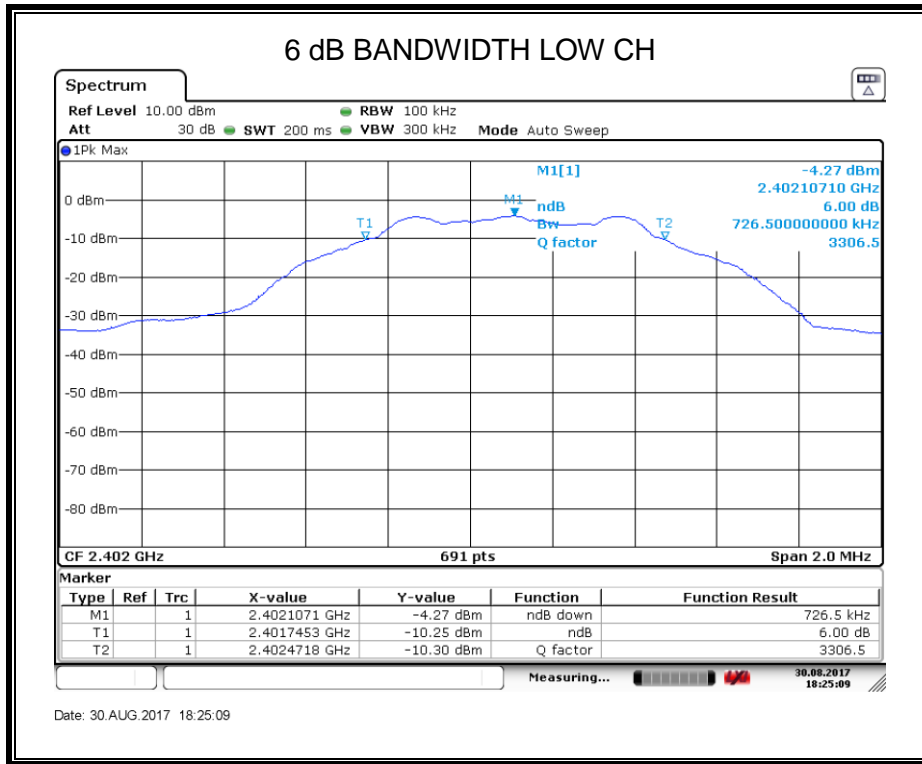



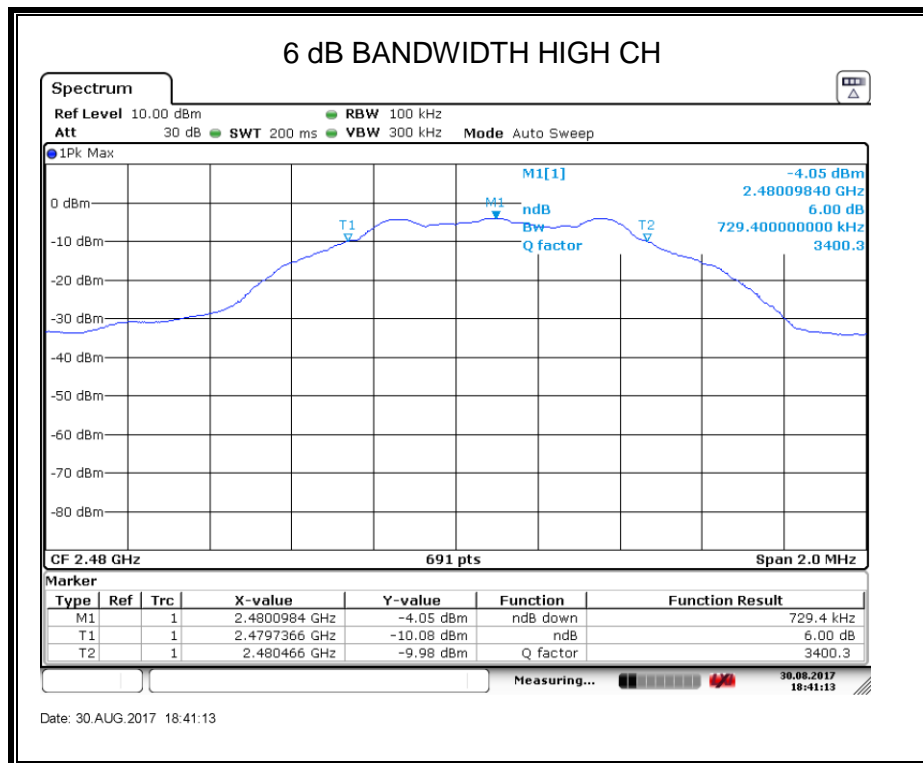
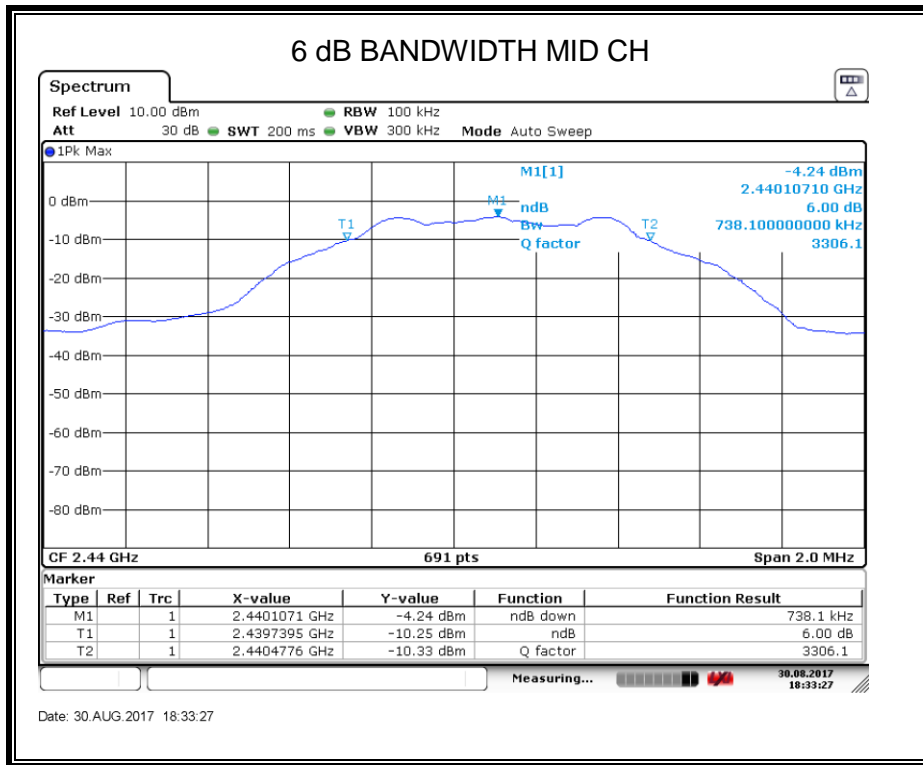

Channel	Frequency (MHz)	99% bandwidth (MHz)	Limit (kHz)	Result
Low	2402	1.0677	500	Pass
Middle	2440	1.0610	500	Pass
High	2480	1.0595	500	Pass

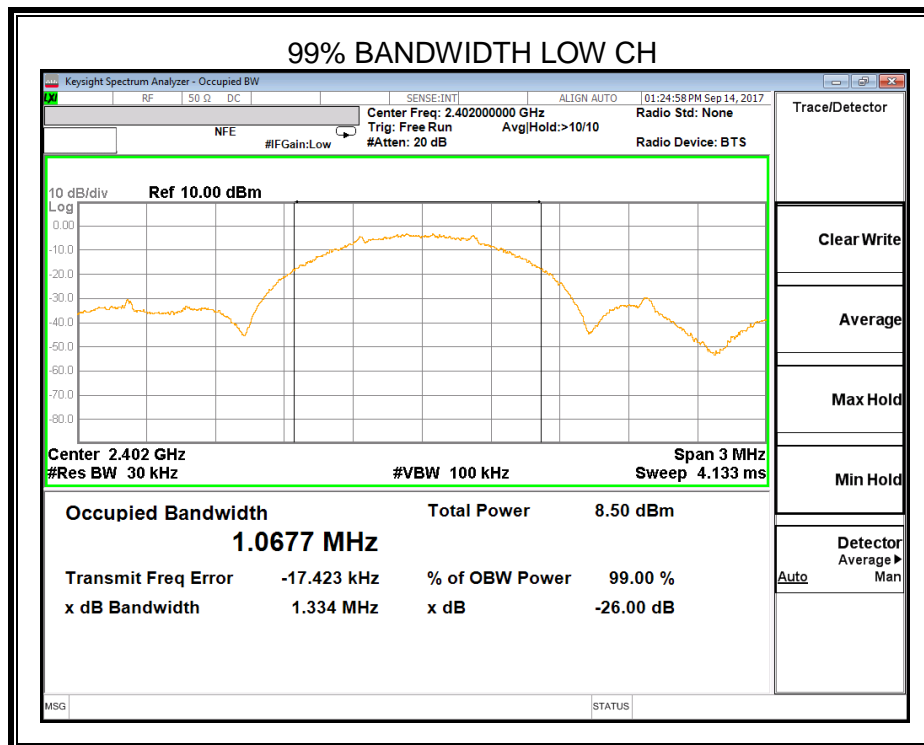

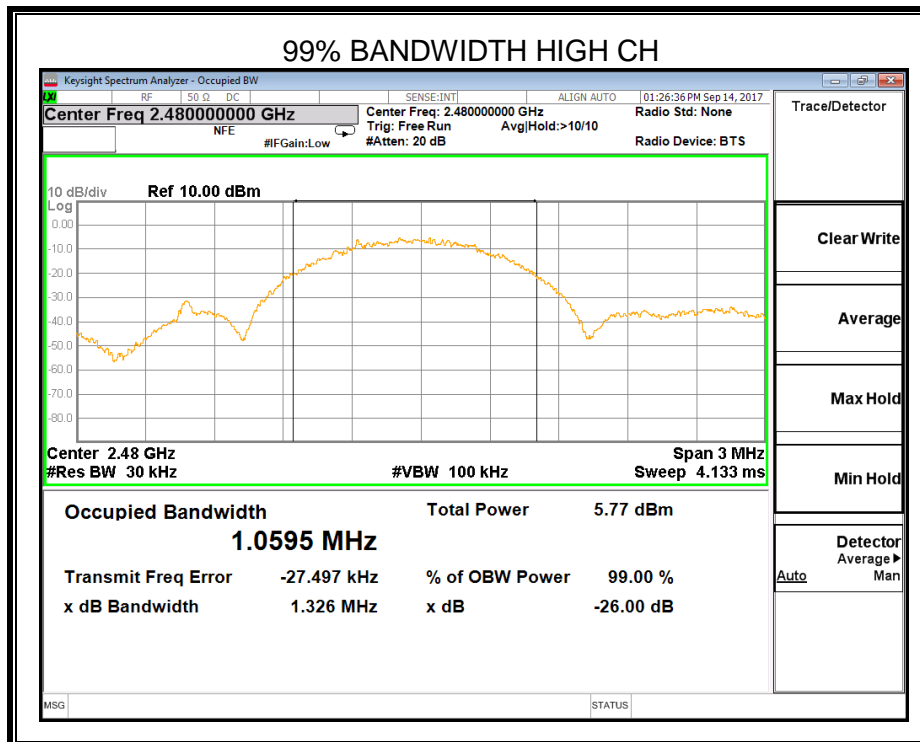
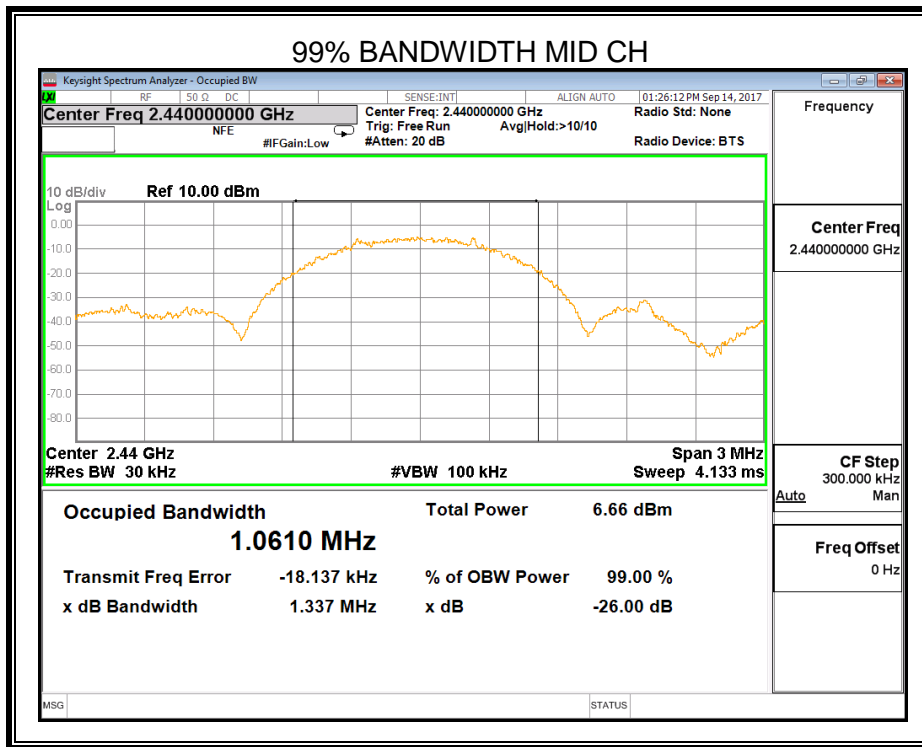

### 7.3. PEAK CONDUCTED OUTPUT POWER

#### LIMITS

FCC Part15 (15.247) , Subpart C			
Section	Test Item	Limit	Frequency Range (MHz)
FCC 15.247(b)(3)	Peak Output Power	1 watt or 30dBm	2400-2483.5

#### TEST PROCEDURE

Place the EUT on the table and set it in the transmitting mode.  
 Remove the antenna from the EUT and then connect a low loss RF cable from the antenna port to the Power sensor.  
 Measure peak power each channel.

#### TEST SETUP

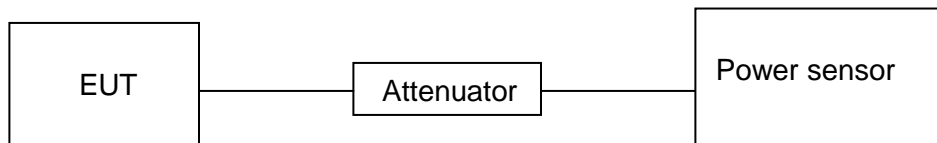

#### RESULTS

Test Channel	Frequency	Maximum Conducted Output Power(PK)	LIMIT
	(MHz)	(dBm)	dBm
CH00	2402	-3.310	30
CH19	2440	-3.180	30
CH39	2480	-2.990	30

## 7.4. POWER SPECTRAL DENSITY

### LIMITS

FCC Part15 (15.247) , Subpart C			
Section	Test Item	Limit	Frequency Range (MHz)
FCC §15.247 (e)	Power Spectral Density	8 dBm in any 3 kHz band	2400-2483.5

### TEST PROCEDURE

Connect the UUT to the spectrum analyser and use the following settings:

Center Frequency	The centre frequency of the channel under test
Detector	Peak
RBW	$3 \text{ kHz} \leq \text{RBW} \leq 100 \text{ kHz}$
VBW	$\geq 3 \times \text{RBW}$
Span	1.5 x DTS bandwidth
Trace	Max hold
Sweep time	Auto couple.

Allow trace to fully stabilize and use the peak marker function to determine the maximum amplitude level within the RBW.

If measured value exceeds limit, reduce RBW (no less than 3 kHz) and repeat.

### TEST SETUP

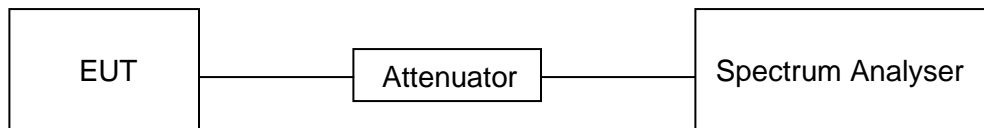

Frequency	Power Spectral Density (dBm/3kHz)	Limit (dBm/3kHz)	Result
2402 MHz	-16.997	8	PASS
2440 MHz	-17.008	8	PASS
2480 MHz	-16.657	8	PASS

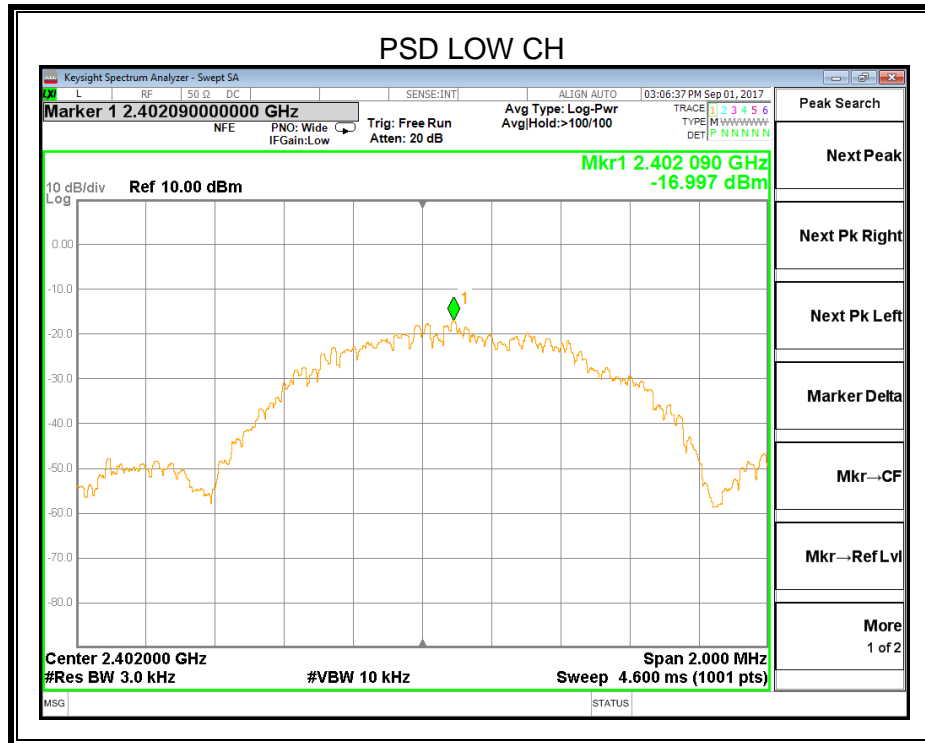

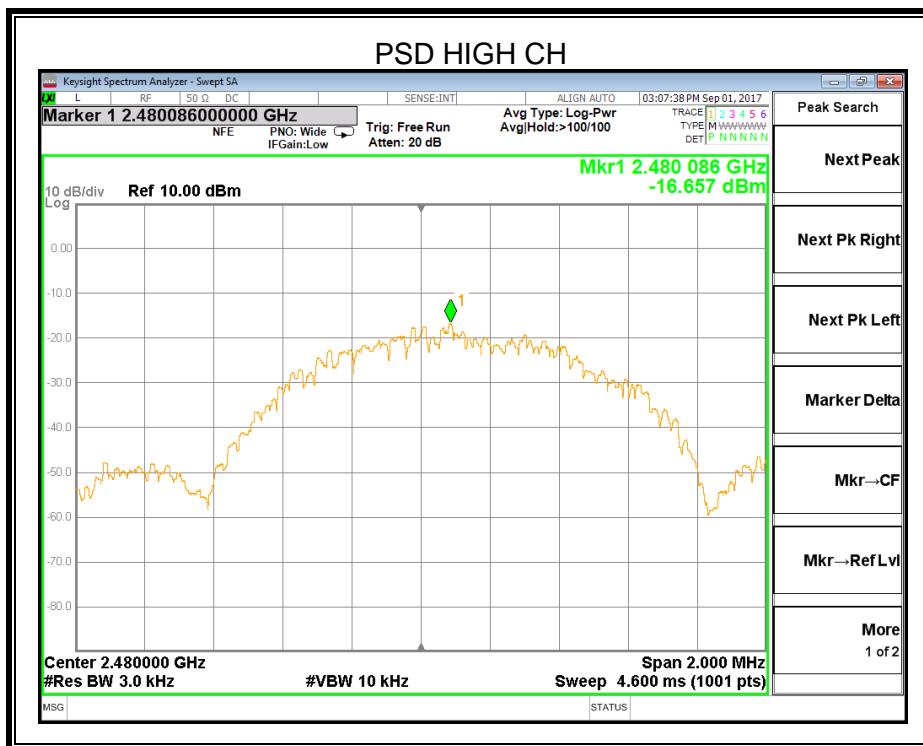
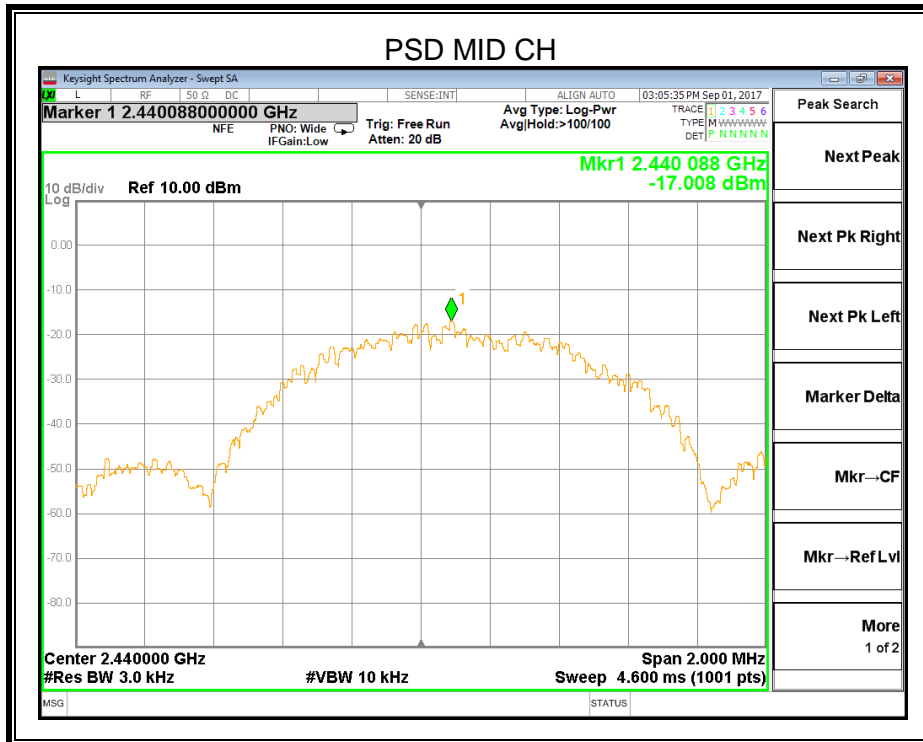

## 7.5. CONDUCTED BANDEGE AND SPURIOUS EMISSIONS

### LIMITS

FCC Part15 (15.247) , Subpart C		
Section	Test Item	Limit
FCC §15.247 (d)	Conducted Bandedge and Spurious Emissions	at least 20 dB below that in the 100 kHz bandwidth within the band that contains the highest level of the desired power

### TEST PROCEDURE

Connect the UUT to the spectrum analyser and use the following settings:

Center Frequency	The center frequency of the channel under test
Detector	Peak
RBW	100K
VBW	$\geq 3 \times \text{RBW}$
Span	1.5 x DTS bandwidth
Trace	Max hold
Sweep time	Auto couple.

Use the peak marker function to determine the maximum PSD level.

Span	Set the center frequency and span to encompass frequency range to be measured
Detector	Peak
RBW	100K
VBW	$\geq 3 \times \text{RBW}$
measurement points	$\geq \text{span}/\text{RBW}$
Trace	Max hold
Sweep time	Auto couple.

Use the peak marker function to determine the maximum amplitude level.

### TEST SETUP

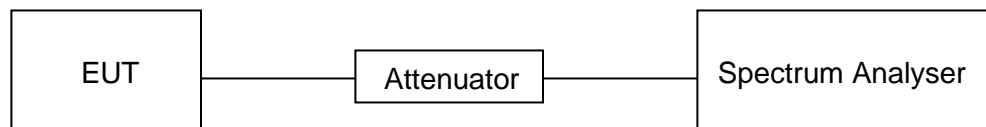



**BANDEDGE RESULTS**

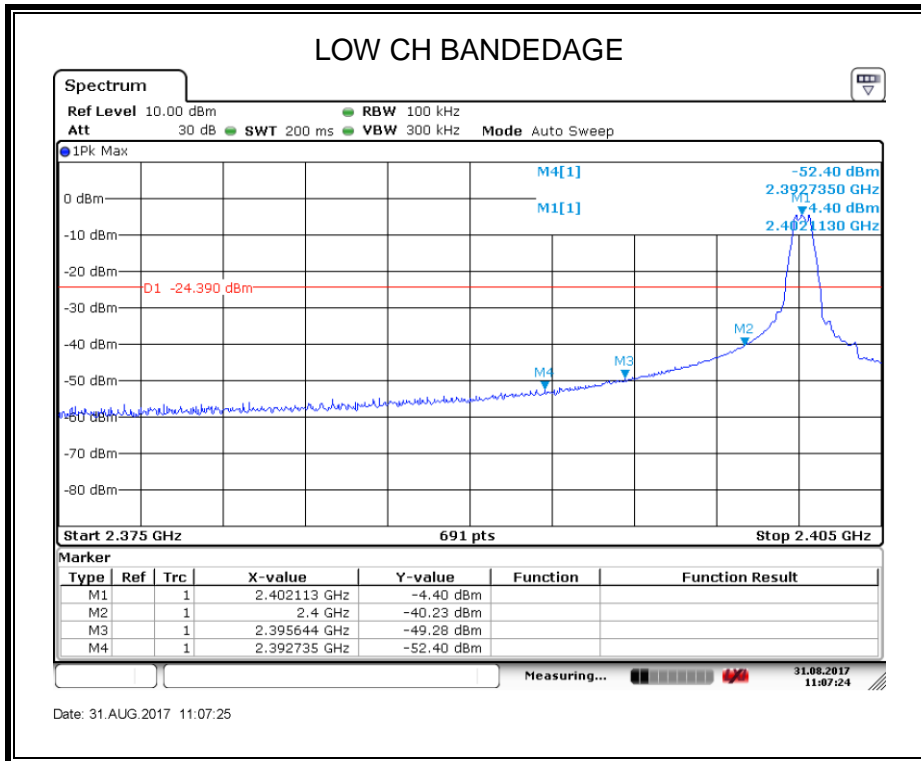
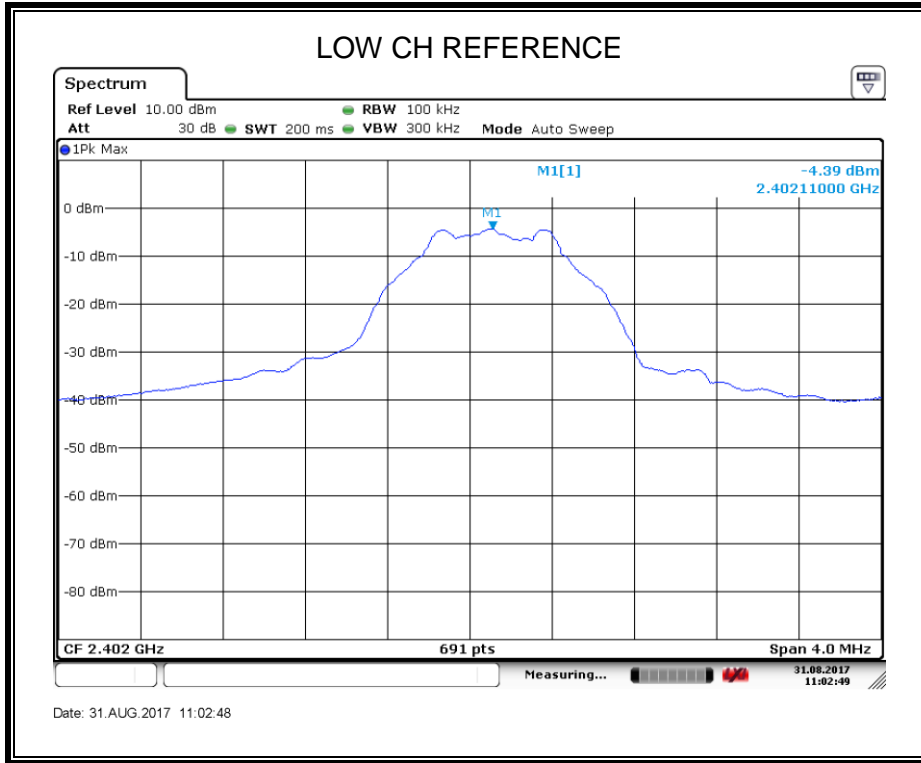

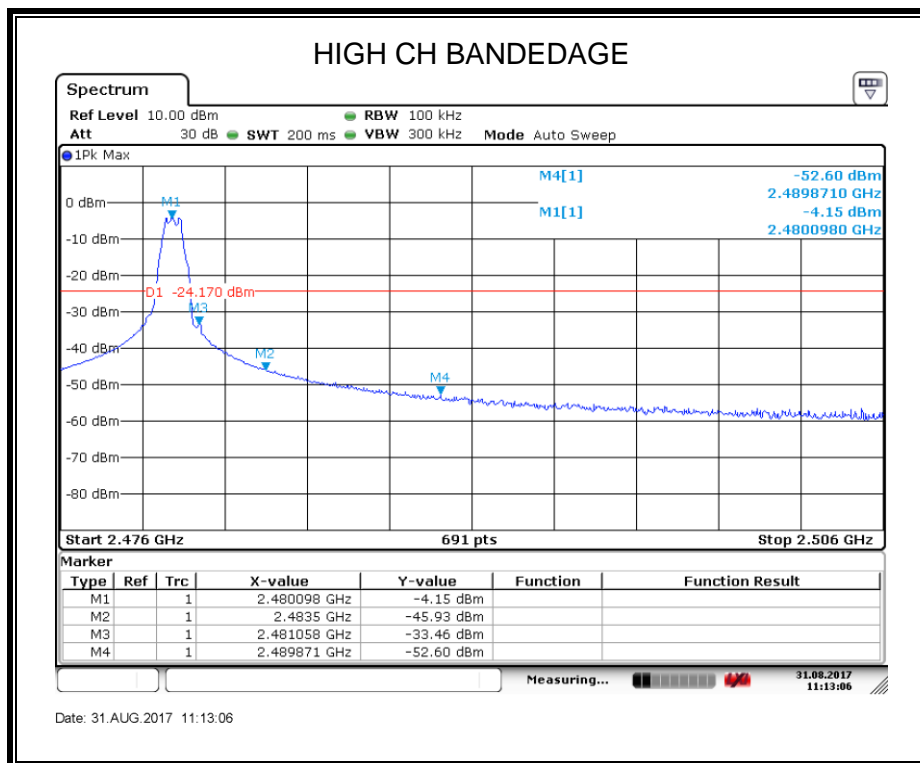
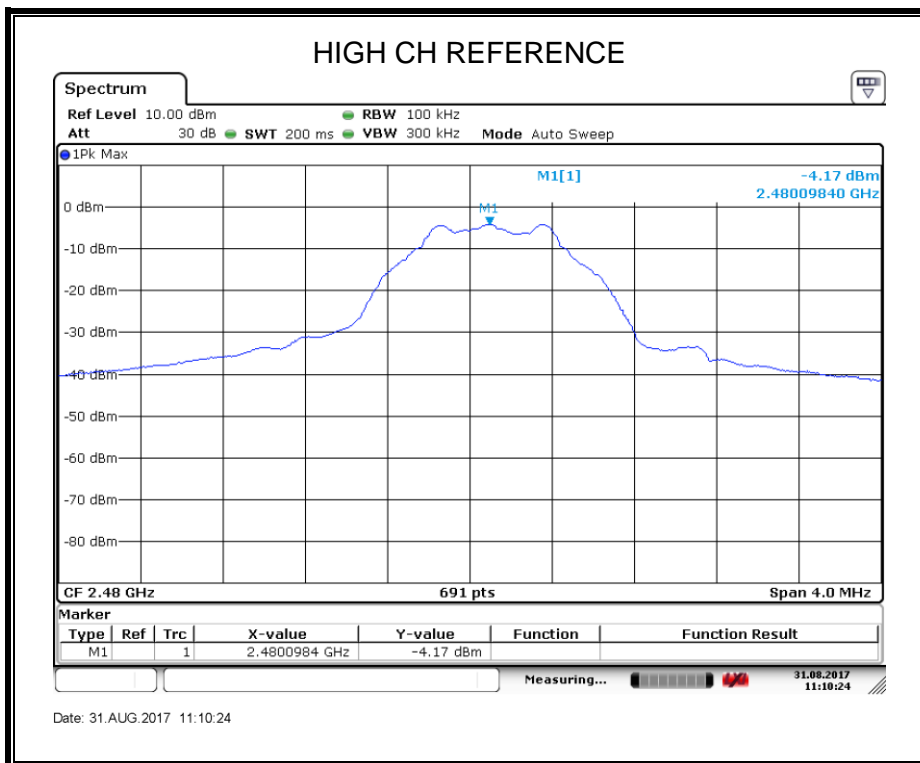

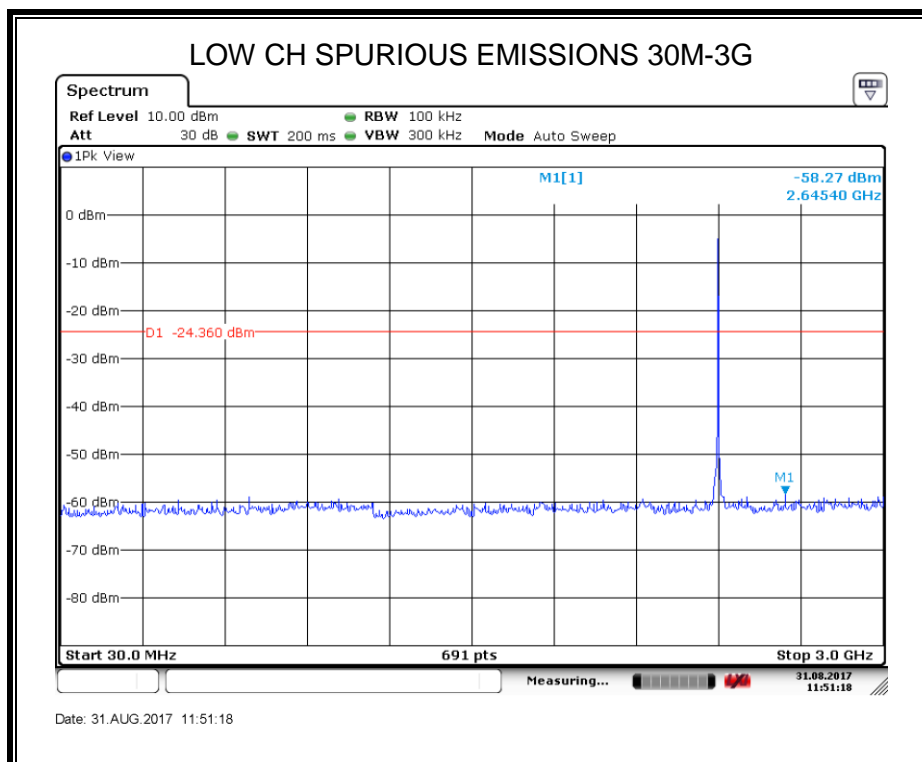
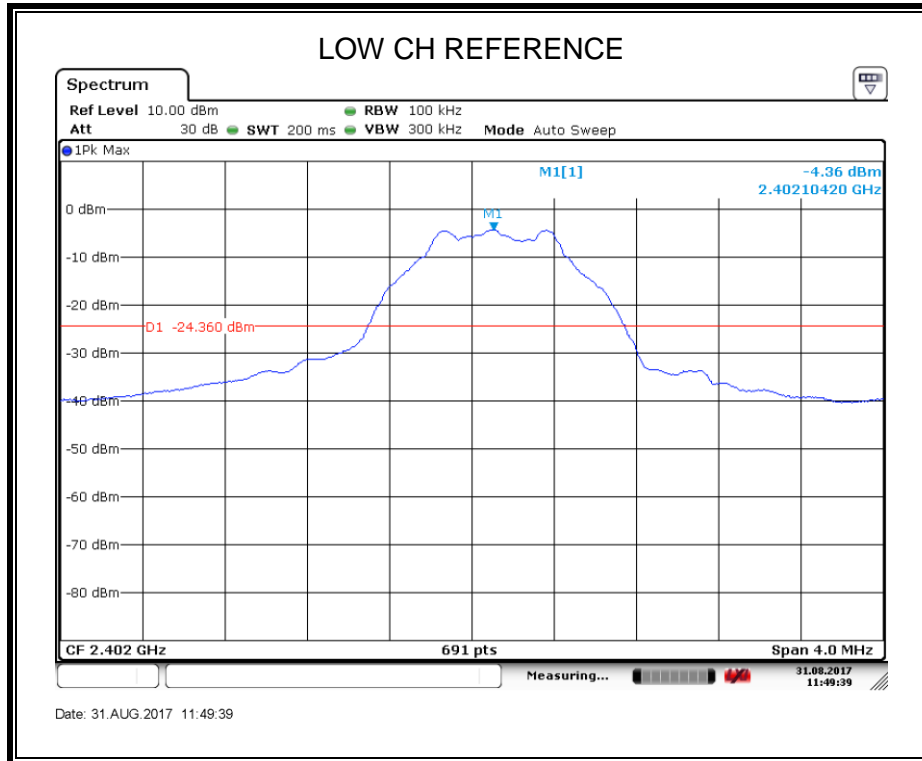

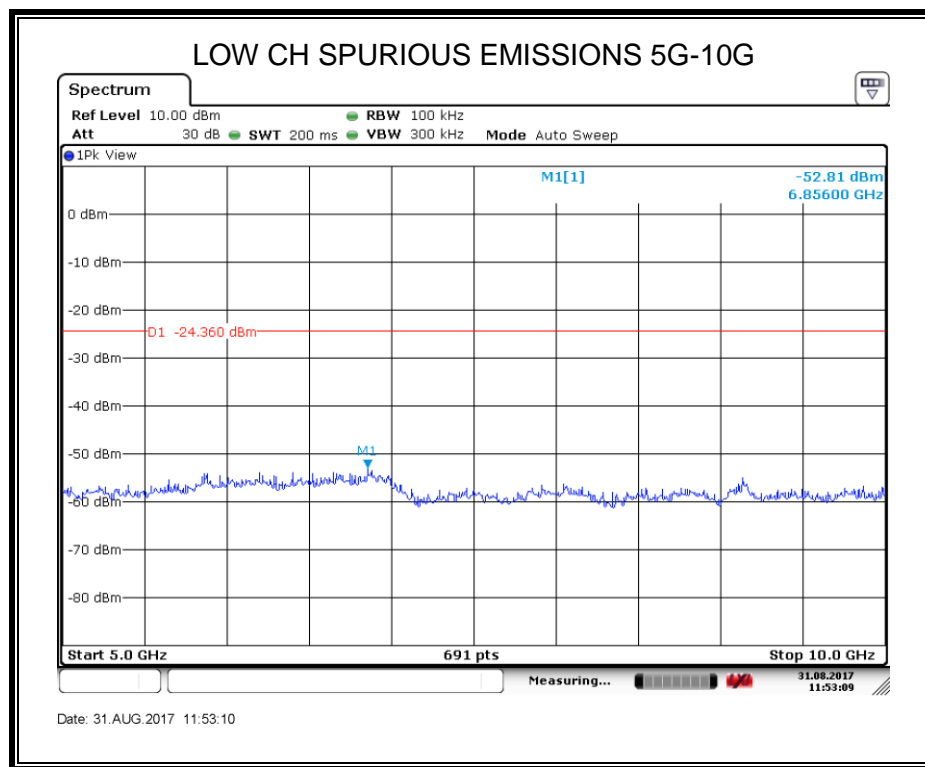
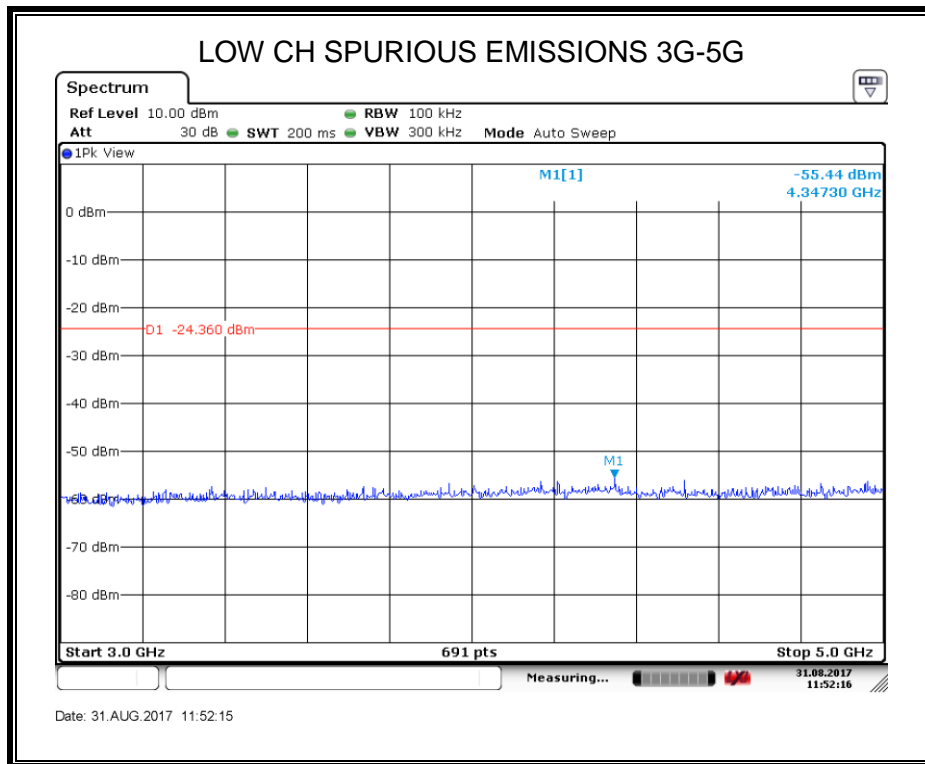

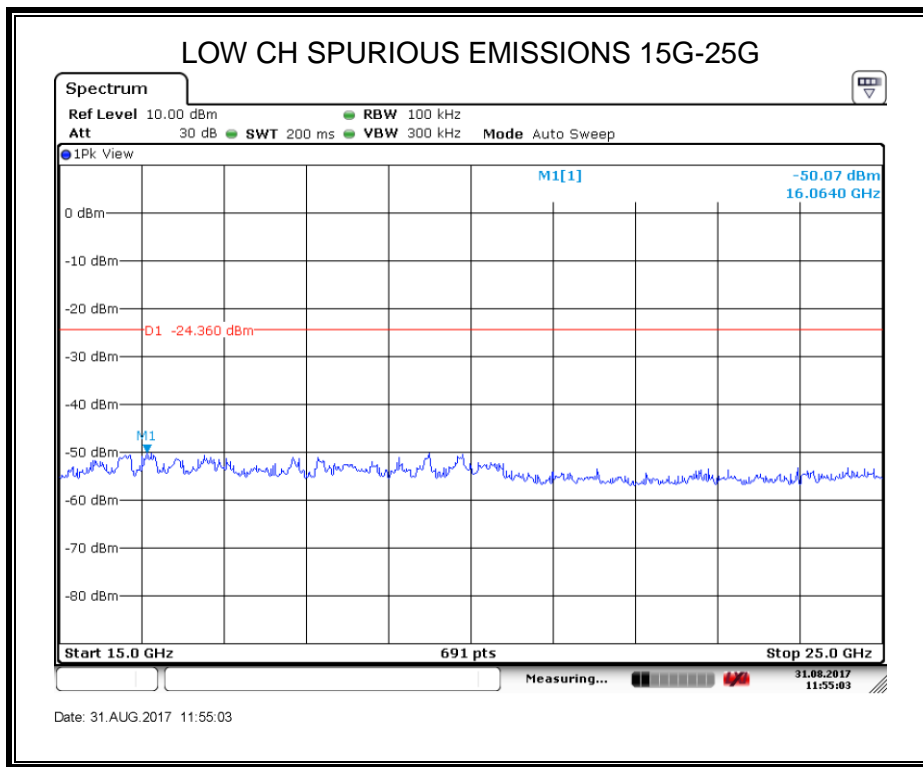
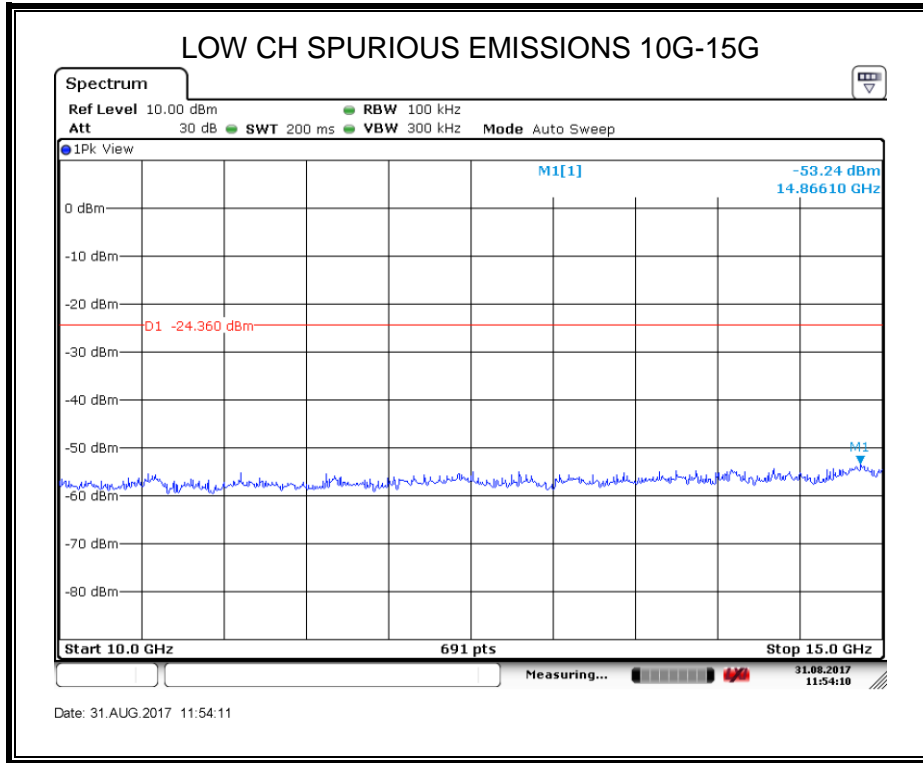

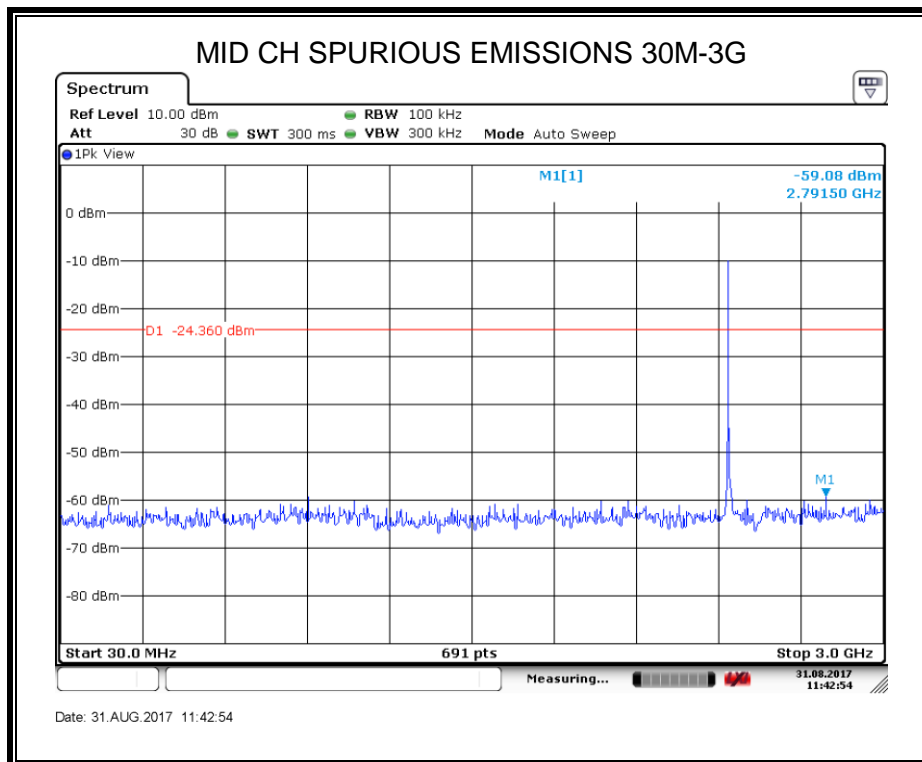
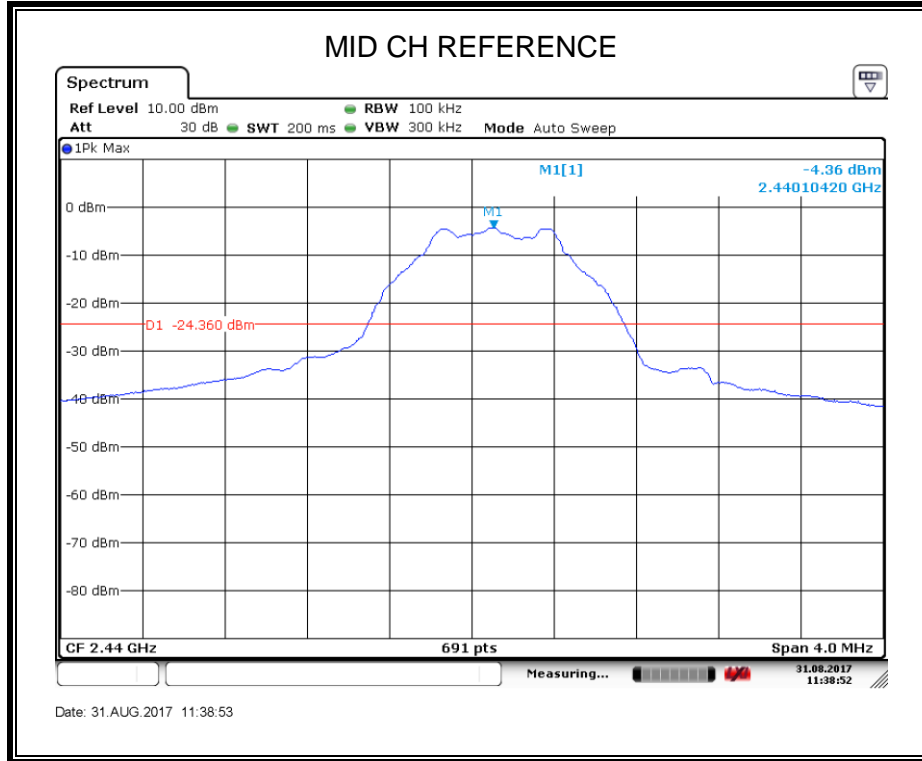

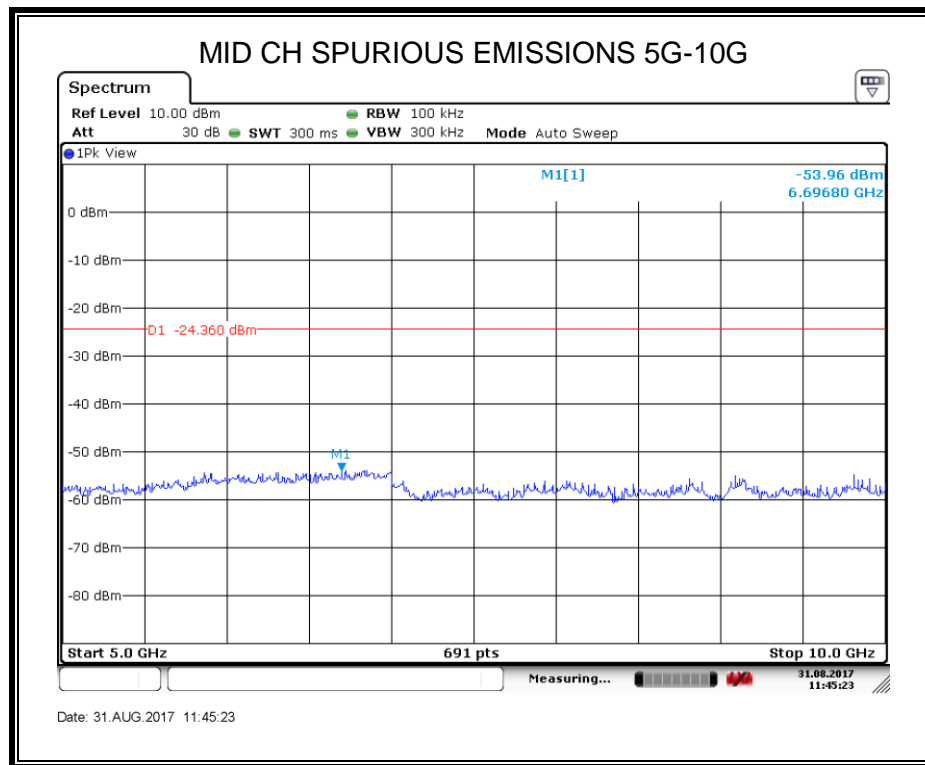
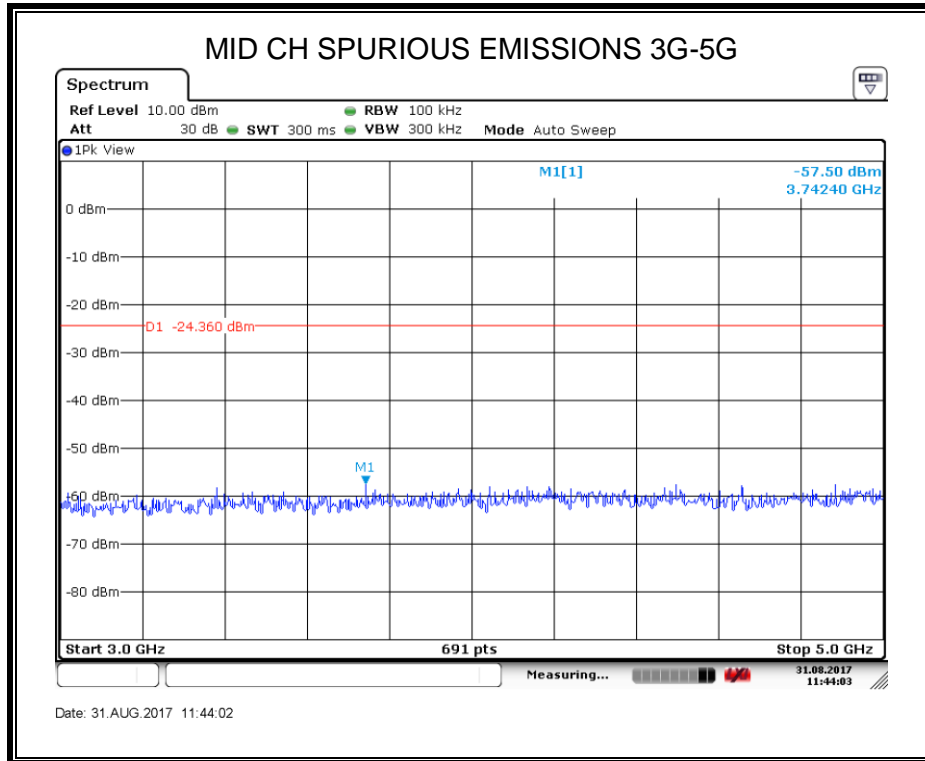

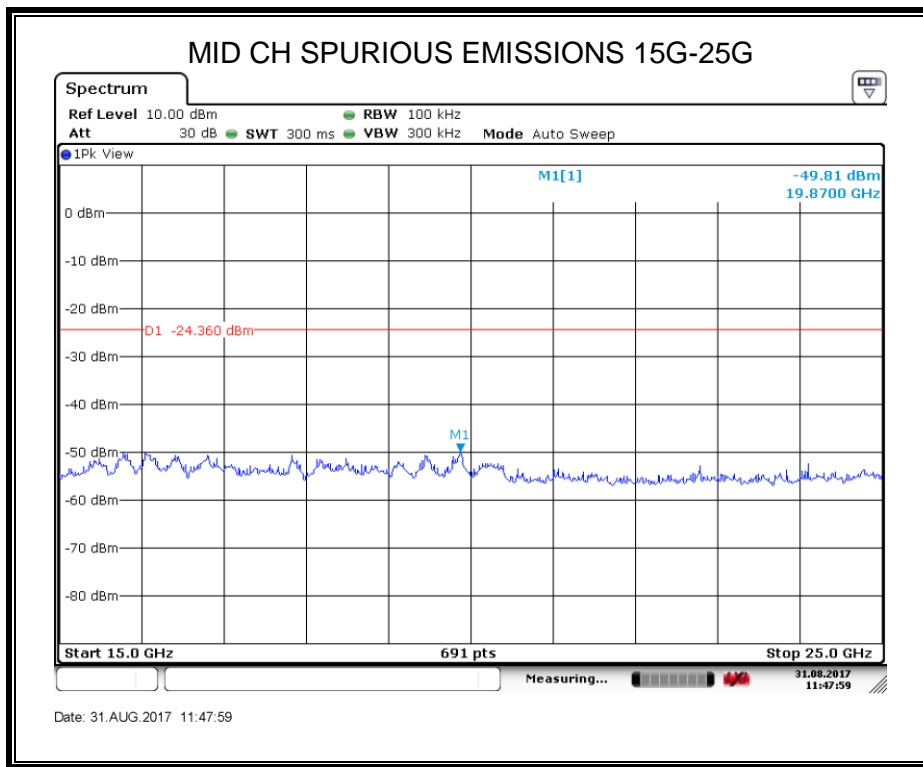
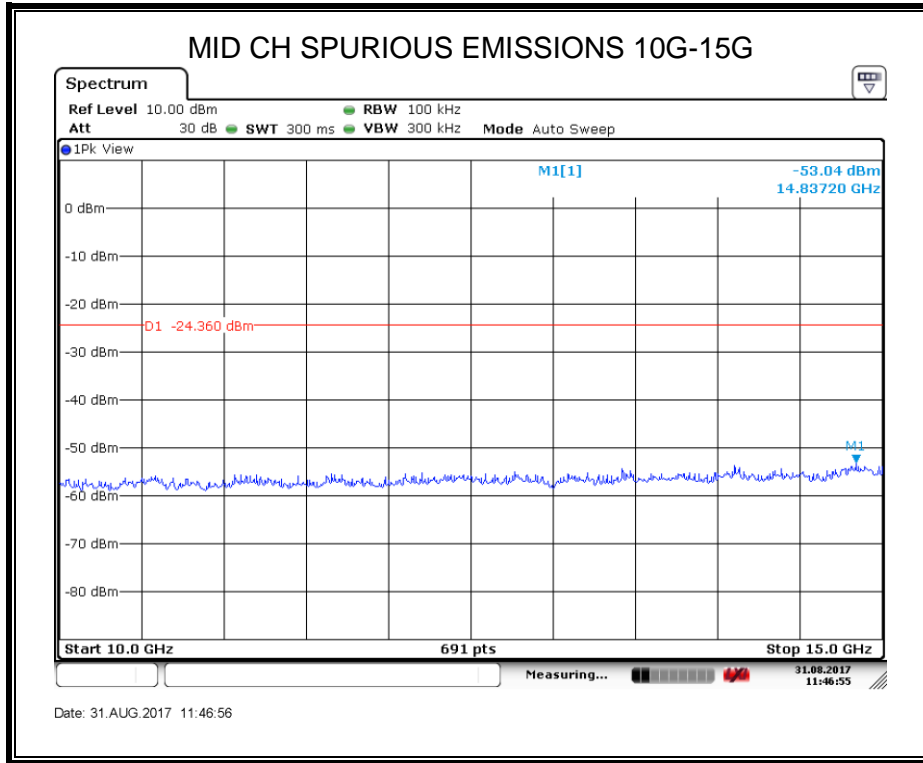



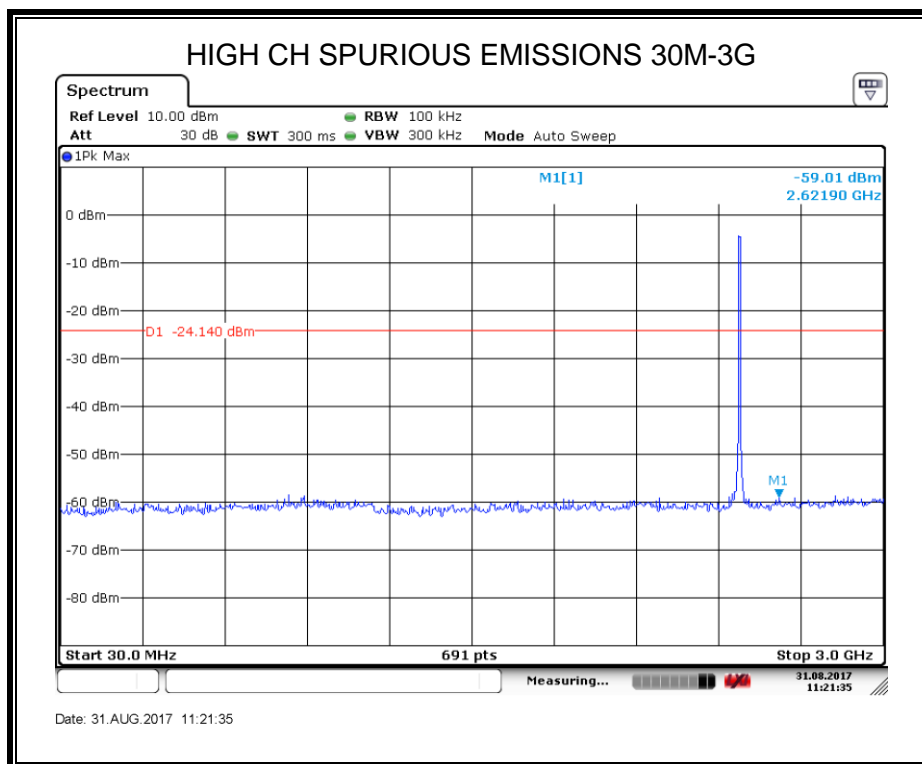
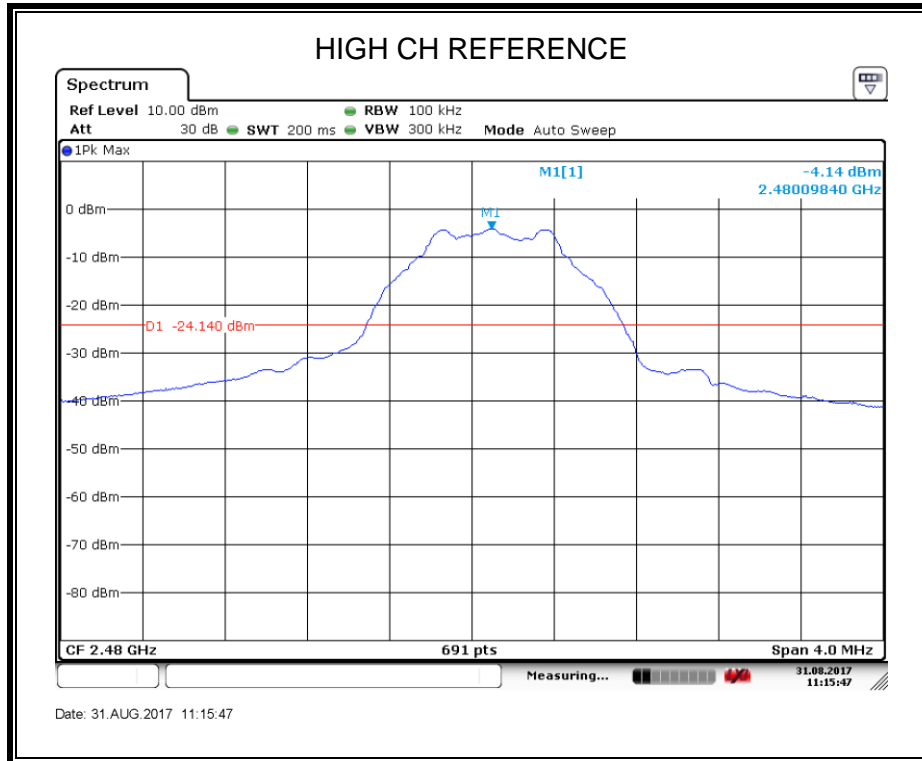

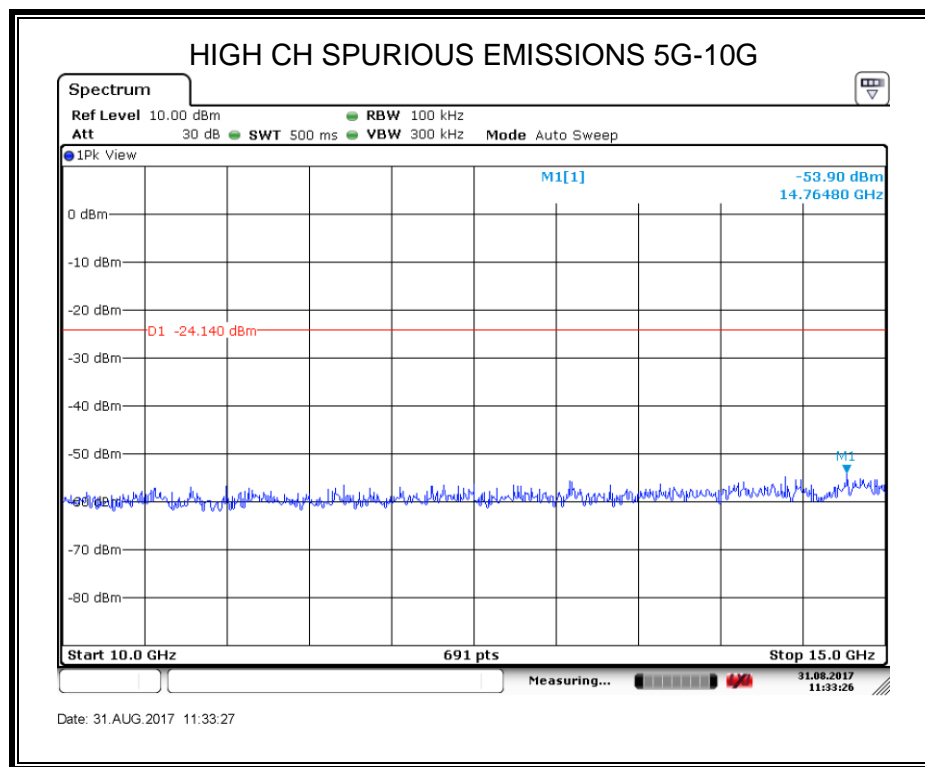
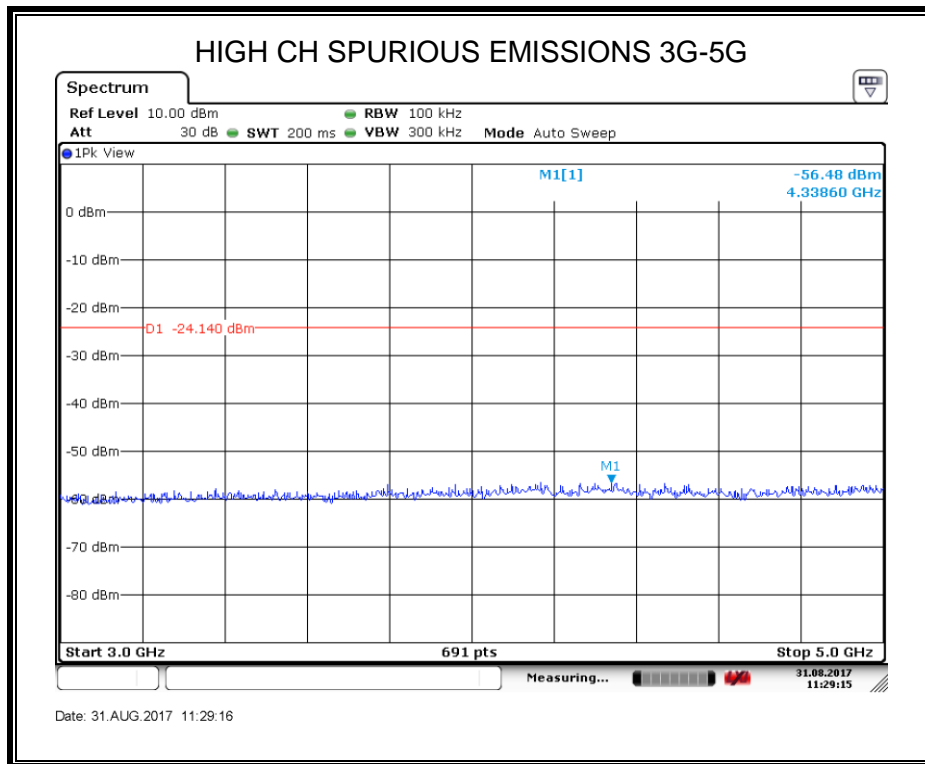

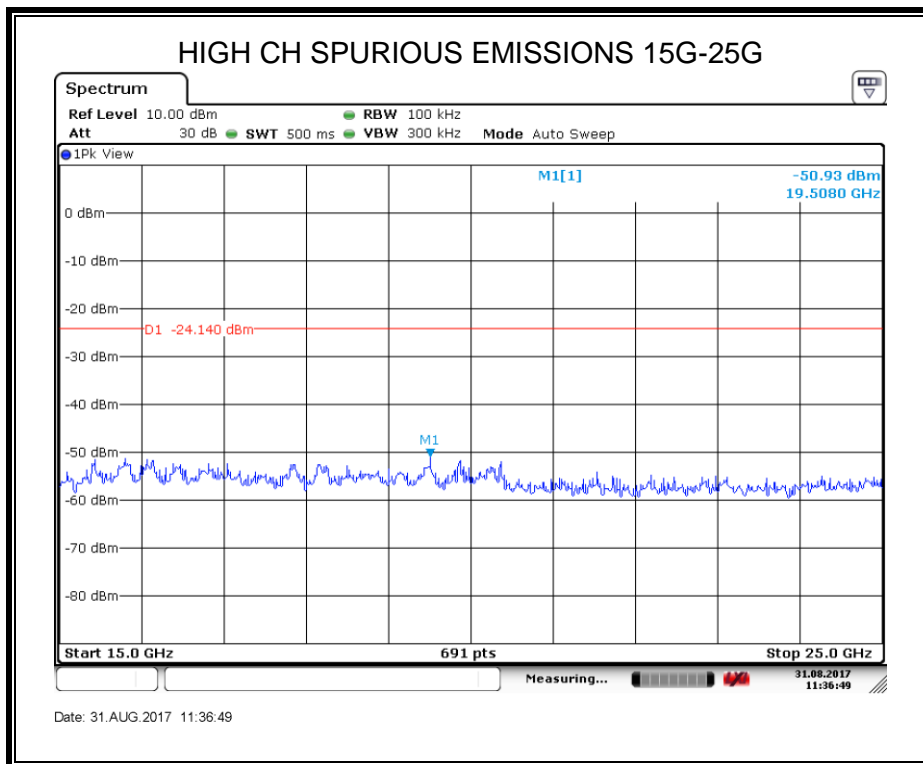
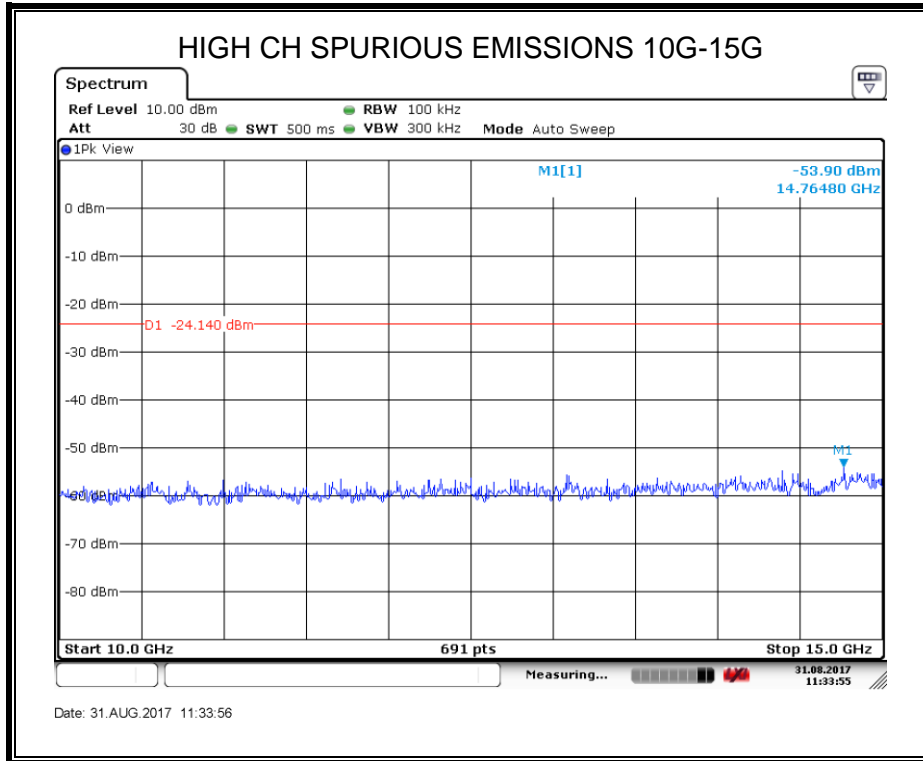

## 8. RADIATED TEST RESULTS

### LIMITS

Please refer to FCC §15.205 and §15.209

Radiation Disturbance Test Limit for FCC (Class B)(9KHz-1GHz)

Frequency (MHz)	Field Strength (microvolts/meter)	Measurement Distance (meters)
0.009~0.490	2400/F(KHz)	300
0.490~1.705	24000/F(KHz)	30
1.705~30.0	30	30
30~88	100	3
88~216	150	3
216~960	200	3
960~1000	500	3

Note: 1) At frequencies at or above 30 MHz, measurements may be performed at a distance other than what is specified provided: measurements are not made in the near field except where it can be shown that near field measurements are appropriate due to the characteristics of the device; and it can be demonstrated that the signal levels needed to be measured at the distance employed can be detected by the measurement equipment. Measurements shall not be performed at a distance greater than 30 meters unless it can be further demonstrated that measurements at a distance of 30 meters or less are impractical. When performing measurements at a distance other than that specified, the results shall be extrapolated to the specified distance using an extrapolation factor of 20 dB/decade (inverse linear-distance for field strength measurements; inverse-linear-distance-squared for power density measurements).

(2) At frequencies below 30 MHz, measurements may be performed at a distance closer than that specified in the regulations; however, an attempt should be made to avoid making measurements in the near field. Pending the development of an appropriate measurement procedure for measurements performed below 30 MHz, when performing measurements at a closer distance than specified, the results shall be extrapolated to the specified distance by either making measurements at a minimum of two distances on at least one radial to determine the proper extrapolation factor or by using the square of an inverse linear distance extrapolation factor (40 dB/decade). This paragraph (f) shall not apply to Access BPL devices operating below 30 MHz.

Radiation Disturbance Test Limit for FCC (Above 1G)

Frequency (MHz)	dB(uV/m) (at 3 meters)	
	Peak	Average
Above 1000	74	54

Restricted bands of operation

MHz	MHz	MHz	GHz
0.090-0.110	16.42-16.423	399.9-410	4.5-5.15
<sup>1</sup> 0.495-0.505	16.69475-16.69525	608-614	5.35-5.46
2.1735-2.1905	16.80425-16.80475	960-1240	7.25-7.75
4.125-4.128	25.5-25.67	1300-1427	8.025-8.5
4.17725-4.17775	37.5-38.25	1435-1626.5	9.0-9.2
4.20725-4.20775	73-74.6	1645.5-1646.5	9.3-9.5
6.215-6.218	74.8-75.2	1660-1710	10.6-12.7
6.26775-6.26825	108-121.94	1718.8-1722.2	13.25-13.4
6.31175-6.31225	123-138	2200-2300	14.47-14.5
8.291-8.294	149.9-150.05	2310-2390	15.35-16.2
8.362-8.366	156.52475-156.52525	2483.5-2500	17.7-21.4
8.37625-8.38675	156.7-156.9	2690-2900	22.01-23.12
8.41425-8.41475	162.0125-167.17	3260-3267	23.6-24.0
12.29-12.293	167.72-173.2	3332-3339	31.2-31.8
12.51975-12.52025	240-285	3345.8-3358	36.43-36.5
12.57675-12.57725	322-335.4	3600-4400	( <sup>2</sup> )
13.36-13.41			

Note: <sup>1</sup>Until February 1, 1999, this restricted band shall be 0.490-0.510 MHz.  
<sup>2</sup>Above 38.6c

Below 30MHz

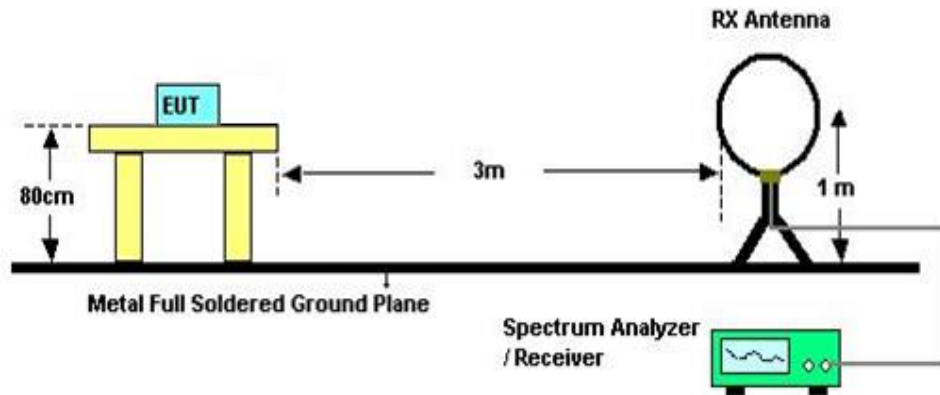

The setting of the spectrum analyser

RBW	200Hz (From 9kHz to 0.15MHz)/ 9KHz (From 0.15MHz to 30MHz)
VBW	200Hz (From 9kHz to 0.15MHz)/ 9KHz (From 0.15MHz to 30MHz)
Sweep	Auto
Detector	Peak/QP/ Average
Trace	Max hold

1. The testing follows the guidelines in ANSI C63.10-2013
2. The EUT was arranged to its worst case and then turntable (from 0 degree to 360 degrees) to find the maximum reading. A pre-amp and a high pass filter are used for the test in order to get better signal level. Both horizontal and vertical polarizations of the antenna are set to make the measurement.
3. The EUT was placed on a turntable with 0.8 meter above ground.
4. The EUT was set 3 meters from the interference receiving antenna, which was mounted on the top of a variable height antenna tower.
5. For measurement below 1GHz, the initial step in collecting conducted emission data is a spectrum analyzer peak detector mode pre-scanning the measurement frequency range. Significant peaks are then marked and then Quasi Peak detector mode re-measured. If the emission level of the EUT measured by the peak detector is 3 dB lower than the applicable limit, the peak emission level will be reported. Otherwise, the emission measurement will be repeated using the quasi-peak detector and reported.
6. For the actual test configuration, please refer to the related item in this test report (Photographs of the Test Configuration)

Below 1G and above 30MHz

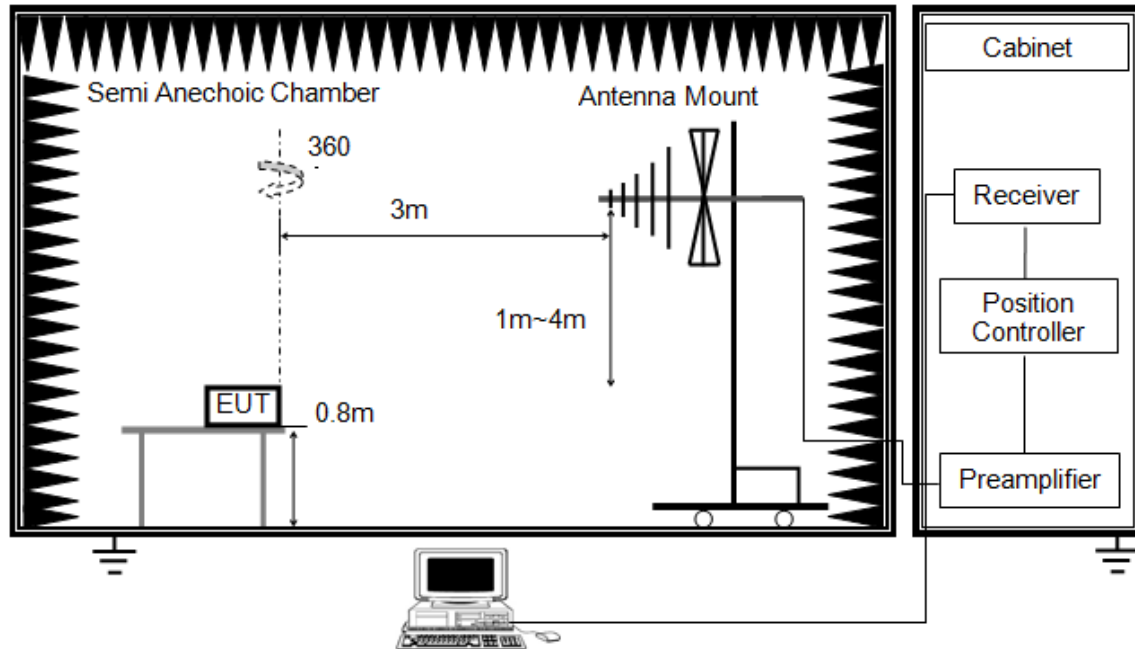

The setting of the spectrum analyser

RBW	120K
VBW	300K
Sweep	Auto
Detector	Peak/QP
Trace	Max hold

1. The testing follows the guidelines in ANSI C63.10-2013.
2. The EUT was arranged to its worst case and then tune the antenna tower (from 1 m to 4 m) and turntable (from 0 degree to 360 degrees) to find the maximum reading. A pre-amp and a high pass filter are used for the test in order to get better signal level. Both horizontal and vertical polarizations of the antenna are set to make the measurement.
3. The EUT was placed on a turntable with 0.8 meter above ground.
4. The EUT was set 3 meters from the interference receiving antenna, which was mounted on the top of a variable height antenna tower.
5. For measurement below 1GHz, the initial step in collecting conducted emission data is a spectrum analyzer peak detector mode pre-scanning the measurement frequency range. Significant peaks are then marked and then Quasi Peak detector mode re-measured. If the emission level of the EUT measured by the peak detector is 3 dB lower than the applicable limit, the peak emission level will be reported. Otherwise, the emission measurement will be repeated using the quasi-peak detector and reported.
6. For the actual test configuration, please refer to the related Item in this test report (Photographs of the Test Configuration)

ABOVE 1G

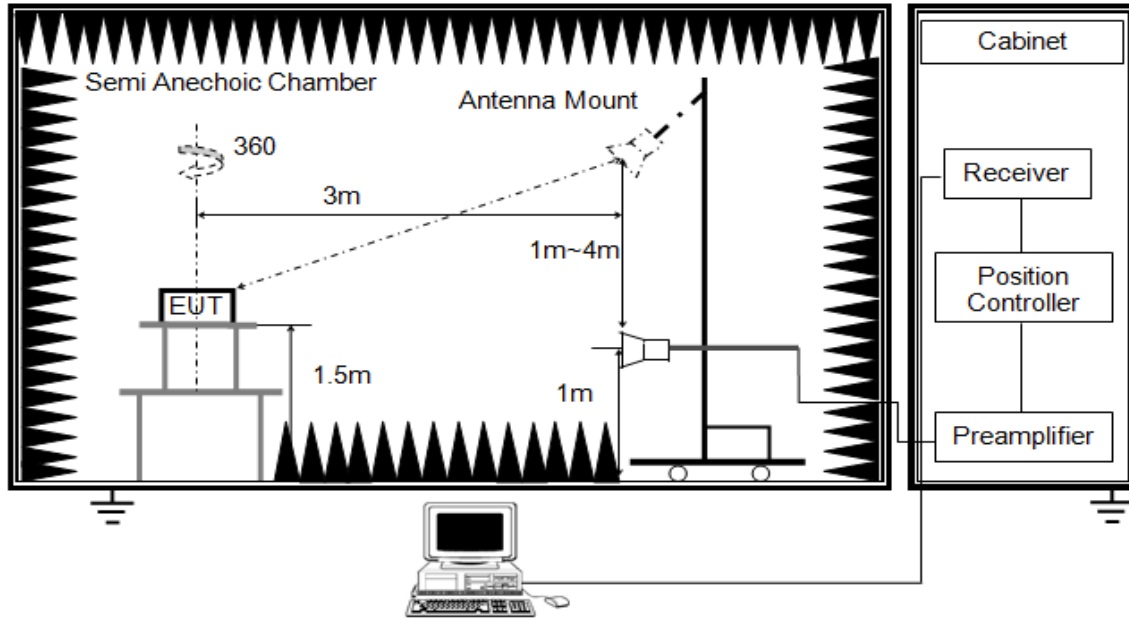

The setting of the spectrum analyser

RBW	1M MHz
VBW	PEAK: 3M AVG: see note 5
Sweep	Auto
Detector	Peak
Trace	Max hold

1. The testing follows the guidelines in ANSI C63.10-2013.
2. The EUT was arranged to its worst case and then tune the antenna tower (1.5 m) and turntable (from 0 degree to 360 degrees) to find the maximum reading. A pre-amp and a high pass filter are used for the test in order to get better signal level. Both horizontal and vertical polarizations of the antenna are set to make the measurement.
3. The EUT was placed on a turntable with 1.5m above ground.
4. The EUT was set 3 meters from the interference receiving antenna, which was mounted on the top of a variable height antenna tower.
5. For measurements above 1 GHz the resolution bandwidth is set to 1 MHz, then the video bandwidth is set to 3 MHz for peak measurements and 1 MHz resolution bandwidth with 1/T video bandwidth with peak detector for average measurements.
6. For the actual test configuration, please refer to the related Item in this test report (Photographs of the Test Configuration)



X axis, Y axis, Z axis positions:

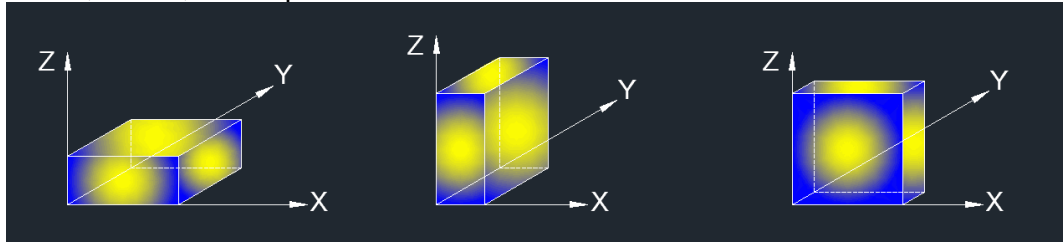

Note: For all radiated test, EUT in each of three orthogonal axis emissions had been tested, but only the worst case (X axis) data recorded in the report.

## 8.1. RESTRICTED BANDEDGE

### RESTRICTED BANDEDGE (LOW CHANNEL, HORIZONTAL)

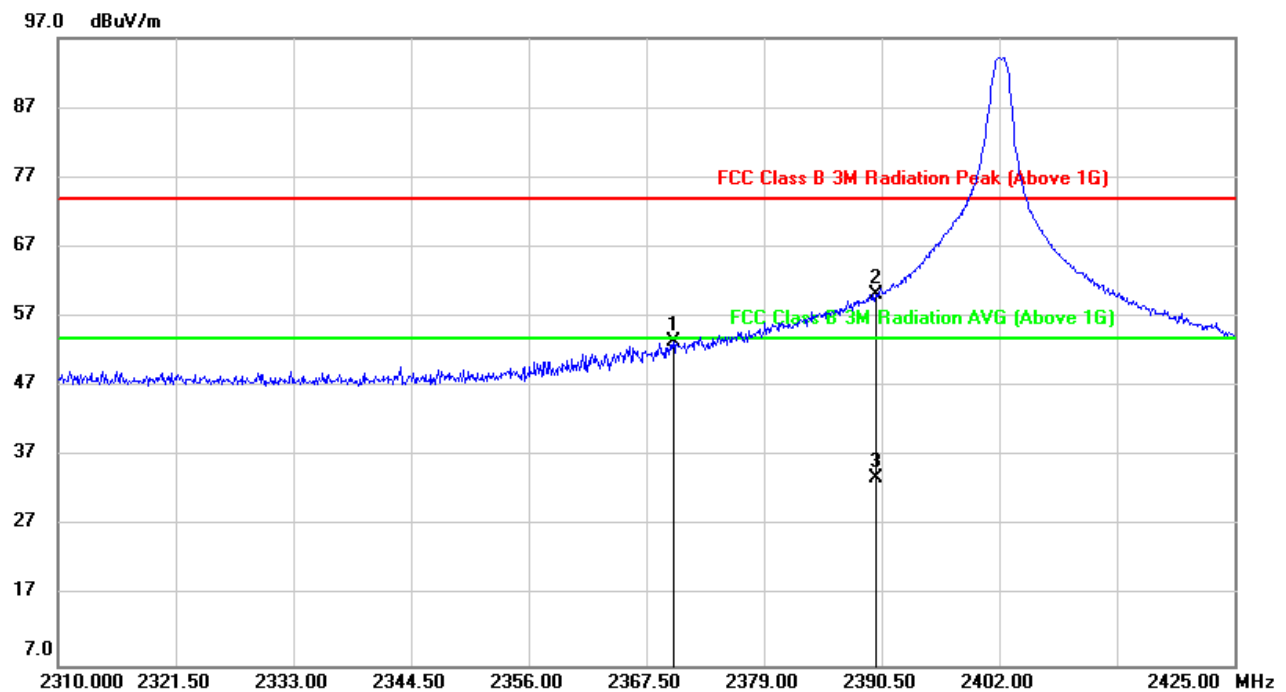

No.	Frequency (MHz)	Reading (dBuV/m)	Correct (dB/m)	Result (dBuV/m)	Limit (dBuV/m)	Margin (dB)	Remark
1	2370.145	20.20	33.29	53.49	74.00	-20.51	peak
2	2390.000	27.11	33.14	60.25	74.00	-13.75	peak
3	2390.000	0.77	33.14	33.91	54.00	-20.09	AVG

- Note: 1. Measurement = Reading Level + Correct Factor.  
 2. If Peak Result complies with AV limit, AV Result is deemed to comply with AV limit.  
 3. Peak: Peak detector.  
 4. AVG:  $VBW=1/Ton$  where: ton is transmit duration.  
 5. For transmit duration, please refer to clause 7.1.

**RESTRICTED BANDEDGE (LOW CHANNEL, VERTICAL)**

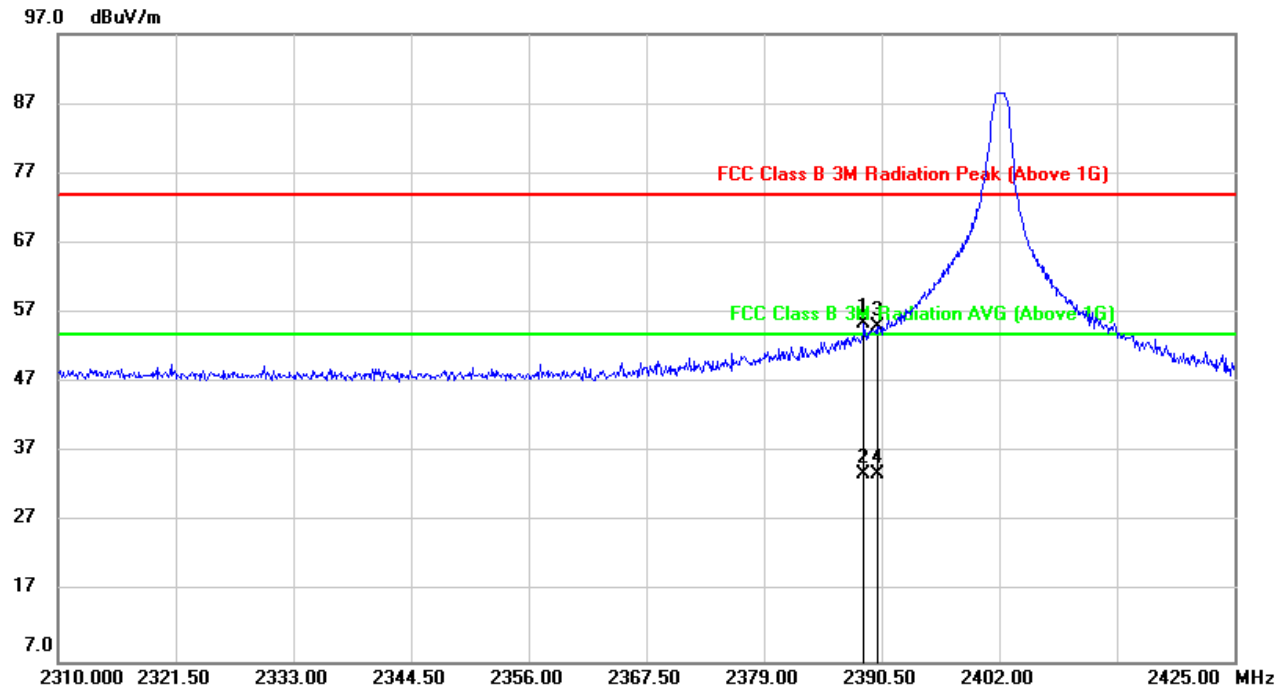

No.	Frequency (MHz)	Reading (dBuV/m)	Correct (dB/m)	Result (dBuV/m)	Limit (dBuV/m)	Margin (dB)	Remark
1	2388.775	22.14	33.25	55.39	74.00	-18.61	peak
2	2388.775	0.72	33.25	33.97	54.00	-20.03	AVG
3	2390.000	21.83	33.24	55.07	74.00	-18.93	peak
4	2390.000	0.75	33.24	33.99	54.00	-20.01	AVG

- Note: 1. Measurement = Reading Level + Correct Factor.  
 2. If Peak Result complies with AV limit, AV Result is deemed to comply with AV limit.  
 3. Peak: Peak detector.  
 4. AVG: VBW=1/Ton where: ton is transmit duration.  
 5. For transmit duration, please refer to clause 7.1.

**RESTRICTED BANDEDGE (HIGH CHANNEL, HORIZONTAL)**

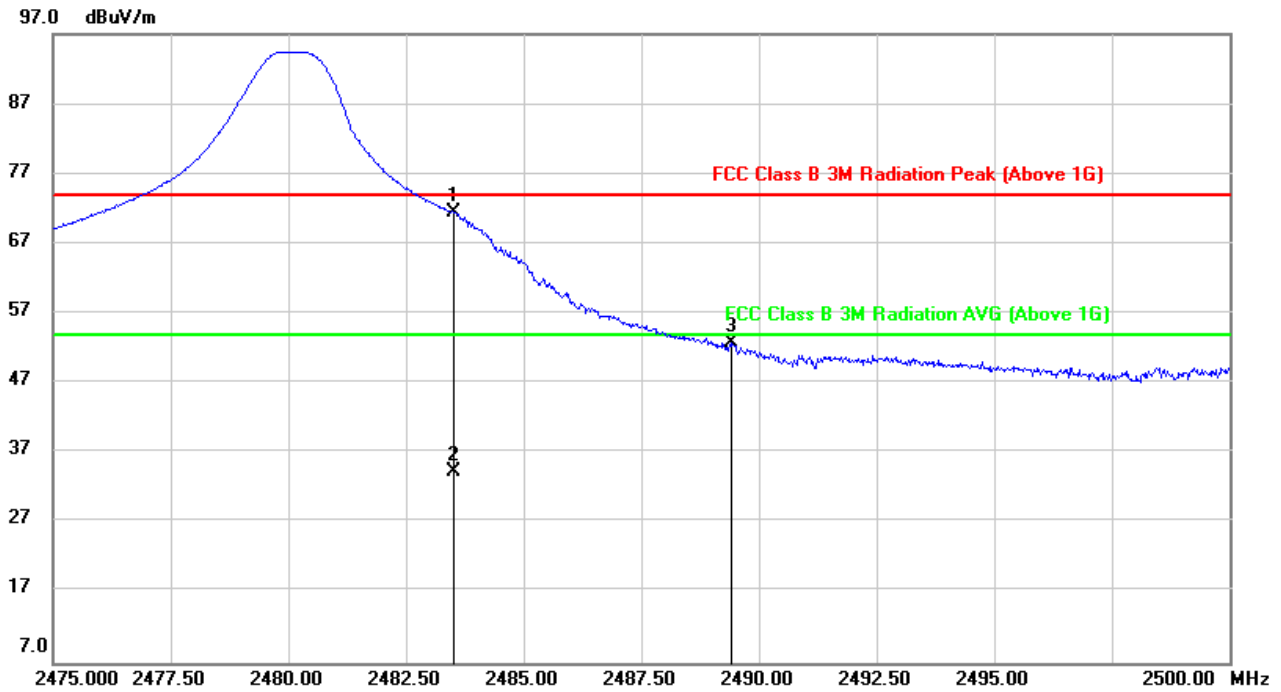

No.	Frequency (MHz)	Reading (dBuV/m)	Correct dB/m	Result (dBuV/m)	Limit (dBuV/m)	Margin (dB)	Remark
1	2483.500	38.72	32.78	71.50	74.00	-2.50	peak
2	2483.500	1.48	32.78	34.26	54.00	-19.74	AVG
3	2489.400	19.94	32.78	52.72	74.00	-21.28	peak

- Note: 1. Measurement = Reading Level + Correct Factor.  
 2. If Peak Result complies with AV limit, AV Result is deemed to comply with AV limit.  
 3. Peak: Peak detector.  
 4. AVG: VBW=1/Ton where: ton is transmit duration.  
 5. For transmit duration, please refer to clause 7.1.

**RESTRICTED BANDEDGE (HIGH CHANNEL, VERTICAL)**

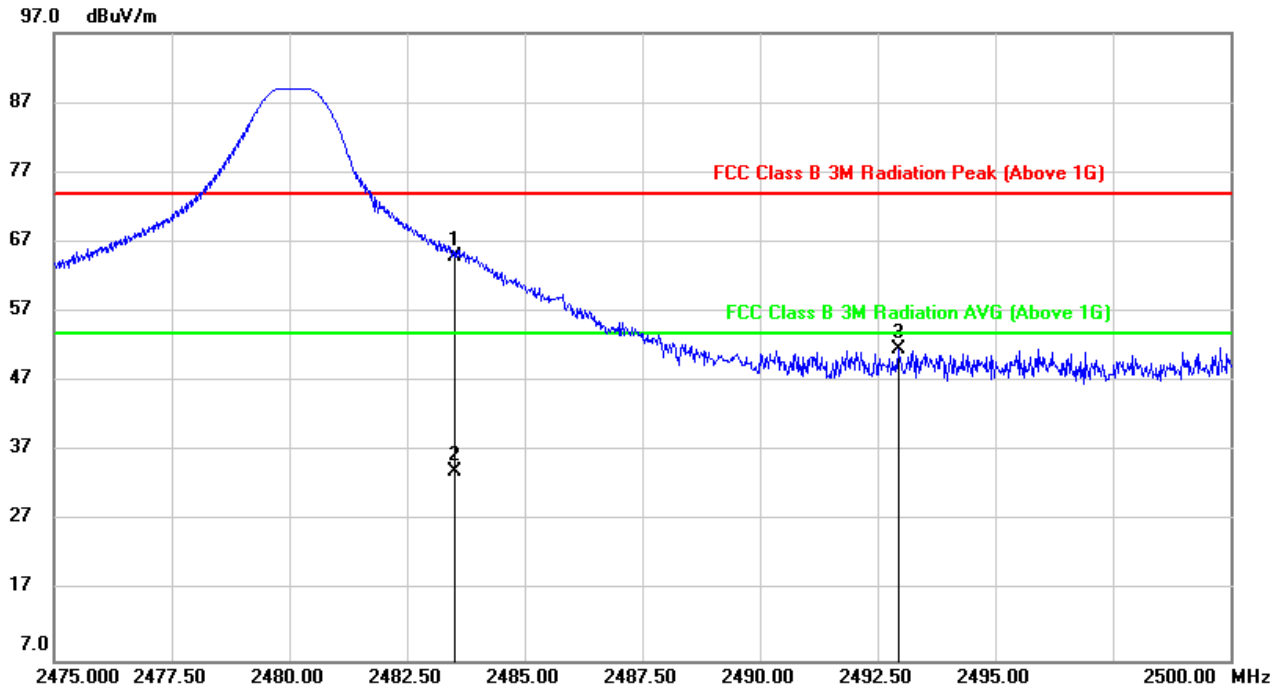

No.	Frequency (MHz)	Reading (dBuV/m)	Correct (dB/m)	Result (dBuV/m)	Limit (dBuV/m)	Margin (dB)	Remark
1	2483.500	32.04	32.88	64.92	74.00	-9.08	peak
2	2483.500	1.27	32.88	34.15	54.00	-19.85	AVG
3	2492.950	18.84	32.87	51.71	74.00	-22.29	peak

- Note: 1. Measurement = Reading Level + Correct Factor.  
 2. If Peak Result complies with AV limit, AV Result is deemed to comply with AV limit.  
 3. Peak: Peak detector.  
 4. AVG: VBW=1/Ton where: ton is transmit duration  
 5. For transmit duration, please refer to clause 7.1.

## 8.2. SPURIOUS EMISSIONS 1~18GHz

### HARMONICS AND SPURIOUS EMISSIONS (LOW CHANNEL, HORIZONTAL)

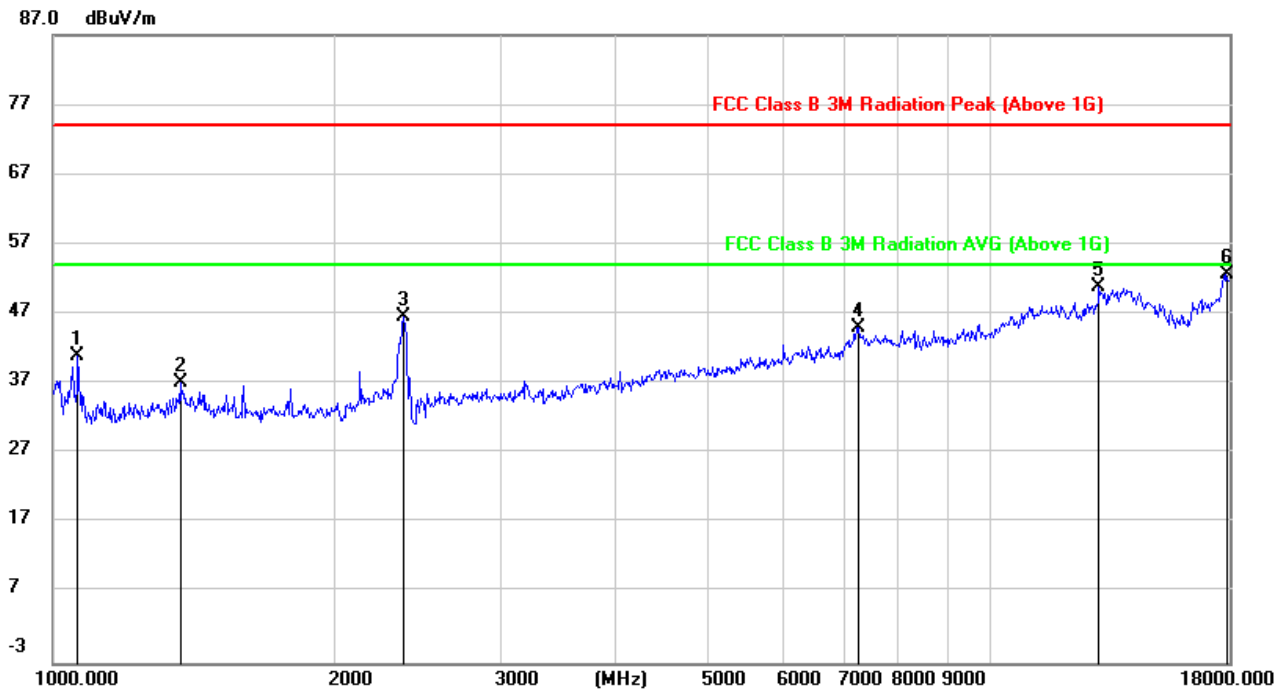

No.	Frequency (MHz)	Reading (dBuV/m)	Correct dB/m	Result (dBuV/m)	Limit (dBuV/m)	Margin (dB)	Remark
1	1062.578	54.97	-14.07	40.90	74.00	-33.10	peak
2	1366.373	49.94	-12.72	37.22	74.00	-36.78	peak
3	2366.308	55.30	-8.77	46.53	74.00	-27.47	peak
4	7242.052	39.16	5.93	45.09	74.00	-28.91	peak
5	13059.822	33.71	17.08	50.79	74.00	-23.21	peak
6	17896.247	26.95	25.75	52.70	74.00	-21.30	peak

- Note: 1. Measurement = Reading Level + Correct Factor.  
 2. If Peak Result complies with AV limit, AV Result is deemed to comply with AV limit.  
 3. Peak: Peak detector.  
 4. AVG: VBW=1/Ton where: ton is transmit duration.  
 5. For transmit duration, please refer to clause 7.1.

**HARMONICS AND SPURIOUS EMISSIONS (LOW CHANNEL, VERTICAL)**

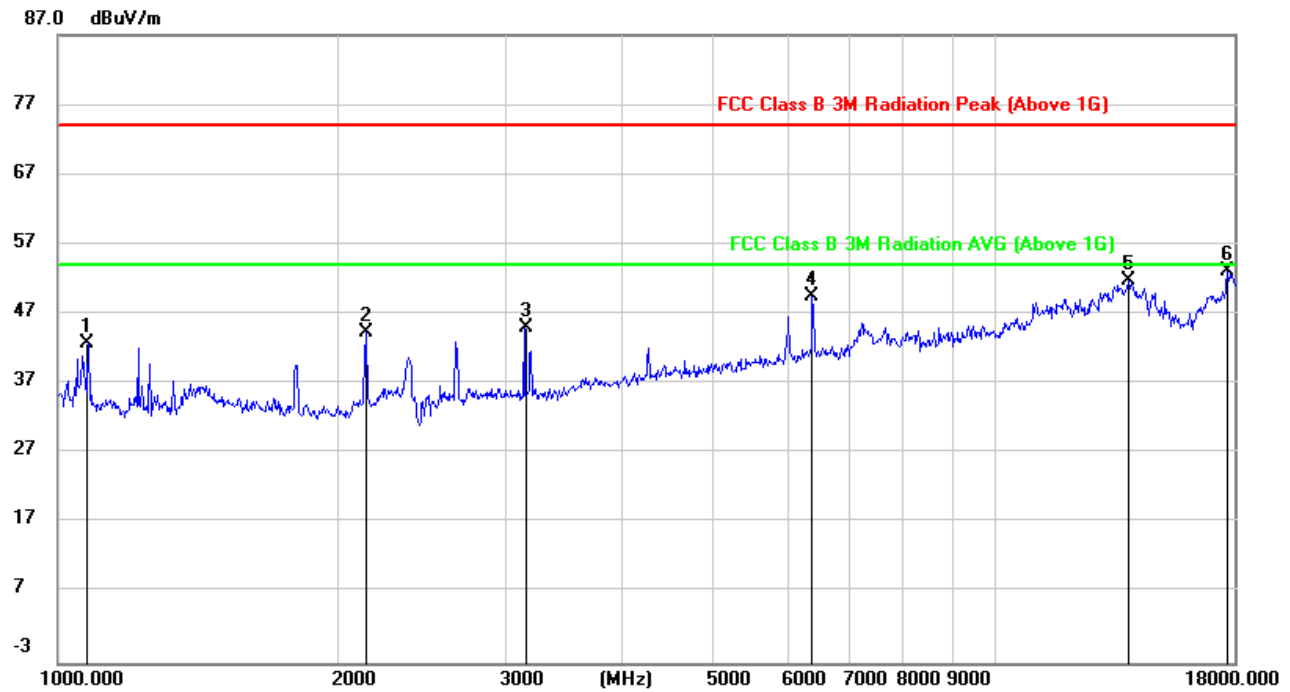

No.	Frequency (MHz)	Reading (dBuV/m)	Correct dB/m	Result (dBuV/m)	Limit (dBuV/m)	Margin (dB)	Remark
1	1078.045	57.22	-14.32	42.90	74.00	-31.10	peak
2	2138.635	54.27	-9.81	44.46	74.00	-29.54	peak
3	3150.237	51.57	-6.48	45.09	74.00	-28.91	peak
4	6377.195	46.55	3.08	49.63	74.00	-24.37	peak
5	13877.076	32.62	19.19	51.81	74.00	-22.19	peak
6	17690.531	28.42	24.78	53.20	74.00	-20.80	peak

- Note: 1. Measurement = Reading Level + Correct Factor.  
 2. If Peak Result complies with AV limit, AV Result is deemed to comply with AV limit.  
 3. Peak: Peak detector.  
 4. AVG: VBW=1/Ton where: ton is transmit duration.  
 5. For transmit duration, please refer to clause 7.1.

**HARMONICS AND SPURIOUS EMISSIONS (MID CHANNEL, HORIZONTAL)**

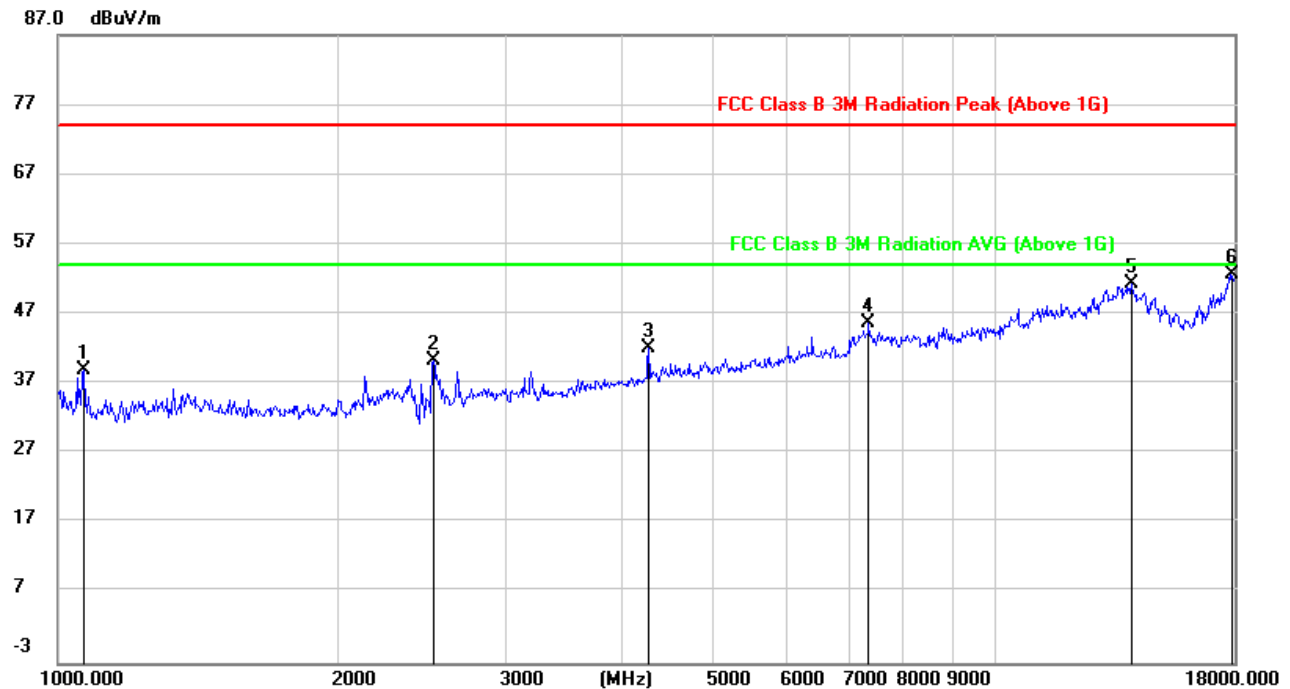

No.	Frequency (MHz)	Reading (dBuV/m)	Correct (dB/m)	Result (dBuV/m)	Limit (dBuV/m)	Margin (dB)	Remark
1	1065.653	53.06	-14.06	39.00	74.00	-35.00	peak
2	2514.386	49.43	-9.19	40.24	74.00	-33.76	peak
3	4267.237	45.43	-3.24	42.19	74.00	-31.81	peak
4	7326.267	39.94	5.70	45.64	74.00	-28.36	peak
5	13957.529	32.37	18.95	51.32	74.00	-22.68	peak
6	17896.247	27.01	25.75	52.76	74.00	-21.24	peak

Note: 1. Measurement = Reading Level + Correct Factor.  
 2. If Peak Result complies with AV limit, AV Result is deemed to comply with AV limit.  
 3. Peak: Peak detector.  
 4. AVG: VBW=1/Ton where: ton is transmit duration.  
 5. For transmit duration, please refer to clause 7.1.

**HARMONICS AND SPURIOUS EMISSIONS (MID CHANNEL, VERTICAL)**

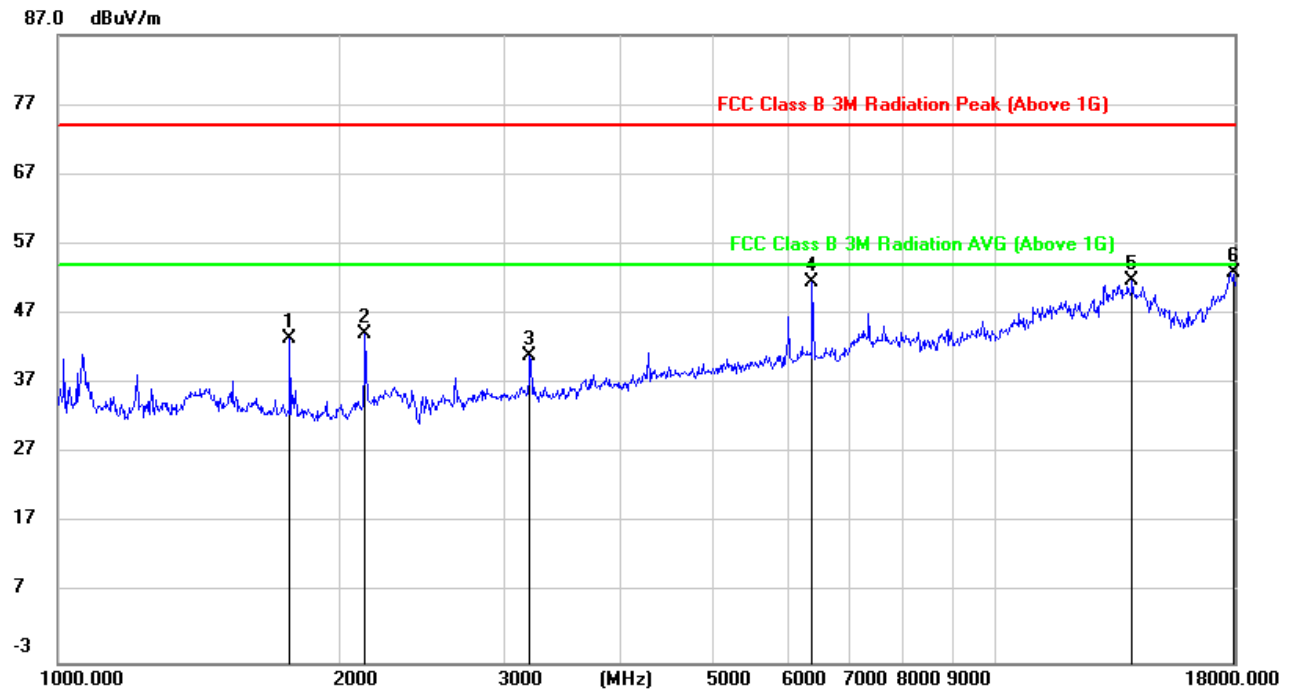

No.	Frequency (MHz)	Reading (dBuV/m)	Correct (dB/m)	Result (dBuV/m)	Limit (dBuV/m)	Margin (dB)	Remark
1	1767.212	55.24	-11.88	43.36	74.00	-30.64	peak
2	2132.462	54.08	-9.88	44.20	74.00	-29.80	peak
3	3186.869	47.38	-6.38	41.00	74.00	-33.00	peak
4	6377.195	48.37	3.08	51.45	74.00	-22.55	peak
5	13997.929	32.82	18.97	51.79	74.00	-22.21	peak
6	17896.247	26.94	25.99	52.93	74.00	-21.07	peak

Note: 1. Measurement = Reading Level + Correct Factor.  
 2. If Peak Result complies with AV limit, AV Result is deemed to comply with AV limit.  
 3. Peak: Peak detector.  
 4. AVG: VBW=1/Ton where: ton is transmit duration.  
 5. For transmit duration, please refer to clause 7.1.



**HARMONICS AND SPURIOUS EMISSIONS (HIGH CHANNEL, HORIZONTAL)**

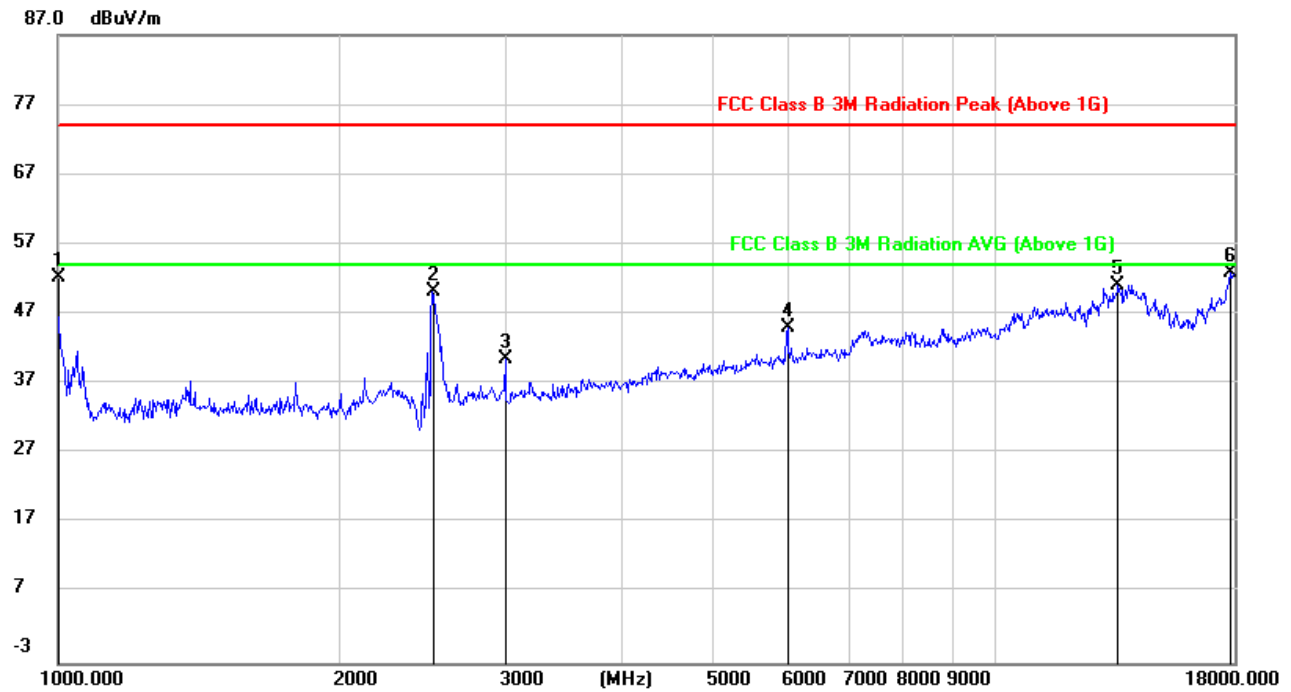

No.	Frequency (MHz)	Reading (dBuV/m)	Correct dB/m	Result (dBuV/m)	Limit (dBuV/m)	Margin (dB)	Remark
1	1000.0000	66.98	-14.76	52.22	74.00	-21.78	peak
2	2514.386	59.49	-9.19	50.30	74.00	-23.70	peak
3	2999.187	47.63	-7.15	40.48	74.00	-33.52	peak
4	6001.626	43.11	2.00	45.11	74.00	-28.89	peak
5	13520.742	32.52	18.67	51.19	74.00	-22.81	peak
6	17793.092	27.12	25.79	52.91	74.00	-21.09	peak

Note: 1. Measurement = Reading Level + Correct Factor.  
 2. If Peak Result complies with AV limit, AV Result is deemed to comply with AV limit.  
 3. Peak: Peak detector.  
 4. AVG: VBW=1/Ton where: ton is transmit duration.  
 5. For transmit duration, please refer to clause 7.1.

**HARMONICS AND SPURIOUS EMISSIONS (HIGH CHANNEL, VERTICAL)**

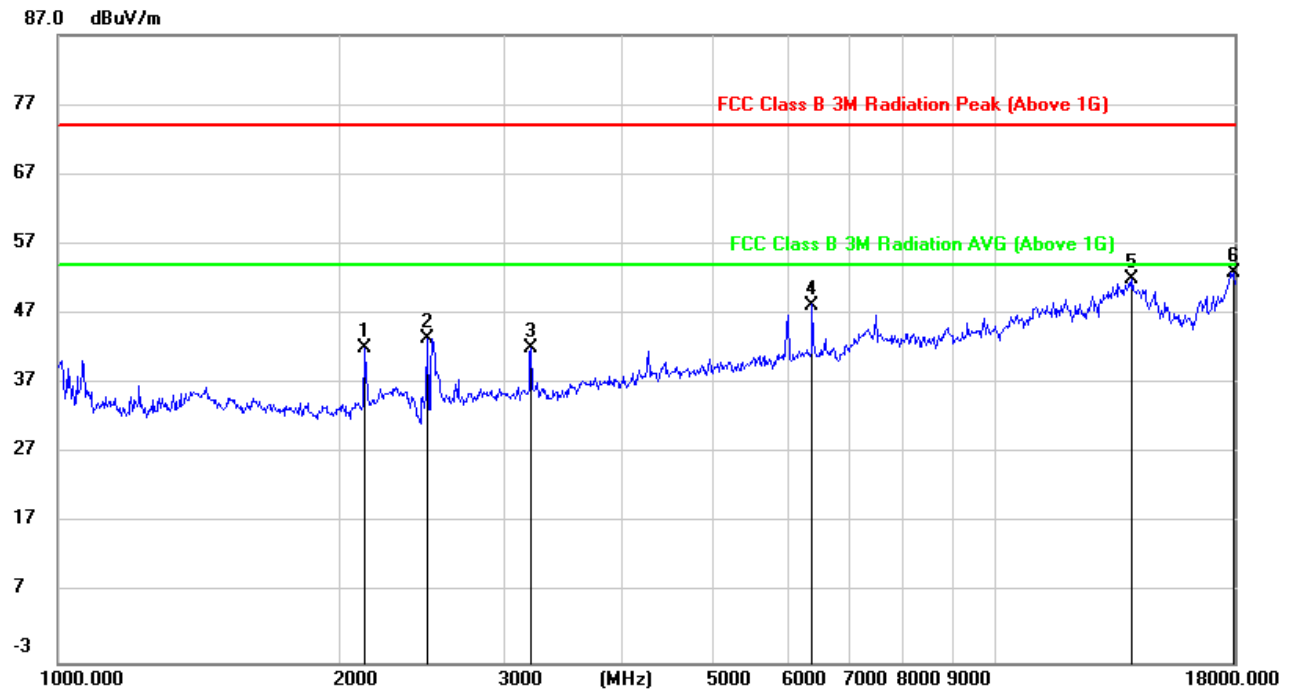

No.	Frequency (MHz)	Reading (dBuV/m)	Correct (dB/m)	Result (dBuV/m)	Limit (dBuV/m)	Margin (dB)	Remark
1	2120.171	52.27	-10.05	42.22	74.00	-31.78	peak
2	2478.310	52.63	-9.11	43.52	74.00	-30.48	peak
3	3196.094	48.40	-6.35	42.05	74.00	-31.95	peak
4	6377.195	45.22	3.08	48.30	74.00	-25.70	peak
5	13997.929	33.10	18.97	52.07	74.00	-21.93	peak
6	17896.247	27.02	25.99	53.01	74.00	-20.99	peak

Note: 1. Measurement = Reading Level + Correct Factor.  
 2. If Peak Result complies with AV limit, AV Result is deemed to comply with AV limit.  
 3. Peak: Peak detector.  
 4. AVG: VBW=1/Ton where: ton is transmit duration.  
 5. For transmit duration, please refer to clause 7.1.

### 8.3. SPURIOUS EMISSIONS 18G ~ 26GHz

#### SPURIOUS EMISSIONS (MID CHANNEL, WORST-CASE CONFIGURATION, HORIZONTAL)

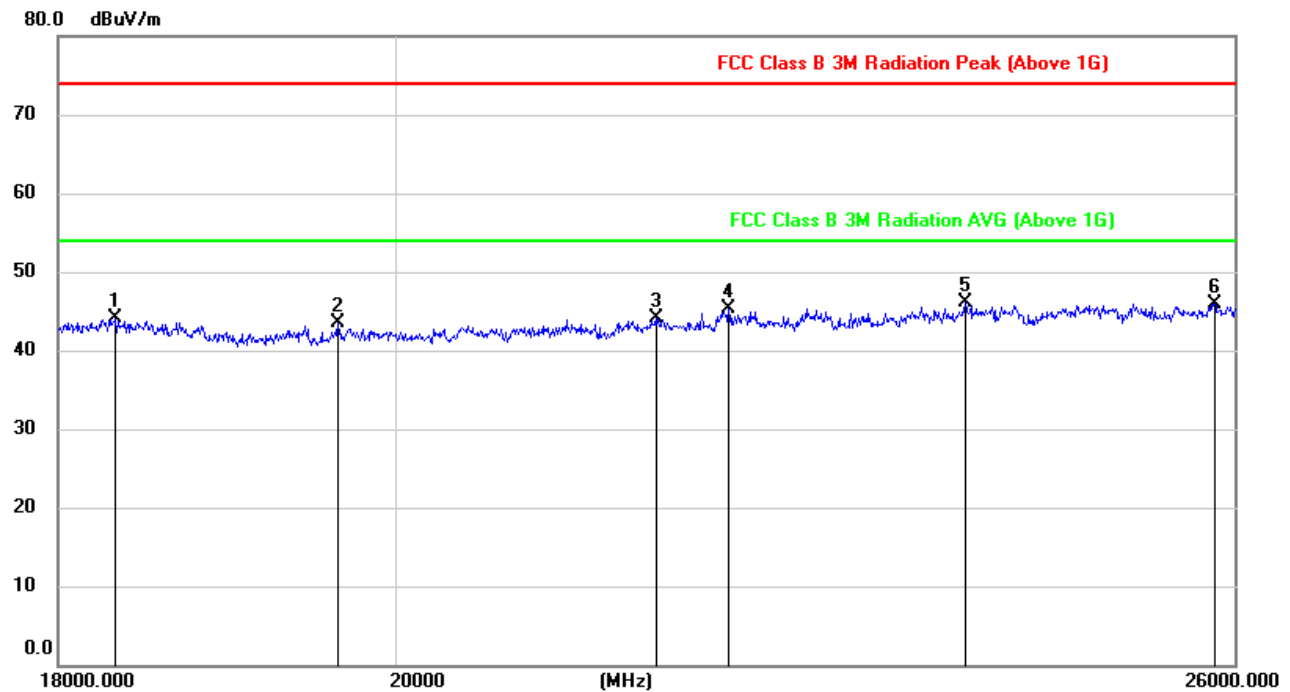

No.	Frequency (MHz)	Reading (dBuV/m)	Correct (dB/m)	Result (dBuV/m)	Limit (dBuV/m)	Margin (dB)	Remark
1	18327.273	49.49	-5.46	44.03	74.00	-29.97	peak
2	19646.324	48.86	-5.38	43.48	74.00	-30.52	peak
3	21697.042	48.59	-4.40	44.19	74.00	-29.81	peak
4	22197.394	49.49	-4.27	45.22	74.00	-28.78	peak
5	23900.217	49.00	-2.93	46.07	74.00	-27.93	peak
6	25837.973	46.76	-0.76	46.00	74.00	-28.00	peak

Note: 1. Measurement = Reading Level + Correct Factor.  
 2. If Peak Result complies with AV limit, AV Result is deemed to comply with AV limit.  
 3. Peak: Peak detector.

**SPURIOUS EMISSIONS (MID CHANNEL, WORST-CASE CONFIGURATION, VERTICAL)**

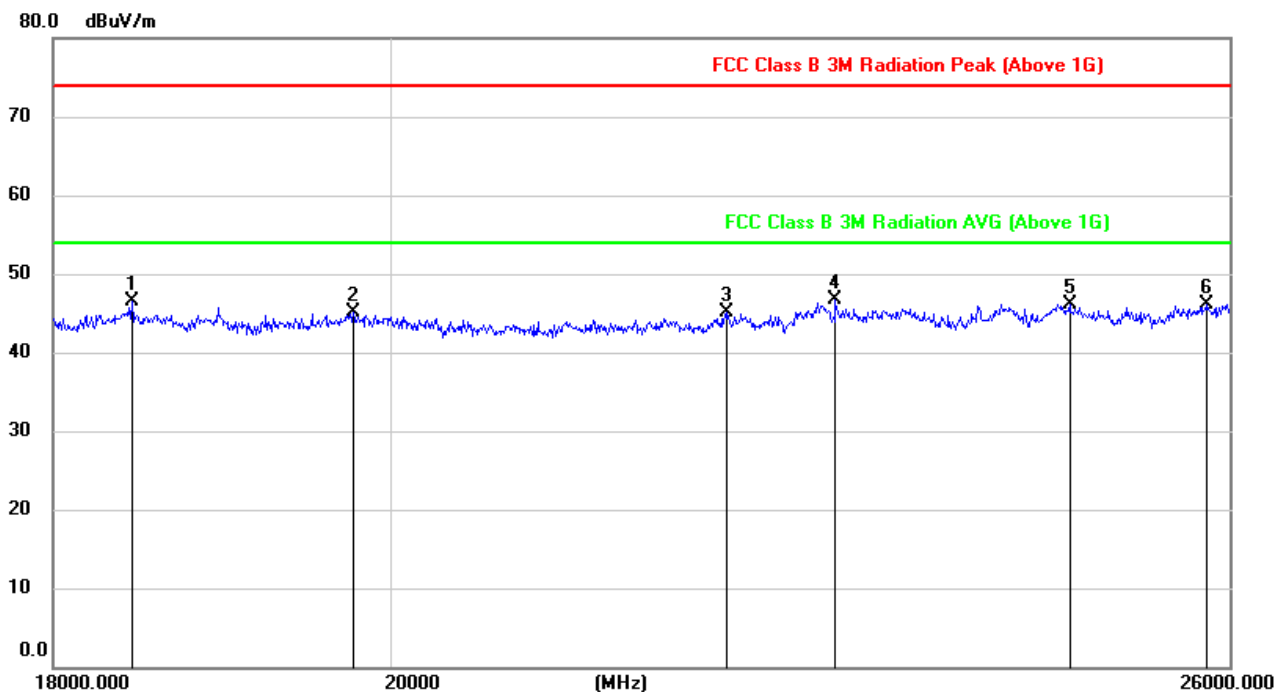

No.	Frequency (MHz)	Reading (dBuV/m)	Correct (dB/m)	Result (dBuV/m)	Limit (dBuV/m)	Margin (dB)	Remark
1	18448.984	51.77	-5.32	46.45	74.00	-27.55	peak
2	19769.524	50.35	-5.26	45.09	74.00	-28.91	peak
3	22221.895	49.34	-4.26	45.08	74.00	-28.92	peak
4	22986.538	50.12	-3.45	46.67	74.00	-27.33	peak
5	24731.704	48.41	-2.31	46.10	74.00	-27.90	peak
6	25809.484	46.82	-0.72	46.10	74.00	-27.90	peak

Note: 1. Measurement = Reading Level + Correct Factor.  
 2. If Peak Result complies with AV limit, AV Result is deemed to comply with AV limit.  
 3. Peak: Peak detector.

### 8.4. SPURIOUS EMISSIONS 30M ~ 1 GHz

#### SPURIOUS EMISSIONS (MID CHANNEL, WORST-CASE CONFIGURATION, HORIZONTAL)

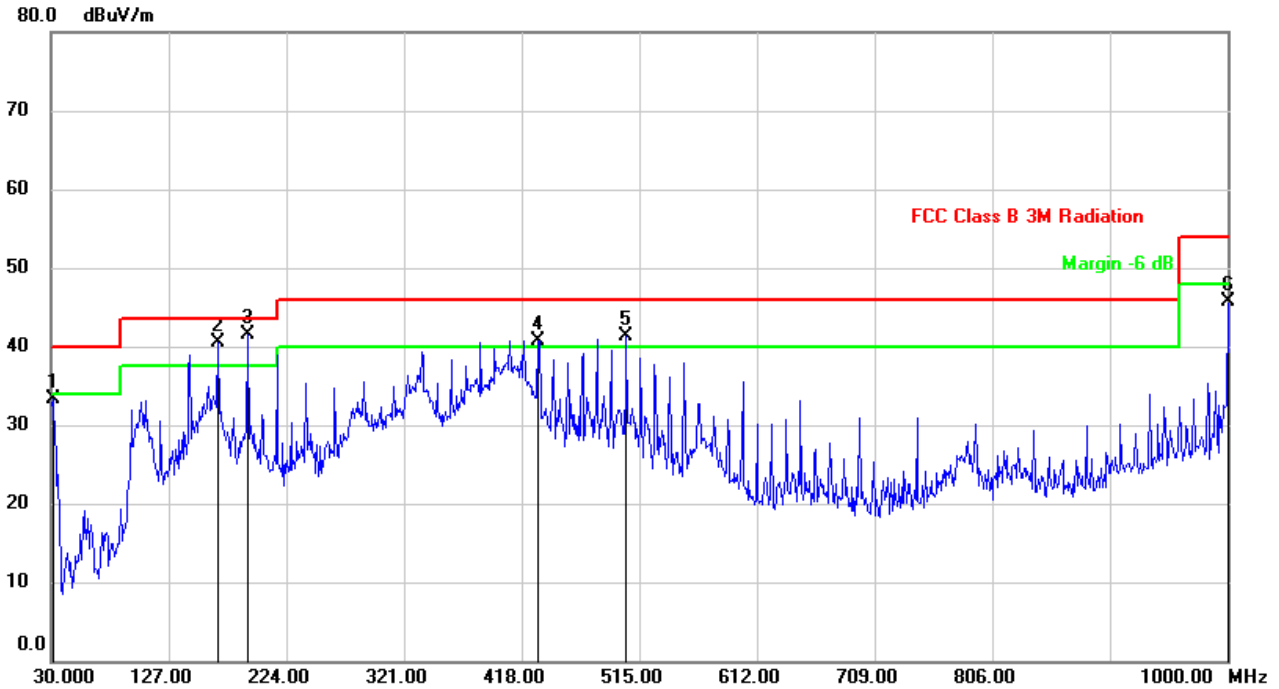

No.	Frequency (MHz)	Reading (dBuV/m)	Correct (dB/m)	Result (dBuV/m)	Limit (dBuV/m)	Margin (dB)	Remark
1	31.9400	47.90	-14.53	33.37	40.00	-6.63	QP
2	167.7400	53.78	-13.27	40.51	43.50	-2.99	QP
3	191.9900	54.31	-12.82	41.49	43.50	-2.01	QP
4	431.5800	50.28	-9.54	40.74	46.00	-5.26	QP
5	504.3300	49.00	-7.77	41.23	46.00	-4.77	QP
6	1000.0000	19.18	26.52	45.70	54.00	-8.30	QP

- Note: 1. Result Level = Read Level + Correct Factor.  
 2. If Peak Result complies with QP limit, QP Result is deemed to comply with QP limit.  
 3. Test setup: RBW: 120 kHz, VBW: 300 kHz, Sweep time: auto.

**SPURIOUS EMISSIONS (MID CHANNEL, WORST-CASE CONFIGURATION, VERTICAL)**

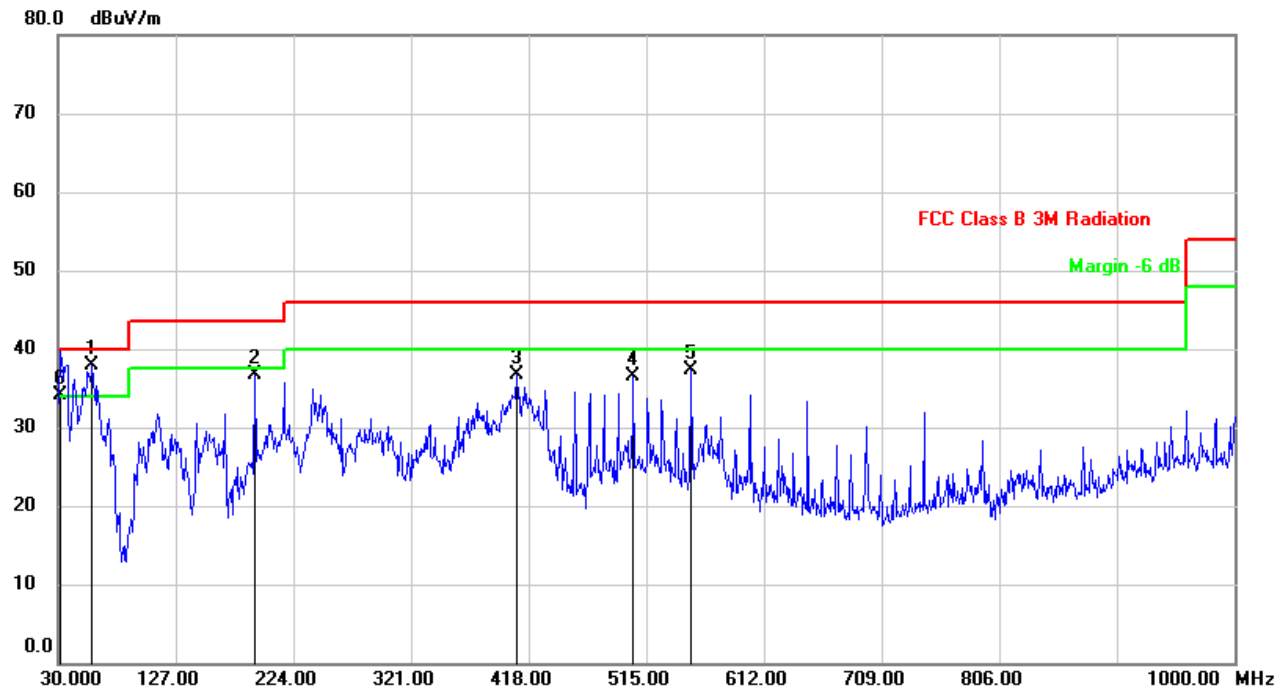

No.	Frequency (MHz)	Reading (dBuV/m)	Correct (dB/m)	Result (dBuV/m)	Limit (dBuV/m)	Margin (dB)	Remark
1	58.1300	54.46	-16.53	37.93	40.00	-2.07	QP
2	191.9900	49.48	-12.82	36.66	43.50	-6.84	QP
3	408.3000	46.67	-9.96	36.71	46.00	-9.29	QP
4	504.3300	44.36	-7.77	36.59	46.00	-9.41	QP
5	551.8600	44.62	-7.38	37.24	46.00	-8.76	QP
6	31.9400	48.73	-14.53	34.20	40.00	-5.80	QP

- Note: 1. Result Level = Read Level + Correct Factor.  
 2. If Peak Result complies with QP limit, QP Result is deemed to comply with QP limit.  
 3. Test setup: RBW: 120 kHz, VBW: 300 kHz, Sweep time: auto

### 8.5. SPURIOUS EMISSIONS BELOW 30M

#### SPURIOUS EMISSIONS (MID CHANNEL, WORST-CASE CONFIGURATION, VERTICAL)

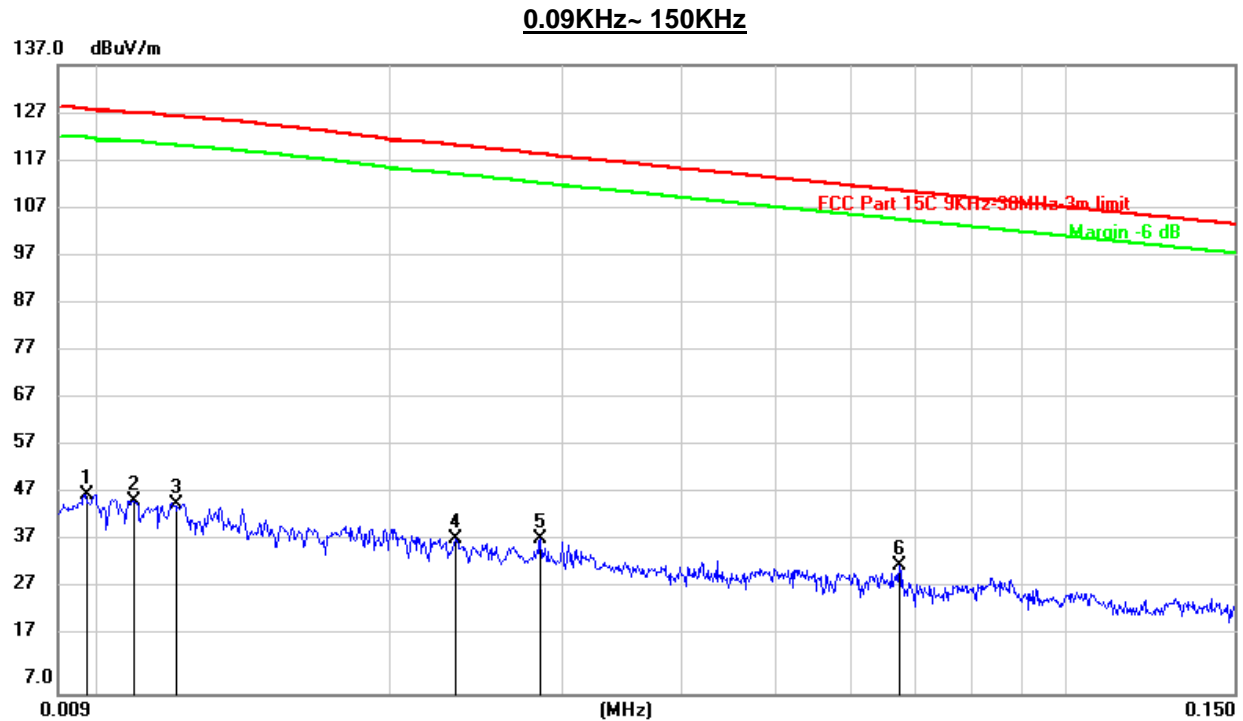

No.	Frequency (KHz)	Reading (dBuV/m)	Correct dB/m	Result (dBuV/m)	Limit (dBuV/m)	Margin (dB)	Remark
1	0.0095	28.00	20.25	48.25	127.98	-79.73	peak
2	0.0108	26.64	20.22	46.86	127.12	-80.26	peak
3	0.0120	26.06	20.23	46.29	126.40	-80.11	peak
4	0.0233	18.85	20.31	39.16	120.42	-81.26	peak
5	0.0285	18.56	20.31	38.87	118.59	-79.72	peak
6	0.0672	13.21	20.31	33.52	111.08	-77.56	peak

Note: 1. Measurement = Reading Level + Correct Factor.  
 2. If Peak Result complies with AV and QP limit, AV and QP Result are deemed to comply with AV limit.

**150KHz ~ 30M**

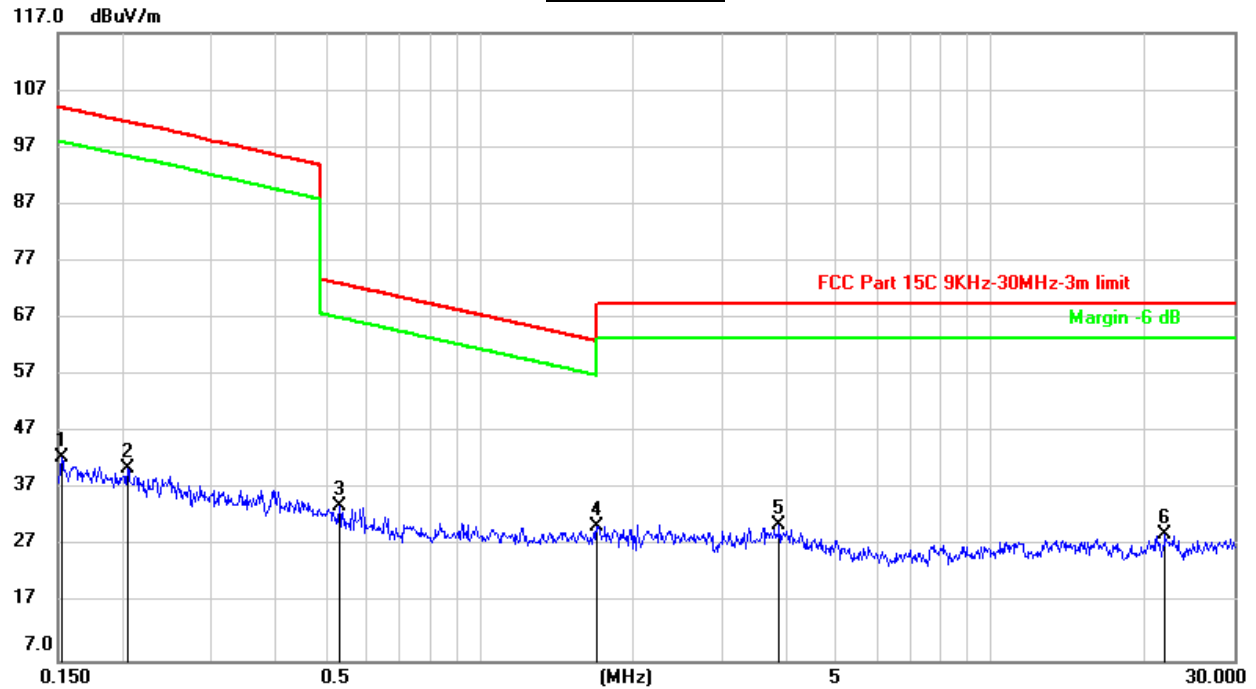

No.	Frequency (MHz)	Reading (dBuV/m)	Correct dB/m	Result (dBuV/m)	Limit (dBuV/m)	Margin (dB)	Remark
1	0.1524	22.16	20.42	42.58	103.95	-61.37	peak
2	0.2048	20.20	20.36	40.56	101.41	-60.85	peak
3	0.5322	13.75	20.25	34.00	73.12	-39.12	peak
4	1.6978	9.92	20.62	30.54	63.01	-32.47	peak
5	3.8603	9.74	21.04	30.78	69.54	-38.76	peak
6	21.9463	7.98	21.25	29.23	69.54	-40.31	peak

Note: 1. Measurement = Reading Level + Correct Factor.  
 2. If Peak Result complies with AV and QP limit, AV and QP Result are deemed to comply with AV limit.



**SPURIOUS EMISSIONS (MID CHANNEL, WORST-CASE CONFIGURATION, HORIZONTAL)**

**0.09KHz~ 150KHz**

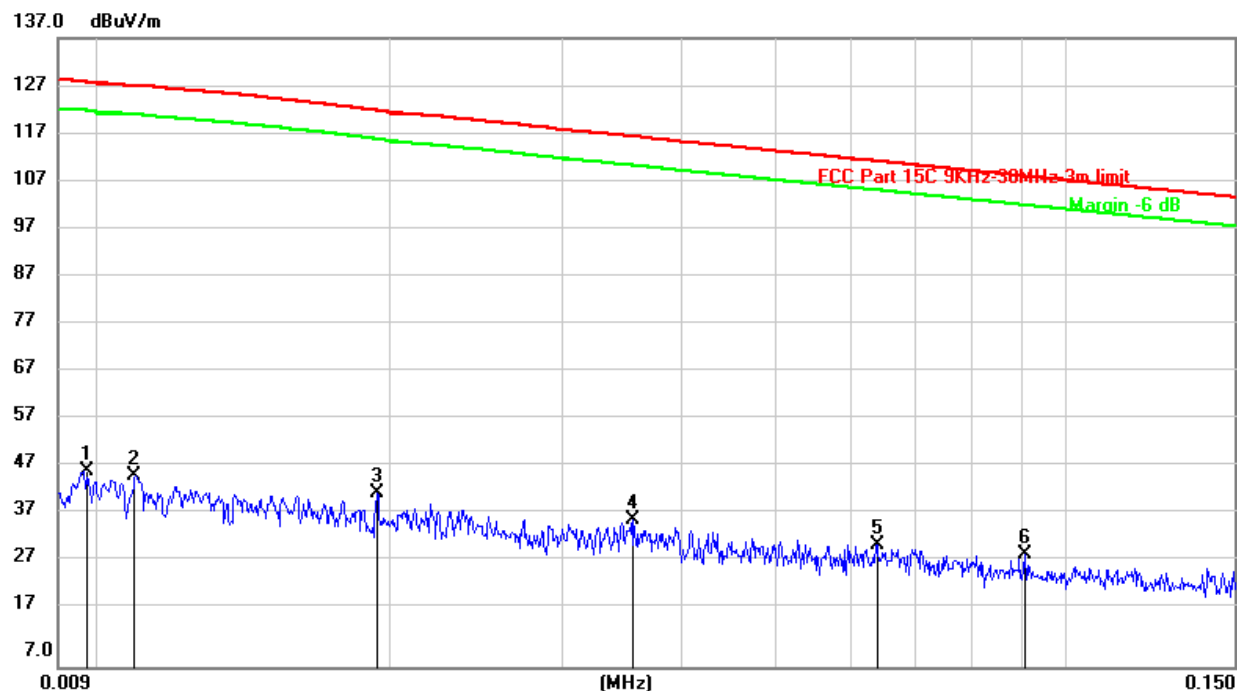

No.	Frequency (KHz)	Reading (dBuV/m)	Correct dB/m	Result (dBuV/m)	Limit (dBuV/m)	Margin (dB)	Remark
1	0.0095	27.20	20.25	47.45	127.98	-80.53	peak
2	0.0108	26.24	20.22	46.46	127.12	-80.66	peak
3	0.0193	22.46	20.30	42.76	122.00	-79.24	peak
4	0.0355	16.97	20.31	37.28	116.69	-79.41	peak
5	0.0637	11.88	20.31	32.19	111.54	-79.35	peak
6	0.0908	9.85	20.26	30.11	108.45	-78.34	peak

Note: 1. Measurement = Reading Level + Correct Factor.

2. If Peak Result complies with AV and QP limit, AV and QP Result are deemed to comply with AV limit.

**150KHz ~ 30M**

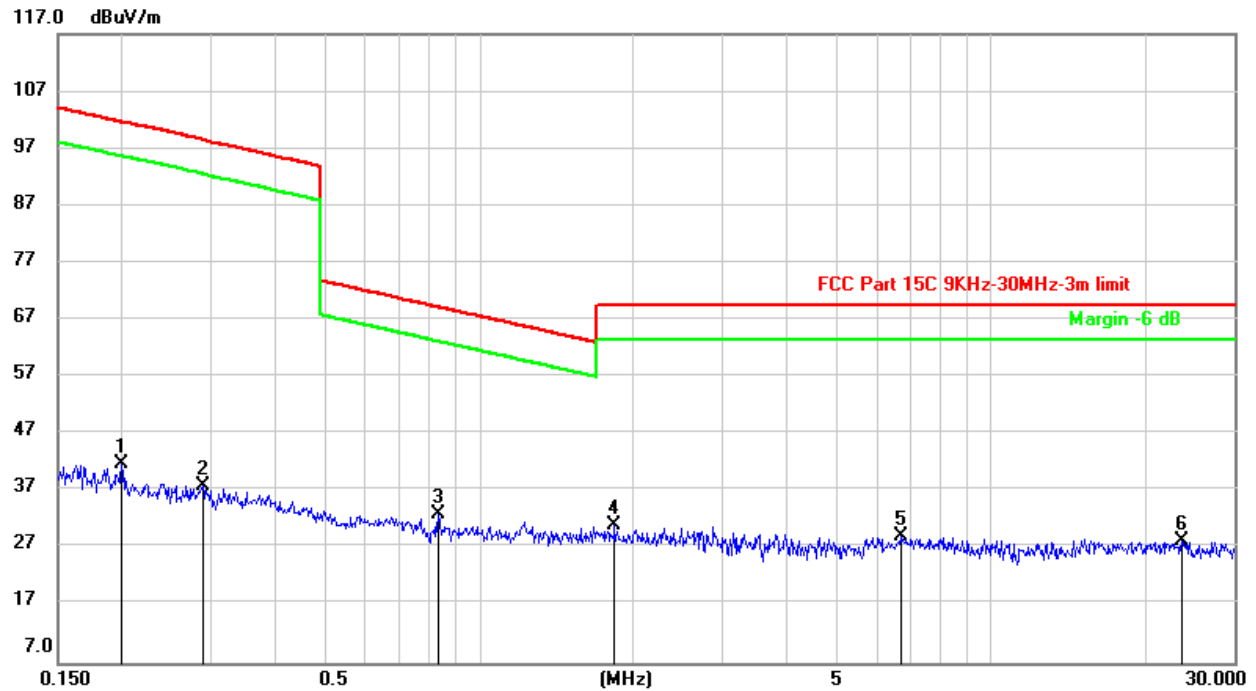

No.	Frequency (MHz)	Reading (dBuV/m)	Correct dB/m	Result (dBuV/m)	Limit (dBuV/m)	Margin (dB)	Remark
1	0.1995	21.35	20.37	41.72	101.60	-59.88	peak
2	0.2878	17.66	20.31	37.97	98.49	-60.52	peak
3	0.8305	12.54	20.36	32.90	69.23	-36.33	peak
4	1.8386	10.28	20.67	30.95	69.54	-38.59	peak
5	6.6623	8.21	20.90	29.11	69.54	-40.43	peak
6	23.6358	6.76	21.42	28.18	69.54	-41.36	peak

Note: 1. Measurement = Reading Level + Correct Factor.  
 2. If Peak Result complies with AV and QP limit, AV and QP Result are deemed to comply with AV limit.

## 9. AC POWER LINE CONDUCTED EMISSIONS

### LIMITS

Please refer to FCC §15.207 (a)

FREQUENCY (MHz)	Class A (dBuV)		Class B (dBuV)	
	Quasi-peak	Average	Quasi-peak	Average
0.15 -0.5	79.00	66.00	66 - 56 *	56 - 46 *
0.50 -5.0	73.00	60.00	56.00	46.00
5.0 -30.0	73.00	60.00	60.00	50.00

### TEST SETUP AND PROCEDURE

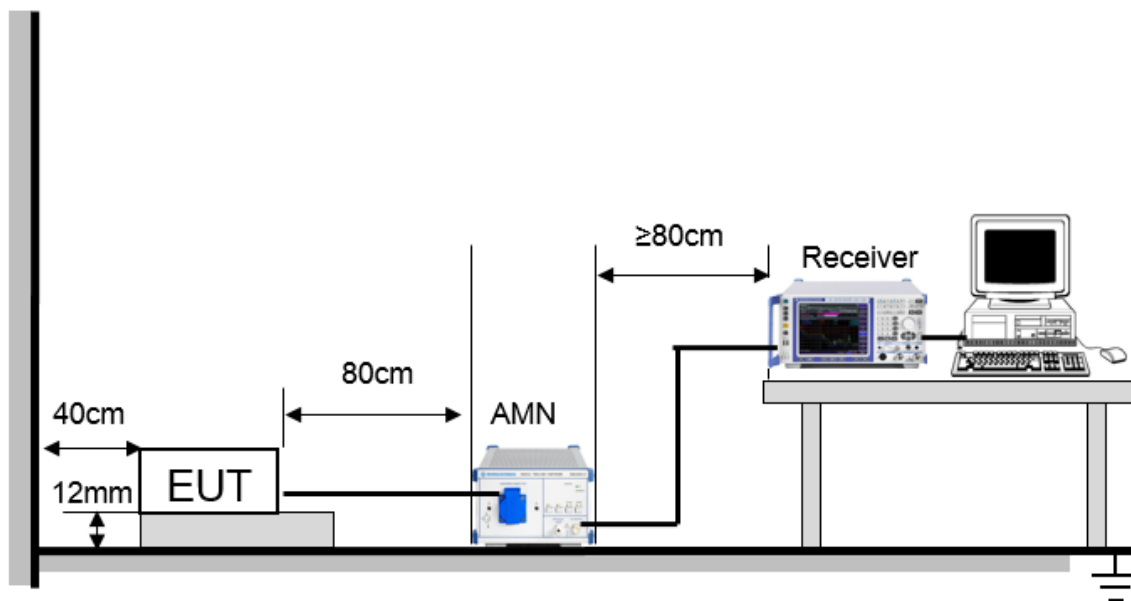

The EUT is put on a table of non-conducting material that is 12mm high. The vertical conducting wall of shielding is located 40cm to the rear of the EUT. The power line of the EUT is connected to the AC mains through a Artificial Mains Network (A.M.N.). A EMI Measurement Receiver (R&S Test Receiver ESR3) is used to test the emissions from both sides of AC line. According to the requirements in Section 6.2 of ANSI C63.10-2013. Conducted emissions from the EUT measured in the frequency range between 0.15 MHz and 30MHz using CISPR Quasi-Peak and average detector mode. The bandwidth of EMI test receiver is set at 9kHz. The arrangement of the equipment is installed to meet the standards and operating in a manner, which tends to maximize its emission characteristics in a normal application.

**TEST RESULTS (MID CHANNEL, WORST-CASE CONFIGURATION)**

**LINE N RESULTS**

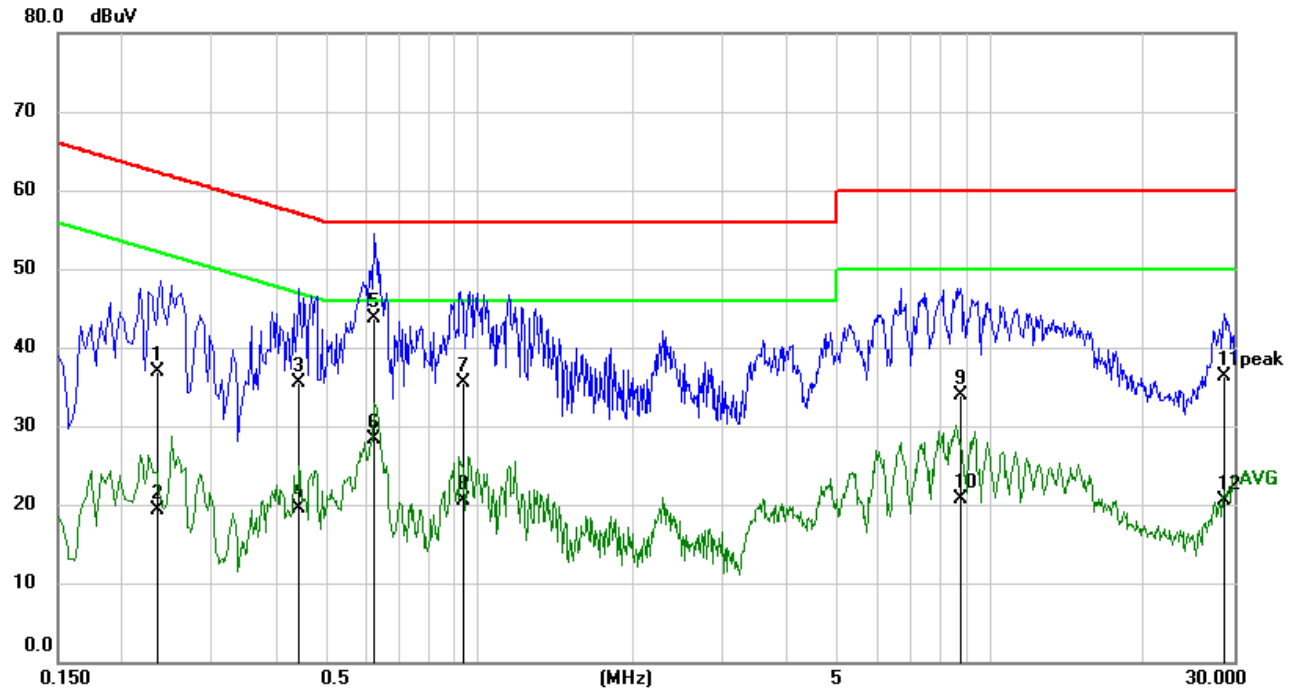

No.	Frequency (MHz)	Reading (dBuV)	Correct (dB)	Result (dBuV)	Limit (dBuV)	Margin (dB)	Remark
1	0.2350	27.24	9.65	36.89	62.27	-25.38	QP
2	0.2350	9.70	9.65	19.35	52.27	-32.92	AVG
3	0.4465	25.82	9.65	35.47	56.94	-21.47	QP
4	0.4465	9.91	9.65	19.56	46.94	-27.38	AVG
5	0.6295	34.10	9.66	43.76	56.00	-12.24	QP
6	0.6295	18.63	9.66	28.29	46.00	-17.71	AVG
7	0.9274	25.89	9.67	35.56	56.00	-20.44	QP
8	0.9274	10.89	9.67	20.56	46.00	-25.44	AVG
9	8.7524	24.17	9.77	33.94	60.00	-26.06	QP
10	8.7524	11.01	9.77	20.78	50.00	-29.22	AVG
11	28.7126	26.30	9.92	36.22	60.00	-23.78	QP
12	28.7126	10.68	9.92	20.60	50.00	-29.40	AVG

- Note: 1. Result = Reading +Correct Factor.  
 2. If QP Result complies with AV limit, AV Result is deemed to comply with AV limit.  
 3. Test setup: RBW: 200 Hz (9 kHz—150 kHz), 9 kHz (150 kHz—30 MHz).  
 4. Step size: 80Hz (0.009MHz-0.15MHz), 4 kHz (0.15MHz-30MHz), Scan time: auto.

**LINE L RESULTS**

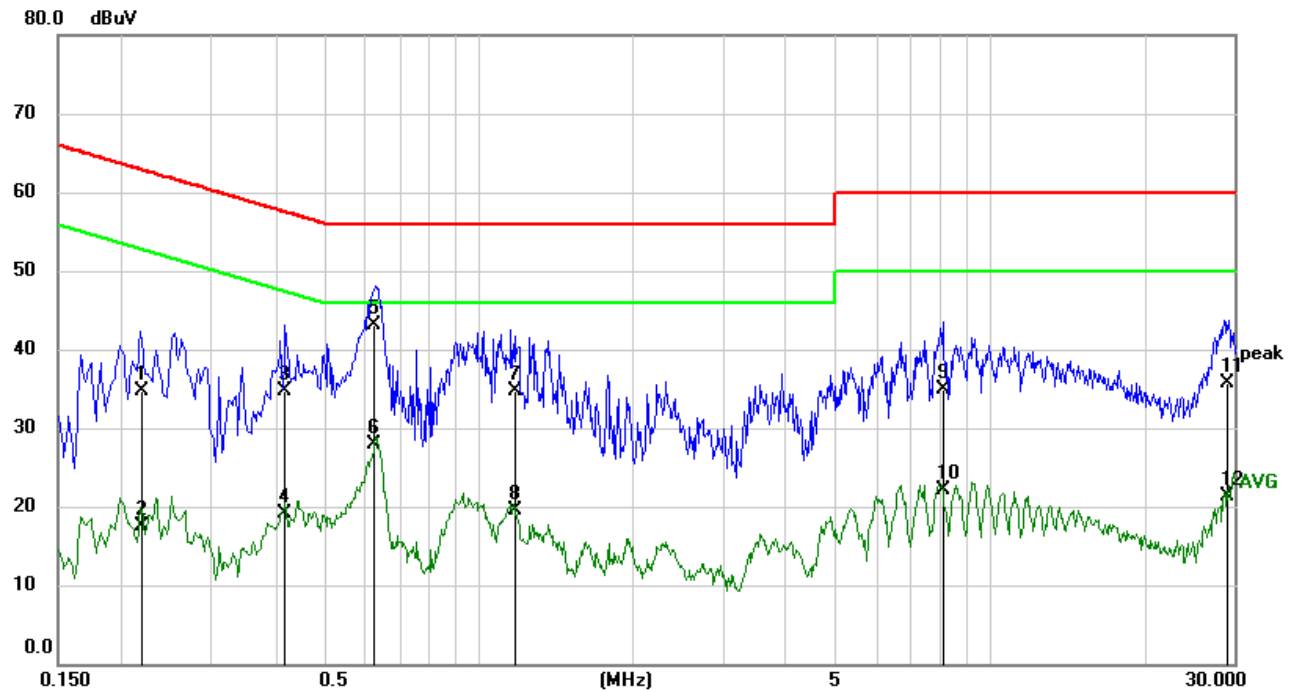

No.	Frequency (MHz)	Reading (dBuV)	Correct (dB)	Result (dBuV)	Limit (dBuV)	Margin (dB)	Remark
1	0.2193	25.04	9.64	34.68	62.85	-28.17	QP
2	0.2193	7.89	9.64	17.53	52.85	-35.32	AVG
3	0.4178	24.97	9.65	34.62	57.49	-22.87	QP
4	0.4178	9.55	9.65	19.20	47.49	-28.29	AVG
5	0.6260	33.47	9.66	43.13	56.00	-12.87	QP
6	0.6260	18.34	9.66	28.00	46.00	-18.00	AVG
7	1.1705	25.02	9.67	34.69	56.00	-21.31	QP
8	1.1705	9.76	9.67	19.43	46.00	-26.57	AVG
9	8.0460	25.22	9.76	34.98	60.00	-25.02	QP
10	8.0460	12.34	9.76	22.10	50.00	-27.90	AVG
11	29.2133	25.74	9.99	35.73	60.00	-24.27	QP
12	29.2133	11.31	9.99	21.30	50.00	-28.70	AVG

- Note: 1. Result = Reading +Correct Factor.  
 2. If QP Result complies with AV limit, AV Result is deemed to comply with AV limit.  
 3. Test setup: RBW: 200 Hz (9 kHz—150 kHz), 9 kHz (150 kHz—30 MHz).  
 4. Step size: 80Hz (0.009MHz-0.15MHz), 4 kHz (0.15MHz-30MHz), Scan time: auto.

Note: All the modulation and channels had been tested, but only the worst data recorded in the report.

## 10. ANTENNA REQUIREMENTS

### Applicable requirements

Please refer to FCC §15.203

An intentional radiator shall be designed to ensure that no antenna other than that furnished by the responsible party shall be used with the device. The use of a permanently attached antenna or of an antenna that uses a unique coupling to the intentional radiator shall be considered sufficient to comply with the provisions of this section. The manufacturer may design the unit so that a broken antenna can be replaced by the user, but the use of a standard antenna jack or electrical connector is prohibited.

Please refer to FCC §15.247(b)(4)

The conducted output power limit specified in paragraph (b) of this section is based on the use of antennas with directional gains that do not exceed 6 dBi. Except as shown in paragraph (c) of this section, if transmitting antennas of directional gain greater than 6 dBi are used, the conducted output power from the intentional radiator shall be reduced below the stated values in paragraphs (b)(1), (b)(2), and (b)(3) of this section, as appropriate, by the amount in dB that the directional gain of the antenna exceeds 6 dBi.

### Antenna Connector

EUT has an external antenna with a non-standard antenna connector.

### Antenna Gain

The antenna gain of EUT is less than 6 dBi.

**END OF REPORT**

Page 62 of 62