

FCC TEST REPORT  
for  
Eagles Nest Outfitters. Inc

Echo  
Model No.: F-6188

Prepared for : Eagles Nest Outfitters. Inc  
Address : 24 Buxton Ave., Asheville, NC 28801, United States

Prepared By : Shenzhen Anbotek Compliance Laboratory Limited  
Address : 1/F., Building 1, SEC Industrial Park, No.0409 Qianhai Road,  
Nanshan District, Shenzhen, Guangdong, China  
Tel: (86) 755-26066544  
Fax: (86) 755-26014772

Report Number : R011607354I  
Date of Test : Jul. 12~29, 2016  
Date of Report : Jul. 29, 2016

## TABLE OF CONTENTS

Description	Page
Test Report	
<b>1. GENERAL INFORMATION.....</b>	<b>5</b>
1.1 Description of Device (EUT).....	5
1.2 Auxiliary Equipment Used during Test.....	5
1.3. Summary of Test Results.....	6
1.4 Description of Test Facility.....	6
1.5 Measurement Uncertainty.....	6
<b>2. TEST PROCEDURE.....</b>	<b>7</b>
<b>3. CONDUCTED EMISSION.....</b>	<b>8</b>
3.1 Block Diagram of Test Setup.....	8
3.2 Power Line Conducted Emission Measurement Limits (15.207).....	8
3.3 Configuration of EUT on Measurement.....	8
3.4 Operating Condition of EUT.....	8
3.5 Test Procedure.....	9
3.6 Power Line Conducted Emission Measurement Results.....	9
<b>4. RADIATION INTERFERENCE.....</b>	<b>14</b>
4.1 Requirements (15.247, 15.209):.....	14
4.2 Test Procedure.....	14
4.3 Test Configuration.....	15
4.4 Test Results.....	16
<b>5. CHANNEL SEPARATION TEST.....</b>	<b>25</b>
5.1 Measurement Procedure.....	25
5.2 Test SET-UP.....	25
5.3 Test Equipment.....	25
5.4 Test Results.....	26
<b>6. 20DB BANDWIDTH TEST.....</b>	<b>28</b>
6.1 Measurement Procedure.....	28
6.2 Test SET-UP.....	28
6.3 Test Equipment.....	28
6.4 Test Results.....	28
<b>7. QUANTITY OF HOPPING CHANNEL TEST.....</b>	<b>30</b>
7.1 Measurement Procedure.....	30
7.2 Test SET-UP.....	30
7.3 Test Equipment.....	30
7.4 Test Results.....	30
<b>8. DWELL TIME TEST.....</b>	<b>32</b>

8.1 Measurement Procedure.....	32
8.2 Test SET-UP.....	32
8.3 Test Equipment.....	32
8.4 Test Results.....	32
<b>9. MAXIMUM PEAK OUTPUT POWER TEST.....</b>	<b>34</b>
9.1 Measurement Procedure.....	34
9.2 Test SET-UP.....	34
9.3 Test Equipment.....	34
9.4 Test Results.....	35
<b>10. BAND EDGE TEST.....</b>	<b>37</b>
10.1 Measurement Procedure.....	37
10.2 Test SET-UP.....	37
10.3 Test Equipment.....	38
10.4 Test Results.....	38
<b>11. ANTENNA APPLICATION.....</b>	<b>44</b>
11.1 Antenna requirement.....	44
11.2 Result.....	44
<b>12. PHOTOGRAPH.....</b>	<b>45</b>
12.1 Photo of Power Line Conducted Emission Measurement.....	45
12.2 Photo of Radiation Emission Test.....	45
<b>APPENDIX I (EXTERNAL PHOTOS).....</b>	<b>47</b>
<b>APPENDIX II (INTERNAL PHOTOS).....</b>	<b>50</b>

## TEST REPORT

Applicant : Eagles Nest Outfitters. Inc  
Manufacturer : Weiguo Solutions Ltd  
EUT : Echo  
Model No. : F-6188  
Serial No. : N.A.  
Trade Mark : Echo  
Rating : DC 2.8-4.5V, 500mA  
DC 5V Via USB Port

Measurement Procedure Used:

FCC Part15 Subpart C 2015, Paragraph 15.207, 15.247 & 15.209

The device described above is tested by Shenzhen Anbotek Compliance Laboratory Limited to determine the maximum emission levels emanating from the device and the severe levels of the device can endure and its performance criterion. The measurement results are contained in this test report and Shenzhen Anbotek Compliance Laboratory Limited is assumed full of responsibility for the accuracy and completeness of these measurements. Also, this report shows that the EUT (Equipment Under Test) is technically compliant with the FCC Part 15 Subpart C requirements.

This report applies to above tested sample only and shall not be reproduced in part without written approval of Shenzhen Anbotek Compliance Laboratory Limited.

Date of Test : Jul. 12~29, 2016

Prepared by :   
(Tested Engineer / Baron Wen)

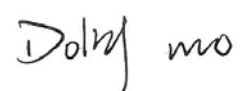
Reviewer :   
(Project Manager / Dolly Mo)

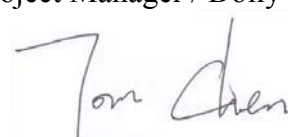
Approved & Authorized Signer :   
(Manager / Tom Chen)

## 1. GENERAL INFORMATION

### 1.1 Description of Device (EUT)

EUT : Echo

Model Number : F-6188

Test Power Supply : AC 120V, 60Hz for adapter/  
AC 240V, 60Hz for adapter/  
DC 3.7V Battery inside

Frequency : 2402~2480MHz

Antenna Specification : PCB Antenna: 0dBi

Modulation : GFSK,  $\pi/4$ DQPSK, 8DPSK

Applicant : Eagles Nest Outfitters. Inc  
Address : 24 Buxton Ave., Asheville, NC 28801, United States

Manufacturer : Weiguo Solutions Ltd  
Address : 3rd Floor, Zone 7, Baosheng Road, Zhuhai Free Trade Zone, Zhuhai, Guangdong, P.R.C

Factory : Weiguo Solutions Ltd  
Address : 3rd Floor, Zone 7, Baosheng Road, Zhuhai Free Trade Zone, Zhuhai, Guangdong, P.R.C

Date of receipt : Jul. 12, 2016

Date of Test : Jul. 12~29, 2016

### 1.2 Auxiliary Equipment Used during Test

Adapter : Manufacturer: ZTE  
M/N: STC-A2050I1000USBA-C  
S/N: 201202102100876  
Input: 100-240V~50/60Hz 0.3A  
Output: DC 5V, 1000mA

### 1.3. Summary of Test Results

The EUT has been tested according to the following specifications:

Standard Section	Test Item	Judgment
15.203/15.247(c)	Antenna Requirement	PASS
15.207	Conducted Emission	PASS
15.247(b)(1)	Conducted Peak Output Power	PASS
15.247(a)(1)	20dB Occupied Bandwidth	PASS
15.247(a)(1)	Carrier Frequencies Separation	PASS
15.247(a)(1)	Hopping Channel Number	PASS
15.247(a)(1)	Dwell Time	PASS
15.205/15.209	Spurious Emission	PASS
15.247(d)	Band Edge	PASS
<b>Remark:</b> "N/A" is an abbreviation for Not Applicable.		

### 1.4 Description of Test Facility

The test facility is recognized, certified, or accredited by the following organizations:

**FCC-Registration No.: 752021**

Shenzhen Anbotek Compliance Laboratory Limited, EMC Laboratory has been registered and fully described in a report filed with the (FCC) Federal Communications Commission. The acceptance letter from the FCC is maintained in our files. Registration 752021, July 06, 2016.

**IC-Registration No.: 8058A-1**

Shenzhen Anbotek Compliance Laboratory Limited., EMC Laboratory has been registered and fully described in a report filed with the (IC) Industry Canada. The acceptance letter from the IC is maintained in our files. Registration 8058A, Jun. 13, 2016.

**Test Location**

All Emissions tests were performed at Shenzhen Anbotek Compliance Laboratory Limited. at 1/F., Building 1, SEC Industrial Park, No.0409 Qianhai Road, Nanshan District, Shenzhen, Guangdong, China

### 1.5 Measurement Uncertainty

Radiation Uncertainty : Ur = 4.1 dB (Horizontal)  
 Ur = 4.3 dB (Vertical)

Conduction Uncertainty : Uc = 3.4dB

## 2. Test Procedure

**GENERAL:** This report shall NOT be reproduced except in full without the written approval of Shenzhen Anbotek Compliance Laboratory Limited. The EUT was transmitting a test signal during the testing.

**RADIATION INTERFERENCE:** The test procedure used was ANSI STANDARD C63.10-2013 using a spectrum analyzer with a pre-selector. The analyzer was calibrated in dB above a microvolt at the output of the antenna. The resolution bandwidth was 100KHz and the video bandwidth was 300KHz up to 1.0GHz and 1.0MHz with a video BW of 3.0MHz above 1.0GHz. The ambient temperature of the EUT was 74.3oF with a humidity of 69%.

**FORMULA OF CONVERSION FACTORS:** The Field Strength at 3m was established by adding the meter reading of the spectrum analyzer (which is set to read in units of dBuV) to the antenna correction factor supplied by the antenna manufacturer. The antenna correction factors are stated in terms of dB. The gain of the Preselector was accounted for in the Spectrum Analyzer Meter Reading.

**Example:**

Freq (MHz) METER READING + ACF = FS  
20 dBuV + 10.36 dB = 30.36 dBuV/m @ 3m

**ANSI STANDARD C63.10-2013 10.1.7 MEASUREMENT PROCEDURES:** The EUT was placed on a table 80 cm high and with dimensions of 1m by 1.5m. The EUT was placed in the center of the table (1.5m side). The table used for radiated measurements is capable of continuous rotation.

When an emission was found, the table was rotated to produce the maximum signal strength. At this point, the antenna was raised and lowered from 1m to 4m. The antenna was placed in both the horizontal and vertical planes.

### 3. Conducted Emission

#### 3.1 Block Diagram of Test Setup

##### 3.1.1. Block diagram of connection between the EUT and simulators

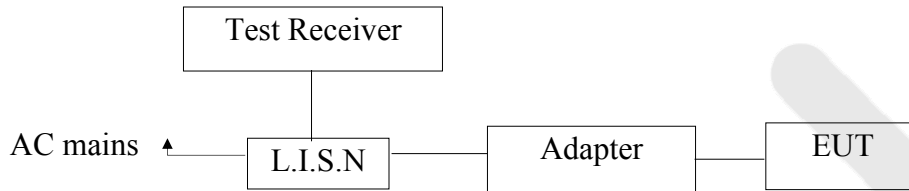

#### 3.2 Power Line Conducted Emission Measurement Limits (15.207)

Frequency MHz	Limits dB(μV)	
	Quasi-peak Level	Average Level
0.15 ~ 0.50	66 ~ 56*	56 ~ 46*
0.50 ~ 5.00	56	46
5.00 ~ 30.00	60	50

- Notes: 1. \*Decreasing linearly with logarithm of frequency.  
2. The lower limit shall apply at the transition frequencies.

#### 3.3 Configuration of EUT on Measurement

The following equipments are installed on Power Line Conducted Emission Measurement to meet the commission requirement and operating regulations in a manner which tends to maximize its emission characteristics in a normal application.

#### 3.4 Operating Condition of EUT

- 3.4.1. Setup the EUT and simulator as shown as Section 3.1.
- 3.4.2. Turn on the power of all equipment.
- 3.4.3. Let the EUT work in test mode (Charging) and measure it.



### 3.5 Test Procedure

The EUT system is connected to the power mains through a line impedance stabilization network (L.I.S.N.). This provides a 50ohm coupling impedance for the EUT system. Please refer the block diagram of the test setup and photographs. Both sides of AC line are checked to find out the maximum conducted emission. In order to find the maximum emission levels, the relative positions of equipment and all of the interface cables shall be changed according to FCC ANSI C63.10-2013 on Conducted Emission Measurement.

The bandwidth of test receiver (ESCI) set at 9KHz.

The frequency range from 150KHz to 30MHz is checked.

The test results are reported on Section 3.6.

#### Test Equipment

Item	Equipment	Manufacturer	Model No.	Serial No.	Last Cal.	Cal. Interval
1.	Two-Line V-network	Rohde & Schwarz	ENV216	100055	Apr. 16, 2016	1 Year
2.	EMI Test Receiver	Rohde & Schwarz	ESCI	100627	Apr. 16, 2016	1 Year
3.	RF Switching Unit	Compliance Direction	RSU-M2	38303	Apr. 16, 2016	1 Year

### 3.6 Power Line Conducted Emission Measurement Results

**PASS.**

The frequency range from 150KHz to 30 MHz is investigated.

Please refer the following pages.

**CONDUCTED EMISSION TEST DATA**

Test Site: 1# Shielded Room  
 Operating Condition: Charging  
 Test Specification: AC 120V, 60Hz for adapter  
 Comment: Live Line  
 Tem.:25°C Hum.:50%

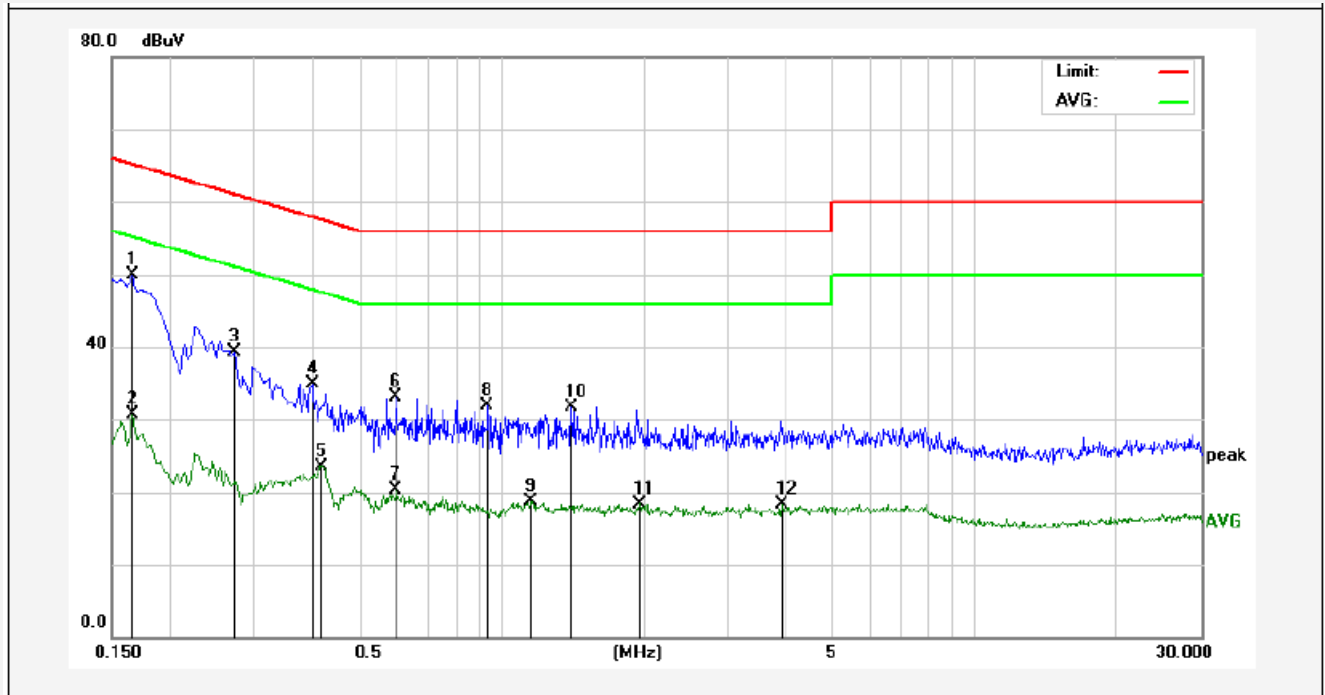

No.	Freq. (MHz)	Reading (dBuV)	Factor (dB)	Result (dBuV)	Limit dBuV	Over Limit (dB)	Detector	Remark
1	0.1660	29.86	20.00	49.86	65.15	-15.29	QP	
2	0.1660	10.77	20.00	30.77	55.15	-24.38	AVG	
3	0.2740	19.25	20.00	39.25	60.99	-21.74	QP	
4	0.3980	14.96	20.00	34.96	57.89	-22.93	QP	
5	0.4180	3.55	20.00	23.55	47.49	-23.94	AVG	
6	0.5980	13.05	20.00	33.05	56.00	-22.95	QP	
7	0.5980	0.32	20.00	20.32	46.00	-25.68	AVG	
8	0.9340	11.95	20.00	31.95	56.00	-24.05	QP	
9	1.1580	-1.26	20.00	18.74	46.00	-27.26	AVG	
10	1.4060	11.79	20.00	31.79	56.00	-24.21	QP	
11	1.9620	-1.60	20.00	18.40	46.00	-27.60	AVG	
12	3.9100	-1.62	20.00	18.38	46.00	-27.62	AVG	

**CONDUCTED EMISSION TEST DATA**

Test Site: 1# Shielded Room  
 Operating Condition: Charging  
 Test Specification: AC 120V, 60Hz for adapter  
 Comment: Neutral Line  
 Tem.:25°C Hum.:50%

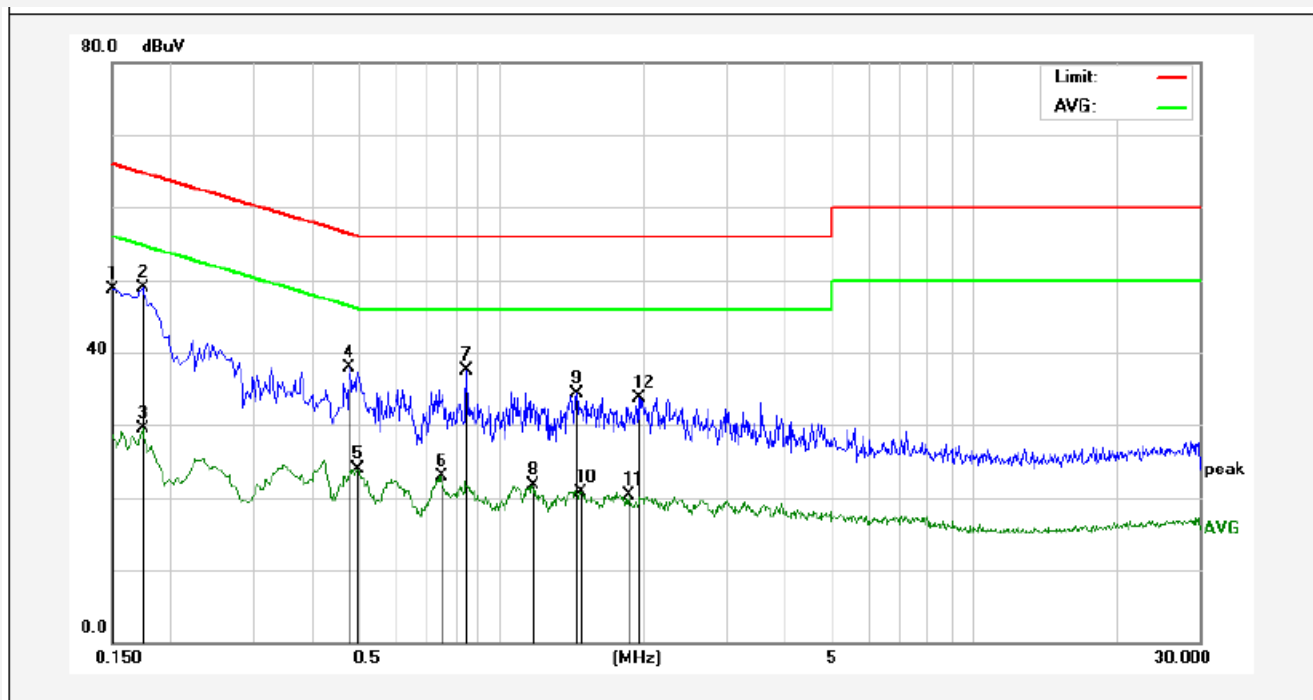

No.	Freq. (MHz)	Reading (dBuV)	Factor (dB)	Result (dBuV)	Limit dBuV	Over Limit (dB)	Detector	Remark
1	0.1499	28.71	20.00	48.71	66.00	-17.29	QP	
2	0.1740	28.98	20.00	48.98	64.76	-15.78	QP	
3	0.1740	9.42	20.00	29.42	54.76	-25.34	AVG	
4	0.4780	17.86	20.00	37.86	56.37	-18.51	QP	
5	0.4980	3.84	20.00	23.84	46.03	-22.19	AVG	
6	0.7460	2.88	20.00	22.88	46.00	-23.12	AVG	
7	0.8460	17.47	20.00	37.47	56.00	-18.53	QP	
8	1.1620	1.65	20.00	21.65	46.00	-24.35	AVG	
9	1.4420	14.34	20.00	34.34	56.00	-21.66	QP	
10	1.4740	0.77	20.00	20.77	46.00	-25.23	AVG	
11	1.8620	0.25	20.00	20.25	46.00	-25.75	AVG	
12	1.9500	13.66	20.00	33.66	56.00	-22.34	QP	

**CONDUCTED EMISSION TEST DATA**

Test Site: 1# Shielded Room  
 Operating Condition: Charging  
 Test Specification: AC 240V, 60Hz for adapter  
 Comment: Live Line  
 Tem.:25°C Hum.:50%

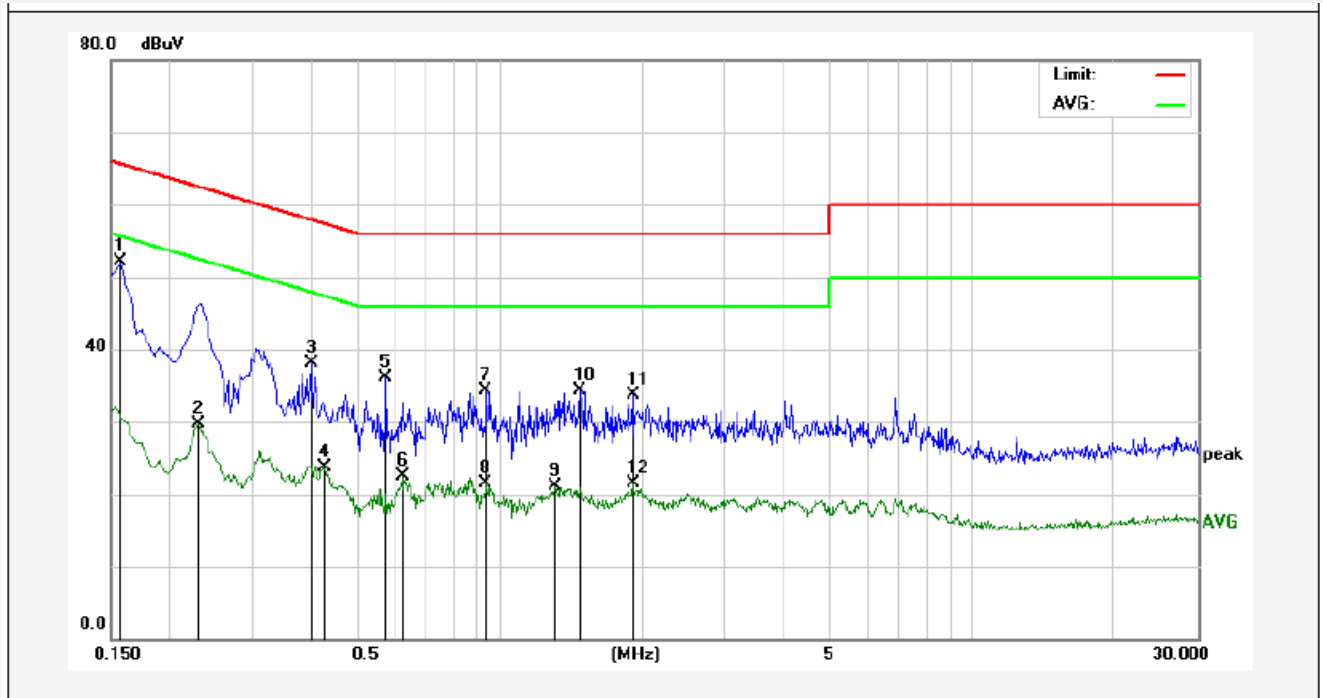

No.	Freq. (MHz)	Reading (dBuV)	Factor (dB)	Result (dBuV)	Limit dBuV	Over Limit (dB)	Detector	Remark
1	0.1580	32.04	20.00	52.04	65.56	-13.52	QP	
2	0.2300	9.70	20.00	29.70	52.45	-22.75	AVG	
3	0.3980	18.13	20.00	38.13	57.89	-19.76	QP	
4	0.4260	3.71	20.00	23.71	47.33	-23.62	AVG	
5	0.5740	16.09	20.00	36.09	56.00	-19.91	QP	
6	0.6220	2.54	20.00	22.54	46.00	-23.46	AVG	
7	0.9380	14.34	20.00	34.34	56.00	-21.66	QP	
8	0.9380	1.53	20.00	21.53	46.00	-24.47	AVG	
9	1.3140	1.17	20.00	21.17	46.00	-24.83	AVG	
10	1.4740	14.29	20.00	34.29	56.00	-21.71	QP	
11	1.9100	13.71	20.00	33.71	56.00	-22.29	QP	
12	1.9100	1.43	20.00	21.43	46.00	-24.57	AVG	

**CONDUCTED EMISSION TEST DATA**

Test Site: 1# Shielded Room  
 Operating Condition: Charging  
 Test Specification: AC 240V, 60Hz for adapter  
 Comment: Neutral Line  
 Tem.:25°C Hum.:50%

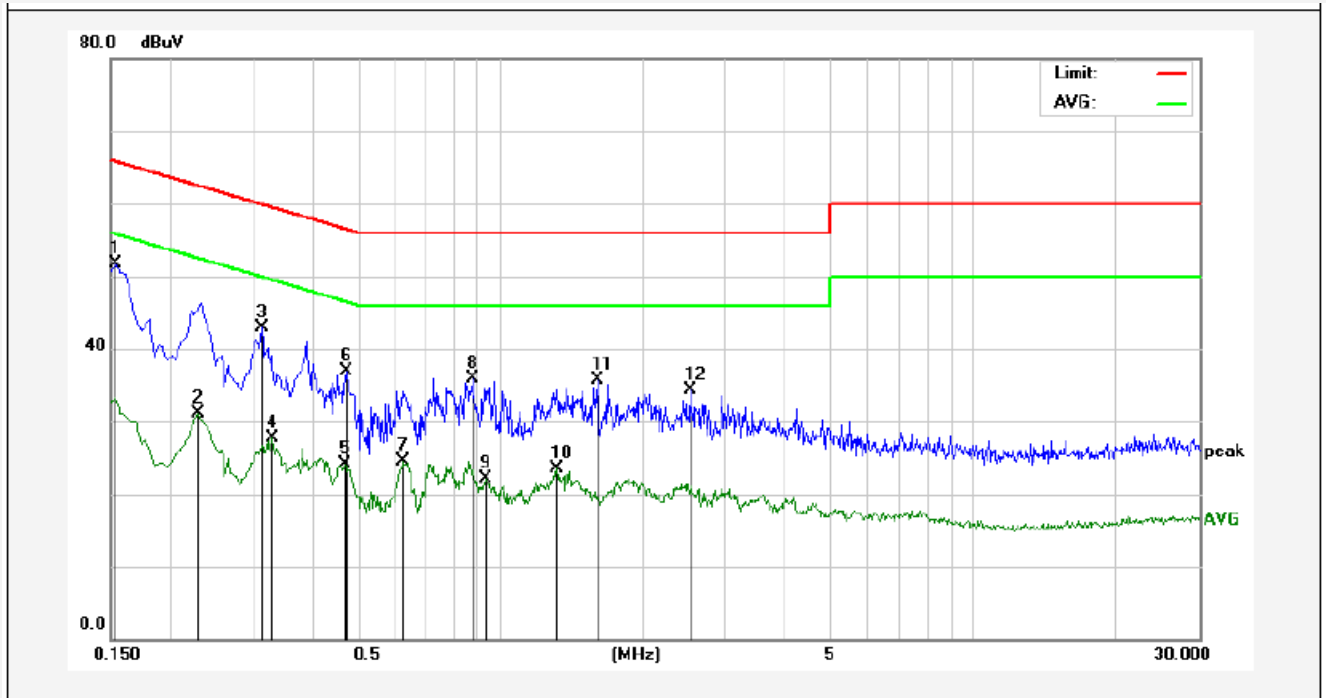

No.	Freq. (MHz)	Reading (dBuV)	Factor (dB)	Result (dBuV)	Limit dBuV	Over Limit (dB)	Detector	Remark
1	0.1539	31.76	20.00	51.76	65.78	-14.02	QP	
2	0.2300	11.03	20.00	31.03	52.45	-21.42	AVG	
3	0.3140	23.00	20.00	43.00	59.86	-16.86	QP	
4	0.3300	7.66	20.00	27.66	49.45	-21.79	AVG	
5	0.4700	4.17	20.00	24.17	46.51	-22.34	AVG	
6	0.4740	16.91	20.00	36.91	56.44	-19.53	QP	
7	0.6260	4.52	20.00	24.52	46.00	-21.48	AVG	
8	0.8740	15.94	20.00	35.94	56.00	-20.06	QP	
9	0.9380	2.17	20.00	22.17	46.00	-23.83	AVG	
10	1.3180	3.41	20.00	23.41	46.00	-22.59	AVG	
11	1.6060	15.65	20.00	35.65	56.00	-20.35	QP	
12	2.5180	14.32	20.00	34.32	56.00	-21.68	QP	

## 4. Radiation Interference

### 4.1 Requirements (15.247, 15.209):

#### 4.1.1. Test Limits (< 30 MHz)

Frequency (MHz)	Field Strength (microvolts/meter)	Measurement Distance (meter)
0.009-0.490	2400/F(kHz)	300
0.490-1.705	24000/F(kHz)	30
1.705-30.0	30	30

#### 4.1.2. Test Limits ( $\geq$ 30 MHz)

FIELD STRENGTH of Fundamental: @3M	FIELD STRENGTH of Harmonics	S15.209	
902-928 MHz		30 - 88 MHz	40 dBuV/m
2.4-2.4835 GHz		88 - 216 MHz	43.5
94 dB $\mu$ V/m @3m	54 dB $\mu$ V/m @3m	216 - 960 MHz	46
		ABOVE 960 MHz	54dBuV/m

For range 9KHz~30MHz, The measured value is really too low to be recorded.

Emissions radiated outside of the specified frequency bands, except for harmonics, shall be attenuated by at least 50 dB below the level of the fundamental or to the general radiated emission limits in 15.209, whichever is the lesser attenuation.

### 4.2 Test Procedure

For below 1GHz: The EUT is placed on a turntable, which is 0.8m above the ground plane.  
For above 1GHz: The EUT is placed on a turntable, which is 1.5m above the ground plane.  
The turn table can rotate 360 degrees to determine the position of the maximum emission level.  
The EUT is set 3 meters away from the receiving antenna which is mounted on a antenna tower.  
The antenna can be moved up and down from 1 to 4 meters to find out the maximum emission level. Rotated the EUT through three orthogonal axes to determine the maximum emissions, both horizontal and vertical polarization of the antenna are set on test. The EUT is tested in 9\*6\*6 Chamber. The device is evaluated in xyz orientation.

#### **For 30MHz to 1000MHz:**

Set the spectrum analyzer as:  
RBW = 100kHz, VBW =300kHz,  
Detector= Quasi-Peak  
Trace mode= Max hold.  
Sweep- auto couple.

#### **For Above 1GHz:**

Set the spectrum analyzer as:  
RBW = 1MHz, VBW =3MHz,  
Detector= Peak  
Trace mode= Max hold.  
Sweep- auto couple.

Set the spectrum analyzer as:  
RBW =1MHz, VBW =10Hz  
Detector= Average  
Trace mode= Max hold.  
Sweep- auto couple.

Test Equipment

Item	Equipment	Manufacturer	Model No.	Serial No.	Last Cal.	Cal. Interval
1.	Spectrum Analysis	Agilent	E4407B	US39390582	Apr. 17, 2016	1 Year
2.	Preamplifier	Instruments corporation	EMC011830	980100	Apr. 17, 2016	1 Year
3.	EMI Test Receiver	Rohde & Schwarz	ESPI	101604	Apr. 17, 2016	1 Year
4.	Double Ridged Horn Antenna	Instruments corporation	GTH-0118	351600	Apr. 20, 2016	1 Year
5.	Bilog Broadband Antenna	Schwarzbeck	VULB9163	VULB 9163-289	Apr. 20, 2016	1 Year
6.	Pre-amplifier	SONOMA	310N	186860	Apr. 17, 2016	1 Year
7.	EMI Test Software EZ-EMC	SHURPLE	N/A	N/A	N/A	N/A
8	Power Sensor	DAER	RPR3006W	15I00041SN046	Jun 30, 2016	1 Year
9	MXA Spectrum Analysis	Agilent	N9020A	MY51170037	Jun 30, 2016	1 Year
10	MXG RF Vector Signal Generator	Agilent	N5182A	MY48180656	Jun 30, 2016	1 Year
11	Signal Generator	Agilent	E4421B	MY41000743	Jun 30, 2016	1 Year
12	DC Power supply	IV	IV-8080	YQSB0096	Jun 30, 2016	1 Year
13	TEMP&HUMI PROGRAMMABLE CHAMBER	Bell Group	BE-THK-150M8	SE-0137	Mar 16, 2016	1 Year

4.3 Test Configuration

4.3.1. 9k to 30MHz emissions:

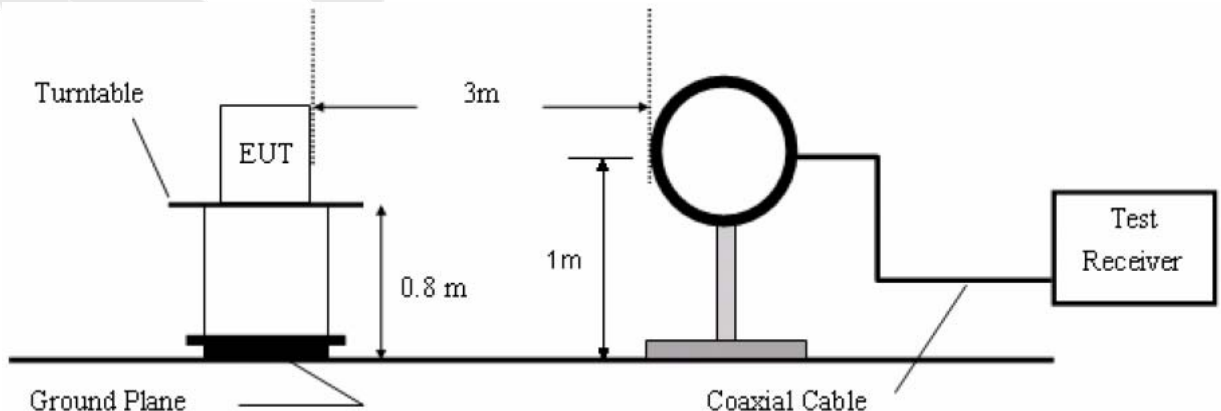



4.3.2. 30M to 1G emissions:

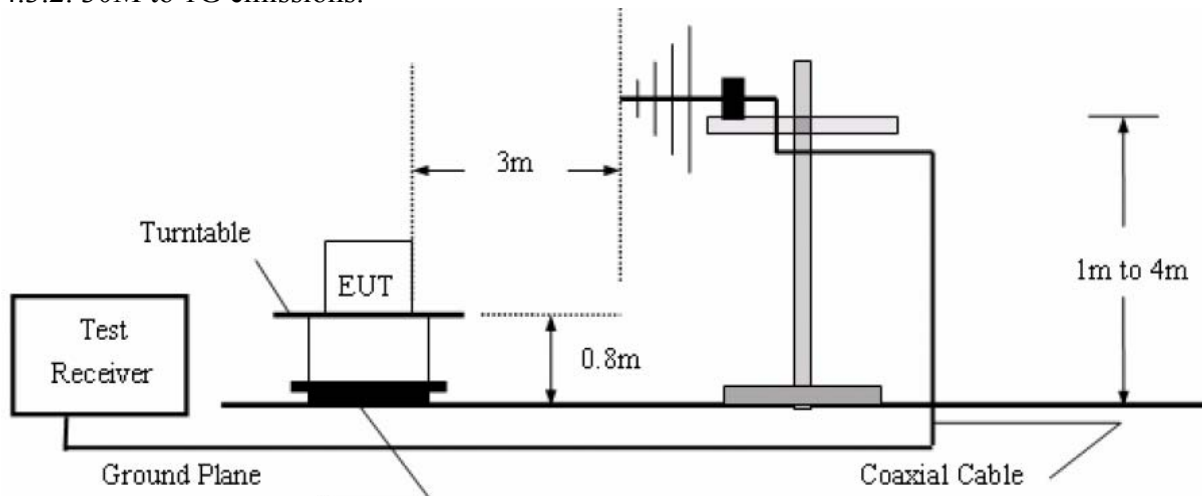

4.3.3. 1G to 40G emissions:

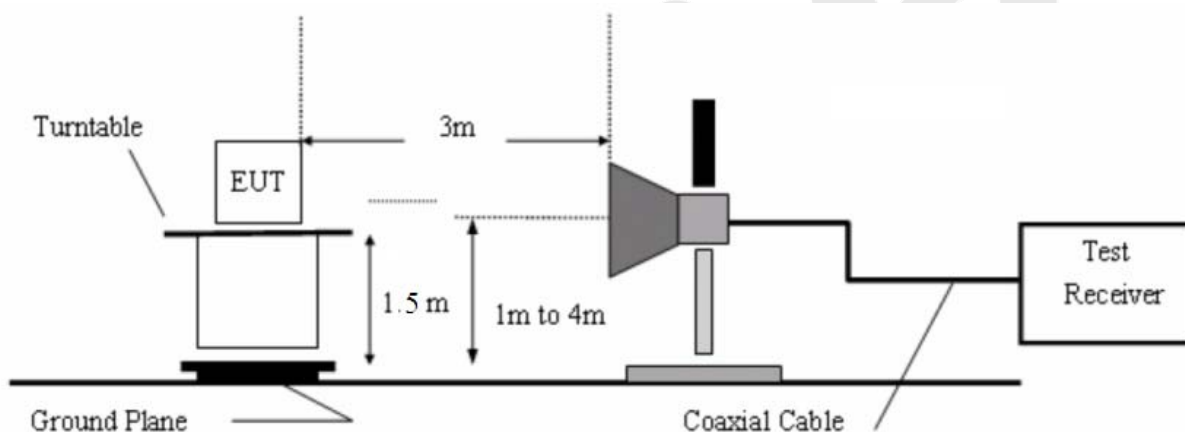

4.4 Test Results

PASS.

The EUT was tested on (Charging, BT Mode) modes, only the worst data of (BT Mode) is attached in the following pages.

Only the worst case (x orientation).

The EDR was tested on ( $\pi/4$ DQPSK, 8DPSK) modes, only the worst data of ( $\pi/4$ DQPSK) is attached in the following pages.

The test results of above 18000MHz are attenuated more than 20dB below the permissible limits, so the results don't record in the report.



Job No.:	011607354I	Polarization:	Horizontal
Standard:	(RE)FCC PART 15C _3m	Power Source:	AC 120V, 60Hz for adapter
Test item:	Radiation Test (30~1000MHz)	Temp.(C)/Hum.(%RH):	24.3( C)/55%RH
Test Mode:	BT Mode	Distance:	3m

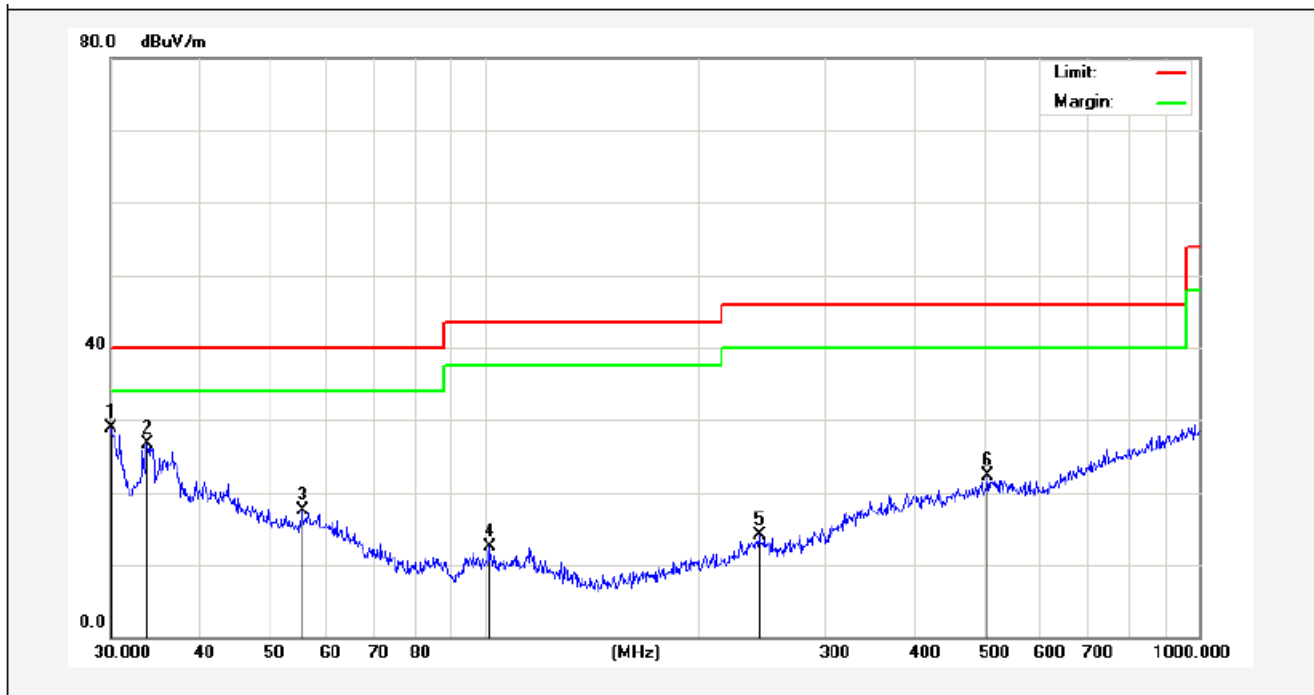

No.	Freq. (MHz)	Reading (dBuV/m)	Factor (dB/m)	Result (dBuV/m)	Limit (dBuV/)	Over Limit (dB)	Detector	Height (cm)	degree (deg)	Remark
1	30.0000	45.81	-16.95	28.86	40.00	-11.14	peak			
2	33.7986	41.57	-14.92	26.65	40.00	-13.35	peak			
3	55.6094	32.43	-14.99	17.44	40.00	-22.56	peak			
4	101.6443	33.19	-20.74	12.45	43.50	-31.05	peak			
5	242.5253	32.28	-18.21	14.07	46.00	-31.93	peak			
6	506.4791	33.25	-10.97	22.28	46.00	-23.72	peak			

Job No.:	011607354I	Polarization:	Vertical
Standard:	(RE)FCC PART 15C _3m	Power Source:	AC 120V, 60Hz for adapter
Test item:	Radiation Test (30~1000MHz)	Temp.(C)/Hum.(%RH):	24.3( C)/55%RH
Test Mode:	BT Mode	Distance:	3m

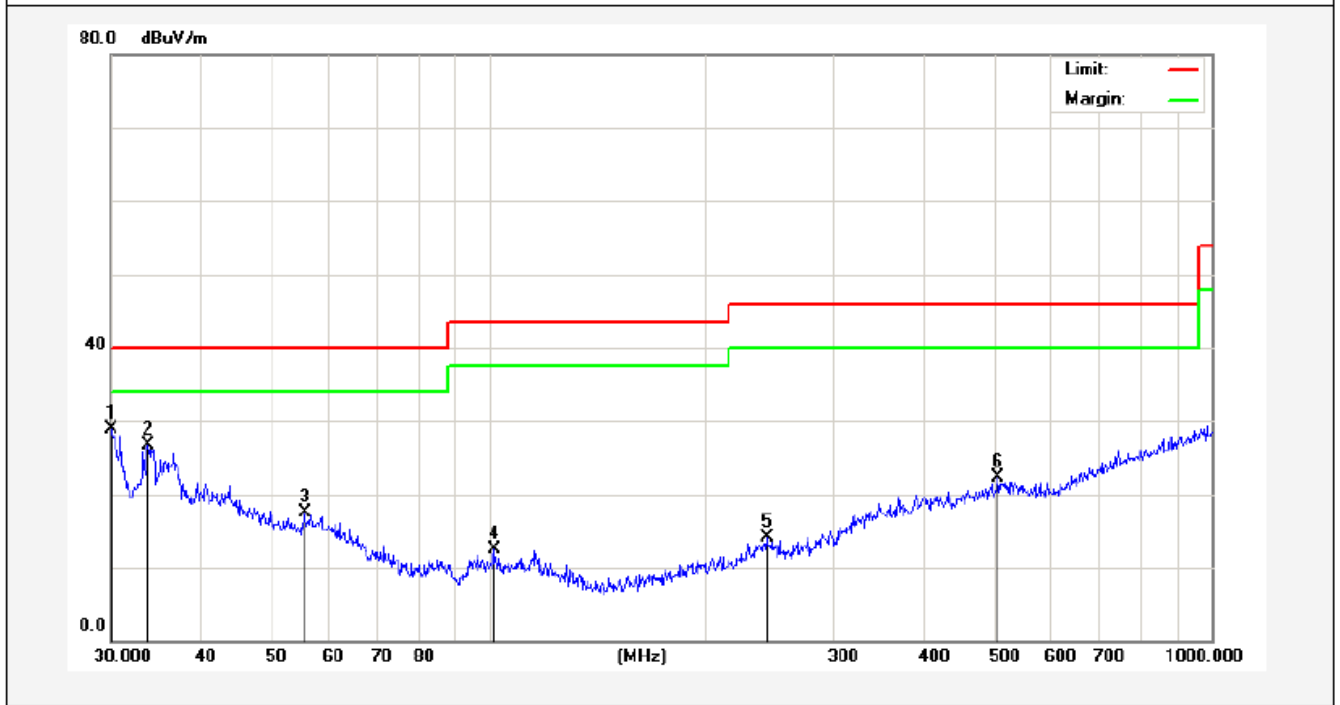

No.	Freq. (MHz)	Reading (dBuV/m)	Factor (dB/m)	Result (dBuV/m)	Limit (dBuV/)	Over Limit (dB)	Detector	Height (cm)	degree (deg)	Remark
1	30.0000	45.81	-16.95	28.86	40.00	-11.14	peak			
2	33.7986	41.57	-14.92	26.65	40.00	-13.35	peak			
3	55.6094	32.43	-14.99	17.44	40.00	-22.56	peak			
4	101.6443	33.19	-20.74	12.45	43.50	-31.05	peak			
5	242.5253	32.28	-18.21	14.07	46.00	-31.93	peak			
6	506.4791	33.25	-10.97	22.28	46.00	-23.72	peak			

Job No.:	011607354I	Polarization:	Horizontal
Standard:	(RE)FCC PART 15C_Class B_3m	Power Source:	AC 120V, 60Hz for adapter
Test item:	Radiation Test (Above 1GHz)	Temp.(C)/Hum.(%RH):	24.3( C)/55%RH
Test Mode:	TX(2402 MHz)	Distance:	3m

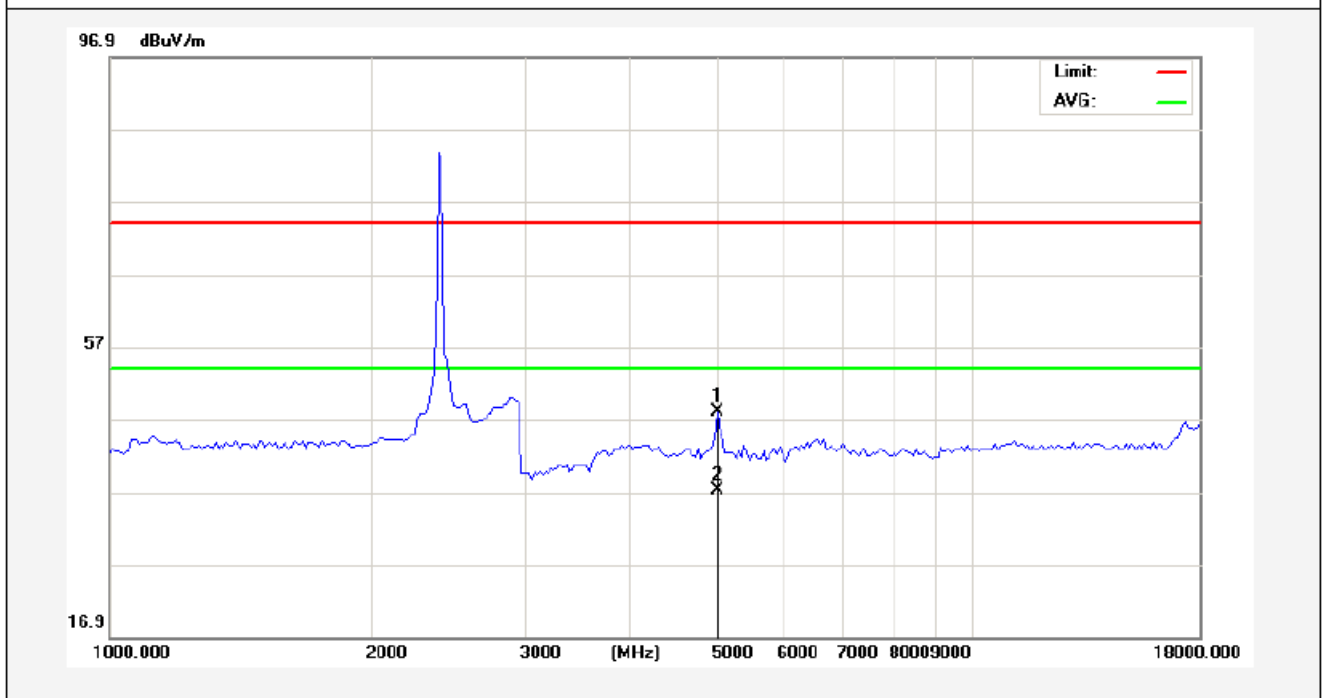

No.	Freq. (MHz)	Reading (dBuV/m)	Factor (dB/m)	Result (dBuV/m)	Limit (dBuV/)	Over Limit (dB)	Detector	Height (cm)	degree (deg)	Remark
1	5037.500	44.26	3.67	47.93	74.00	-26.07	peak			
2	5037.500	33.45	3.67	37.12	54.00	-16.88	AVG			

Job No.:	011607354I	Polarization:	Vertical
Standard:	(RE)FCC PART 15C_Class B_3m	Power Source:	AC 120V, 60Hz for adapter
Test item:	Radiation Test (Above 1GHz)	Temp.(C)/Hum.(%RH):	24.3( C)/55%RH
Test Mode:	TX(2402 MHz)	Distance:	3m

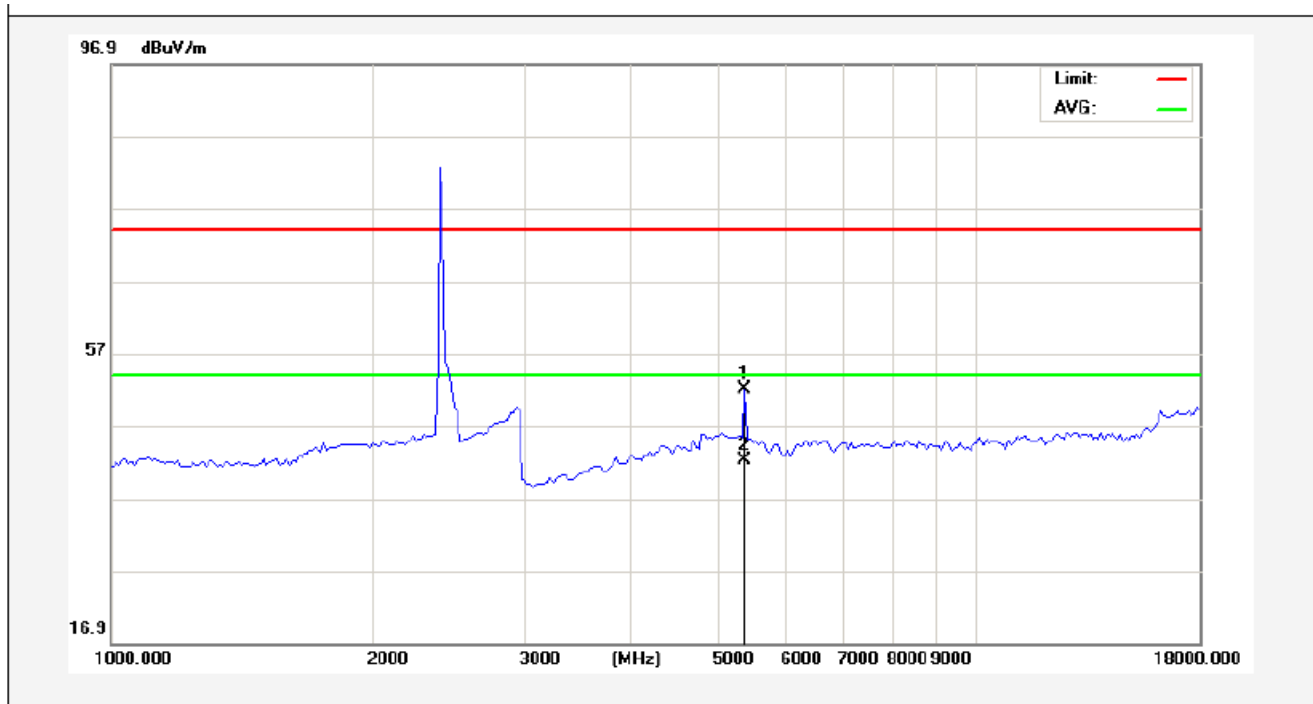

No.	Freq. (MHz)	Reading (dBuV/m)	Factor (dB/m)	Result (dBuV/m)	Limit (dBuV/)	Over Limit (dB)	Detector	Height (cm)	degree (deg)	Remark
1	5420.000	48.16	3.94	52.10	74.00	-21.90	peak			
2	5420.000	38.19	3.94	42.13	54.00	-11.87	AVG			

Job No.:	011607354I	Polarization:	Horizontal
Standard:	(RE)FCC PART 15C_Class B_3m	Power Source:	AC 120V, 60Hz for adapter
Test item:	Radiation Test (Above 1GHz)	Temp.(C)/Hum.(%RH):	24.3( C)/55%RH
Test Mode:	TX(2441 MHz)	Distance:	3m

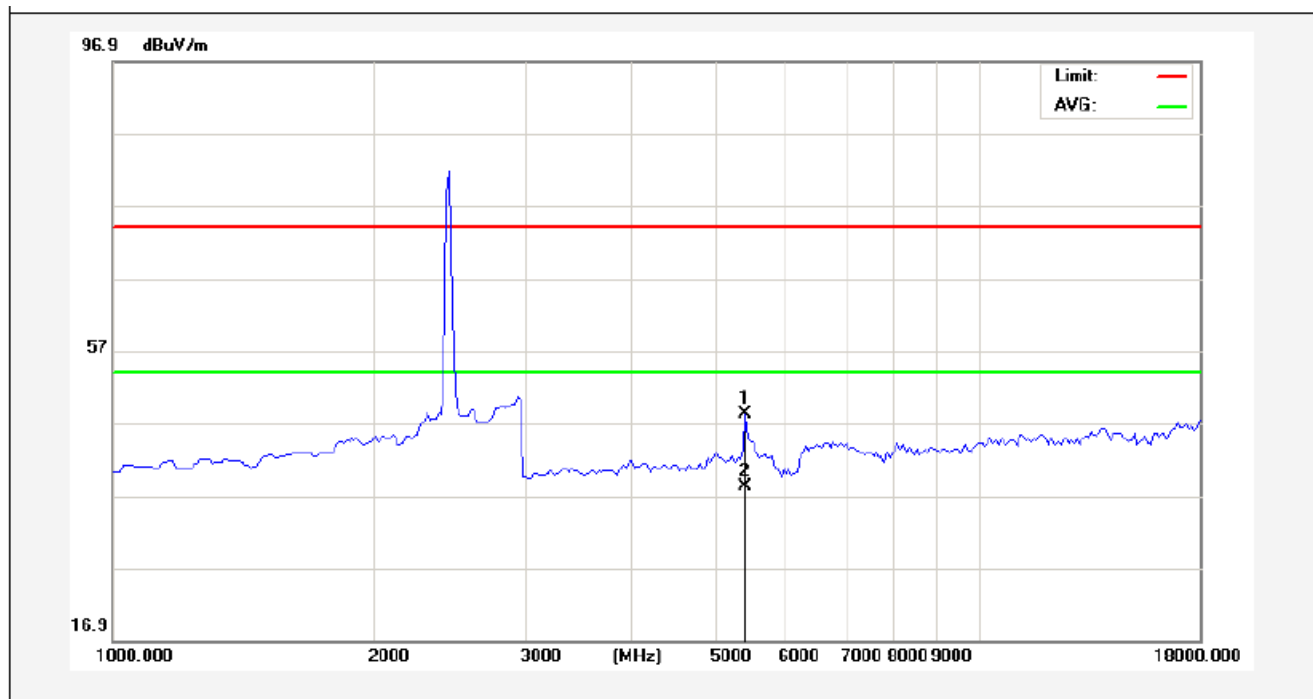

No.	Freq. (MHz)	Reading (dBuV/m)	Factor (dB/m)	Result (dBuV/m)	Limit (dBuV/)	Over Limit (dB)	Detector	Height (cm)	degree (deg)	Remark
1	5420.000	44.32	3.94	48.26	74.00	-25.74	peak			
2	5420.000	34.19	3.94	38.13	54.00	-15.87	AVG			

Job No.:	011607354I	Polarization:	Vertical
Standard:	(RE)FCC PART 15C_Class B_3m	Power Source:	AC 120V, 60Hz for adapter
Test item:	Radiation Test (Above 1GHz)	Temp.(C)/Hum.(%RH):	24.3( C)/55%RH
Test Mode:	TX(2441 MHz)	Distance:	3m

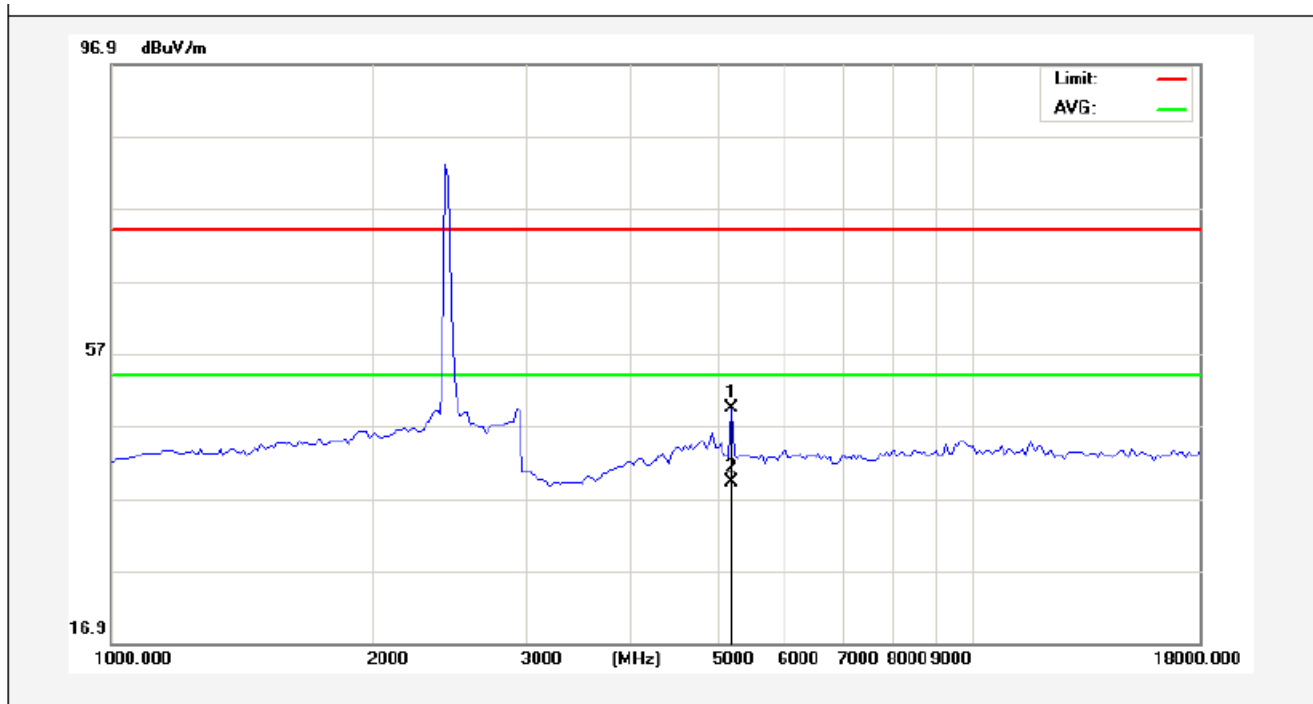

No.	Freq. (MHz)	Reading (dBuV/m)	Factor (dB/m)	Result (dBuV/m)	Limit (dBuV/)	Over Limit (dB)	Detector	Height (cm)	degree (deg)	Remark
1	5207.500	45.56	3.79	49.35	74.00	-24.65	peak			
2	5207.500	35.33	3.79	39.12	54.00	-14.88	AVG			

Job No.:	011607354I	Polarization:	Horizontal
Standard:	(RE)FCC PART 15C_Class B_3m	Power Source:	AC 120V, 60Hz for adapter
Test item:	Radiation Test (Above 1GHz)	Temp.(C)/Hum.(%RH):	24.3( C)/55%RH
Test Mode:	TX(2480 MHz)	Distance:	3m

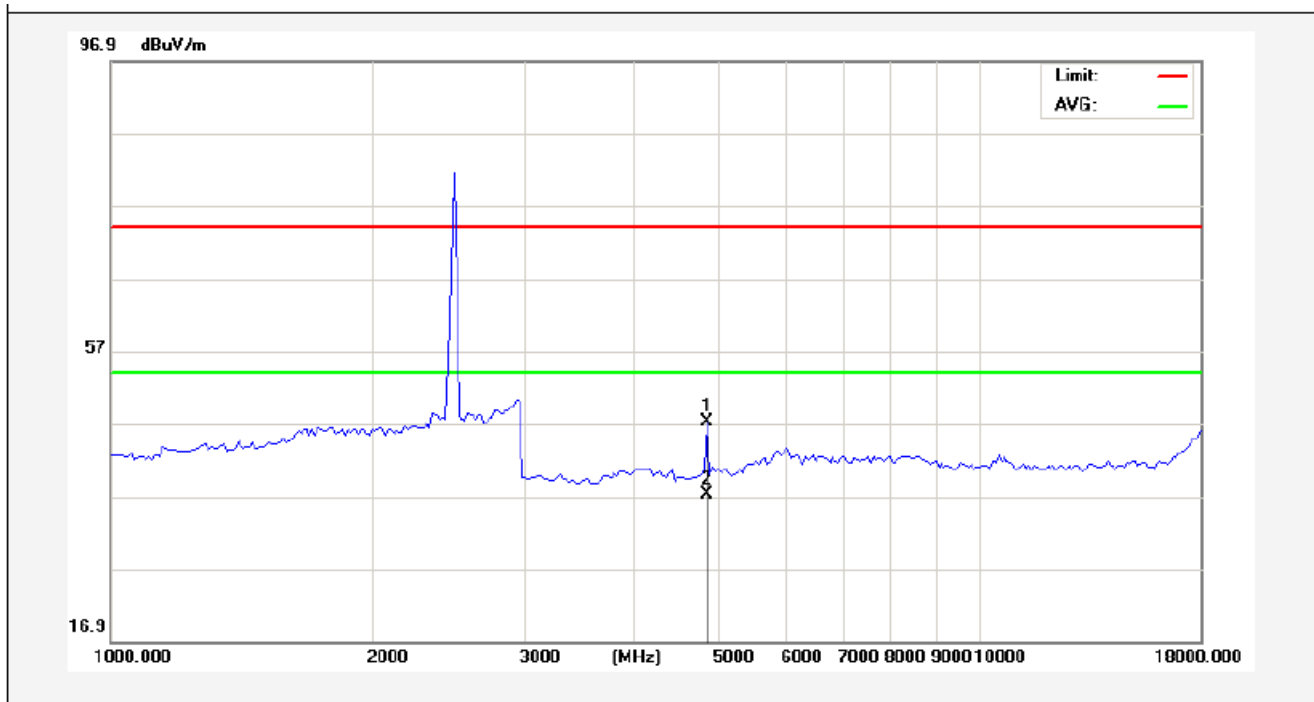

No.	Freq. (MHz)	Reading (dBuV/m)	Factor (dB/m)	Result (dBuV/m)	Limit (dBuV/)	Over Limit (dB)	Detector	Height (cm)	degree (deg)	Remark
1	4867.500	43.85	3.41	47.26	74.00	-26.74	peak			
2	4867.500	33.72	3.41	37.13	54.00	-16.87	AVG			

Job No.:	011607354I	Polarization:	Vertical
Standard:	(RE)FCC PART 15C_Class B_3m	Power Source:	AC 120V, 60Hz for adapter
Test item:	Radiation Test (Above 1GHz)	Temp.(C)/Hum.(%RH):	24.3( C)/55%RH
Test Mode:	TX(2480 MHz)	Distance:	3m

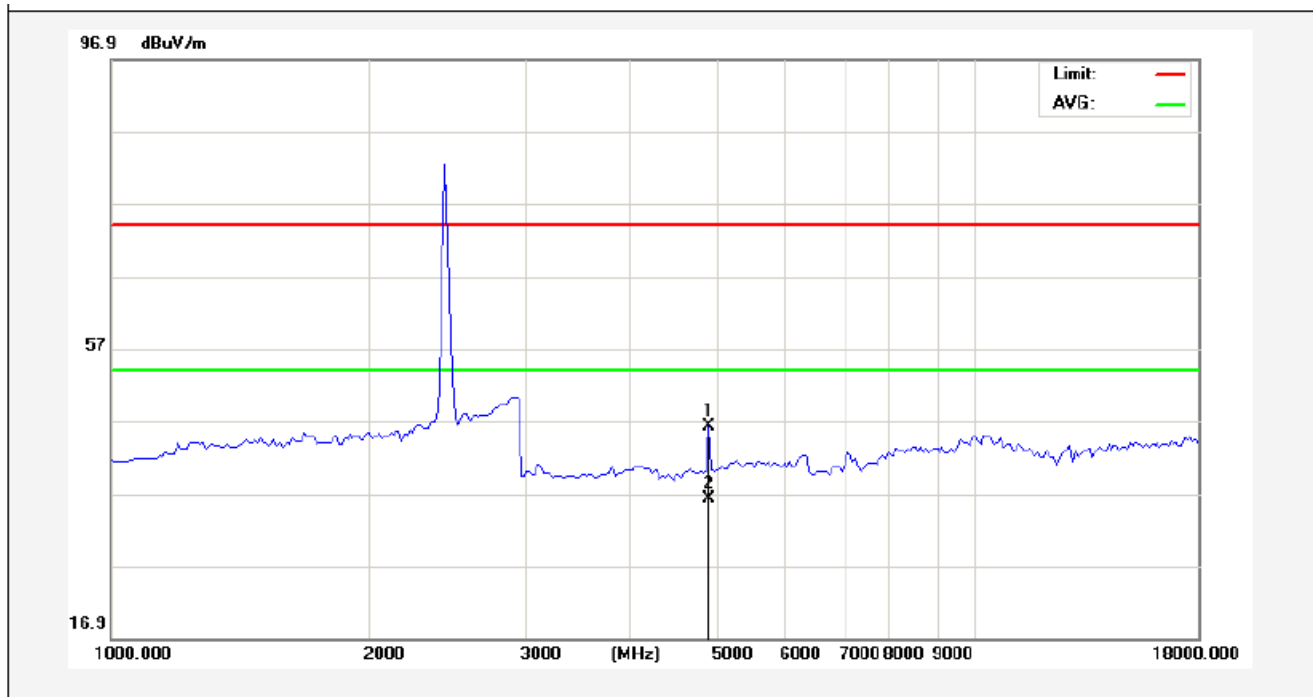

No.	Freq. (MHz)	Reading (dBuV/m)	Factor (dB/m)	Result (dBuV/m)	Limit (dBuV/)	Over Limit (dB)	Detector	Height (cm)	degree (deg)	Remark
1	4910.000	42.74	3.49	46.23	74.00	-27.77	peak			
2	4910.000	32.63	3.49	36.12	54.00	-17.88	AVG			



## 5. CHANNEL SEPARATION TEST

### 5.1 Measurement Procedure

The EUT must have its hopping function enabled. Using the following spectrum analyzer settings:

1. Span= Wide enough to capture the peaks of two adjacent channels
2. Set the RBW = 100 kHz.
3. Set the VBW = 100 kHz.
4. Sweep time = auto couple.
5. Detector function = peak.
6. Trace mode = max hold.
7. Allow trace to fully stabilize.

### 5.2 Test SET-UP

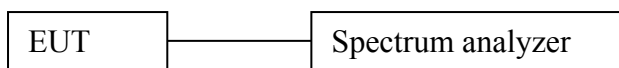

### 5.3 Test Equipment

Item	Equipment	Manufacturer	Model No.	Serial No.	Last Cal.	Cal. Interval
1.	Spectrum Analysis	Agilent	E4407B	US39390582	Apr. 17, 2016	1 Year
2.	Preamplifier	Instruments corporation	EMC011830	980100	Apr. 17, 2016	1 Year
3.	EMI Test Receiver	Rohde & Schwarz	ESPI	101604	Apr. 17, 2016	1 Year
4.	Double Ridged Horn Antenna	Instruments corporation	GTH-0118	351600	Apr. 20, 2016	1 Year
5.	Bilog Broadband Antenna	Schwarzbeck	VULB9163	VULB 9163-289	Apr. 20, 2016	1 Year
6.	Pre-amplifier	SONOMA	310N	186860	Apr. 17, 2016	1 Year
7.	EMI Test Software EZ-EMC	SHURPLE	N/A	N/A	N/A	N/A
8	Power Sensor	DAER	RPR3006W	15I00041SN046	Jun 30, 2016	1 Year
9	MXA Spectrum Analysis	Agilent	N9020A	MY51170037	Jun 30, 2016	1 Year
10	MXG RF Vector Signal Generator	Agilent	N5182A	MY48180656	Jun 30, 2016	1 Year
11	Signal Generator	Agilent	E4421B	MY41000743	Jun 30, 2016	1 Year
12	DC Power supply	IV	IV-8080	YQSB0096	Jun 30, 2016	1 Year
13	TEMP&HUMI PROGRAMMABLE CHAMBER	Bell Group	BE-THK-150M8	SE-0137	Mar 16, 2016	1 Year

#### 5.4 Test Results

Test Item : Frequency Separation Test Mode : CH Low ~ CH High  
 Test Voltage : AC 120V, 60Hz for adapter Temperature : 24°C  
 Test Result : PASS Humidity : 55%RH

Channel	Frequency (MHz)	Separation Read Value (kHz)	Limit (kHz)	Modulation Mode
Low	2401	1002	928.6	BDR
Mid	2441	1002	931.8	BDR
High	2480	1002	931.4	BDR
Low	2401	1002	843.3	EDR
Mid	2441	1002	836.0	EDR
High	2480	1002	842.7	EDR

Remark:

1. The limit of mode (EDR) is 2/3 of 20dB BW;
2. The EDR was tested on ( $\pi/4$ DQPSK, 8DPSK) modes, only the worst data of ( $\pi/4$ DQPSK) is attached in the following pages.



Test Mode: BDR---Low

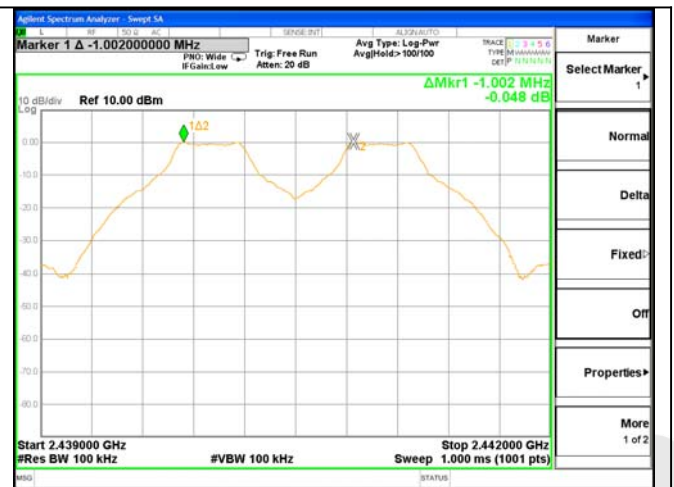

Test Mode: BDR---Mid



Test Mode: BDR---High

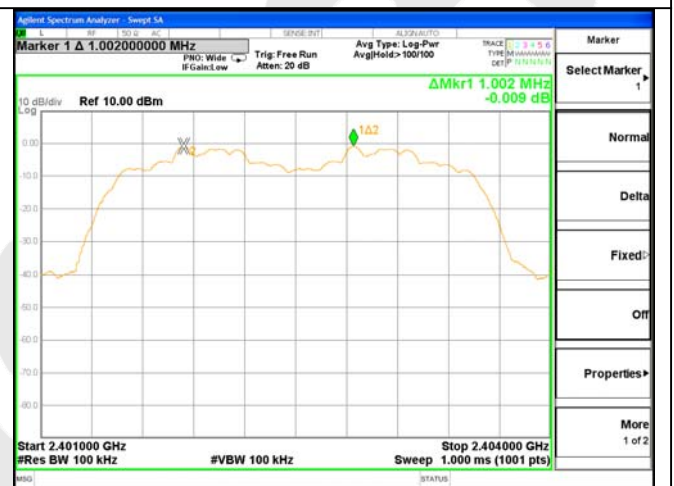

Test Mode: EDR---Low



Test Mode: EDR---Mid

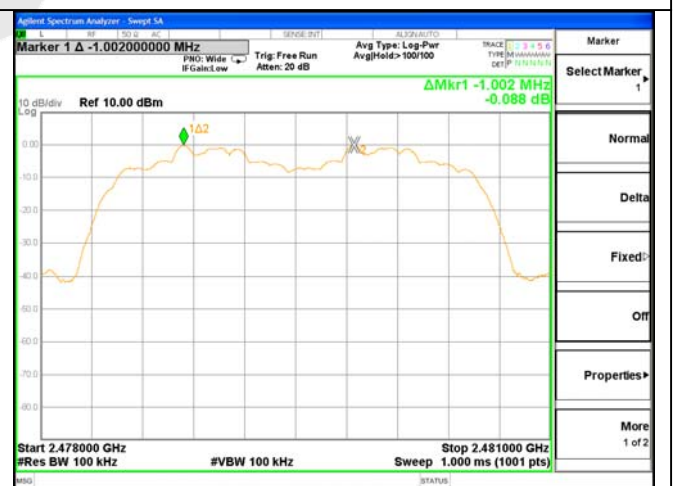

Test Mode: EDR---High

## 6. 20DB BANDWIDTH TEST

### 6.1 Measurement Procedure

Using the following spectrum analyzer settings:

1. Span= approximately 2 to 3 times the 20dB bandwidth, centered on a hopping channel.
2. Set the RBW = 30 kHz.
3. Set the VBW = 100 kHz.
4. Sweep time = auto couple.
5. Detector function = peak.
6. Trace mode = max hold.
7. Allow trace to fully stabilize.

### 6.2 Test SET-UP

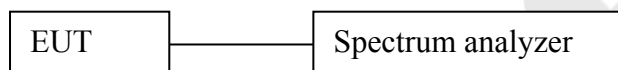

### 6.3 Test Equipment

Same as the equipment listed in 5.3.

### 6.4 Test Results

Test Item	: 20dB BW	Test Mode	: CH Low ~ CH High
Test Voltage	: AC 120V, 60Hz for adapter	Temperature	: 24°C
Test Result	: PASS	Humidity	: 55%RH

Channel	Frequency (MHz)	20dB Down BW(kHz)	Modulation Mode
Low	2401	928.6	BDR
Mid	2441	931.8	BDR
High	2480	931.4	BDR
Low	2401	1265.0	EDR
Mid	2441	1254.0	EDR
High	2480	1261.0	EDR

Remark: The EDR was tested on ( $\pi/4$ DQPSK, 8DPSK) modes, only the worst data of ( $\pi/4$ DQPSK) is attached in the following pages.

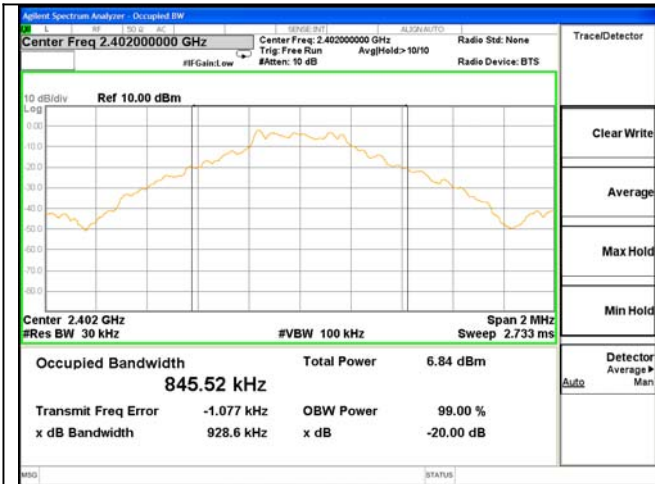

Test Mode: BDR---Low

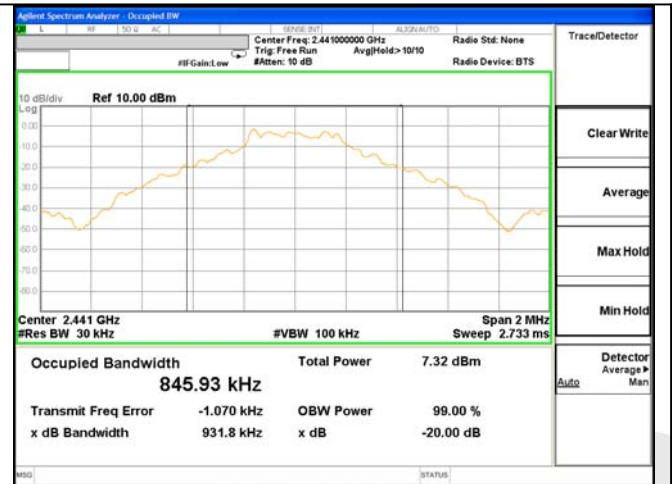

Test Mode: BDR---Mid

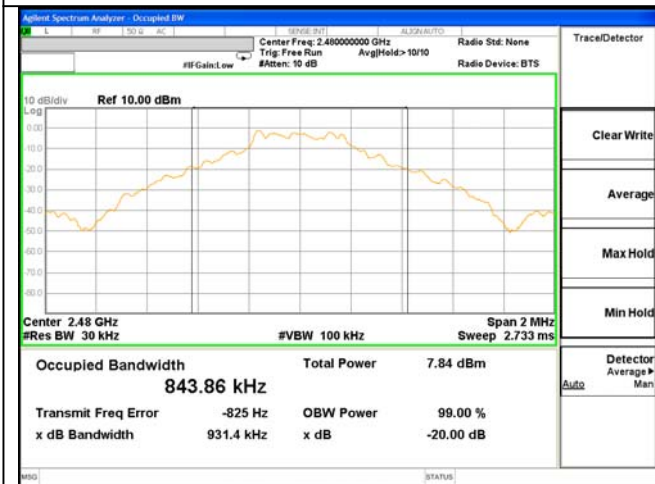

Test Mode: BDR---High

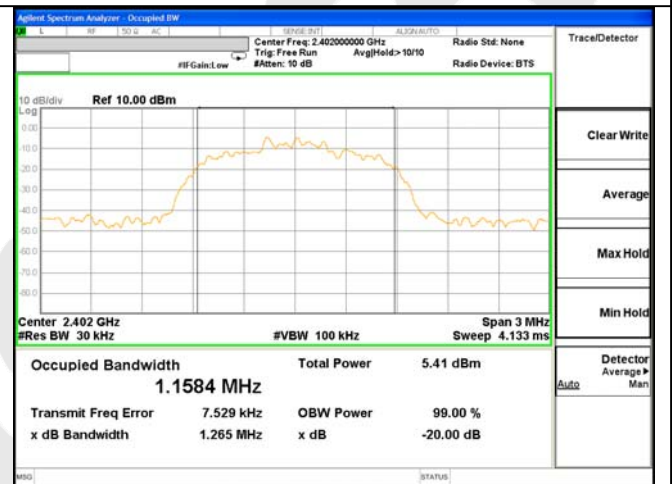

Test Mode: EDR---Low

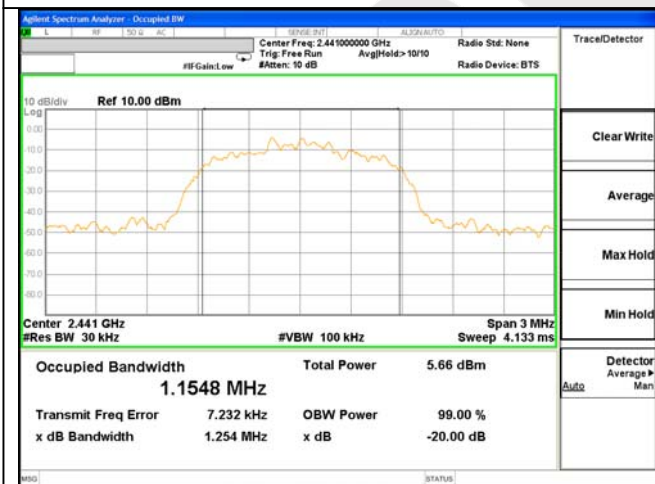

Test Mode: EDR---Mid

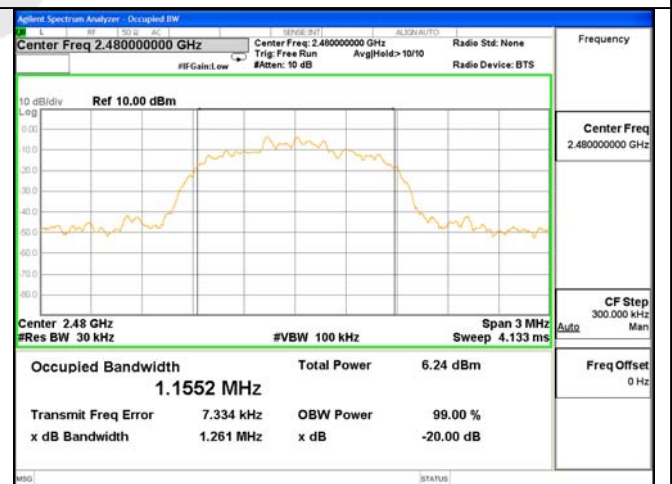

Test Mode: EDR---High

## 7. QUANTITY OF HOPPING CHANNEL TEST

### 7.1 Measurement Procedure

The EUT must have its hopping function enabled. Using the following spectrum analyzer setting:

1. Span= the frequency band of operation
2. Set the RBW = 1 MHz.
3. Set the VBW = 50 MHz.
4. Sweep time = auto couple.
5. Detector function = peak.
6. Trace mode = max hold.
7. Allow trace to fully stabilize.

### 7.2 Test SET-UP

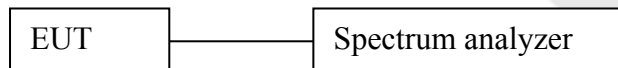

### 7.3 Test Equipment

Same as the equipment listed in 5.3.

### 7.4 Test Results

Test Item	: Number of Hopping Frequency	Test Mode	: CH Low ~ CH High
Test Voltage	: AC 120V, 60Hz for adapter	Temperature	: 24°C
Test Result	: PASS	Humidity	: 55%RH

Hopping Channel Frequency Range	Quantity of Hopping Channel	Quantity of Hopping Channel
2402-2480	79	> 15

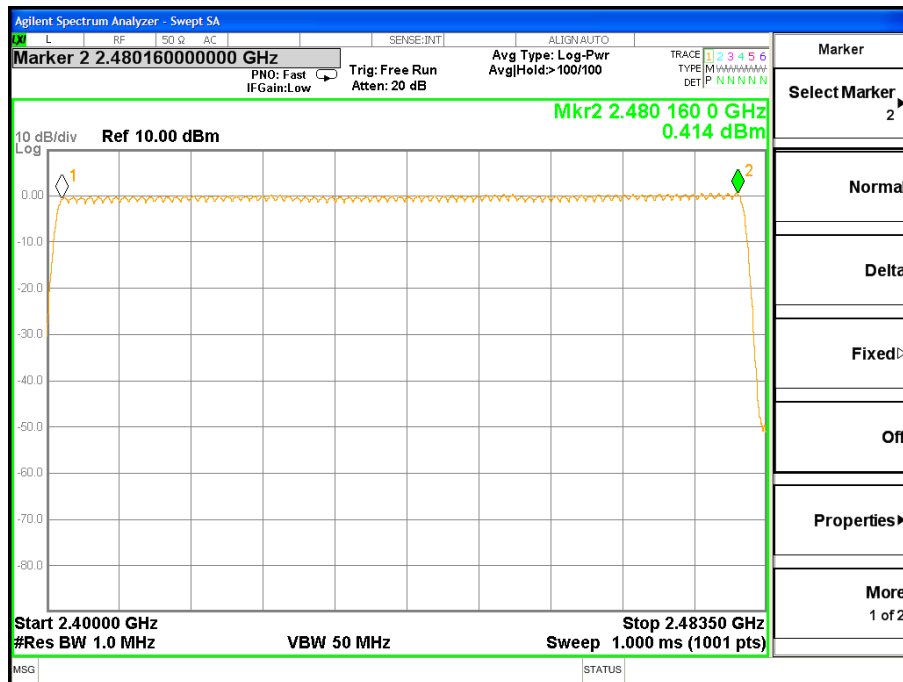

## 8. DWELL TIME TEST

### 8.1 Measurement Procedure

The EUT must have its hopping function enabled. Use the following spectrum analyzer settings:

1. Span= zero span, centered on a hopping channel
2. Set the RBW = 1 MHz.
3. Set the VBW = 1 MHz.
4. Sweep time = as necessary to capture the entire dwell time per hopping channel.
5. Detector function = peak.
6. Trace mode = max hold.
7. Allow trace to fully stabilize.

### 8.2 Test SET-UP

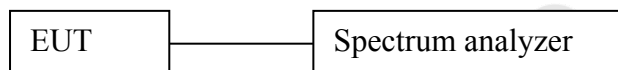

### 8.3 Test Equipment

Same as the equipment listed in 5.3.

### 8.4 Test Results

Test Item	: Time of Occupancy	Test Mode	: CH Low ~ CH High
Test Voltage	: AC 120V, 60Hz for adapter	Temperature	: 24°C
Test Result	: PASS	Humidity	: 55%RH

Package Type	Pulse width (ms)	Time slot length(ms)	Dwell time (ms)	Limit (s)	Modulation
DH1	0.368	time slot length * 1600/2 /79 * 31.6	117.8	0.4	BDR
DH3	1.610	time slot length * 1600/4 /79 * 31.6	257.6	0.4	BDR
DH5	2.855	time slot length * 1600/6 /79 * 31.6	304.5	0.4	BDR
3DH1	0.366	time slot length * 1600/2 /79 * 31.6	117.1	0.4	EDR
3DH3	1.620	time slot length * 1600/4 /79 * 31.6	259.2	0.4	EDR
3DH5	2.855	time slot length * 1600/6 /79 * 31.6	304.5	0.4	EDR





Test Mode: BDR---DH1



Test Mode: BDR---DH3



Test Mode: BDR---DH5



Test Mode: EDR---3DH1



Test Mode: EDR---3DH1



Test Mode: EDR---3DH3

## 9. MAXIMUM PEAK OUTPUT POWER TEST

### 9.1 Measurement Procedure

- a. Check the calibration of the measuring instrument(SA) using either an internal calibrator or a known signal from an external generator.
- b. Turn on the EUT and connect it to measurement instrument. Then set it to any one convenient frequency within its operating range. Set a reference level on the measuring instrument equal to the highest peak value.
- c. The center frequency of the spectrum analyzer is set to the fundamental frequency and using proper RBW and VBW setting.
- d. Measure the captured power within the band and recording the plot.
- e. Repeat above procedures until all frequencies required were complete.

Using the following spectrum analyzer settings:

1. Span= approximately 5 times the 20dB bandwidth, centered on a hopping channel
2. Set the RBW = 3 MHz.
3. Set the VBW = 3 MHz.
4. Sweep time = auto couple.
5. Detector function = peak.
6. Trace mode = max hold.
7. Allow trace to fully stabilize.

### 9.2 Test SET-UP

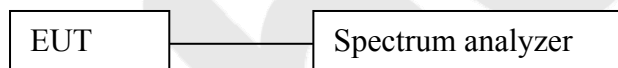

### 9.3 Test Equipment

Same as the equipment listed in 5.3.

### 9.4 Test Results

Test Item : Max. peak output power      Test Mode : CH Low ~ CH High  
 Test Voltage : AC 120V, 60Hz for adapter      Temperature : 24°C  
 Test Result : PASS      Humidity : 55%RH

Channel Frequency (MHz)	Peak Power output(mW)	Peak Power output(dBm)	Peak Power Limit(mW)	Results	Modulation
2402	1.053	0.224	1000	PASS	BDR
2441	1.098	0.407	1000	PASS	BDR
2480	1.274	<b>1.052</b>	1000	PASS	BDR
2402	1.009	0.039	125	PASS	EDR
2441	1.078	0.328	125	PASS	EDR
2480	1.249	0.967	125	PASS	EDR

Remark: The EDR was tested on ( $\pi/4$ DQPSK, 8DPSK) modes, only the worst data of ( $\pi/4$ DQPSK) is attached in the following pages.

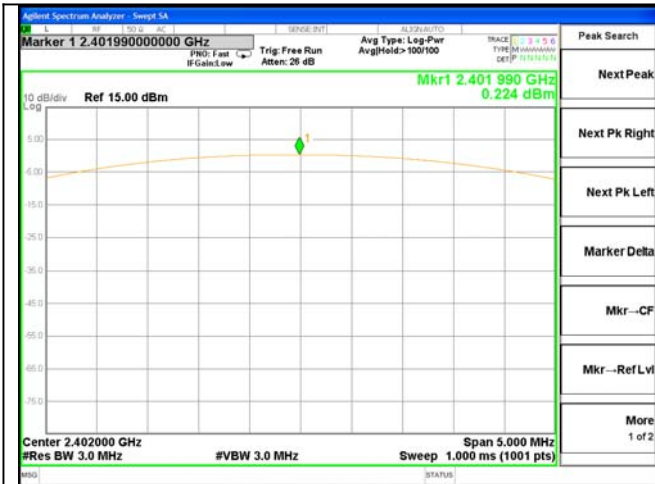

Test Mode: BDR---Low

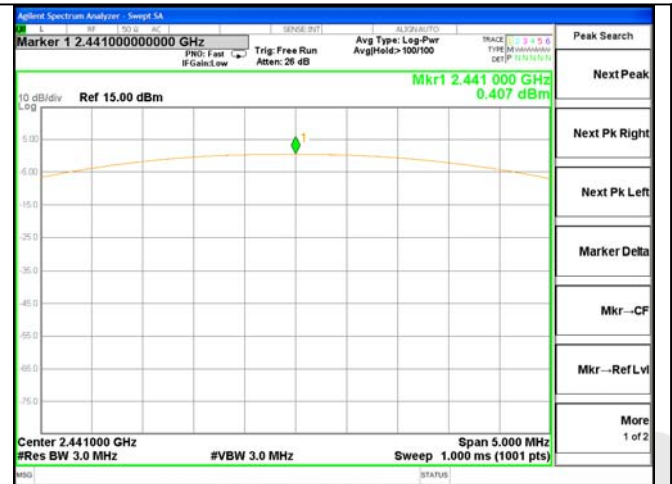

Test Mode: BDR---Mid

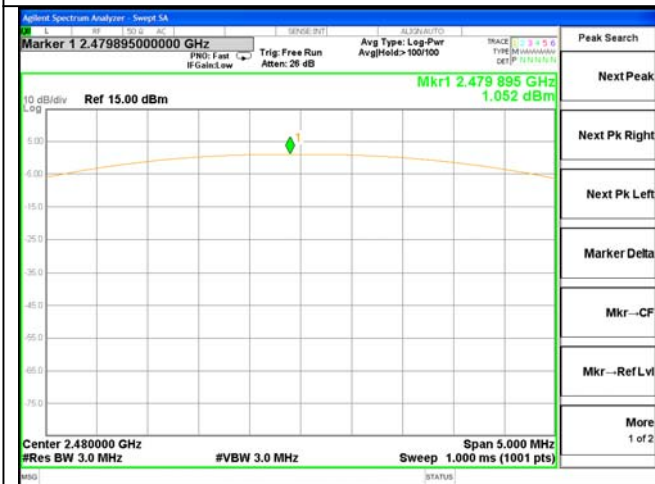

Test Mode: BDR---High

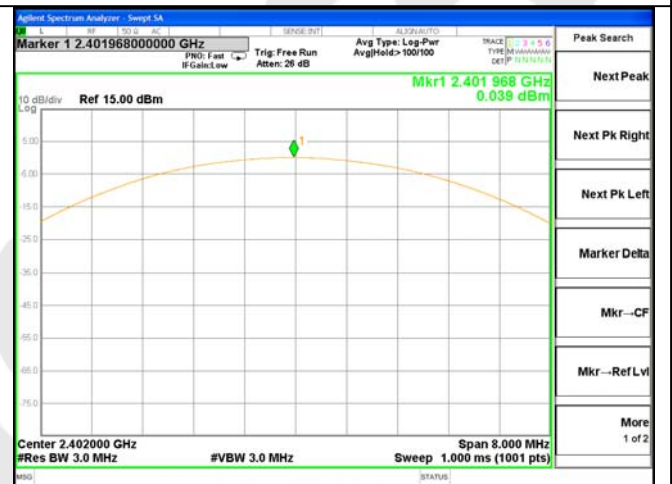

Test Mode: EDR---Low



Test Mode: EDR---Mid

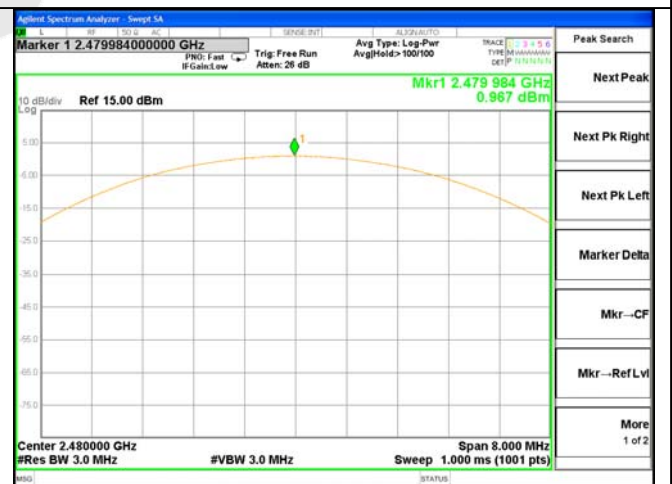

Test Mode: EDR---High

## 10. BAND EDGE TEST

### 10.1 Measurement Procedure

#### A) Conducted Emission method:

1. Check the calibration of the measuring instrument using either an internal calibrator or a known signal from an external generator.
2. Position the EUT without connection to measurement instrument. Put it on the Rotated table and turn on the EUT and make it operate in transmitting mode. Then set it to low Channel and High Channel within its operating range, and make sure the instrument is operated in its linear range.
3. Set both RBW and VBW of spectrum analyzer to 100kHz with a convenient frequency span including 100kHz bandwidth from band edge,
4. Measurement the highest amplitude appearing on spectral display and set it as a reference level. Plot the graph with marking the highest point and edge frequency.
5. Report above procedures until all measured frequencies were complete.

#### B) Radiated Emission method:

The EUT is placed on a turn table which is 1.5 meter high above the ground. The turn table can rotate 360 degrees to determine the position of the maximum emission level. The EUT is set 3 meters away from the receiving antenna which is mounted on a antenna tower. The antenna can be moved up and down from 1 to 4 meters to find out the maximum emission level. Rotated the EUT through three orthogonal axes to determine the maximum emissions, both horizontal and vertical polarization of the antenna are set on test. The EUT is tested in 9\*6\*6 Chamber. for Radiated emissions restricted band RBW= 1 MHz, VBW= 3 MHz.

### 10.2 Test SET-UP

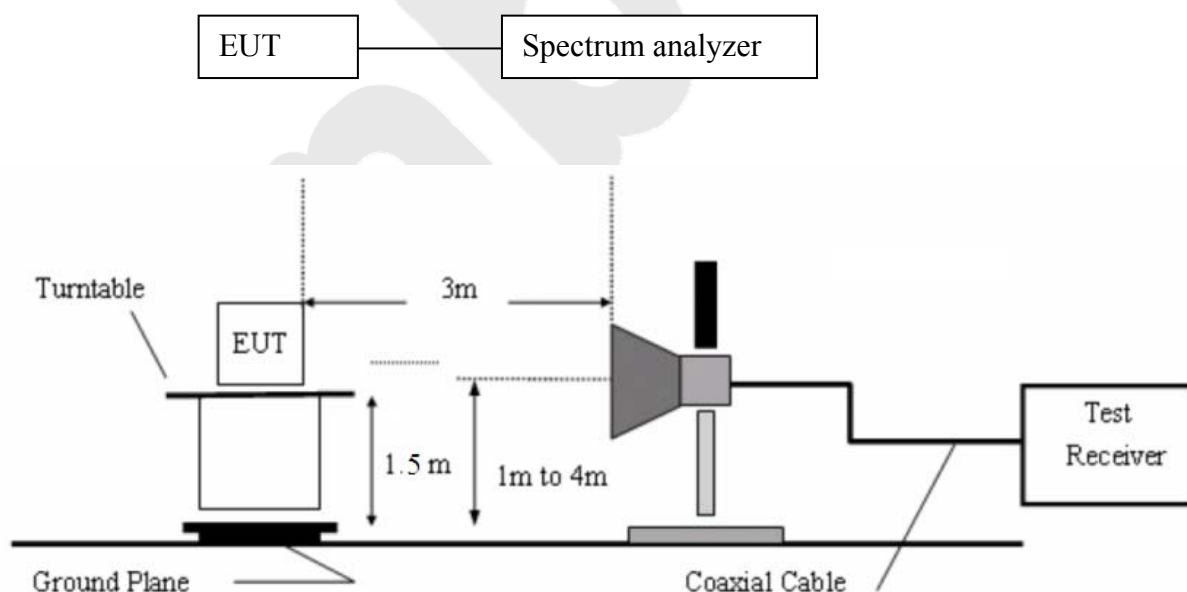

### 10.3 Test Equipment

Same as the equipment listed in 5.3.

### 10.4 Test Results

Pass.

Please refer the following data.

Test Item	: Band edge	Test Mode	: CH Low ~ CH High
Test Voltage	: AC 120V, 60Hz for adapter	Temperature	: 24°C
Test Result	: PASS	Humidity	: 55%RH

#### **For Hopping Mode:**

Remark: The EDR was tested on ( $\pi/4$ DQPSK, 8DPSK) modes, only the worst data of ( $\pi/4$ DQPSK) is attached in the following pages.

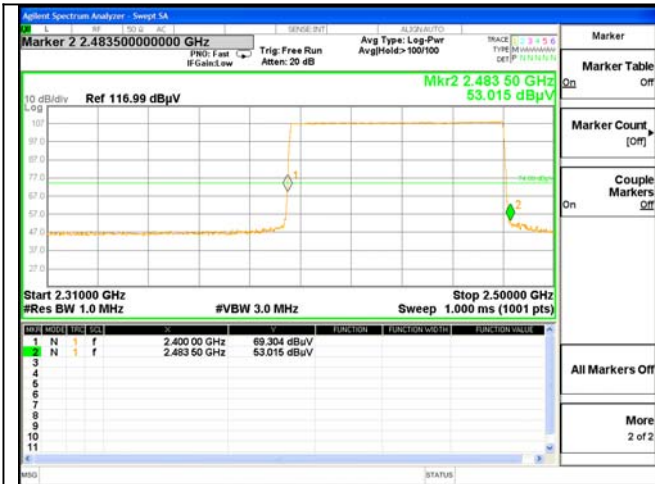

Test Mode: BDR

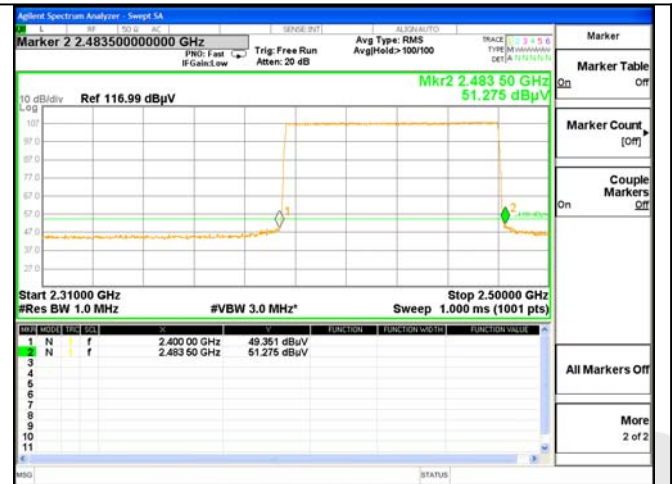

Test Mode: BDR

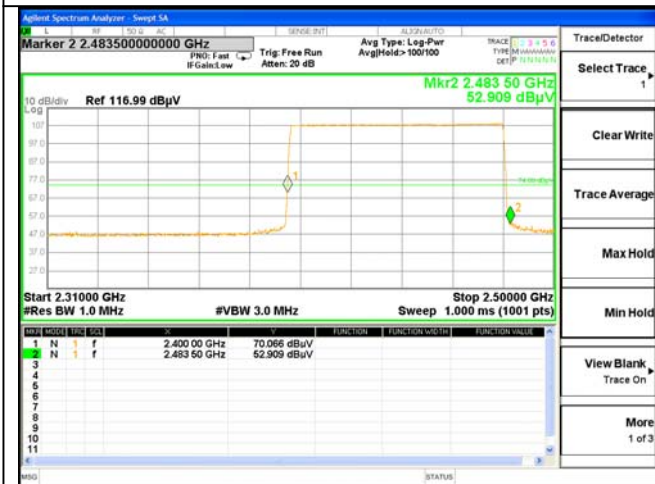

Test Mode: EDR



Test Mode: EDR



Test Item	: Band edge	Test Mode	: CH Low ~ CH High
Test Voltage	: AC 120V, 60Hz for adapter	Temperature	: 24°C
Test Result	: PASS	Humidity	: 55%RH

**For Non-Hopping Mode:**

1. Conducted Test

Frequency (MHz)	Peak Power Output(dBm)	Emission read Value(dBm)	Result of Band edge(dBc)	Band edge Limit(dBc)	Modulation
<2400	1.914	-43.345	45.289	>20dBc	BDR
	2.289	-34.326	32.037	>20dBc	EDR
>2483.5	0.087	-56.703	56.790	>20dBc	BDR
	0.748	-53.925	64.673	>20dBc	EDR

2. Radiated emission Test

Frequency (MHz)	Antenna polarization (H/V)	Emission (dBuV/m)		Band edge Limit (dBuV/m)		Modulation
		PK	AV	PK	AV	
<2400	V	53.15	39.51	74.00	54.00	BDR
	V	51.74	38.16	74.00	54.00	EDR
>2483.5	V	50.29	37.69	74.00	54.00	BDR
	V	48.88	35.93	74.00	54.00	EDR

Remark: The EDR was tested on ( $\pi/4$ DQPSK, 8DPSK) modes, only the worst data of ( $\pi/4$ DQPSK) is attached in the following pages.





Test Mode: BDR



Test Mode: BDR



Test Mode: EDR

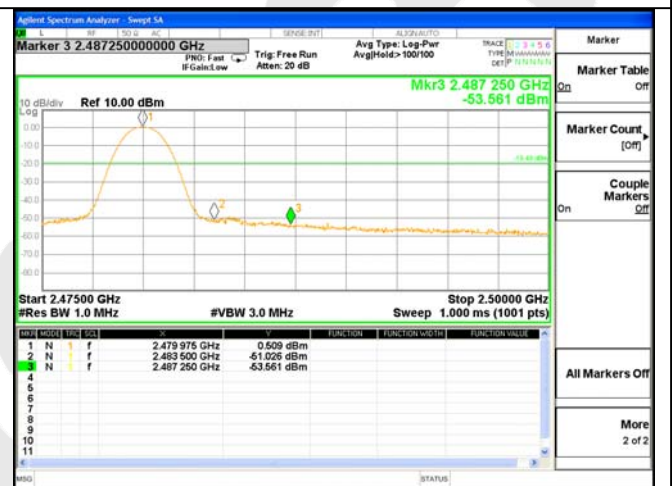

Test Mode: EDR

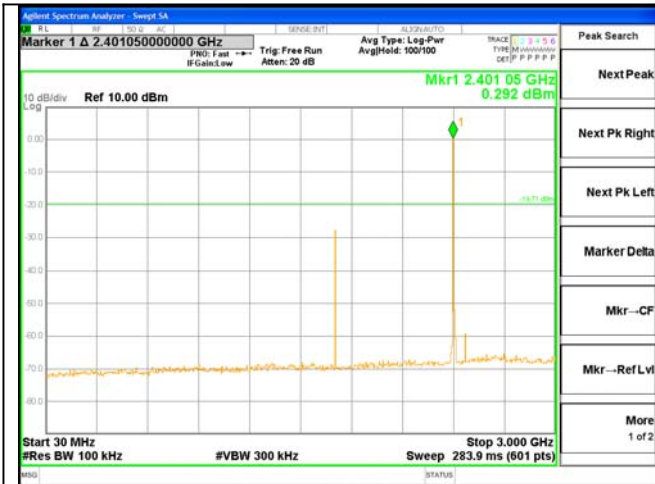

Test Mode: BDR---Low



Test Mode: BDR---Low

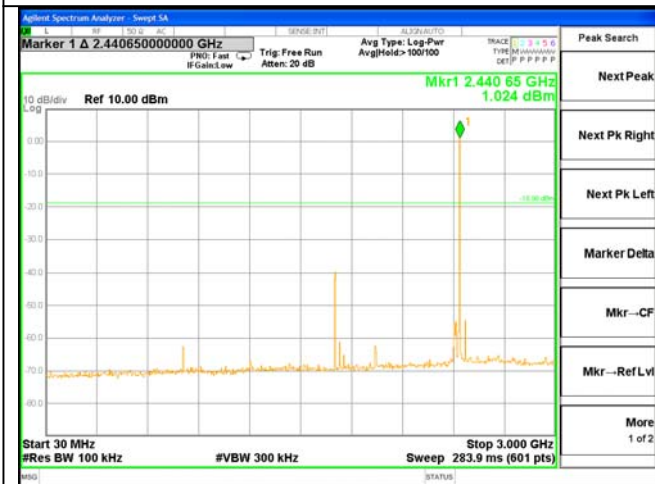

Test Mode: BDR---Mid

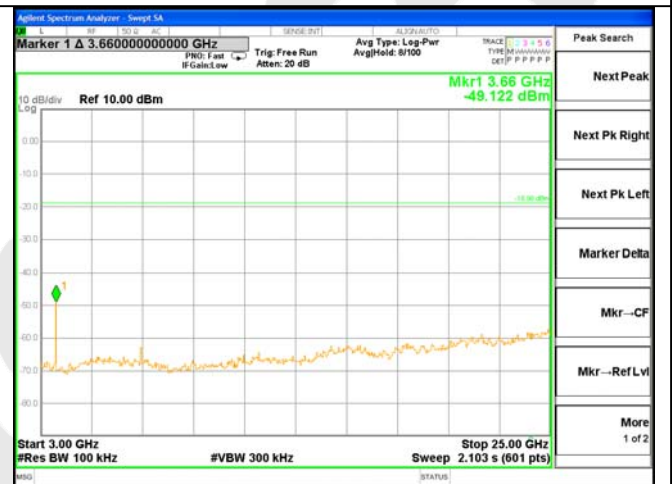

Test Mode: BDR---Mid

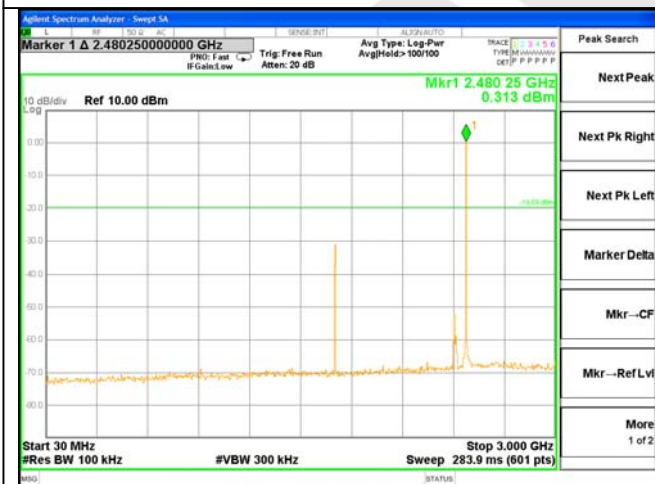

Test Mode: BDR---High

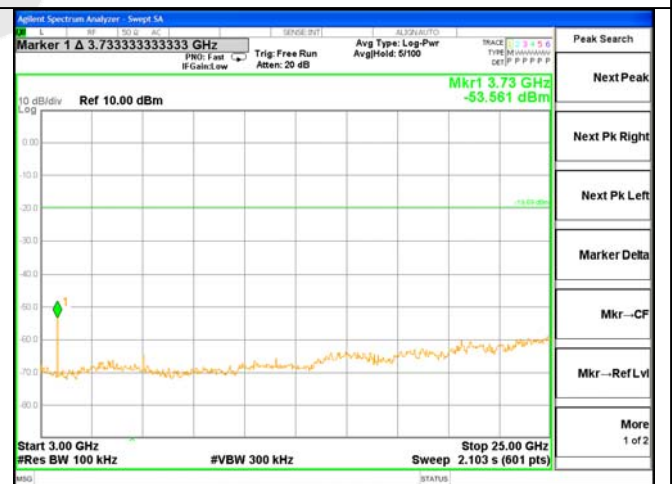

Test Mode: BDR---High

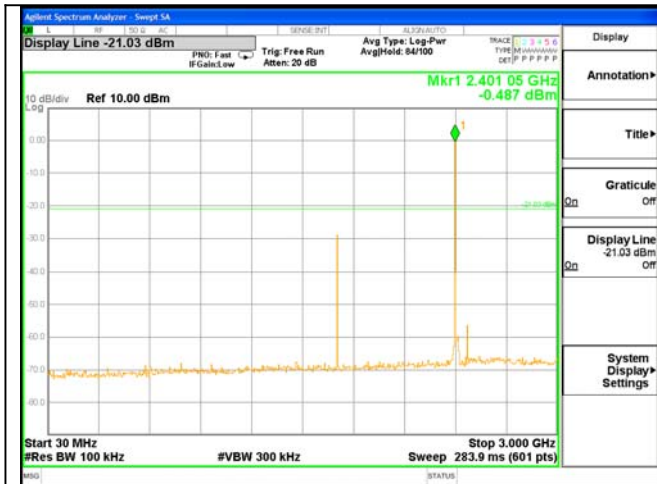

Test Mode: EDR---Low



Test Mode: EDR---Low

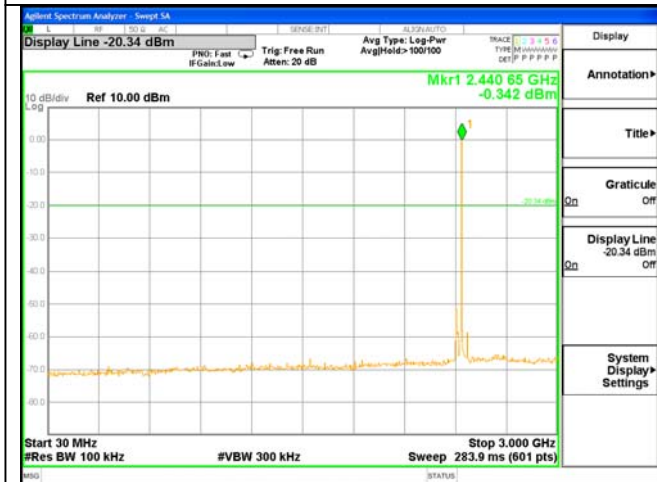

Test Mode: EDR---Mid



Test Mode: EDR---Mid

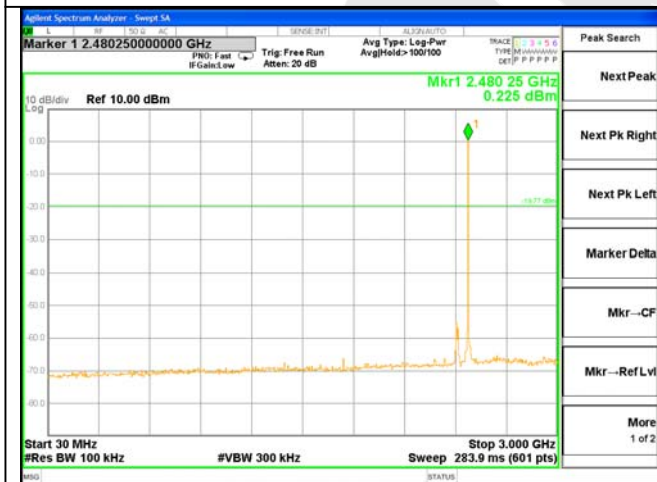

Test Mode: EDR---High

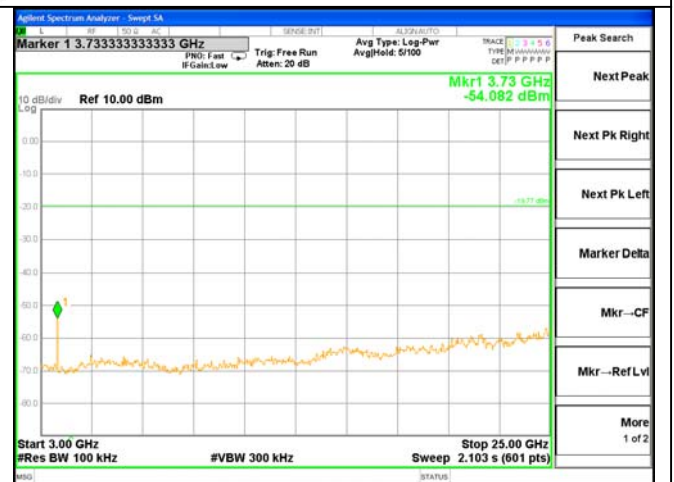

Test Mode: EDR---High

## 11. ANTENNA APPLICATION

### 11.1 Antenna requirement

The EUT'S antenna is met the requirement of FCC part 15C section 15.203 and 15.247.

FCC part 15C section 15.247 requirements:

Systems operating in the 2402-2480MHz band that are used exclusively for fixed, point-to-point operations may employ transmitting antennas with directional gain greater than 6dBi provided the maximum peak output power of the intentional radiator is reduced by 1dB for every 3dB that the directional gain of the antenna exceeds 6dBi.

### 11.2 Result

The EUT's antenna used a PCB Antenna, The antenna's gain is 0dBi and meets the requirement.

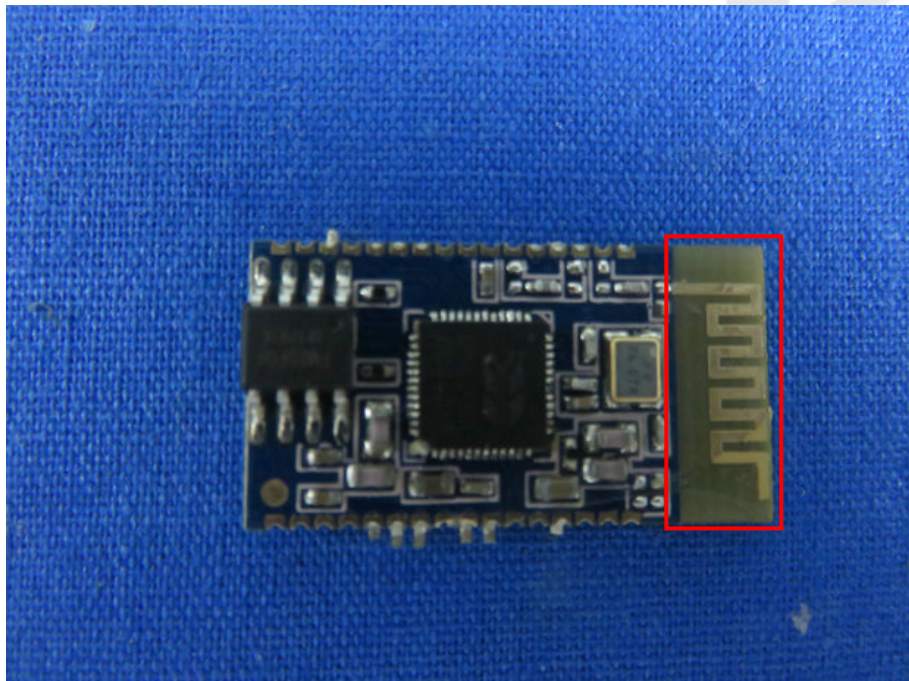



## 12. PHOTOGRAPH

### 12.1 Photo of Power Line Conducted Emission Measurement



### 12.2 Photo of Radiation Emission Test

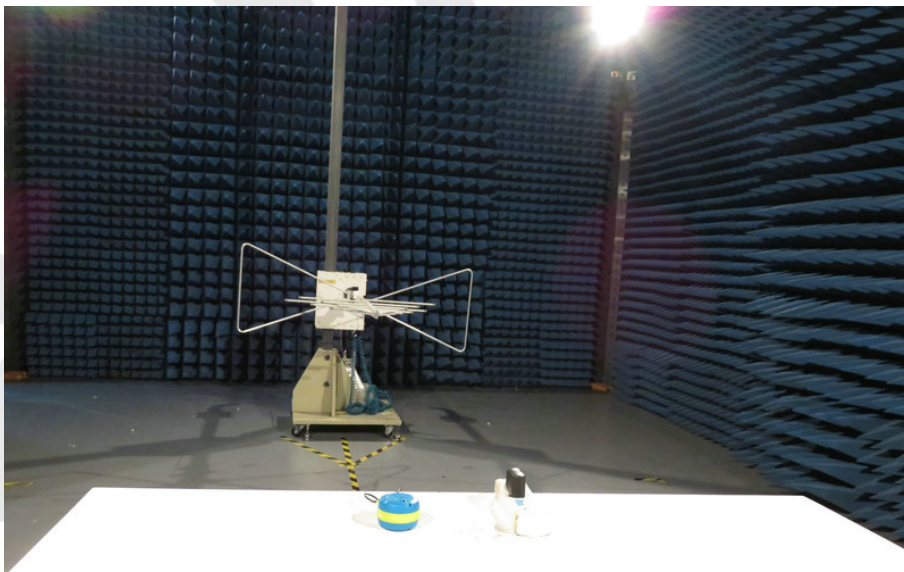

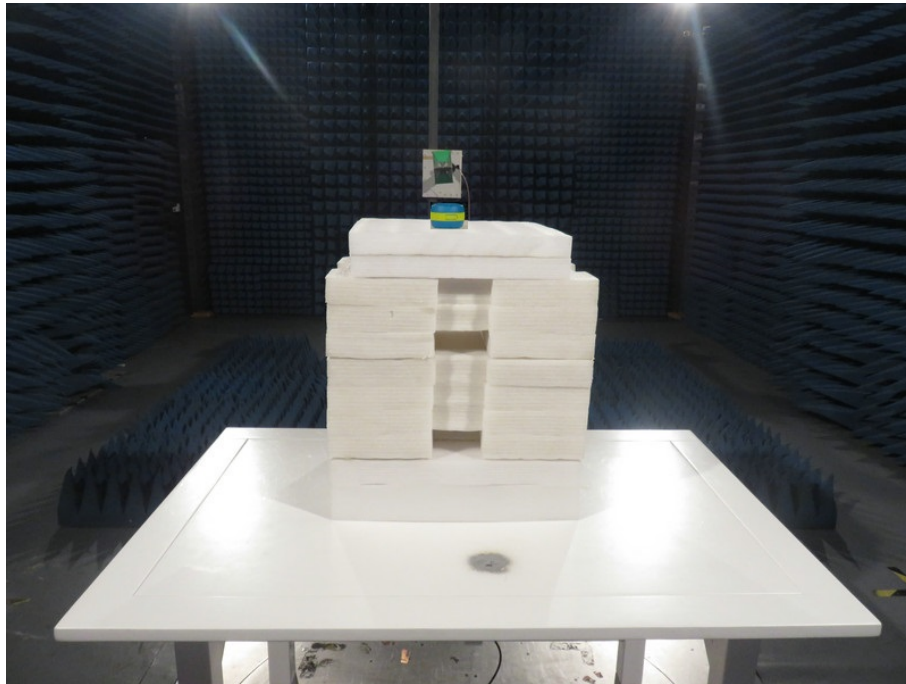

Anbotek

## APPENDIX I (EXTERNAL PHOTOS)

1. Figure  
The EUT-Top View

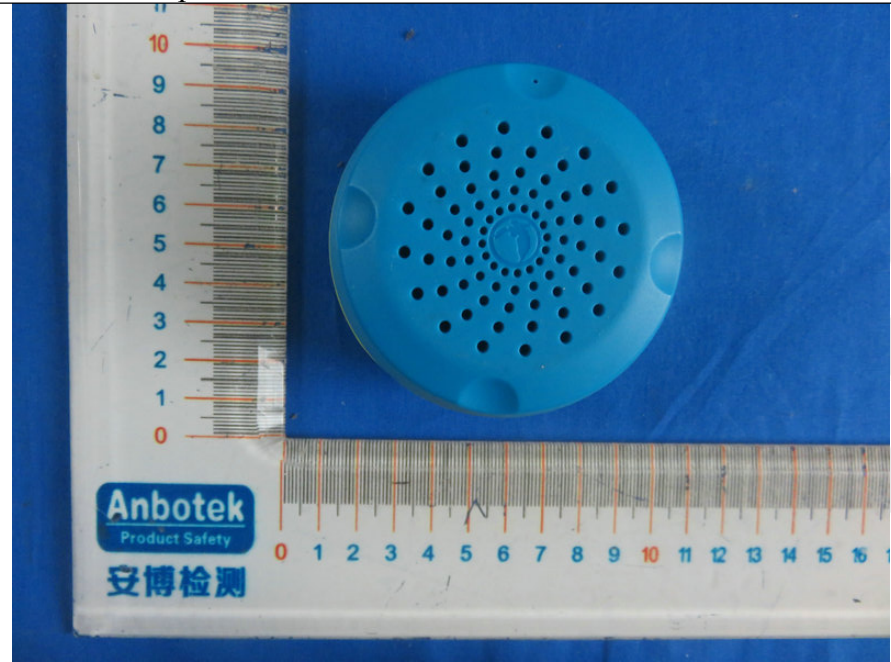

2. Figure  
The EUT-Bottom View





3. Figure  
The EUT-Front View

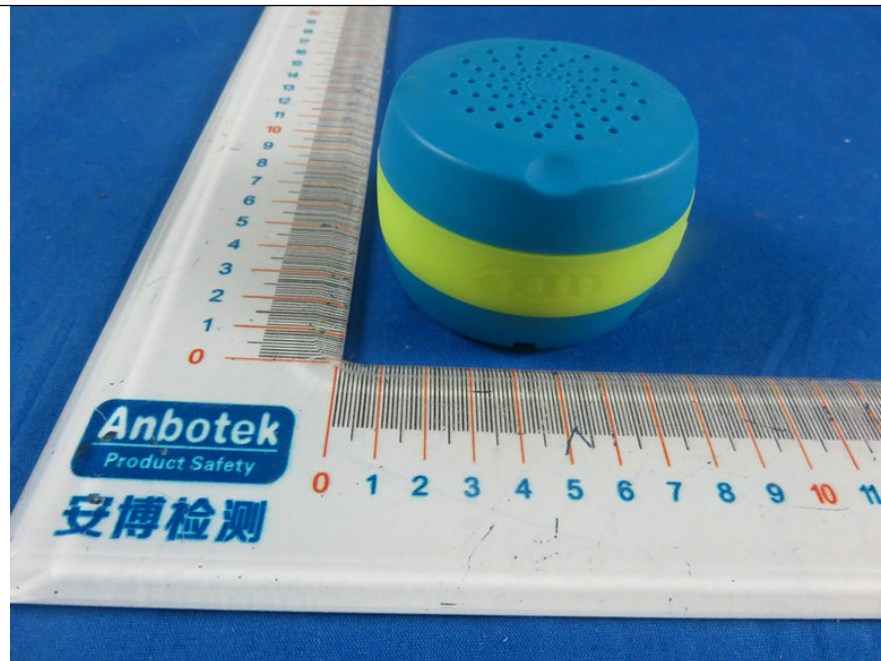

4. Figure  
The EUT-Back View

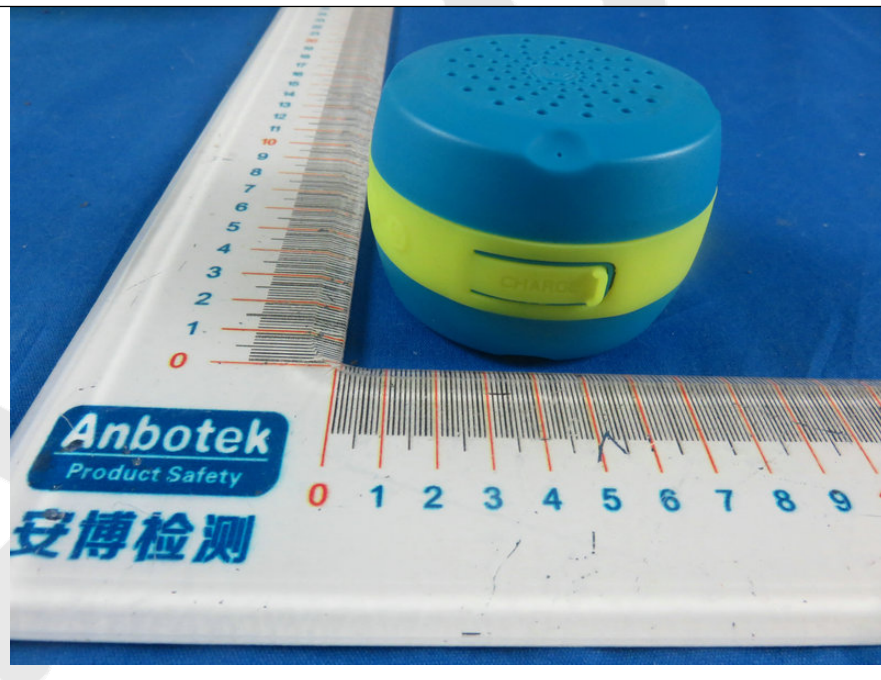



5. Figure  
The EUT-Right View

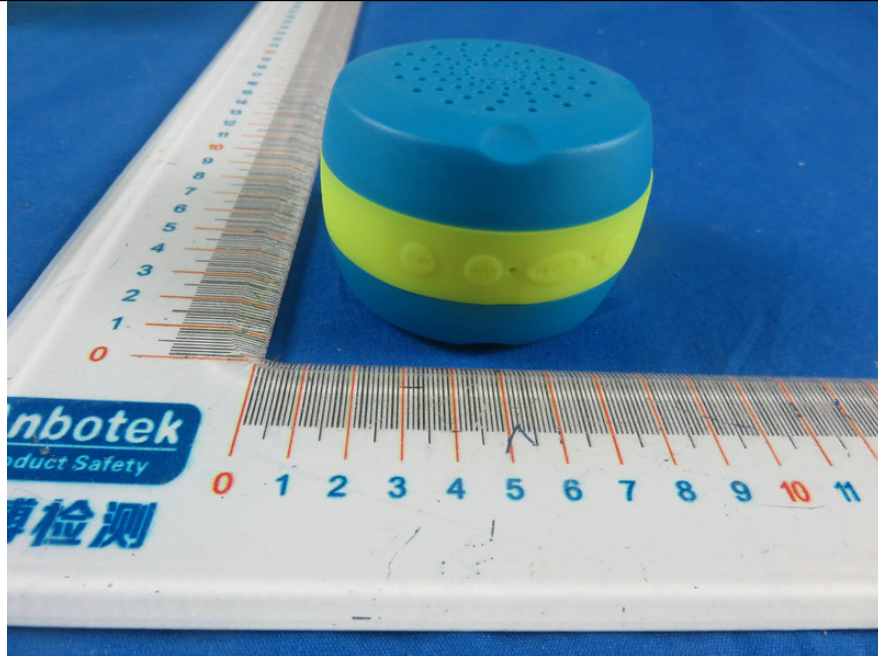

6. Figure  
The EUT-Left View

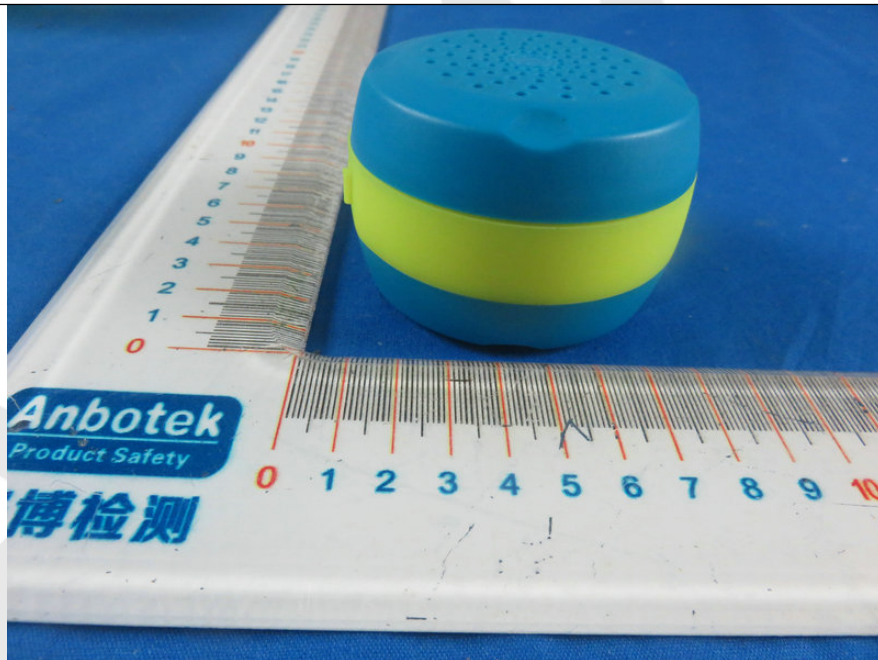

## APPENDIX II (INTERNAL PHOTOS)

1. Figure  
The EUT-Inside View

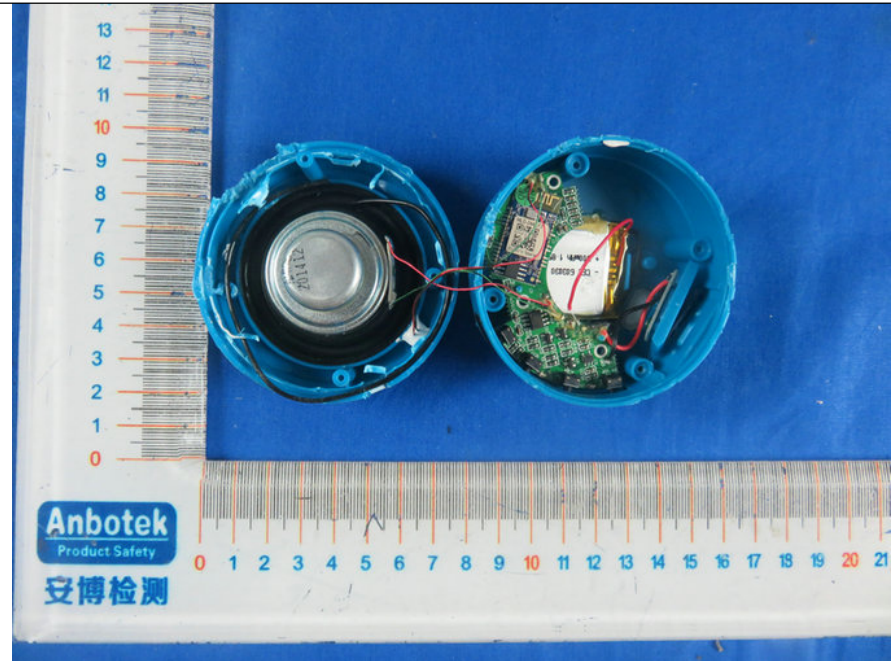

2. Figure  
PCB of the EUT-Front View

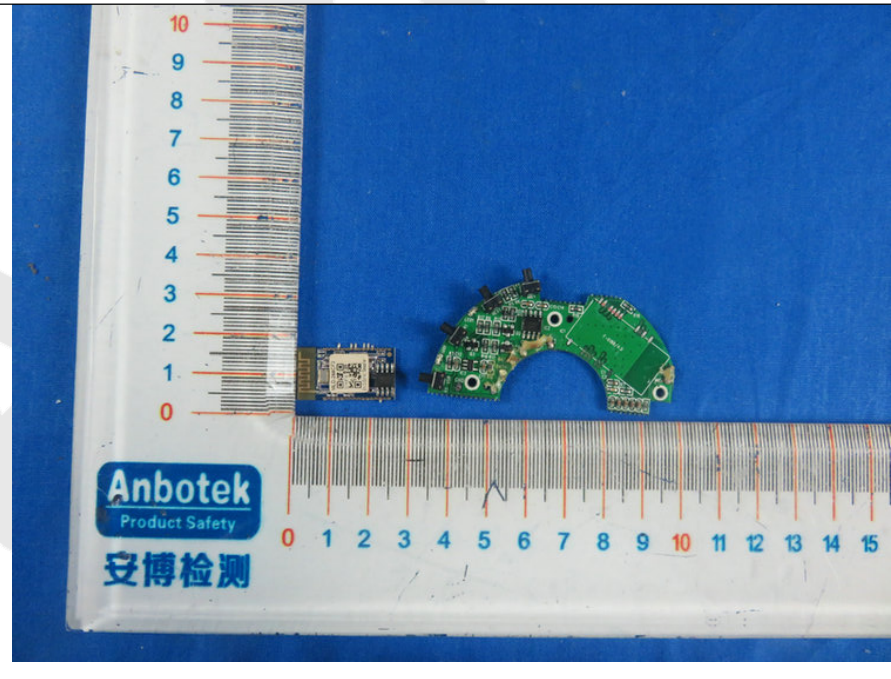



3. Figure  
PCB of the EUT-Back View

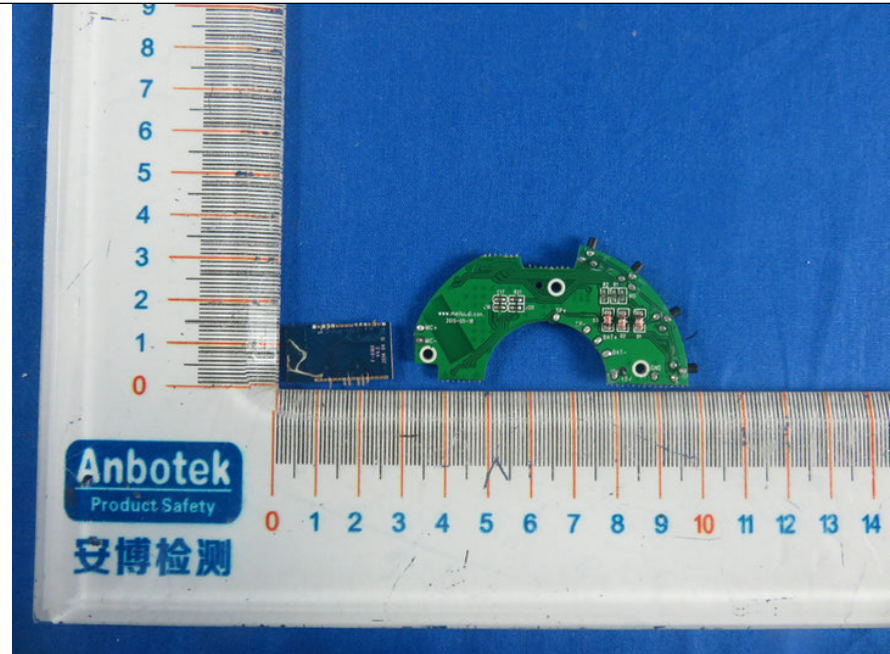

4. Figure  
PCB of the EUT-Front View

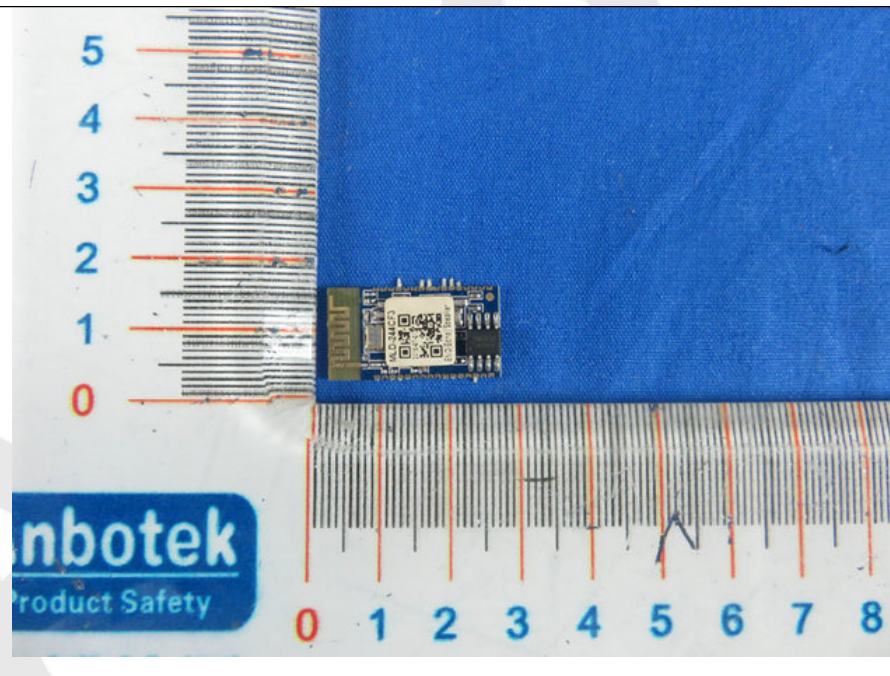

5. Figure  
PCB of the EUT-Back View

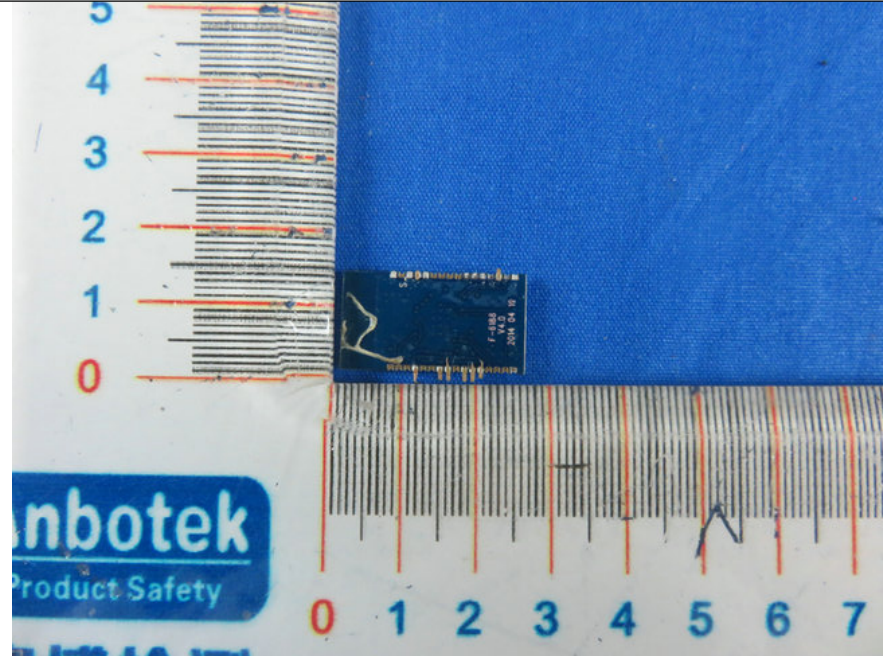

6. Figure  
PCB of the EUT-Front View

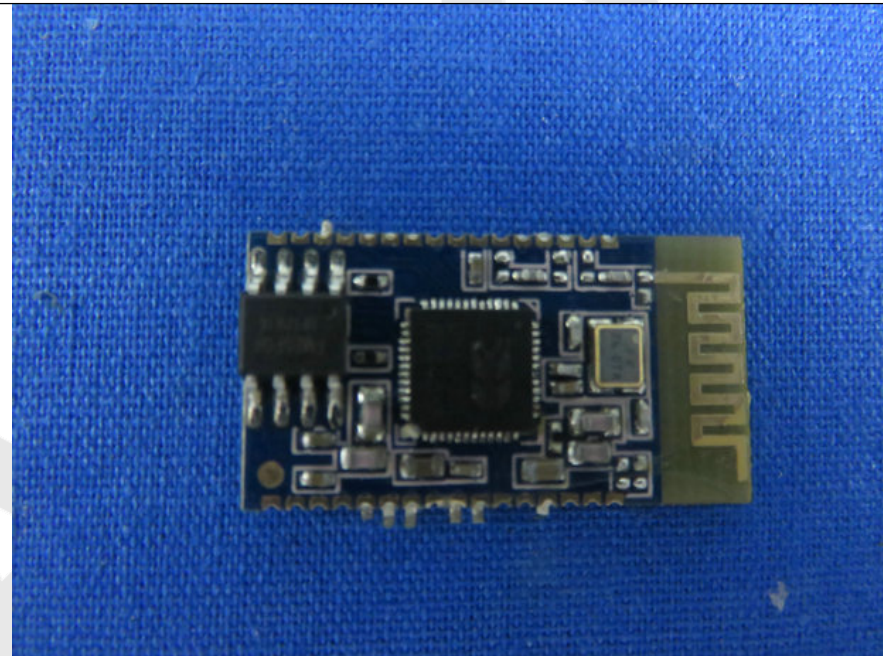



7. Figure  
PCB of the EUT-Back View

