



TESTING LABORATORY
CERTIFICATE #4820.01



FCC PART 20.21

TEST REPORT

For

Signifi Mobile Inc

1001 Rue Lenoir Suite A-414 Montreal, Quebec, H4C 2Z6, Canada

FCC ID: 2AJAN-SMT17CPAL

Report Type: Original Report	Product Type: Uniden Cellular Signal Booster
Report Number: RDG180408005-00A	
Report Date: 2018-06-29	
Reviewed By: Dean Lau RF Supervisor	<i>Dean Lau</i>
Prepared By: Bay Area Compliance Laboratories Corp. (Dongguan) No.69 Pulongcun, Puxinhu Industry Area, Tangxia, Dongguan, Guangdong, China Tel: +86-769-86858888 Fax: +86-769-86858891 www.baclcorp.com.cn	

Note: This test report is prepared for the customer shown above and for the device described herein. It may not be duplicated or used in part without prior written consent from Bay Area Compliance Laboratories Corp. (Dongguan). This report must not be used by the customer to claim product certification, approval, or endorsement by A2LA* or any agency of the Federal Government. * This report may contain data that are not covered by the A2LA accreditation and are marked with an asterisk “**”.

TABLE OF CONTENTS

GENERAL INFORMATION.....	4
PRODUCT DESCRIPTION FOR EQUIPMENT UNDER TEST (EUT)	4
OBJECTIVE	4
RELATED SUBMITTAL(S)/GRANT(S).....	4
TEST METHODOLOGY	5
MEASUREMENT UNCERTAINTY.....	5
TEST FACILITY	5
SYSTEM TEST CONFIGURATION.....	6
DESCRIPTION OF TEST CONFIGURATION	6
EUT EXERCISE SOFTWARE	6
SPECIAL ACCESSORIES.....	6
EQUIPMENT MODIFICATIONS	6
SUPPORT EQUIPMENT LIST AND DETAILS	6
EXTERNAL I/O CABLE.....	6
BLOCK DIAGRAM OF TEST SETUP	7
SUMMARY OF TEST RESULTS	8
TEST EQUIPMENT LIST	9
§ 20.21(E)(3) – AUTHORIZED FREQUENCY BAND VERIFICATION	11
APPLICABLE STANDARD	11
TEST PROCEDURE	11
TEST DATA	12
§ 20.21(e)(8)(i)(D) , § 20.21(e)(8)(i)(B)& §20.21(e)(4)– MAXIMUM POWER MEASUREMENT	18
APPLICABLE STANDARD	18
TEST PROCEDURE	18
TEST DATA	19
§ 20.21(e)(8)(i)(C)(2), § 20.21(e)(8)(i)(B)&§20.21(e)(4) – MAXIMUM BOOSTER GIAN COMPUTATION	31
APPLICABLE STANDARDS.....	31
TEST PROCEDURE	31
TEST DATA	31
§ 20.21(e)(8)(i)(F)- INTERMODULATION PRODUCT.....	33
APPLICABLE STANDARDS.....	33
TEST PROCEDURE	33
TEST DATA	34
§ 20.21(e)(8)(i)(E)- OUT OF BAND EMISSIONS	45
APPLICABLE STANDARDS.....	45
TEST PROCEDURE	45
TEST DATA	46
§ 20.21(e)(8)(i)(A), § 20.21(e)(8)(i)(H) &§20.21(e)(4) - NOISE LIMITS	107
APPLICABLE STANDARDS.....	107
TEST PROCEDURE	107
TEST DATA	108
§ 20.21(e)(8)(i)(I) &§20.21(e)(4) - UPLINK INACTIVITY	119
APPLICABLE STANDARDS.....	119

TEST PROCEDURE 119
 TEST DATA 120

§ 20.21(e)(8)(i)(C)(1) & § 20.21(e)(8)(i)(H) - VARIABLE BOOSTER GAIN.....123

 APPLICABLE STANDARDS.....123
 TEST PROCEDURE123
 TEST DATA 124

§ 2.1049 - OCCUPIED BANDWIDTH129

 APPLICABLE STANDARDS.....129
 TEST PROCEDURE129
 TEST DATA 130

§ 20.21(e)(8)(ii)(A) & §20.21(e)(4) - OSCILLATION DETECTION161

 APPLICABLE STANDARDS.....161
 TEST PROCEDURE161
 TEST DATA 161

§2.1051- SPURIOUS EMISSIONS AT ANTENNA TERMINALS212

 APPLICABLE STANDARDS.....212
 TEST PROCEDURE212
 TEST DATA 213

§ 2.1053 - RADIATED SPURIOUS EMISSIONS229

 APPLICABLE STANDARDS.....229
 TEST PROCEDURE229
 TEST DATA 230

GENERAL INFORMATION

Product Description for Equipment under Test (EUT)

The *Signifi Mobile Inc*'s product, model number: *SM-T17CPAL* (FCC ID: *2AJAN-SMT17CPAL*) in this report is a *Uniden Cellular Signal Booster*.

Radio System Type	Wide Band Consumer Signal Booster
Frequency Bands	Lower 700MHz:698-716MHz(Uplink), 728-746MHz(Downlink) Upper 700 MHz: 776-787MHz(Uplink), 746-757MHz(Downlink) Cellular: 824-849MHz (Uplink), 869-894MHz(Downlink) AWS: 1710-1755MHz (Uplink), 2110-2155MHz(Downlink) PCS: 1850-1910MHz(Uplink), 1930-1990MHz(Downlink)
Max. Gain	Uplink: 68dB Downlink: 66dB
Max. Output Power (Antenna Port)	Uplink: 19dBm+/-2dB Downlink: 0dBm+/-2dB
Max. Antenna Gain:	Uplink: 10dBi Down Link: 10dBi
Nominal Power Supply:	DC 12V from adapter
External Dimension	200 mm (L) * 117 mm (W) * 40 mm (H)
Temperature Range	-25°C to 55°C

Adapter Information:

Model: ZF120A-1203000

Input: 100-240Vac 2A 50/60Hz

Output: 12V, 3A

Note: The series product, models SM-T17CPAL, SM-T13CPAL, SM-T10CPAL are electrically identical, The difference between them please refer to the declaration letter for details. For marketing purpose, we selected SM-T17CPAL for fully test.

** All measurement and test data in this report was gathered from production sample serial number: 180408005. (Assigned by BACL, Dongguan). The EUT supplied by the applicant was received on 2018-04-08.*

Objective

This test report is prepared on behalf of *Signifi Mobile Inc* in accordance with Part 2, part 20.21 of the Federal Communication Commissions rules.

Related Submittal(s)/Grant(s)

No related submittal(s).

Test Methodology

All tests and measurements indicated in this document were performed in accordance with the Code of federal Regulations Title 47 Part 2, Sub-part J as well as the following individual parts:

Applicable Standards: TIA 603-D, KDB 935210 D03 Signal Booster Measurements v04.

All emissions measurement was performed at Bay Area Compliance Laboratories Corp. (Dongguan). The radiated testing was performed at an antenna-to-EUT distance of 3 meters.

Measurement Uncertainty

Item		Uncertainty
RF conducted test with spectrum		±0.9dB
Radiated emission	30MHz~1GHz	±5.91dB
	Above 1G	±4.92dB
Occupied Bandwidth		±0.5kHz
Temperature		±1.0°C
Humidity		±6%

Test Facility

The Test site used by Bay Area Compliance Laboratories Corp. (Dongguan) to collect test data is located on the No.69 Pulongcun, Puxinhu Industry Area, Tangxia, Dongguan, Guangdong, China.

The test site has been approved by the FCC under the KDB 974614 D01 and is listed in the FCC Public Access Link (PAL) database, FCC Registration No. : 897218, the FCC Designation No. : CN1220.

The test site has been registered with ISED Canada under ISED Canada Registration Number 3062D.

SYSTEM TEST CONFIGURATION

Description of Test Configuration

The system was configured for testing in a test mode which has been done in the factory.

Antenna kitting requirement: EUT has multiple sets antenna kitting for marketing, the antenna gain for varier band were listed in user manual, fulfill the requirement of FCC Part 20.21(e)(8)(i)(G), more detail information please refer to the user manuals.

EUT Exercise Software

No exercise software was used.

Special Accessories

No special accessory was used.

Equipment Modifications

No modification was made to the EUT tested.

Support Equipment List and Details

Manufacturer	Description	Model	Serial Number
Agilent	MXG Vector Signal Generator	N5182B	MY51350142
Weinschel	50 ohm Load	1440-3	MD477

External I/O Cable

Cable Description	Length (m)	From Port	To
Coaxial Cable	2.0	Output Port of SG	Server Port of EUT

Block Diagram of Test Setup

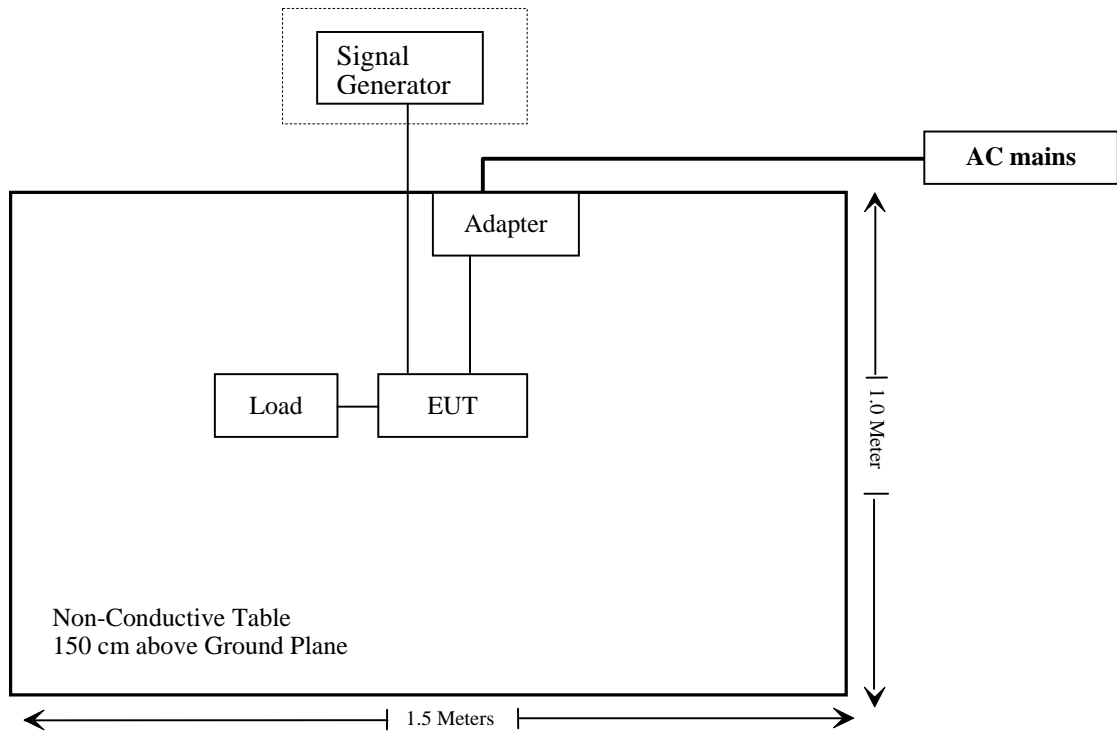

SUMMARY OF TEST RESULTS

FCC Rules	Description of Test	Results
§20.21(e)(3)	7.1 Authorized Frequency Band Verification	Compliance
§ 20.21(e)(8)(i)(D) § 20.21(e)(8)(i)(B) & §20.21(e)(4)	7.2 Maximum Power Measurement	Compliance
§ 20.21(e)(8)(i)(C)(2) § 20.21(e)(8)(i)(B) & §20.21(e)(4)	7.9 Maximum Booster Gain Computation	Compliance
§ 20.21(e)(8)(i)(B) § 20.21(e)(3)	7.13 Spectrum block filtering test procedure	Not applicable
§ 20.21(e)(8)(i)(F)	7.4 Intermodulation Product	Compliance
§ 20.21(e)(8)(i)(E)	7.5 Out Of Band Emissions	Compliance
§ 20.21(e)(8)(i)(A) § 20.21(e)(8)(i)(H) &§20.21(e)(4)	7.7 Noise Limits	Compliance
§ 20.21(e)(8)(i)(I) &§20.21(e)(4)	7.8 Uplink Inactivity	Compliance
§ 20.21(e)(8)(i)(C)(1) & § 20.21(e)(8)(i)(H)	7.9 Variable Booster Gain	Compliance
§ 2.1049	7.10 Occupied Bandwidth	Compliance
§ 20.21(e)(8)(ii)(A) &§20.21(e)(4)	7.11 Oscillation Detection	Compliance
§2.1051	7.6 Spurious Emissions At Antenna Terminals	Compliance
§ 2.1053	7.12 Radiated Spurious Emissions	Compliance

Not applicable: This item only for wideband consumer boosters utilizing spectrum block filtering.

TEST EQUIPMENT LIST

Manufacturer	Description	Model	Serial Number	Calibration Date	Calibration Due Date
Radiated Emission Test					
R&S	EMI Test Receiver	ESCI	100224	2017-12-11	2018-12-11
Sunol Sciences	Antenna	JB3	A060611-1	2017-11-10	2020-11-10
EMCO	Adjustable Dipole Antenna	3121C	9109-753	N/A	N/A
Unknown	Coaxial Cable	C-NJNJ-50	C-0400-01	2017-09-05	2018-09-05
Unknown	Coaxial Cable	C-NJNJ-50	C-0075-01	2017-09-05	2018-09-05
Unknown	Coaxial Cable	C-NJNJ-50	C-1000-01	2017-09-05	2018-09-05
Unknown	Coaxial Cable	C-NJNJ-50	C-0200-02	2017-09-05	2018-09-05
HP	Amplifier	8447D	2727A05902	2017-09-05	2018-09-05
Agilent	Signal Generator	E8247C	MY43321350	2017-12-11	2018-12-11
Agilent	Spectrum Analyzer	E4440A	SG43360054	2018-01-04	2019-01-04
TDK RF	Horn Antenna	HRN-0118	130 084	2016-01-05	2019-01-04
ETS-Lindgren	Horn Antenna	3115	000 527 35	2016-01-05	2019-01-04
Unknown	Coaxial Cable	C-SJSJ-50	C-0800-01	2017-09-05	2018-09-05
MITEQ	Amplifier	AFS42-00101800-25-S-42	2001271	2017-09-05	2018-09-05
RF Conducted test					
R&S	Spectrum Analyzer	FSU 26	200256	2018-01-04	2019-01-04
Unknown	Coaxial Cable	C-SJ00-0010	C0010/01	Each time	/
Unknown	Coaxial Cable	C-SJ00-0010	C0010/02	Each time	/
Unknown	Coaxial Cable	C-SJ00-0010	C0010/03	Each time	/
Unknown	Coaxial Cable	C-SJ00-0010	C0010/04	Each time	/
Unknown	Coaxial Cable	C-SJ00-0010	C0010/05	Each time	/
E-Microwave	Coaxial Attenuators	EMCA10-5RN-6	OE01203239	2017-09-05	2018-09-05
R&S	Wideband Radio Communication Tester	CMW500	147473	2017-08-31	2018-08-31
HP	Setp Attenuator	8494B	1510A05007	2017-09-05	2018-09-05
Agilent	Setp Attenuator	8496B	2815A10904	2017-09-05	2018-09-05
Unknown	Combiner	Unknown	Combiner 1	Each time	/
Unknown	Combiner	Unknown	Combiner 2	Each time	/
E-Microwave	Coaxial Attenuators	EMCA10-5RN-6	OE01203239	2017-09-05	2018-09-05
Narda	Directional coupler	4242-10	C1	Each time	/
Narda	Directional coupler	4242-10	C2	Each time	/

Narda	Directional coupler	4243B-10	C3	Each time	/
Narda	Directional coupler	4243B-10	C4	Each time	/
Agilent	MXG Vector Signal Generator	N5182B	MY51350142	2017-05-04	2018-05-04
Agilent	MXG Vector Signal Generator	N5182B	MY51350142	2018-05-04	2019-05-04

* **Statement of Traceability:** Bay Area Compliance Laboratories Corp. (Dongguan) attests that all calibrations have been performed, traceable to National Primary Standards and International System of Units (SI).

§ 20.21(E)(3) – AUTHORIZED FREQUENCY BAND VERIFICATION

Applicable Standard

According to § 20.21(e)(3) Frequency Bands

This test is intended to confirm that the signal booster only operates on the CMRS frequency bands authorized for use by the NPS. In addition, this test will identify the frequency at which the maximum gain is realized within each CMRS operational band, which then serves as a basis for subsequent tests.

Test Procedure

- a) Connect the EUT to the test equipment as shown in Figure 1. Begin with the uplink output connected to the spectrum analyzer.
- b) Set the spectrum analyzer RBW for 100 kHz with the VBW $\geq 3 \times$ the RBW using a PEAK detector with the MAX HOLD function.
- c) Set the center frequency of the spectrum analyzer to the center of the operational band under test with a span of 1 MHz.
- d) Set the signal generator for CW mode and tune to the center frequency of the operational band under test.
- e) Set the initial signal generator power to a level that is at least 6 dB below the AGC level specified by the manufacturer.
- f) Slowly increase the signal generator power level until the output signal reaches the AGC operational level.
- g) Reduce the signal generator power to a level that is 3 dB below the level noted above and manually reset the EUT.
- h) Reset the spectrum analyzer span to $2 \times$ the CMRS band under test. Adjust the tuned frequency of the signal generator to sweep $2 \times$ the CMRS band using the sweep function. The AGC must not be activated throughout the entire sweep.
- i) Using three markers, identify the CMRS band edges and the frequency with the highest power. Affirm that the values of all markers are visible on the display of the spectrum analyzer (e.g., marker table set to on).
- j) Capture the spectrum analyzer trace for inclusion in the test report.
- k) Repeat 7.1c) to 7.1j) for all operational uplink and downlink bands.

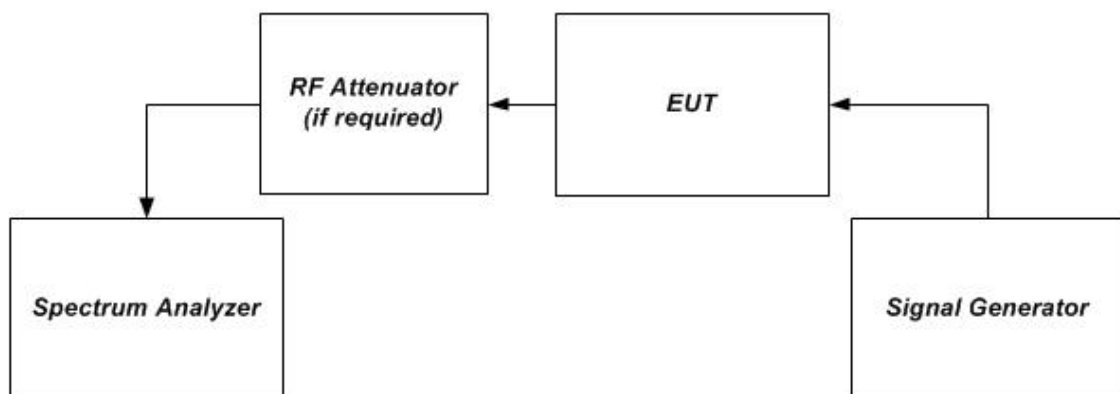

Figure 1 – Band verification test instrumentation setup

Test Data

Environmental Conditions

Temperature:	27.2~27.8 °C
Relative Humidity:	64~66 %
ATM Pressure:	100.8~101.1 kPa

The testing was performed by George Pang from 2018-05-02 to 2018-05-09.

Test Result: Compliance. Please refer to following plots.

Uplink:

Lower 700MHz Band

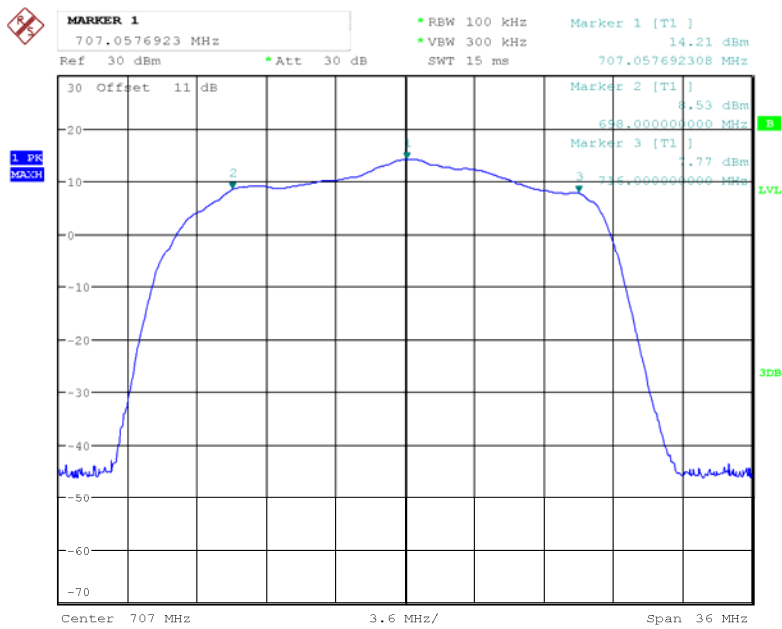

Date: 2.MAY.2018 17:53:57

Upper 700MHz Band

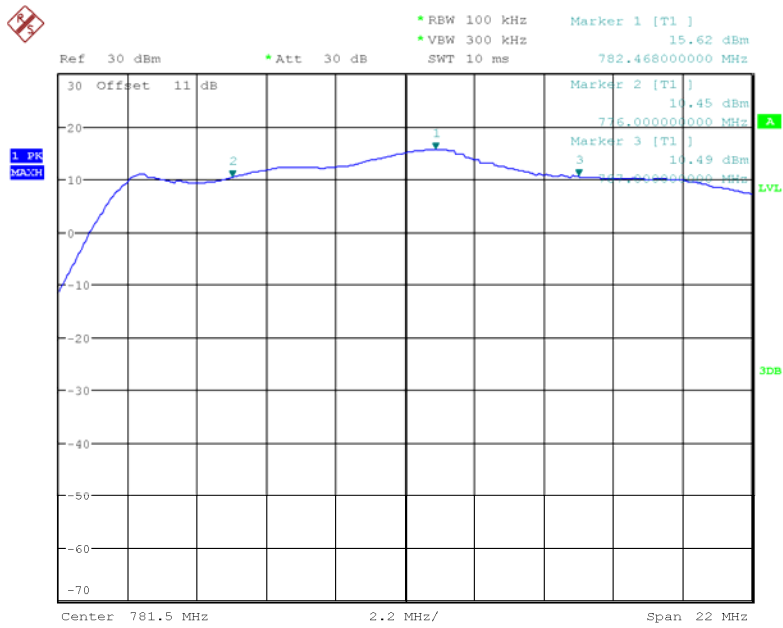

Date: 2.MAY.2018 19:46:27

Cellular Band

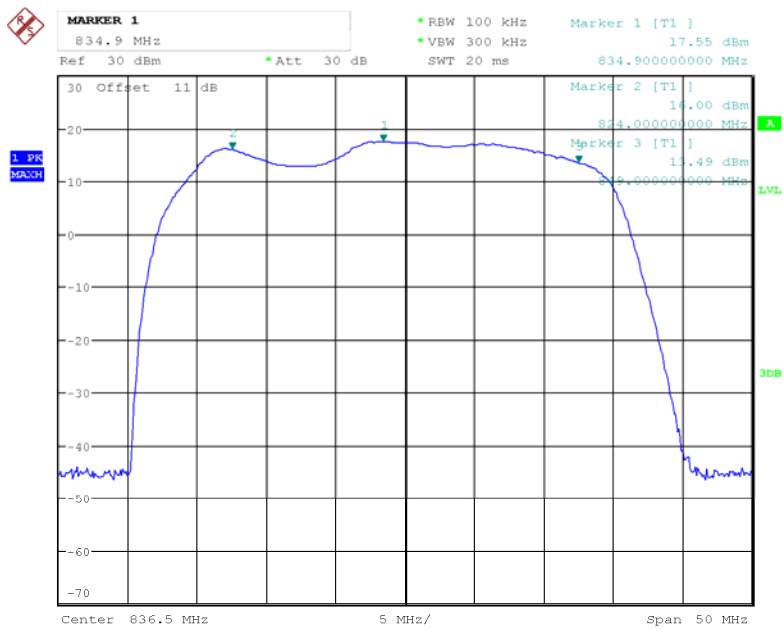

Date: 2.MAY.2018 19:53:10

AWS Band

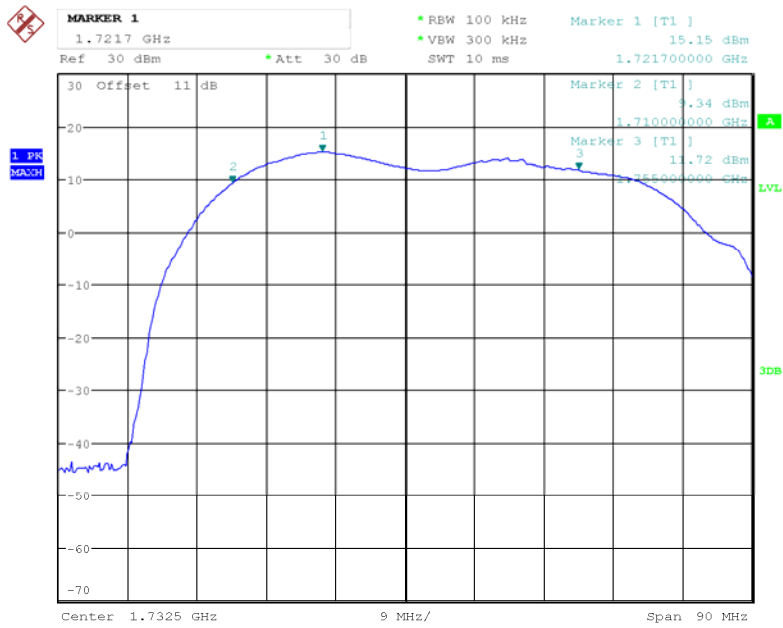

Date: 2.MAY.2018 22:48:31

PCS Band

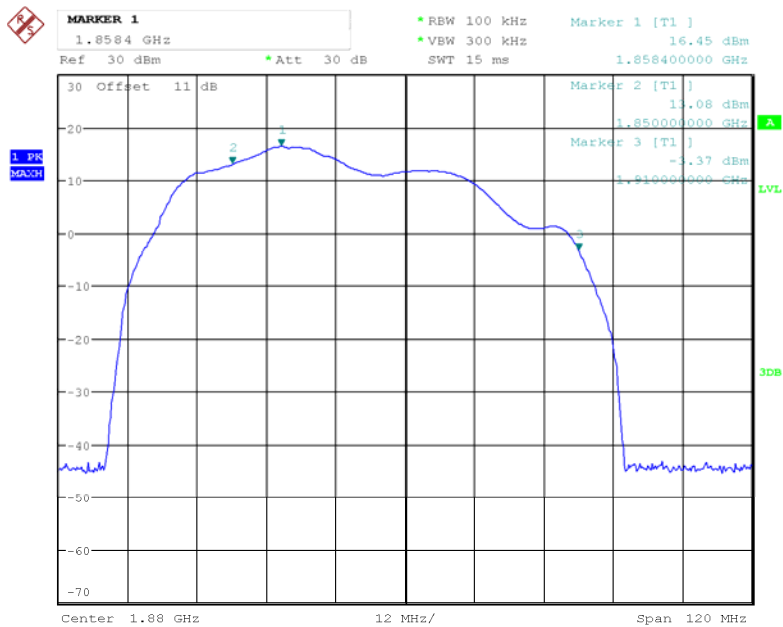

Date: 2.MAY.2018 20:22:19

Downlink:

Lower 700MHz Band

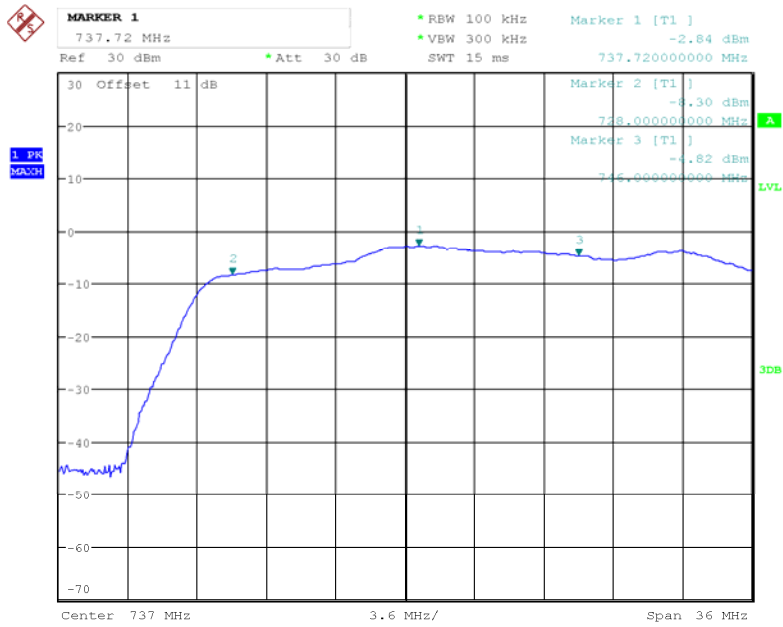

Date: 9.MAY.2018 18:48:58

Upper 700MHz Band

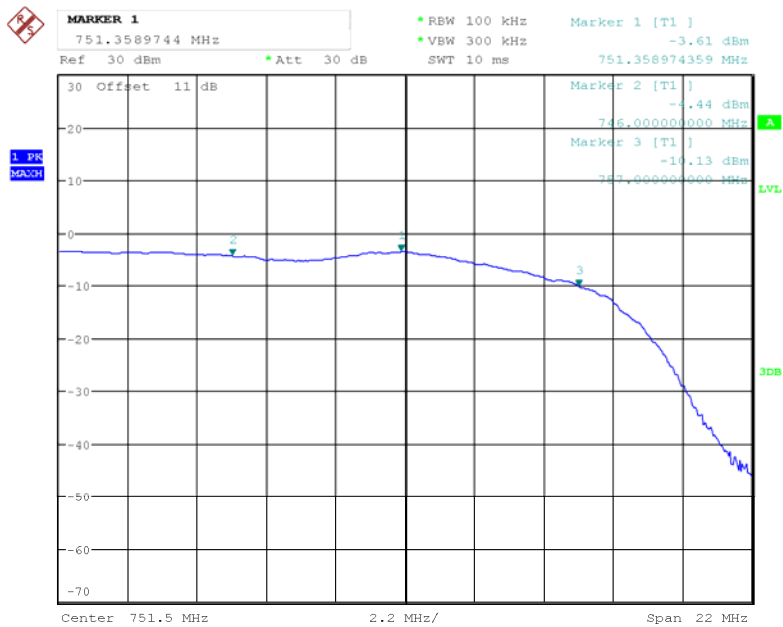

Date: 9.MAY.2018 19:31:23

Cellular Band

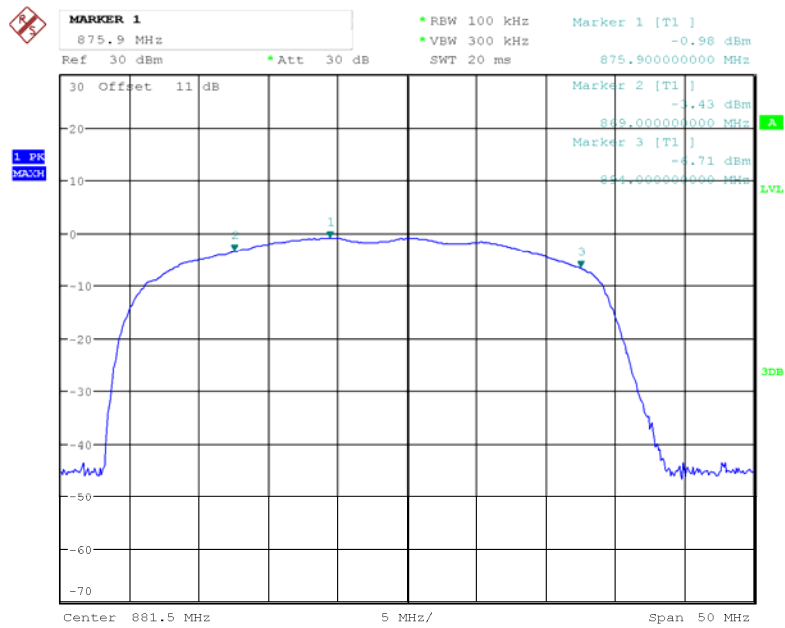

Date: 9.MAY.2018 19:37:01

AWS Band

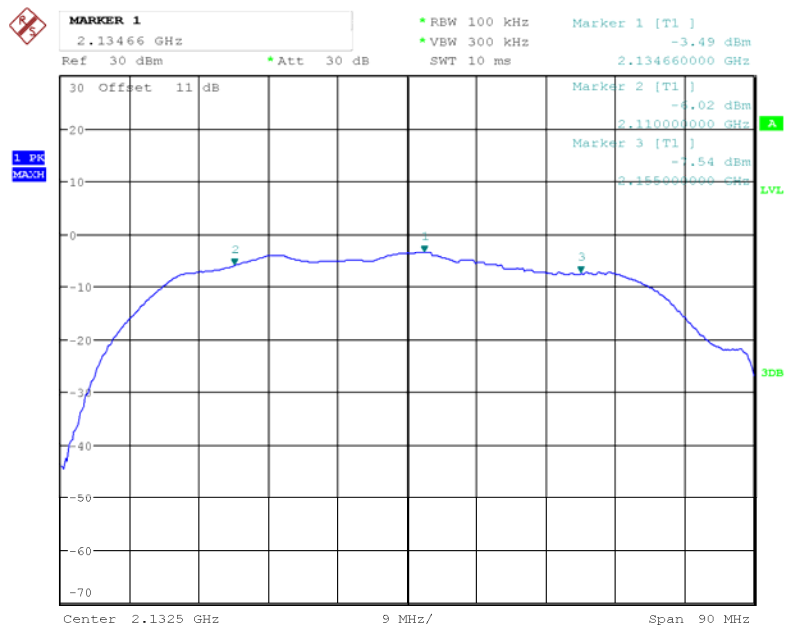

Date: 9.MAY.2018 20:03:30

PCS Band

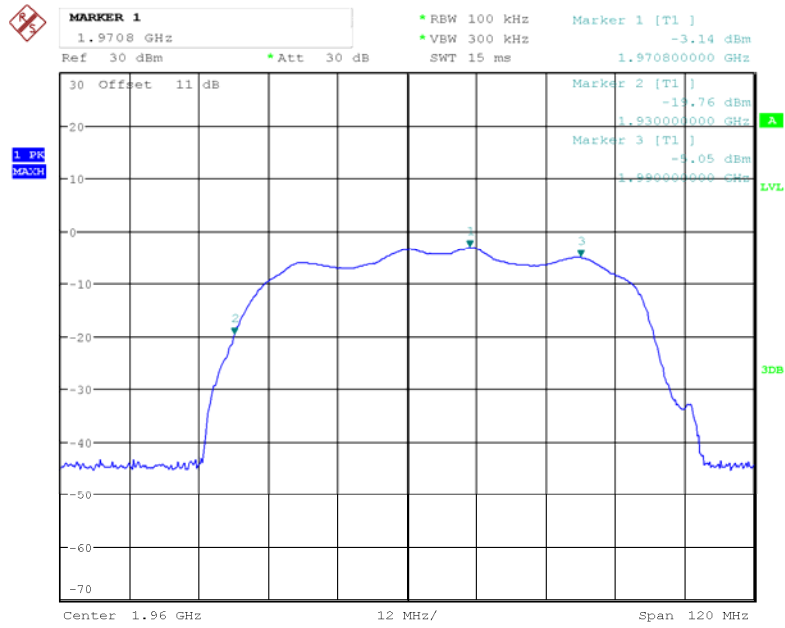

Date: 9.MAY.2018 19:54:09

§ 20.21(e)(8)(i)(D) ,§ 20.21(e)(8)(i)(B)& §20.21(e)(4)– MAXIMUM POWER MEASUREMENT

Applicable Standard

According to § 20.21(e)(8)(i)(D) Power Limits; § 20.21(e)(8)(i)(B) Bidirectional Capability (uplink minimum conducted power output); §20.21(e)(4) Self-monitoring.

This procedure shall be used to demonstrate compliance to the signal booster power limits and requirements as specified in §§ 20.21(e)(8)(i)(D) and 20.21(e)(8)(i)(B) for wideband consumer signal boosters.

- a) Compliance to authorized EIRP limits must be shown using the highest gains from the list of antennas, cabling, and coupling devices declared by the manufacturer for use with the consumer booster.
- b) In addition, the maximum power levels measured in this procedure will be utilized in calculating the maximum gain as described in the next subclause.
- c) The frequency with the highest power level in each operational band as determined in 7.1 is to be measured discretely by applying the following procedure utilizing the stated emission and power detector types independently.
- d) Use a signal generator to create a pulsed CW or GSM signal with a pulse width of 570 μ s and a duty cycle of 12.5% (i.e., one GSM timeslot), then measure utilizing the burst power function of the measuring instrument.
- e) Use a signal generator to create an AWGN signal with a 99% occupied bandwidth of 4.1 MHz, then measure utilizing the channel power or band power function of the measuring instrumentation.
- f) All modes of operation must be verified to maintain operation within authorized limits at the maximum uplink and downlink test levels per device type as defined in 5.4, by increasing the power level in 2 dB steps from the AGC level to the maximum input level specified in 5.5.

Test Procedure

- a) Connect the EUT to the test equipment as shown in Figure 1. Begin with the uplink output (donor port) connected to the spectrum analyzer.
- b) Configure the signal generator and spectrum analyzer for operation on the frequency determined in 7.1 with the highest power level, but with the center frequency of the signal no closer than 2.5 MHz from the band edge. The spectrum analyzer span shall be set to at least 10 MHz.
- c) Set the initial signal generator power to a level well below that which causes AGC control.
- d) Slowly increase the signal generator power level until the output signal reaches the AGC operational limit (from observation of signal behavior on the spectrum analyzer; i.e., no further increase in output power as input power is increased).
- e) Reduce power sufficiently on the signal generator to ensure that the AGC is not controlling the power output.
- f) Slowly increase the signal generator power to a level just below (within 0.5 dB of) the AGC limit without triggering the AGC. Note the signal generator power level as P_{in} .
- g) Measure the output power P_{out} with the spectrum analyzer as follows.
 - 1) Set RBW = 100 kHz for AWGN signal type and 300 kHz for CW or GSM signal type.
 - 2) Set VBW $\geq 3 \times$ RBW.
 - 3) Select either the BURST POWER or CHANNEL POWER measurement tool, as required for each signal type. The channel power integration bandwidth shall be 99% occupied bandwidth (4.1 MHz).
 - 4) Select the RMS (power averaging) detector.
 - 5) Ensure that the number Note: This requirement
 - 6) Set sweep time = auto

- 7) Trace average at least 100 traces in power averaging (i.e., RMS) mode.
- h) Record the measured power level as P_{OUT} with one set of results for the GSM or CW input stimulus and another set of results for the AWGN input stimulus.
- i) Repeat step h) while increasing the signal generator amplitude in 2 dB steps until the maximum input level indicated in 5.5 is reached. If the booster has shut down at any point during the input power steps it should be noted and step h) shall be repeated at an input level 1 dB less than that found to cause the shutdown.
- j) Repeat the entire procedure for each operational uplink and downlink frequency band supported by the booster.
- k) Provide tabulated results in the test report.

Test Data

Environmental Conditions

Temperature:	26.1~27.5 °C
Relative Humidity:	54~58 %
ATM Pressure:	101.5~102 kPa

The testing was performed by George Pang from 2018-05-10 to 2018-05-27.

Test Result: Compliance. Please refer to the following tables and plots

Output Power:

Mode	Operation Band	Signal type	Pre AGC Input level	Conducted Output level	Antenna Gain	Cable loss	EIRP	Limit		
			dBm	dBm	dBi	dB	dBm	dBm		
Uplink	Lower 700MHz	AWGN	-42.9	19.95	10	0.7	29.25	17-30		
		GSM	-40.4	17.66	10	0.7	26.96			
	Upper 700MHz	AWGN	-44.6	18.44	10	0.7	27.74			
		GSM	-42.4	17.66	10	0.7	26.96			
	cellular	AWGN	-44.9	18.86	10	0.7	28.16			
		GSM	-42	17.27	10	0.7	26.57			
	AWS	AWGN	-47.7	20.08	10	1	29.08			
		GSM	-43.5	17.57	10	1	26.57			
	PCS	AWGN	-44.2	18.3	10	1	27.3			
		GSM	-39.9	17.25	10	1	26.25			
	Downlink	Lower 700MHz	AWGN	-63.1	-0.19	10	0.7		9.11	≤17
			GSM	-60.5	-0.63	10	0.7		8.67	
Upper 700MHz		AWGN	-64.2	-0.71	10	0.7	8.59			
		GSM	-60.7	-1.09	10	0.7	8.21			
cellular		AWGN	-62.5	1.61	10	0.7	10.91			
		GSM	-59.9	0.72	10	0.7	10.02			
AWS		AWGN	-67.3	-2.48	10	1	6.52			
		GSM	-61.3	-2.51	10	1	6.49			
PCS		AWGN	-64.8	0.74	10	1	9.74			
		GSM	-60.7	-0.84	10	1	8.16			

Maximum Input level:

Mode	Operation Band	Signal type	Maximum Input level	Maximum Input level Limits	Conducted Output level		
			dBm	dBm	dBm		
Uplink	Lower 700MHz	AWGN	14.3	27.0	20.62		
		GSM	17.5		18.19		
	Upper 700MHz	AWGN	12.4		17.9		
		GSM	14.6		15.95		
	cellular	AWGN	12.8		19.45		
		GSM	16.7		19.56		
	AWS	AWGN	15.4		20.71		
		GSM	17.9		18.16		
	PCS	AWGN	15.3		18.73		
		GSM	17.6		16.06		
	Downlink	Lower 700MHz	AWGN		-50.8	-20	0.31
			GSM		-47.5		-0.18
Upper 700MHz		AWGN	-54.1	-0.29			
		GSM	-47.4	-0.69			
cellular		AWGN	-54.1	2.29			
		GSM	-47.1	1.21			
AWS		AWGN	-48.3	-1.8			
		GSM	-46.9	-1.85			
PCS		AWGN	-58.6	1.37			
		GSM	-51.1	-0.28			

**AWGN:
Output Power**

Lower 700MHz Downlink

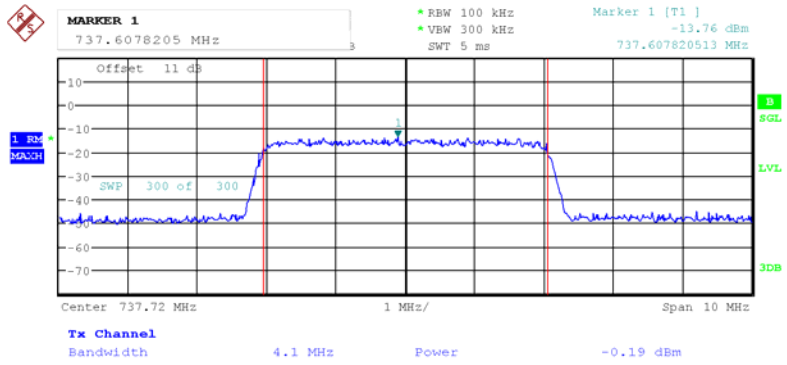

Date: 11.MAY.2018 00:38:57

Upper 700MHz Downlink

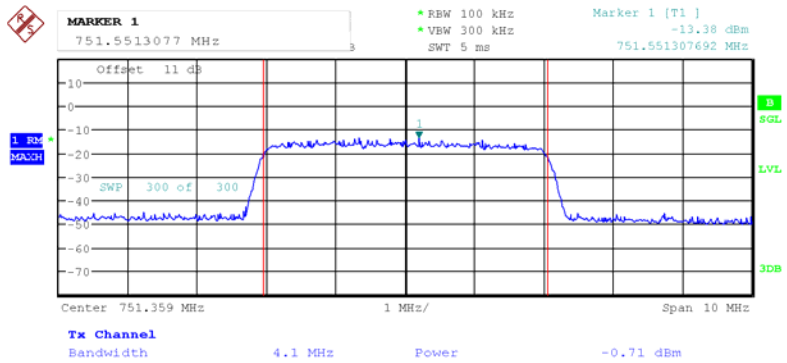

Date: 11.MAY.2018 00:44:04

Cellular Downlink

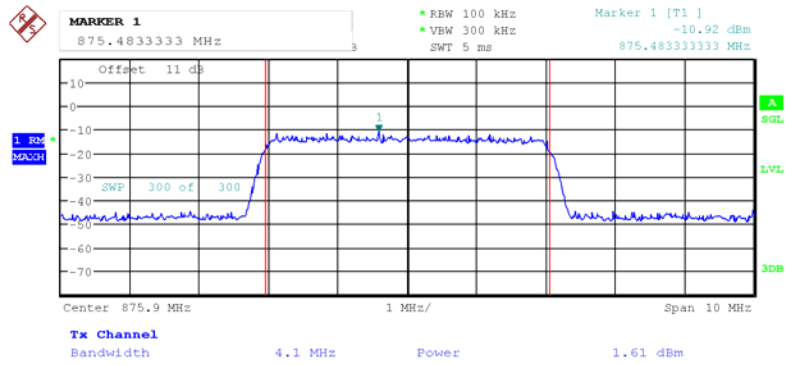

Date: 11.MAY.2018 18:41:39

AWS Downlink

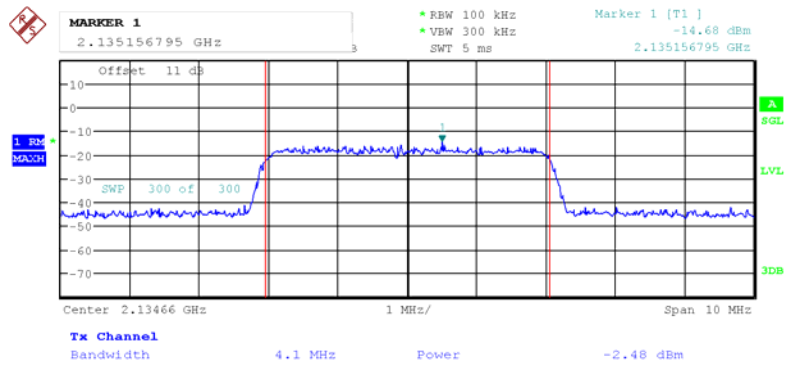

Date: 11.MAY.2018 19:44:52

PCS Band Downlink

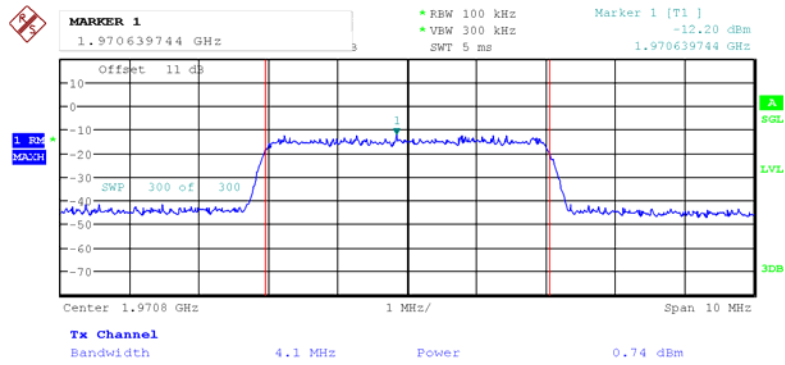

Date: 11.MAY.2018 18:49:04

Lower 700MHz Uplink

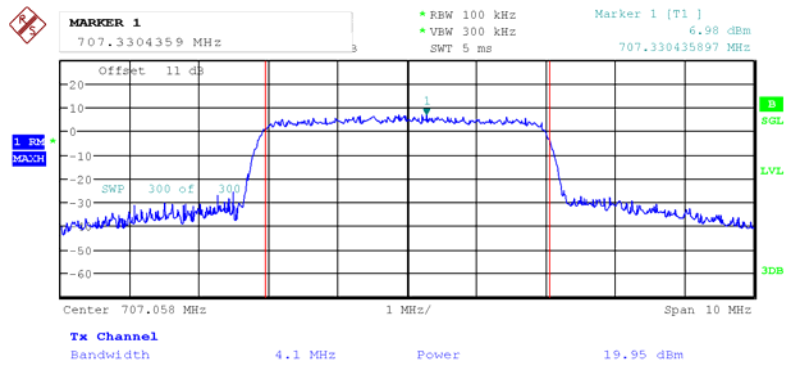

Date: 10.MAY.2018 23:09:00

Upper 700MHz Uplink

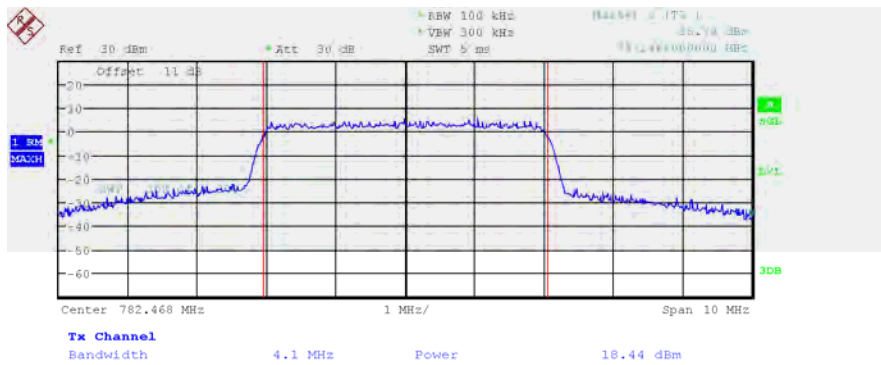

Date: 27.MAY.2018 14:31:26

Cellular Uplink

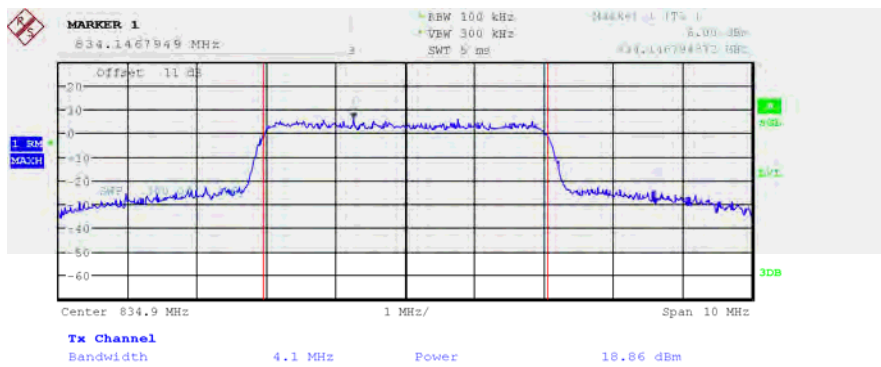

Date: 27.MAY.2018 14:41:45

AWS Uplink

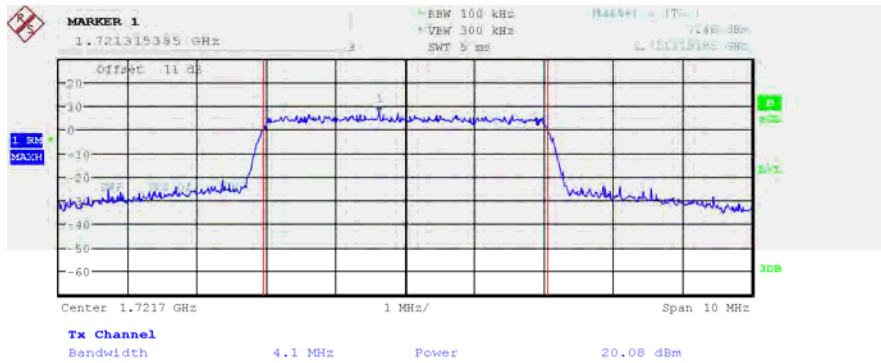

Date: 11.MAY.2018 00:15:36

PCS Band Uplink

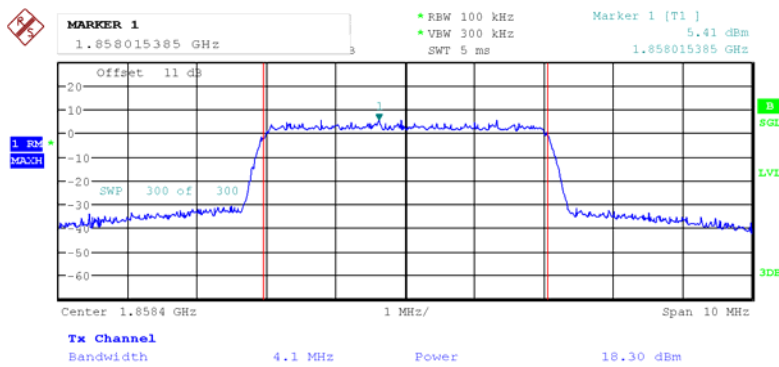

Date: 11.MAY.2018 00:09:44

GSM Signal: Output Power

Lower 700MHz Downlink

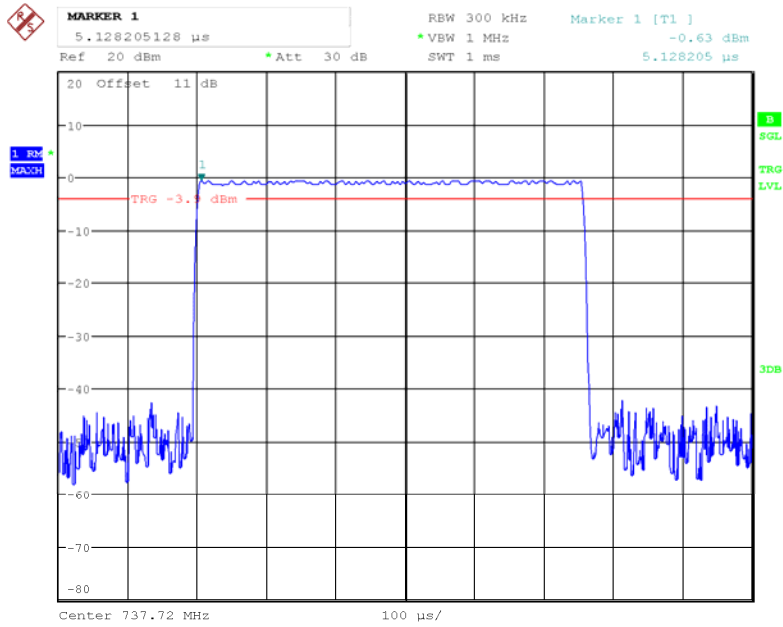

Date: 11.MAY.2018 00:33:10

Upper 700MHz Downlink

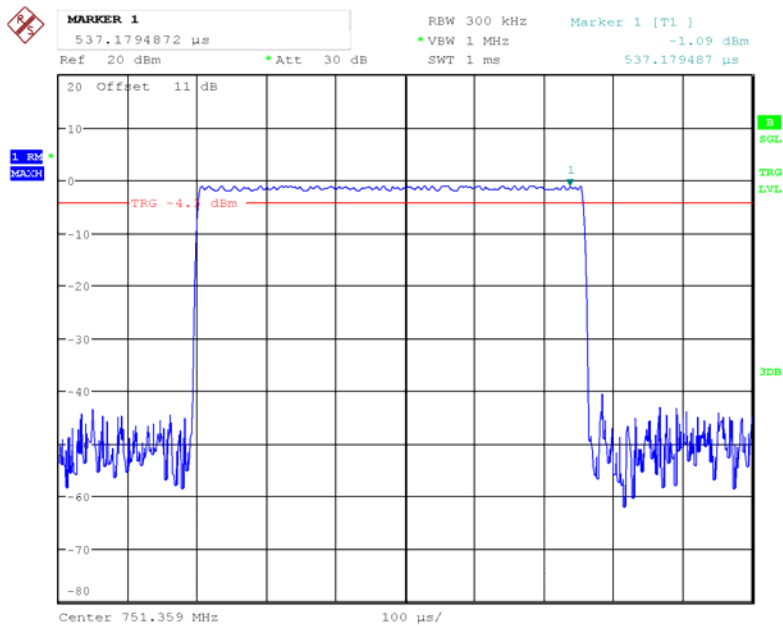

Date: 11.MAY.2018 00:48:16

Cellular Downlink

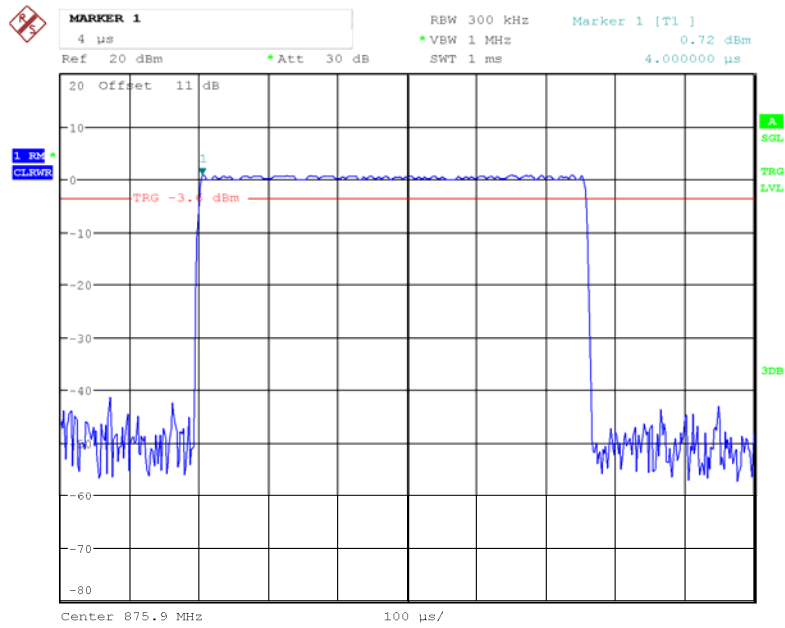

Date: 11.MAY.2018 18:36:43

AWS Downlink

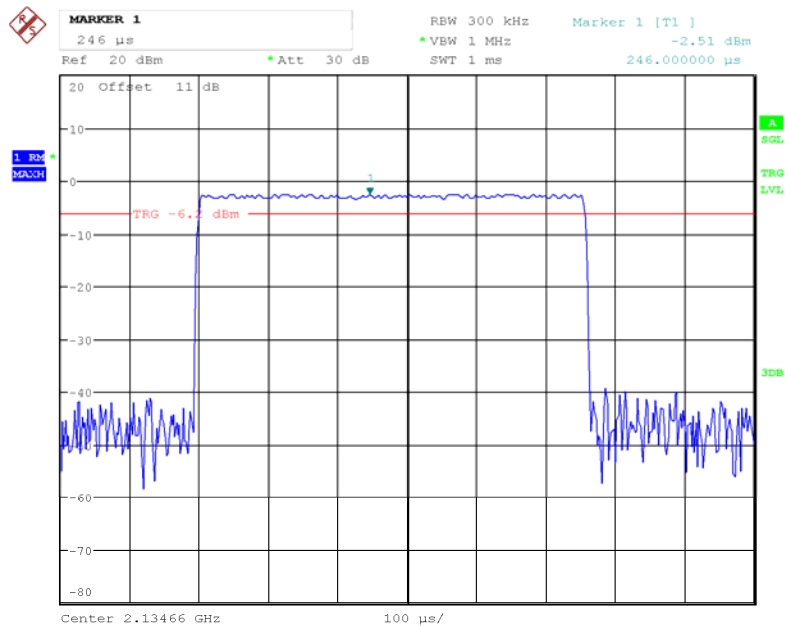

Date: 11.MAY.2018 19:39:11

PCS Band Downlink

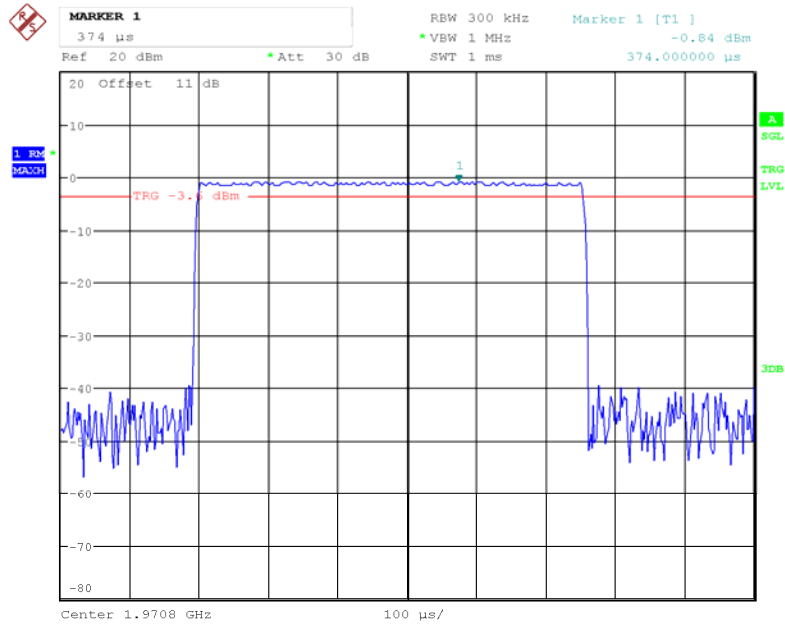

Date: 11.MAY.2018 19:32:06

Lower 700MHz Uplink

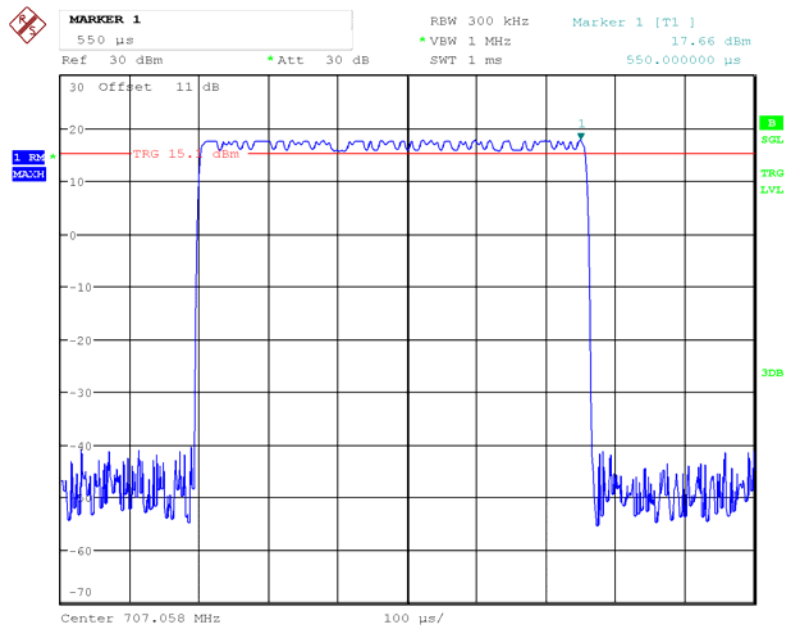

Date: 10.MAY.2018 23:21:32

Upper 700MHz Uplink

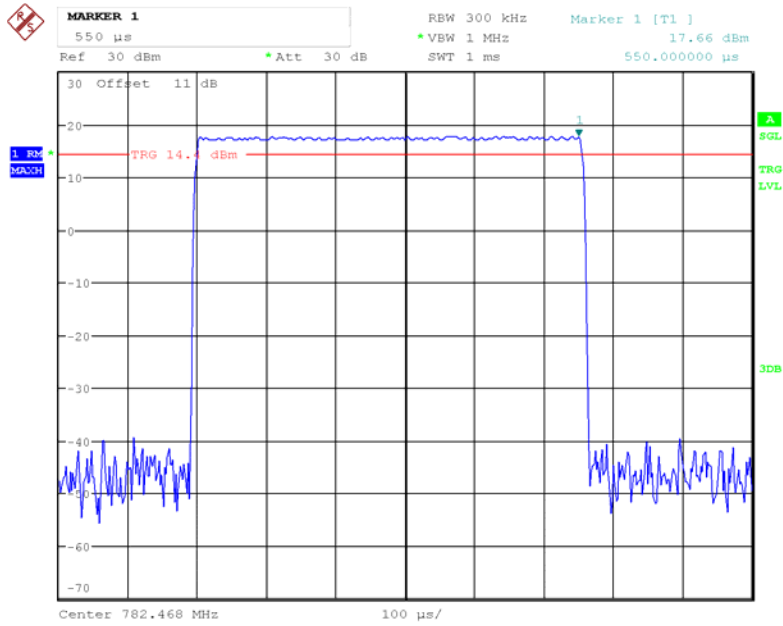

Date: 27.MAY.2018 14:48:27

Cellular Uplink

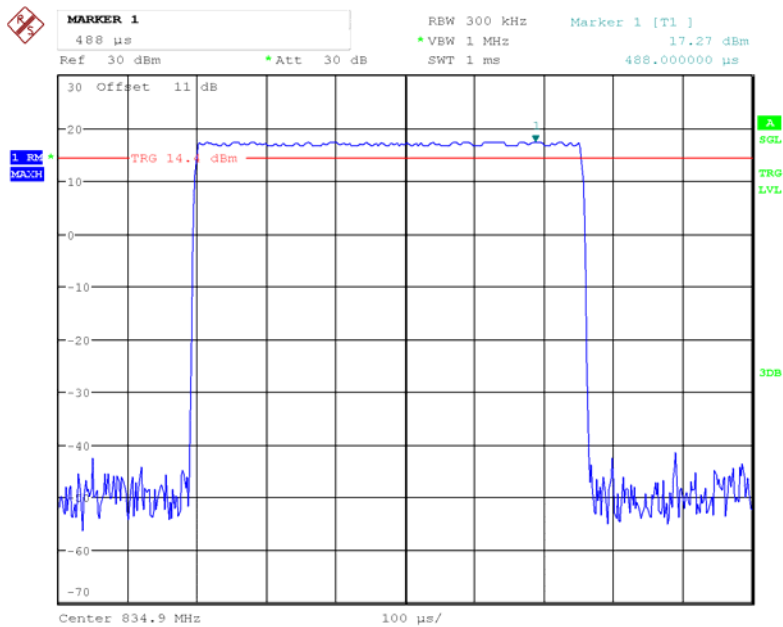

Date: 27.MAY.2018 14:45:20

AWS Uplink

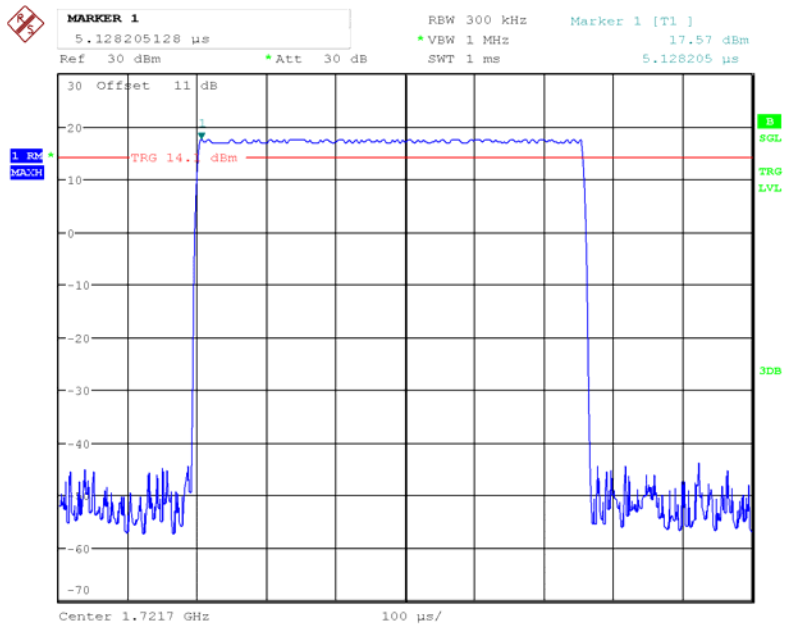

Date: 11.MAY.2018 00:21:50

PCS Band Uplink

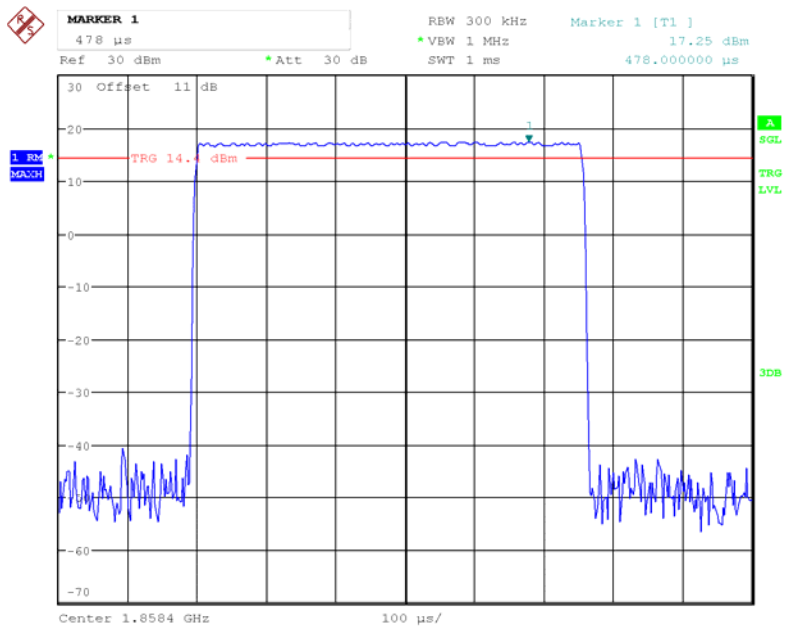

Date: 27.MAY.2018 14:51:25

§ 20.21(e)(8)(i)(C)(2), § 20.21(e)(8)(i)(B) & § 20.21(e)(4) – MAXIMUM BOOSTER GAIN COMPUTATION

Applicable Standards

According to § 20.21(e)(8)(i)(C)(2) Booster Gain Limits (maximum gain); § 20.21(e)(8)(i)(B) Bidirectional Capability (equivalent uplink and downlink gain); § 20.21(e)(4) Self-monitoring.

This subclause provides guidance on the computation of the maximum gain based on the results obtained from previous measurements. The NPS limits on maximum gain for fixed and mobile wideband consumer signal boosters are provided in § 20.21(e)(8)(i)(C)(2). Additionally, § 20.21(e)(8)(i)(B) requires that wideband consumer signal boosters be able to provide equivalent uplink and downlink gain (within 9 dB)

Test Procedure

- a) Calculate the maximum gain of the booster as follows to demonstrate compliance to the applicable gain limits as specified.
- b) For both the uplink and downlink in each supported frequency band, use each of the P_{OUT} and P_{IN} result pairs for all signal types used in 7.2 in the following equation to determine the maximum gain (G) of the booster:

$$G \text{ (dB)} = P_{OUT}(\text{dBm}) - P_{IN}(\text{dBm}).$$
- c) Record the maximum gain of the uplink and downlink paths for each supported frequency band, and verify that the each gain value complies with the applicable limit.
- d) Provide tabulated results in the test report.

Test Data

Environmental Conditions

Temperature:	27.2 °C
Relative Humidity:	66 %
ATM Pressure:	101.1 kPa

The testing was performed by George Pang on 2018-05-09.

Test Result: Compliance. Please refer to the following tables and the plots please refer to section 7.2.

Maximum gain:

Mode	Operation Band	Signal type	Pre AGC Input level	Conducted Output level	Gain	Limit	
			dBm	dBm	dB	dB	
Uplink	Lower 700MHz	AWGN	-42.9	19.95	62.85	63.49	
		GSM	-40.4	17.66	58.06		
	Upper 700MHz	AWGN	-44.6	18.44	63.04	64.36	
		GSM	-42.4	17.66	60.06		
	cellular	AWGN	-44.9	18.86	63.76	64.95	
		GSM	-42	17.27	59.27		
	AWS	AWGN	-47.7	20.08	67.78	71.27	
		GSM	-43.5	17.57	61.07		
	PCS	AWGN	-44.2	18.3	62.5	71.98	
		GSM	-39.9	17.25	57.15		
	Downlink	Lower 700MHz	AWGN	-63.1	-0.19	62.91	63.49
			GSM	-60.5	-0.63	59.87	
Upper 700MHz		AWGN	-64.2	-0.71	63.49	64.36	
		GSM	-60.7	-1.09	59.61		
cellular		AWGN	-62.5	1.61	64.11	64.95	
		GSM	-59.9	0.72	60.62		
AWS		AWGN	-67.3	-2.48	64.82	71.27	
		GSM	-61.3	-2.51	58.79		
PCS		AWGN	-64.8	0.74	65.54	71.98	
		GSM	-60.7	-0.84	59.86		

Note: Fixed Booster maximum gain shall not exceed 6.5 dB + 20 Log10 (Frequency), Where, Frequency is the uplink mid-band frequency of the supported spectrum bands in MHz.

Equivalent Uplink and downlink gain:

Operating Band	Signal type	Uplink Gain	Downlink Gain	Calculated Value	Limit
MHz		dB	dB	dB	dB
Lower 700MHz	AWGN	62.85	62.91	-0.06	±9
	GSM	58.06	59.87	-1.81	
Upper 700MHz	AWGN	63.04	63.49	-0.45	
	GSM	60.06	59.61	0.45	
cellular	AWGN	63.76	64.11	-0.35	
	GSM	59.27	60.62	-1.35	
AWS	AWGN	67.78	64.82	2.96	
	GSM	61.07	58.79	2.28	
PCS	AWGN	62.5	65.54	-3.04	
	GSM	57.15	59.86	-2.71	

§ 20.21(e)(8)(i)(F)- INTERMODULATION PRODUCT

Applicable Standards

According to § 20.21(e)(8)(i)(F) Intermodulation Limits.

Test Procedure

The following procedures shall be used to demonstrate compliance to the intermodulation limit specified in § 20.21(e)(8)(i)(F) for wideband consumer signal boosters.

- a) Connect the signal booster to the test equipment as shown in **Figure 2**. Begin with the uplink output connected to the spectrum analyzer.
- b) Set the spectrum analyzer RBW = 3 kHz.
- c) Set the VBW $\geq 3 \times$ RBW.
- d) Select the RMS detector
- e) Set the spectrum analyzer center frequency to the center of the supported operational band under test.
- f) Set the span to 5 MHz. Affirm that the number of measurement points per sweep $\geq (2 \times \text{span})/\text{RBW}$.
- g) Configure the two signal generators for CW operation with generator 1 tuned 300 kHz below the operational band center frequency and generator 2 tuned 300 kHz above the operational band center frequency.
- h) Set the signal generator amplitudes so that the power from each into the RF combiner is equivalent, then turn on the RF output.
- i) Increase the signal generators' amplitudes equally until just before the EUT begins AGC and affirm that all intermodulation products (if any exist) are below the specified limit of -19 dBm.
- j) Utilize the trace averaging function of the spectrum analyzer and wait for the trace to stabilize. Place a marker at the highest amplitude intermodulation product.
- k) Record the maximum intermodulation product amplitude level that is observed.
- l) Capture the spectrum analyzer trace for inclusion in the test report.
- m) Repeat 7.4e) to 7.4l) for all uplink and downlink operational bands.

Note: If using a single signal generator with dual outputs, affirm that intermodulation products are not the result of the generator.

- n) Increase the signal generator amplitude in 2 dB steps to 10 dB above the AGC threshold determined in 7.4i), but to not to exceed the maximum input level in 5.5, to affirm that the EUT maintains compliance with the intermodulation limit

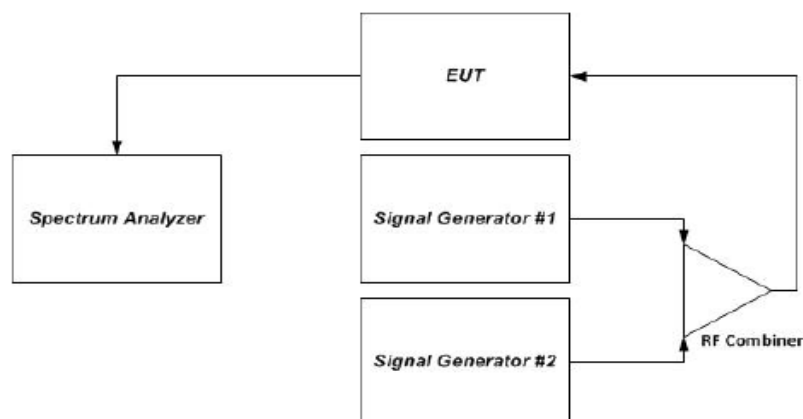

Figure 2 – Intermodulation product instrumentation test setup

Test Data

Environmental Conditions

Temperature:	27.8~28.3 °C
Relative Humidity:	60~64 %
ATM Pressure:	100.7~100.8 kPa

The testing was performed by George Pang on 2018-05-07 and 2018-05-08.

Test Result: Compliance. Please refer to following plots.

Downlink

Lower 700MHz-AGC

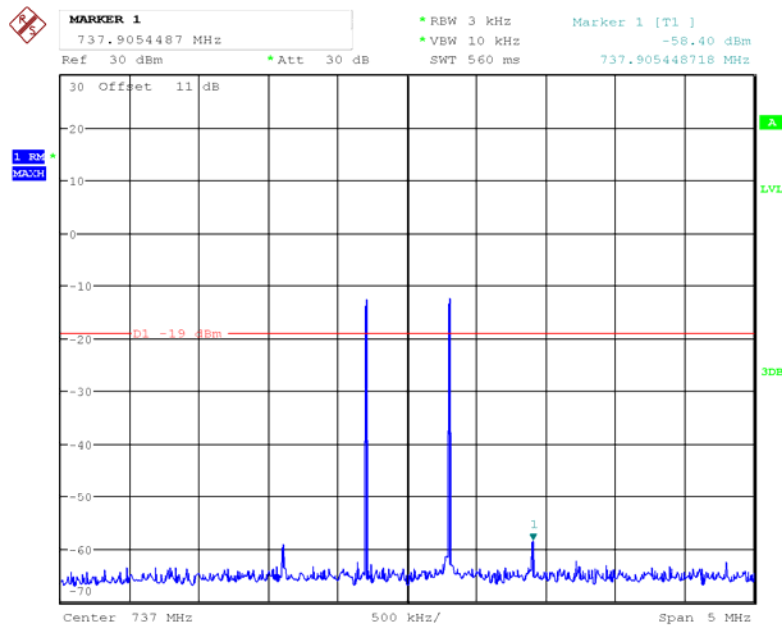

Date: 8.MAY.2018 00:01:01

Lower 700MHz Above AGC

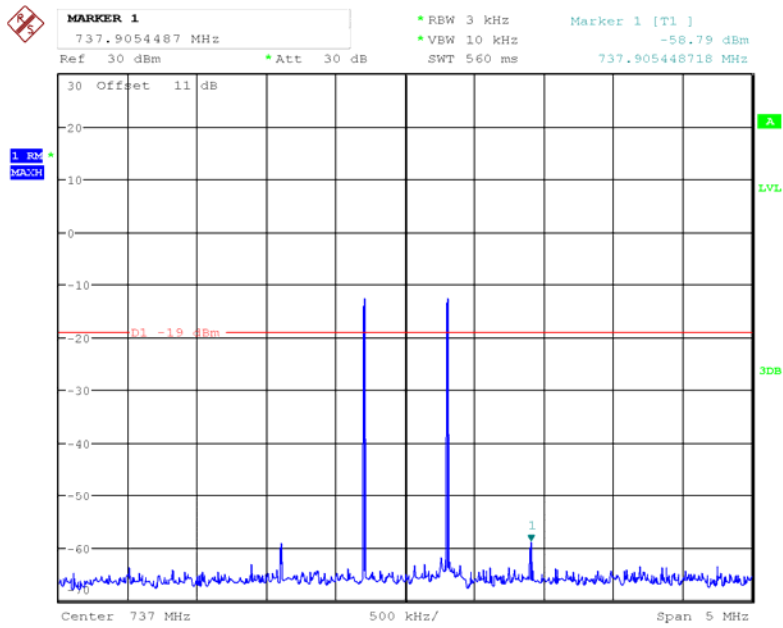

Date: 8.MAY.2018 00:02:07

Upper 700MHz -AGC

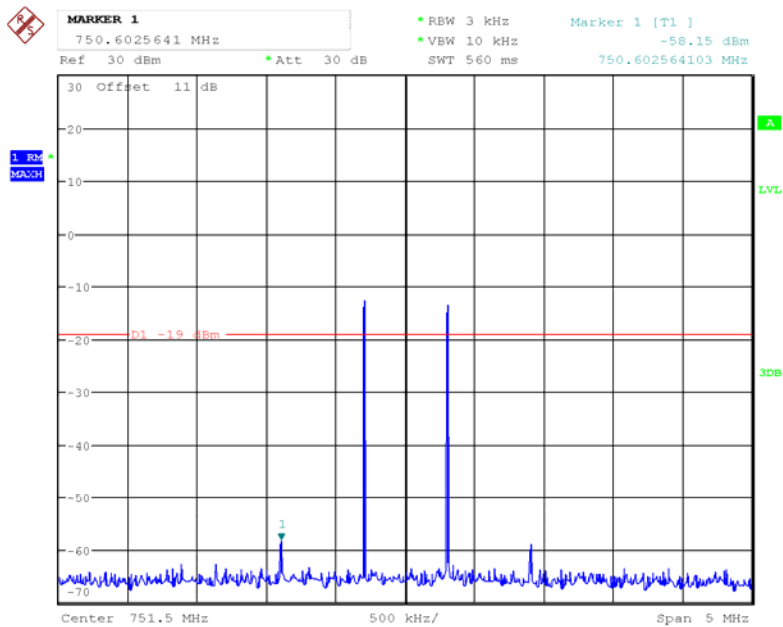

Date: 8.MAY.2018 00:06:38

Upper 700MHz Above AGC

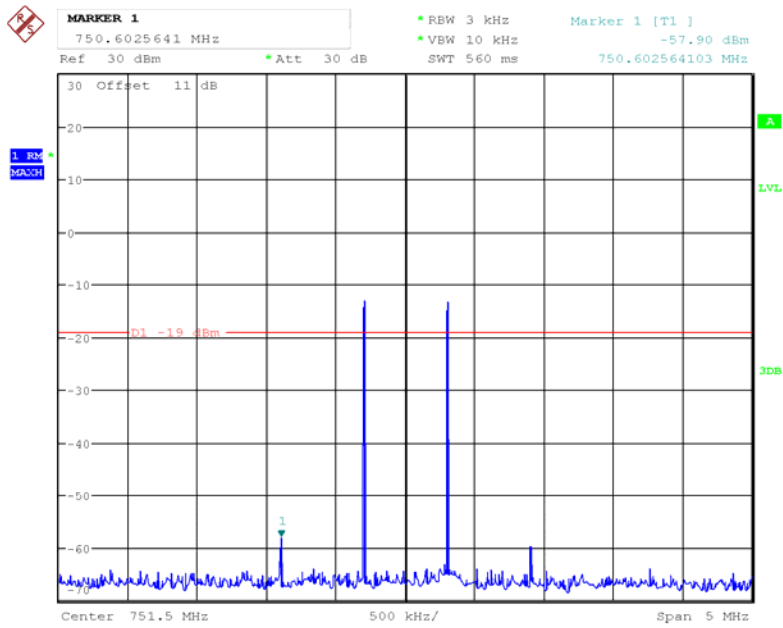

Date: 8.MAY.2018 00:08:44

Cellular Pre-AGC

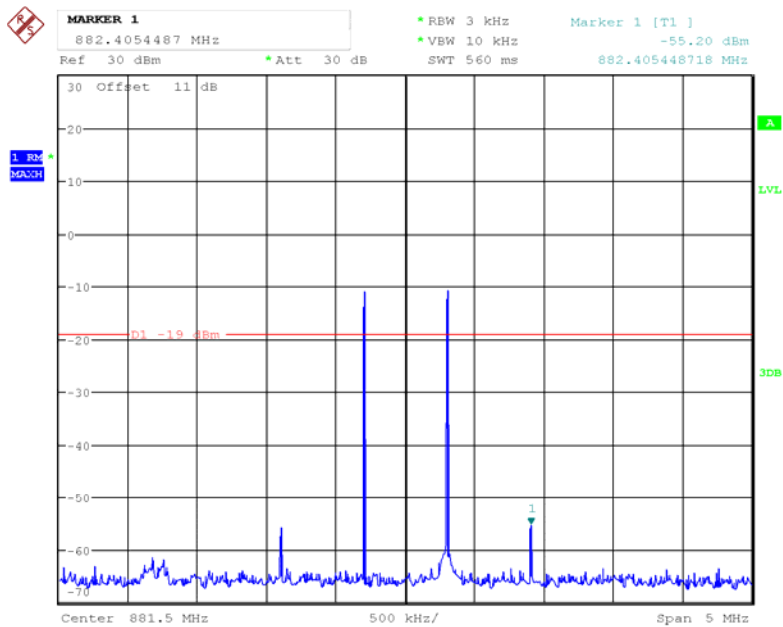

Date: 8.MAY.2018 00:12:57

Cellular Above AGC

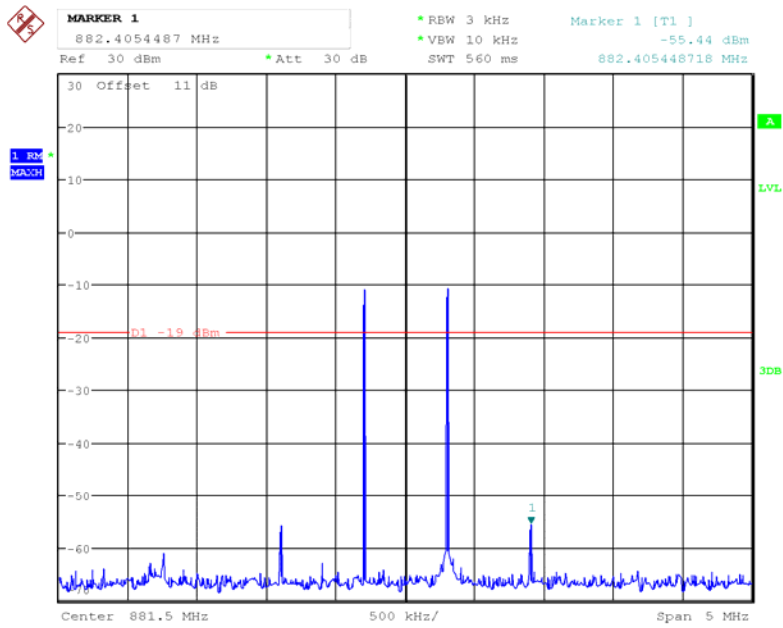

Date: 8.MAY.2018 00:13:50

AWS-AGC

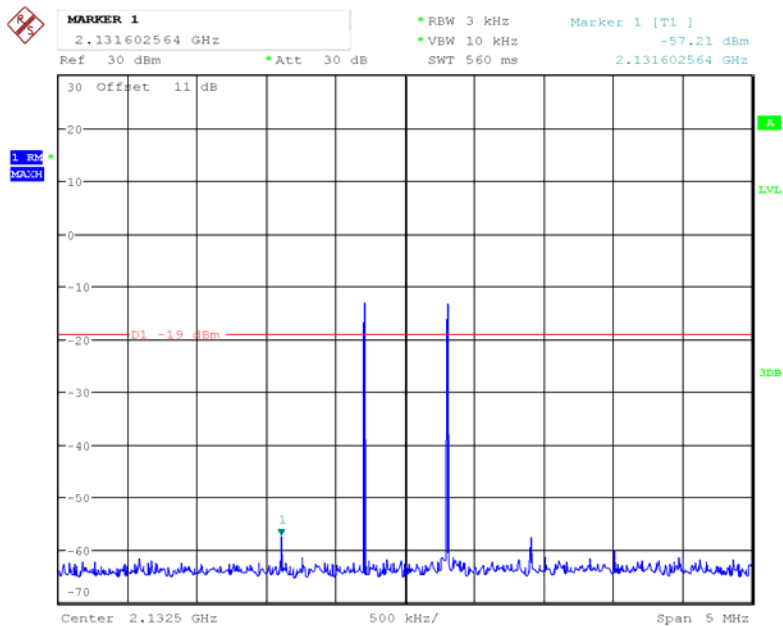

Date: 8.MAY.2018 00:27:04

AWS Above AGC

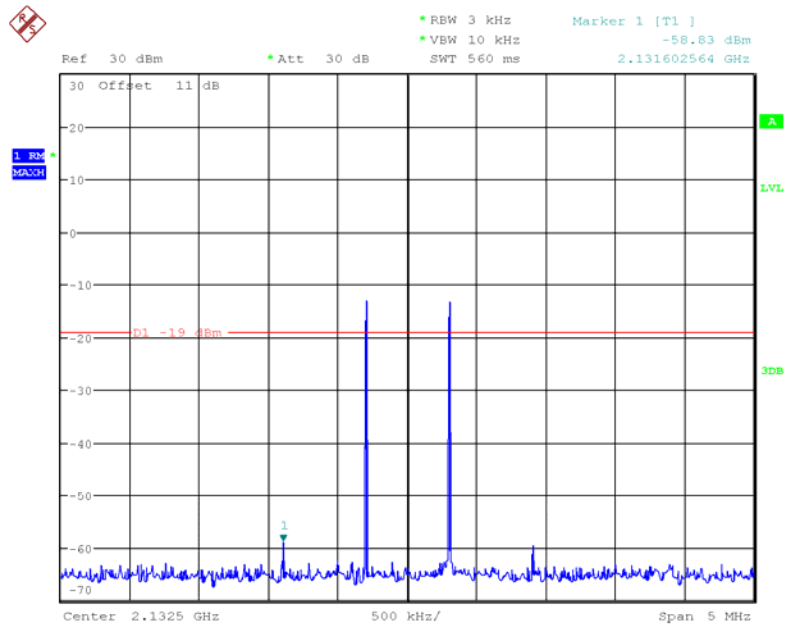

Date: 8.MAY.2018 00:29:20

PCS Pre-AGC

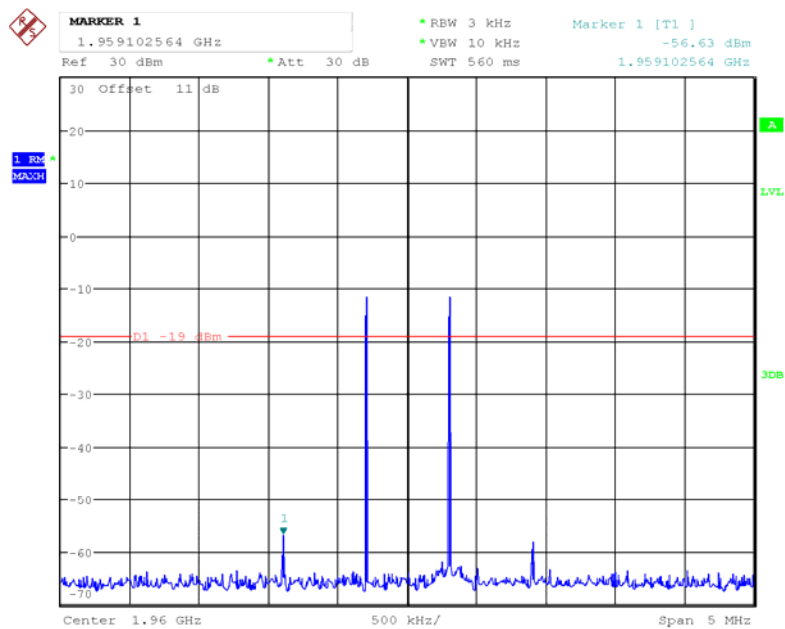

Date: 8.MAY.2018 00:19:05

PCS Above AGC

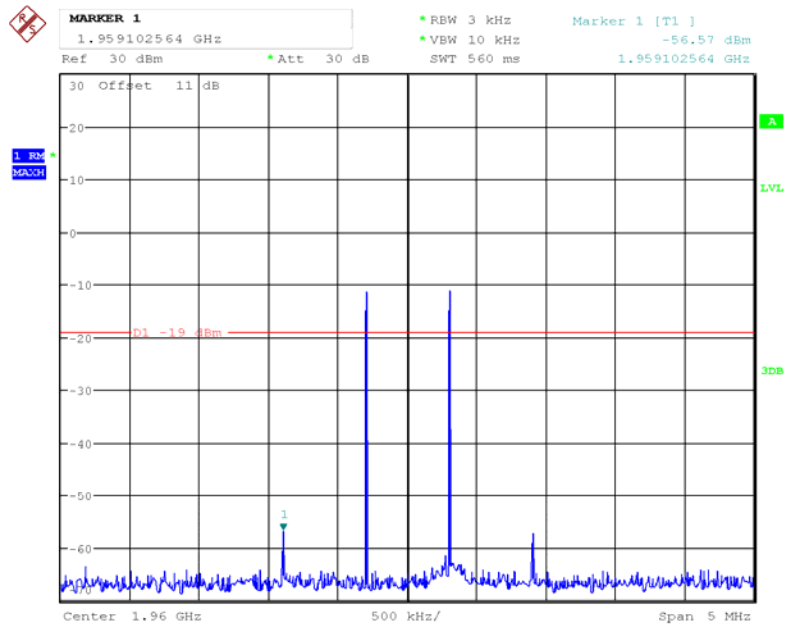

Date: 8.MAY.2018 00:20:56

Uplink

Lower 700MHz -AGC

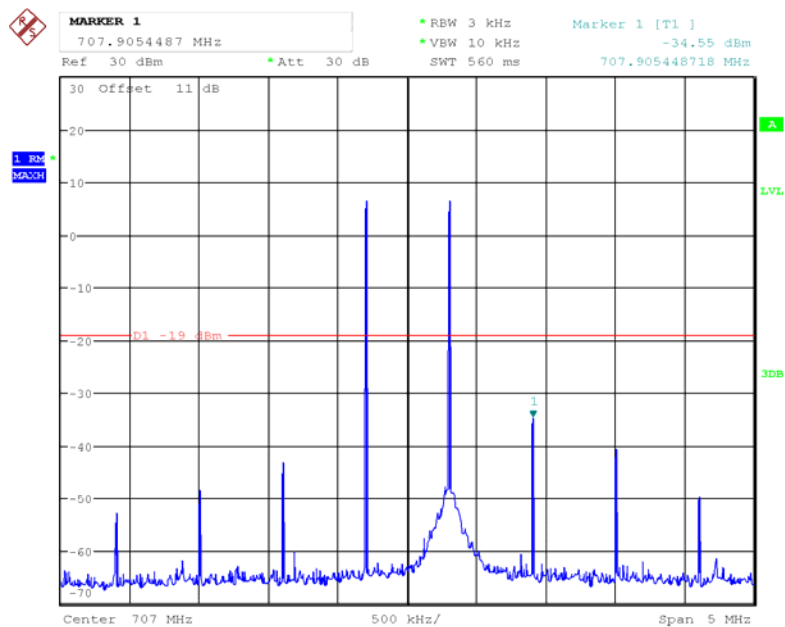

Date: 7.MAY.2018 23:28:56

Lower 700MHz Above AGC

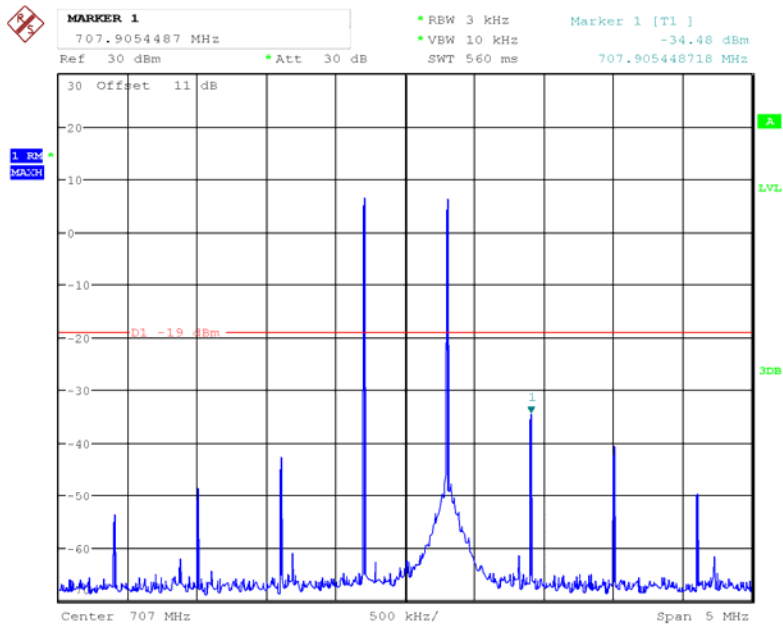

Date: 7.MAY.2018 23:30:19

Upper 700MHz -AGC

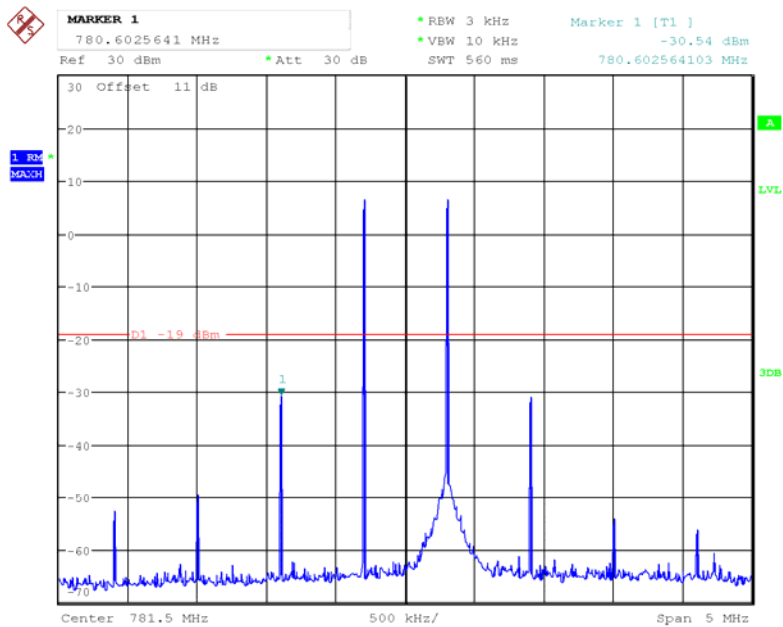

Date: 7.MAY.2018 23:39:55

Upper 700MHz Above AGC

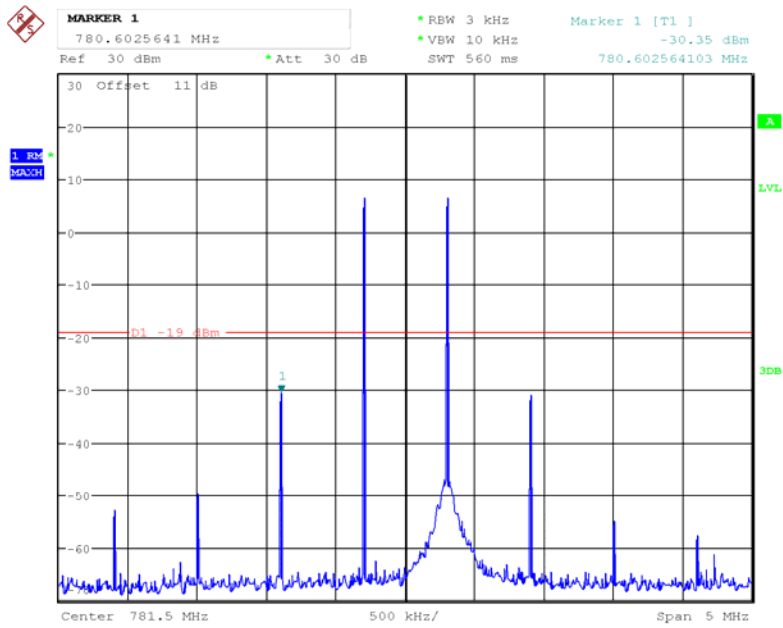

Date: 7.MAY.2018 23:41:06

Cellular Pre-AGC

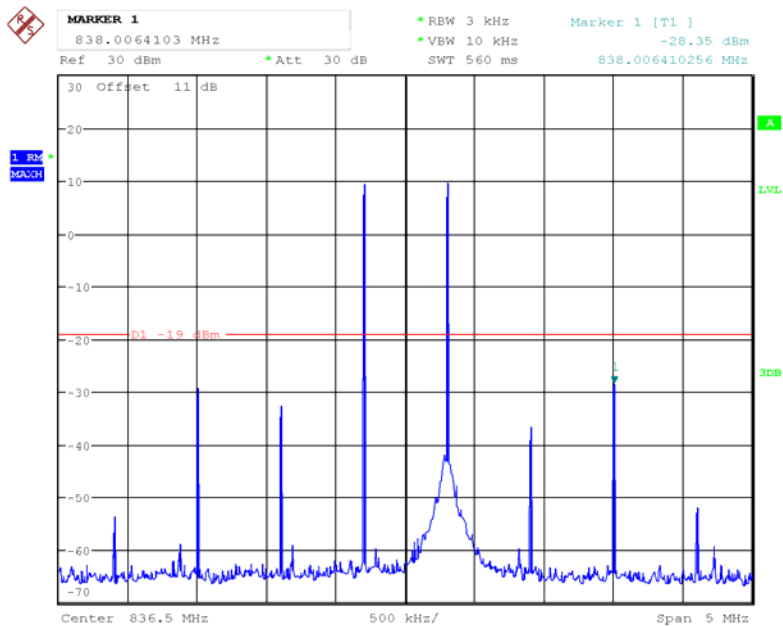

Date: 7.MAY.2018 23:33:47

Cellular Above AGC

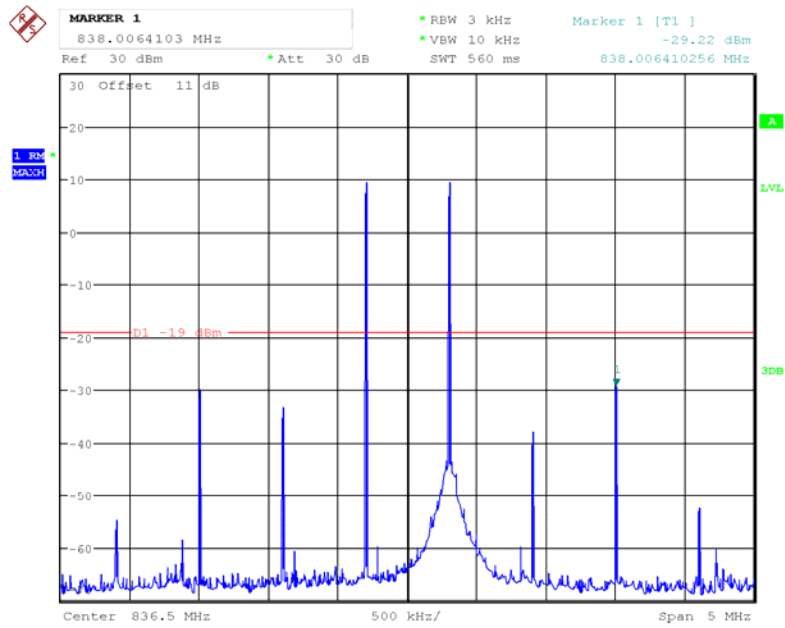

Date: 7.MAY.2018 23:35:11

AWS-AGC

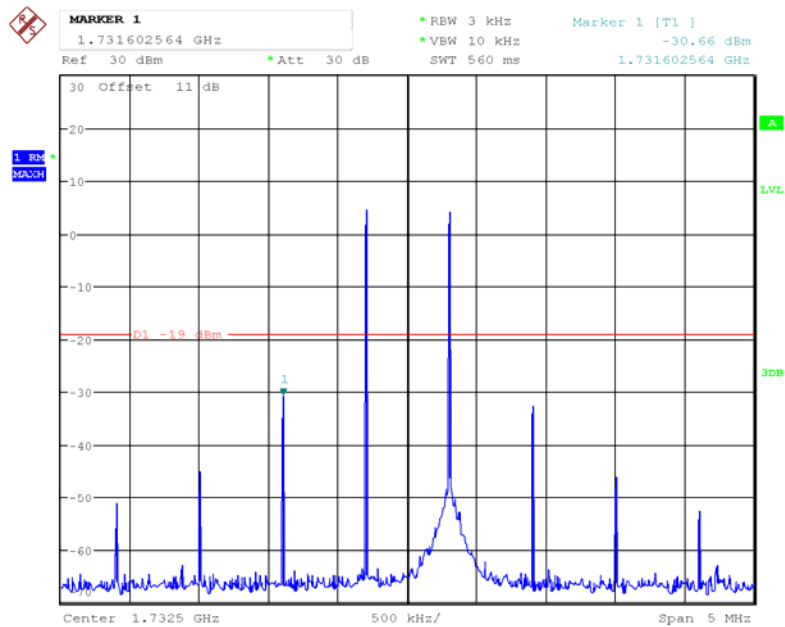

Date: 7.MAY.2018 23:50:41

AWS Above AGC

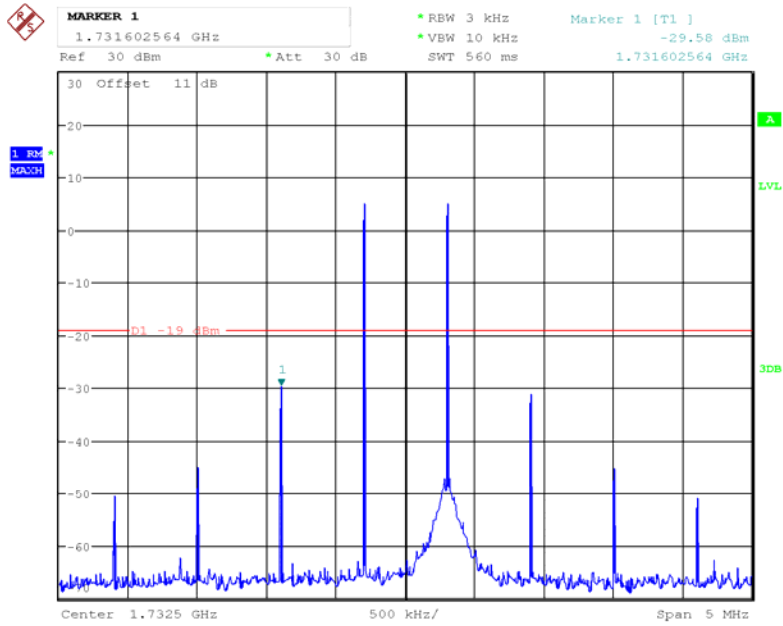

Date: 7.MAY.2018 23:52:43

PCS Pre-AGC

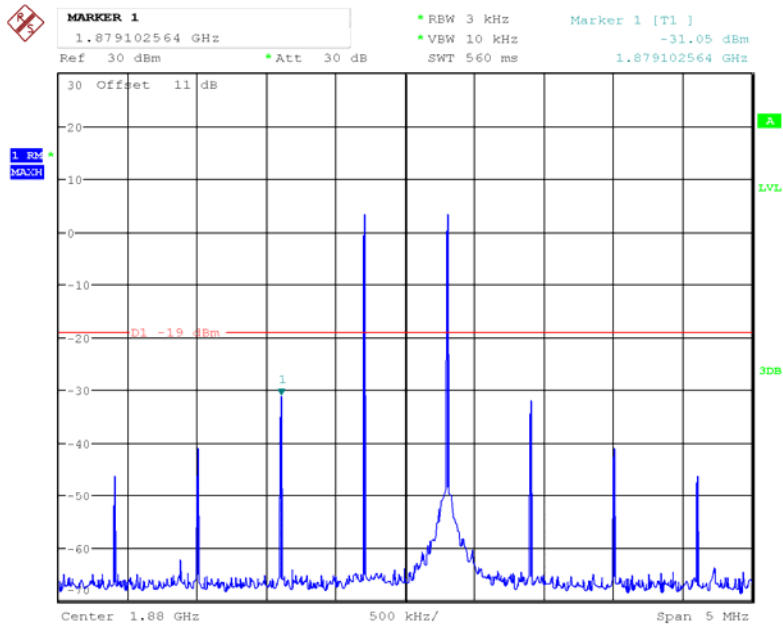

Date: 7.MAY.2018 23:45:56

PCS Above AGC

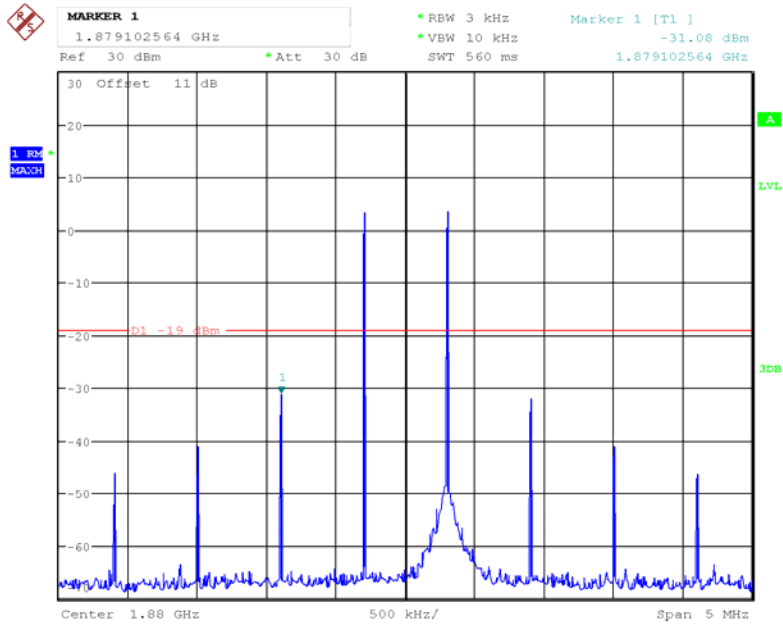

Date: 7.MAY.2018 23:46:58

§ 20.21(e)(8)(i)(E)- OUT OF BAND EMISSIONS

Applicable Standards

According to § 20.21(e)(8)(i)(E) Out of Band Emission Limits.

Test Procedure

This measurement is intended to demonstrate compliance to the limit specified in § 20.21(e)(8)(i)(E). The mobile emission limit applicable to the supported band of operation can be determined from the applicable rule part as listed in Annex A for each authorized operating band.

- a) Connect the EUT to the test equipment as shown in **Figure 1**. Begin with the uplink output connected to the spectrum analyzer.
- b) Configure the signal generator for the appropriate operation for all uplink and downlink bands:
 - i) GSM: 0.2 MHz from upper and lower band edges.
 - ii) LTE (5 MHz): 2.5 MHz from upper and lower band edges.
 - iii) CDMA: 1.25 MHz from upper and lower band edges, except for cellular band as follows (only the upper and lower frequencies need to be tested):

824.88 MHz, 845.73 MHz, 836.52 MHz, 848.10 MHz, 869.88 MHz, 890.73 MHz, 881.52 MHz, 893.10 MHz.

Note 1: *Alternative test modulation types:*

- CDMA (alternative 1.25 MHz AWGN)
- LTE 5 MHz (alternative W-CDMA or 4.1 MHz AWGN)

Note 2: *For LTE, the signal generator should utilize the uplink and downlink signal types for these modulations in uplink and downlink tests, respectively. LTE shall use 5 MHz signal, 25 resource blocks transmitting.*

Note 3: *When using an AWGN test signal, the bandwidth shall be the measured 99% occupied bandwidth.*

- c) Set the signal generator amplitude to the maximum power level prior to AGC similar to the procedures in 7.2.2e) to 7.2.2f) of power measurement procedure for appropriate modulations.
- d) Set RBW = measurement bandwidth specified in the applicable rule section for the supported frequency band (*see Annex A for cross-reference to applicable rule section*).
- e) Set VBW = $3 \times$ RBW.
- f) Select the RMS (power averaging) detector.
- g) Sweep time = auto-couple.
- h) Set the analyzer start frequency to the upper band/block edge frequency and the stop frequency to the upper band/block edge frequency plus 300 kHz (when operational frequency is < 1 GHz) or 3 MHz (when operational frequency is ≥ 1 GHz).
- i) Trace average at least 100 traces in power averaging (i.e., RMS) mode.
- j) Use peak marker function to find the maximum power level.
- k) Capture the spectrum analyzer trace of the power level for inclusion in the test report.
- l) Increase the signal generator amplitude in 2 dB steps until the maximum input level indicated in 5.5 is reached. Affirm that the EUT maintains compliance with the OOB limits.
- m) Reset the analyzer start frequency to the lower band/block edge frequency minus 300 kHz (when operational frequency is < 1 GHz) or 3 MHz (when operational frequency is ≥ 1 GHz), and the stop frequency to the lower band/block edge frequency and repeat 7.5j) to 7.5l).
- n) Repeat 7.5b) through 7.5m) for each uplink and downlink operational band.

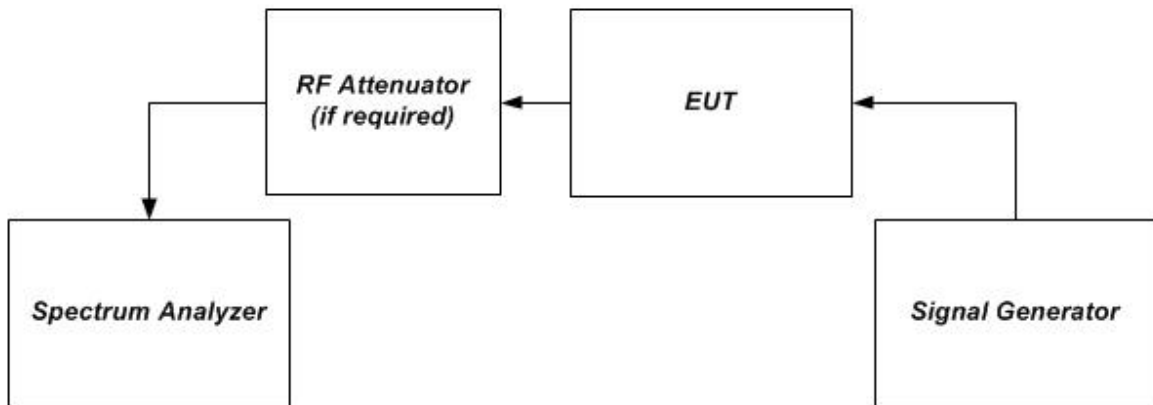

Figure 1 – Band verification test instrumentation setup

Test Data

Environmental Conditions

Temperature:	26.4~27.6 °C
Relative Humidity:	52~61 %
ATM Pressure:	101.2~102.1 kPa

The testing was performed by George Pang from 2018-05-24 to 2018-06-06.

Test Result: Compliance. Please refer to following plots.

Downlink

PCS Band CDMA Left Side 1931.25MHz Pre-AGC

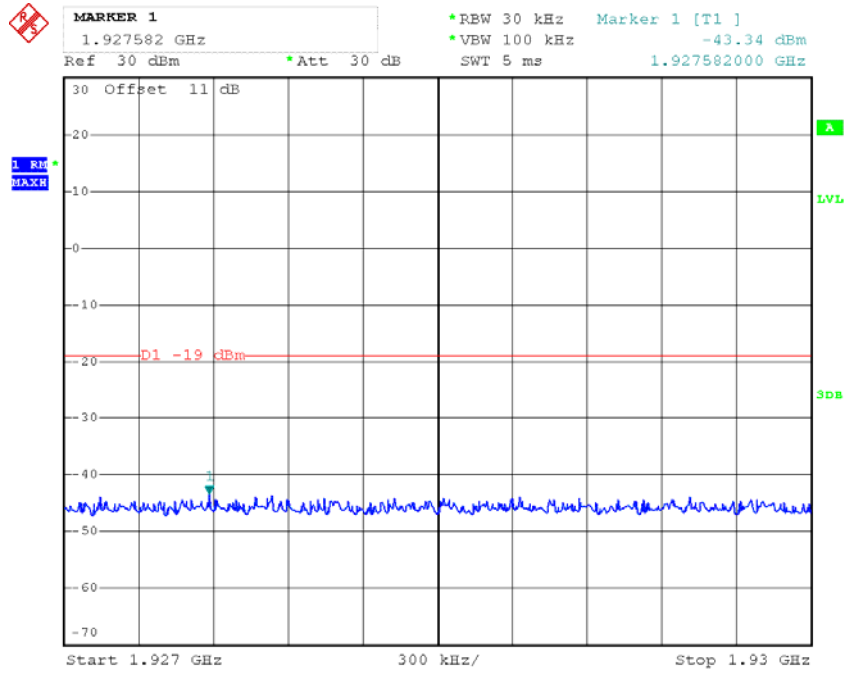

Date: 25.MAY.2018 22:57:31

PCS Band CDMA Left Side 1931.25MHz Above AGC

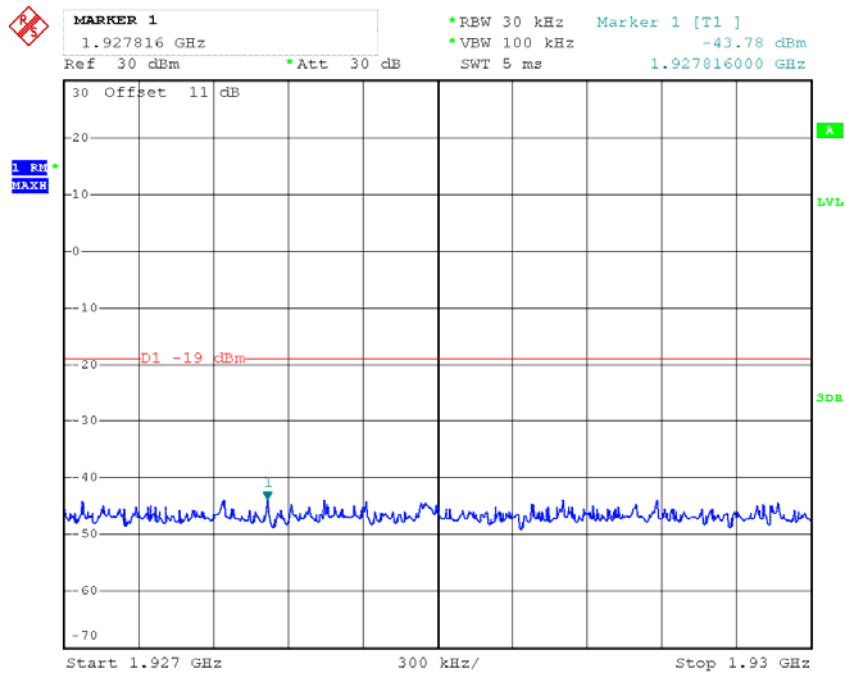

Date: 25.MAY.2018 22:58:42

PCS Band CDMA Right Side 1988.75MHz Pre-AGC

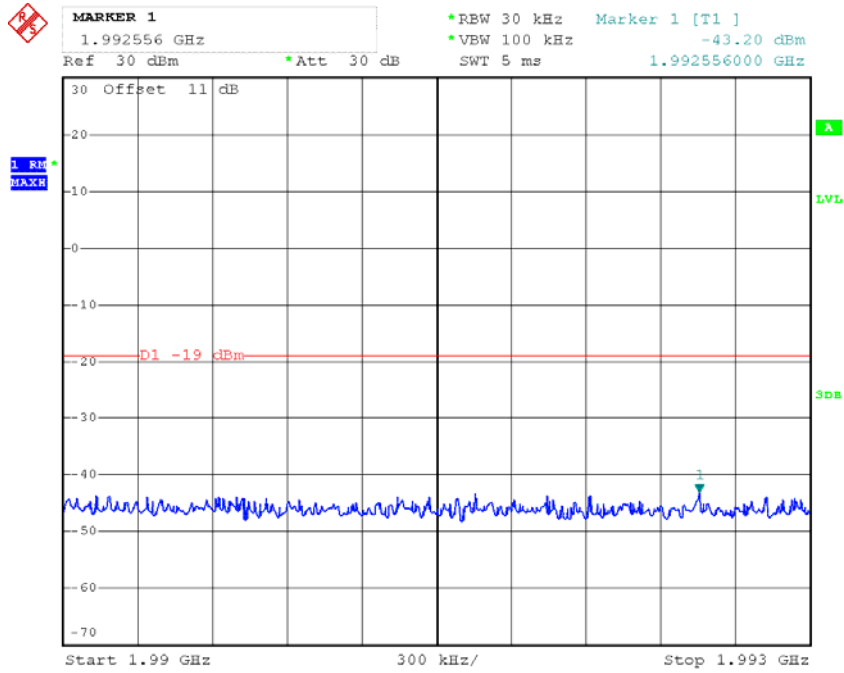

Date: 25.MAY.2018 22:53:31

PCS Band CDMA Right Side 1988.75MHz Above AGC

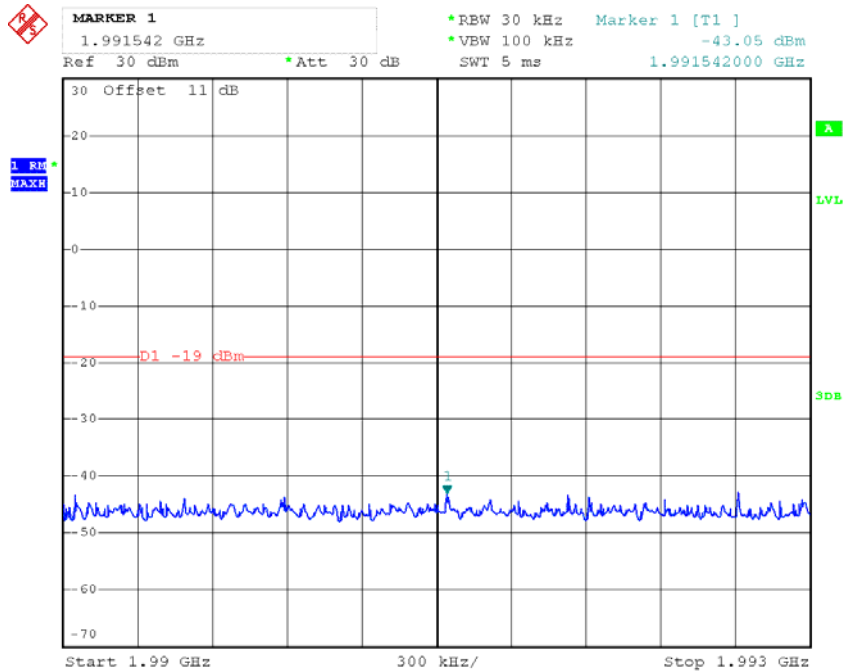

Date: 25.MAY.2018 22:54:30

PCS Band LTE Left Side 1932.5MHz Pre-AGC

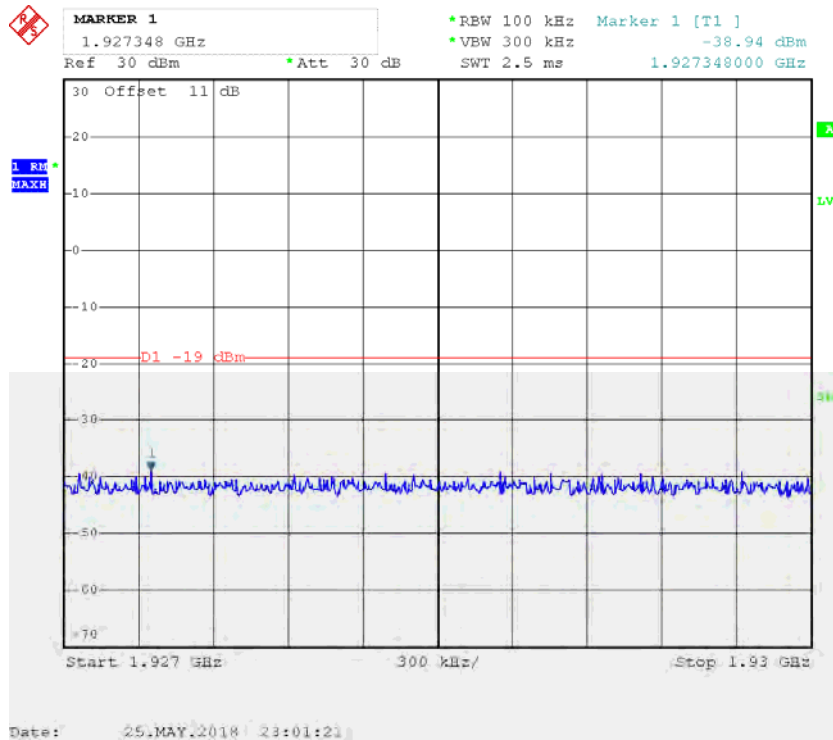

PCS Band LTE Left Side 1932.5MHz Above AGC

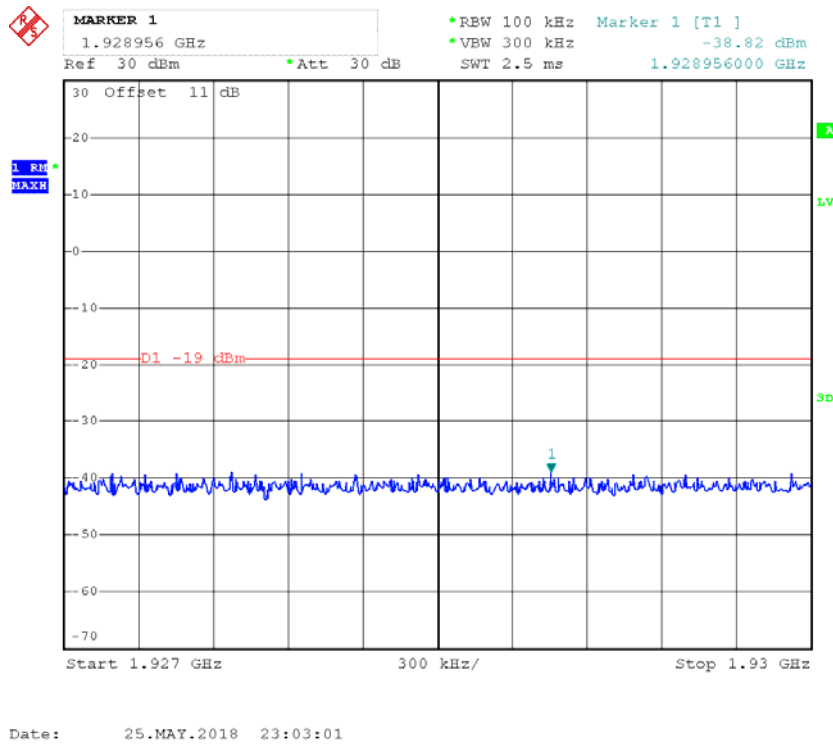

PCS Band LTE Right Side 1987.5MHz Pre-AGC

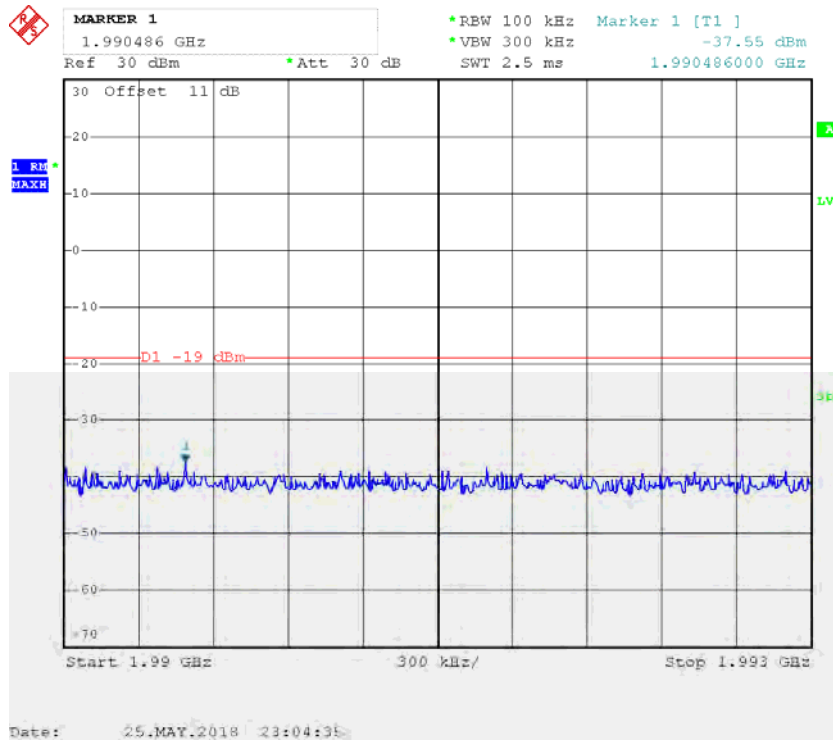

PCS Band LTE Right Side 1987.5MHz Above AGC

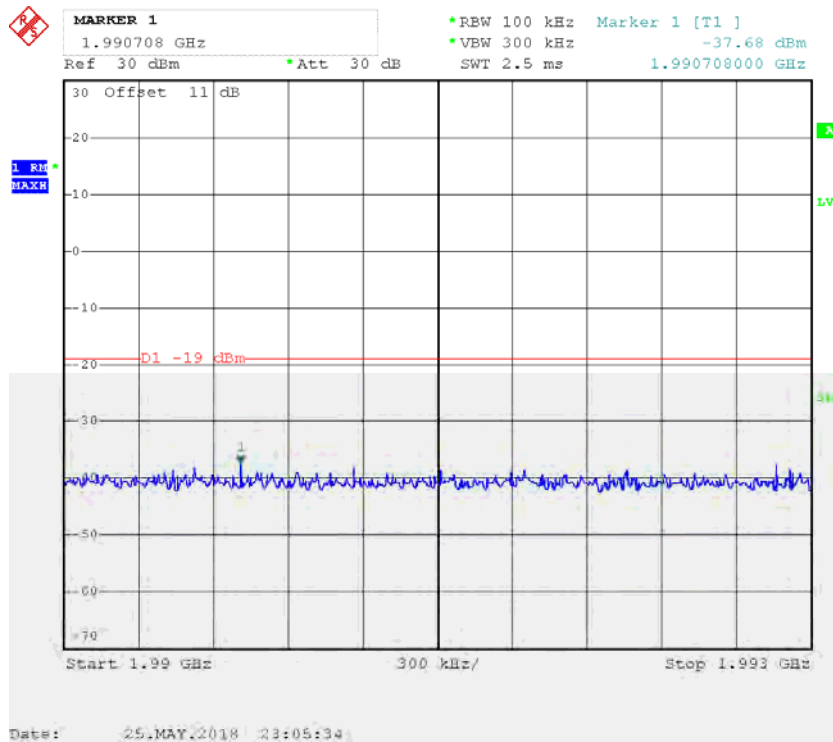

PCS Band GSM Left Side 1930.2MHz Pre-AGC

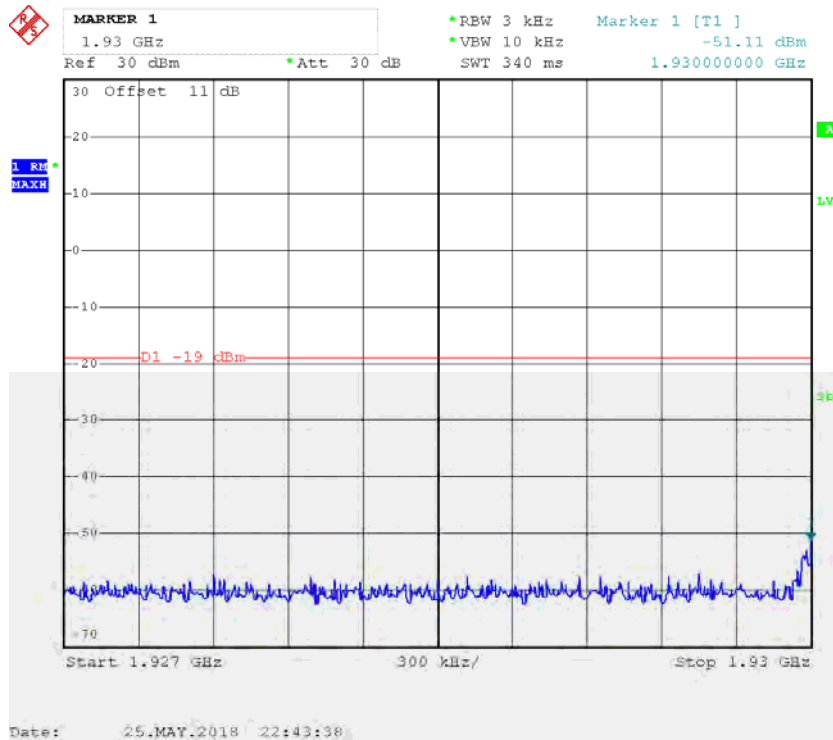

PCS Band GSM Left Side 1930.2MHz Above AGC

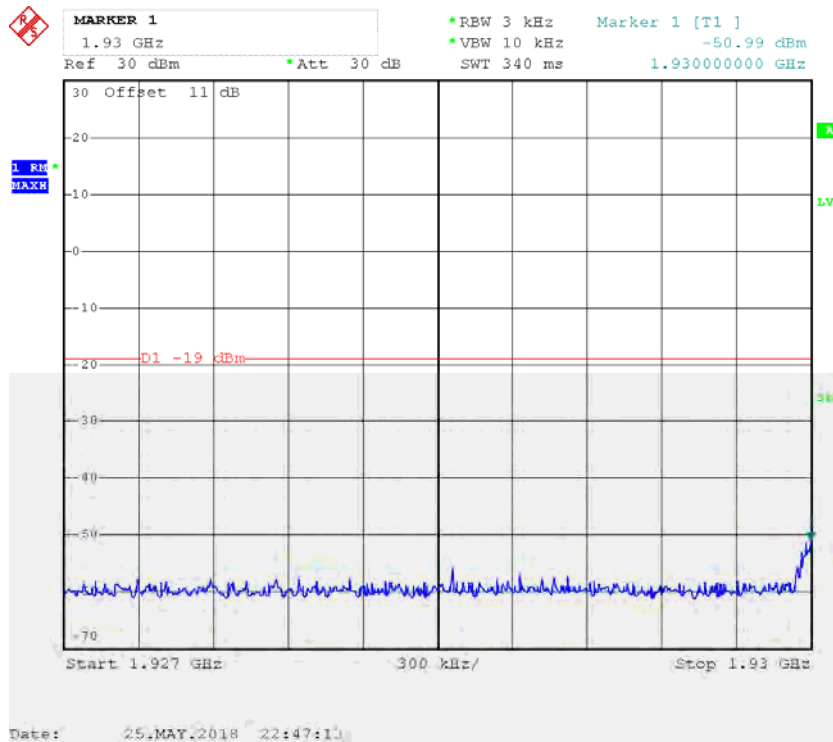

PCS Band GSM Right Side 1989.8MHz Pre-AGC

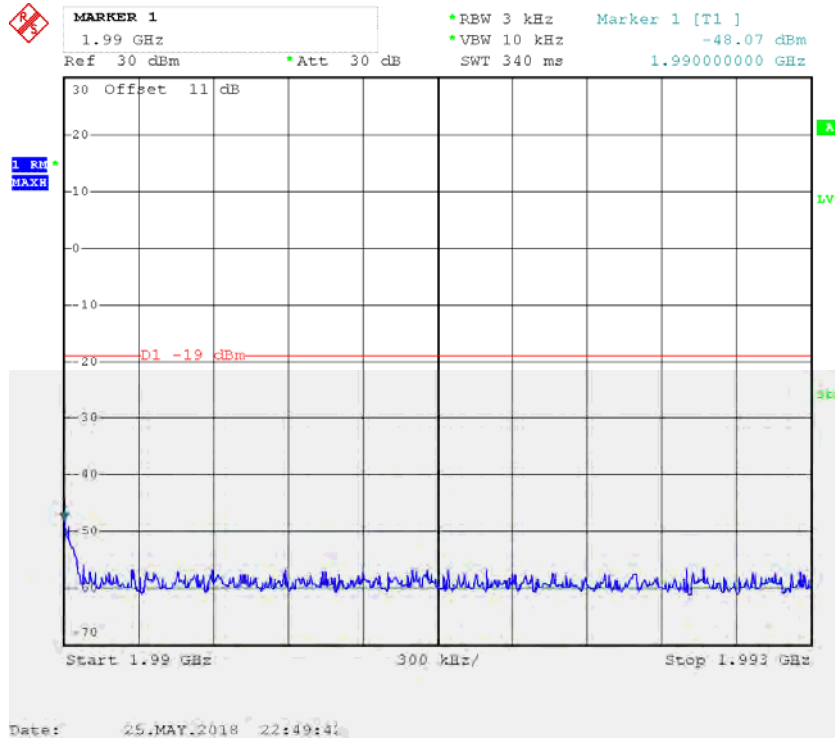

PCS Band GSM Right Side 1989.8MHz Above AGC

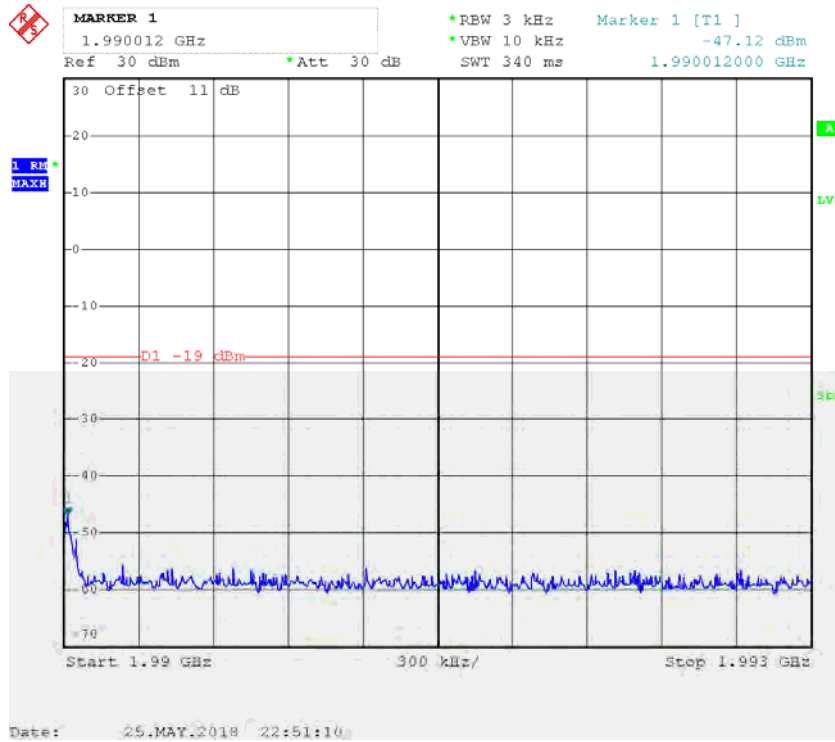

AWS Band CDMA Left Side 2111.25MHz Pre-AGC

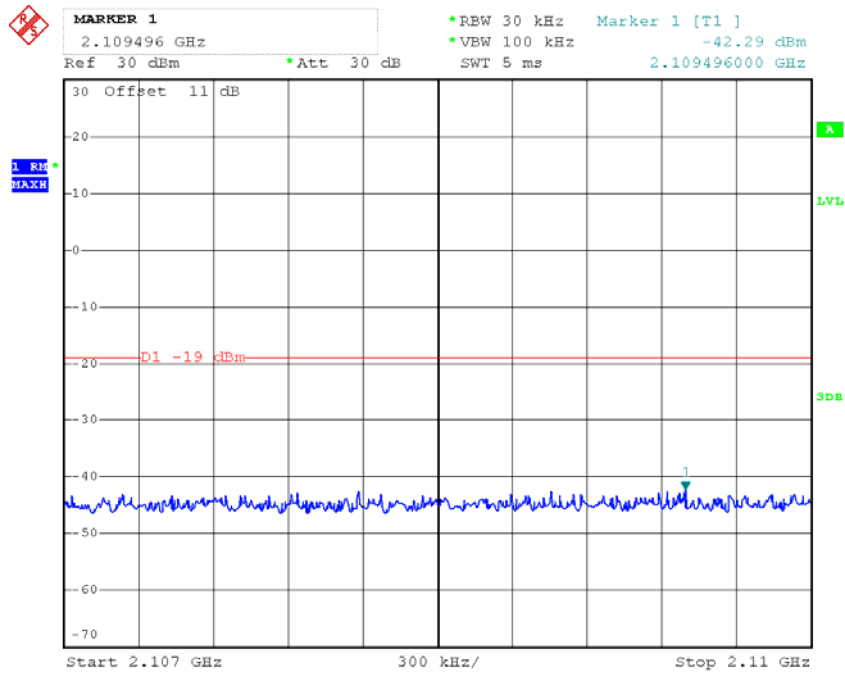

Date: 25.MAY.2018 23:21:03

AWS Band CDMA Left Side 2111.25MHz Above AGC

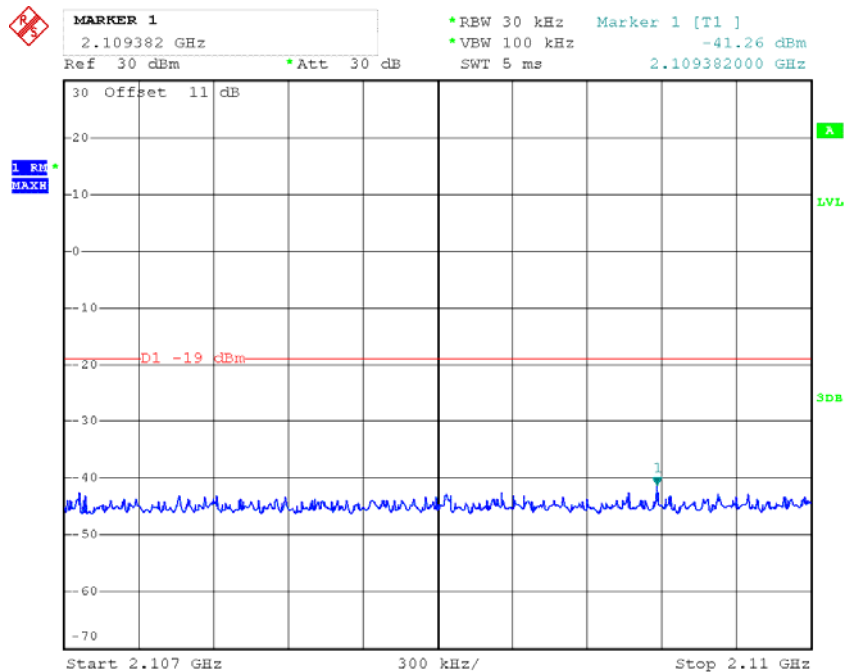

Date: 25.MAY.2018 23:21:54

AWS Band GSM Left Side 2110.2MHz Pre-AGC

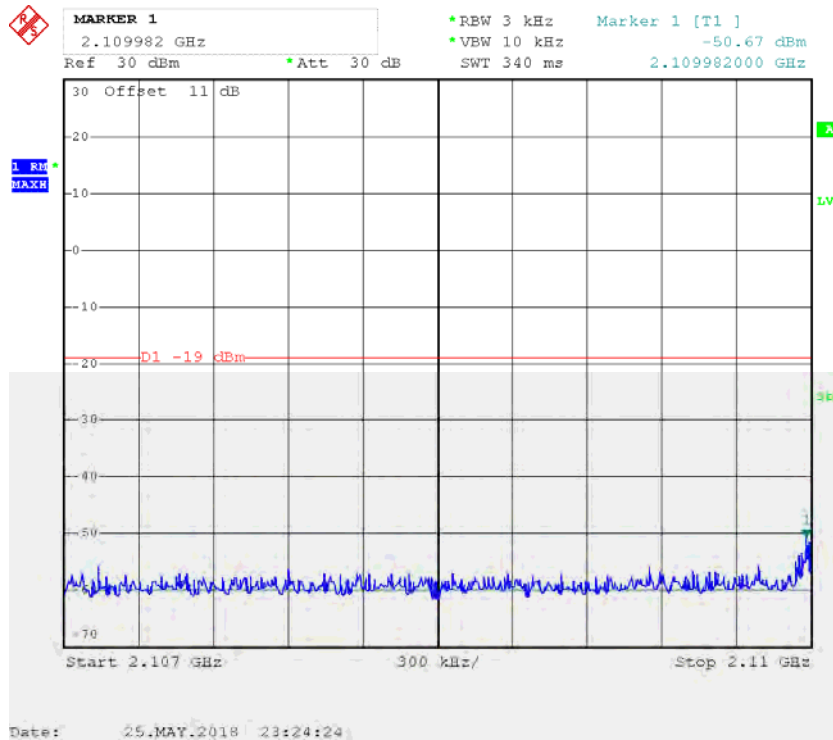

AWS Band GSM Left Side 2110.2MHz Above AGC

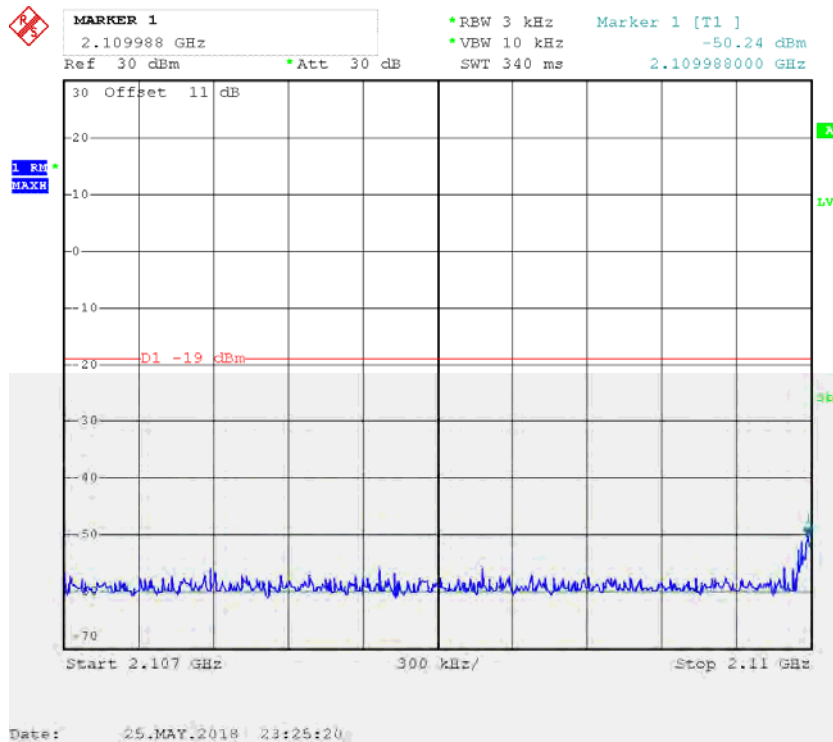

AWS Band LTE Left Side 2112.5MHz Pre-AGC

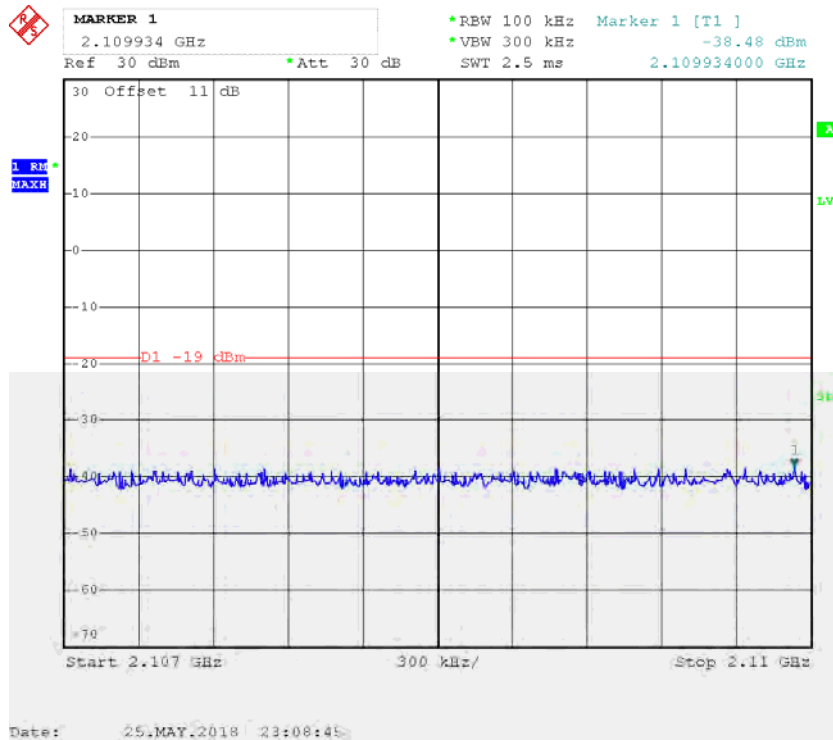

AWS Band LTE Left Side 2112.5MHz Above AGC

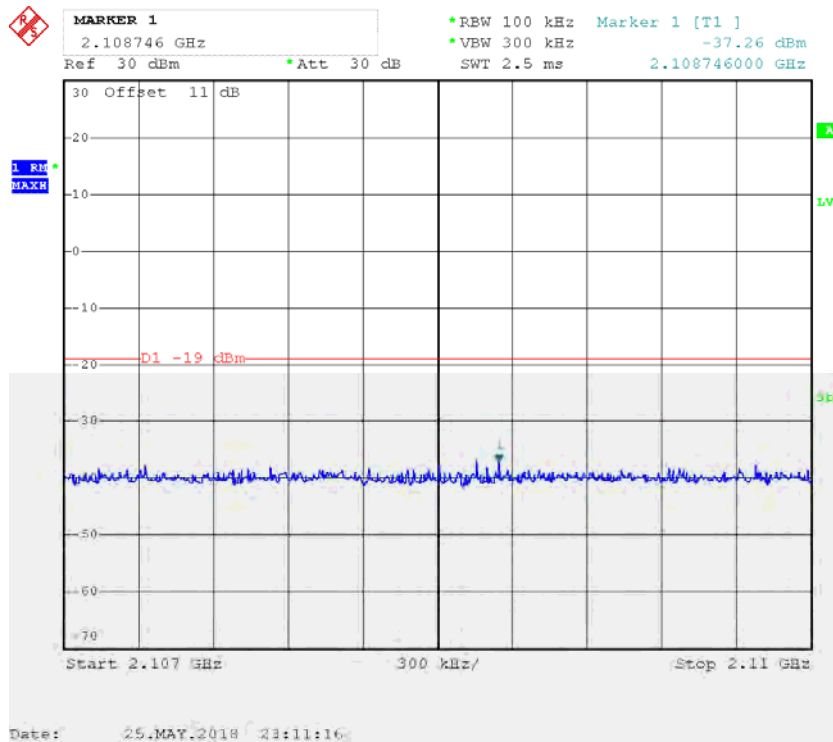

AWS Band CDMA Right Side 2153.75MHz Pre-AGC

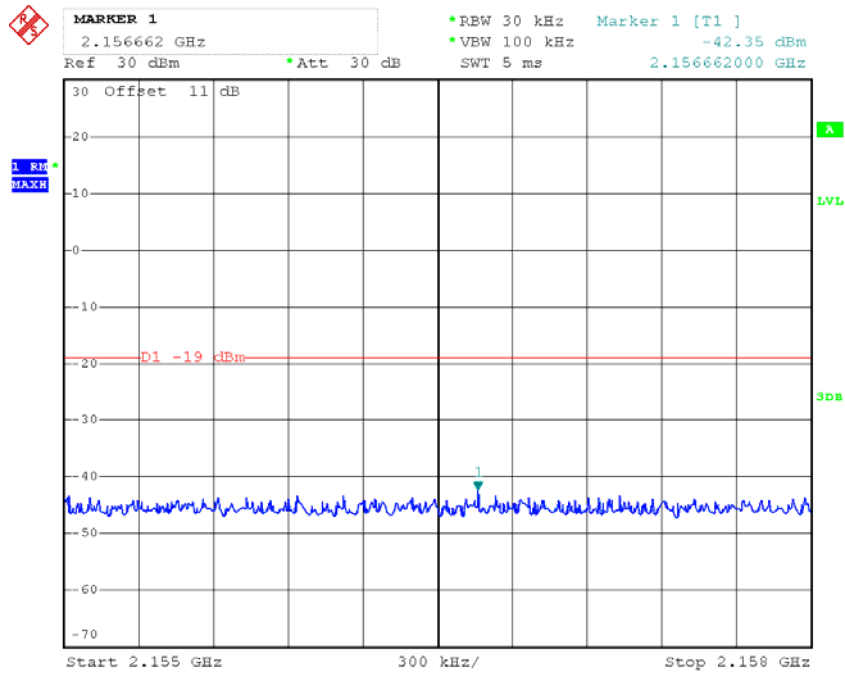

Date: 25.MAY.2018 23:15:57

AWS Band CDMA Right Side 2153.75MHz Above AGC

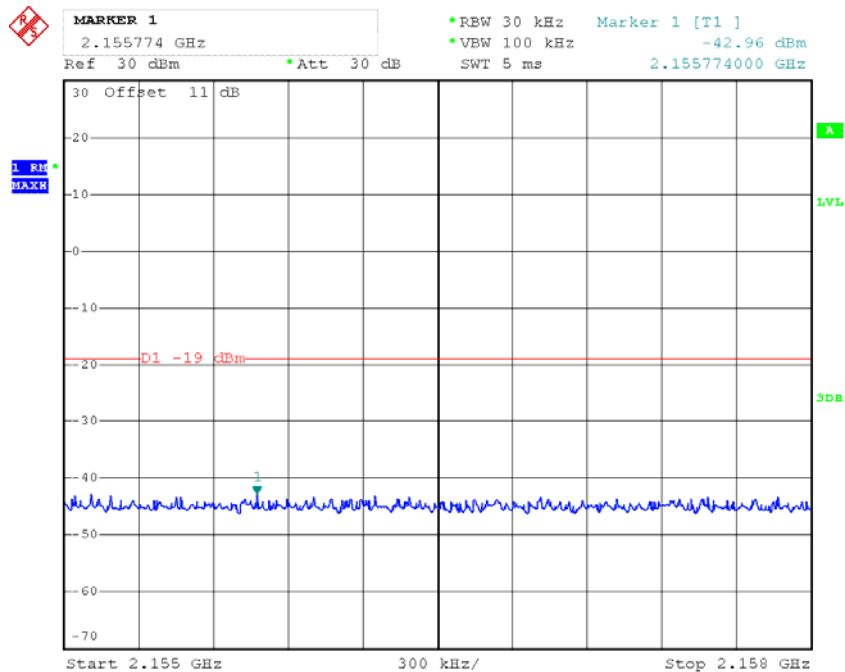

Date: 25.MAY.2018 23:17:43

AWS Band GSM Right Side 2154.8MHz Pre-AGC

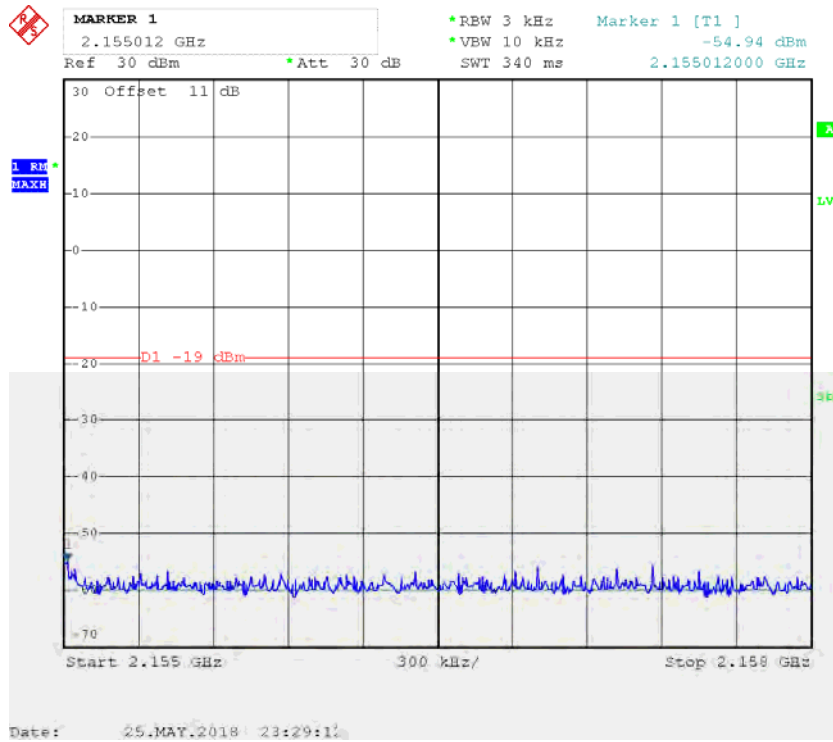

AWS Band GSM Right Side 2154.8MHz Above AGC

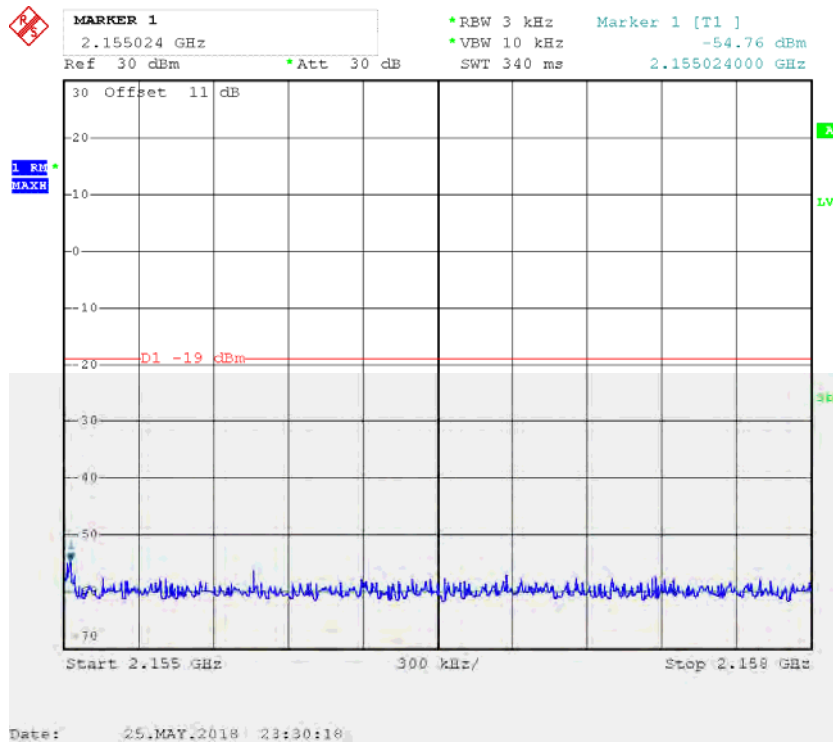

AWS Band LTE Right Side 2152.5MHz Pre-AGC

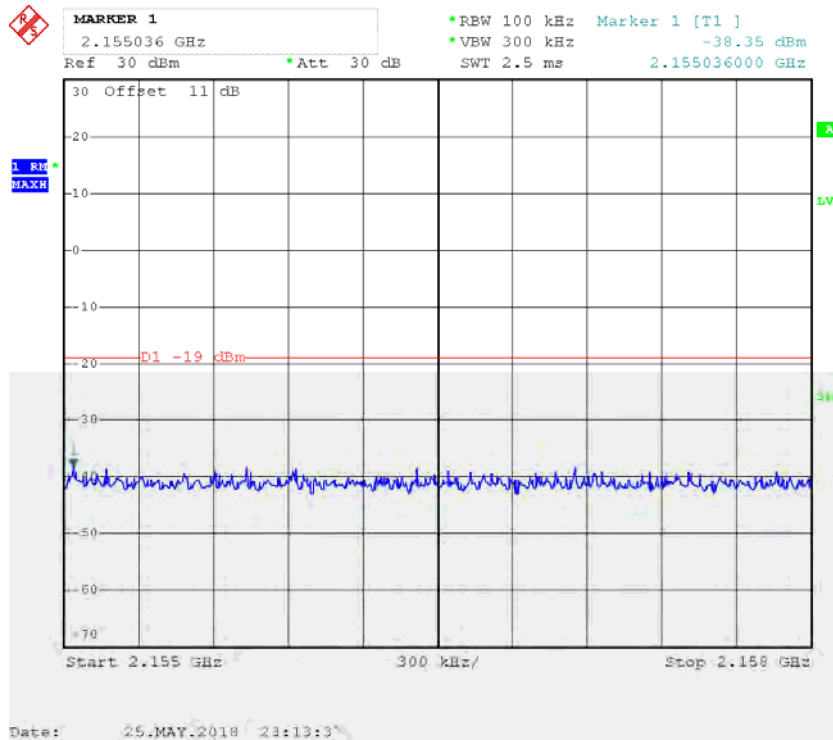

AWS Band LTE Right Side 2152.5MHz Above AGC

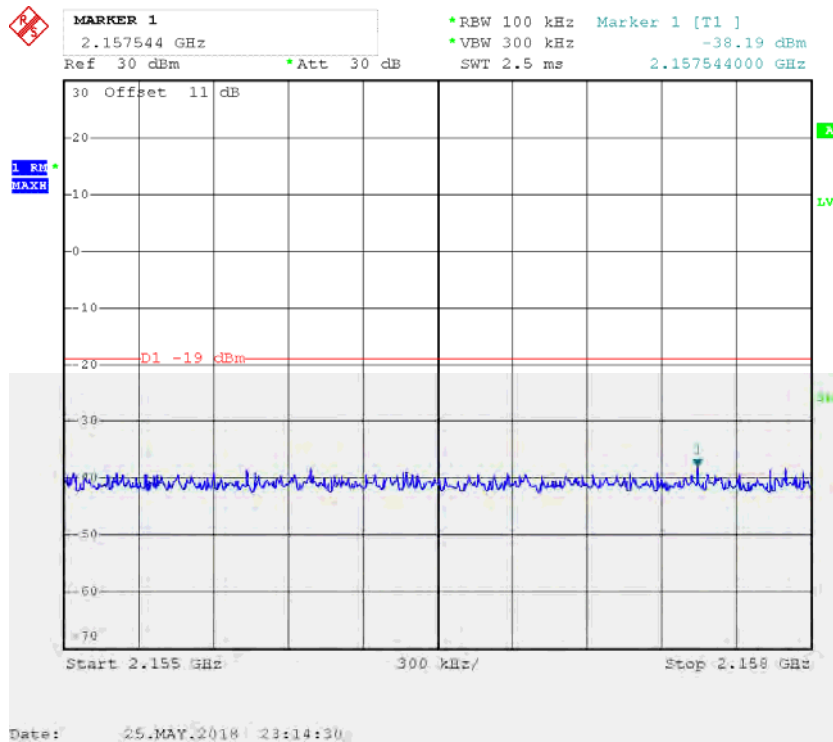

Cellular Band CDMA Left Side 869.88 MHz Pre-AGC

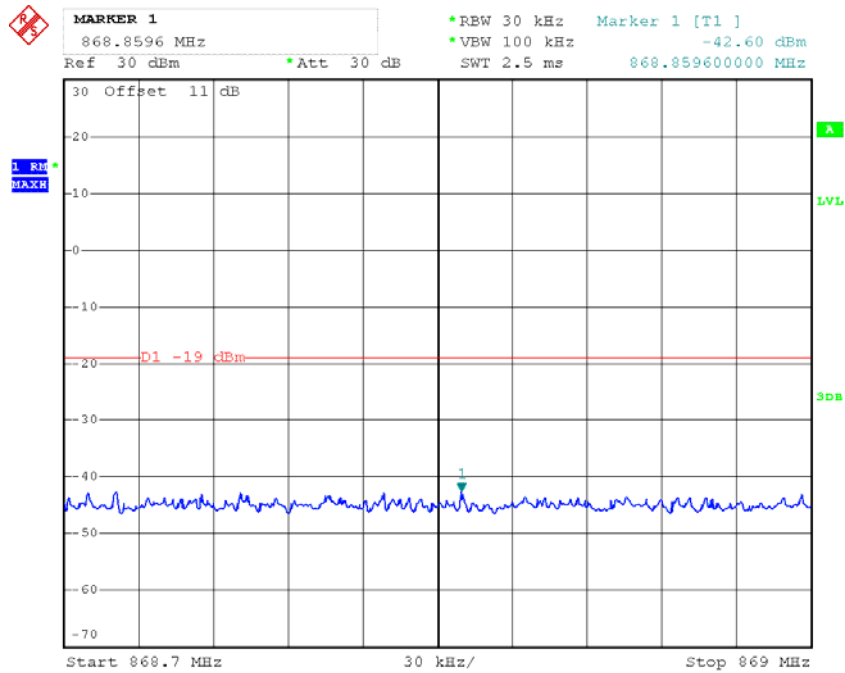

Date: 25.MAY.2018 22:23:27

Cellular Band CDMA Left Side 869.88 MHz Above AGC

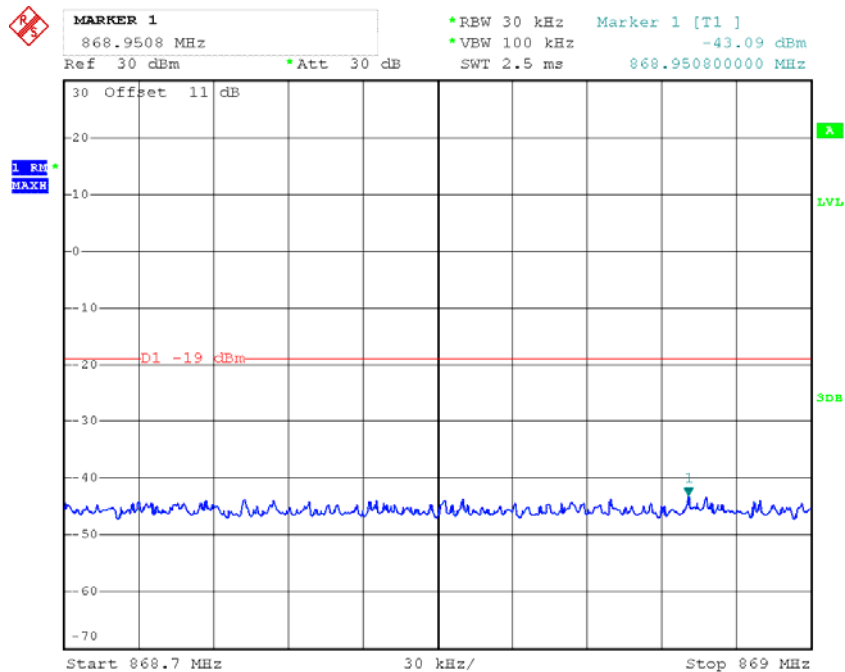

Date: 25.MAY.2018 22:25:01

Cellular Band GSM Left Side 869.2MHz Pre-AGC

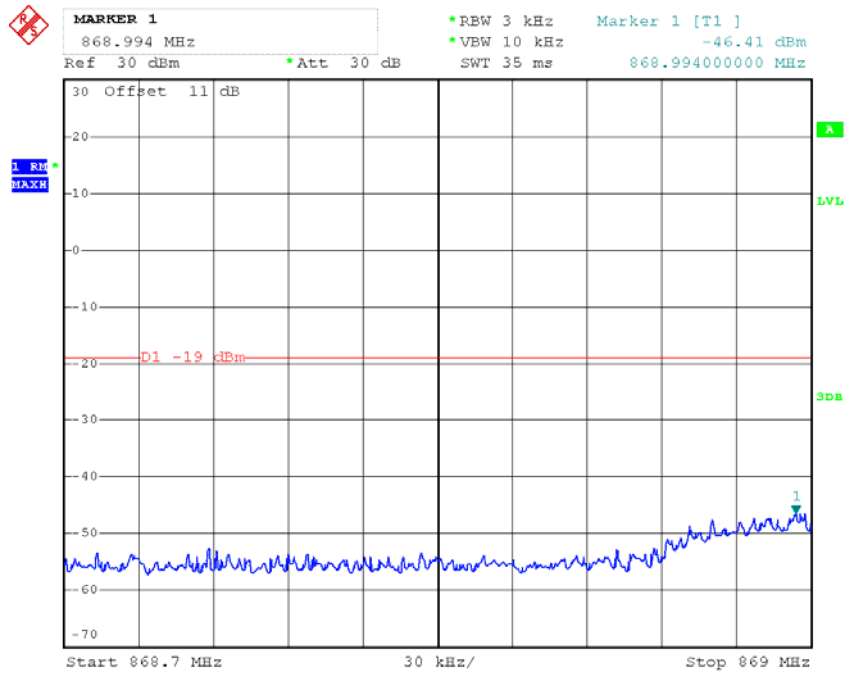

Date: 25.MAY.2018 22:34:40

Cellular Band GSM Left Side 869.2MHz Above AGC

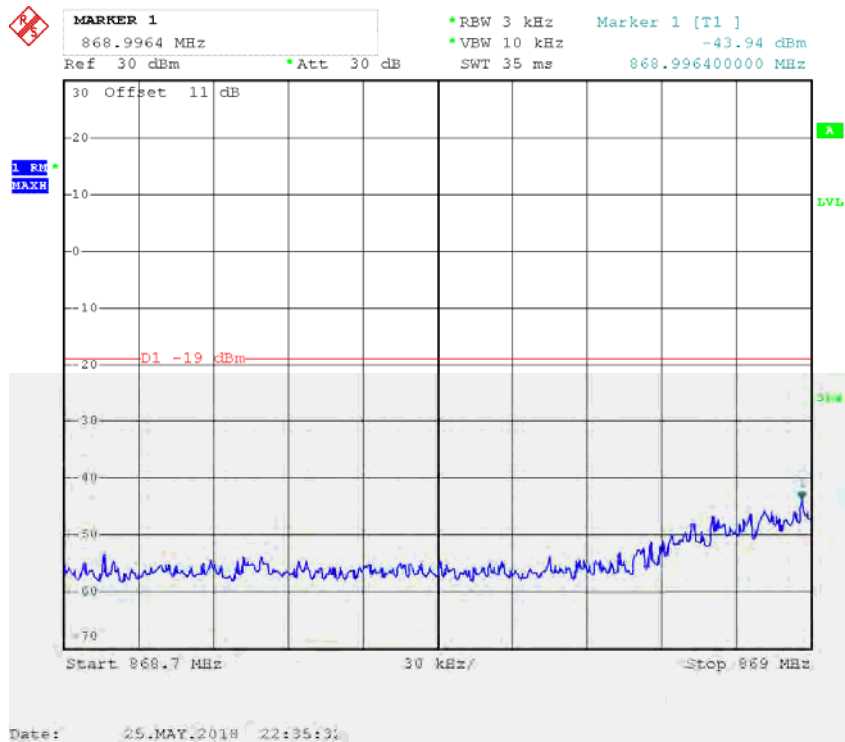

Date: 25.MAY.2018 22:35:31

Cellular Band LTE Left Side 871.5MHz Pre-AGC

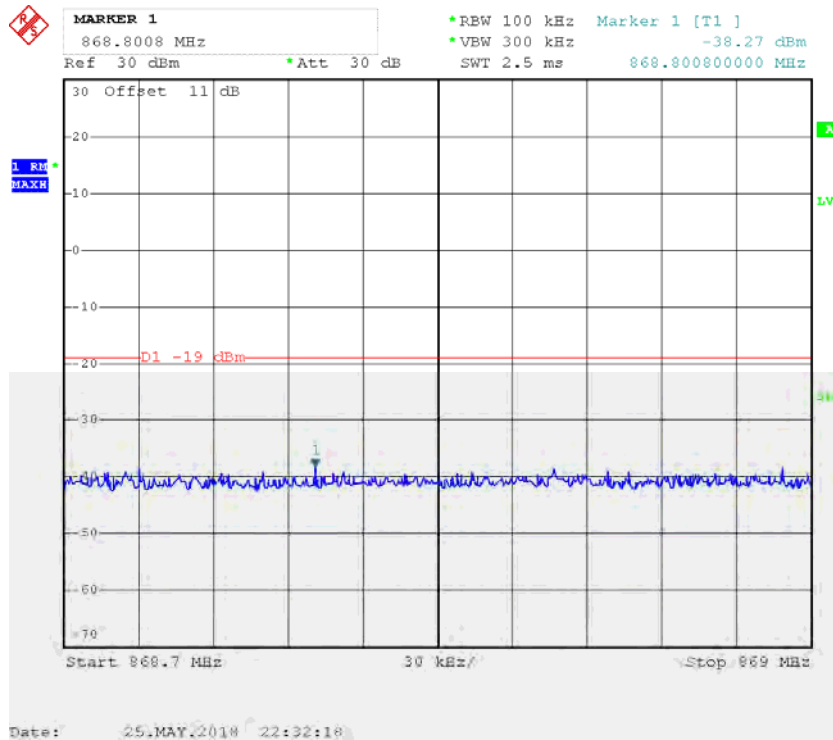

Cellular Band LTE Left Side 871.5MHz Above AGC

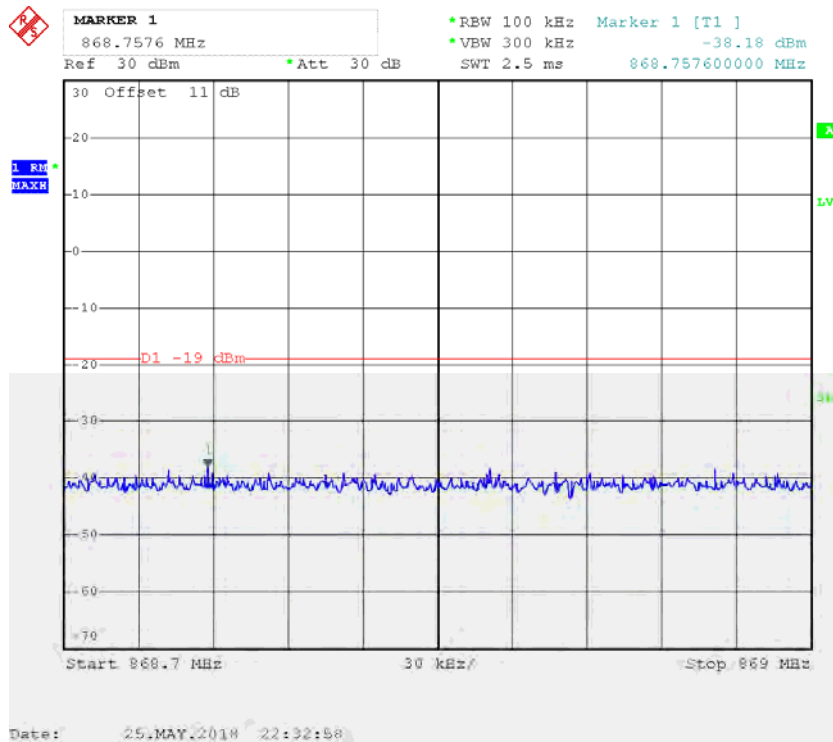

Cellular Band CDMA Right Side 893.1MHz Pre-AGC

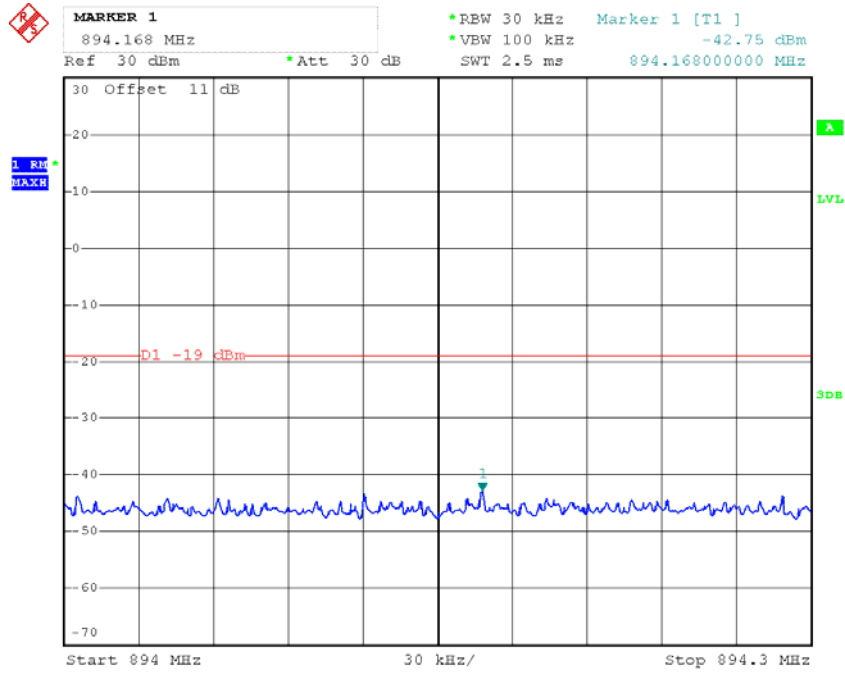

Date: 25.MAY.2018 22:26:40

Cellular Band CDMA Right Side 893.1MHz Above AGC

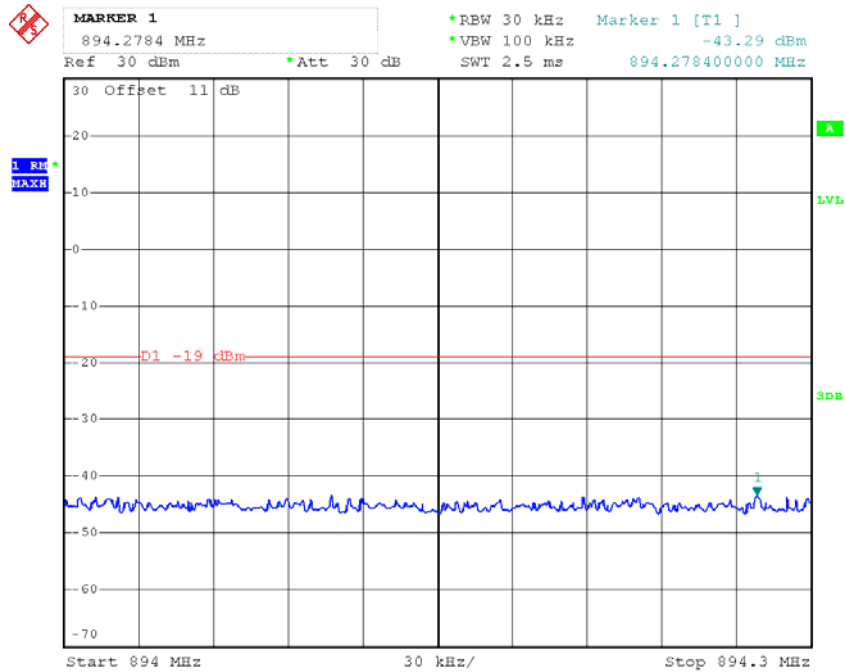

Date: 25.MAY.2018 22:27:38

Cellular Band GSM Right Side 893.8MHz Pre-AGC

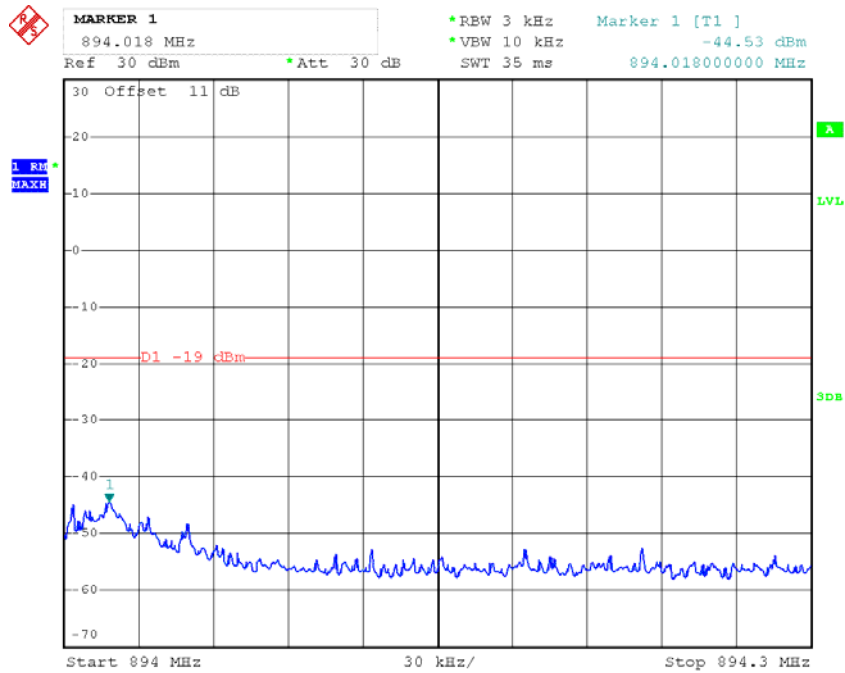

Date: 25.MAY.2018 22:37:34

Cellular Band GSM Right Side 893.8MHz Above AGC

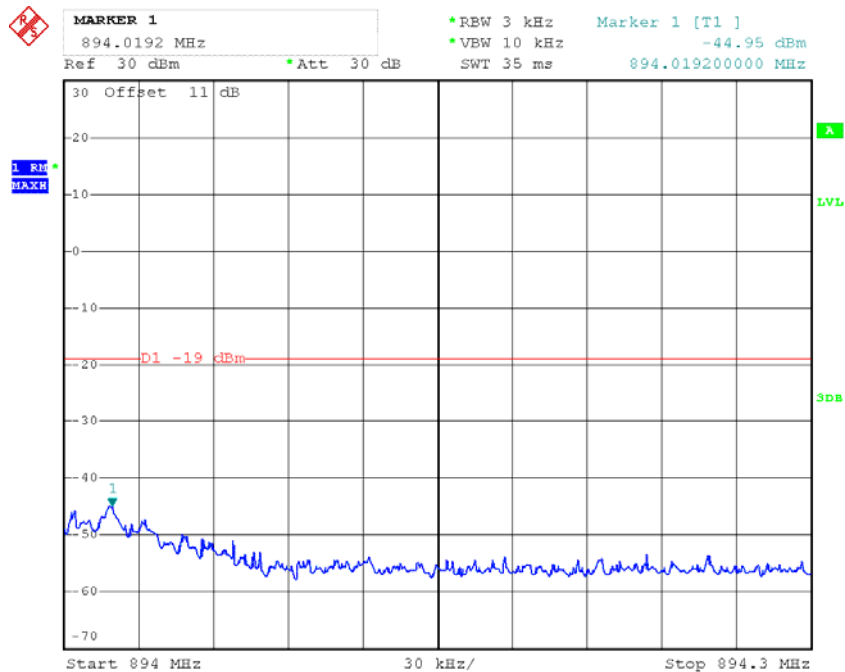

Date: 25.MAY.2018 22:38:35

Cellular Band LTE Right Side 891.5MHz Pre-AGC

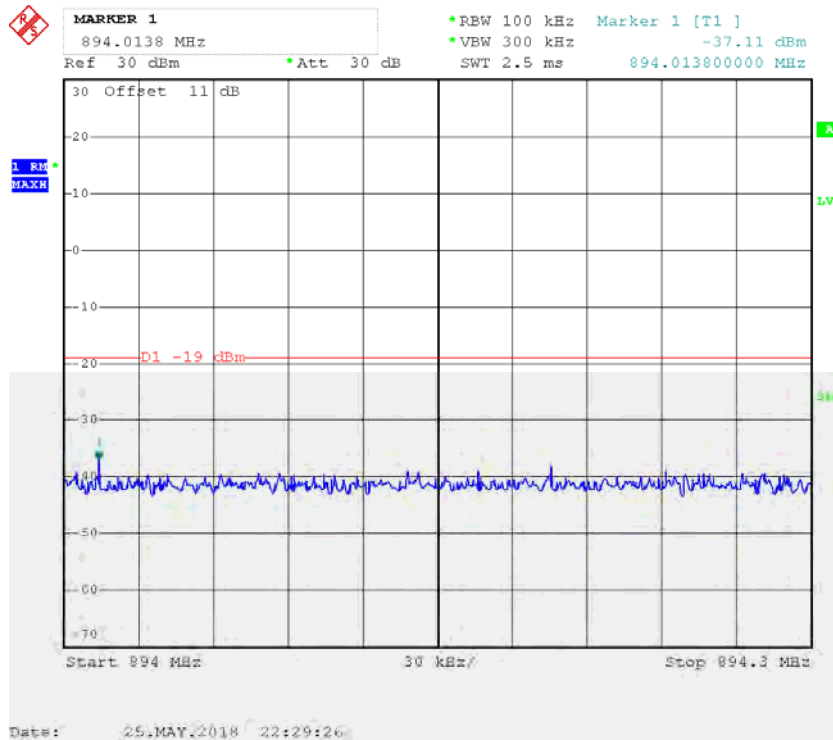

Cellular Band LTE Right Side 891.5MHz Above AGC

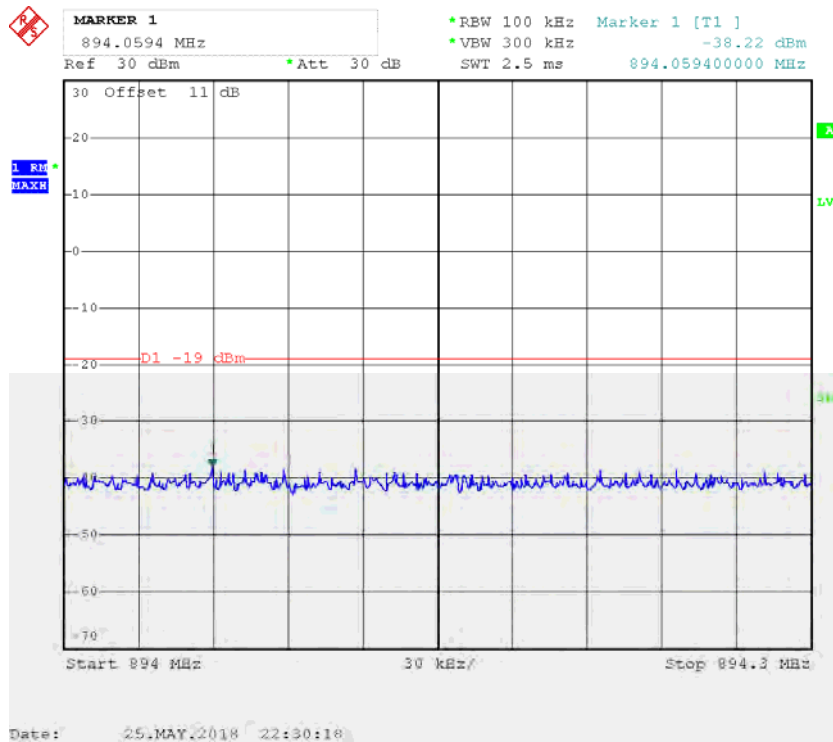

Upper 700MHz Band CDMA Left Side 747.25MHz Pre-AGC

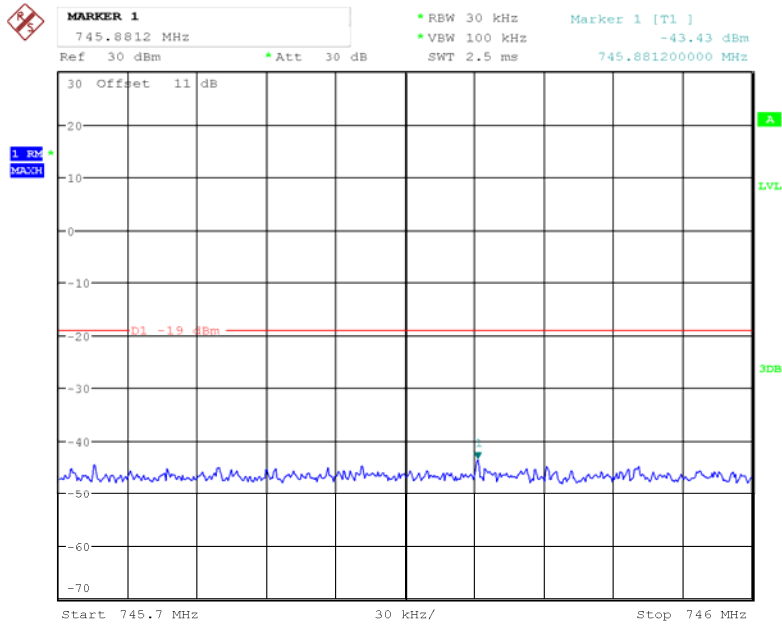

Date: 6.JUN.2018 17:58:50

Upper 700MHz Band CDMA Left Side 747.25MHz Above AGC

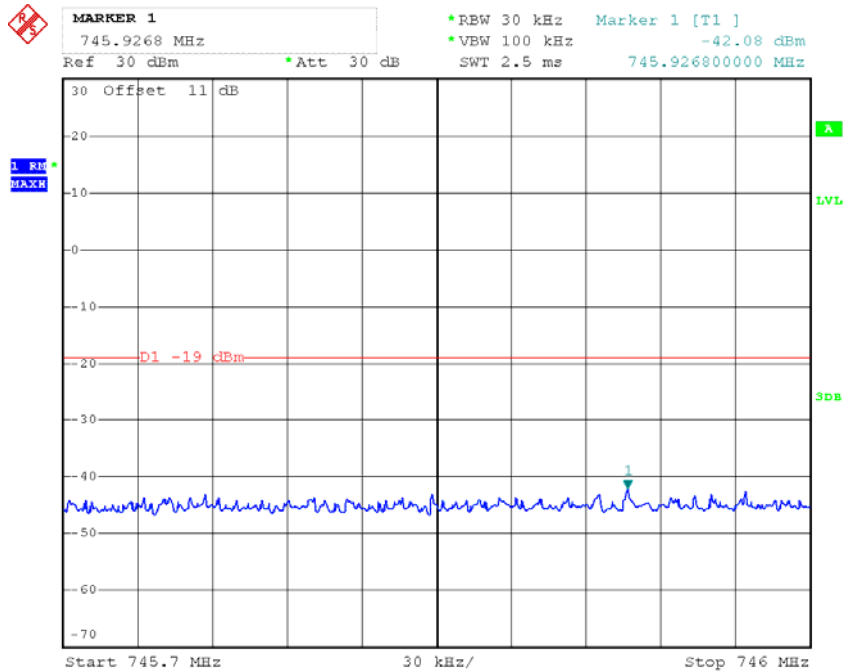

Date: 26.MAY.2018 00:20:51

Upper 700MHz Band GSM Left Side 746.2MHz Pre-AGC

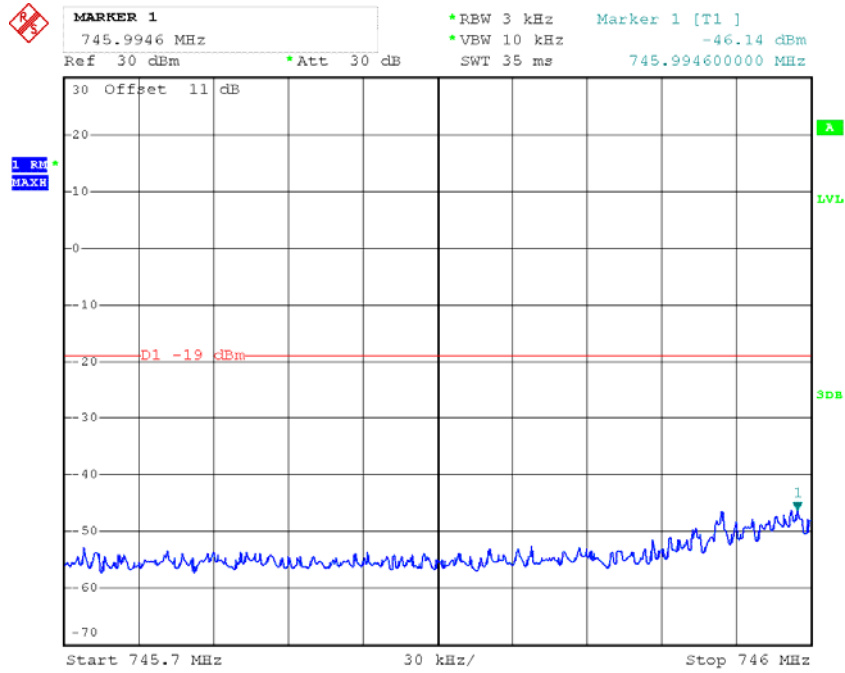

Date: 26.MAY.2018 00:25:01

Upper 700MHz Band GSM Left Side 746.2MHz Above AGC

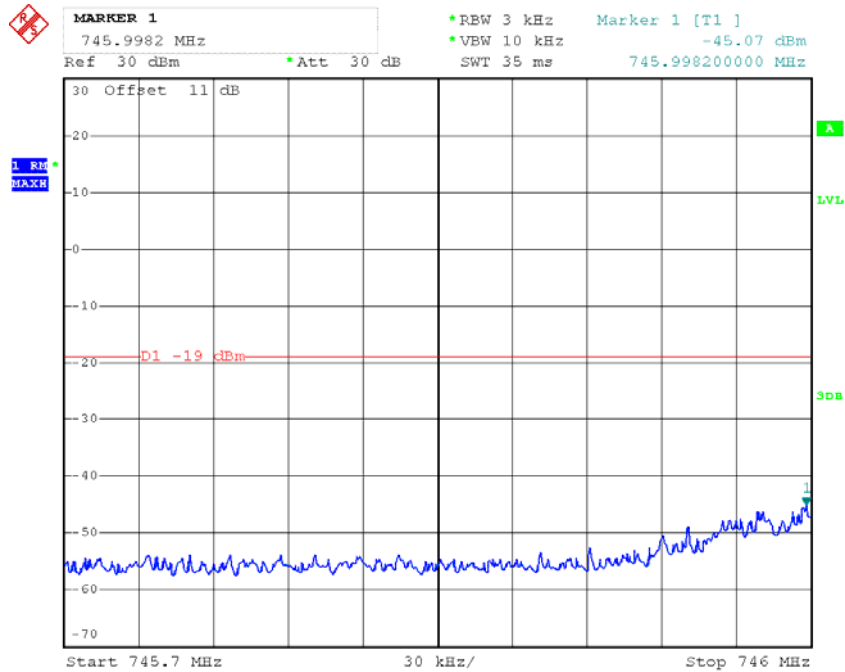

Date: 26.MAY.2018 00:25:54

Upper 700MHz Band LTE Left Side 748.5MHz Pre-AGC

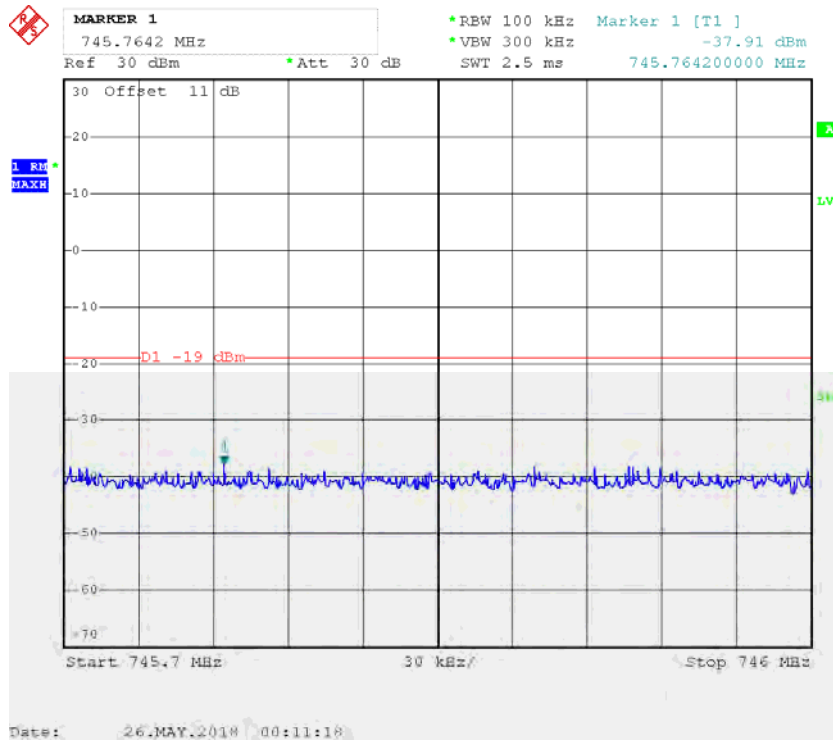

Upper 700MHz Band LTE Left Side 748.5MHz Above AGC

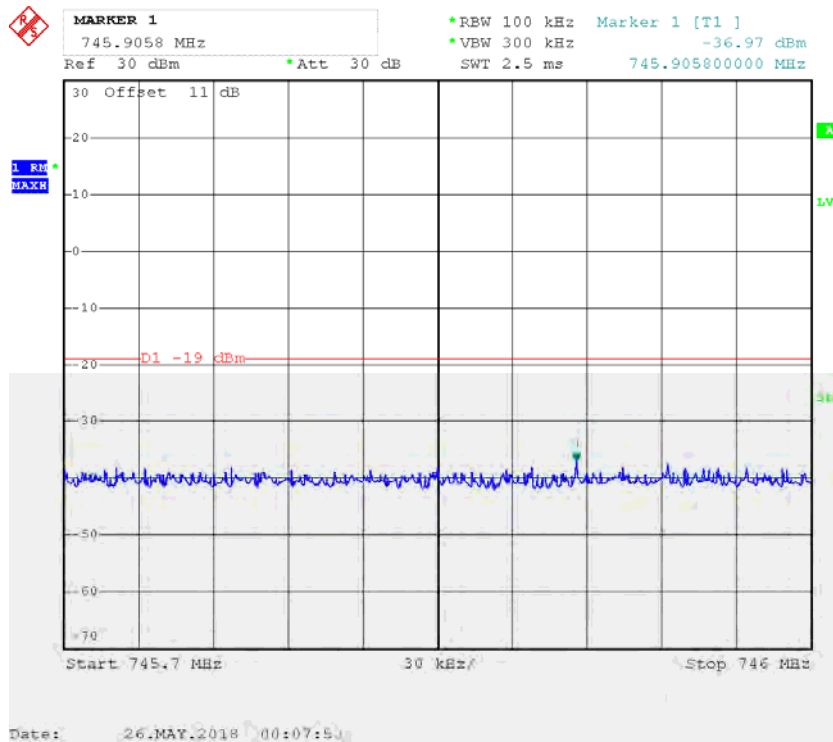

Upper 700MHz Band CDMA Right Side 755.75MHz Pre-AGC

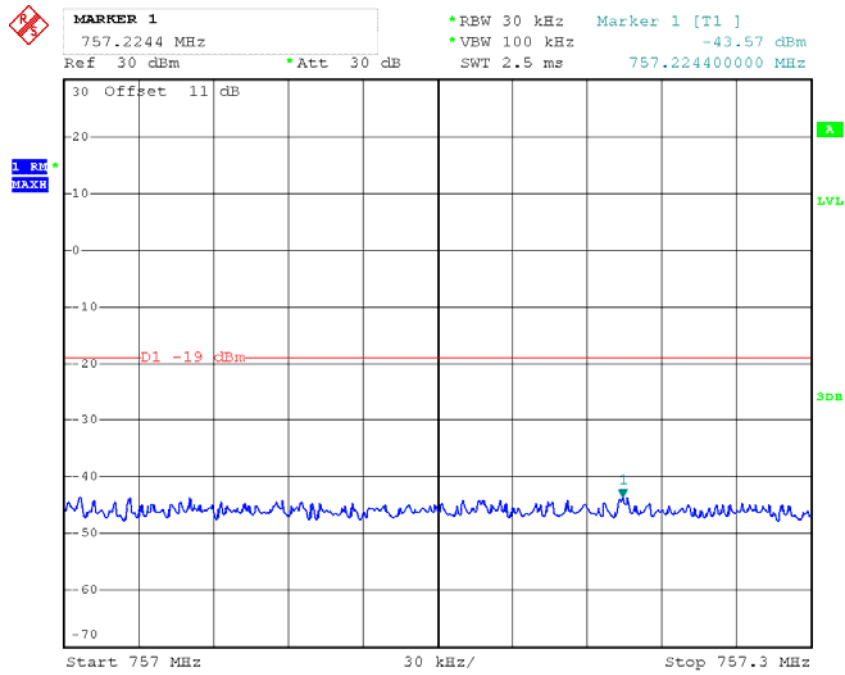

Date: 26.MAY.2018 00:16:43

Upper 700MHz Band CDMA Right Side 755.75MHz Above AGC

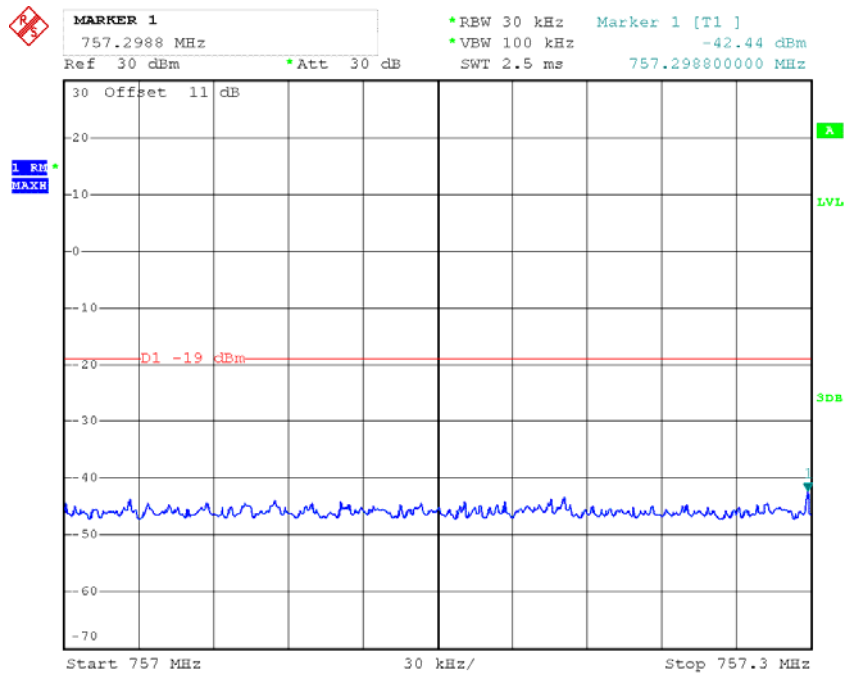

Date: 26.MAY.2018 00:17:46

Upper 700MHz Band GSM Right Side 756.8MHz Pre-AGC

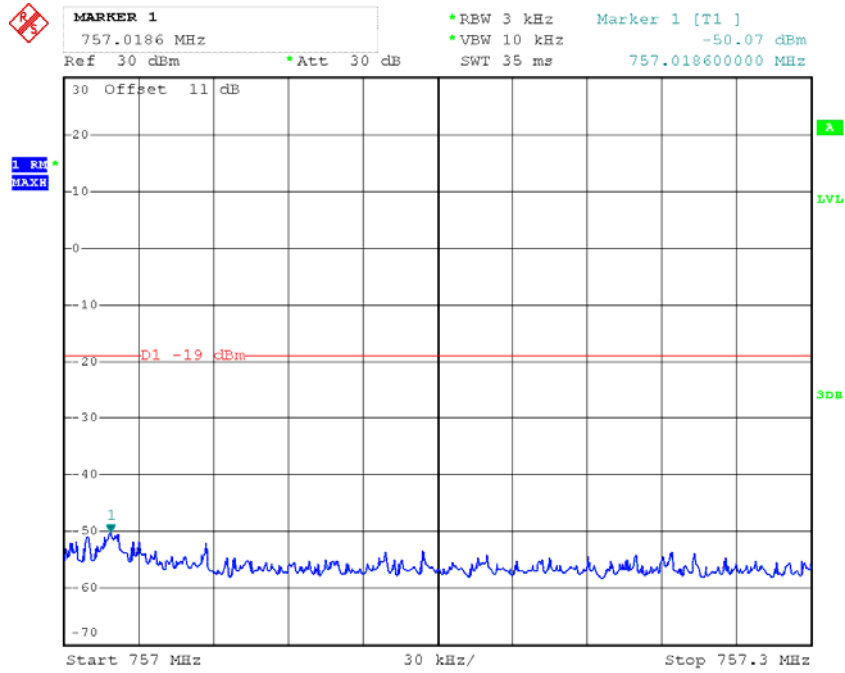

Date: 26.MAY.2018 00:28:05

Upper 700MHz Band GSM Right Side 756.8MHz Above AGC

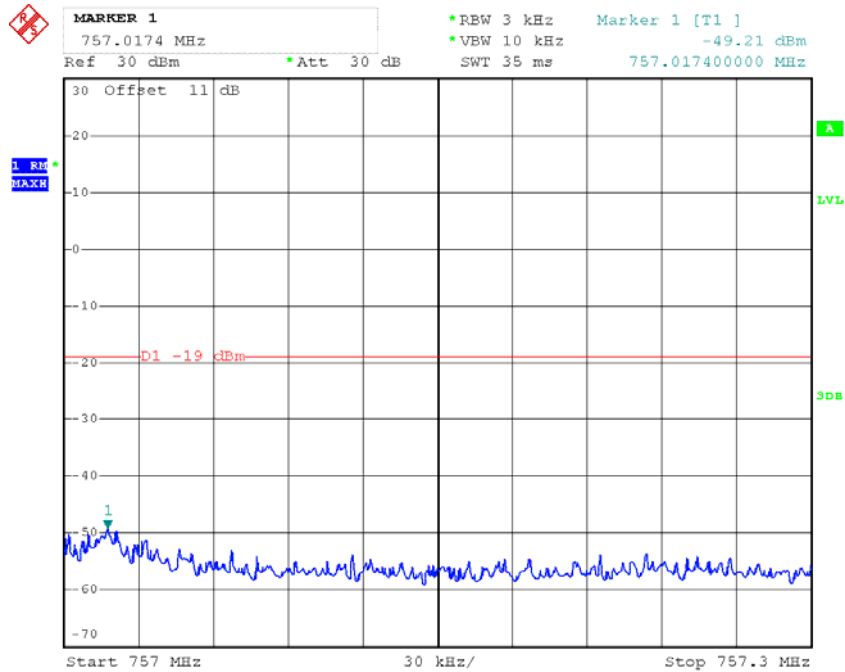

Date: 26.MAY.2018 00:28:45

Upper 700MHz Band LTE Right Side 754.5MHz Pre-AGC

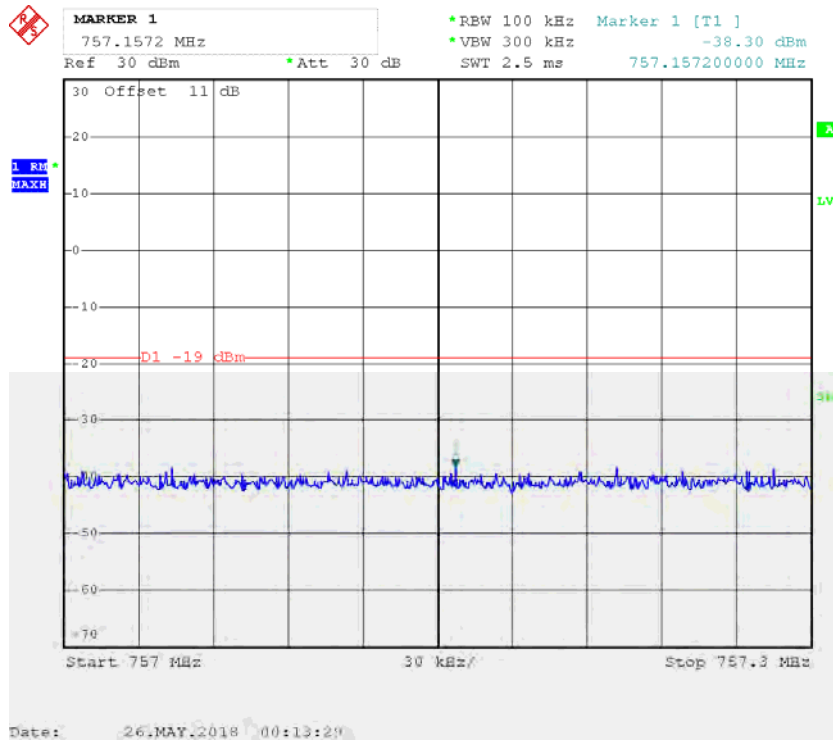

Upper 700MHz Band LTE Right Side 754.5MHz Above AGC

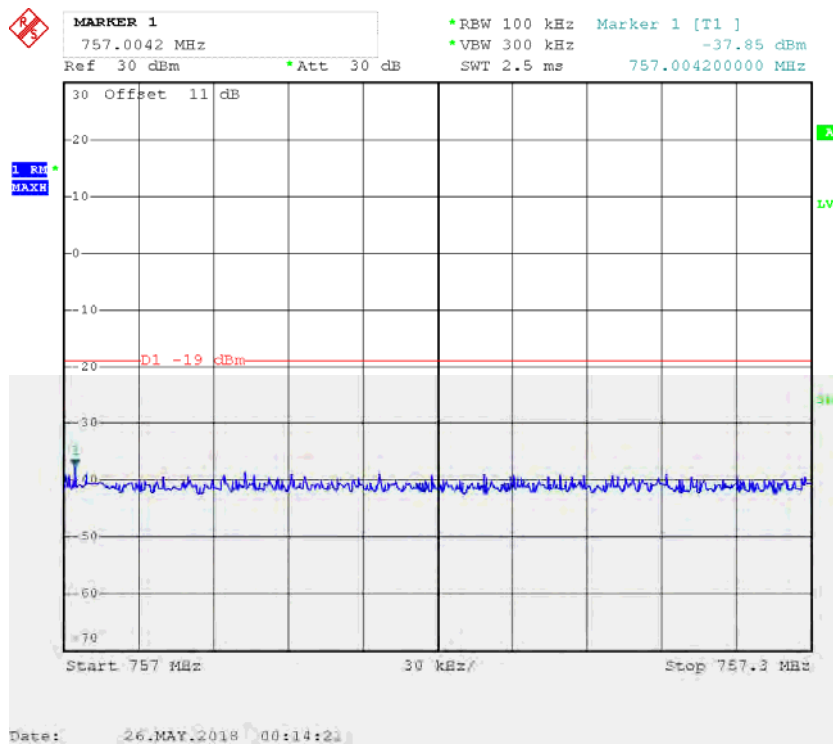

Lower 700MHz Band CDMA Left Side 729.25MHz Pre-AGC

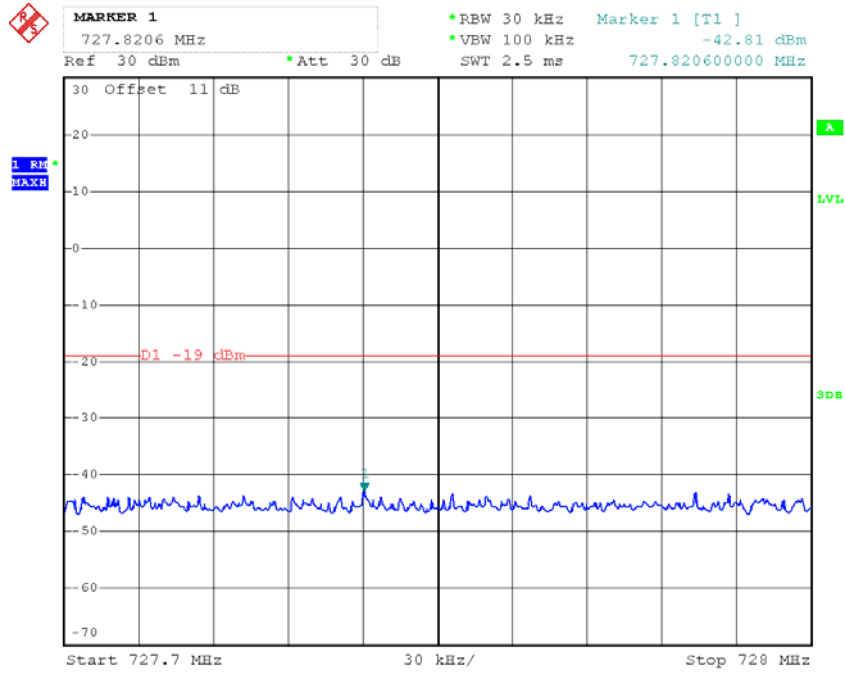

Date: 25.MAY.2018 23:55:54

Lower 700MHz Band CDMA Left Side 729.25MHz Above AGC

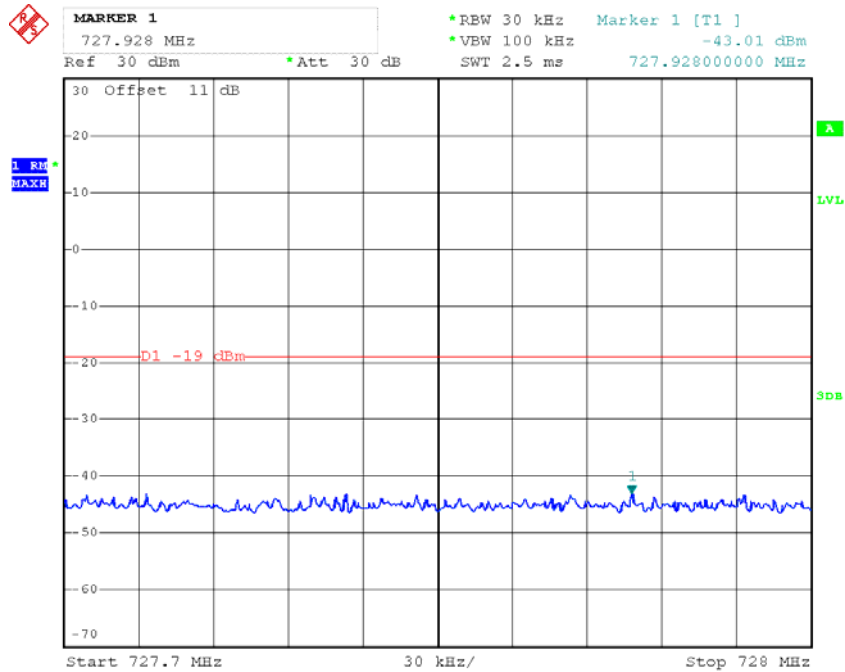

Date: 25.MAY.2018 23:57:09

Lower 700MHz Band GSM Left Side 728.2MHz Pre-AGC

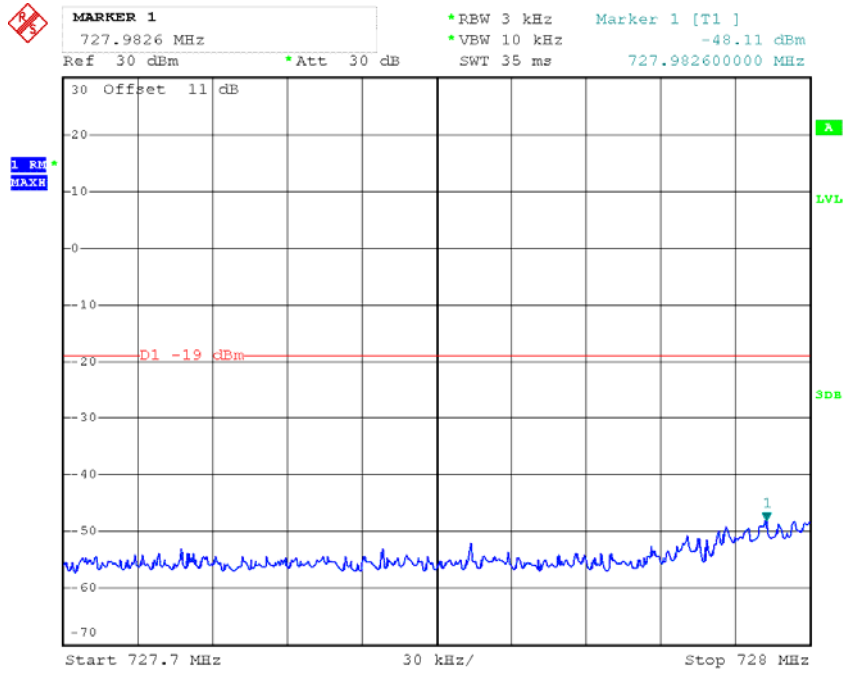

Date: 25.MAY.2018 23:45:44

Lower 700MHz Band GSM Left Side 728.2MHz Above AGC

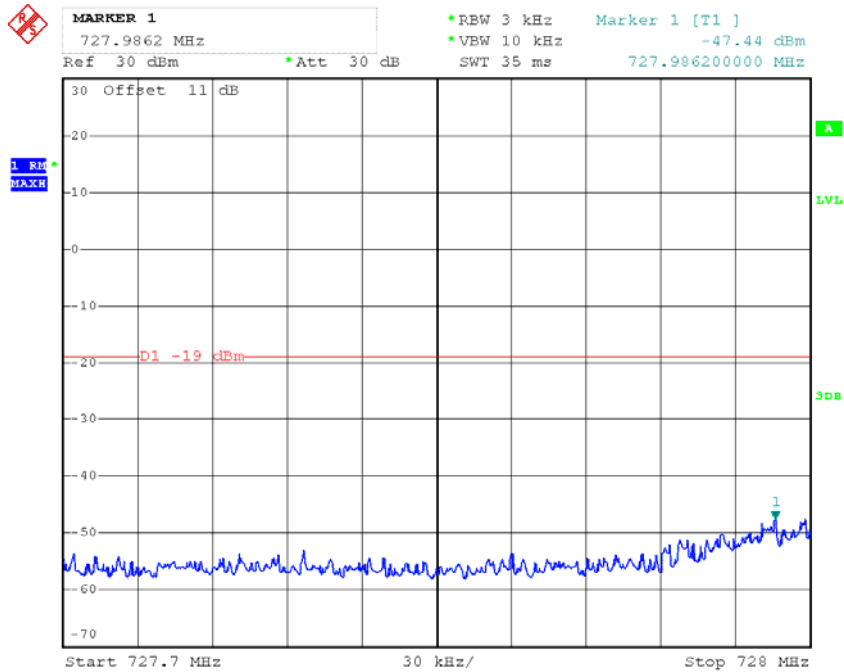

Date: 25.MAY.2018 23:46:36

Lower 700MHz Band LTE Left Side 730.5MHz Pre-AGC

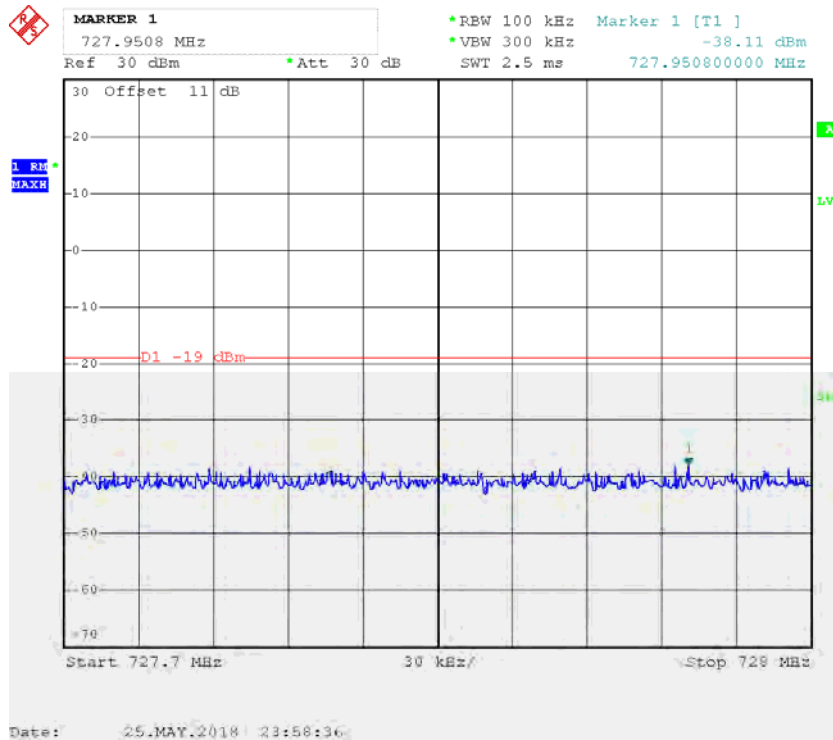

Lower 700MHz Band LTE Left Side 730.5MHz Above AGC

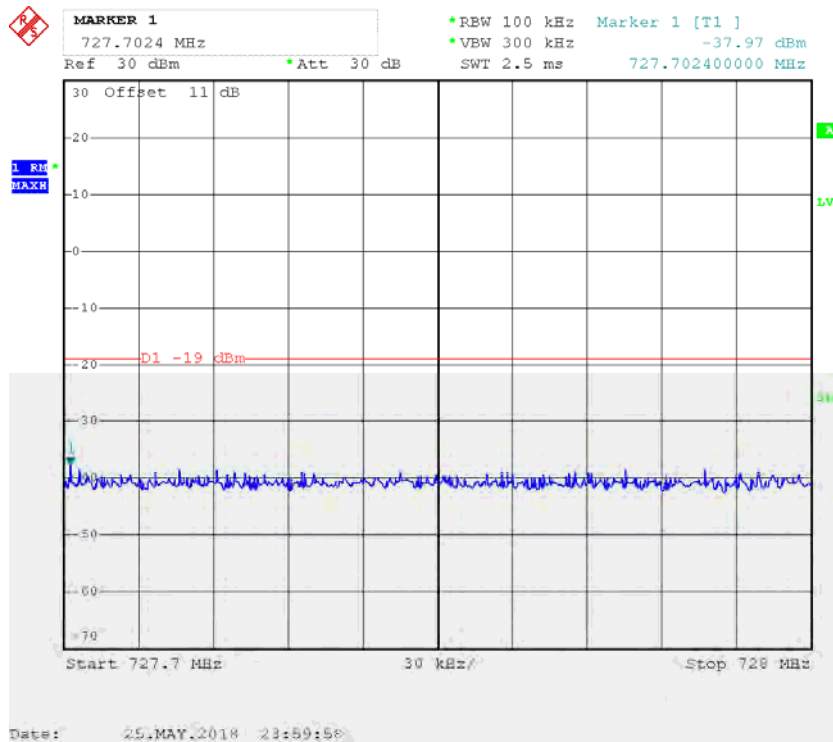

Lower 700MHz Band CDMA Right Side 744.75MHz Pre-AGC

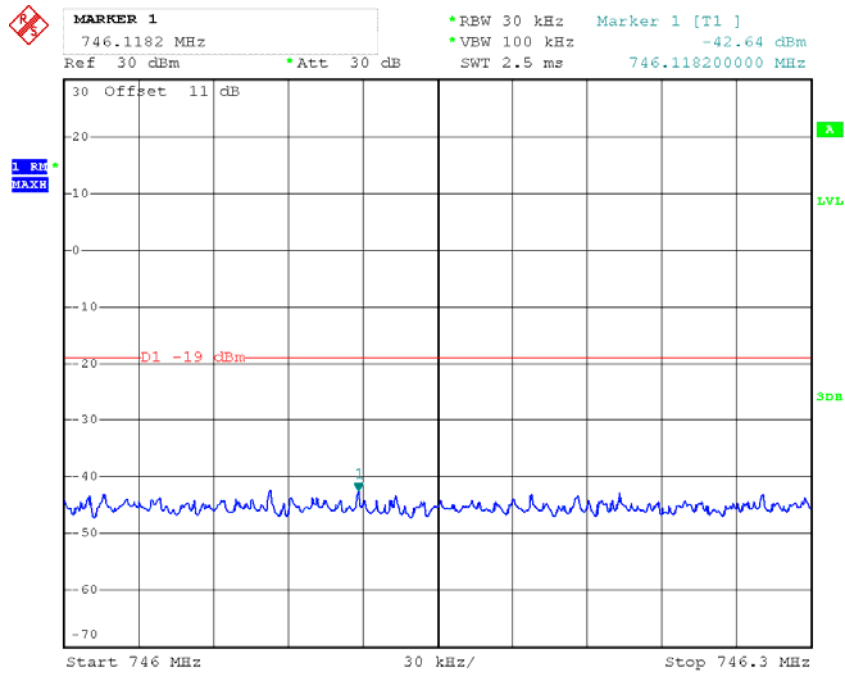

Date: 25.MAY.2018 23:52:09

Lower 700MHz Band CDMA Right Side 744.75MHz Above AGC

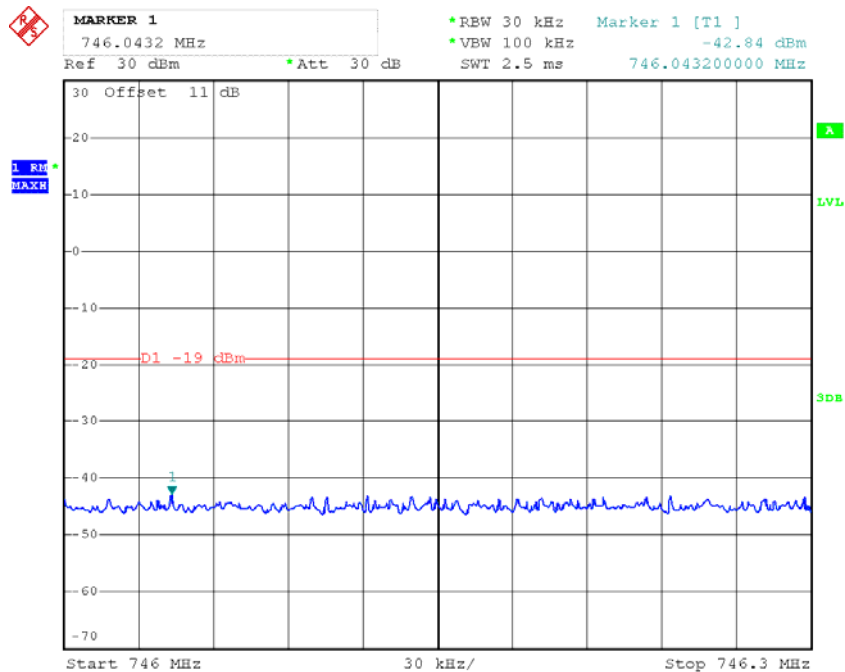

Date: 25.MAY.2018 23:54:26

Lower 700MHz Band GSM Right Side 745.8MHz Pre-AGC

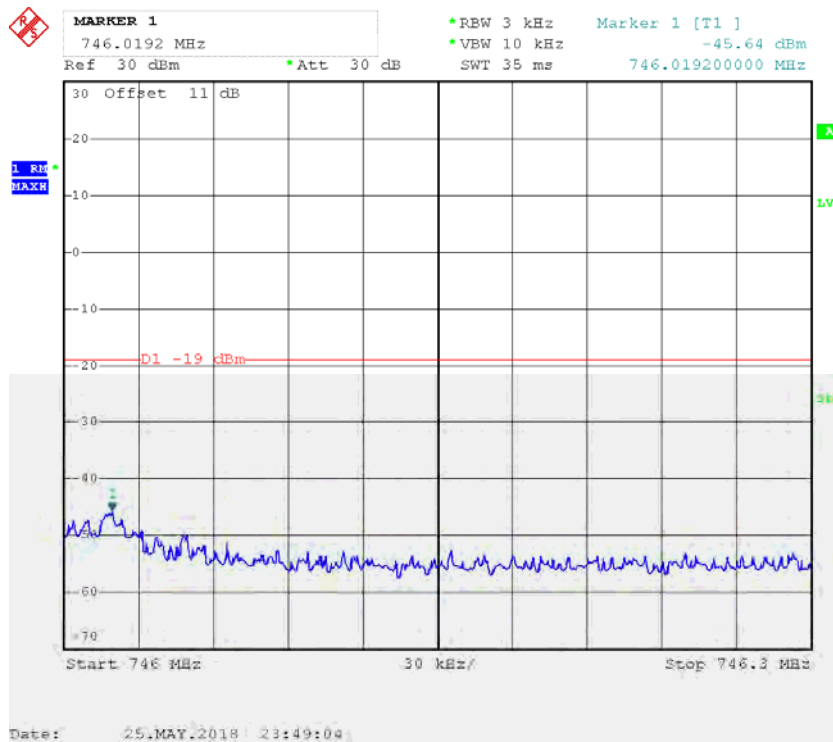

Lower 700MHz Band GSM Right Side 745.8MHz Above AGC

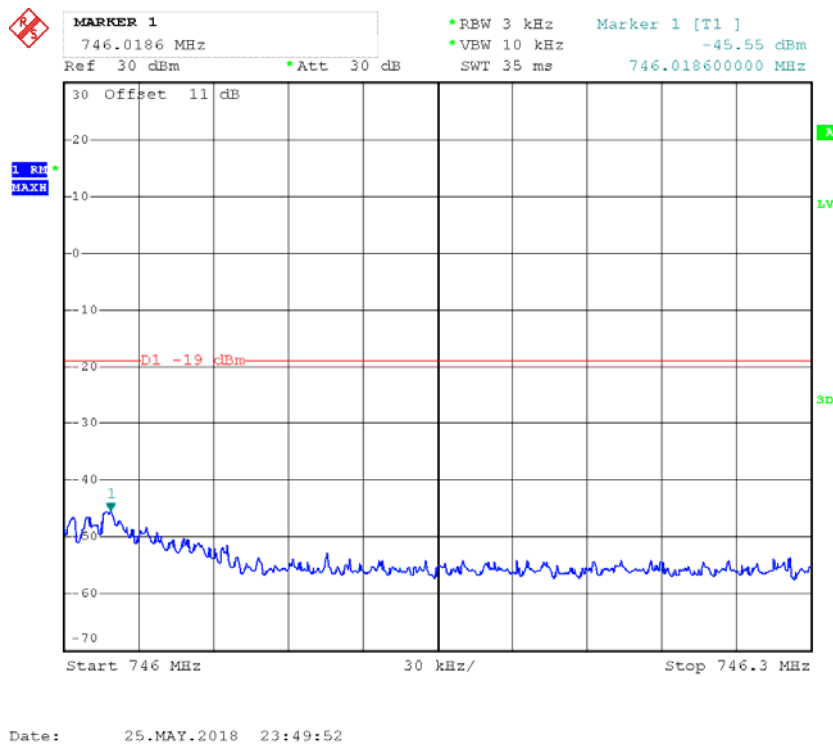

Lower 700MHz Band LTE Right Side 743.5MHz Pre-AGC

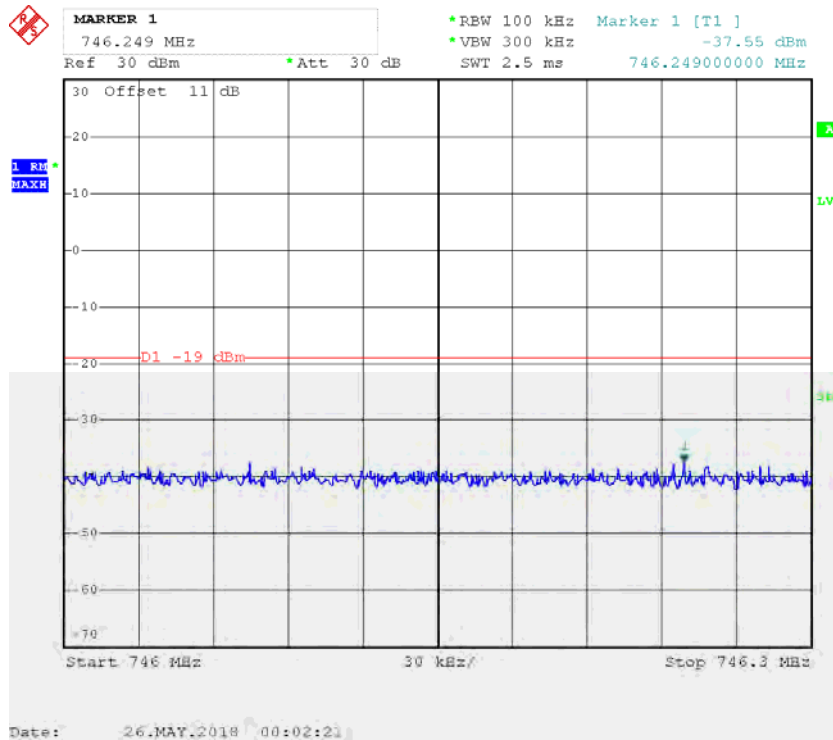

Lower 700MHz Band LTE Right Side 743.5MHz Above AGC

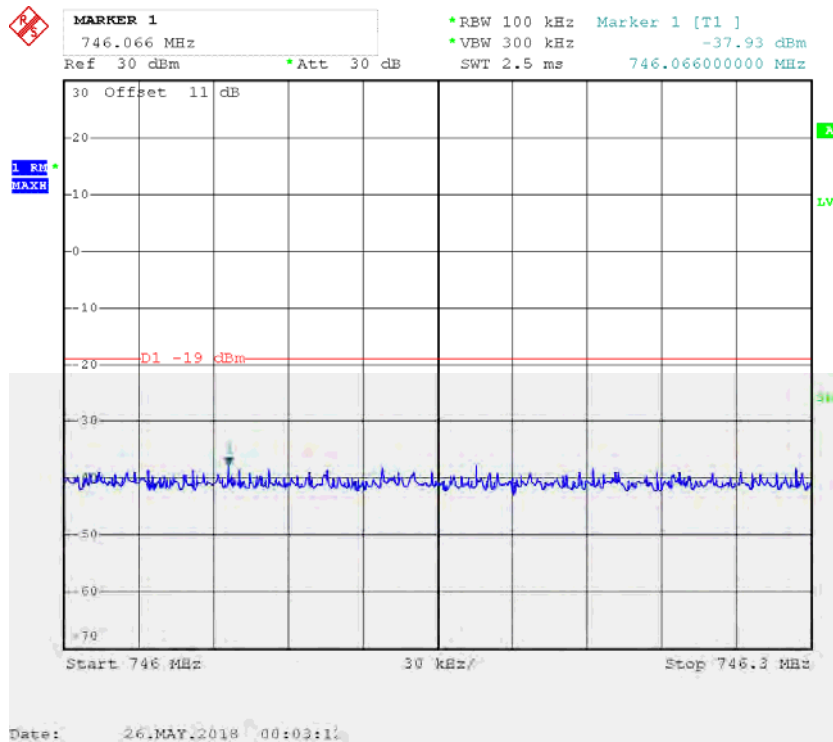

Uplink

PCS Band CDMA Left Side 1851.25MHz Pre-AGC

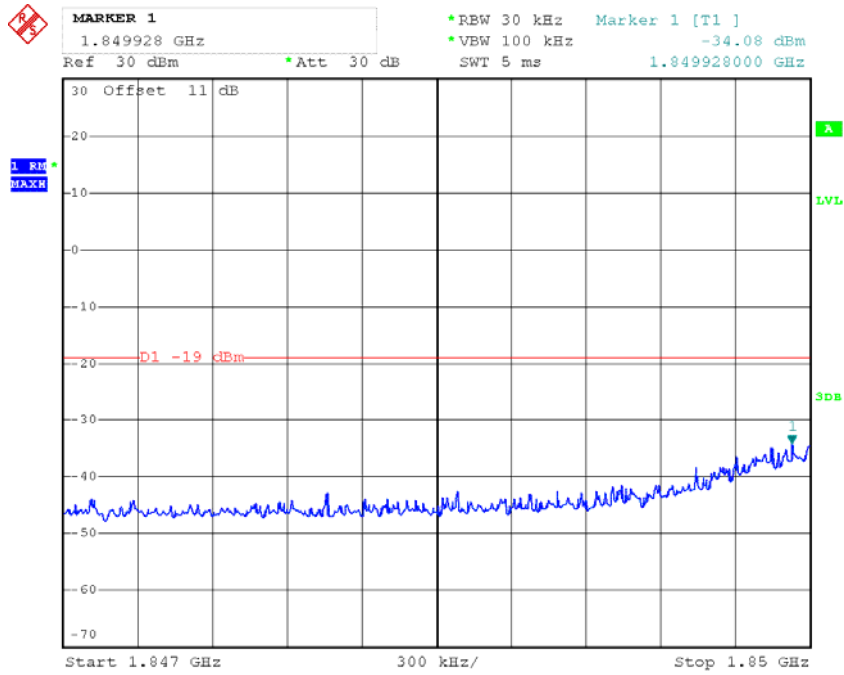

Date: 25.MAY.2018 21:00:50

PCS Band CDMA Left Side 1851.25MHz Above AGC

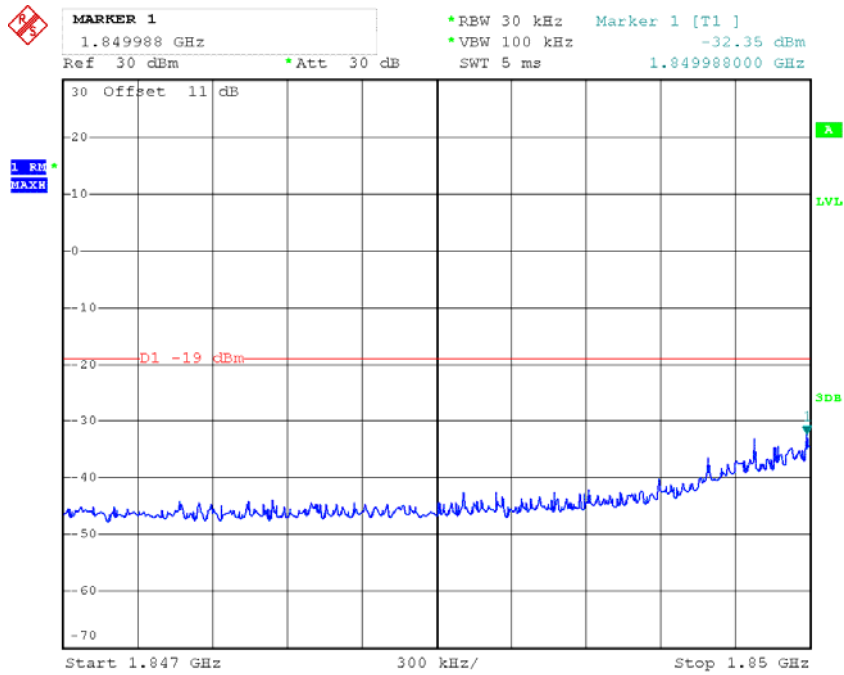

Date: 25.MAY.2018 21:01:28

PCS Band GSM Left Side 1850.2MHz Pre-AGC

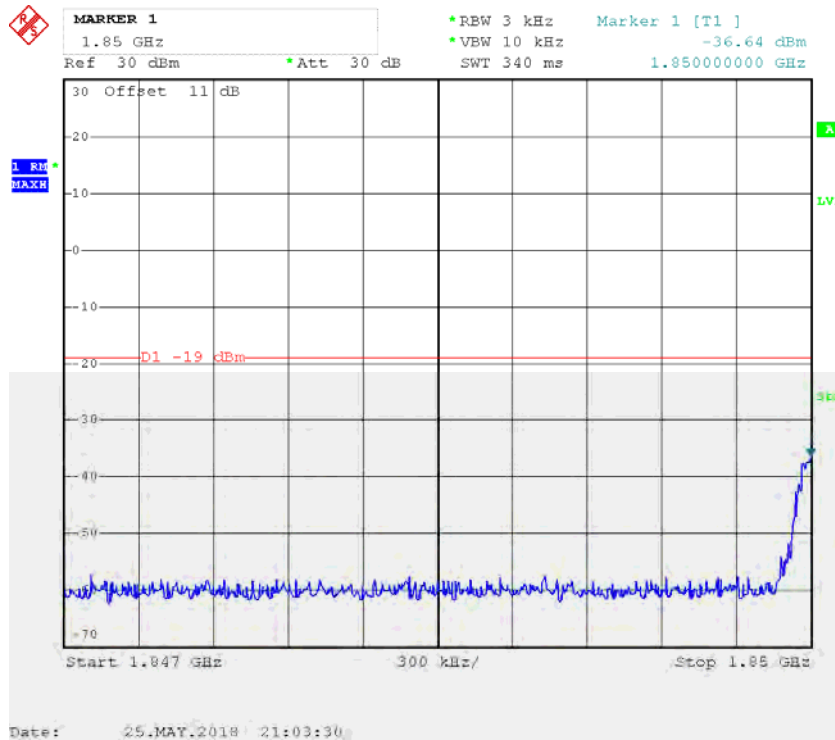

PCS Band GSM Left Side 1850.2MHz Above AGC

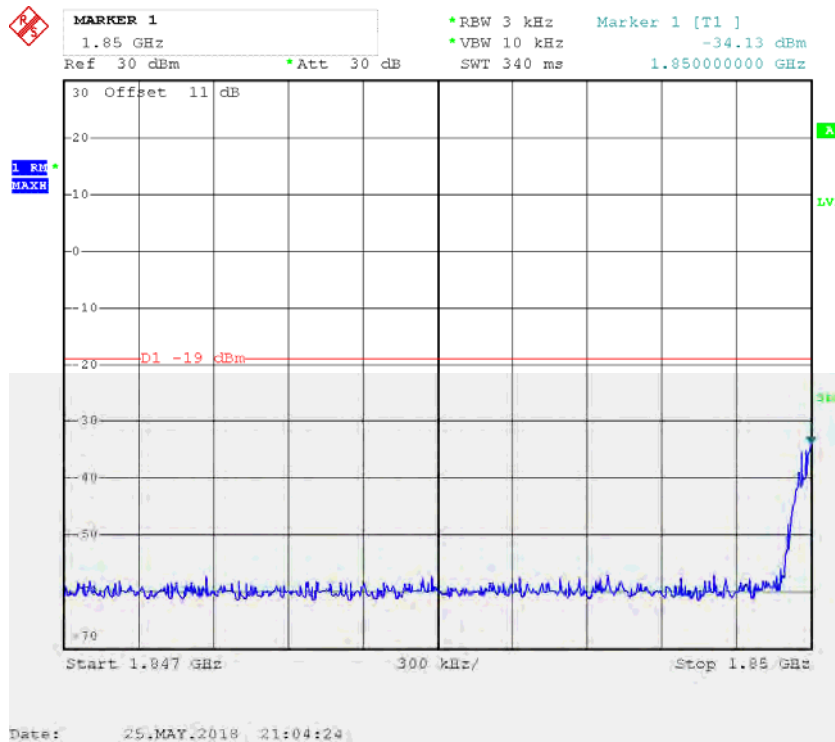

PCS Band LTE Left Side 1852.5MHz Pre-AGC

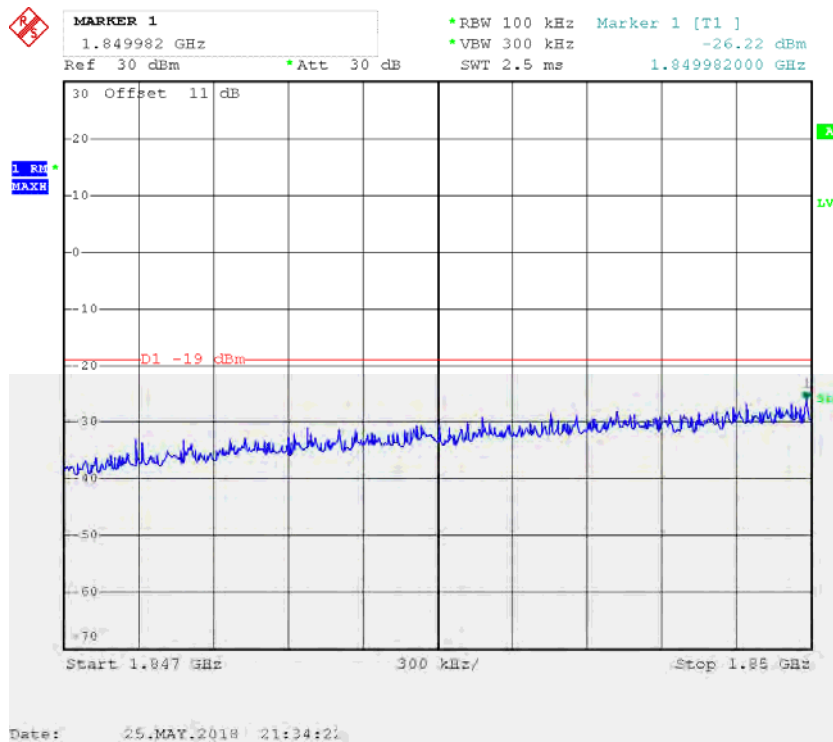

PCS Band LTE Left Side 1852.5MHz Above AGC

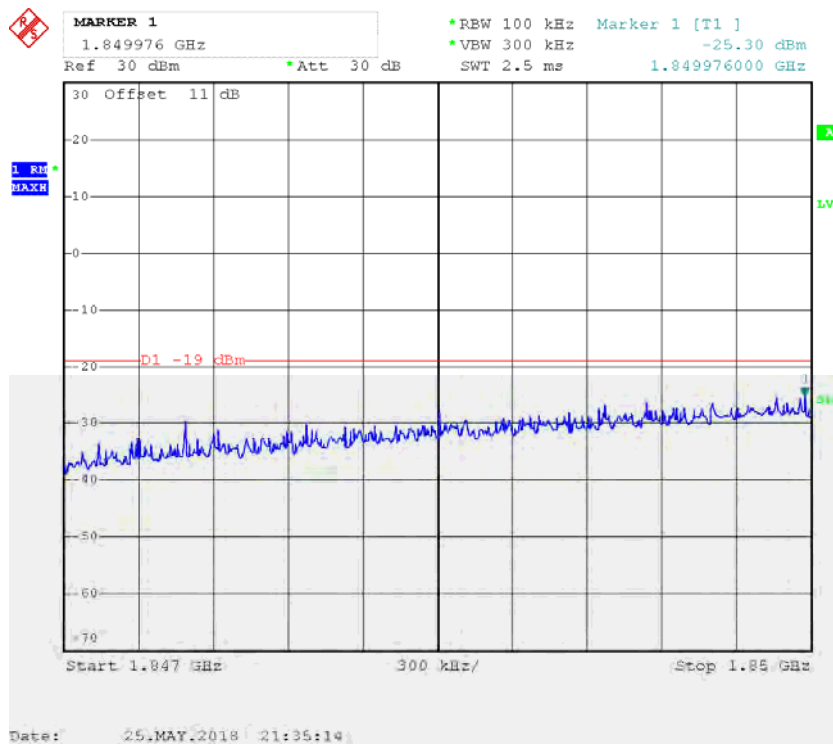

PCS Band CDMA Right Side 1908.75MHz Pre-AGC

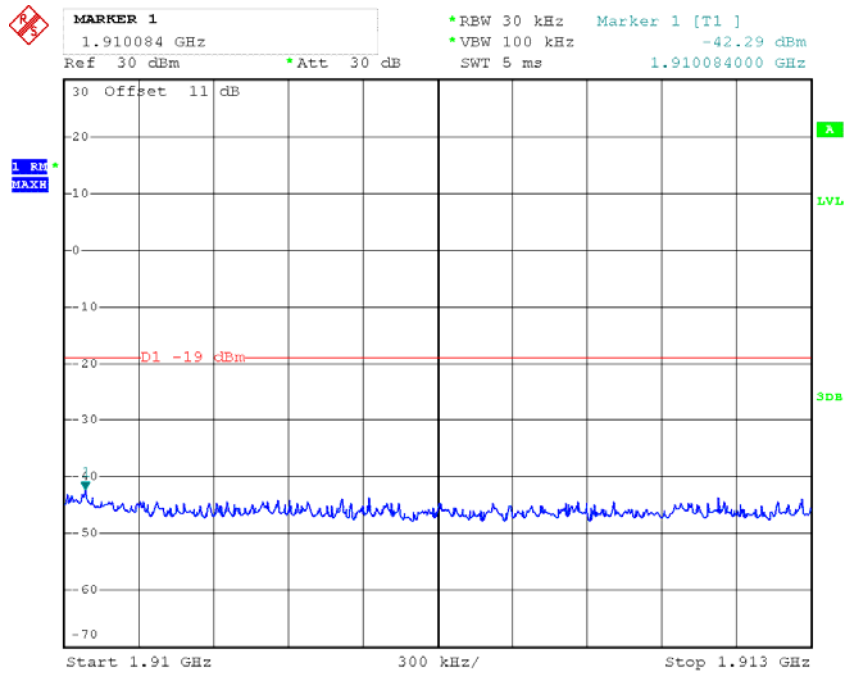

Date: 25.MAY.2018 20:54:13

PCS Band CDMA Right Side 1908.75MHz Above AGC

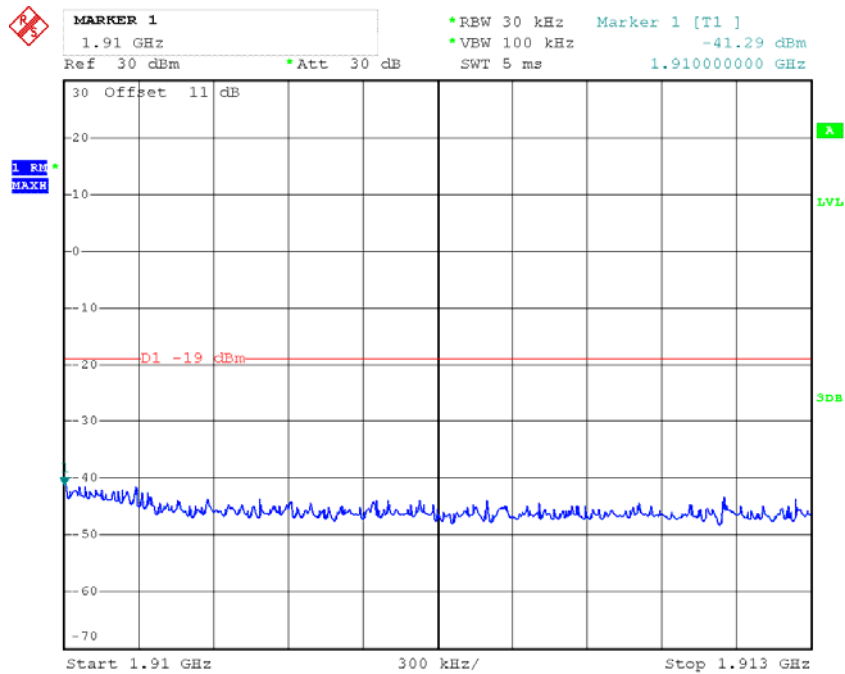

Date: 25.MAY.2018 20:55:03

PCS Band GSM Right Side 1909.8MHz Pre-AGC

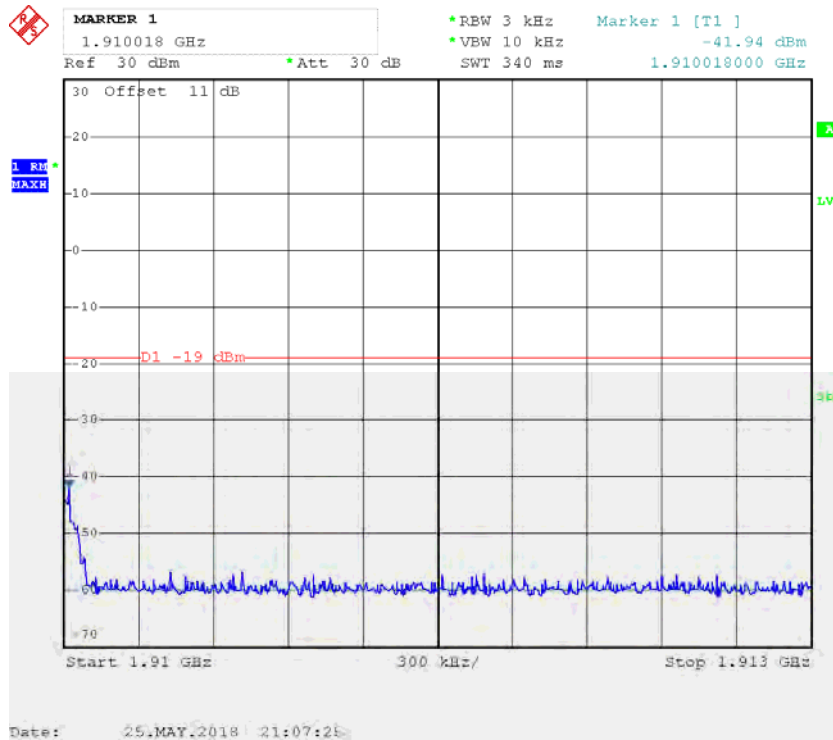

PCS Band GSM Right Side 1909.8MHz Above AGC

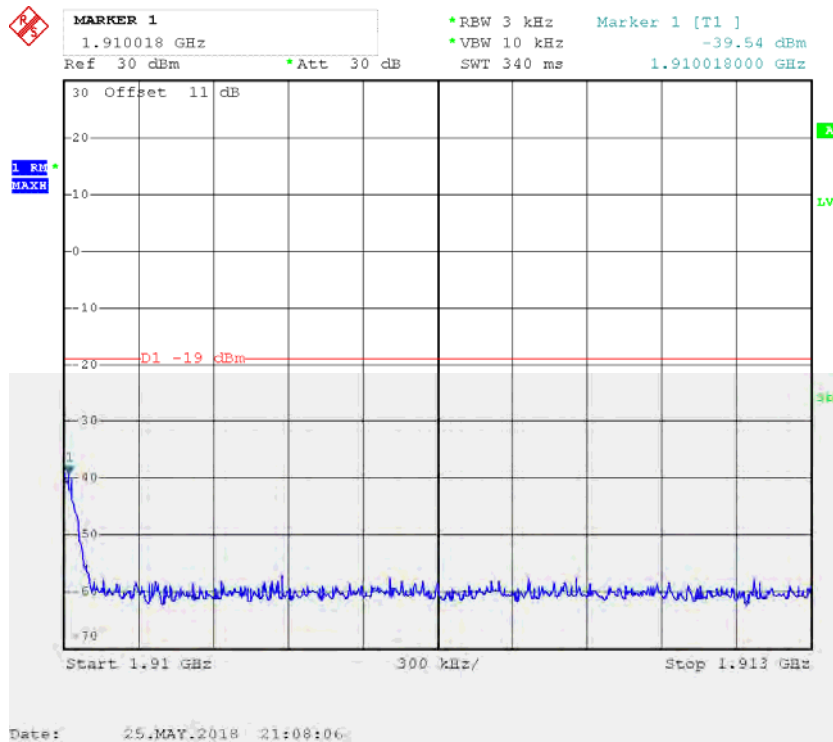

PCS Band LTE Right Side 1907.5MHz Pre-AGC

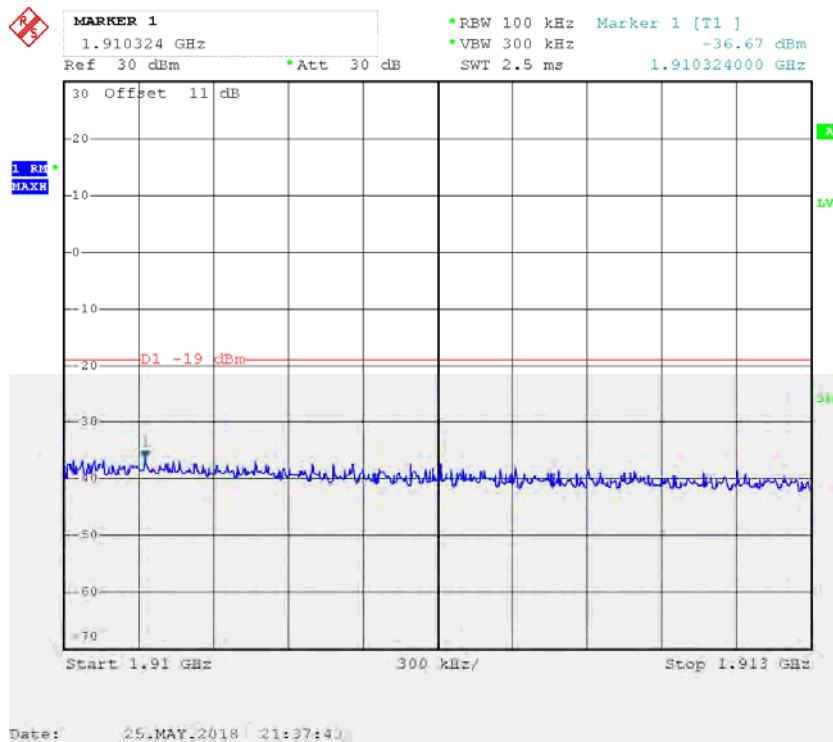

PCS Band LTE Right Side 1907.5MHz Above AGC

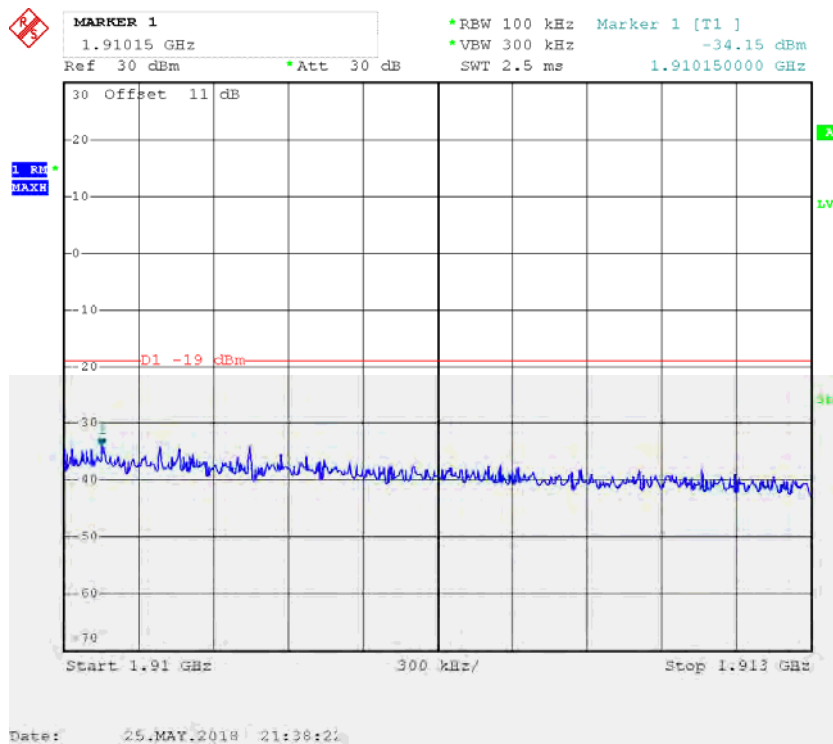

AWS Band CDMA Left Side 1711.25MHz Pre-AGC

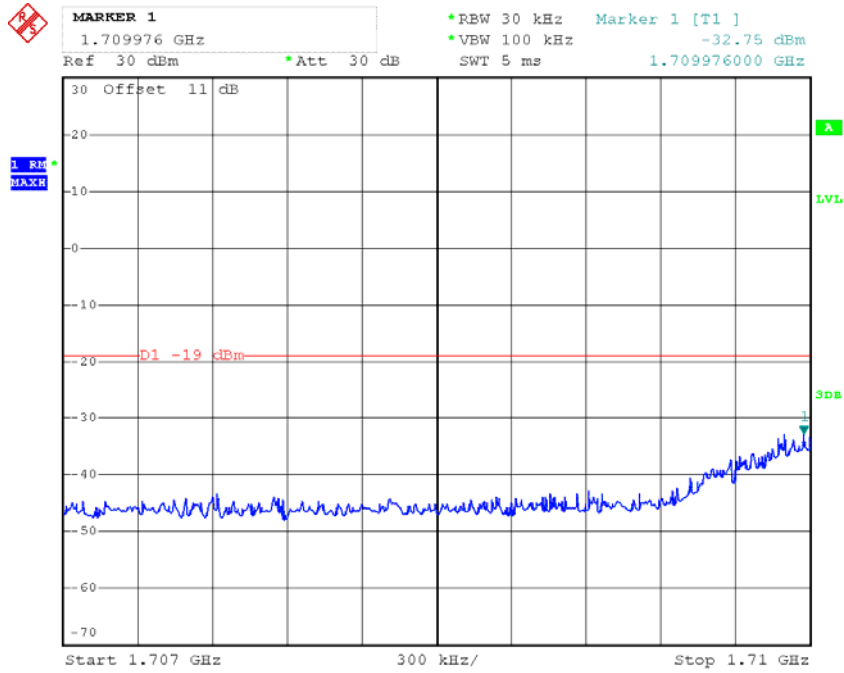

AWS Band CDMA Left Side 1711.25MHz Above AGC

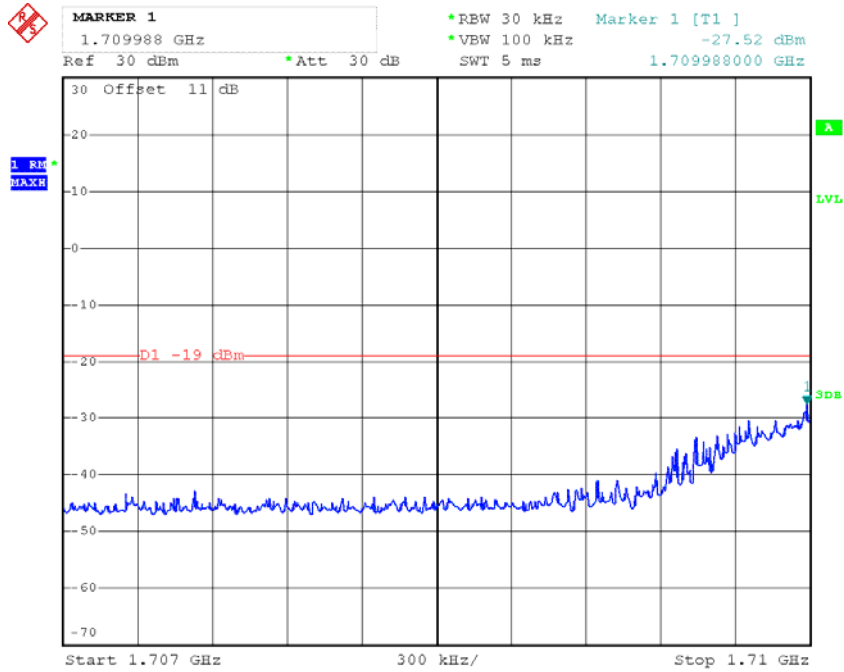

AWS Band GSM Left Side 1710.2MHz Pre-AGC

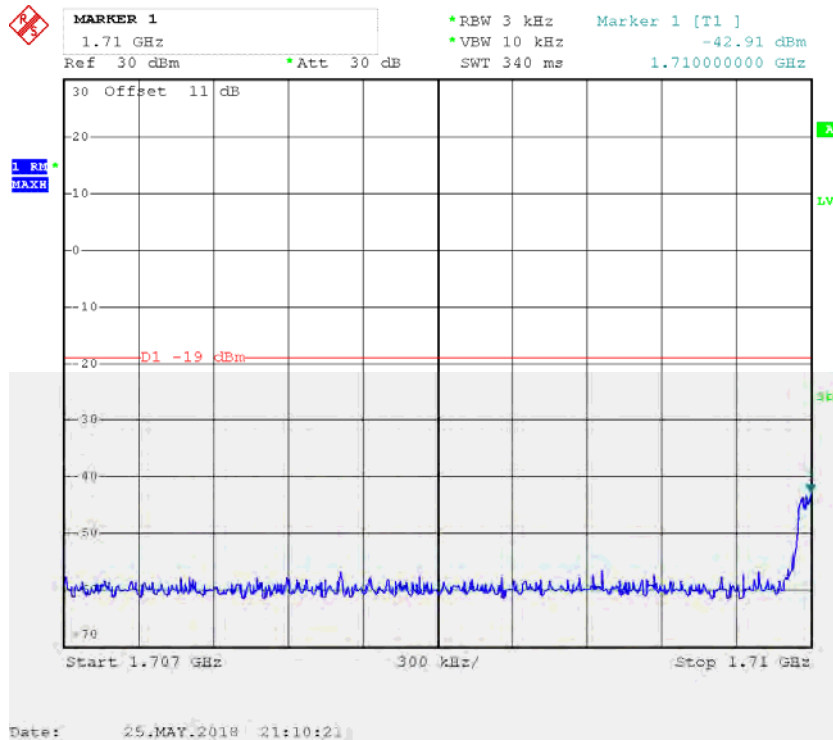

AWS Band GSM Left Side 1710.2MHz Above AGC

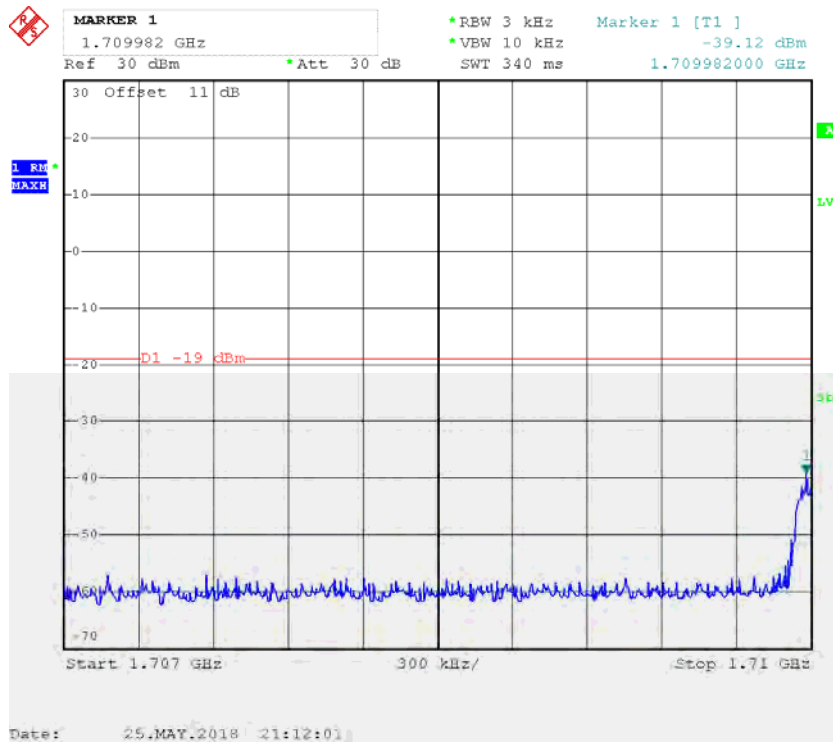

AWS Band LTE Left Side 1712.5MHz Pre-AGC

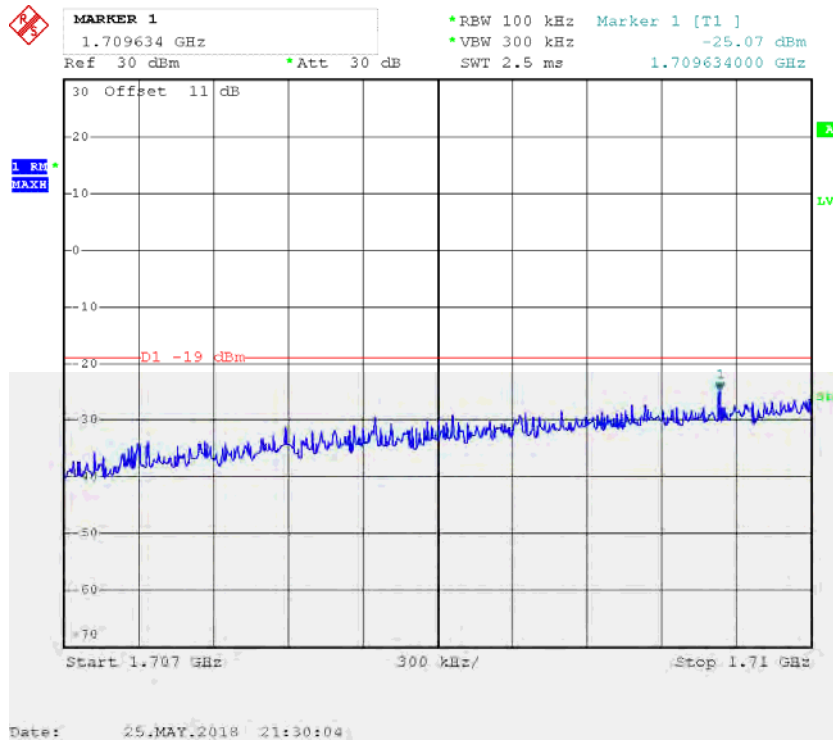

AWS Band LTE Left Side 1712.5MHz Above AGC

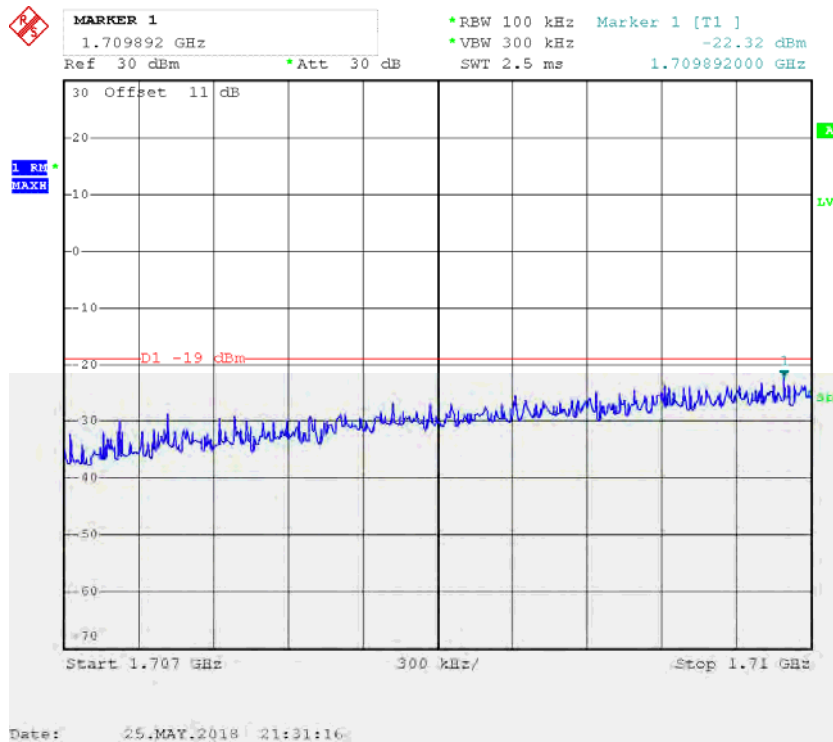

AWS Band CDMA Right Side 1753.75MHz Pre-AGC

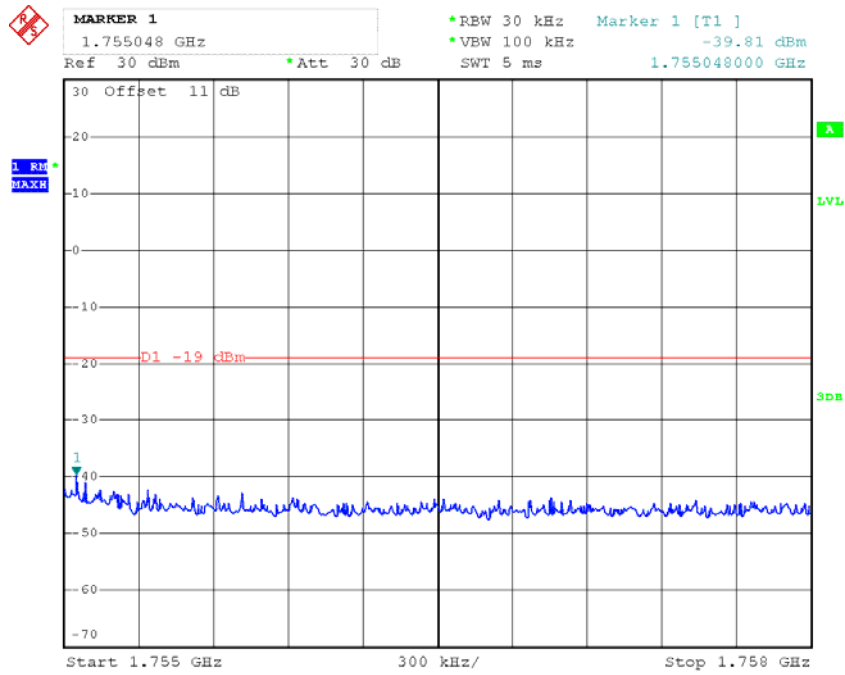

Date: 25.MAY.2018 21:23:12

AWS Band CDMA Right Side 1753.75MHz Above AGC

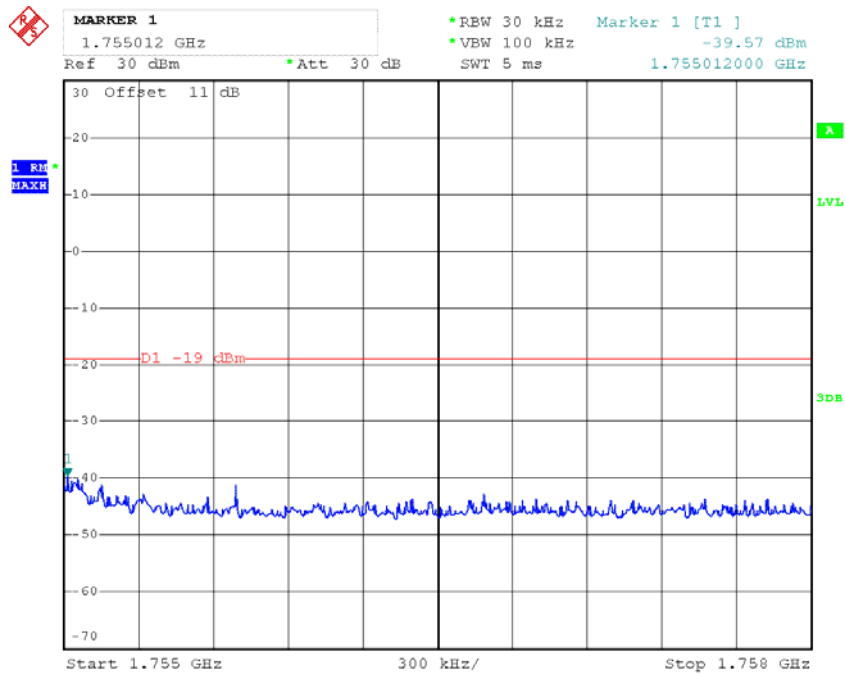

Date: 25.MAY.2018 21:23:56

AWS Band GSM Right Side 1754.8MHz Pre-AGC

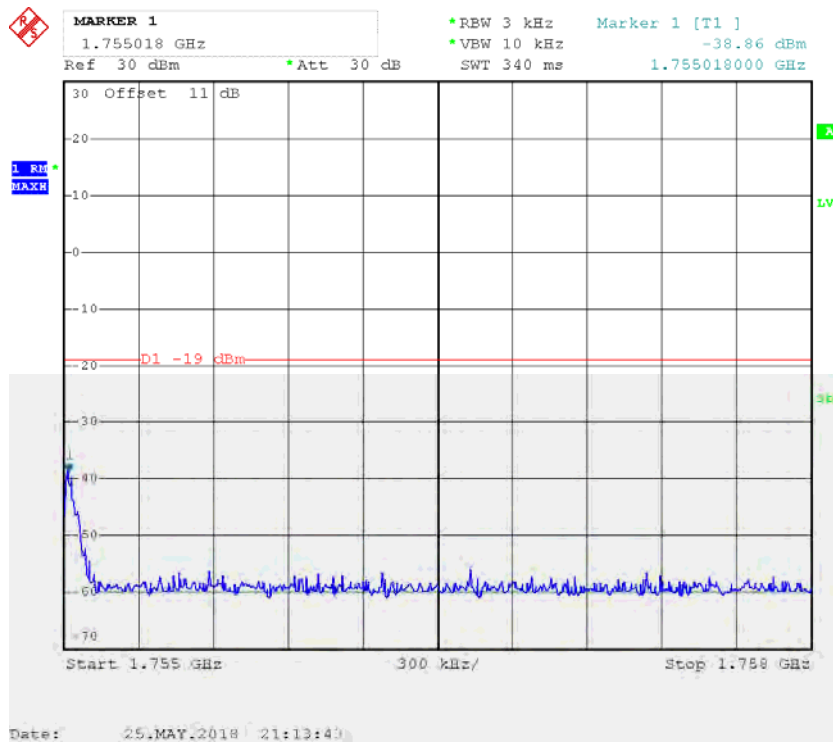

AWS Band GSM Right Side 1754.8MHz Above AGC

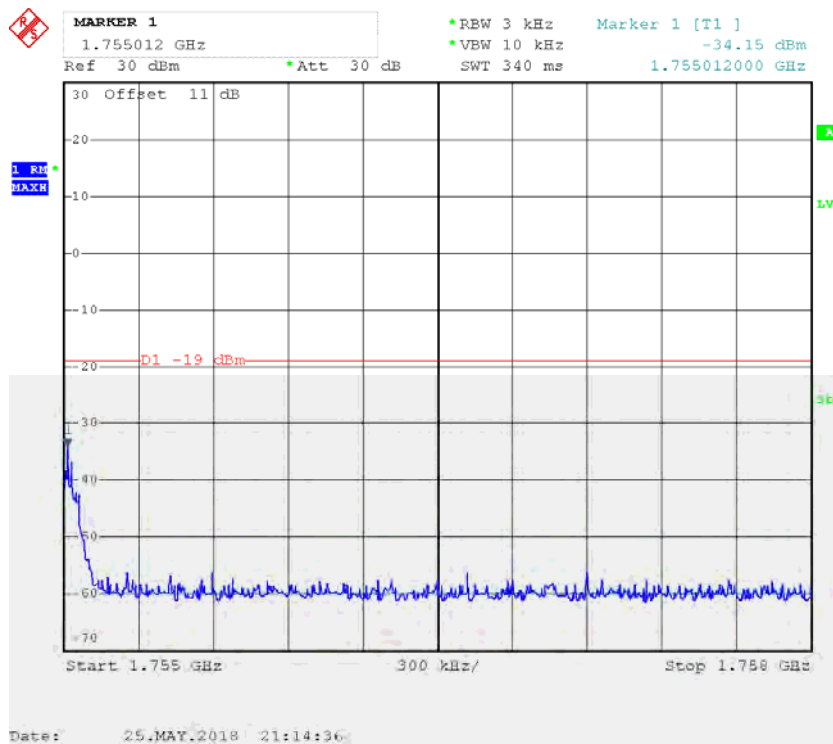

AWS Band LTE Right Side 1752.5MHz Pre-AGC

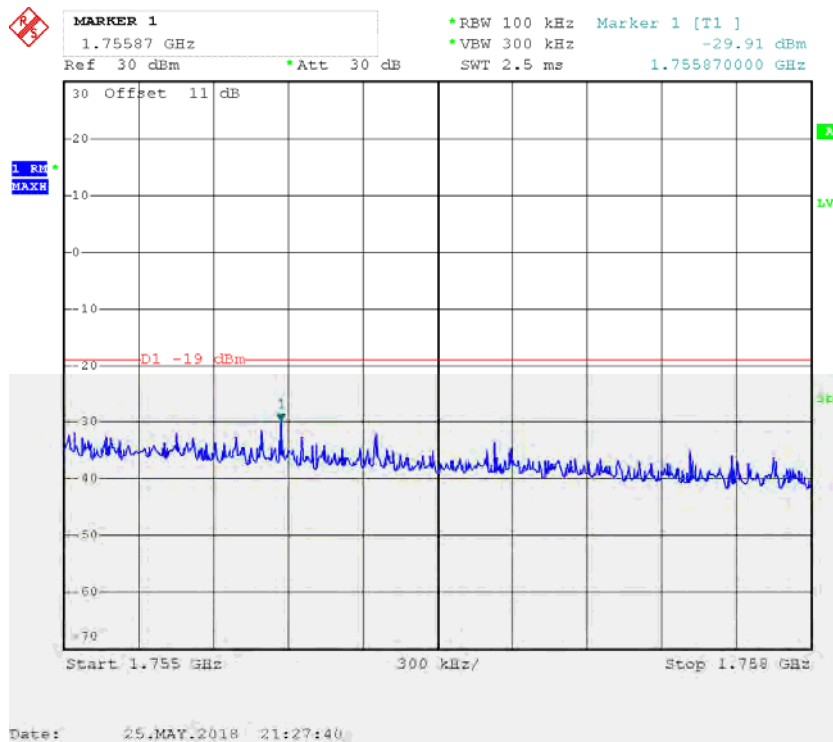

AWS Band LTE Right Side 1752.5MHz Above AGC

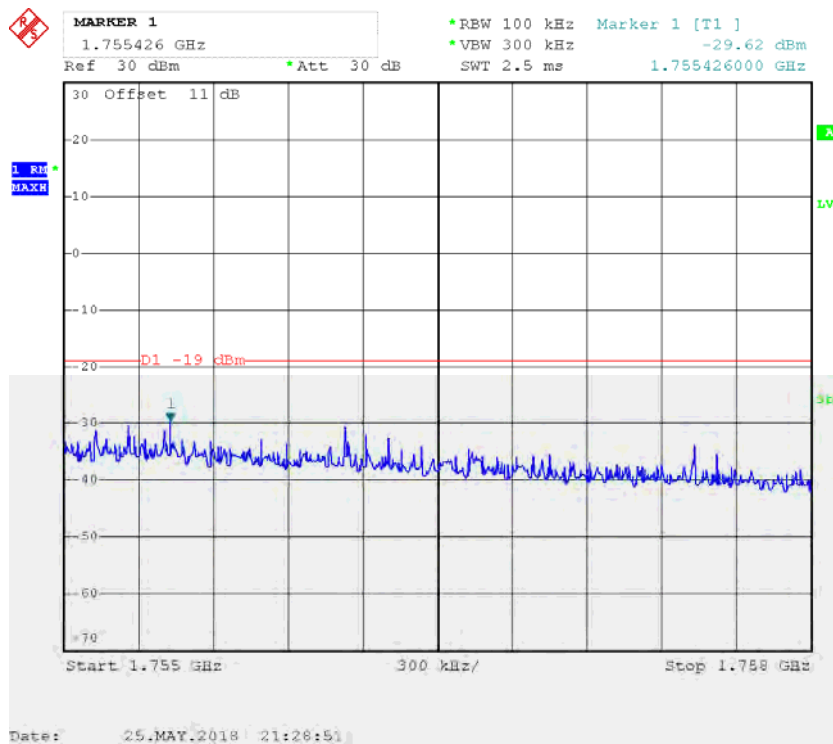

Cellular Band CDMA Left Side 824.88MHz Pre-AGC

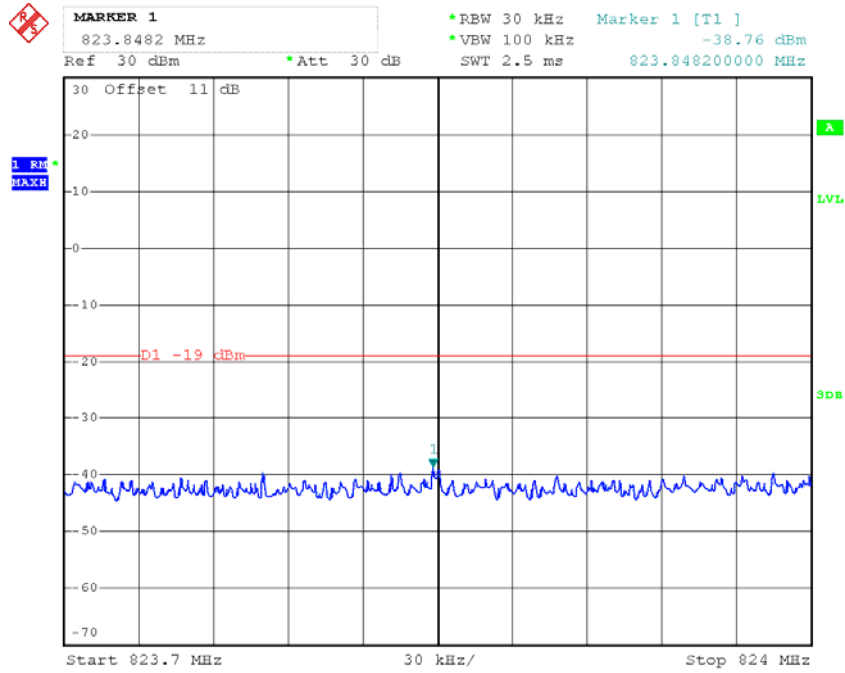

Date: 25.MAY.2018 20:30:44

Cellular Band CDMA Left Side 824.88MHz Above AGC

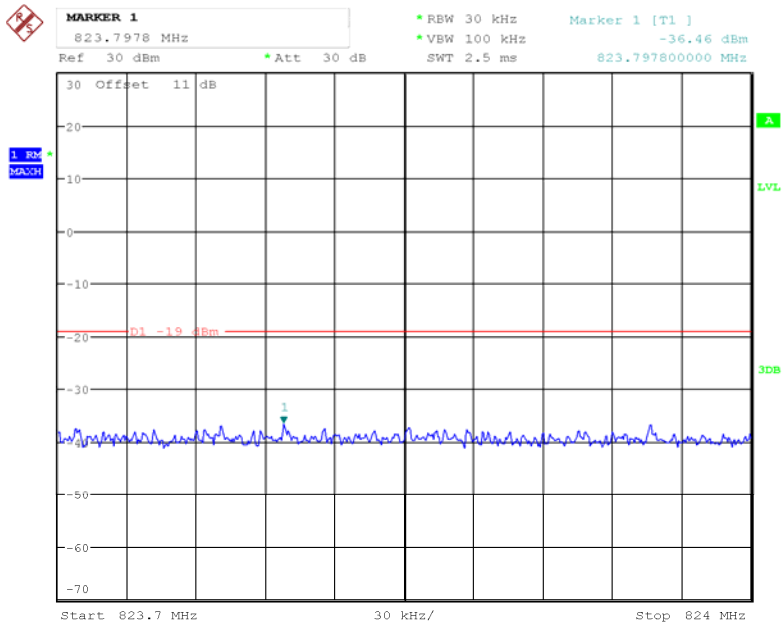

Date: 29.JUN.2018 19:28:27

Cellular Band GSM Left Side 824.2MHz Pre-AGC

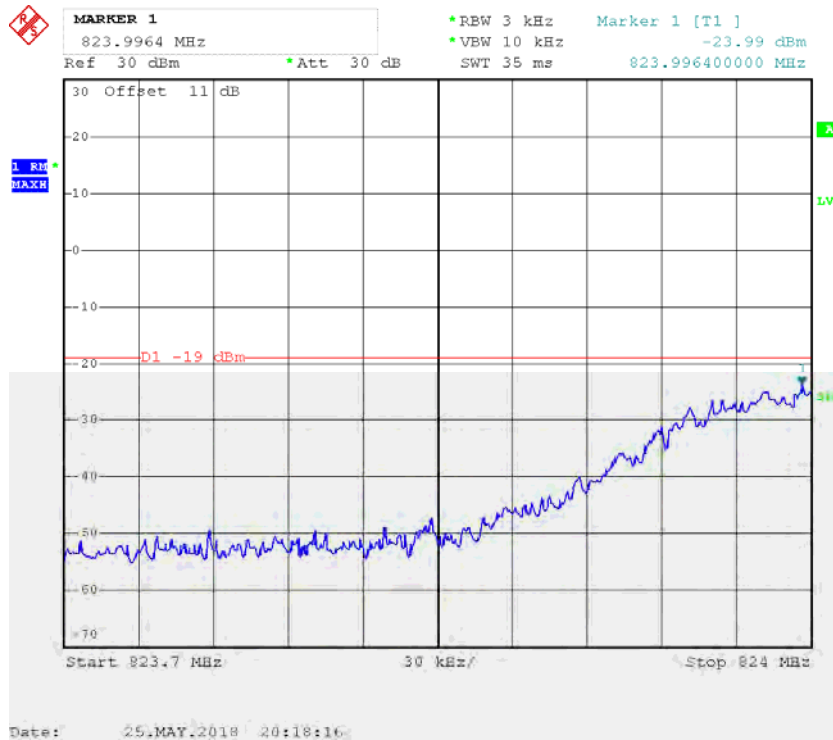

Cellular Band GSM Left Side 824.2MHz Above AGC

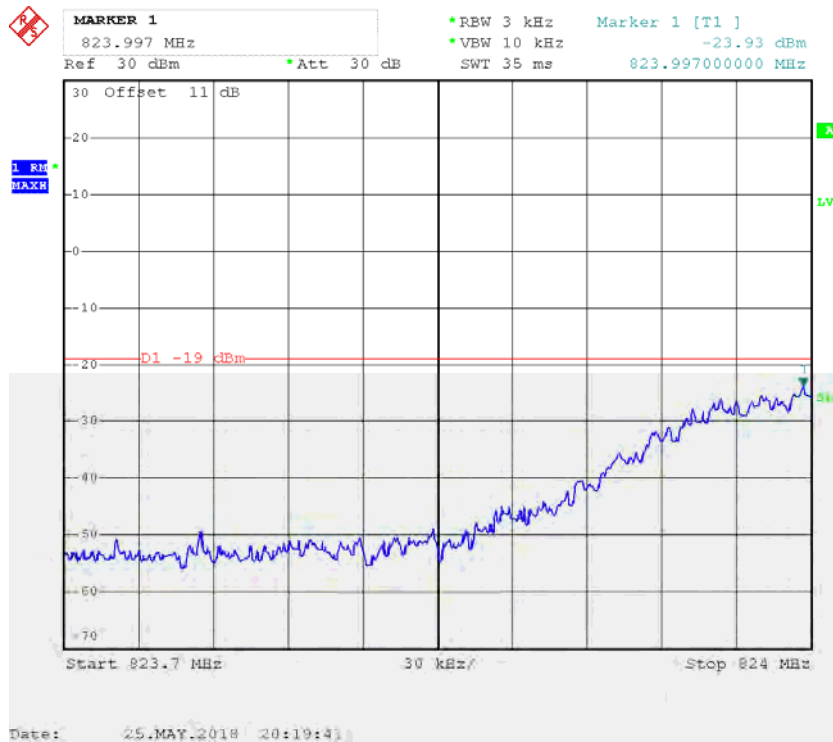

Cellular Band LTE Left Side 826.5MHz Pre-AGC

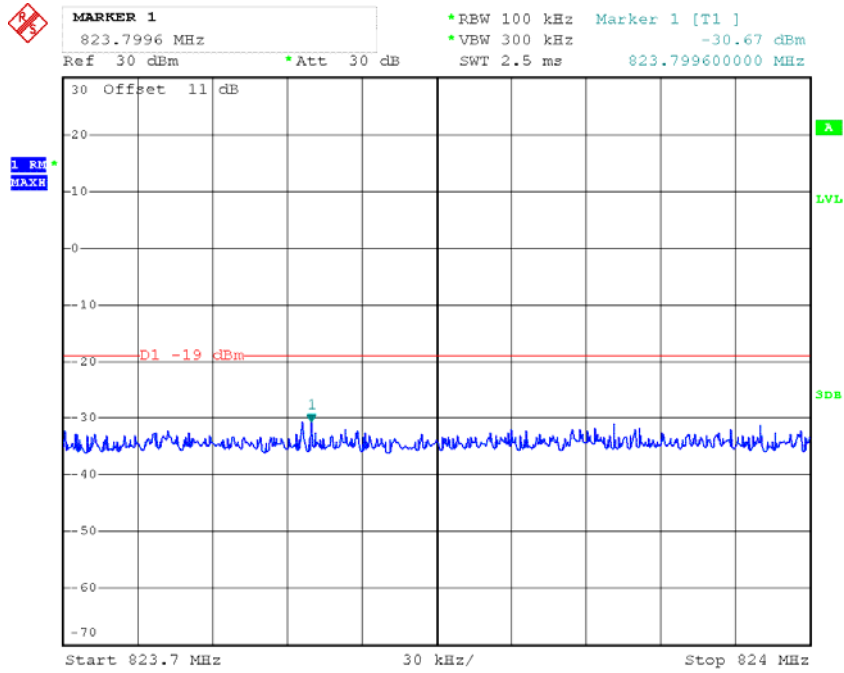

Date: 25.MAY.2018 21:43:38

Cellular Band LTE Left Side 826.5MHz Above AGC

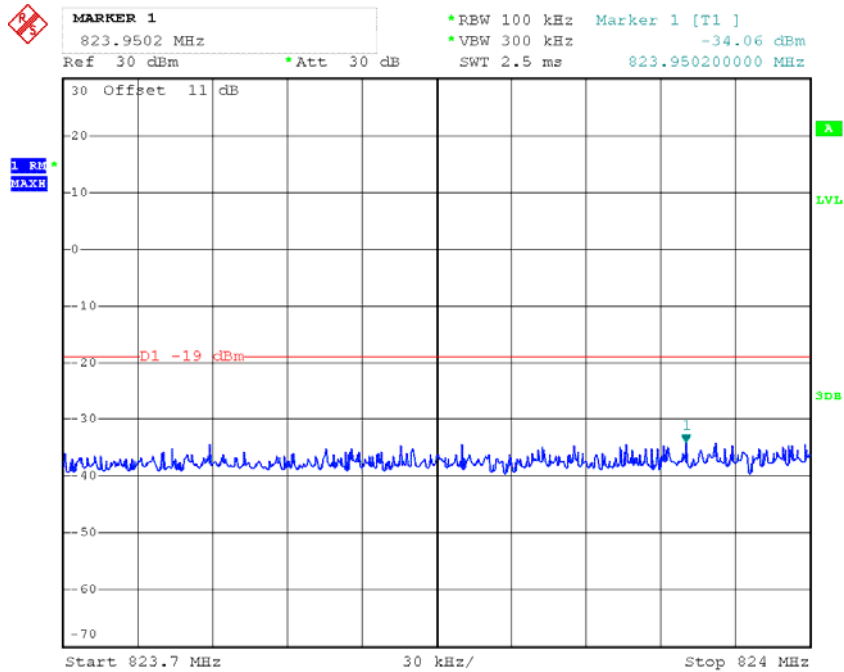

Date: 25.MAY.2018 20:34:37

Cellular Band CDMA Right Side 848.10MHz Pre-AGC

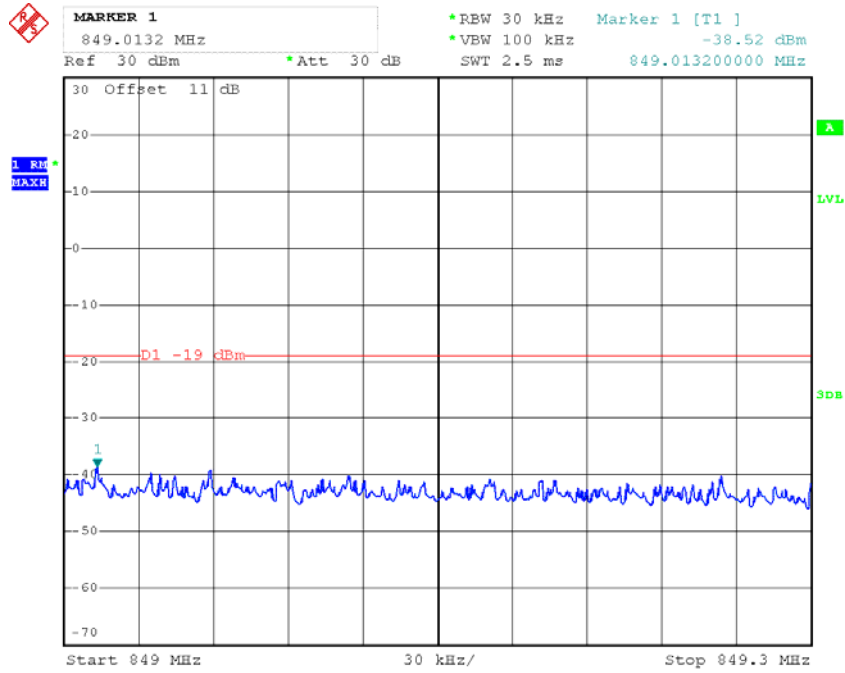

Date: 25.MAY.2018 20:27:54

Cellular Band CDMA Right Side 848.10MHz Above AGC

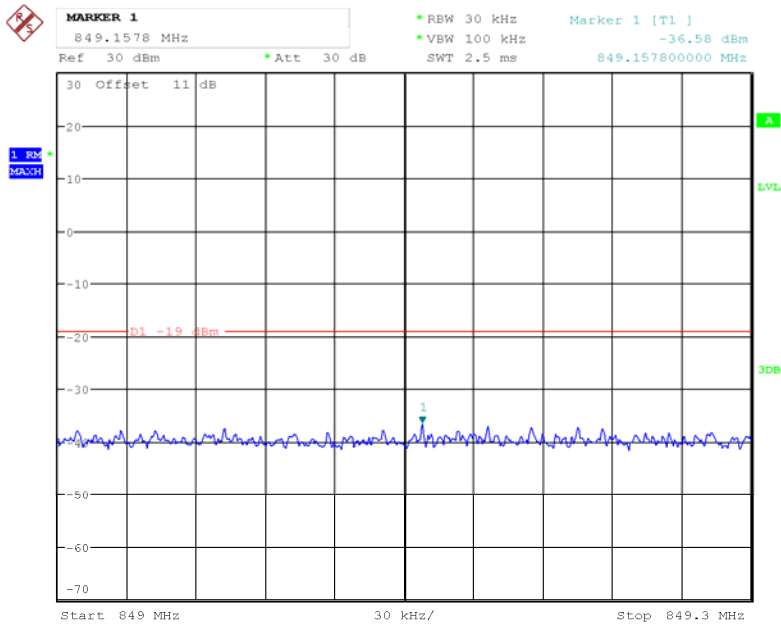

Date: 29.JUN.2018 19:29:17

Cellular Band GSM Right Side 848.8MHz Pre-AGC

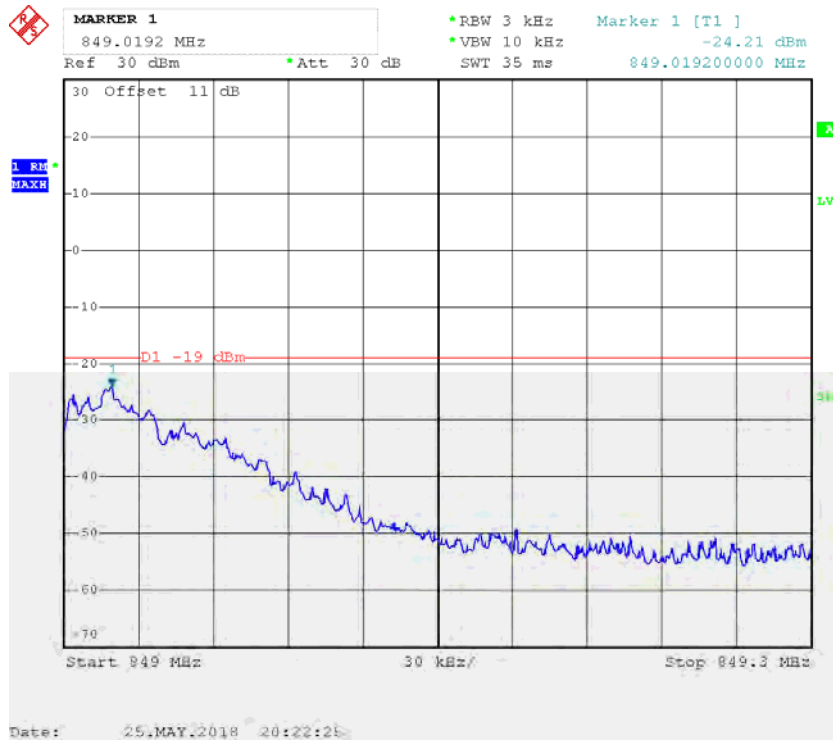

Cellular Band GSM Right Side 848.8MHz Above AGC

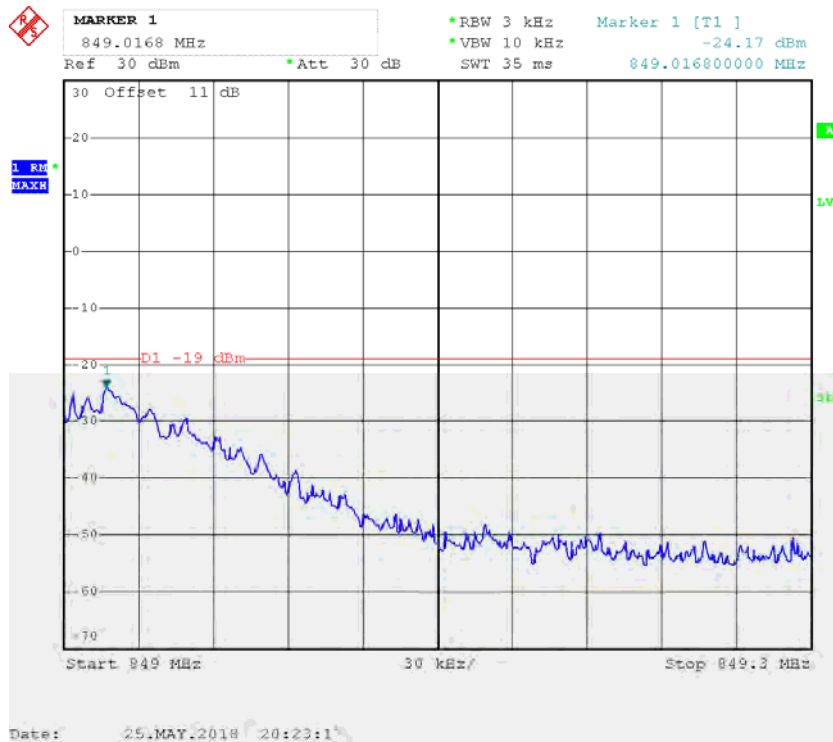

Cellular Band LTE Right Side 846.5MHz Pre-AGC

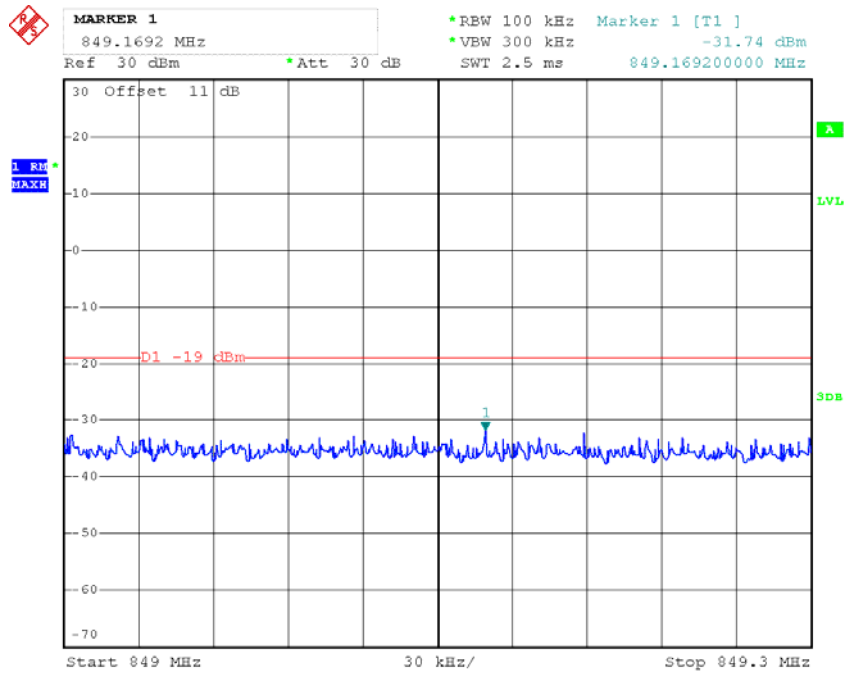

Date: 25.MAY.2018 21:48:11

Cellular Band LTE Right Side 846.5MHz Above AGC

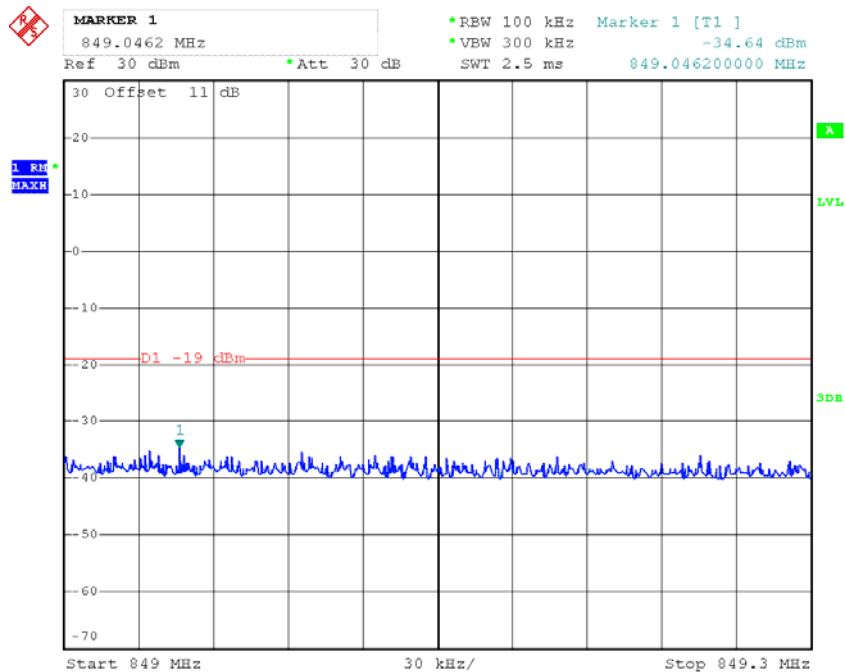

Date: 25.MAY.2018 20:37:41

Upper 700MHz Band CDMA Left Side 777.25MHz Pre-AGC

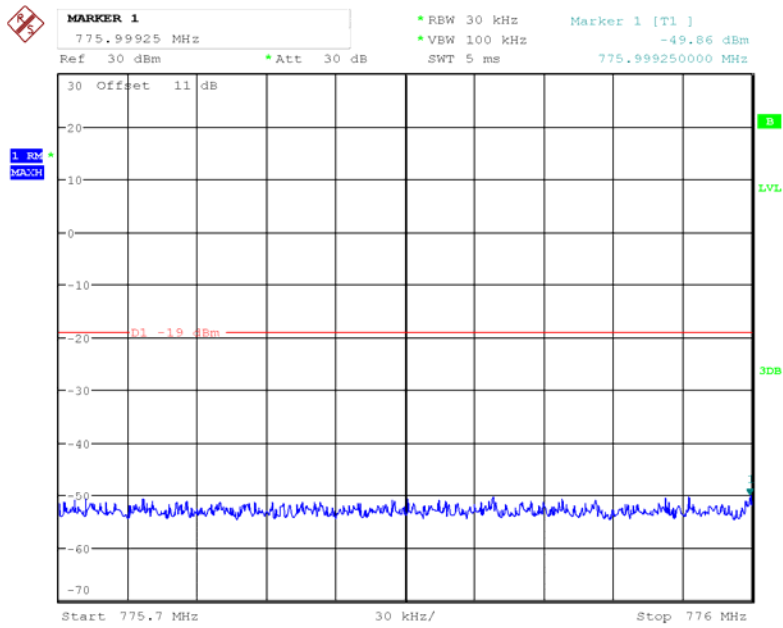

Date: 25.MAY.2018 00:39:32

Upper 700MHz Band CDMA Left Side 777.25MHz Above AGC

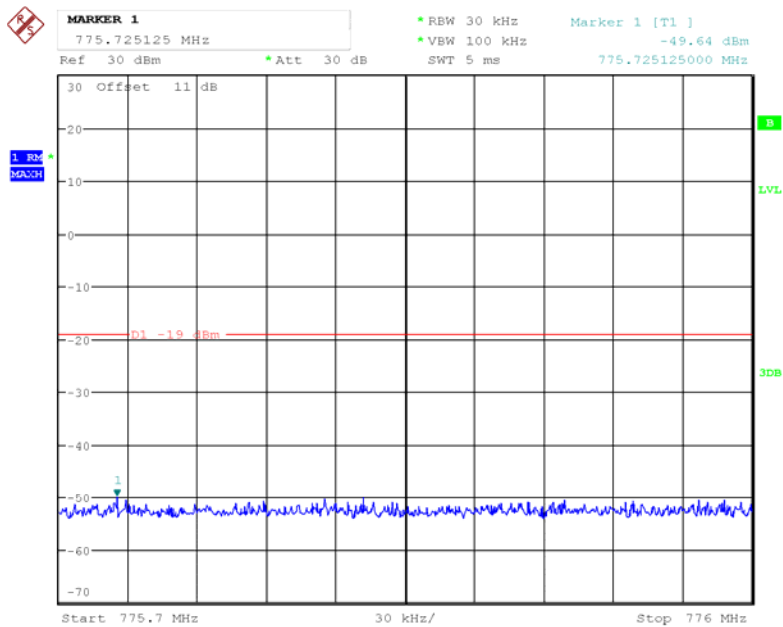

Date: 25.MAY.2018 00:40:19

Upper 700MHz Band GSM Left Side 776.2MHz Pre-AGC

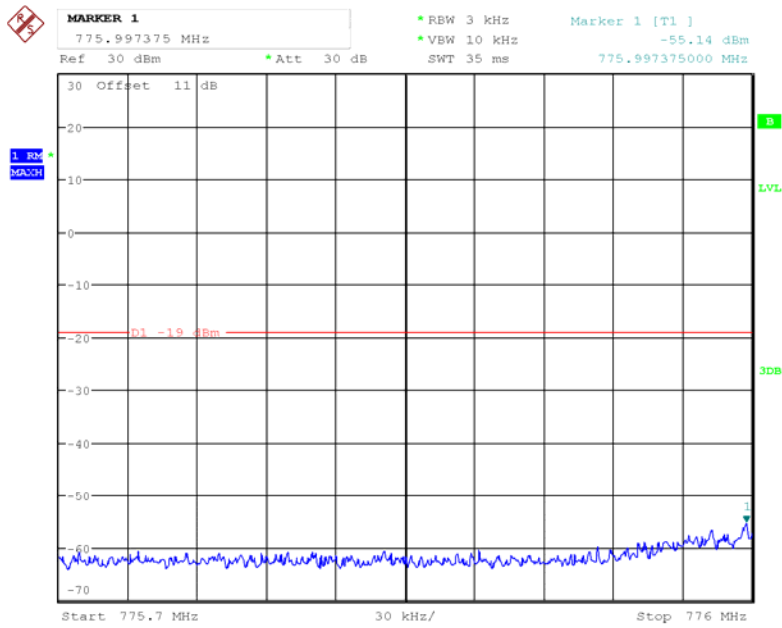

Date: 25.MAY.2018 00:42:42

Upper 700MHz Band GSM Left Side 776.2MHz Above AGC

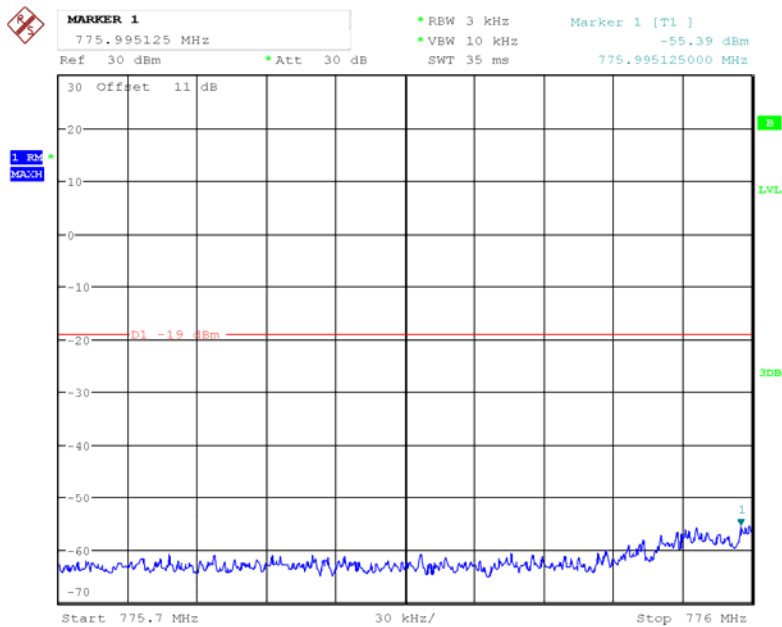

Date: 25.MAY.2018 00:43:35

Upper 700MHz Band LTE Left Side 778.5MHz Pre-AGC

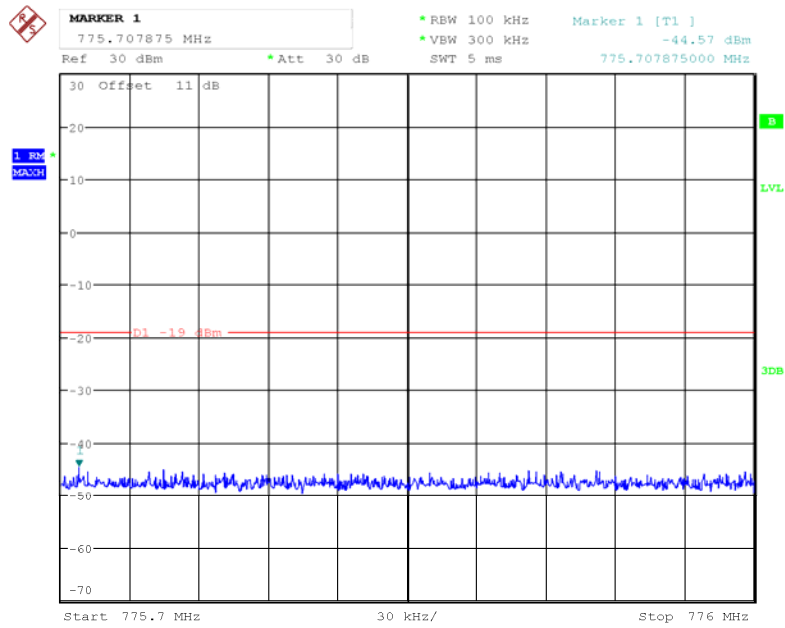

Date: 25.MAY.2018 00:29:49

Upper 700MHz Band LTE Left Side 778.5MHz Above AGC

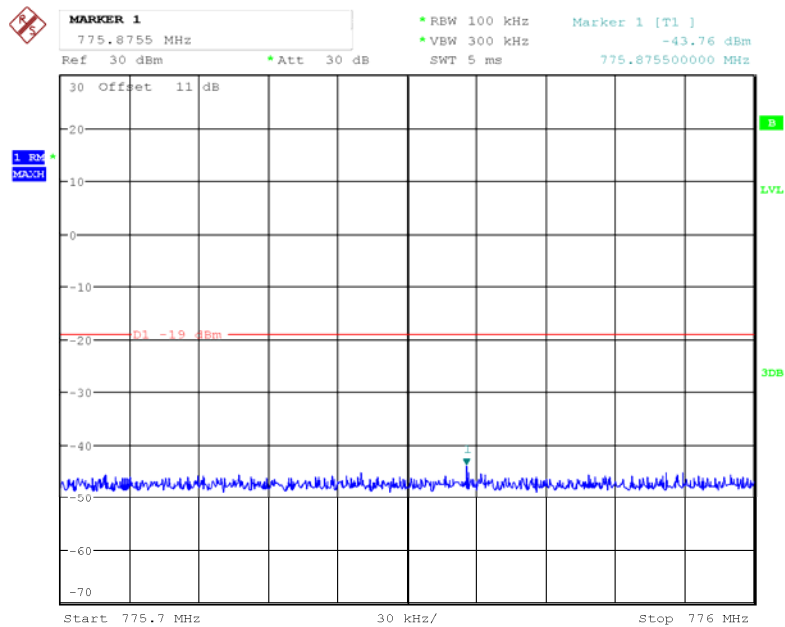

Date: 25.MAY.2018 00:31:02

Upper 700MHz Band CDMA Right Side 785.75MHz Pre-AGC

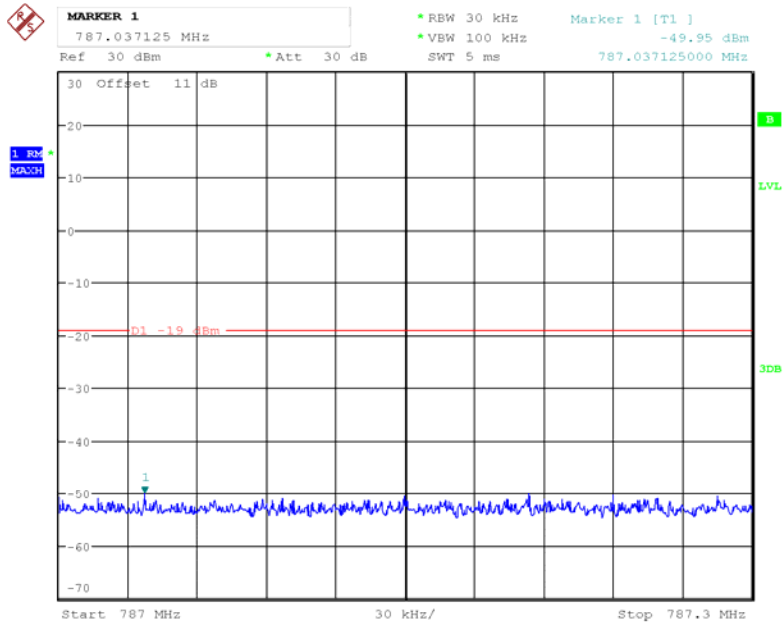

Date: 25.MAY.2018 00:36:22

Upper 700MHz Band CDMA Right Side 785.75MHz Above AGC

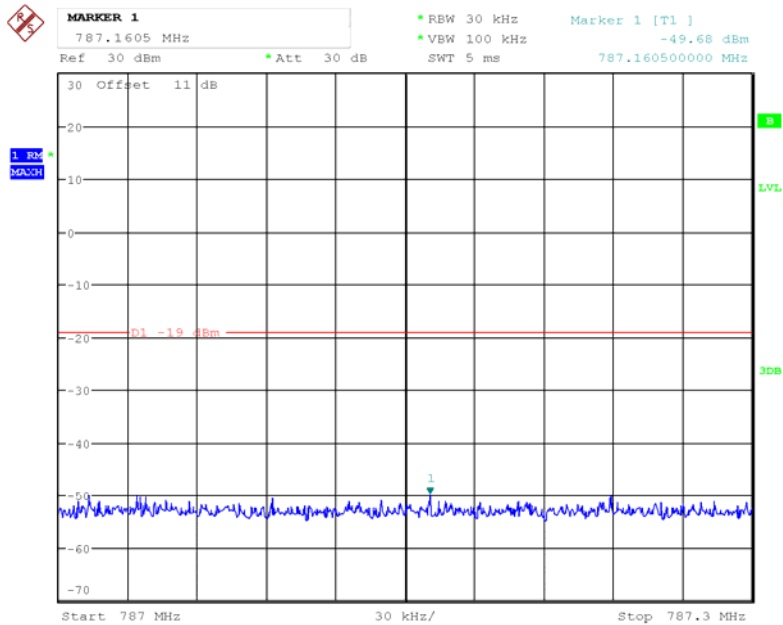

Date: 25.MAY.2018 00:37:37

Upper 700MHz Band GSM Right Side 786.8MHz Pre-AGC

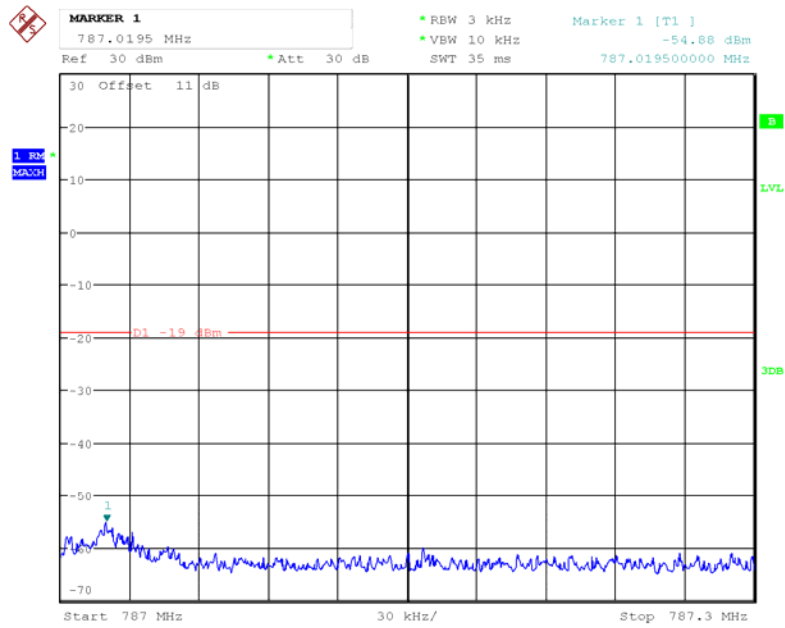

Date: 25.MAY.2018 00:46:23

Upper 700MHz Band GSM Right Side 786.8MHz Above AGC

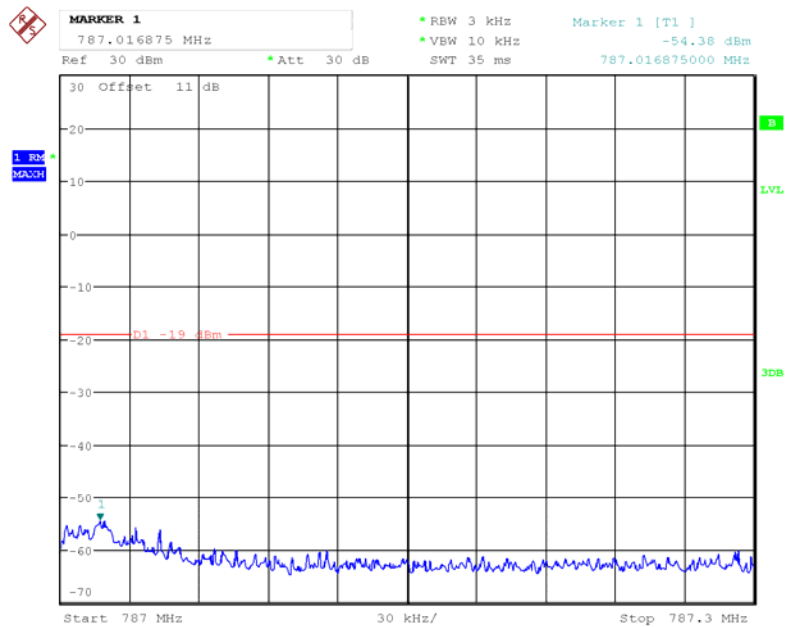

Date: 25.MAY.2018 00:47:24

Upper 700MHz Band LTE Right Side 784.5MHz Pre-AGC

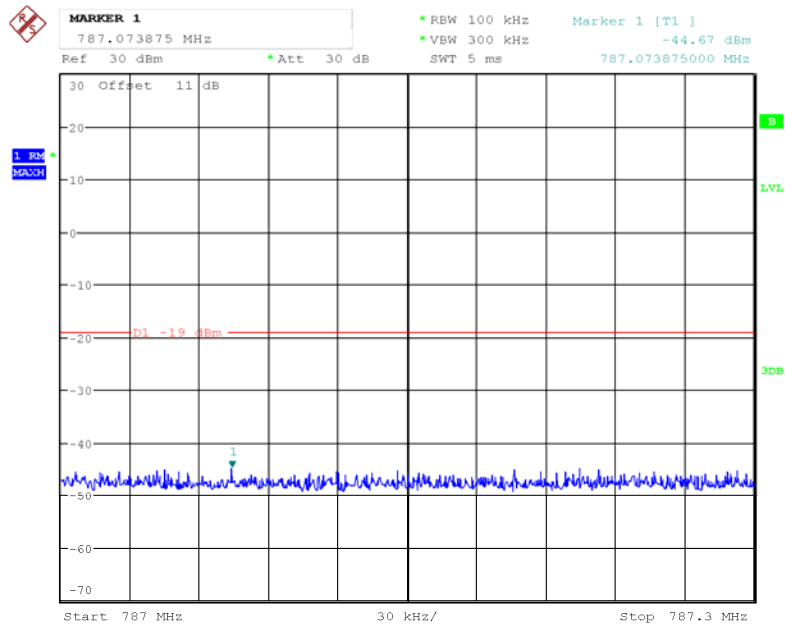

Date: 25.MAY.2018 00:33:55

Upper 700MHz Band LTE Right Side 784.5MHz Above AGC

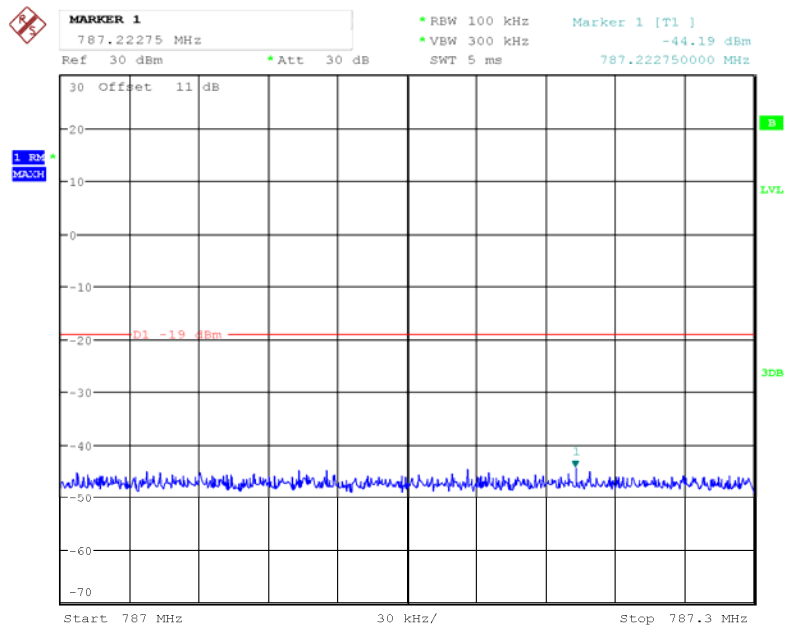

Date: 25.MAY.2018 00:34:39

Upper 700MHz Band CDMA Left Side 699.25MHz Pre-AGC

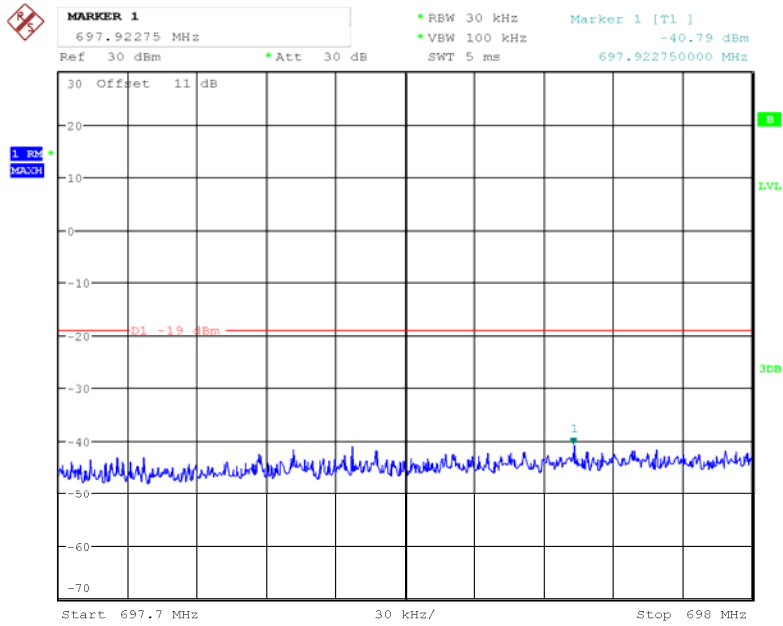

Date: 24.MAY.2018 23:59:24

Lower 700MHz Band CDMA Left Side 699.25MHz Above AGC

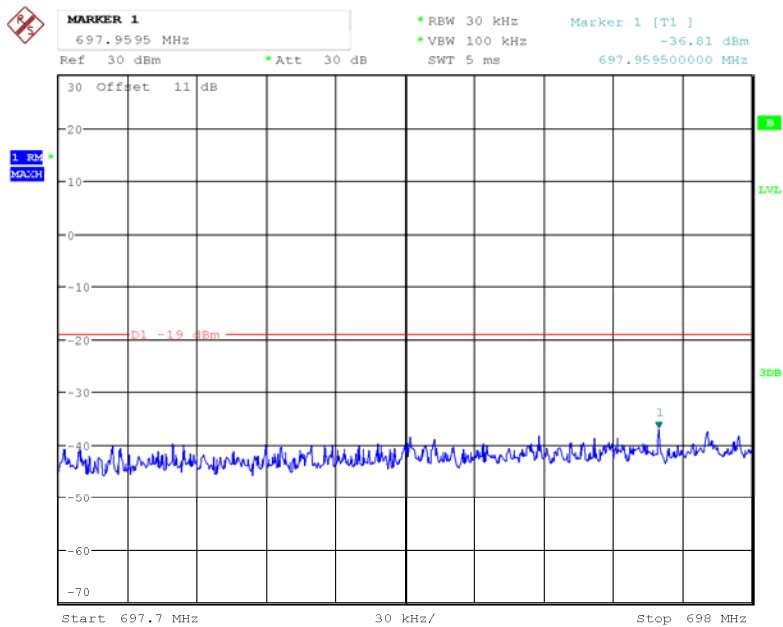

Date: 25.MAY.2018 00:00:03

Lower 700MHz Band GSM Left Side 698.2MHz Pre-AGC

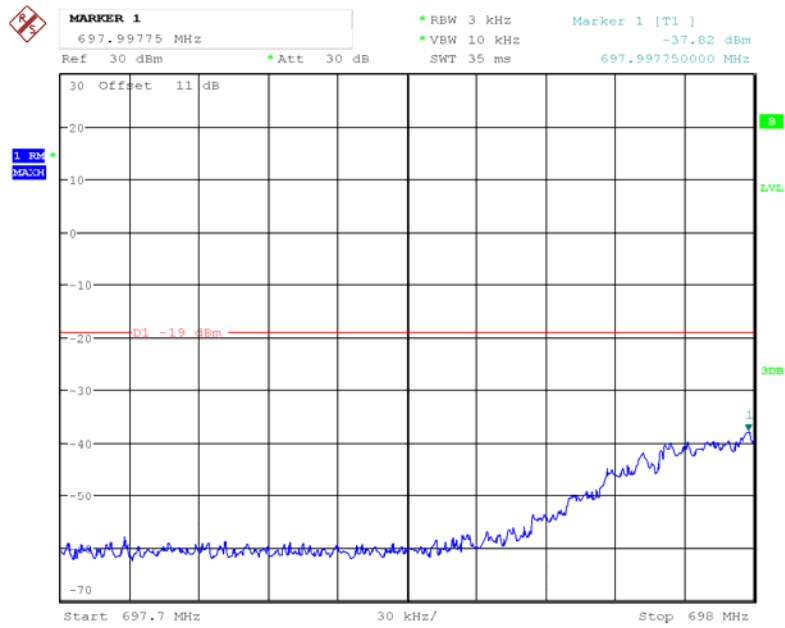

Date: 24.MAY.2018 23:47:35

Lower 700MHz Band GSM Left Side 698.2MHz Above AGC

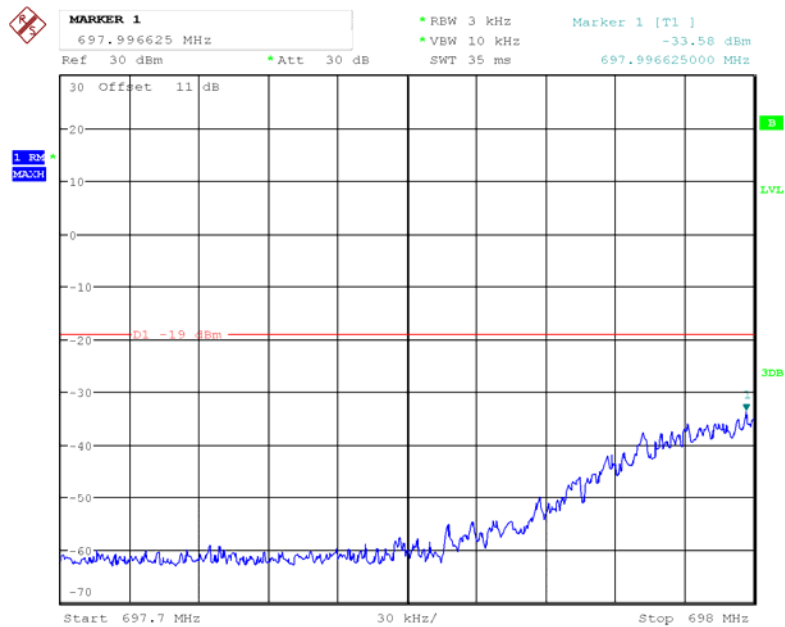

Date: 24.MAY.2018 23:50:25

Lower 700MHz Band LTE Left Side 670.5MHz Pre-AGC

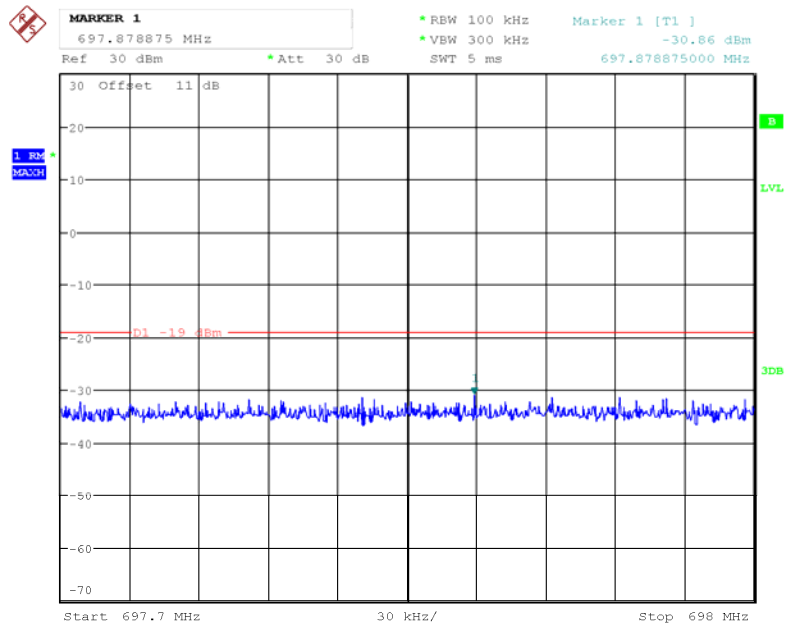

Date: 25.MAY.2018 00:01:40

Lower 700MHz Band LTE Left Side 670.5MHz Above AGC

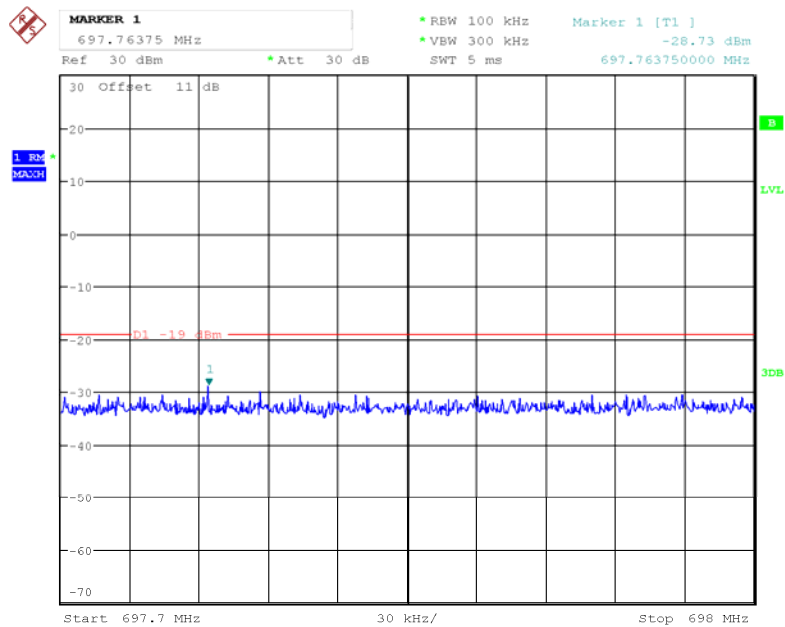

Date: 25.MAY.2018 00:03:13

Lower 700MHz Band CDMA Right Side 714.75MHz Pre-AGC

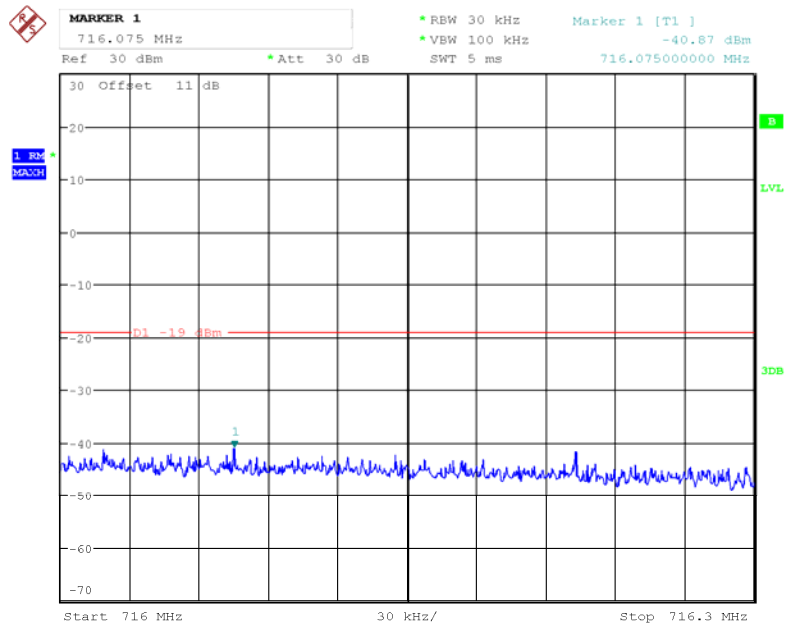

Date: 24.MAY.2018 23:57:05

Lower 700MHz Band CDMA Right Side 714.75MHz Above AGC

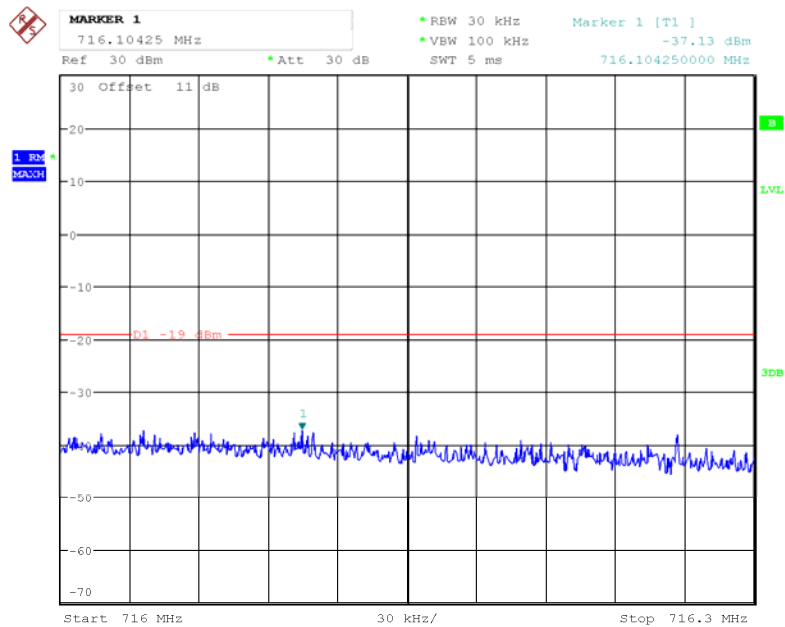

Date: 24.MAY.2018 23:57:45

Lower 700MHz Band GSM Right Side 715.8MHz Pre-AGC

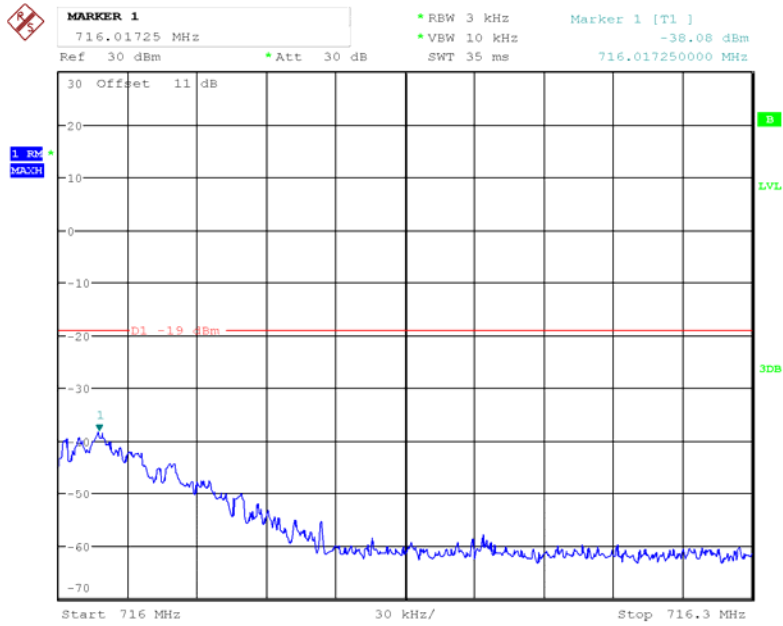

Date: 24.MAY.2018 23:52:35

Lower 700MHz Band GSM Right Side 715.8MHz Above AGC

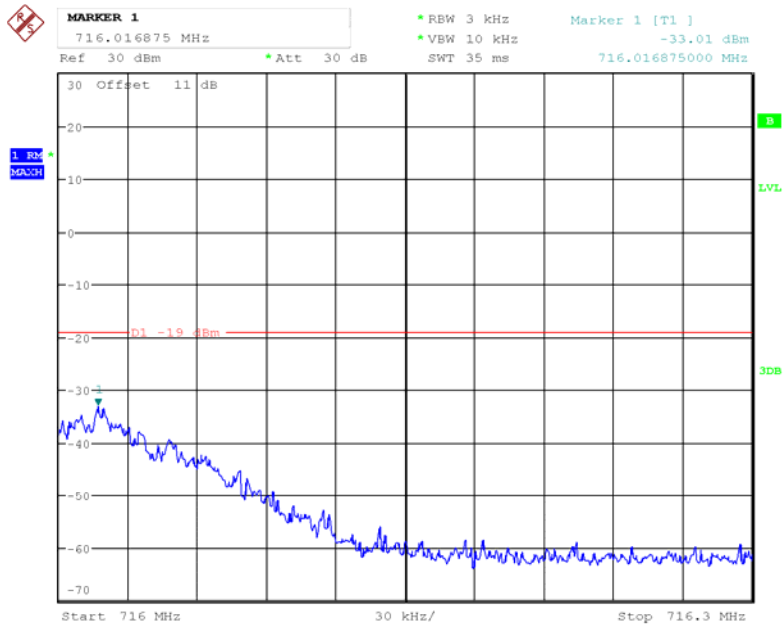

Date: 24.MAY.2018 23:53:49

Lower 700MHz Band LTE Right Side 713.5MHz Pre-AGC

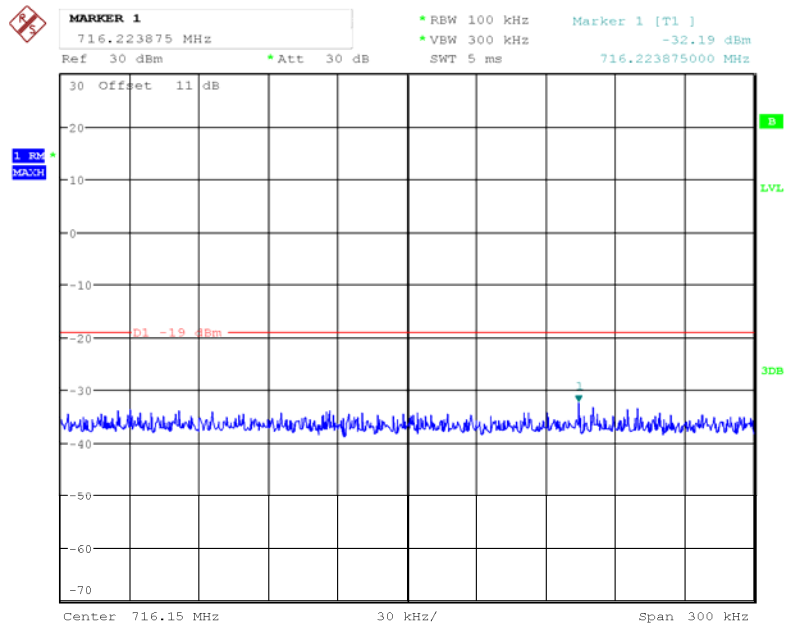

Date: 25.MAY.2018 00:04:40

Lower 700MHz Band LTE Right Side 713.5MHz Above AGC

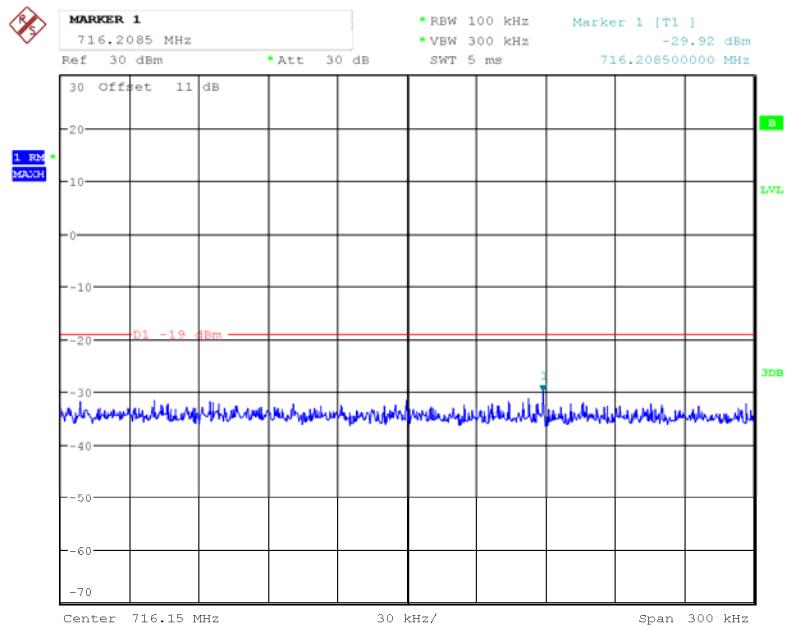

Date: 25.MAY.2018 00:05:19

§ 20.21(e)(8)(i)(A), § 20.21(e)(8)(i)(H) & §20.21(e)(4) - NOISE LIMITS

Applicable Standards

According to § 20.21(e)(8)(i)(A) Noise Limits; § 20.21(e)(8)(i)(H) Transmit Power Off Mode (uplink and downlink noise power); §20.21(e)(4) Self-monitoring.

Test Procedure

Maximum transmitter noise power level

- a) Connect the EUT to the test equipment as shown in **Figure 3**. Begin with the uplink output connected to the spectrum analyzer. When measuring downlink noise, connect the downlink output to the spectrum analyzer.
- b) Set the spectrum analyzer RBW to 1 MHz with the VBW $\geq 3 \times$ RBW.
- c) Select the power averaging (RMS) detector and trace average over at least 100 traces.
- d) Set the center frequency of the spectrum analyzer to the center of the CMRS band under test with the span $\geq 2 \times$ the CMRS band.
- e) Measure the maximum transmitter noise power level.
- f) Save the spectrum analyzer plot as necessary for inclusion in the final test report.
- g) Repeat 7.7b) to 7.7f) for all operational uplink and downlink bands.
- h) Connect the EUT to the test equipment as shown in **Figure 4** for uplink. Affirm the coupled path of the RF coupler is connected to the spectrum analyzer.
- i) Configure the signal generator for 4.1 MHz AWGN operation.
- j) Set the spectrum analyzer RBW for 1 MHz with the VBW $\geq 3 \times$ RBW with a power averaging (rms) detector with at least 100 trace averages.
- k) Set the center frequency of the spectrum analyzer to the center of the CMRS band under test with the span $\geq 2 \times$ the CMRS band. This shall include all spectrum blocks in the particular CMRS band under test (see Annex A).
- l) For uplink noise measurements, set the spectrum analyzer center frequency for the uplink band under test and tune the signal generator to the center of the paired downlink band.
- m) Measure the maximum transmitter noise power level when varying the downlink signal generator output level from -90 dBm to -20 dBm, as measured at the input port, in 1 dB steps inside the RSSI-dependent region and in 10 dB steps outside the RSSI-dependent region. Report the six values closest to the limit with at least two points within the RSSI-dependent region of the limit. See noise limit in Annex D.
- n) Repeat 7.7.1h) through 7.7.1m) for all operational uplink.

Variable uplink noise timing

Variable uplink noise timing is to be measured as follows.

- a) Set the spectrum analyzer to the uplink frequency to be measured.
- b) Set the span to 0 Hz with a sweep time of 10 seconds.
- c) Set the power level of signal generator 1 to the lowest level of the RSSI-dependent noise.
- d) Select MAX HOLD and increase the power level of signal generator 1 by 10 dB for mobile boosters and 20 dB for fixed boosters.
- e) Confirm that the uplink noise decreases to the specified level within 1 second for mobile devices and 3 seconds for fixed devices
- f) Repeat 7.7.2a) to 7.7.2e) for all operational uplink bands.
- g) Include plots and summary table in test report.

Note: Some signal boosters will require a signal generator input because they will not operate unless a signal is received at the input terminals. If this is the case, connect a second signal generator and cycle the RF output to simulate this function.

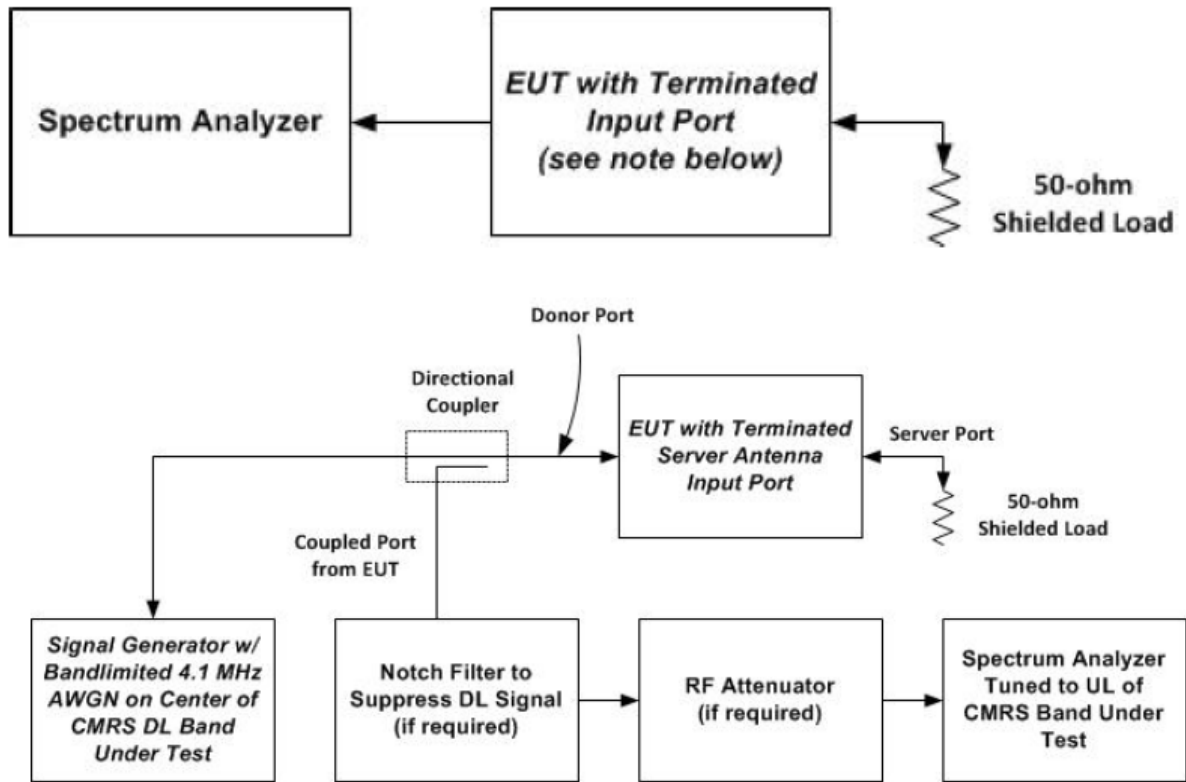

Test Data

Environmental Conditions

Temperature:	27.8~27.9 °C
Relative Humidity:	60~64 %
ATM Pressure:	100.5~100.7 kPa

The testing was performed by George Pang on 2018-05-08 and 2018-05-13.

Test Result: Compliance. Please refer to following table.

Maximum Noise:

Mode	Operation Bands	Measured Value	Limit	Result
		dBm/MHz	dBm/MHz	
Uplink	Lower 700MHz	-51.84	-45.51	Compliance
	Upper 700MHz	-54.71	-44.64	Compliance
	cellular	-53.57	-44.05	Compliance
	AWS	-52.5	-37.73	Compliance
	PCS	-53.04	-37.02	Compliance
Downlink	Lower 700MHz	-50.7	-45.51	Compliance
	Upper 700MHz	-51.82	-44.64	Compliance
	cellular	-51.79	-44.05	Compliance
	AWS	-44.69	-37.73	Compliance
	PCS	-44.24	-37.02	Compliance

Note: Fixed booster maximum noise power shall not exceed $-102.5 \text{ dBm/MHz} + 20 \text{ Log}_{10}(\text{Frequency})$, where Frequency is the uplink mid-band frequency of the supported spectrum bands in MHz.

Uplink Lower 700MHz Band

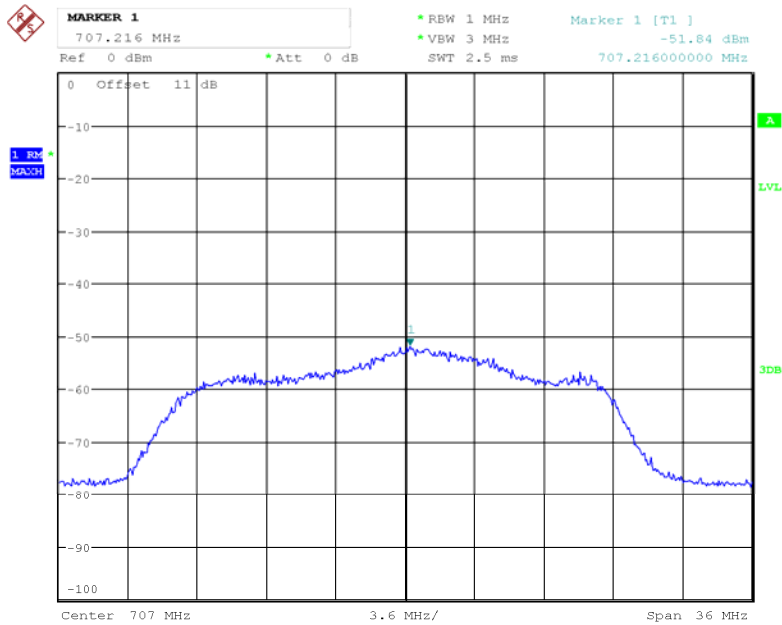

Date: 8.MAY.2018 22:04:13

Uplink Upper 700MHz Band

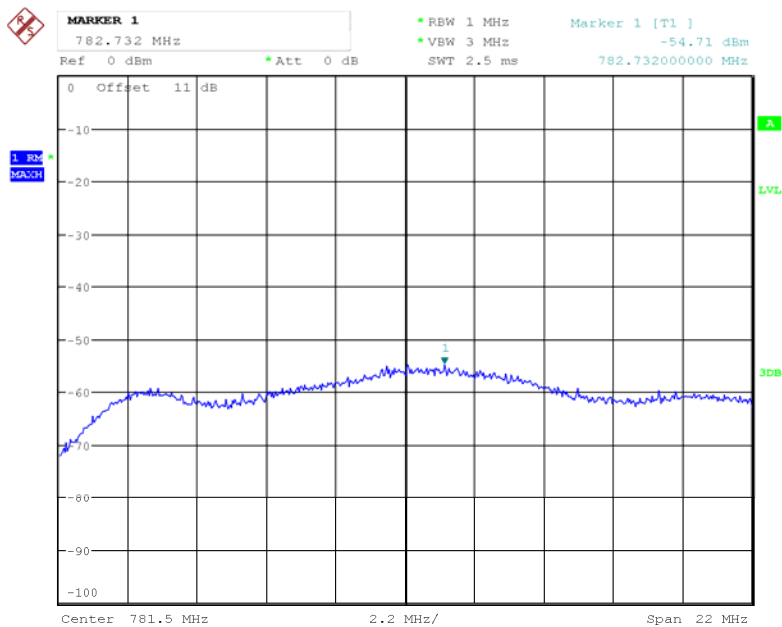

Date: 8.MAY.2018 22:06:30

Uplink Cellular Band

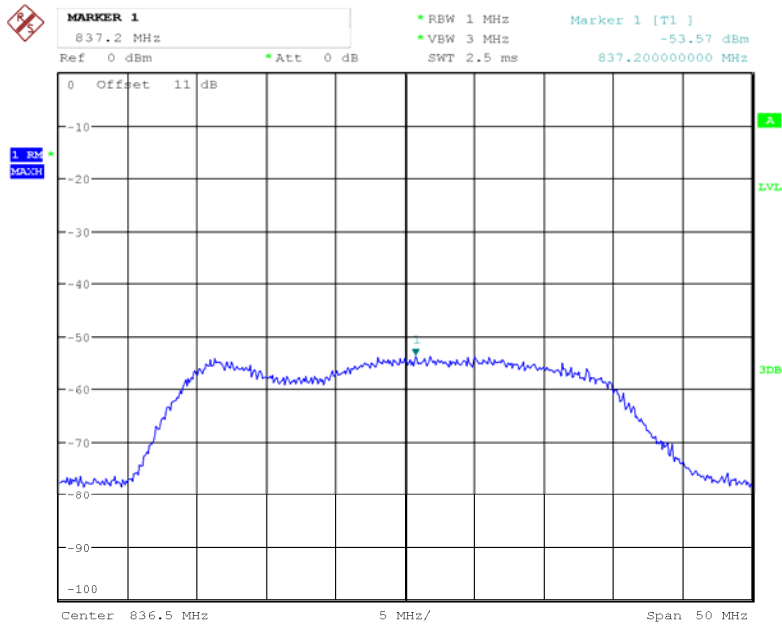

Date: 8.MAY.2018 22:07:34

Uplink AWS Band

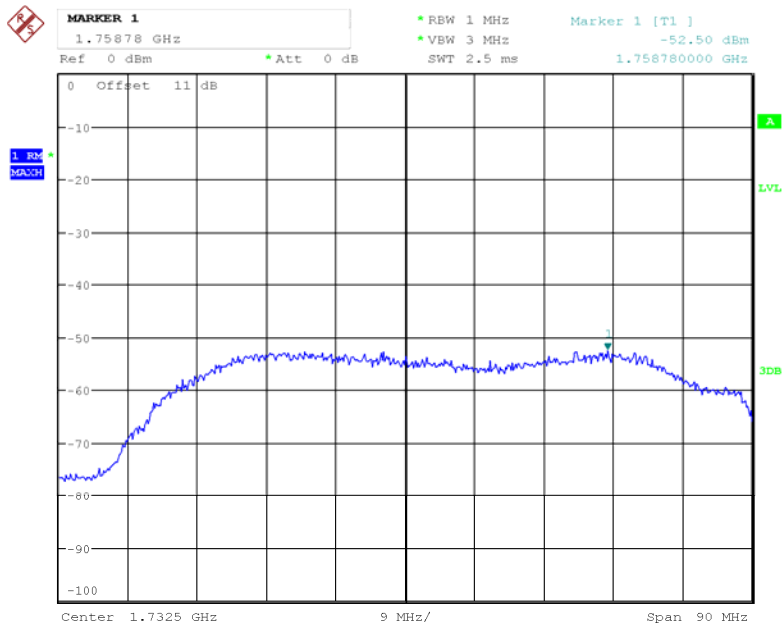

Date: 8.MAY.2018 22:08:33

Uplink PCS Band

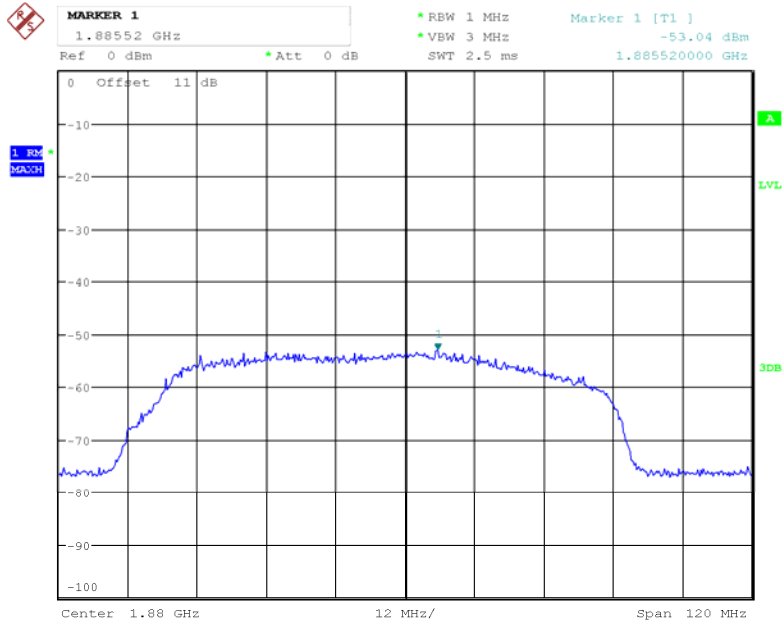

Date: 8.MAY.2018 22:02:18

Downlink LTE Lower 700MHz Band

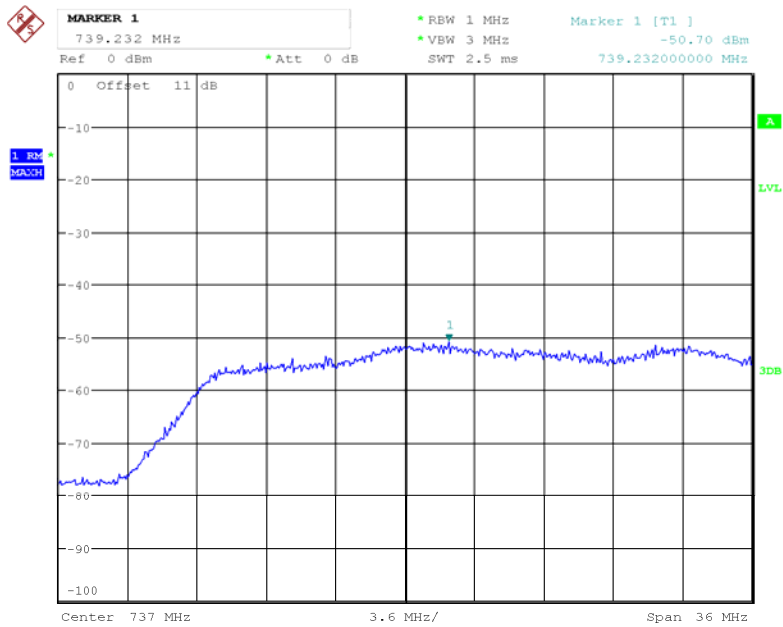

Date: 8.MAY.2018 22:11:43

Downlink LTE Upper 700MHz Band

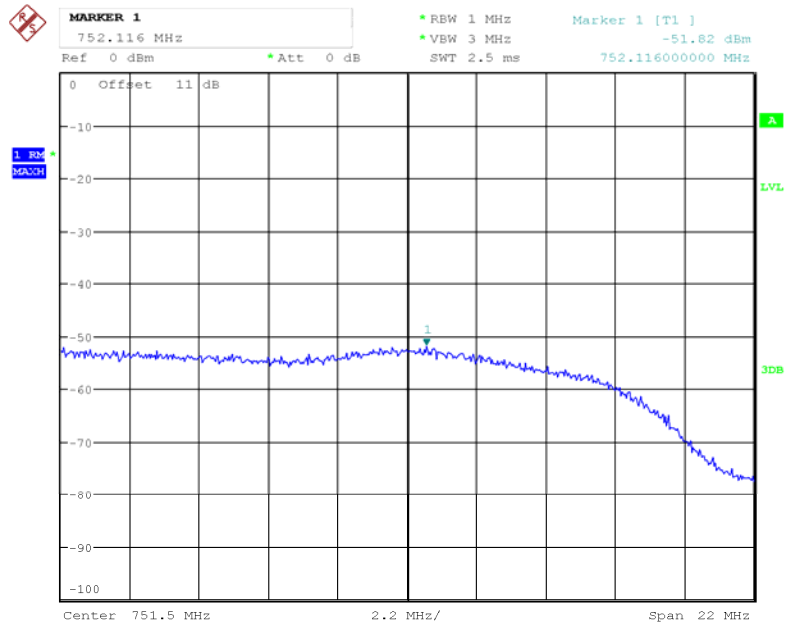

Date: 8.MAY.2018 22:16:07

Downlink Cellular Band

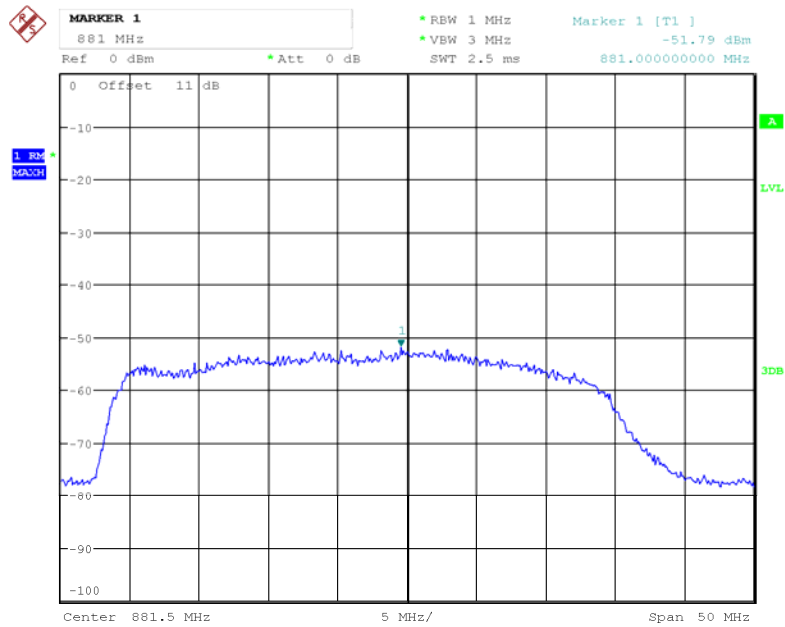

Date: 8.MAY.2018 22:17:07

Downlink AWS Band

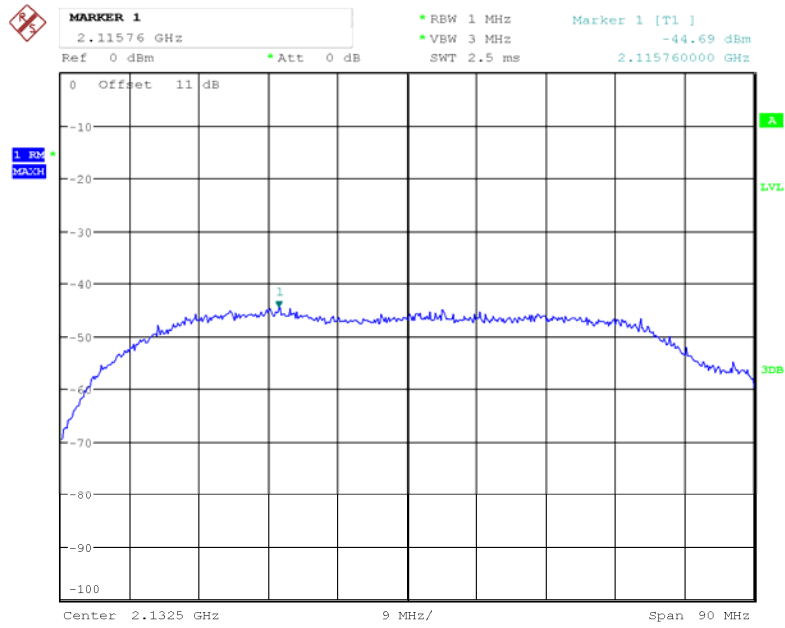

Date: 8.MAY.2018 22:19:27

Downlink PCS Band

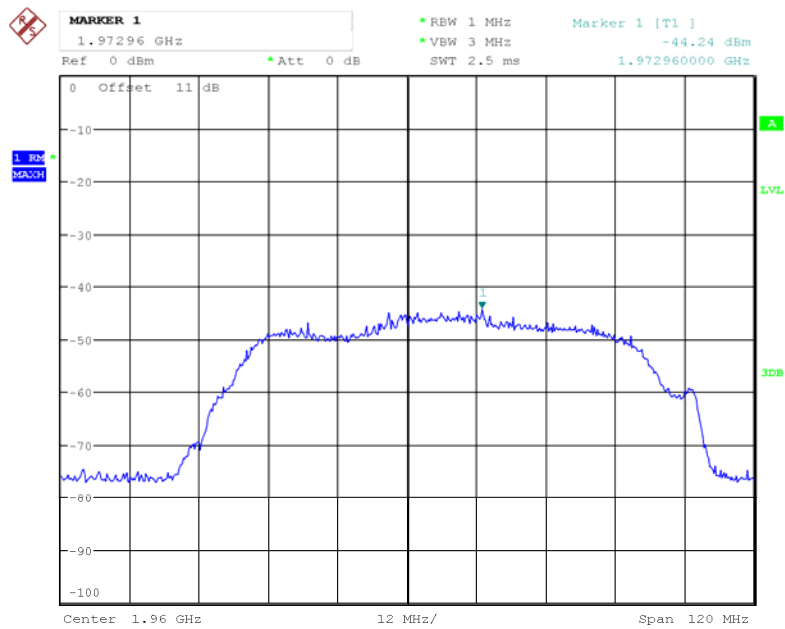

Date: 8.MAY.2018 22:18:30

Variable uplink Noise limit test result:

Operation Bands	RSSI	Measured Value	Limit	Results
	dBm	dBm/MHz	dBm/MHz	
Lower 700MHz	-90	-53.41	-45.51	Compliance
	-80	-55.62	-45.51	Compliance
	-70	-57.36	-45.51	Compliance
	-63	-62.33	-40.00	Compliance
	-62	-62.97	-41.00	Compliance
	-61	-62.71	-42.00	Compliance
Upper 700MHz	-90	-54.97	-44.64	Compliance
	-80	-58.33	-44.64	Compliance
	-70	-60.98	-44.64	Compliance
	-63	-65.42	-40.00	Compliance
	-62	-65.82	-41.00	Compliance
	-61	-66.09	-42.00	Compliance
cellular	-90	-54.66	-44.05	Compliance
	-80	-59.62	-44.05	Compliance
	-70	-62.27	-44.05	Compliance
	-63	-66.52	-40.00	Compliance
	-62	-66.89	-41.00	Compliance
	-61	-67.22	-42.00	Compliance
AWS	-90	-53.87	-37.73	Compliance
	-80	-57.93	-37.73	Compliance
	-70	-60.27	-37.73	Compliance
	-63	-66.38	-40.00	Compliance
	-62	-66.48	-41.00	Compliance
	-61	-66.63	-42.00	Compliance
PCS	-90	-54.52	-37.02	Compliance
	-80	-59.65	-37.02	Compliance
	-70	-62.24	-37.02	Compliance
	-63	-66.49	-40.00	Compliance
	-62	-66.89	-41.00	Compliance
	-61	-67.10	-42.00	Compliance

According to KDB 935210 D03 Signal Booster Measurements v04 Annex D, the Variable uplink Noise limit is -103 dBm – RSSI in RSSI-Dependent Region, out of RSSI RSSI-Dependent Region, it is -102.5 dBm/MHz + 20 Log10 (Frequency).

Variable Uplink Noise Timing:

Operating Band	Measured Value	Limit	Results
	s	s	
Lower 700MHz	0.05	3	Compliance
Upper 700MHz	0.10	3	Compliance
Cellular	0.11	3	Compliance
AWS	0.08	3	Compliance
PCS	0.30	3	Compliance

Note: The uplink noise decreases to the specified level within 1 second for mobile devices and 3 seconds for fixed devices.

Lower 700MHz Band

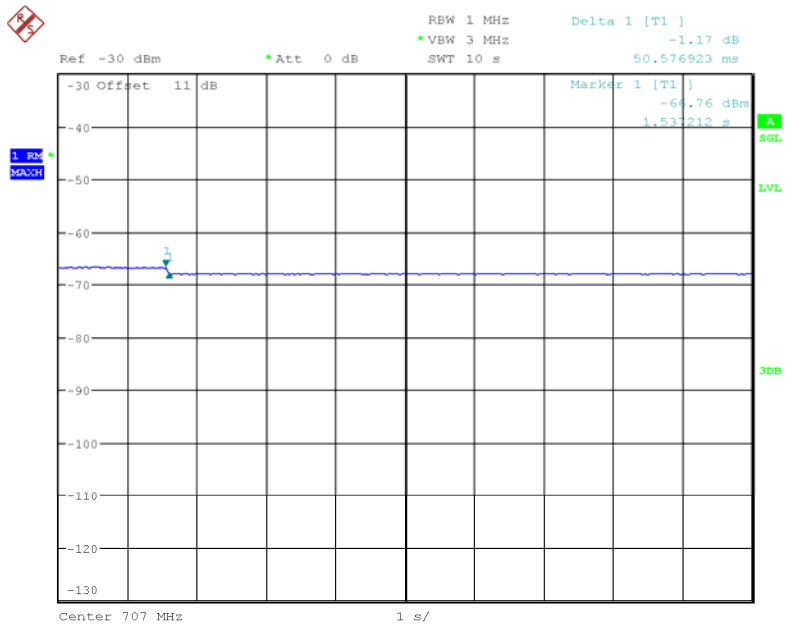

Date: 13.MAY.2018 13:46:54

Upper 700MHz Band

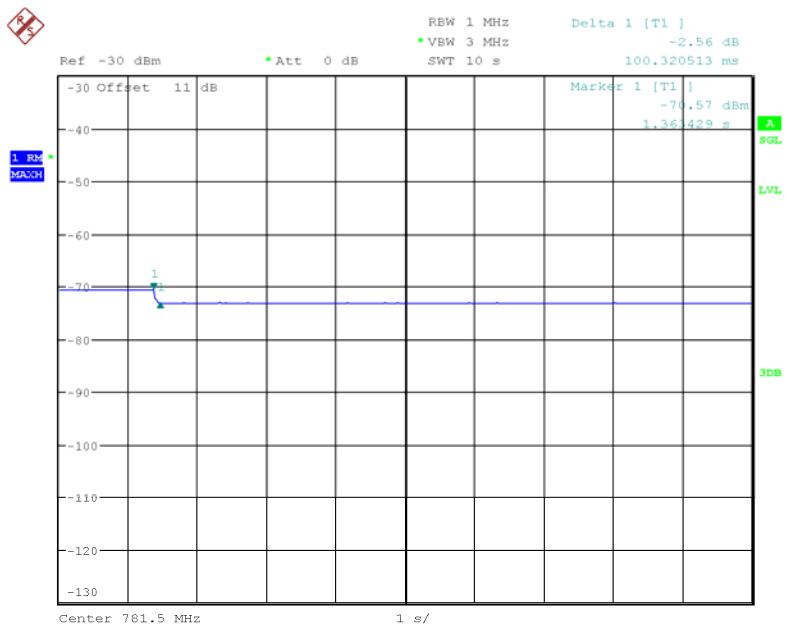

Date: 13.MAY.2018 13:34:12

Cellular Band

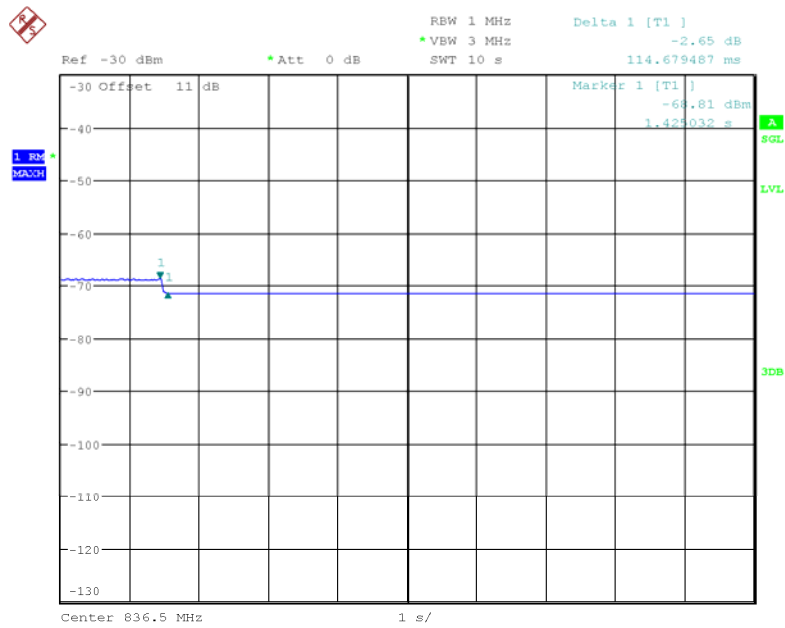

Date: 13.MAY.2018 14:08:50

AWS Band

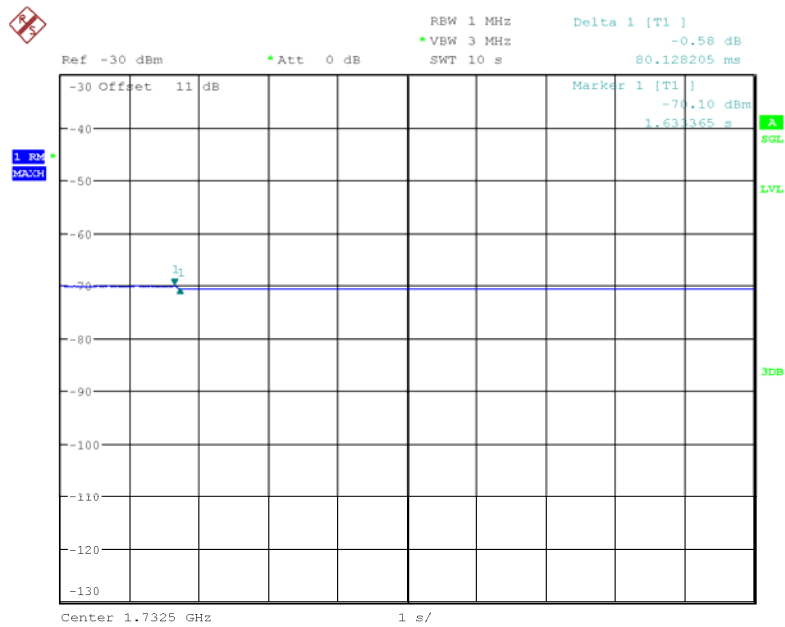

Date: 13.MAY.2018 14:26:08

PCS Band

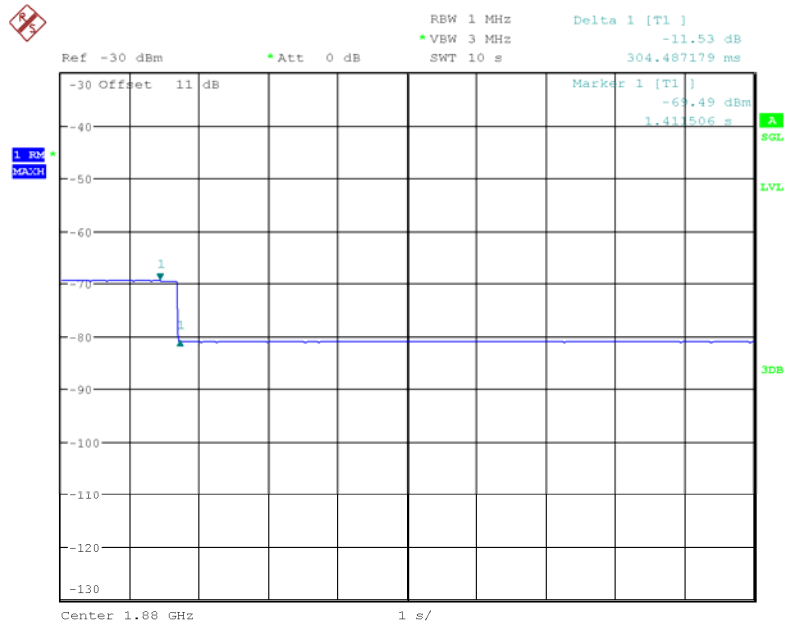

Date: 13.MAY.2018 14:58:29

§ 20.21(e)(8)(i)(I) & §20.21(e)(4) - UPLINK INACTIVITY

Applicable Standards

According to § 20.21(e)(8)(i)(I) Uplink Inactivity & §20.21(e)(4); §20.21(e)(4) Self-monitoring.

Test Procedure

This measurement procedure is intended to demonstrate compliance to the uplink inactivity requirements specified for wideband consumer signal boosters in § 20.21(e)(8)(i)(I).

- Connect the EUT to the test equipment as shown in **Figure 3** with the uplink output connected to the spectrum analyzer.
- Select the RMS power averaging detector.
- Set the spectrum analyzer RBW for 1 MHz with the $VBW \geq 3 \times RBW$.
- Set the center frequency of the spectrum analyzer to the center of the uplink operational band.
- Set the span for 0 Hz with a single sweep time for a minimum of 700 seconds.
- Start to capture a new trace using MAX HOLD.
- After approximately 15 seconds turn on the EUT power.
- Once the full spectrum analyzer trace is complete place a MARKER on the leading edge of the pulse and use the DELTA MARKER METHOD to measure the time until the uplink becomes inactive.
- Affirm that the noise level for the squelched signal is below the uplink inactivity noise power limit, as specified by the rules.
- Capture the plot for inclusion in the test report.
- Measure noise using procedures in 7.7.1a) to 7.7.1f).
- Repeat 7.8d) through 7.8k) for all operational uplink bands.

Note: Some signal boosters will require a signal generator input because they will not operate unless a signal is received at the input terminals. If this is the case, connect a signal generator and cycle the RF output to simulate this function.

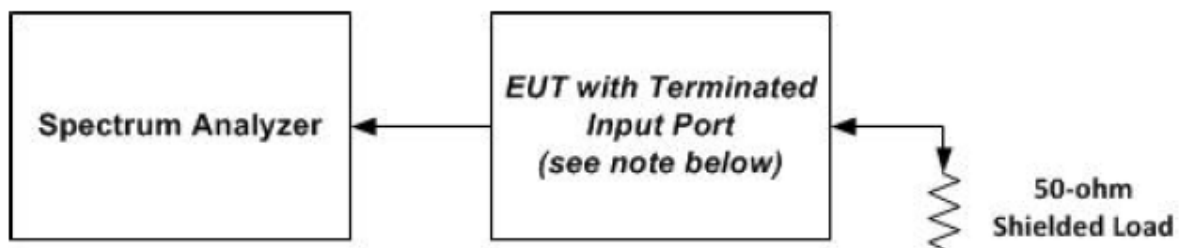

Test Data

Environmental Conditions

Temperature:	26.6~27.2 °C
Relative Humidity:	56~66 %
ATM Pressure:	101.1~101.5 kPa

The testing was performed by George Pang on 2018-06-28.

Test Result: Compliance. Please refer to following table.

Operation Band	Measured value	Limit	Result
	s	s	
Lower 700MHz	284.37	300	Compliance
Upper 700MHz	284.37		Compliance
Cellular	285.61		Compliance
AWS	282.24		Compliance
PCS	282.24		Compliance

Note: When the consumer booster is not serving an active device connection after 5 minutes the uplink noise power not exceed -70 dBm/MHz.

Lower 700MHz Band

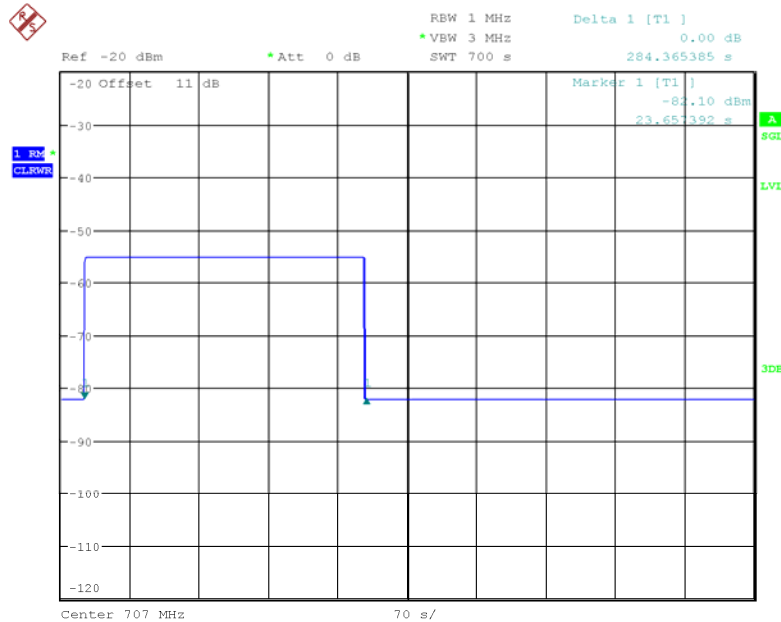

Date: 28.JUN.2018 22:29:37

Upper 700MHz Band

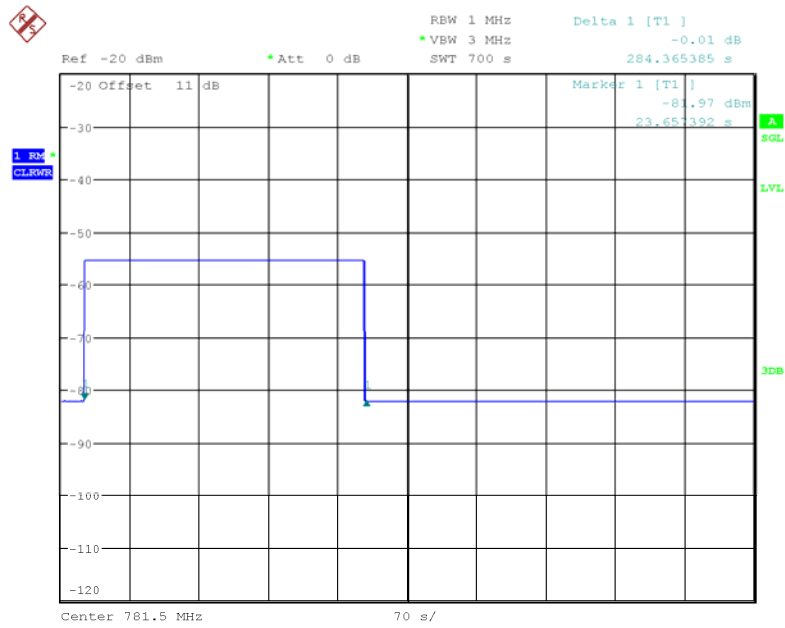

Date: 28.JUN.2018 22:44:26

Cellular Band

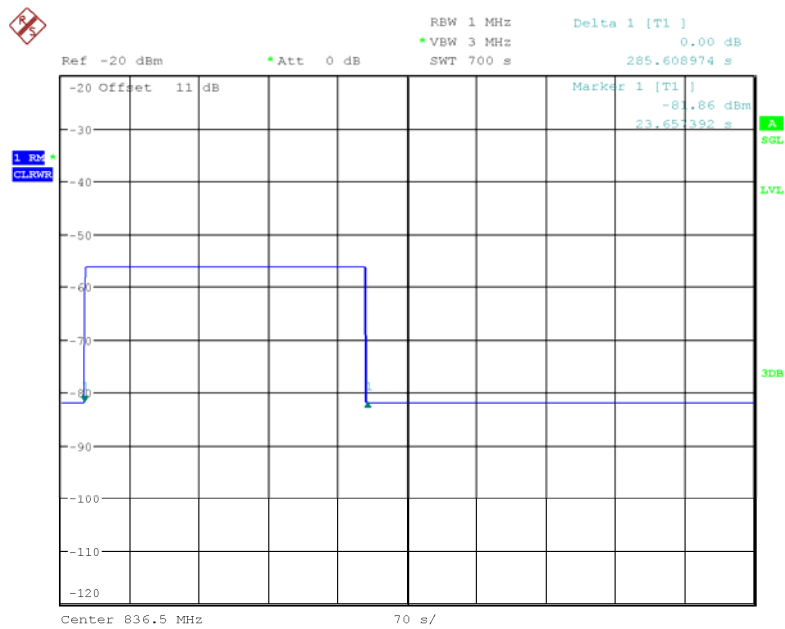

Date: 28.JUN.2018 21:31:39

AWS Band

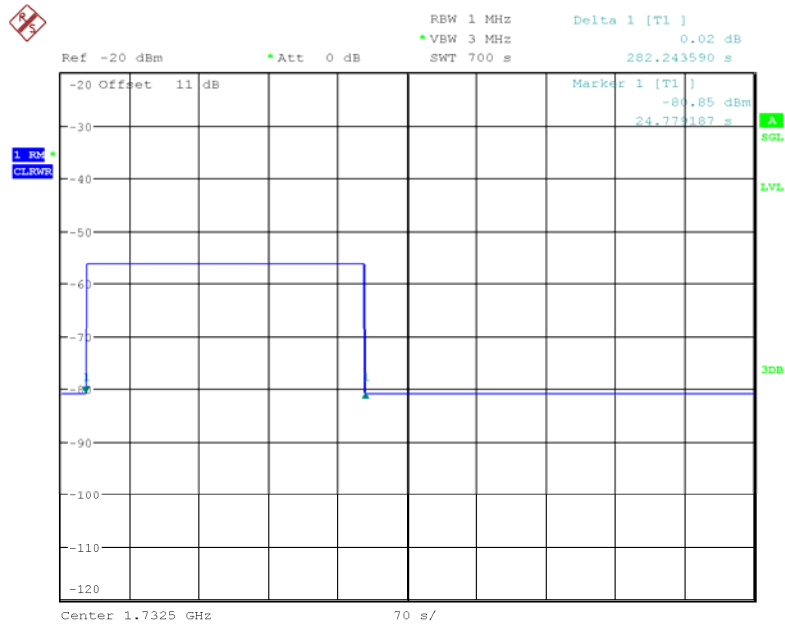

Date: 28.JUN.2018 23:29:53

PCS Band

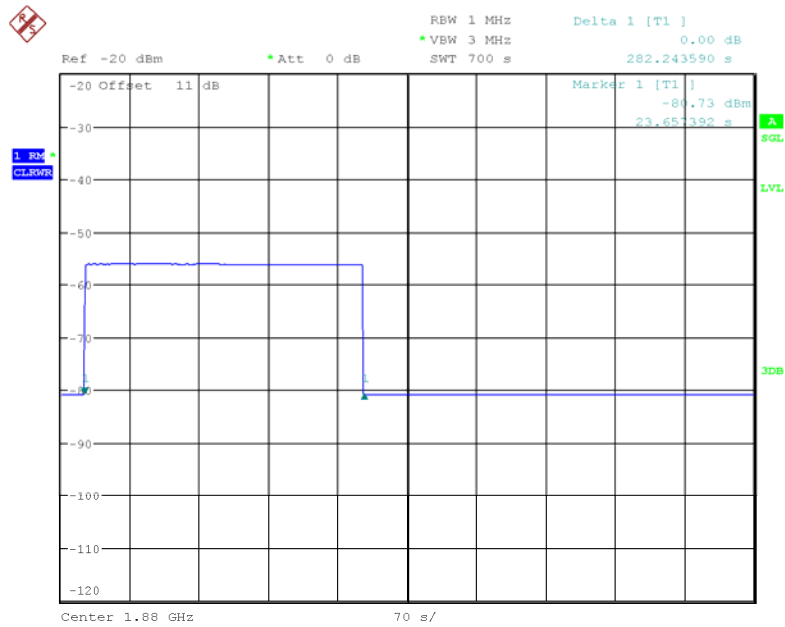

Date: 28.JUN.2018 20:48:21

§ 20.21(e)(8)(i)(C)(1) & § 20.21(e)(8)(i)(H) - VARIABLE BOOSTER GAIN

Applicable Standards

Rule paragraph(s): § 20.21(e)(8)(i)(C)(1) *Booster Gain Limits* (variable gain); § 20.21(e)(8)(i)(H) *Transmit Power Off Mode* (uplink gain).

Test Procedure

Maximum gain

This procedure shall be used to demonstrate compliance to the booster gain limits specified for wideband consumer signal boosters in § 20.21(e)(8)(i)(C) or § 20.21(e)(8)(i)(H). The variable booster gain limits are expressed as a function of RSSI and MSCL. The RSSI is varied over a range of values as specified within the procedure. Refer to Annex B of this document for guidance on determining the applicable MSCL value.

- a) Connect the EUT to the test equipment as shown in **Figure 5** with the uplink output connected to signal generator 1. Confirm that the coupled path of the RF coupler is connected to the spectrum analyzer.
- b) Configure downlink signal generator 1 for AWGN operation with a 99% occupied bandwidth of 4.1 MHz tuned to the center of the operational band.
- c) Set the power level and frequency of signal generator 2 to a value 5 dB below the AGC level determined from 7.2. The signal type is AWGN with a 99% OBW of 4.1 MHz.
- d) Set RBW = 100 kHz.
- e) Set VBW \geq 300 kHz.
- f) Select the CHANNEL POWER measurement mode.
- g) Select the RMS (power averaging) detector.
- h) Ensure that the number of measurement points per sweep $\geq (2 \times \text{span})/\text{RBW}$.
- i) Sweep time = auto couple or as necessary (but no less than auto couple value).
- j) Trace average at least 10 traces in power averaging (i.e., RMS) mode.
- k) Measure the maximum channel power and compute maximum gain when varying the signal generator 1 output to a level from -90 dBm to -20 dBm as measured at the input port in 1 dB steps inside the RSSI-dependent region and 10 dB steps outside the RSSI-dependent region and report the six values closest to the limit, including at least two points from within the RSSI-dependent region of operation. See gain limit in charts in Annex D for uplink gain requirements. Additionally, document that the EUT provides equivalent uplink and downlink gain, and when operating in shutoff mode the uplink and downlink gain is within the transmit power off mode gain limits.
- l) Repeat 7.9.1b) to 7.9.1k) for all operational uplink bands.

Variable uplink gain timing

Variable uplink gain timing is to be measured as follows.

- a) Set the spectrum analyzer to the uplink frequency to be measured.
- b) Set the span to 0 Hz with a sweep time of 10 seconds.
- c) Set the power level of signal generator 1 to the lowest level of the RSSI-dependent gain.
- d) Select MAX HOLD and increase the power level of signal generator 1 by 10 dB for mobile boosters and 20 dB for fixed indoor boosters. Signal generator 2 remains same, as described in 7.9.1c).
- e) Confirm that the uplink gain decreases to the specified levels within 1 second for mobile devices and 3 seconds for fixed devices.
- f) Repeat 7.9.2a) to 7.9.2e) for all operational uplink bands.

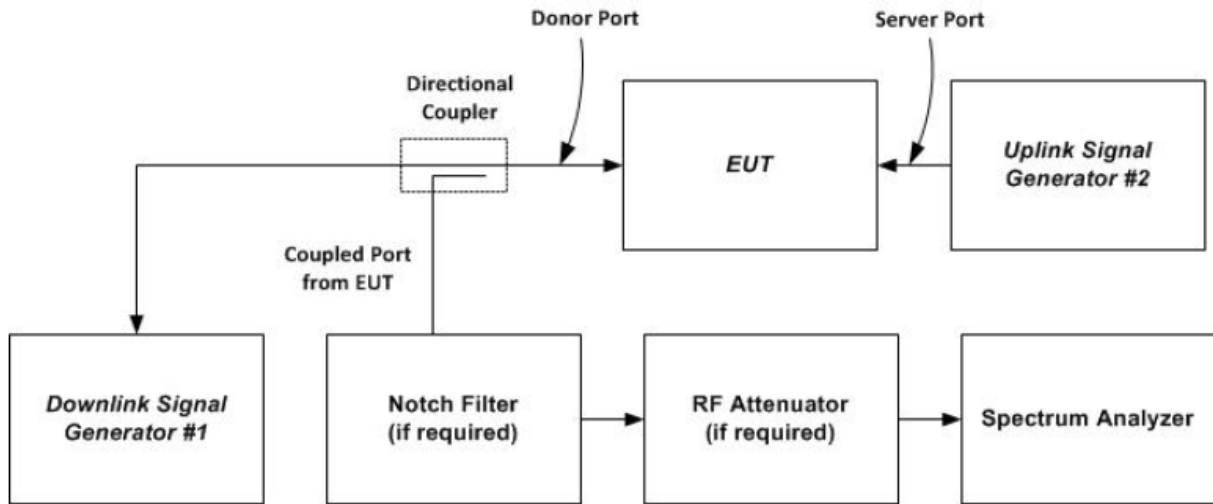

Figure 5 – Variable gain instrumentation test setup

Test Data

Environmental Conditions

Temperature:	26.6 °C
Relative Humidity:	56 %
ATM Pressure:	101.5 kPa

The testing was performed by George Pang on 2018-05-10.

Test Result: Compliance. Please refer to following table.

MSCL calculation:

Operation Bands	Frequency	Distance	Path Loss	Indoor Antenna Gain	Indoor Cable Loss	Polarity Loss	MSCL
	MHz						
Lower 700MHz	707	1.83	34.74	10	2.1	1.73	28.57
Upper 700MHz	781.5	1.83	35.61	10	2.4	1.73	29.74
Cellular	836.5	1.83	36.20	10	2.4	1.73	30.33
AWS	1745.5	1.83	42.59	10	3.0	1.73	37.32
PCS	1880	1.83	43.23	10	3.2	1.73	38.16

Note:

Path loss=20logf+20logd-27.5

Polarity loss=20log(1/sin(55))=1.73

d=6 feet=1.83m, please refer to the user manual

Variable booster gain:

Operation Bands	RSSI	P _{in}	P _{out}	MSCL	Measured Value	Limit	Result
	dBm	dBm	dBm	dB	dB	dB	
Lower 700MHz	-90	-50.8	5.53	28.45	56.33	84.45	Compliance
	-80	-50.8	5.56	28.45	56.36	74.45	Compliance
	-70	-50.8	5.2	28.45	56.00	64.45	Compliance
	-64	-50.8	0.87	28.45	51.67	58.45	Compliance
	-63	-50.8	0.07	28.45	50.87	57.45	Compliance
	-62	-50.8	0.39	28.45	51.19	56.45	Compliance
Upper 700MHz	-90	-51.3	4.94	29.32	56.24	85.32	Compliance
	-80	-51.3	4.83	29.32	56.13	75.32	Compliance
	-70	-51.3	4.17	29.32	55.47	65.32	Compliance
	-64	-51.3	3.5	29.32	54.80	59.32	Compliance
	-63	-51.3	2.51	29.32	53.81	58.32	Compliance
	-62	-51.3	1.49	29.32	52.79	57.32	Compliance
Cellular	-90	-49.3	7.5	29.91	56.80	85.91	Compliance
	-80	-49.3	7.39	29.91	56.69	75.91	Compliance
	-70	-49.3	6.79	29.91	56.09	65.91	Compliance
	-64	-49.3	5.94	29.91	55.24	59.91	Compliance
	-63	-49.3	5.29	29.91	54.59	58.91	Compliance
	-62	-49.3	4.34	29.91	53.64	57.91	Compliance
AWS	-90	-50.1	-3.09	36.6	47.01	92.6	Compliance
	-80	-50.1	-3.12	36.6	46.98	82.6	Compliance
	-70	-50.1	-3.82	36.6	46.28	72.6	Compliance
	-64	-50.1	-4.56	36.6	45.54	66.6	Compliance
	-63	-50.1	-5.17	36.6	44.93	65.6	Compliance
	-62	-50.1	-6.09	36.6	44.01	64.6	Compliance
PCS	-90	-45.2	4.21	37.24	49.41	93.24	Compliance
	-80	-45.2	4.25	37.24	49.45	83.24	Compliance
	-70	-45.2	3.24	37.24	48.44	73.24	Compliance
	-64	-45.2	2.4	37.24	47.60	67.24	Compliance
	-63	-45.2	1.54	37.24	46.74	66.24	Compliance
	-62	-45.2	0.89	37.24	46.09	65.24	Compliance

Note: Variable booster gain Limit: -34 dB-RSSI + MSCL.

Variable gain timing:

Operation Bands	Measured value	Limit	Results
MHz	s	s	
Lower 700MHz	0.11	3	Compliance
Upper 700MHz	0.14		Compliance
Cellular	0.11		Compliance
AWS	0.16		Compliance
PCS	0.14		Compliance
			Compliance

Lower 700MHz Band

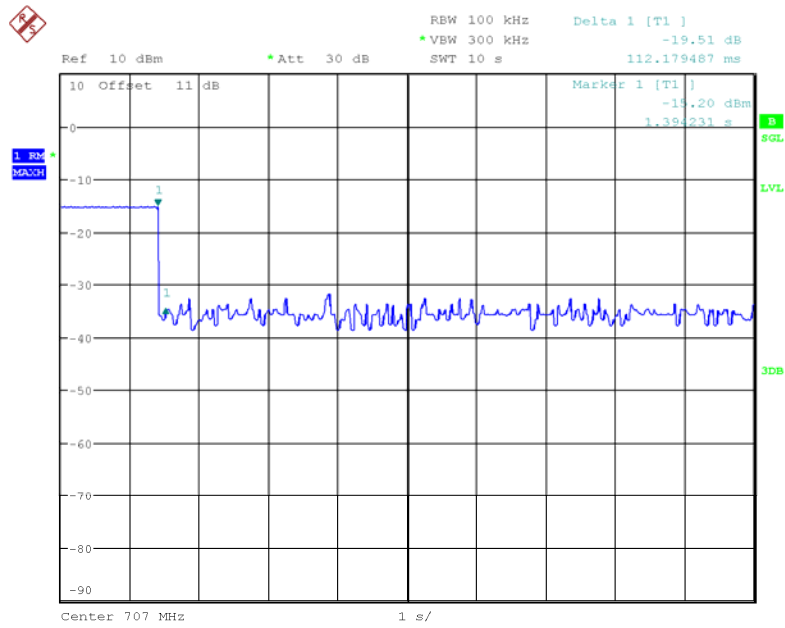

Date: 10.MAY.2018 19:45:07

Upper 700MHz Band

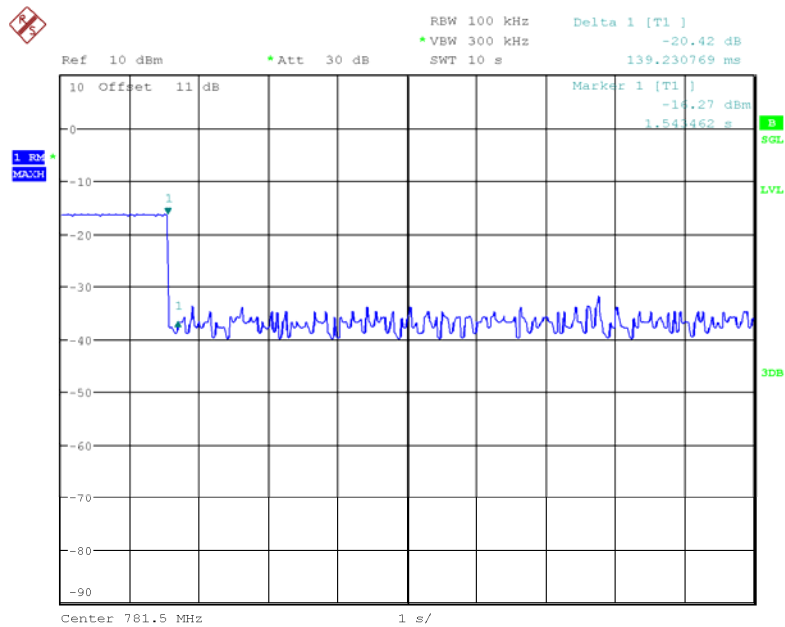

Date: 10.MAY.2018 21:15:36

Cellular Band

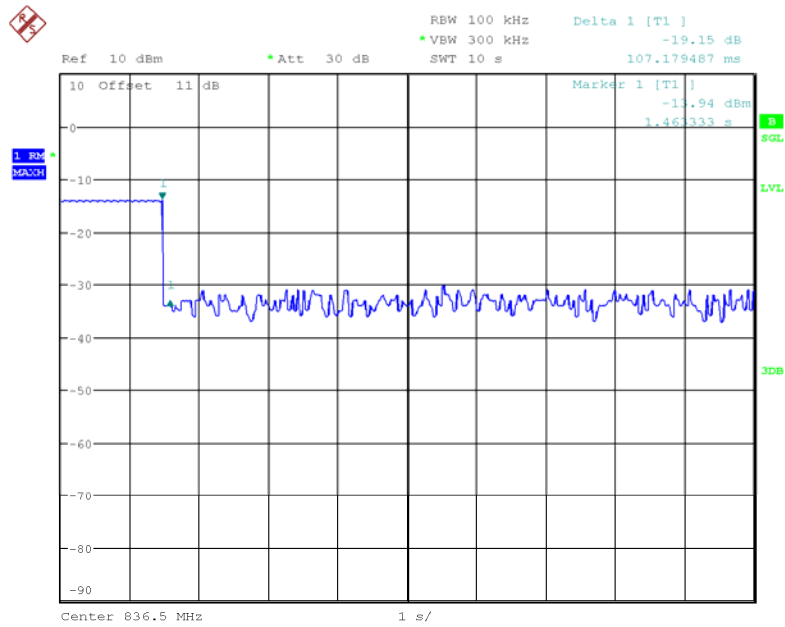

Date: 10.MAY.2018 21:00:04

AWS Band

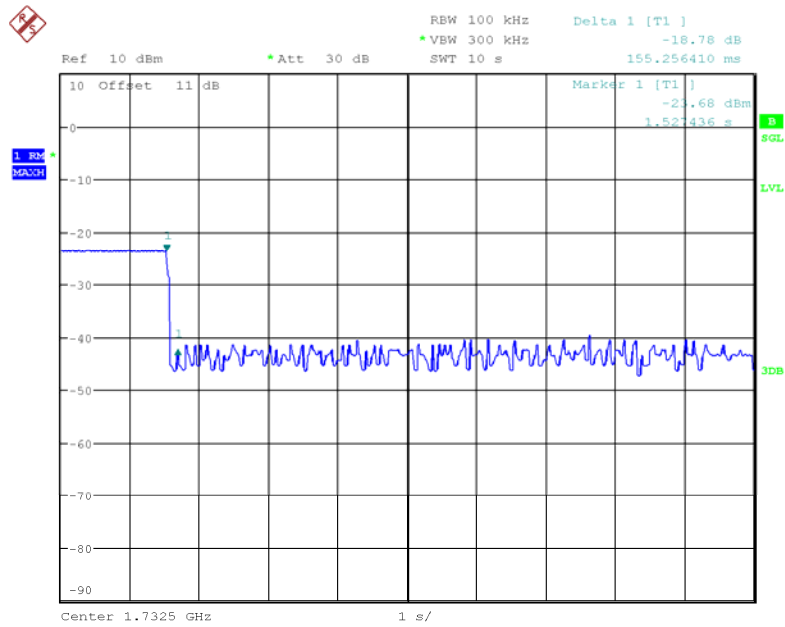

Date: 10.MAY.2018 22:00:34

PCS Band

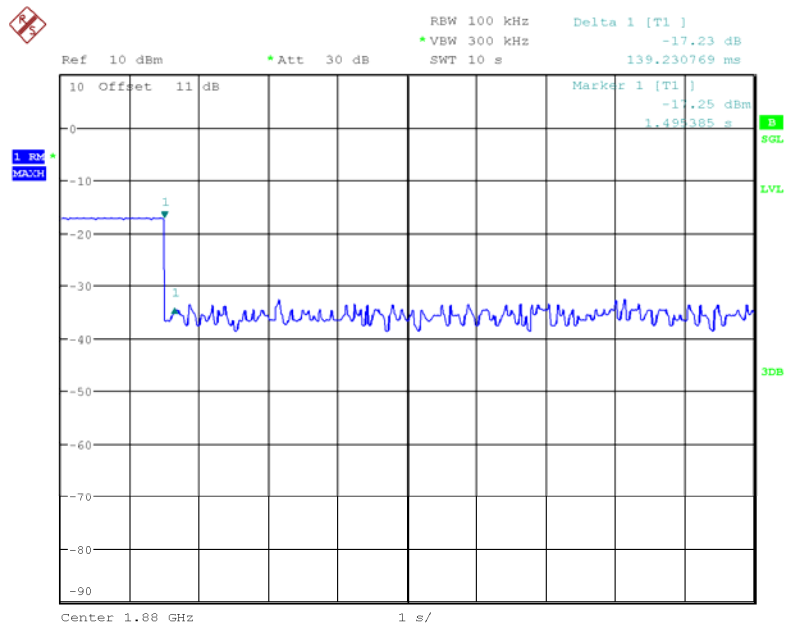

Date: 10.MAY.2018 21:41:17

§ 2.1049 - OCCUPIED BANDWIDTH

Applicable Standards

According to § 2.1049 Measurements required: Occupied bandwidth.

Test Procedure

This measurement is required to compare the uniformity of the output signal relative to the input signal and to satisfy the requirements of § 2.1049.

- a) Connect the test equipment as shown in **Figure 6** to measure the characteristics of the test signals produced by the signal generator.
- b) Set VBW to $\geq 3 \times \text{RBW}$.
- c) Set the center frequency of the spectrum analyzer to the center of the operational band. The span will be adjusted for each modulation type and occupied bandwidth as necessary for accurately viewing the signals.
- d) Set the signal generator for power level to match the values obtained in 7.2.
- e) Set the signal generator modulation type for GSM with a PRBS pattern and allow the trace on the signal generator to stabilize adjusting the span as necessary.
- f) Set the spectrum analyzer RBW for 1% to 5% of the emissions bandwidth.
- g) Capture the spectrum analyzer trace for inclusion in the test report.
- h) Repeat 7.10c) to 7.10g) for CDMA and W-CDMA modulation adjusting the span as necessary for all uplink and downlink operational bands. AWGN or LTE may be used in place of W-CDMA, as an option.
- i) Connect the test equipment as shown in **Figure 1**. Begin with the uplink output connected to the spectrum analyzer.
- j) Repeat 7.10c) to 7.10h) in this new configuration.

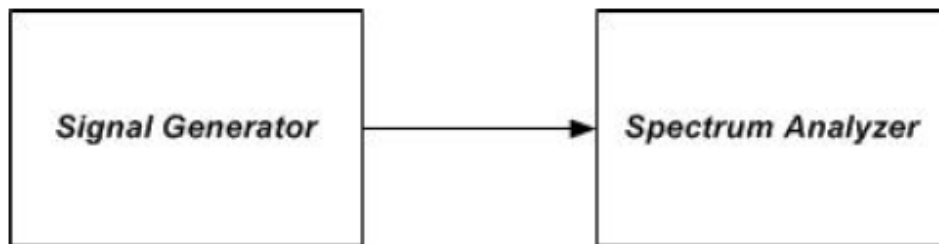

Figure 6 – Occupied bandwidth instrumentation test setup

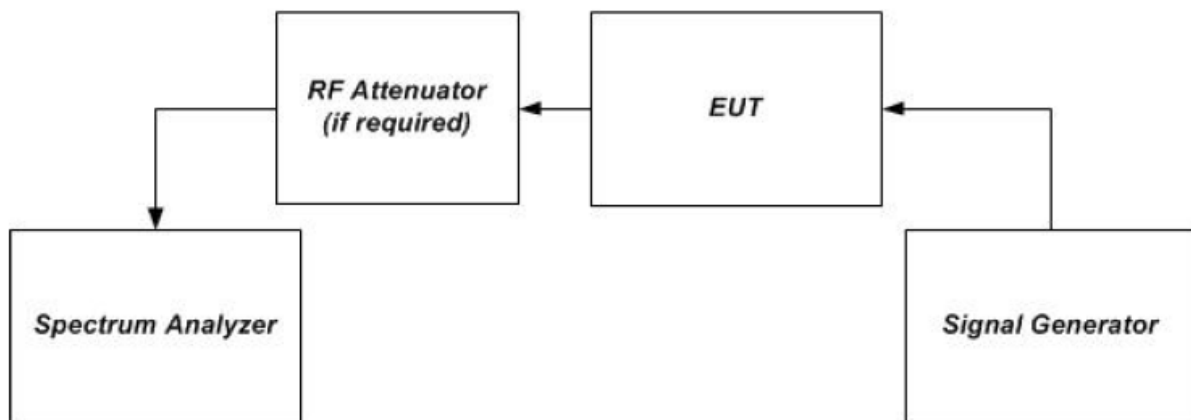

Figure 1 – Band verification test instrumentation setup

Test Data

Environmental Conditions

Temperature:	26.4 °C
Relative Humidity:	56 %
ATM Pressure:	101.8 kPa

The testing was performed by George Pang on 2018-05-30.

Test Result: Compliance. Please refer to following table.

Input-versus-output signal comparison

Mode	Operation Band	Signal type	Input	Output	Results
			MHz	MHz	
Uplink	Lower 700MHz	AWGN	4.13	4.11	Compliance
		CDMA	1.26	1.27	Compliance
		GSM	0.25	0.25	Compliance
	Upper 700MHz	AWGN	4.13	4.14	Compliance
		CDMA	1.26	1.27	Compliance
		GSM	0.25	0.25	Compliance
	Cellular	AWGN	4.14	4.15	Compliance
		CDMA	1.27	1.27	Compliance
		GSM	0.25	0.25	Compliance
	AWS	AWGN	4.13	4.16	Compliance
		CDMA	1.26	1.27	Compliance
		GSM	0.25	0.25	Compliance
PCS	AWGN	4.13	4.13	Compliance	
	CDMA	1.27	1.26	Compliance	
	GSM	0.25	0.25	Compliance	
Downlink	Lower 700MHz	AWGN	4.18	4.13	Compliance
		CDMA	1.27	1.26	Compliance
		GSM	0.25	0.25	Compliance
	Upper 700MHz	AWGN	4.13	4.11	Compliance
		CDMA	1.27	1.26	Compliance
		GSM	0.25	0.25	Compliance
	Cellular	AWGN	4.15	4.14	Compliance
		CDMA	1.27	1.26	Compliance
		GSM	0.25	0.25	Compliance
	AWS	AWGN	4.16	4.14	Compliance
		CDMA	1.27	1.26	Compliance
		GSM	0.25	0.25	Compliance
	PCS	AWGN	4.18	4.13	Compliance
		CDMA	1.27	1.26	Compliance
		GSM	0.25	0.25	Compliance

Uplink, 707MHz -AWGN(Input)

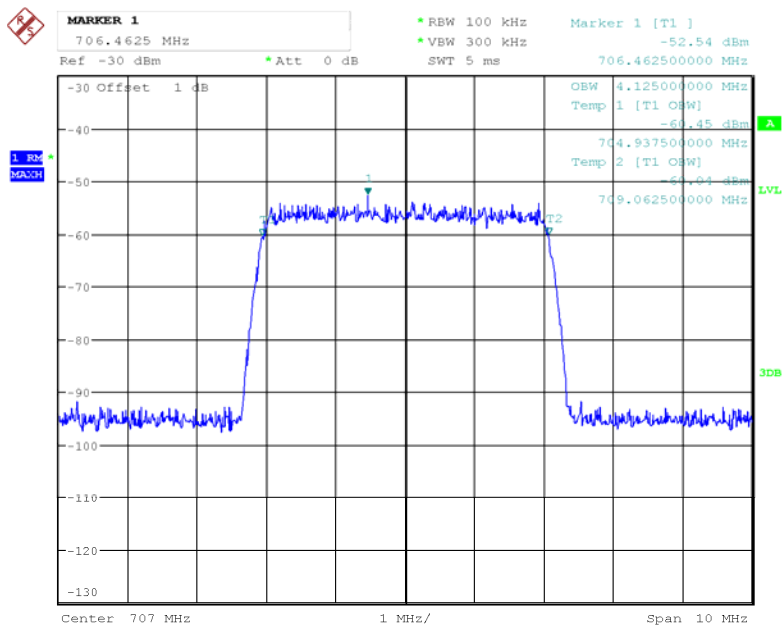

Date: 30.MAY.2018 21:13:25

Uplink, 707MHz -AWGN(Output)

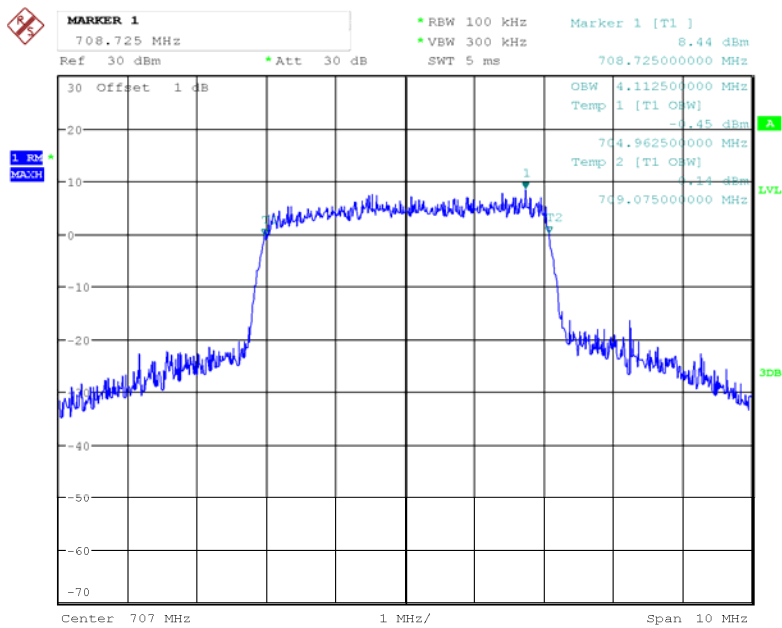

Date: 30.MAY.2018 20:44:26

Uplink, 707MHz -CDMA(Input)

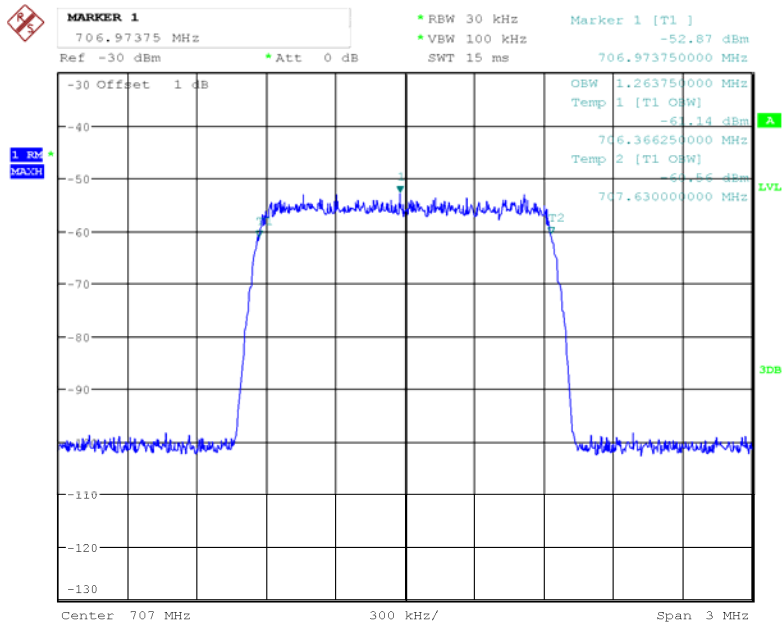

Date: 30.MAY.2018 21:12:41

Uplink, 707MHz -CDMA(Output)

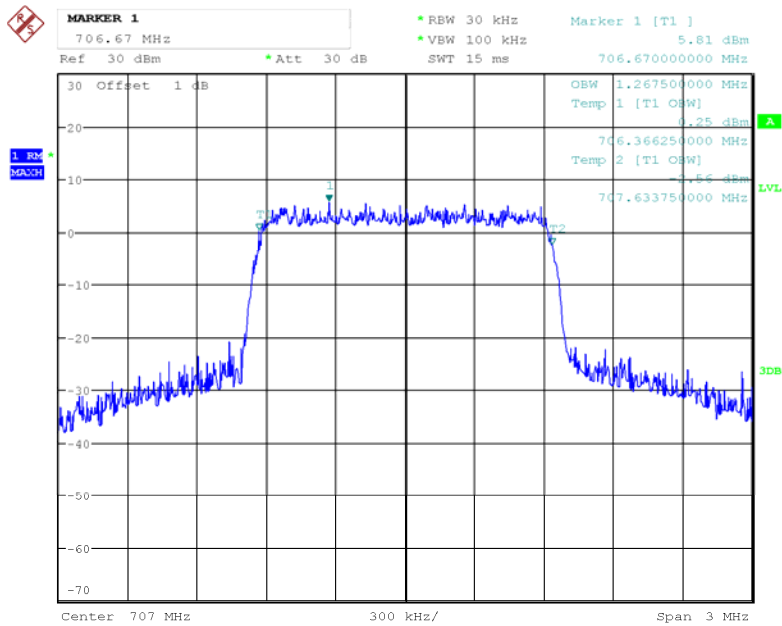

Date: 30.MAY.2018 20:45:04

Uplink, 707MHz -GSM(Input)

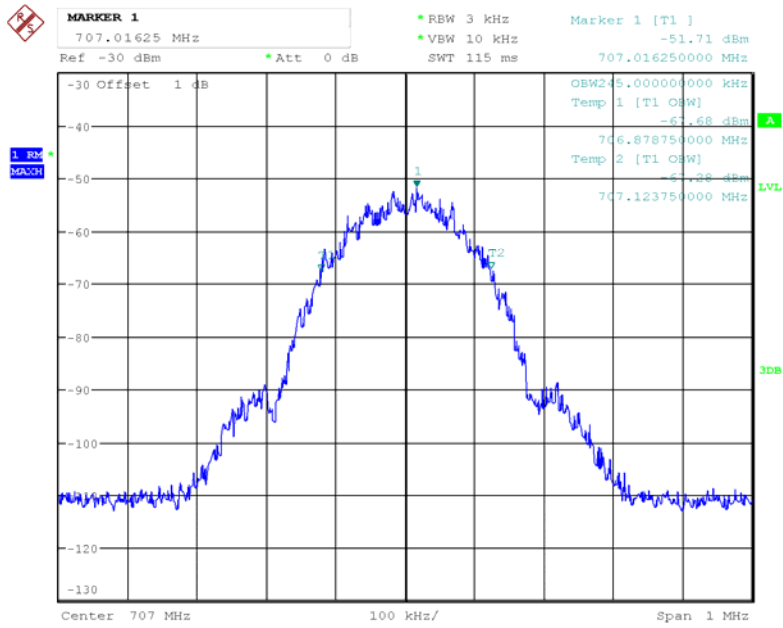

Date: 30.MAY.2018 21:14:22

Uplink, 707MHz -GSM(Output)

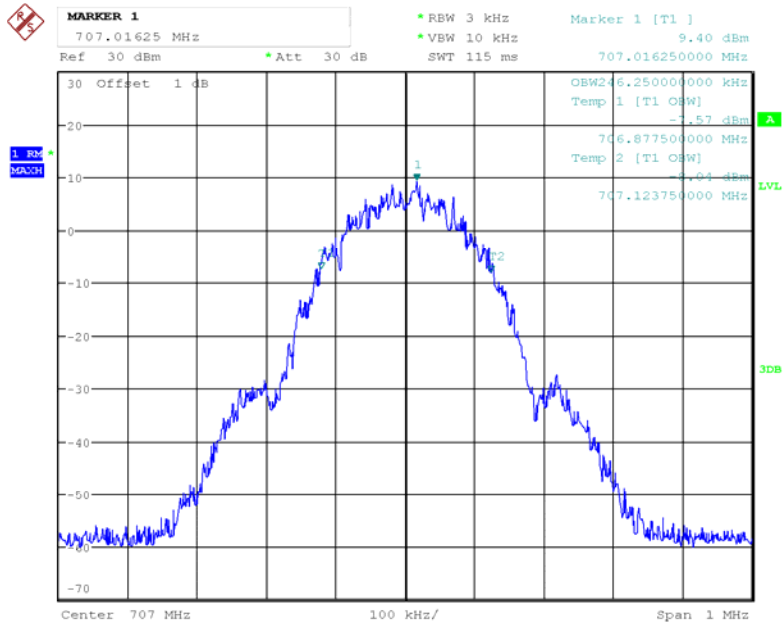

Date: 30.MAY.2018 20:43:37

Uplink, 781.5MHz -AWGN(Input)

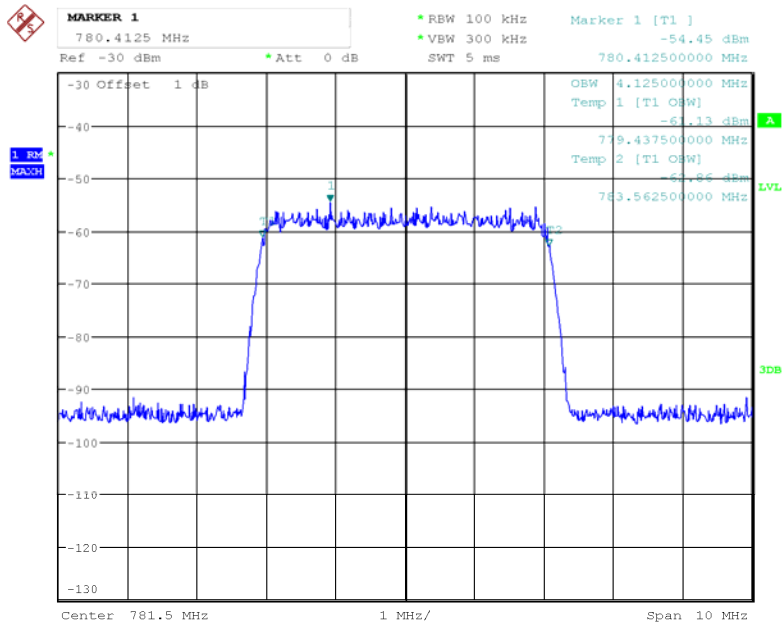

Date: 30.MAY.2018 21:16:54

Uplink, 781.5MHz -AWGN(Output)

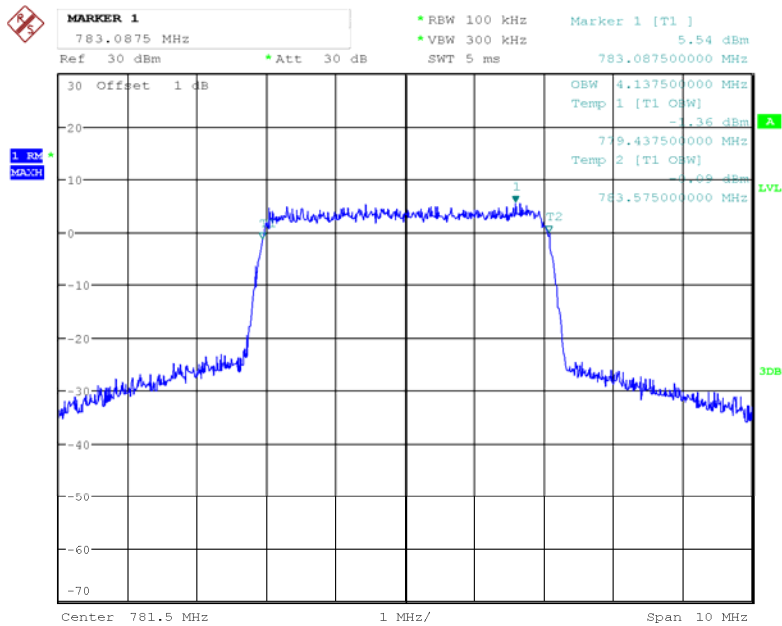

Date: 30.MAY.2018 20:52:17

Uplink, 781.5MHz -CDMA(Input)

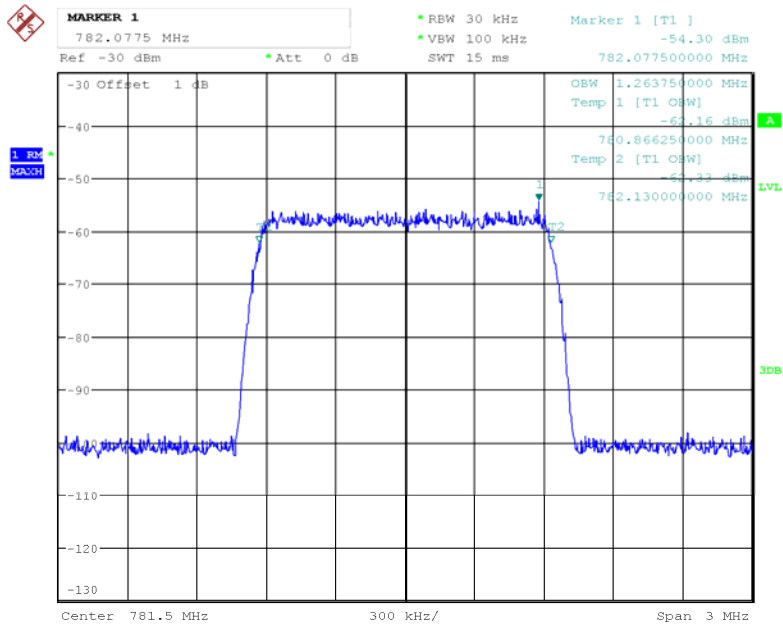

Date: 30.MAY.2018 21:17:56

Uplink, 781.5MHz -CDMA(Output)

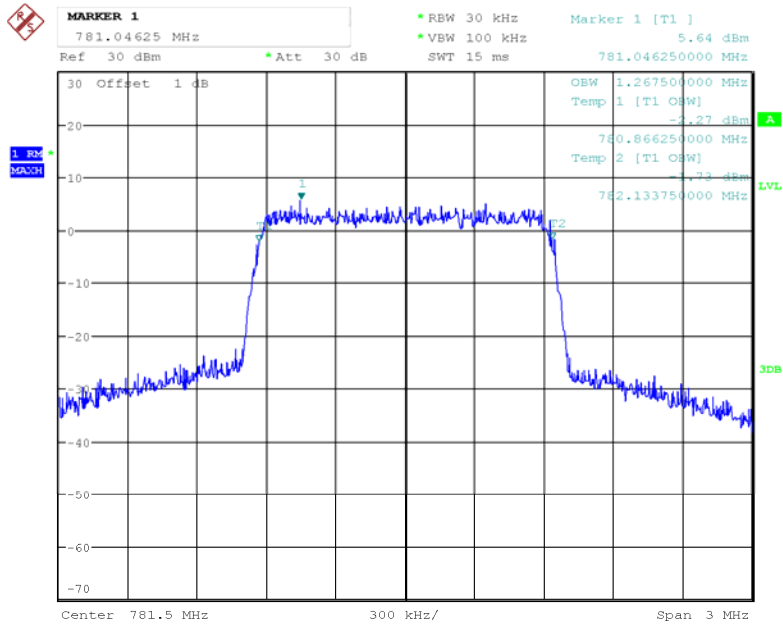

Date: 30.MAY.2018 20:46:26

Uplink, 781.5MHz -GSM(Input)

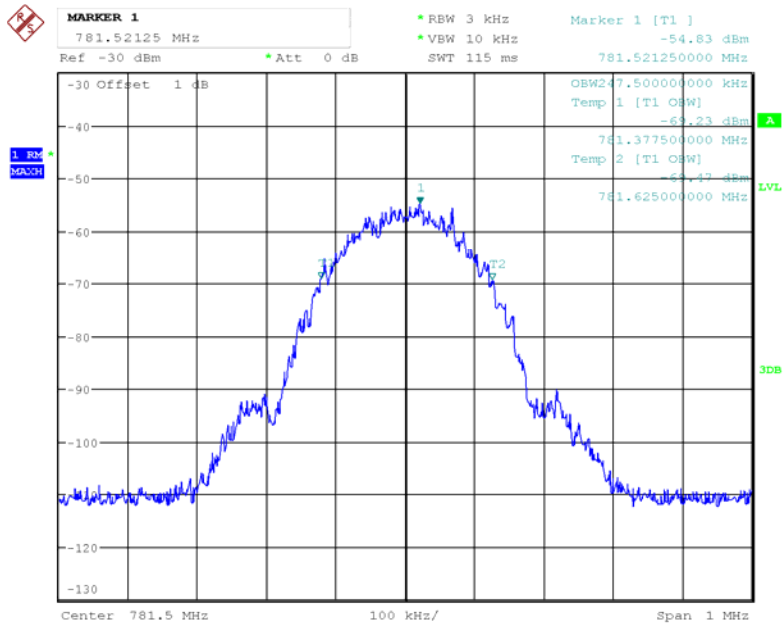

Date: 30.MAY.2018 21:16:06

Uplink, 781.5MHz -GSM(Output)

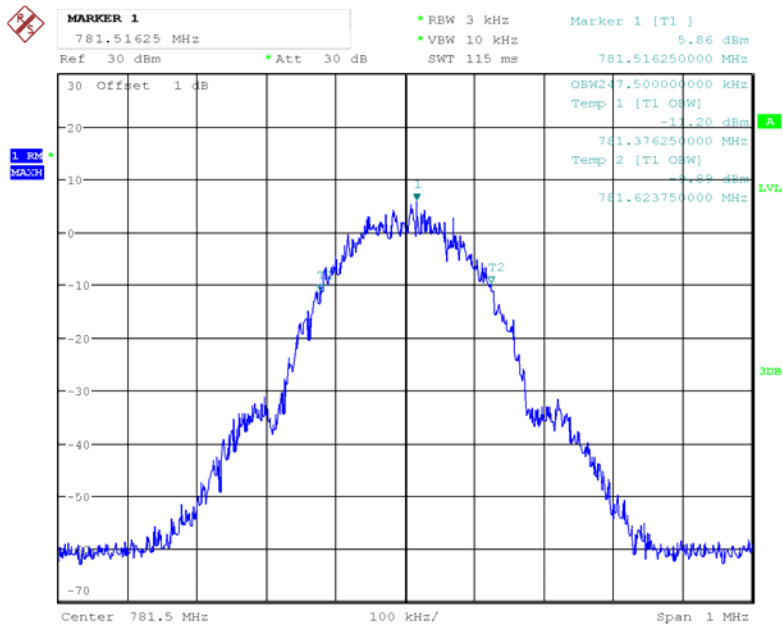

Date: 30.MAY.2018 20:53:38

Uplink, 836.5MHz -AWGN(Input)

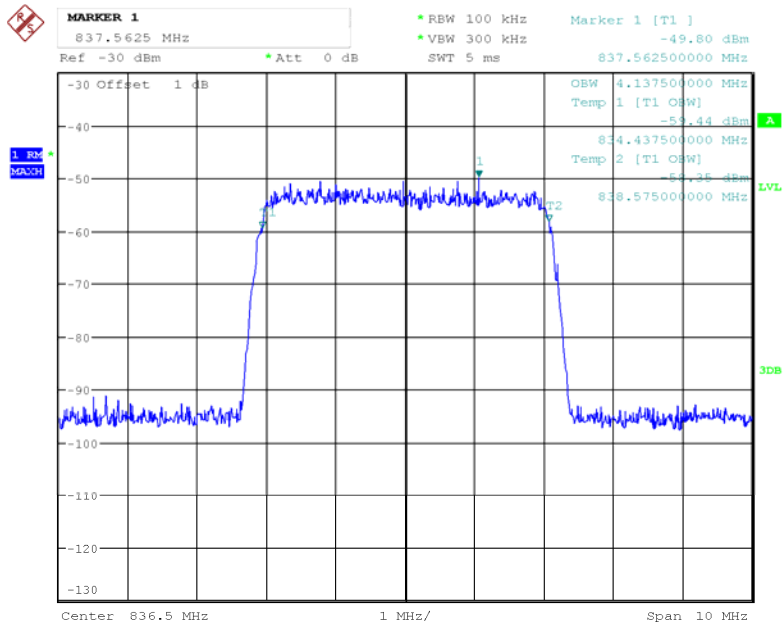

Date: 30.MAY.2018 21:20:26

Uplink, 836.5MHz -AWGN(Output)

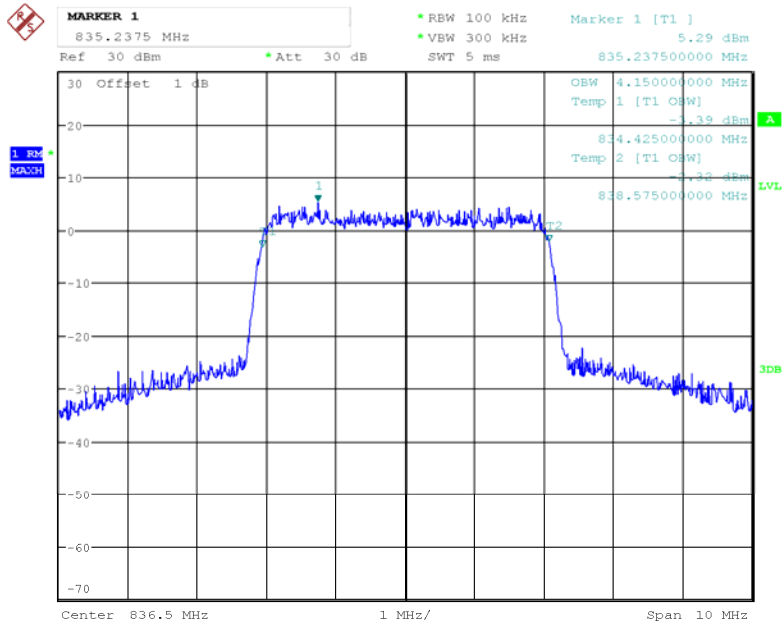

Date: 30.MAY.2018 20:57:20

Uplink, 836.5MHz -CDMA(Input)

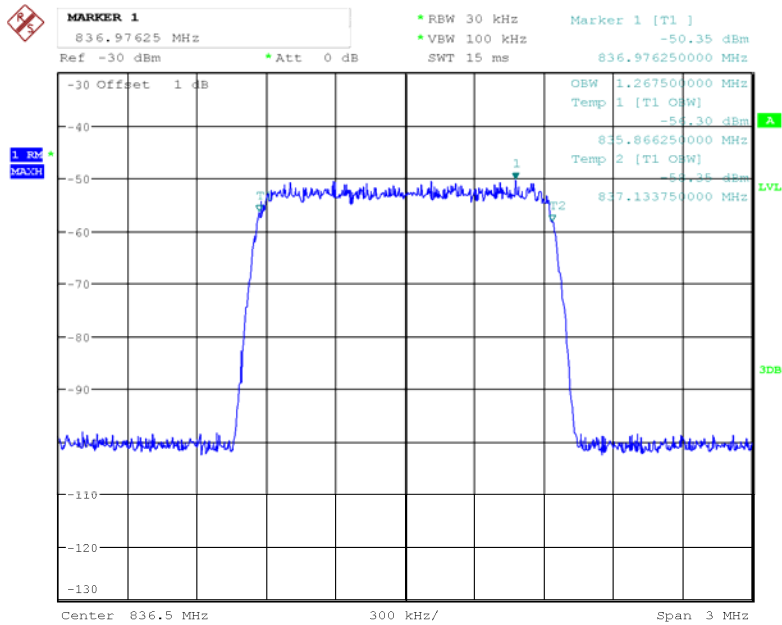

Date: 30.MAY.2018 21:19:43

Uplink, 836.5MHz -CDMA(Output)

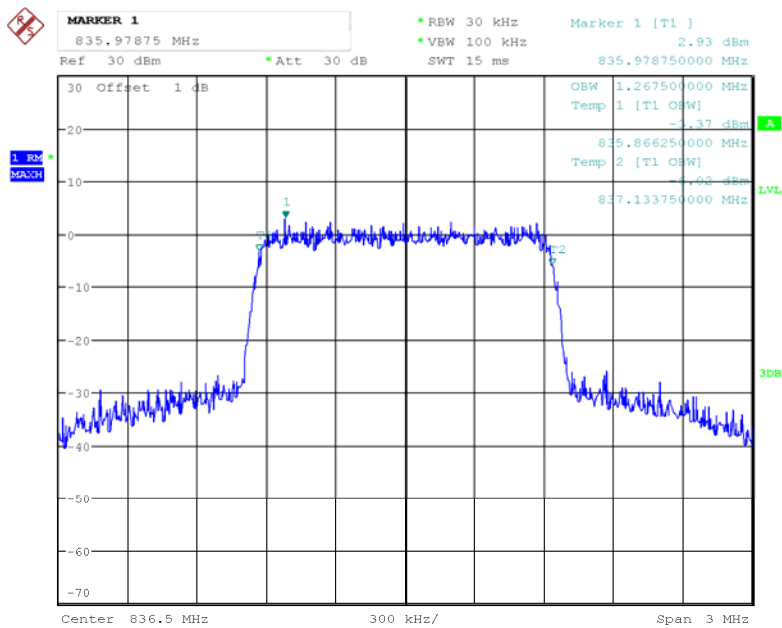

Date: 30.MAY.2018 20:58:00

Uplink, 836.5MHz -GSM(Input)

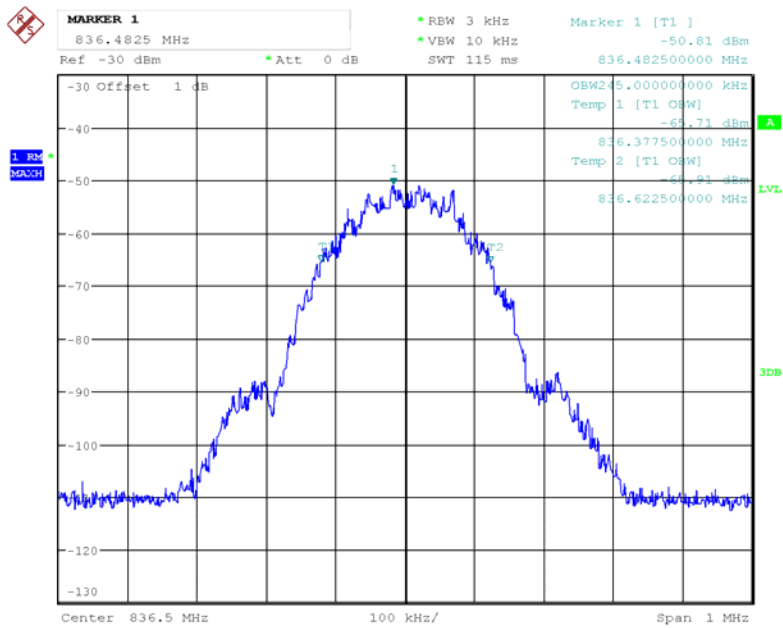

Date: 30.MAY.2018 21:21:48

Uplink, 836.5MHz -GSM(Output)

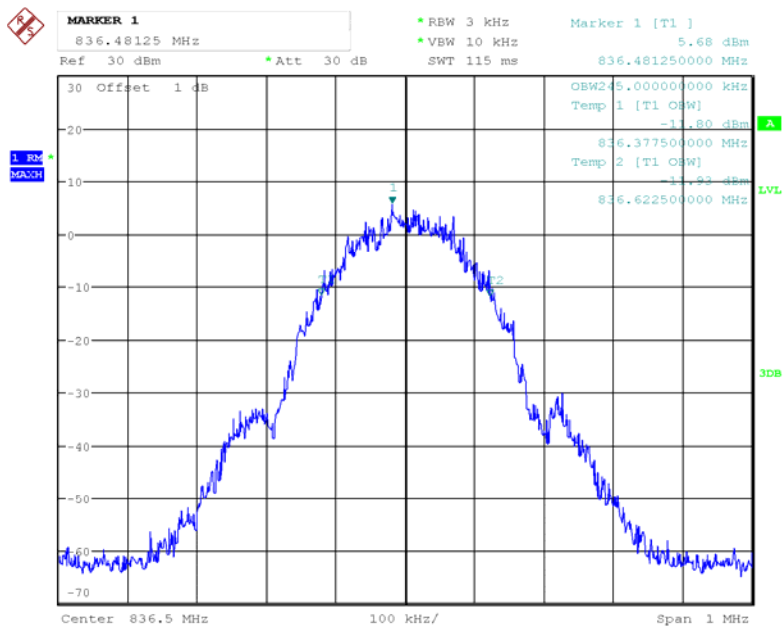

Date: 30.MAY.2018 20:55:45

Uplink, 1732.5MHz -AWGN(Input)

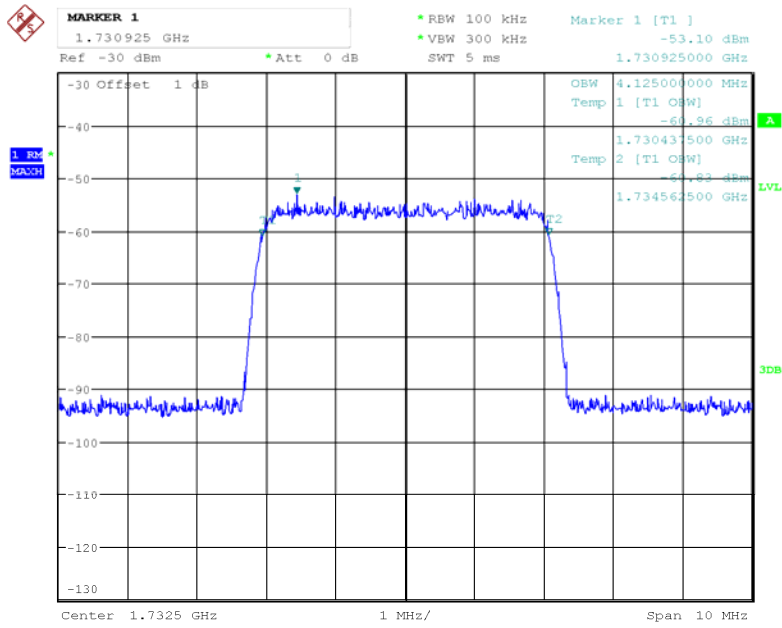

Date: 30.MAY.2018 21:24:39

Uplink, 1732.5MHz -AWGN(Output)

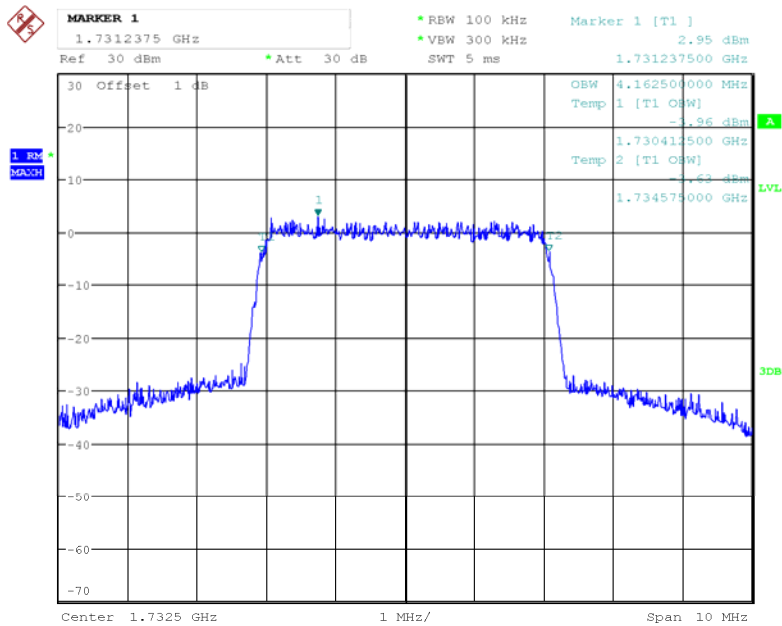

Date: 30.MAY.2018 21:01:38

Uplink, 1732.5MHz -CDMA(Input)

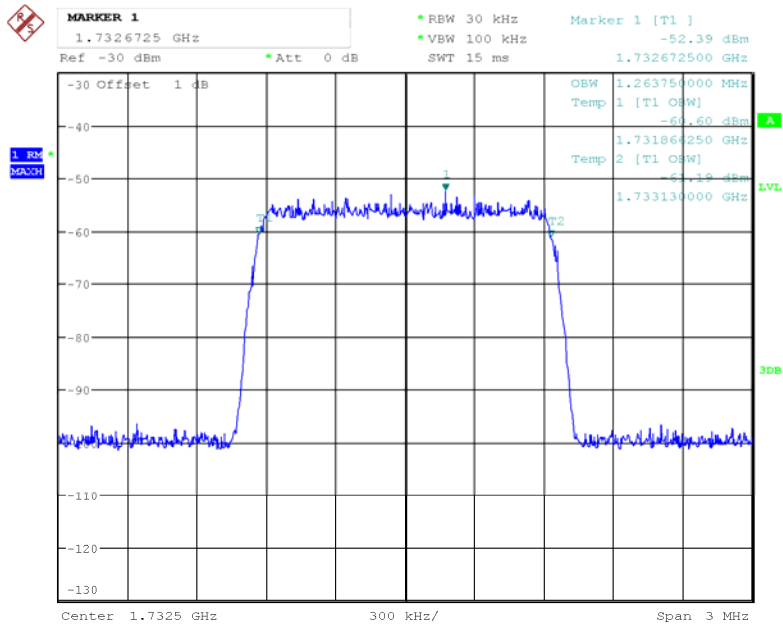

Date: 30.MAY.2018 21:25:19

Uplink, 1732.5MHz -CDMA(Output)

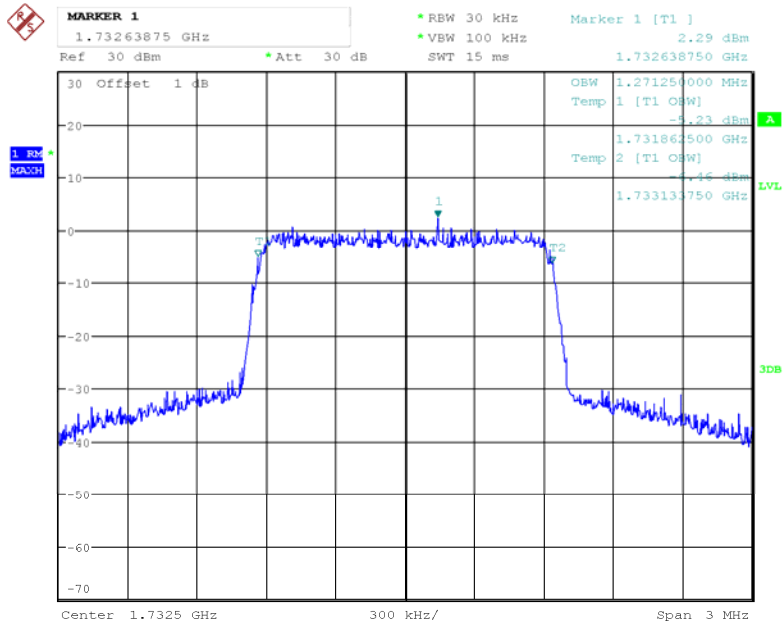

Date: 30.MAY.2018 20:59:29

Uplink, 1732.5MHz -GSM(Input)

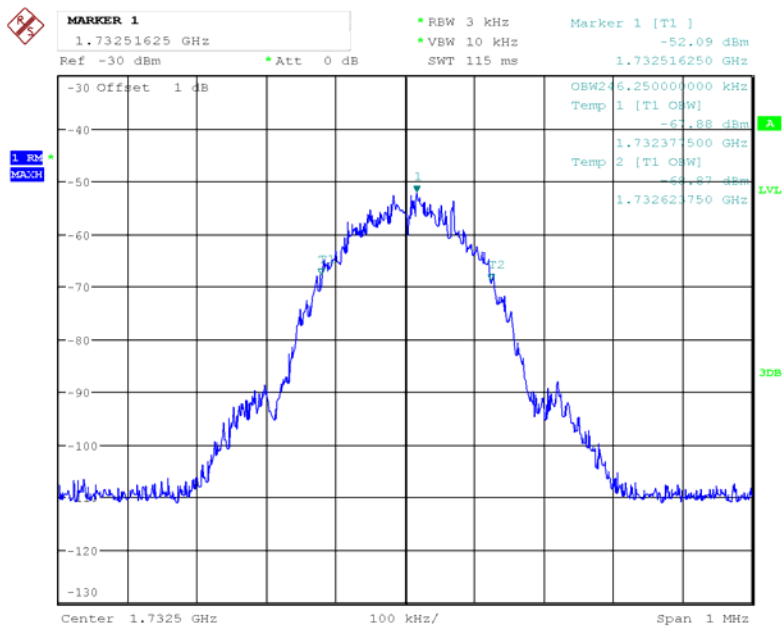

Date: 30.MAY.2018 21:23:54

Uplink, 1732.5MHz -GSM(Output)

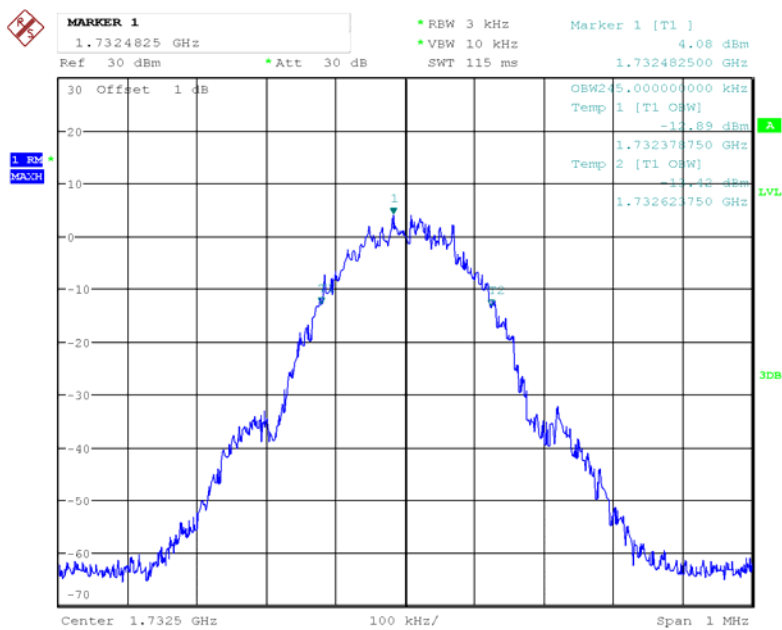

Date: 30.MAY.2018 21:03:08

Uplink, 1880MHz-AWGN(Input)

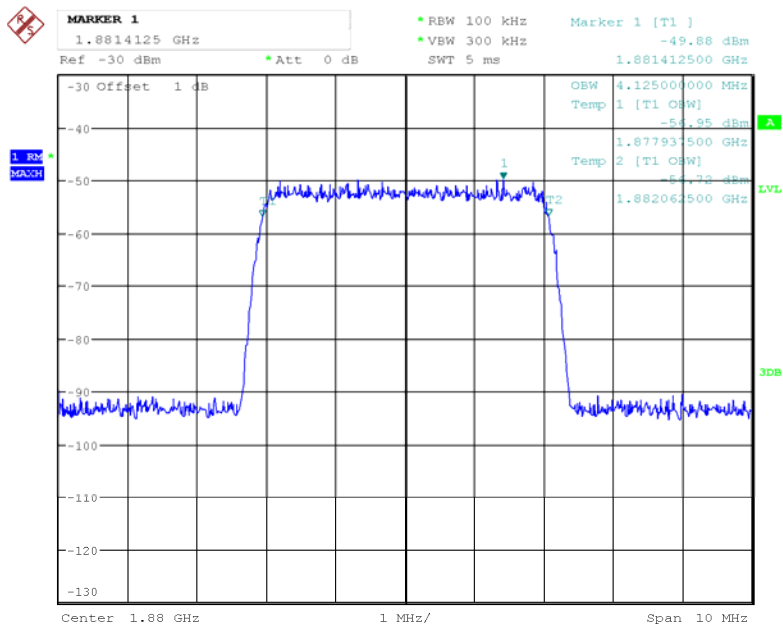

Date: 30.MAY.2018 21:27:35

Uplink, 1880MHz-AWGN(Output)

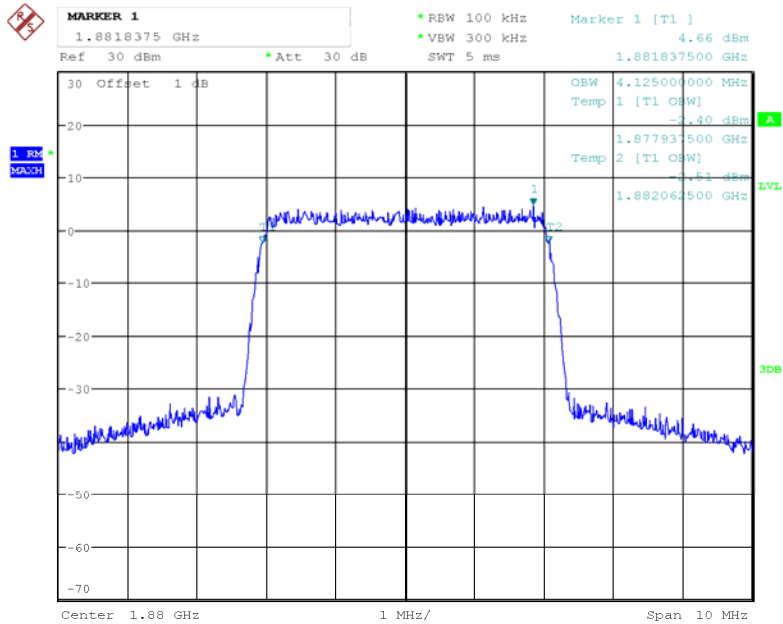

Date: 30.MAY.2018 21:07:27

Uplink, 1880MHz-CDMA(Input)

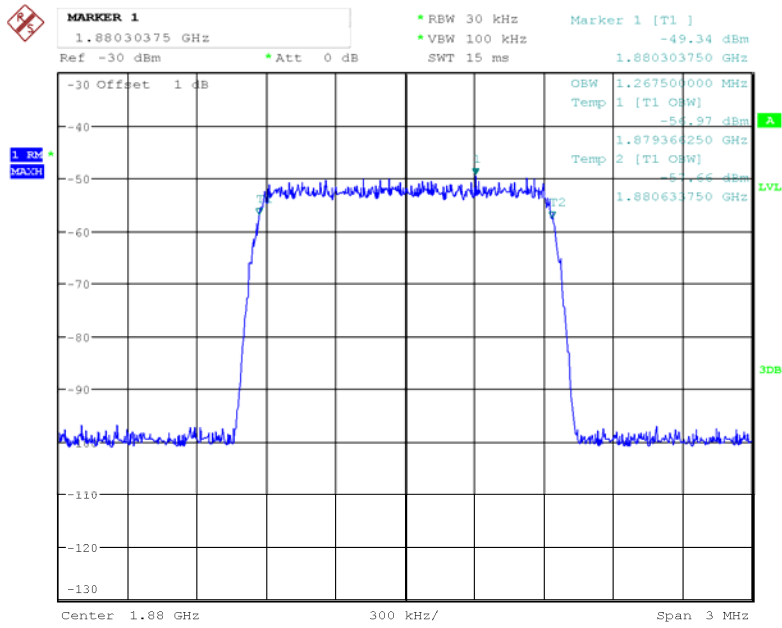

Date: 30.MAY.2018 21:26:53

Uplink, 1880MHz-CDMA(Output)

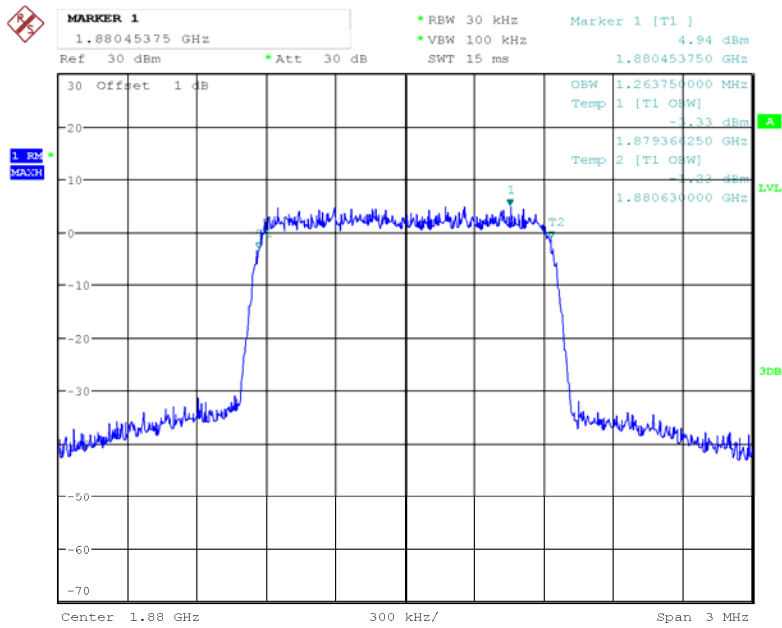

Date: 30.MAY.2018 21:08:22

Uplink, 1880MHz-GSM(Input)

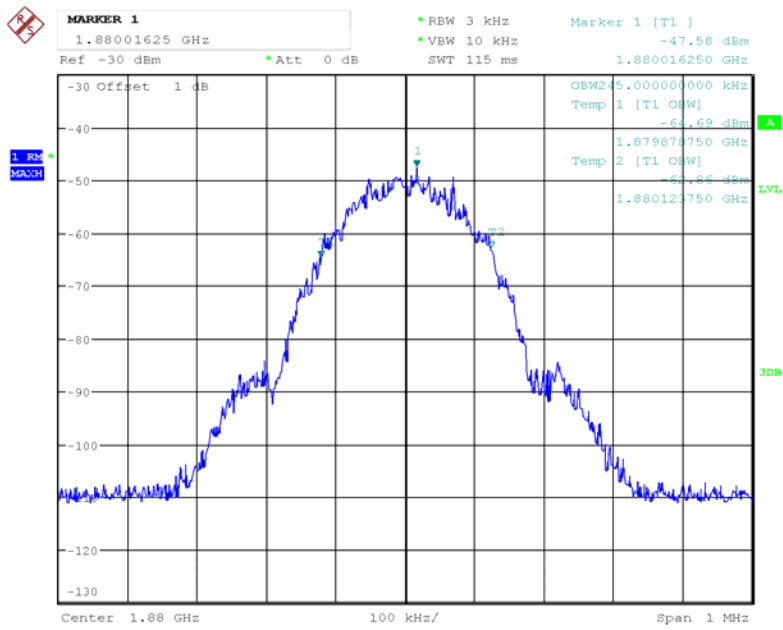

Date: 30.MAY.2018 21:28:53

Uplink, 1880MHz-GSM(Output)

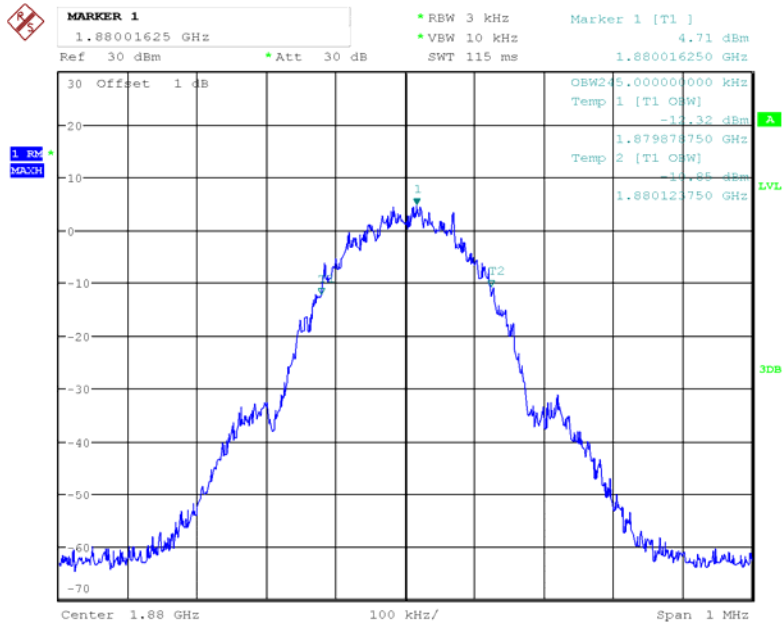

Date: 30.MAY.2018 21:06:06

Downlink, 737MHz -AWGN(Input)

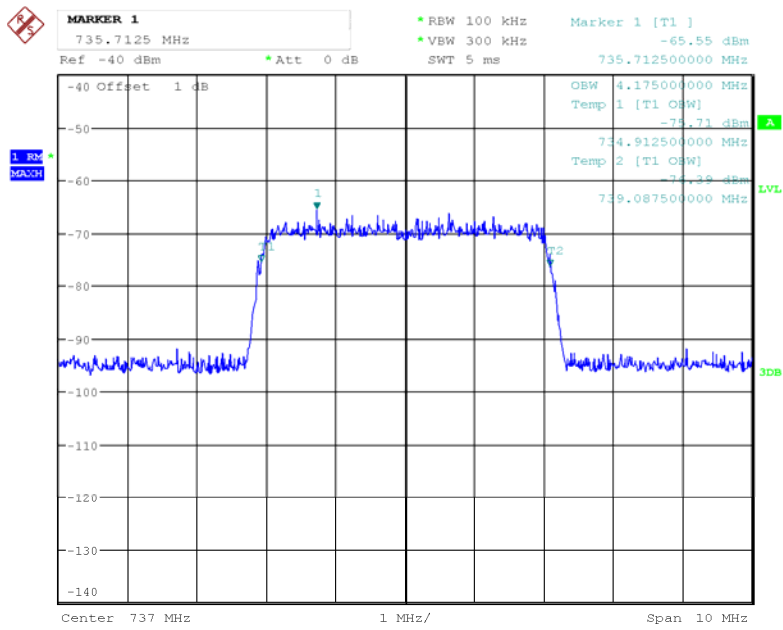

Date: 30.MAY.2018 21:32:11

Downlink, 737MHz -AWGN(Output)

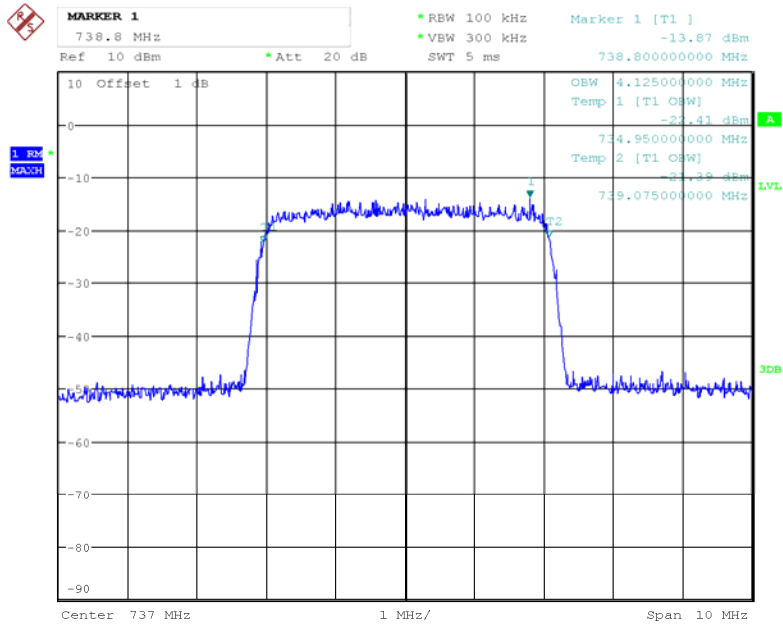

Date: 30.MAY.2018 20:16:04

Downlink, 737MHz -CDMA(Input)

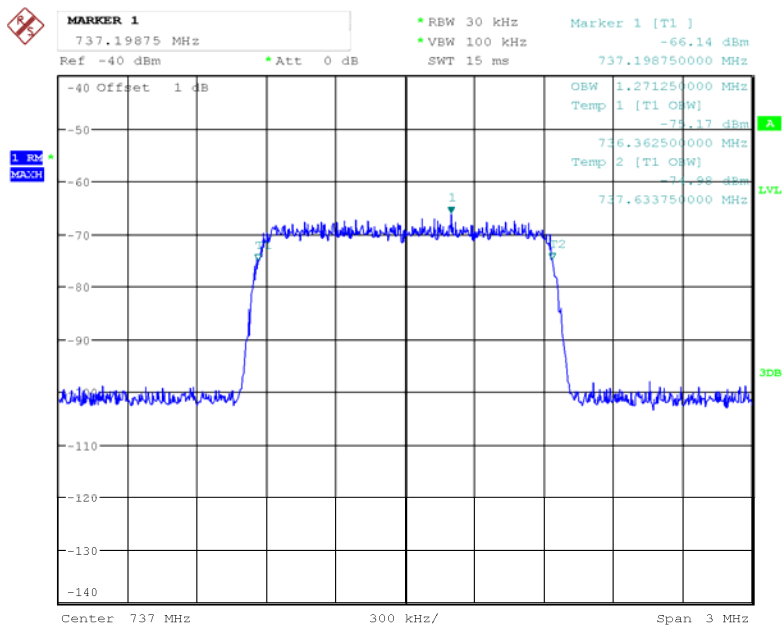

Date: 30.MAY.2018 21:32:51

Downlink, 737MHz -CDMA(Output)

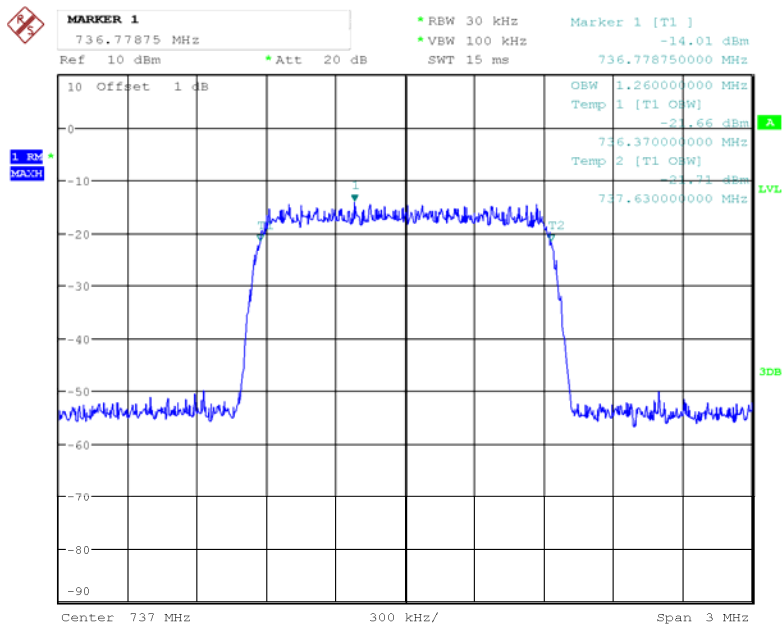

Date: 30.MAY.2018 20:14:56

Downlink, 737MHz -GSM(Input)

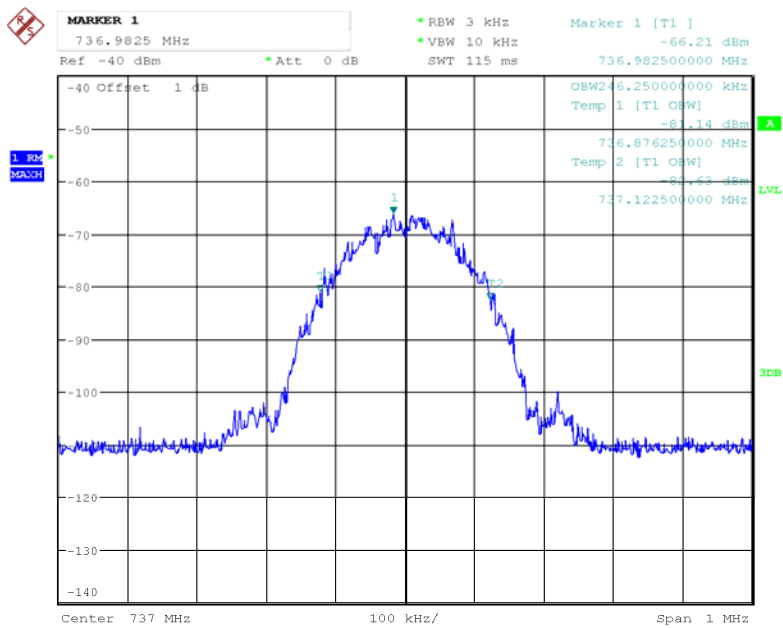

Date: 30.MAY.2018 21:31:16

Downlink, 737MHz -GSM(Output)

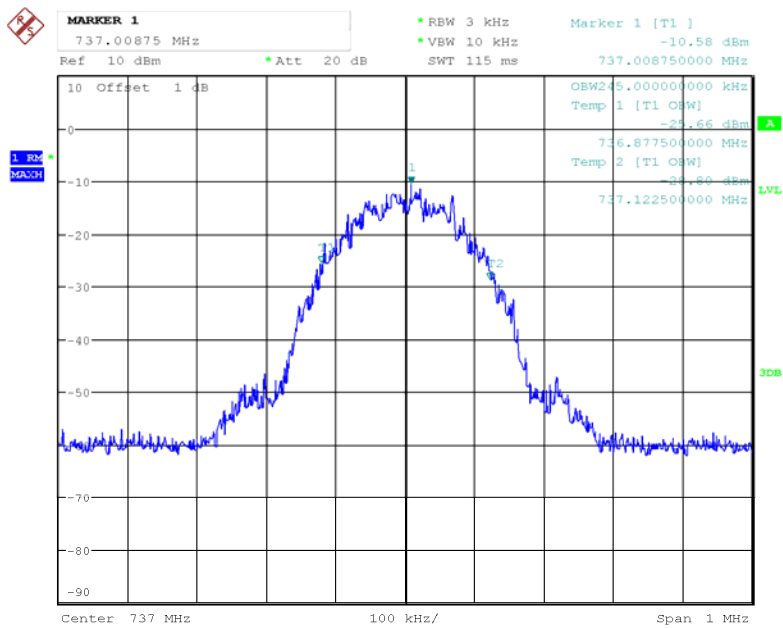

Date: 30.MAY.2018 20:17:26

Downlink, 751.5MHz -AWGN(Input)

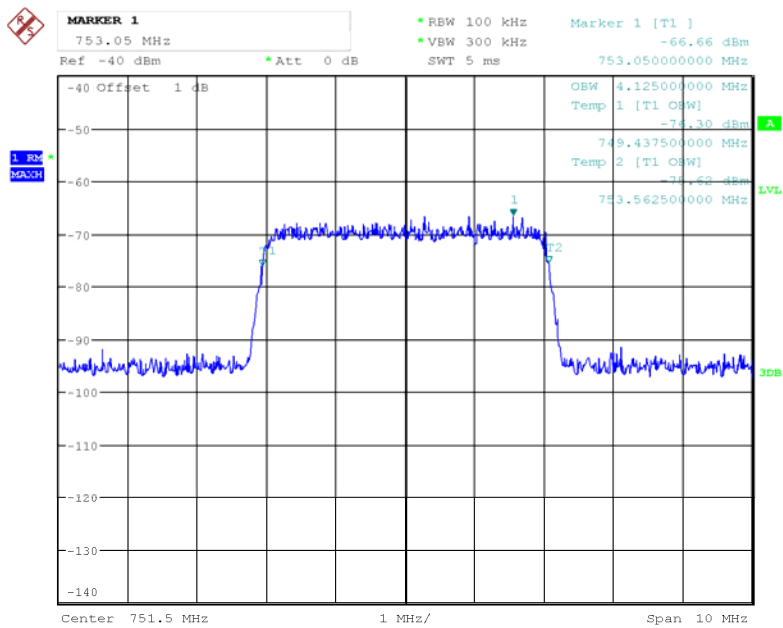

Date: 30.MAY.2018 21:34:52

Downlink, 751.5MHz -AWGN(Output)

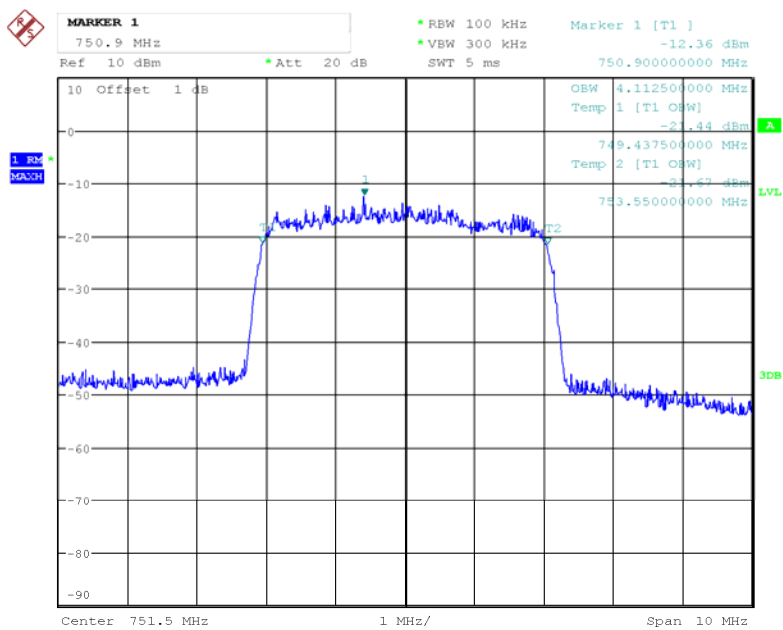

Date: 30.MAY.2018 20:20:57

Downlink, 751.5MHz -CDMA(Input)

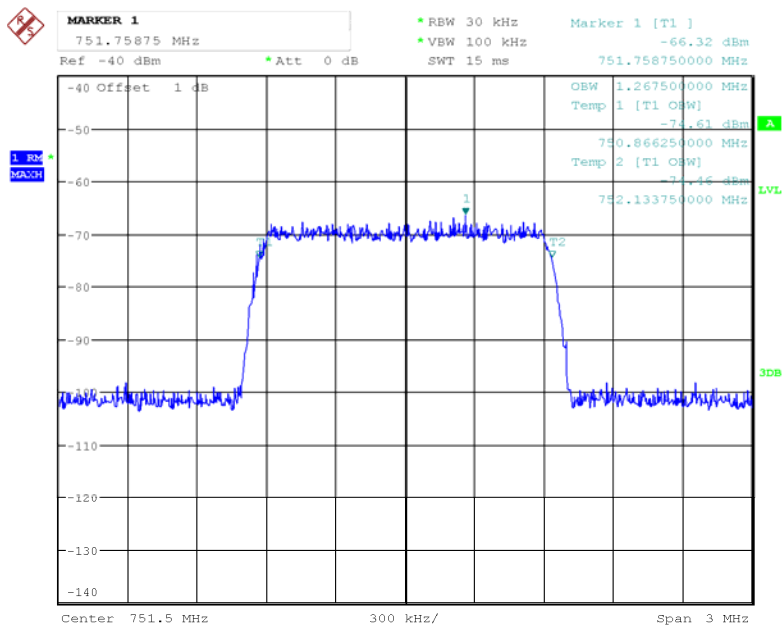

Date: 30.MAY.2018 21:34:10

Downlink, 751.5MHz -CDMA(Output)

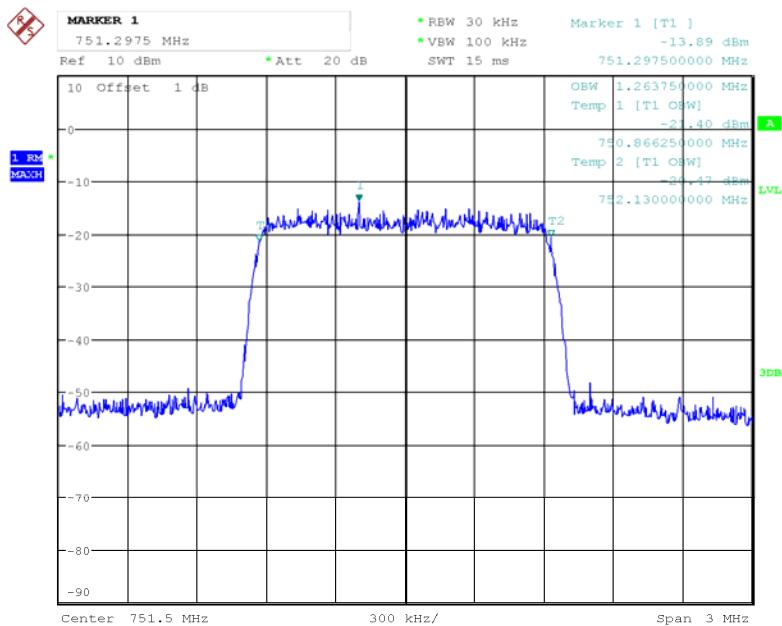

Date: 30.MAY.2018 20:21:34

Downlink, 751.5MHz -GSM(Input)

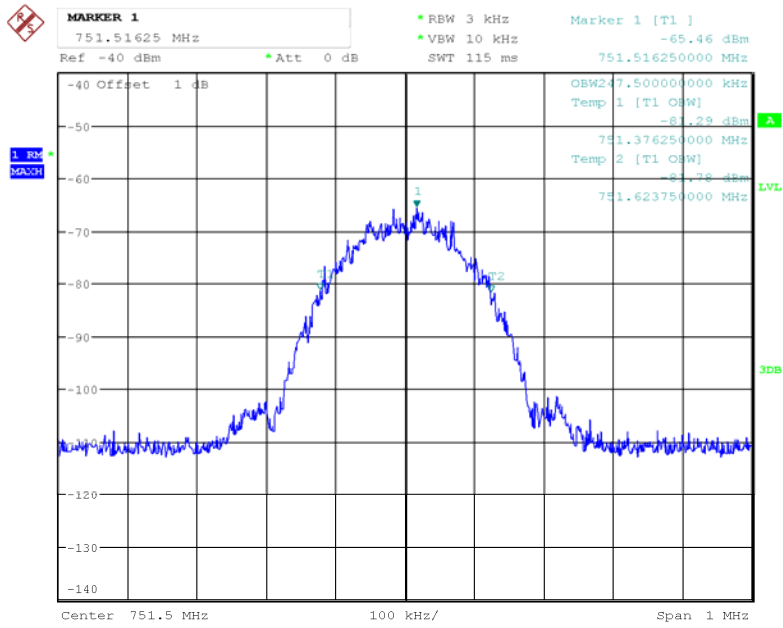

Date: 30.MAY.2018 21:36:06

Downlink, 751.5MHz -GSM(Output)

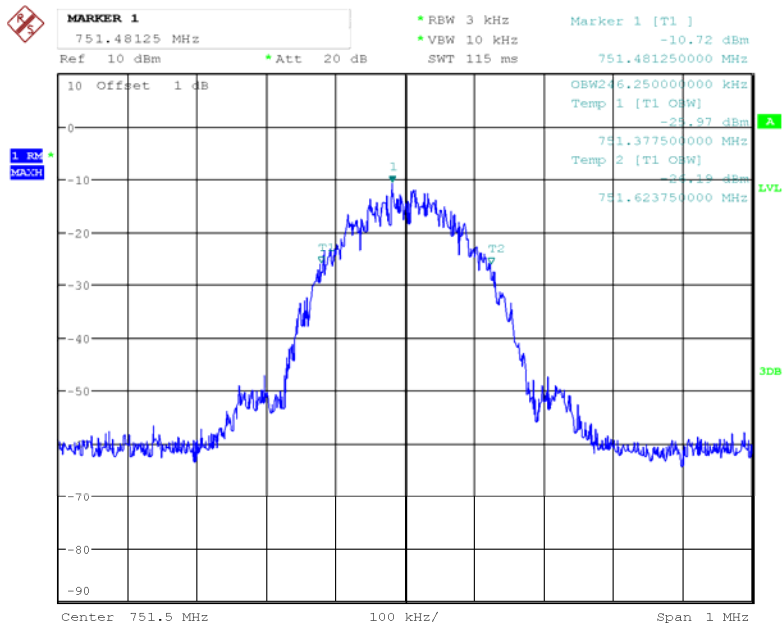

Date: 30.MAY.2018 20:19:13

Downlink, 881.5MHz -AWGN(Input)

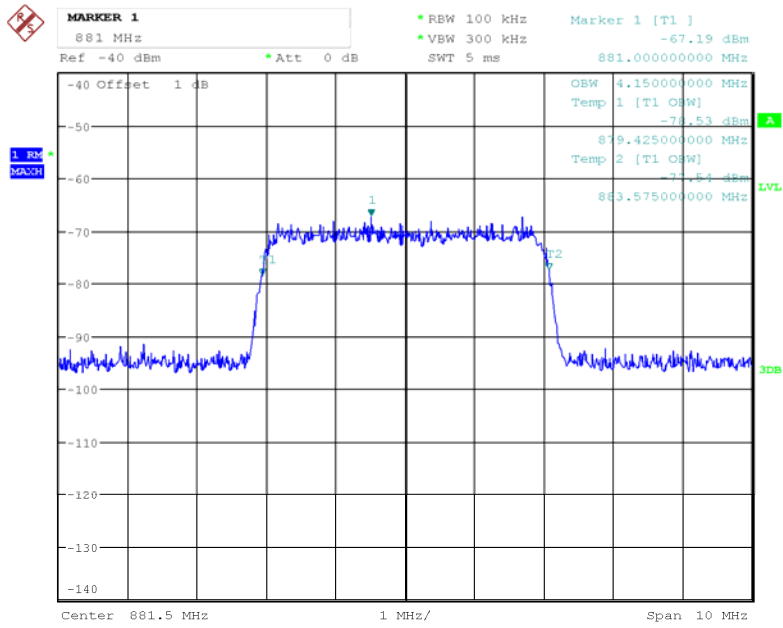

Date: 30.MAY.2018 21:39:40

Downlink, 881.5MHz -AWGN(Output)

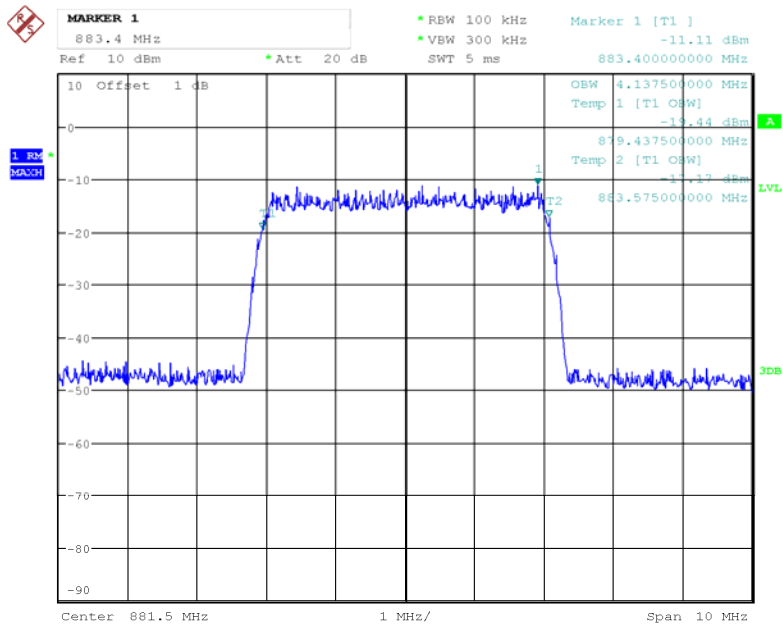

Date: 30.MAY.2018 20:23:58

Downlink, 881.5MHz -CDMA(Input)

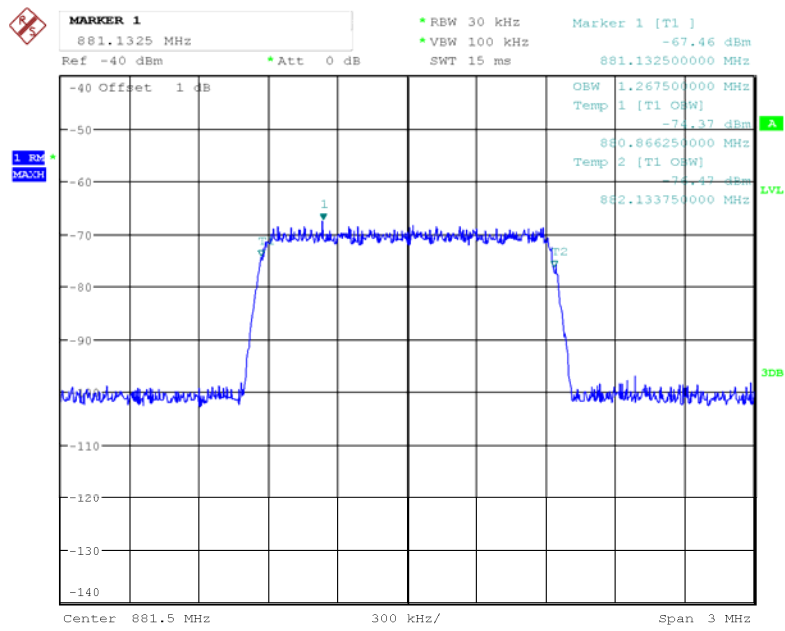

Date: 30.MAY.2018 21:40:24

Downlink, 881.5MHz -CDMA(Output)

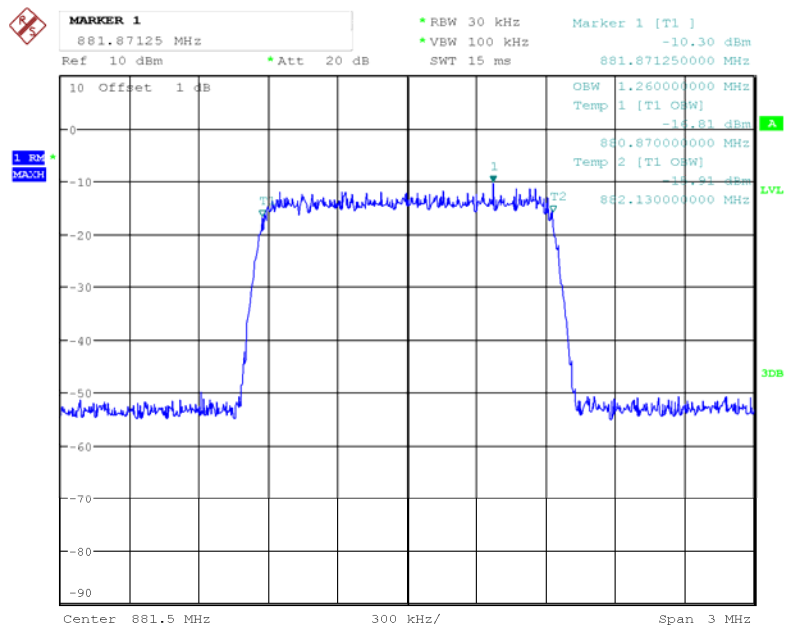

Date: 30.MAY.2018 20:23:02

Downlink, 881.5MHz -GSM(Input)

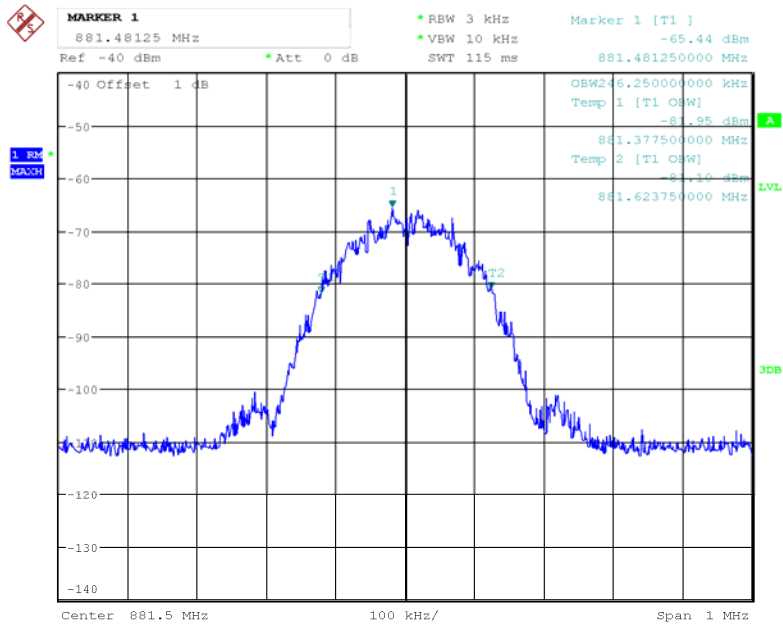

Date: 30.MAY.2018 21:38:55

Downlink, 881.5MHz -GSM(Output)

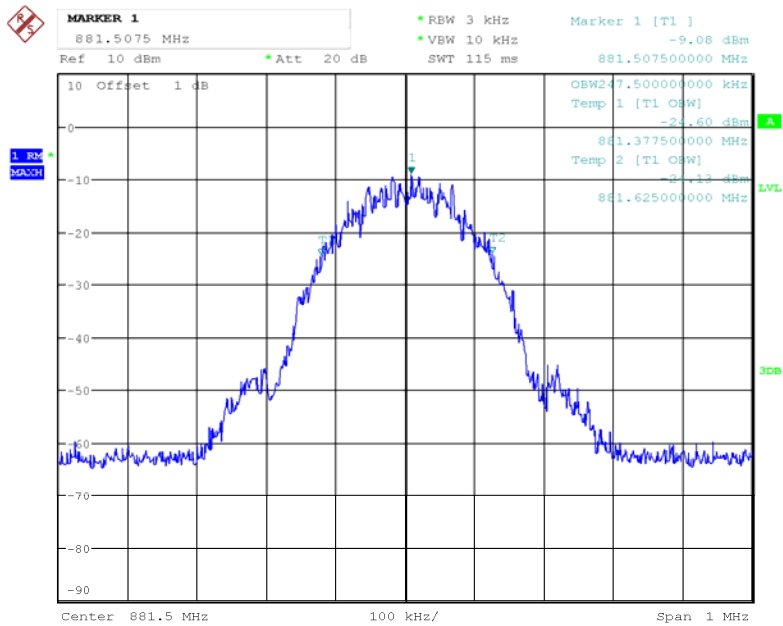

Date: 30.MAY.2018 20:25:08

Downlink, 1960MHz -AWGN(Input)

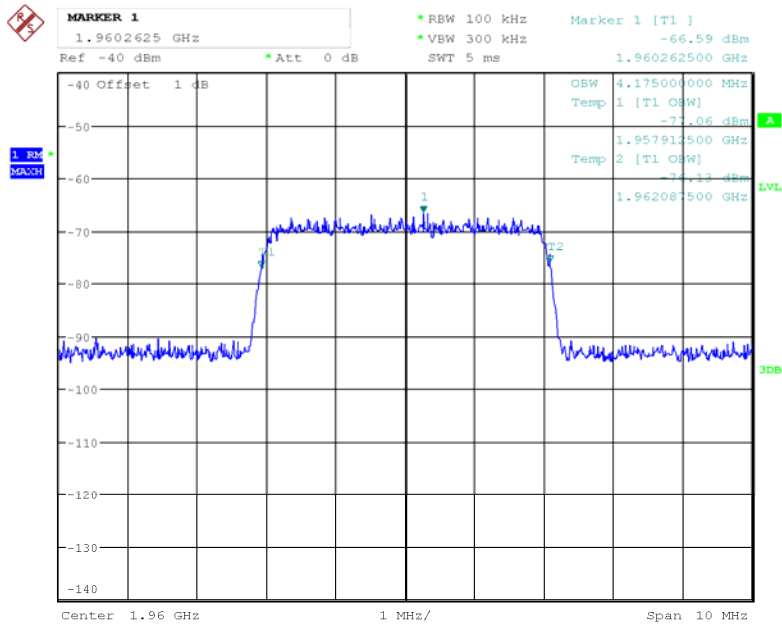

Date: 30.MAY.2018 21:49:59

Downlink, 1960MHz -AWGN(Output)

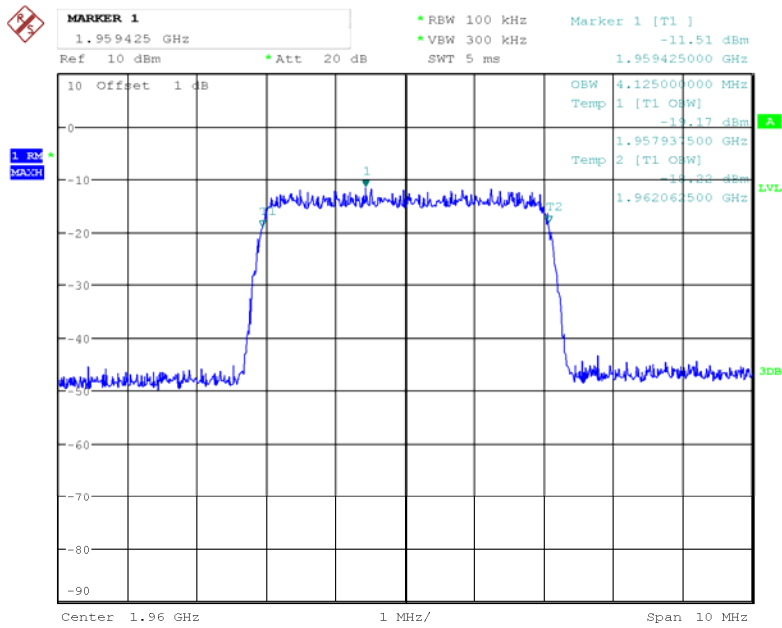

Date: 30.MAY.2018 20:33:28

Downlink, 1960MHz -CDMA(Input)

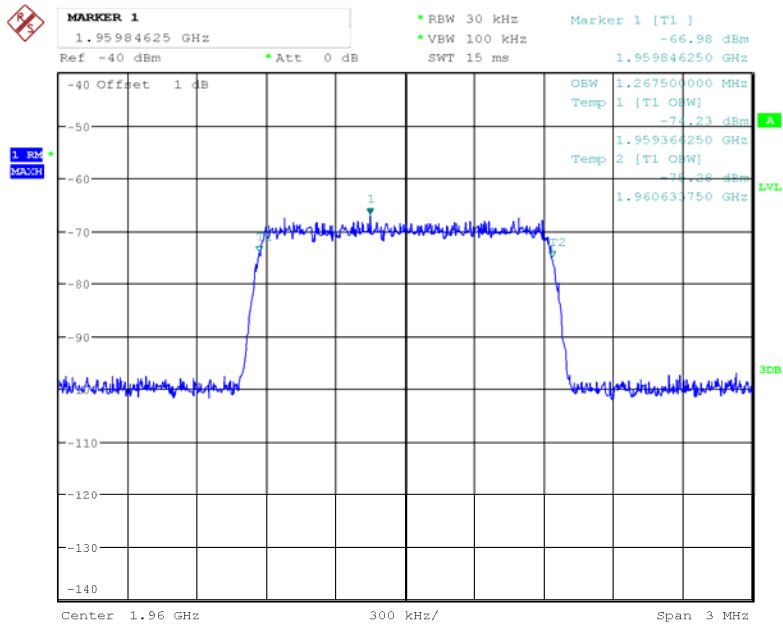

Date: 30.MAY.2018 21:49:22

Downlink, 1960MHz -CDMA(Output)

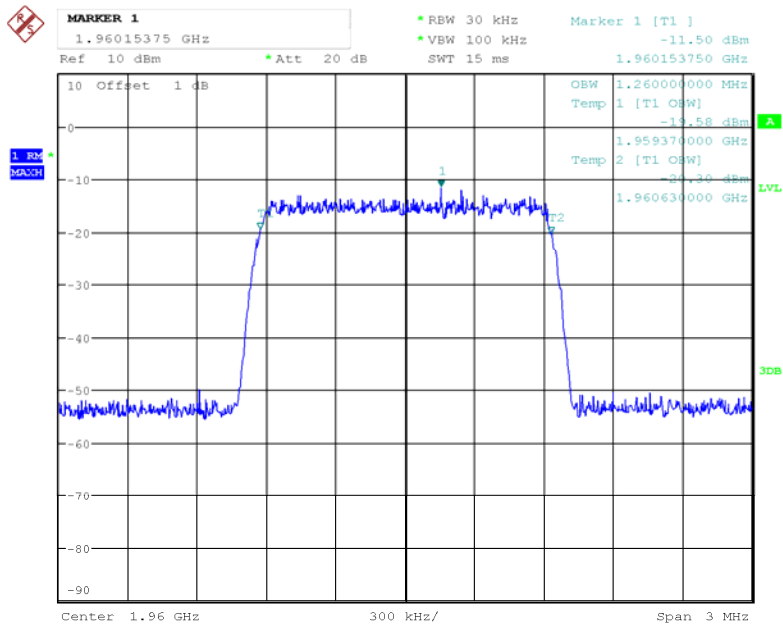

Date: 30.MAY.2018 20:32:39

Downlink, 1960MHz -GSM(Input)

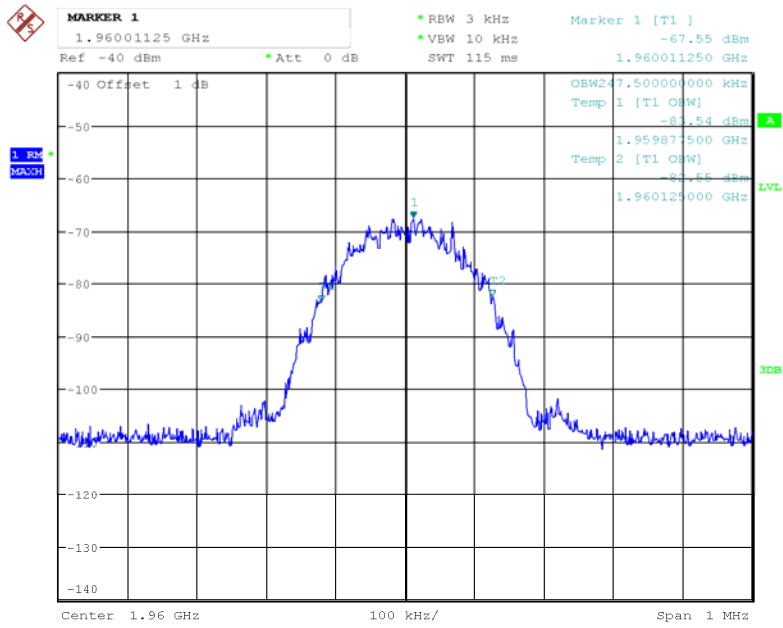

Date: 30.MAY.2018 21:48:33

Downlink, 1960MHz -GSM(Output)

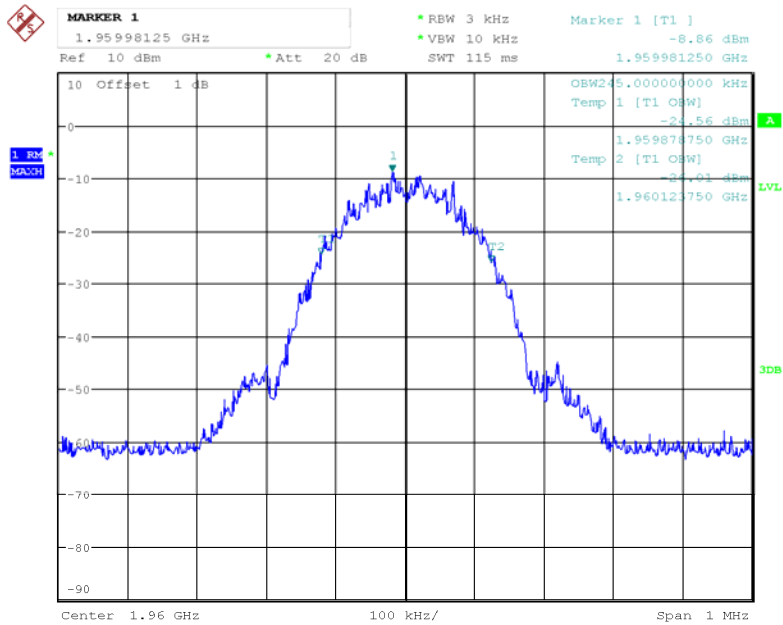

Date: 30.MAY.2018 20:34:36

Downlink, 2132.5MHz-AWGN(Input)

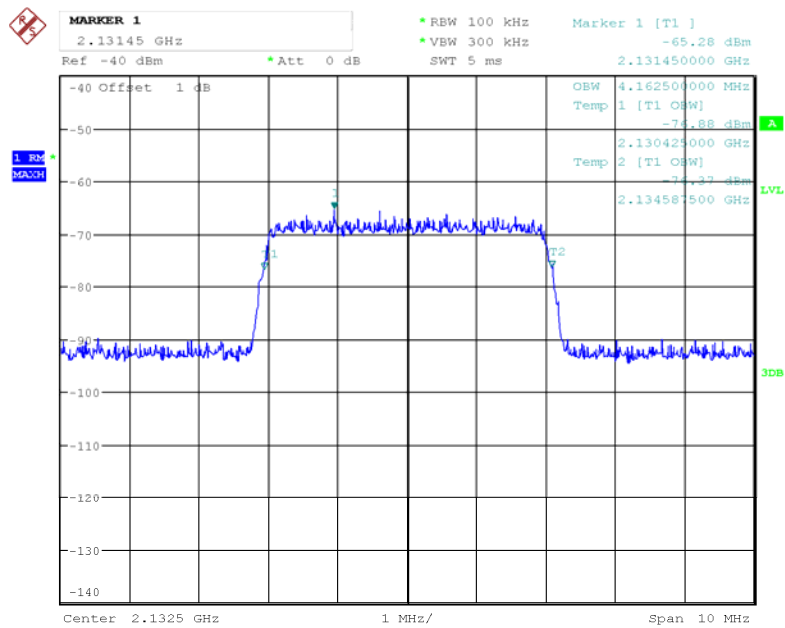

Date: 30.MAY.2018 21:43:56

Downlink, 2132.5MHz-AWGN(Output)

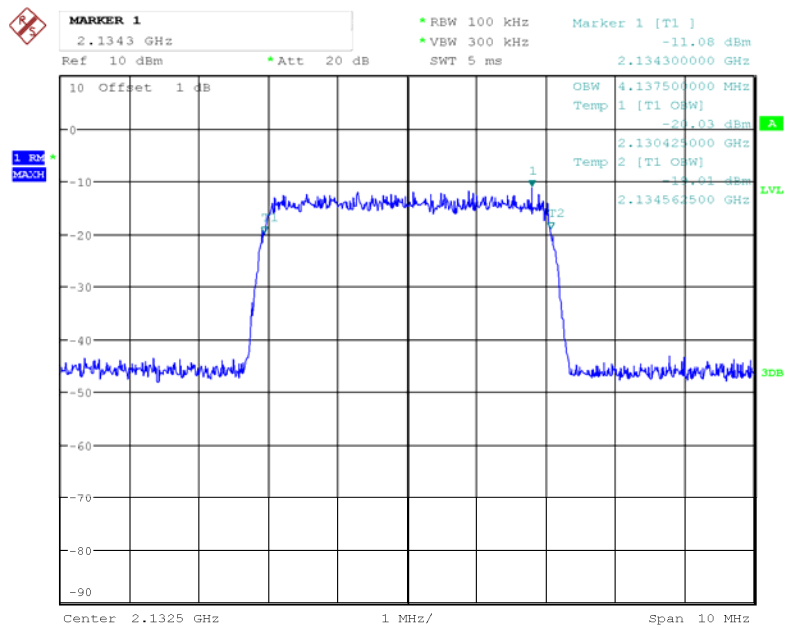

Date: 30.MAY.2018 20:29:43

Downlink, 2132.5MHz -CDMA(Input)

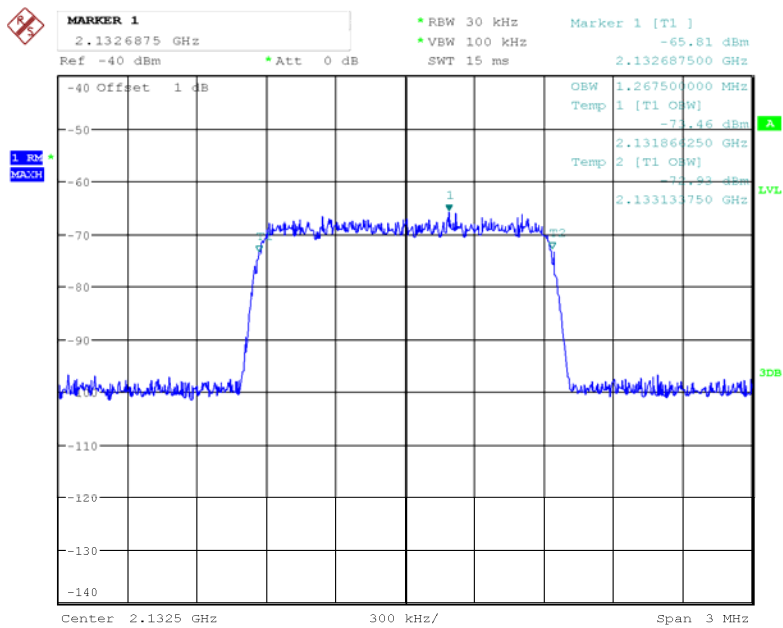

Date: 30.MAY.2018 21:44:54

Downlink, 2132.5MHz -CDMA(Output)

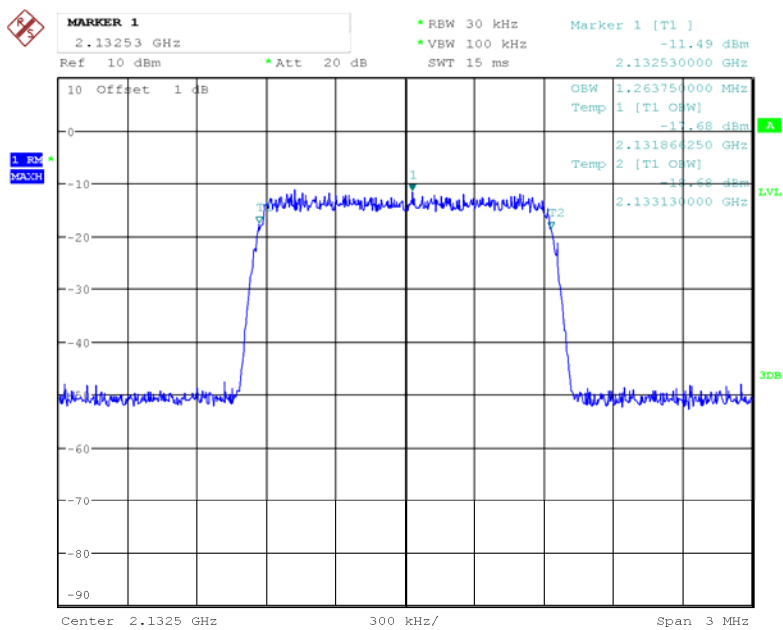

Date: 30.MAY.2018 20:30:36

Downlink, 2132.5MHz -GSM(Input)

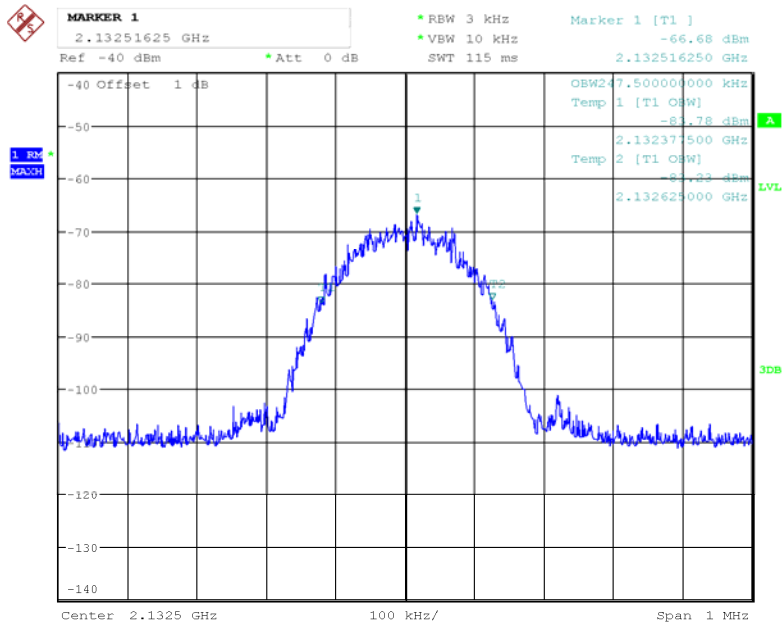

Date: 30.MAY.2018 21:46:04

Downlink, 2132.5MHz -GSM(Output)

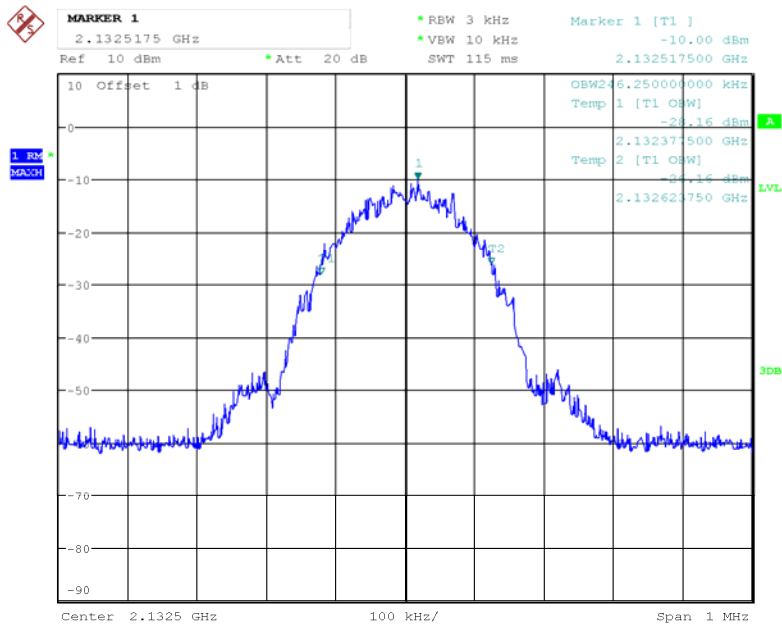

Date: 30.MAY.2018 20:27:56

§ 20.21(e)(8)(ii)(A) & §20.21(e)(4) - OSCILLATION DETECTION

Applicable Standards

Rule paragraph(s): § 20.21(e)(8)(ii)(A) Anti-Oscillation, §20.21(e)(4) Self-monitoring

For this measurement two EUTs will be permitted, one operating in a normal mode and the second operating in a test mode that is capable of disabling the uplink inactivity squelching and or a reduction of the time between restarts to 5 seconds. This will greatly decrease the test time required.

NOTE — Consumer boosters certified as direct connection mobile boosters having gain of less than or equal to 15 dB are exempt from compliance to testing procedures in 7.11.3 and 7.11.4.

Test Procedure

According to KDB 935210 D03 Signal Booster Measurements v04, §7.11.2 Oscillation restart tests and §7.11.3 Test procedure for measuring oscillation mitigation or shutdown

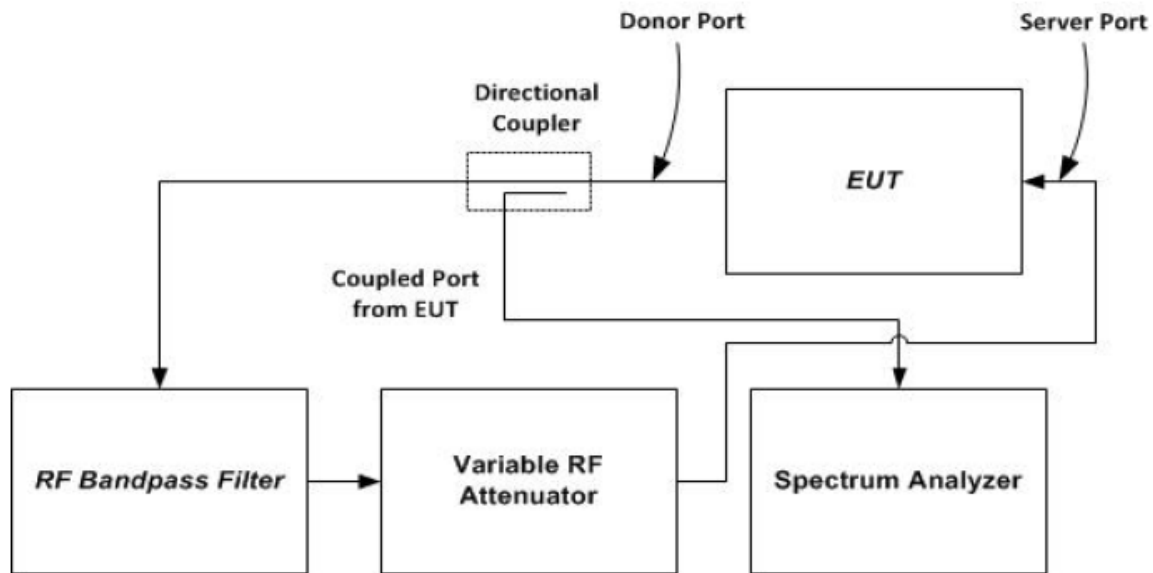

Figure 7 – Oscillation detection instrumentation test setup

Test Data

Environmental Conditions

Temperature:	26.3~28.3 °C
Relative Humidity:	53~59 %
ATM Pressure:	101.2~101.3 kPa

The testing was performed by George Pang from 2018-05-20 to 2018-05-31.

Test Result: Compliance. Please refer to following table.

Oscillation Restart Time:

Mode	Operation Bands	Detection Time (s)		Power level	Between restart time (s)		Number of restart		Result
		Reading	Limit	dBm	Reading	Limit	Reading	Limit	
Uplink	Lower 700MHz	0.26	0.3	15.6	61.70	60	4	5	Compliance
	Upper 700MHz	0.13		1.64	61.55		5		Compliance
	Cellular	0.26		16.1	62.64		4		Compliance
	AWS	0.27		16.93	61.70		4		Compliance
	PCS	0.06		12.64	61.58		4		Compliance
Downlink	Lower 700MHz	0.26	1	20.8	61.75	60	4	5	Compliance
	Upper 700MHz	0.27		12.28	62.01		4		Compliance
	Cellular	0.27		20.8	61.70		4		Compliance
	AWS	0.27		13.73	61.88		4		Compliance
	PCS	0.26		10.29	61.26		4		Compliance

Oscillation Mitigation or Shutdown:

Mode	Operation Band	Max gain dB	Isolation dB	Difference dB	Limit dB	Result	
Uplink	Lower 700MHz	62.85	+5	6.68	12.00	Compliance	
			+4	6.92	12.00	Compliance	
			+3	7.68	12.00	Compliance	
			+2	9	12.00	Compliance	
			+1	9.33	12.00	Compliance	
			+0	10.68	12.00	Compliance	
			-1	/	/	Compliance*	
			-2	/	/	Compliance*	
			-3	/	/	Compliance*	
			-4	/	/	Compliance*	
	-5	/	/	Compliance*			
	Upper 700MHz	63.04	63.04	+5	5.71	12.00	Compliance
				+4	5.73	12.00	Compliance
				+3	5.82	12.00	Compliance
				+2	6.77	12.00	Compliance
				+1	7.68	12.00	Compliance
				+0	8.03	12.00	Compliance
				-1	/	/	Compliance*
				-2	/	/	Compliance*
				-3	/	/	Compliance*
				-4	/	/	Compliance*
	-5	/	/	Compliance			
	Cellular	63.76	63.76	+5	4.84	12.00	Compliance
				+4	5.05	12.00	Compliance
				+3	5.78	12.00	Compliance
				+2	6.55	12.00	Compliance
				+1	7.33	12.00	Compliance
				+0	7.85	12.00	Compliance
				-1	/	/	Compliance*
				-2	/	/	Compliance*
				-3	/	/	Compliance*
				-4	/	/	Compliance*
	-5	/	/	Compliance*			
	AWS	67.78	67.78	+5	4.65	12.00	Compliance
				+4	5.35	12.00	Compliance
				+3	6.05	12.00	Compliance
				+2	6.67	12.00	Compliance
				+1	7	12.00	Compliance
				+0	7.79	12.00	Compliance
				-1	/	/	Compliance*
-2				/	/	Compliance*	
-3				/	/	Compliance*	
-4				/	/	Compliance*	
-5	/	/	Compliance*				

Note: Compliance*: The measured difference exceeds the limit (12dB) for a period of less than 300 seconds before device mitigate and shut down.

Mode	Operation Band	Max gain	Isolation	Difference	Limit	Result
		dB	dB	dB	dB	
Uplink	PCS	62.5	+5	4.49	12.00	Compliance
			+4	5.01	12.00	Compliance
			+3	5.14	12.00	Compliance
			+2	6.1	12.00	Compliance
			+1	6.94	12.00	Compliance
			+0	7.66	12.00	Compliance
			-1	/	/	Compliance*
			-2	/	/	Compliance*
			-3	/	/	Compliance*
			-4	/	/	Compliance*
Downlink	Lower 700MHz	62.91	+5	6.58	12.00	Compliance
			+4	6.95	12.00	Compliance
			+3	7.63	12.00	Compliance
			+2	8.41	12.00	Compliance
			+1	9.23	12.00	Compliance
			+0	10.18	12.00	Compliance
			-1	/	/	Compliance*
			-2	/	/	Compliance*
			-3	/	/	Compliance*
			-4	/	/	Compliance*
	-5	/	/	Compliance*		
	Upper 700MHz	63.49	+5	7.39	12.00	Compliance
			+4	7.94	12.00	Compliance
			+3	8.84	12.00	Compliance
			+2	9.43	12.00	Compliance
			+1	9.99	12.00	Compliance
			+0	10.78	12.00	Compliance
			-1	/	/	Compliance*
			-2	/	/	Compliance*
			-3	/	/	Compliance*
			-4	/	/	Compliance*
	-5	/	/	Compliance*		
	Cellular	64.11	+5	6.64	12.00	Compliance
			+4	7.16	12.00	Compliance
			+3	8.48	12.00	Compliance
			+2	9.36	12.00	Compliance
			+1	10.27	12.00	Compliance
			+0	11.49	12.00	Compliance
			-1	/	/	Compliance*
			-2	/	/	Compliance*
-3			/	/	Compliance*	
-4			/	/	Compliance*	
-5	/	/	Compliance*			

Note: Compliance*: The mesured difference exceeds the limit (12dB) for a period of less than 300 seconds before device mitigrare and shut down.

Mode	Operation Band	Max gain	Isolation	Difference	Limit	Result
		dB	dB	dB	dB	
Downlink	AWS	64.82	+5	6.92	12.00	Compliance
			+4	7.46	12.00	Compliance
			+3	7.75	12.00	Compliance
			+2	8.81	12.00	Compliance
			+1	9.87	12.00	Compliance
			+0	10.99	12.00	Compliance
			-1	/	/	Compliance*
			-2	/	/	Compliance*
			-3	/	/	Compliance*
			-4	/	/	Compliance*
	PCS	65.54	+5	7.15	12.00	Compliance
			+4	7.76	12.00	Compliance
			+3	8.27	12.00	Compliance
			+2	10.02	12.00	Compliance
			+1	10.61	12.00	Compliance
			+0	11.77	12.00	Compliance
			-1	/	/	Compliance*
			-2	/	/	Compliance*
			-3	/	/	Compliance*
			-4	/	/	Compliance*
-5	/	/	Compliance*			

Note: Compliance*: The measured difference exceeds the limit (12dB) for a period of less than 300 seconds before device mitigate and shut down.

Oscillation restart tests:

Downlink:

Lower 700MHz Band

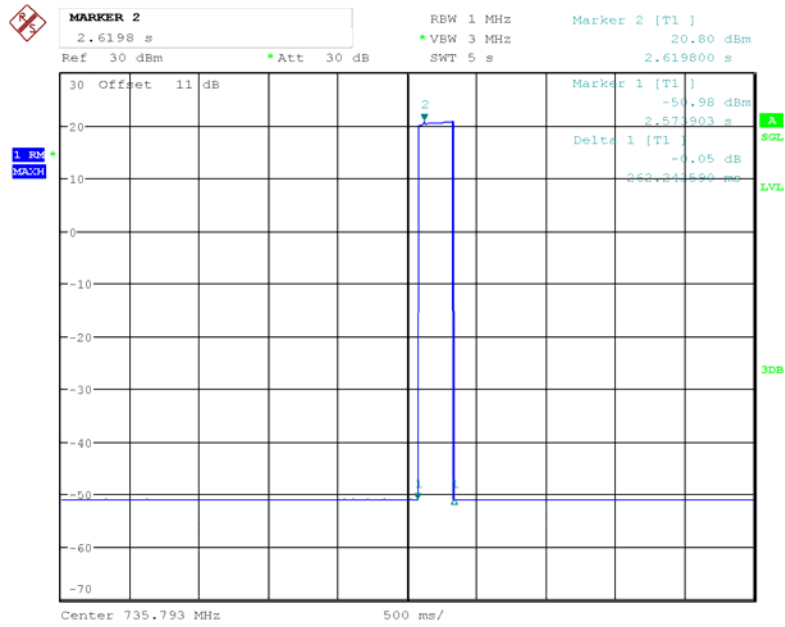

Date: 27.MAY.2018 15:28:35

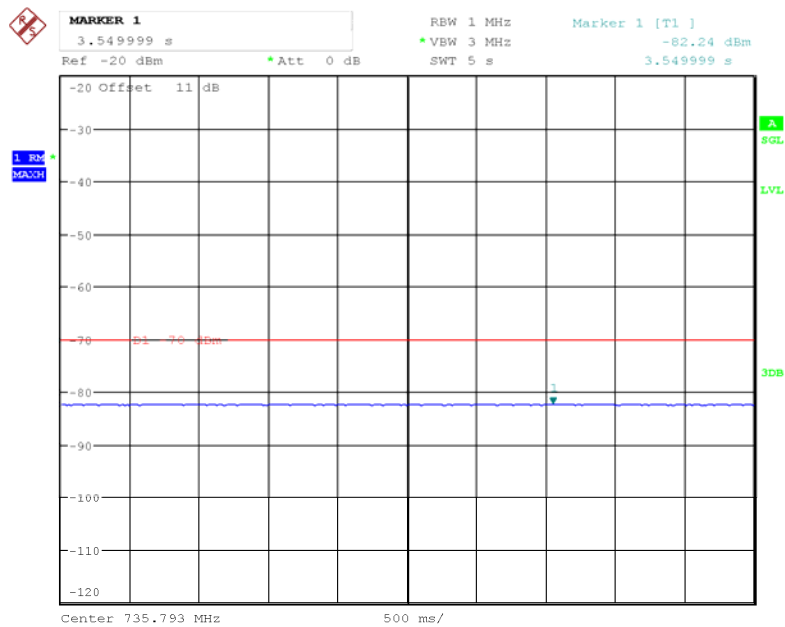

Date: 27.MAY.2018 19:50:42

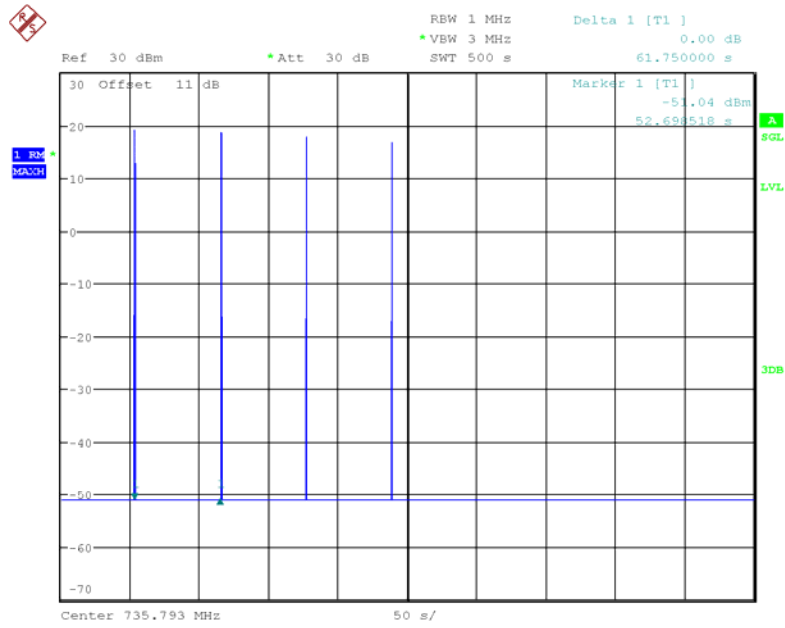

Date: 27.MAY.2018 15:45:23

Upper 700MHz Band

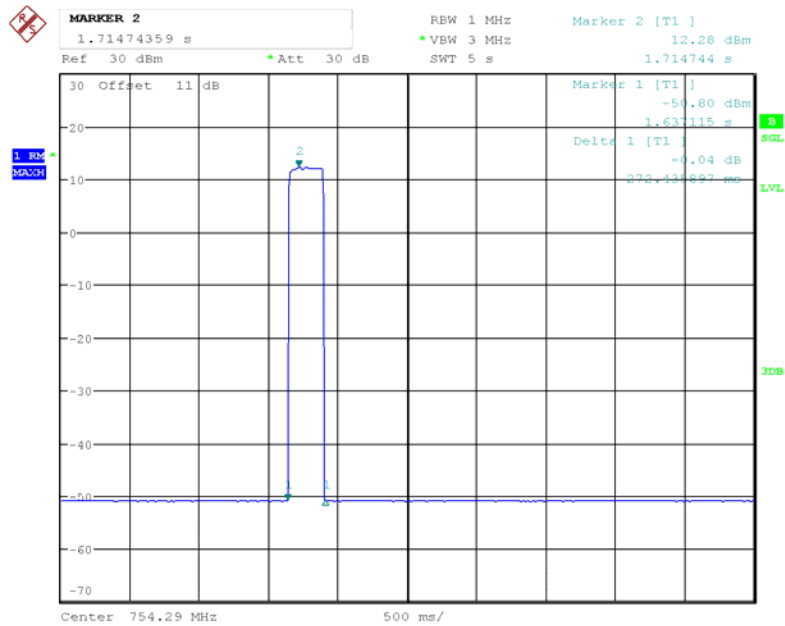

Date: 20.MAY.2018 14:25:40

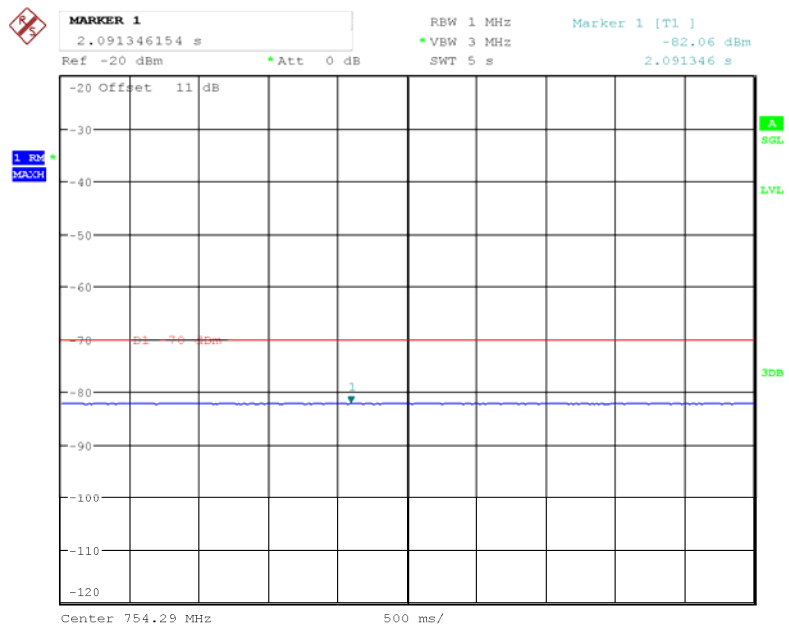

Date: 31.MAY.2018 22:33:01

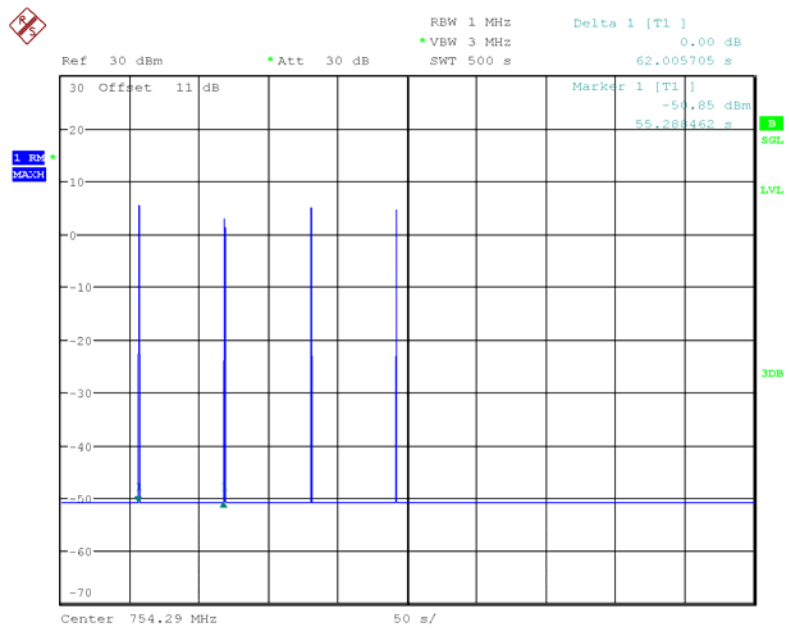

Date: 20.MAY.2018 14:34:57

Cellular Band

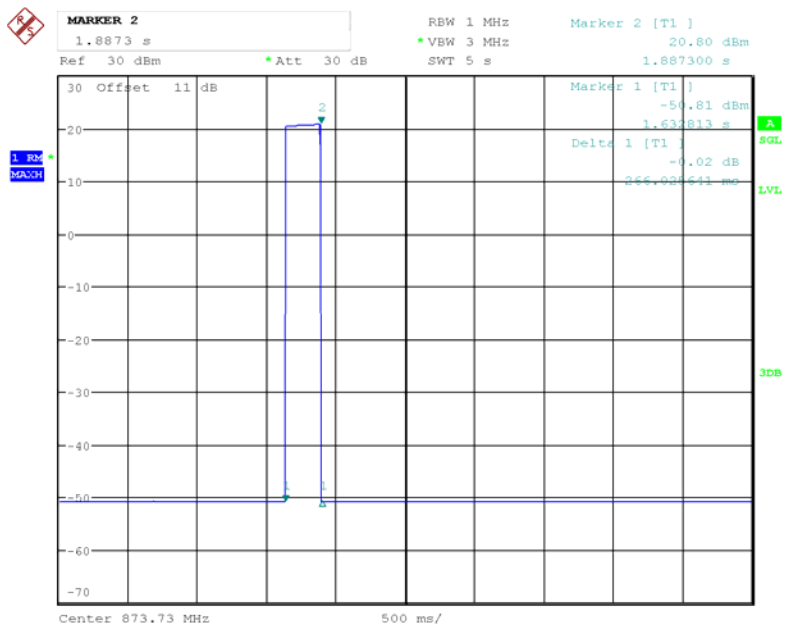

Date: 27.MAY.2018 15:55:15

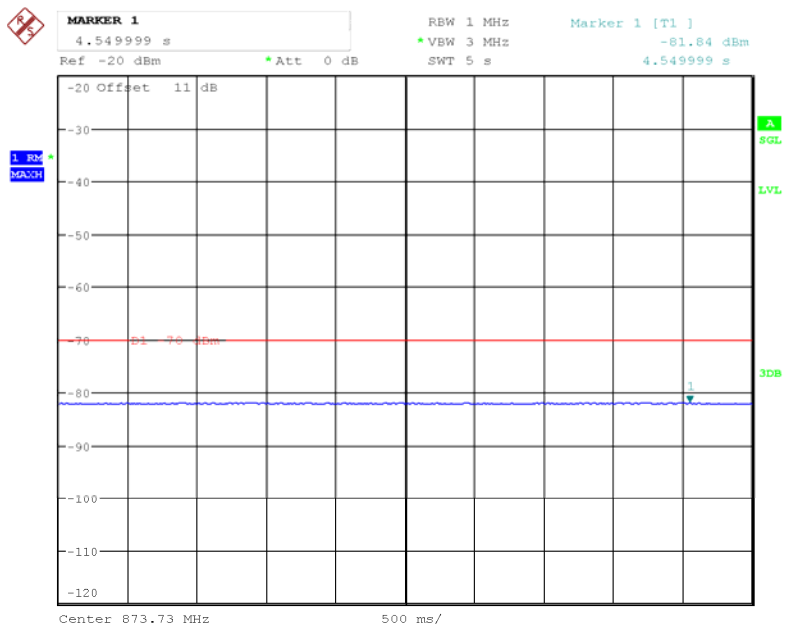

Date: 27.MAY.2018 19:49:42

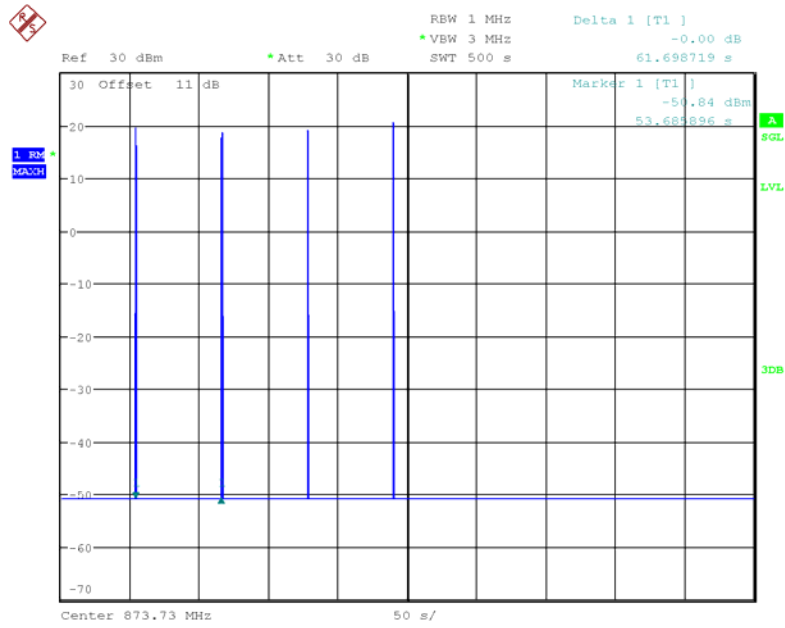

Date: 27.MAY.2018 16:06:59

AWS Band

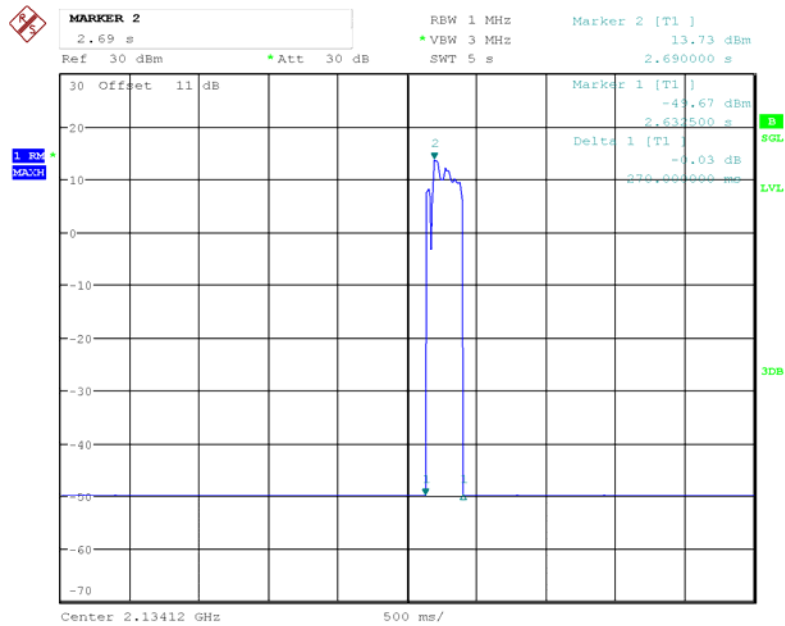

Date: 24.MAY.2018 18:41:41

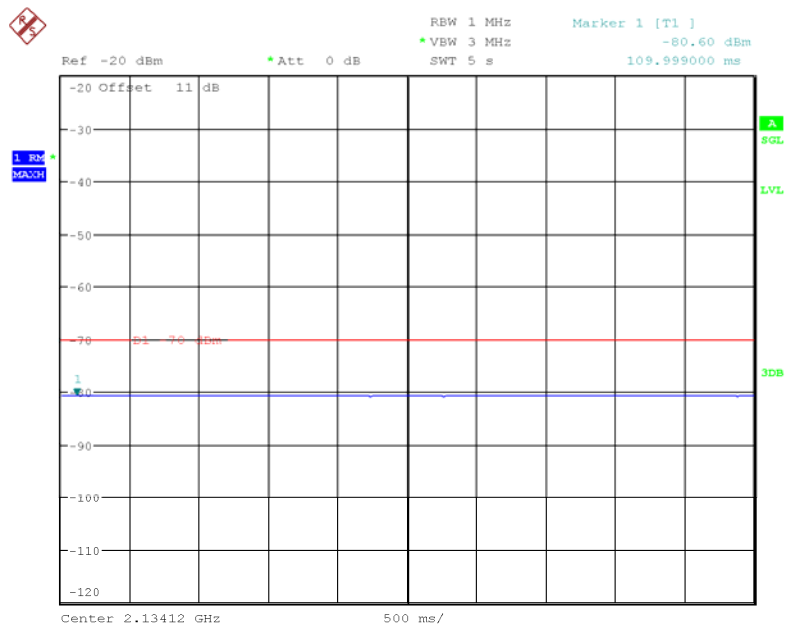

Date: 27.MAY.2018 19:48:42

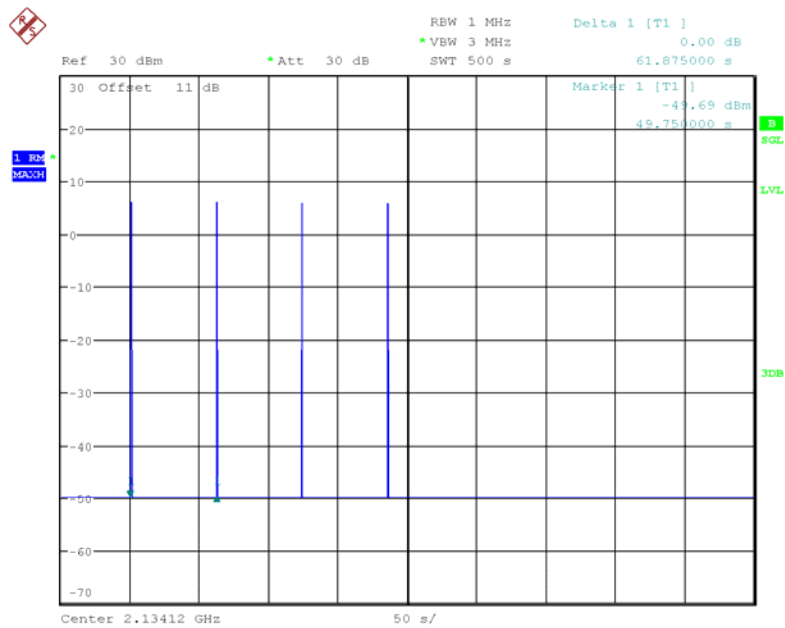

Date: 24.MAY.2018 19:48:02

PCS Band

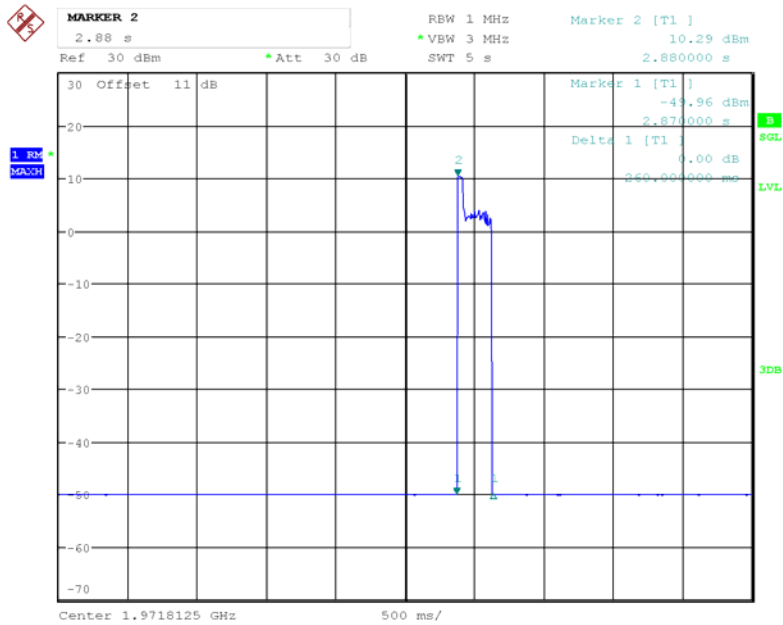

Date: 24.MAY.2018 19:56:30

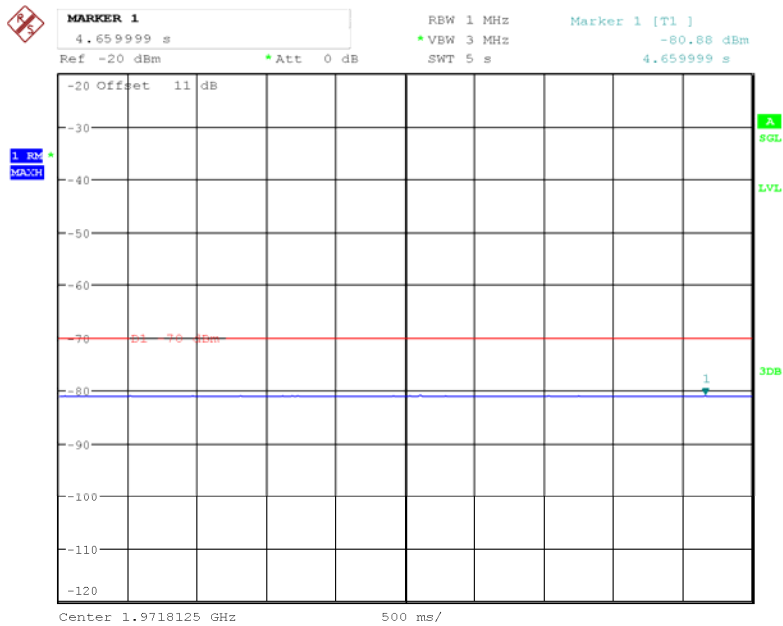

Date: 27.MAY.2018 19:54:22

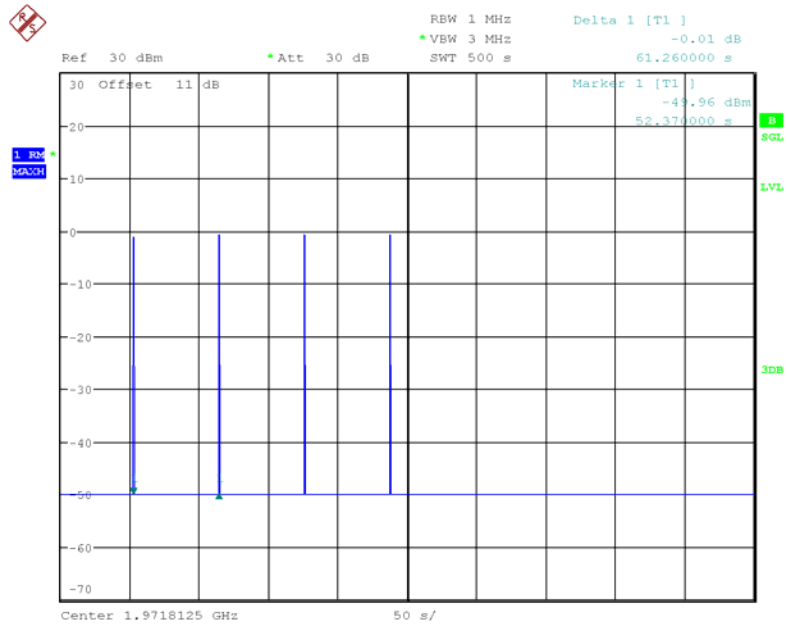

Date: 24.MAY.2018 20:07:32

Uplink:

Lower 700MHz Band

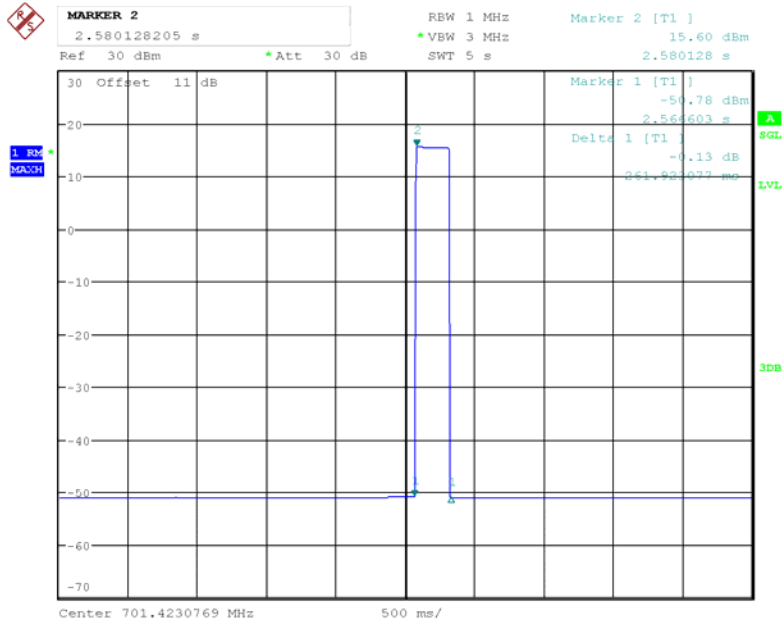

Date: 23.MAY.2018 18:43:56

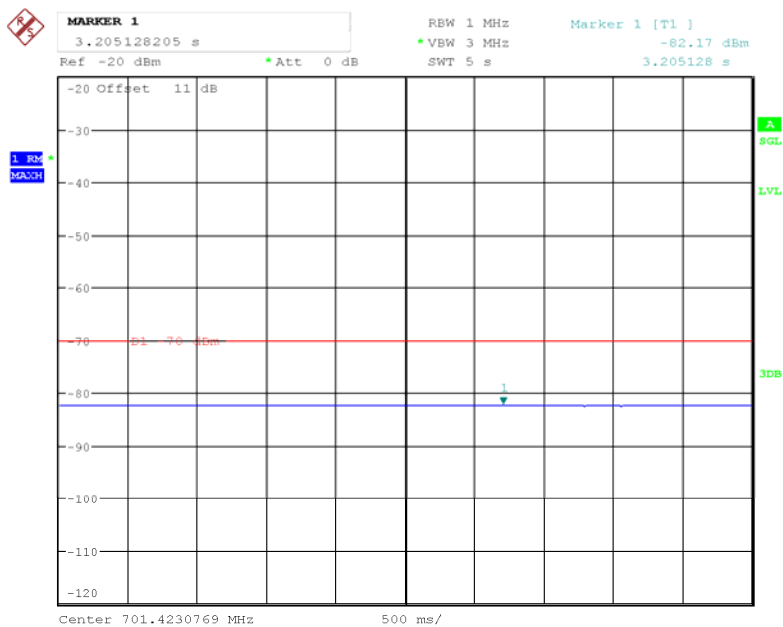

Date: 23.MAY.2018 19:24:32

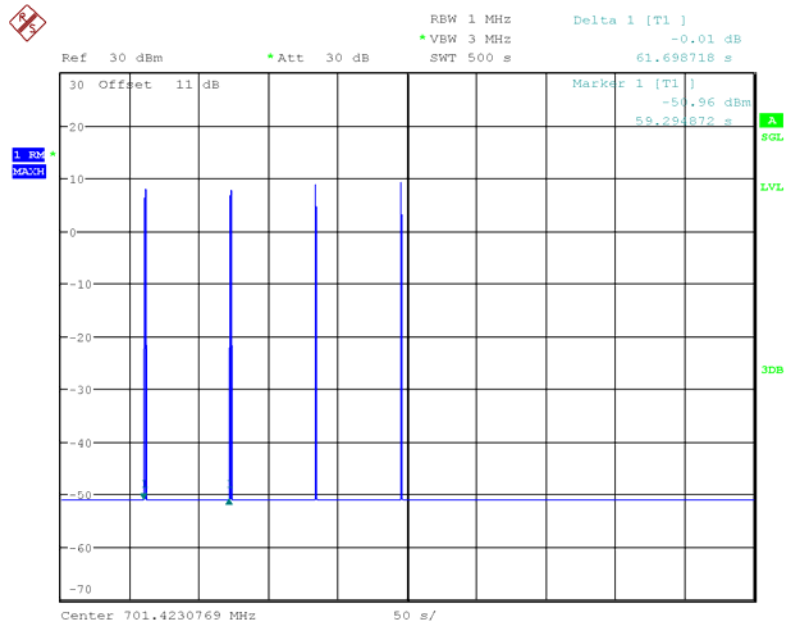

Date: 23.MAY.2018 19:22:36

Upper 700MHz Band

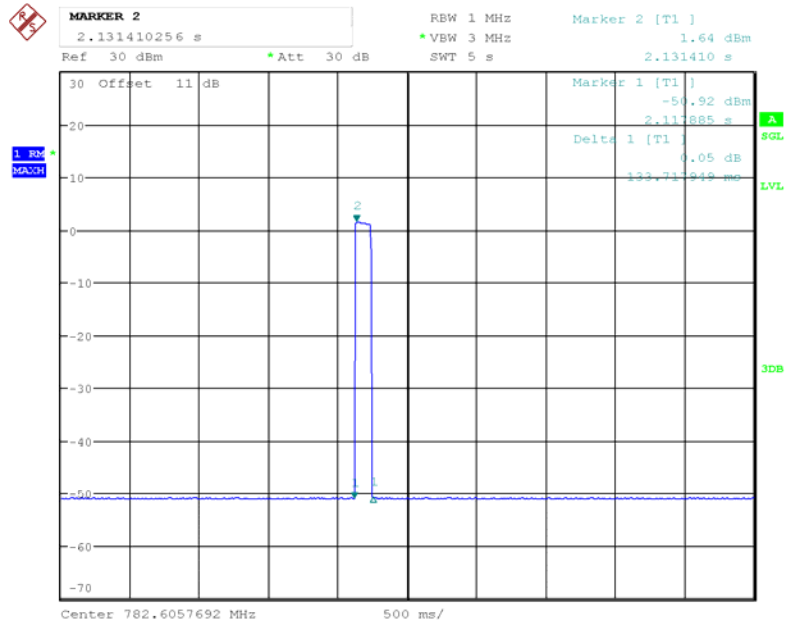

Date: 23.MAY.2018 19:58:01

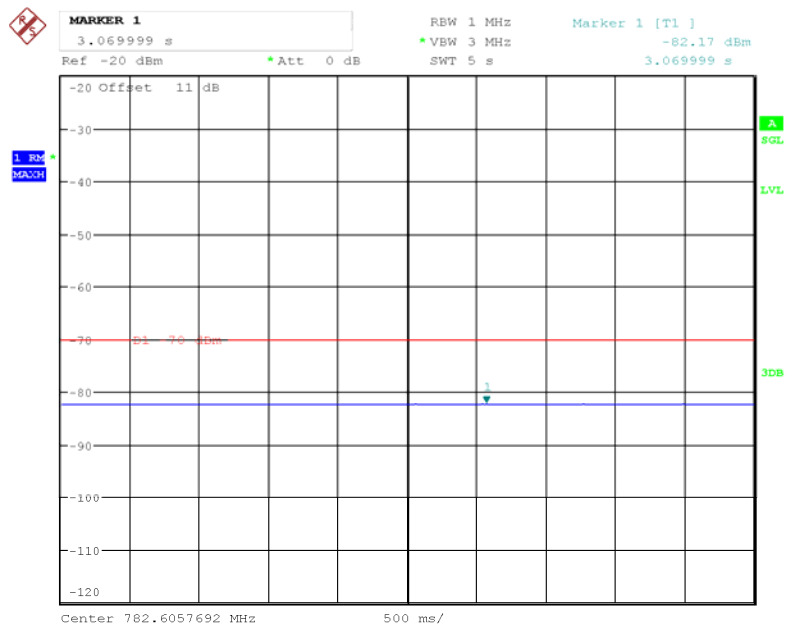

Date: 27.MAY.2018 19:53:17

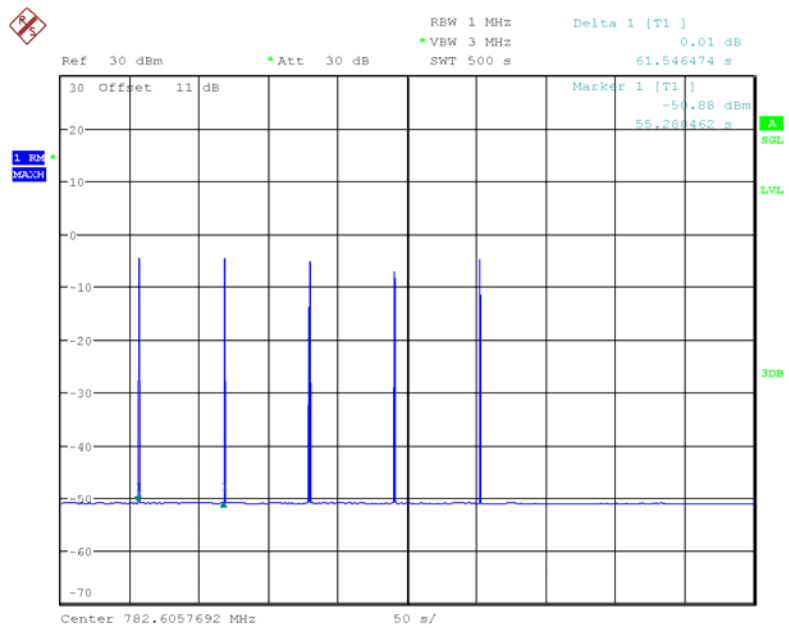

Date: 23.MAY.2018 20:08:03

Cellular Band

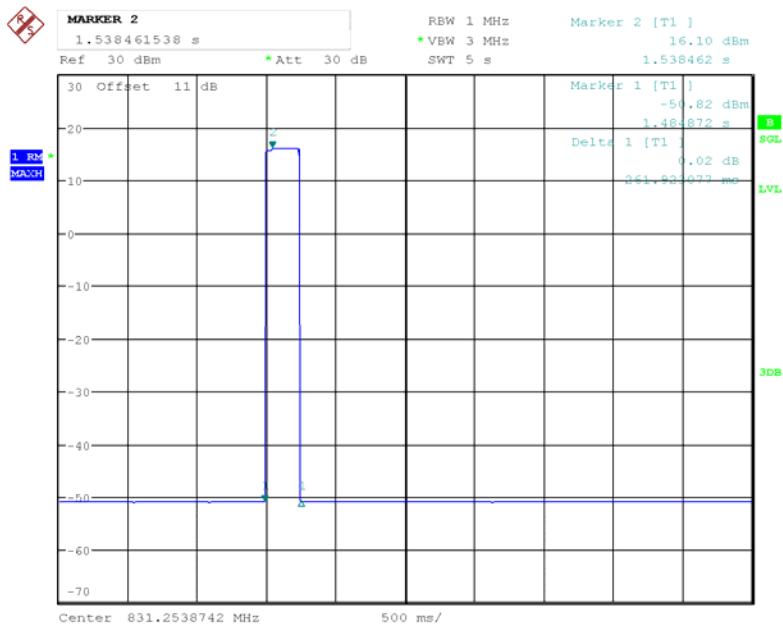

Date: 20.MAY.2018 13:52:24

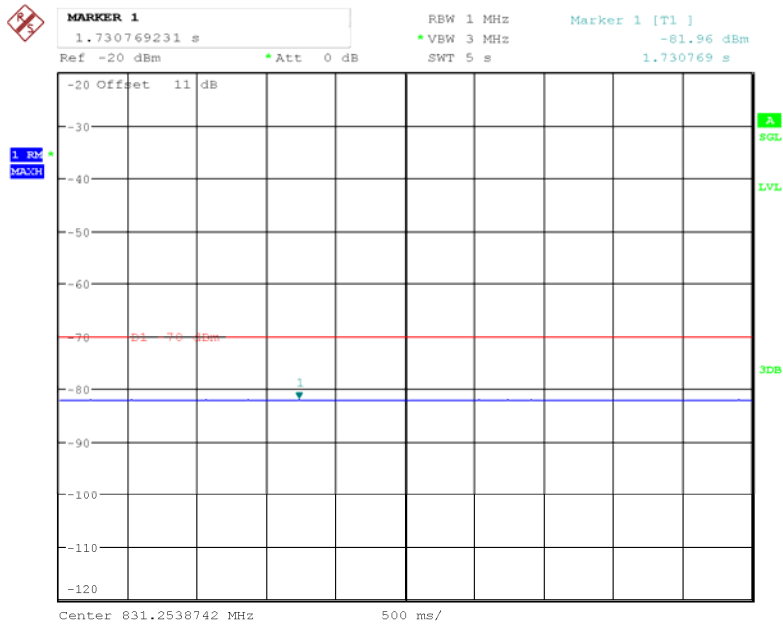

Date: 31.MAY.2018 22:30:21

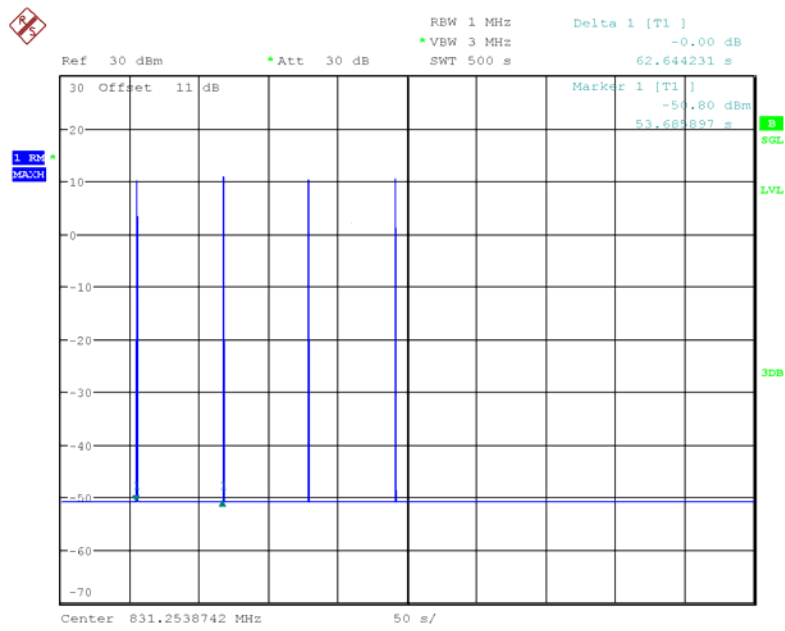

Date: 20.MAY.2018 14:03:58

AWS Band

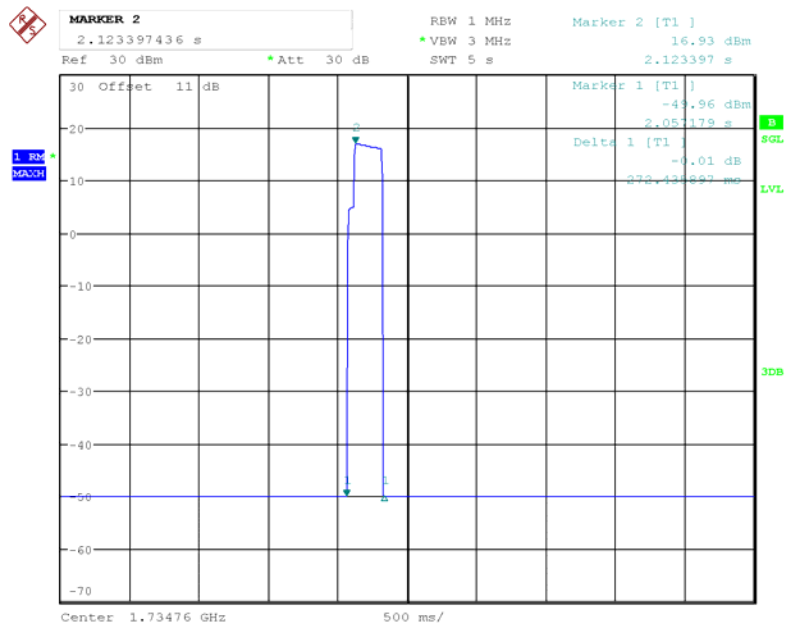

Date: 20.MAY.2018 14:06:37

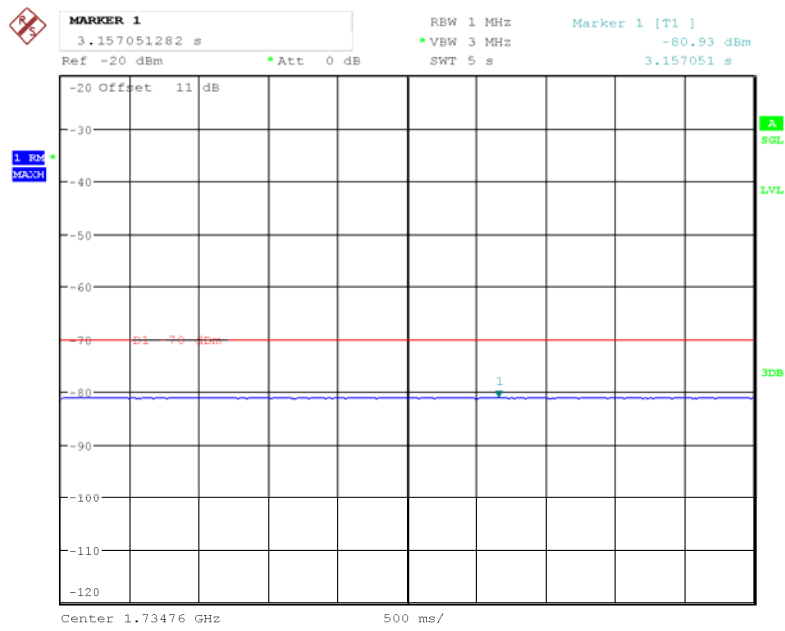

Date: 31.MAY.2018 22:31:24

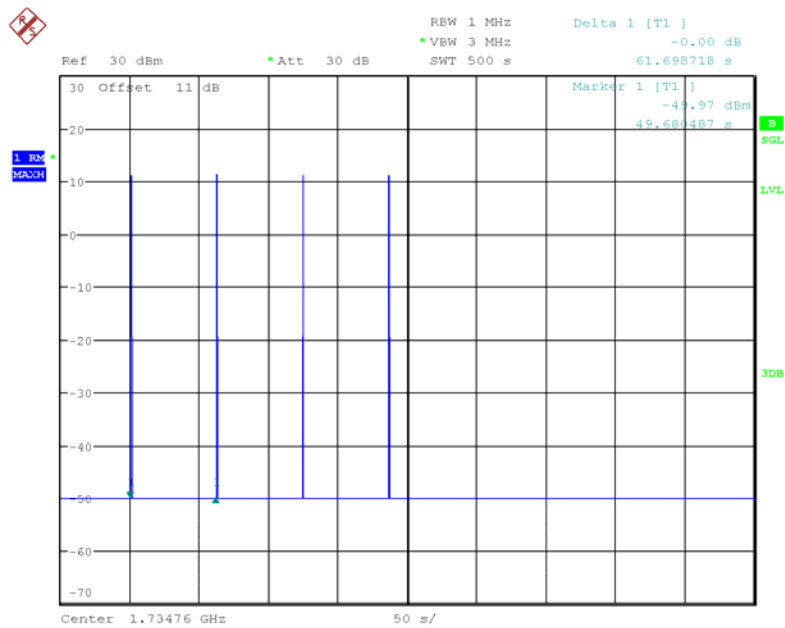

Date: 20.MAY.2018 14:17:21

PCS Band

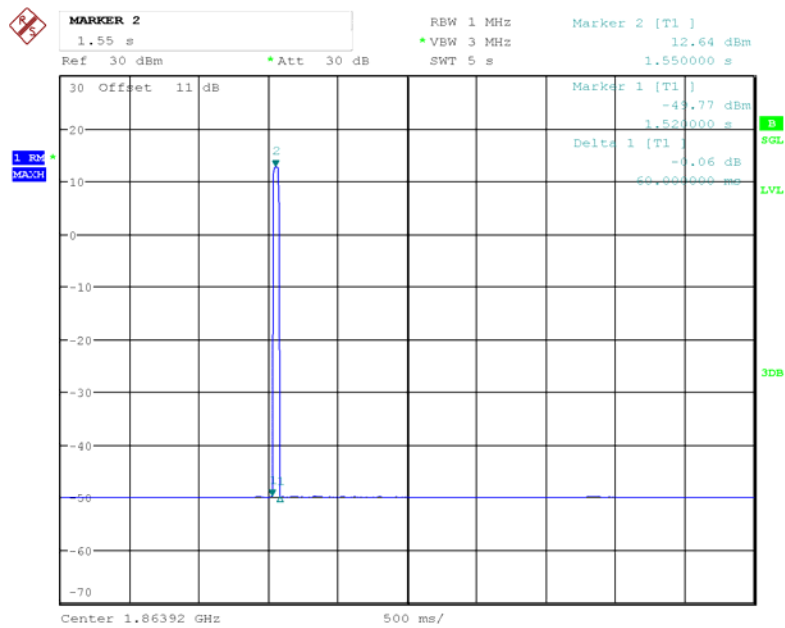

Date: 24.MAY.2018 17:35:10

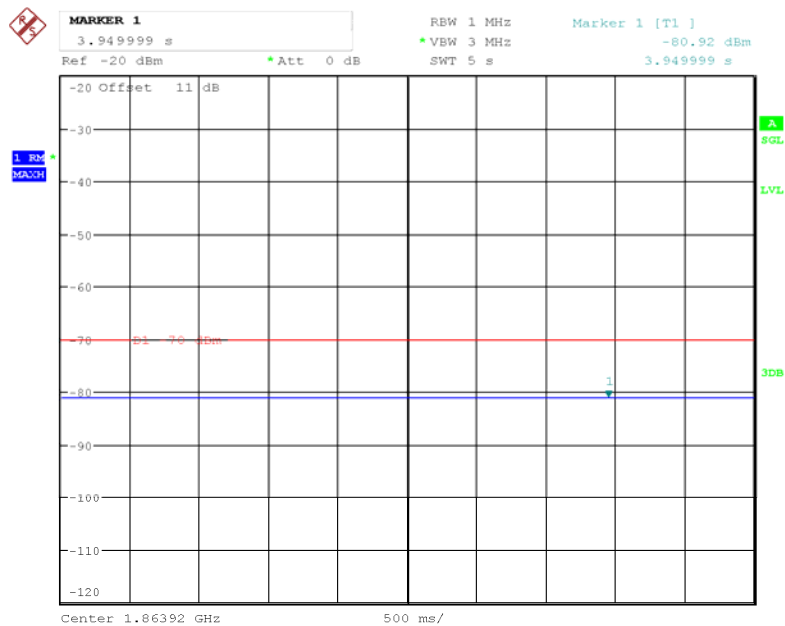

Date: 27.MAY.2018 19:55:14

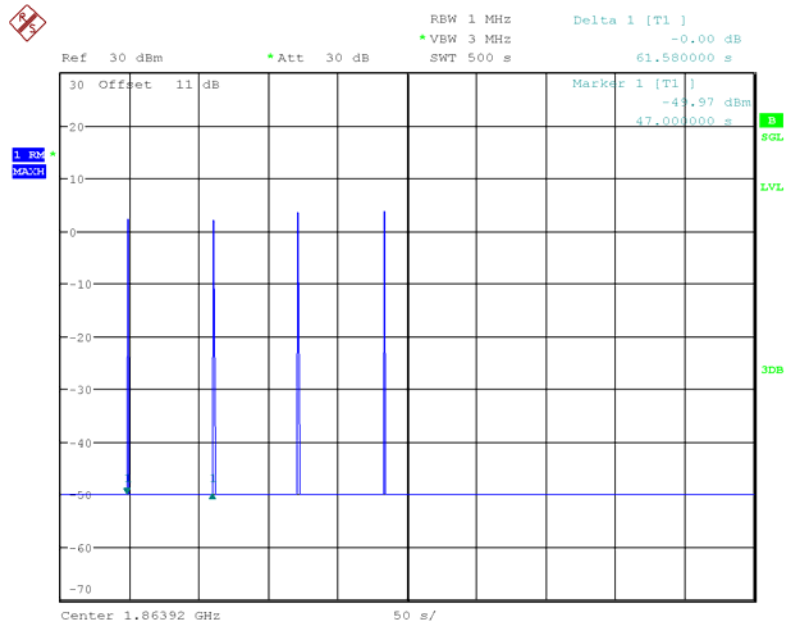

Date: 24.MAY.2018 17:45:00

**Oscillation mitigation or shutdown:
Downlink:**

Lower 700MHz Band

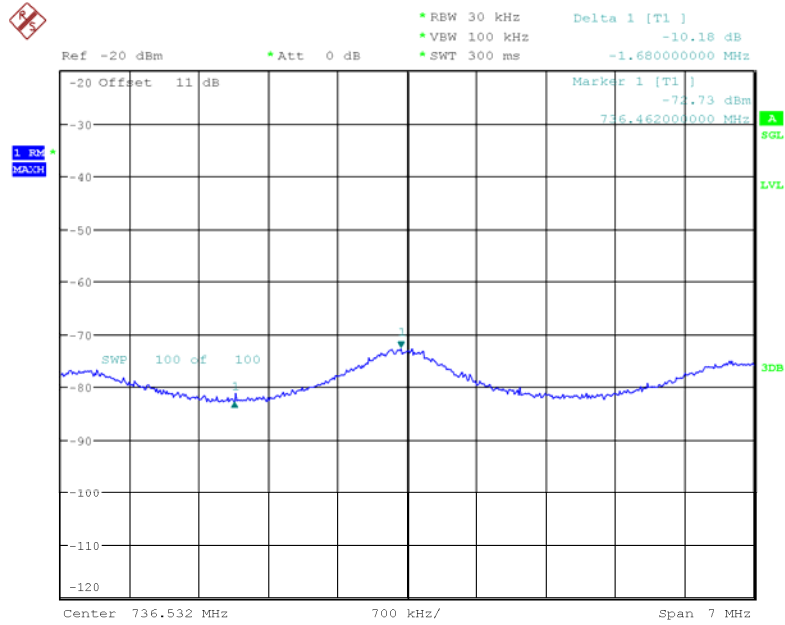

Date: 27.MAY.2018 11:24:23

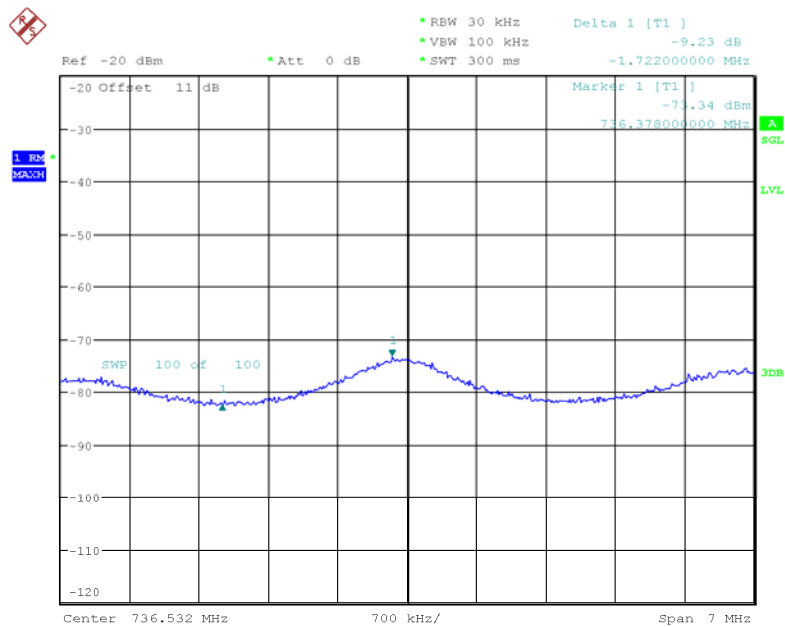

Date: 27.MAY.2018 11:25:18

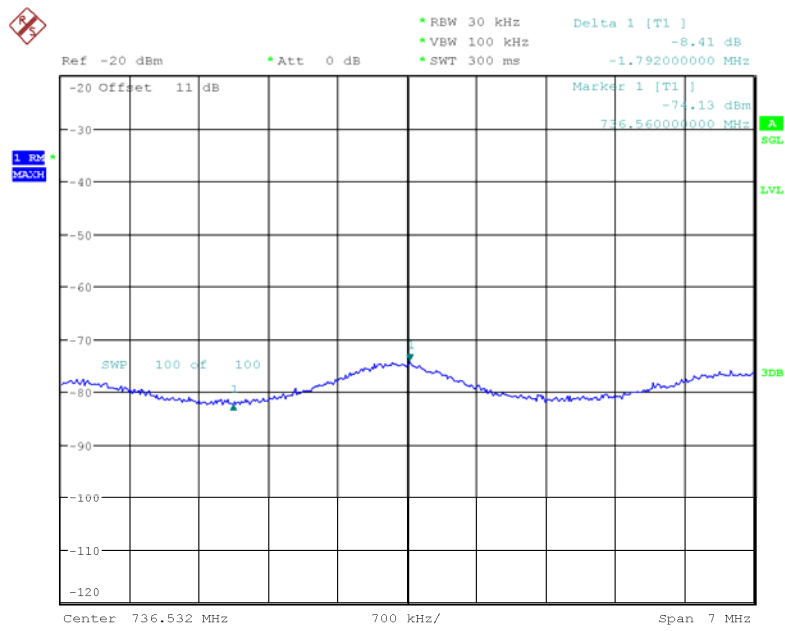

Date: 27.MAY.2018 11:26:10

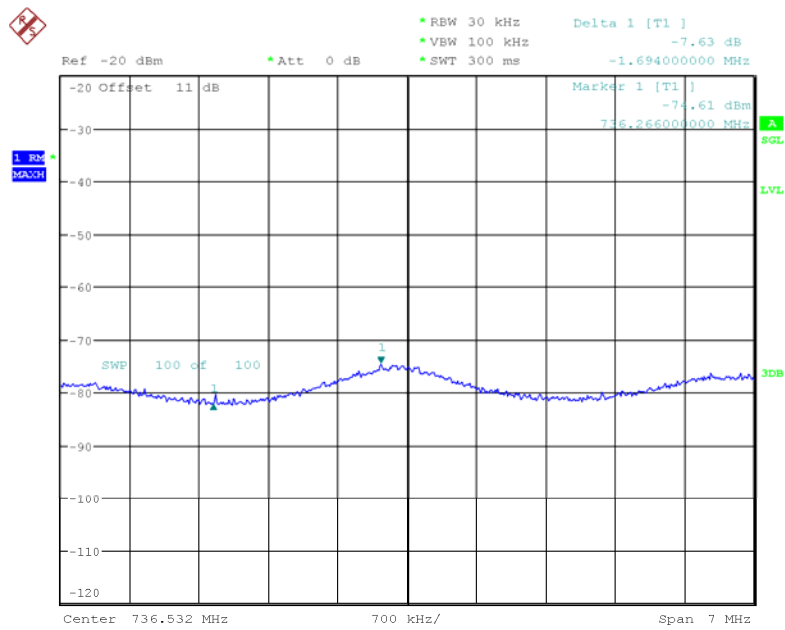

Date: 27.MAY.2018 11:27:03

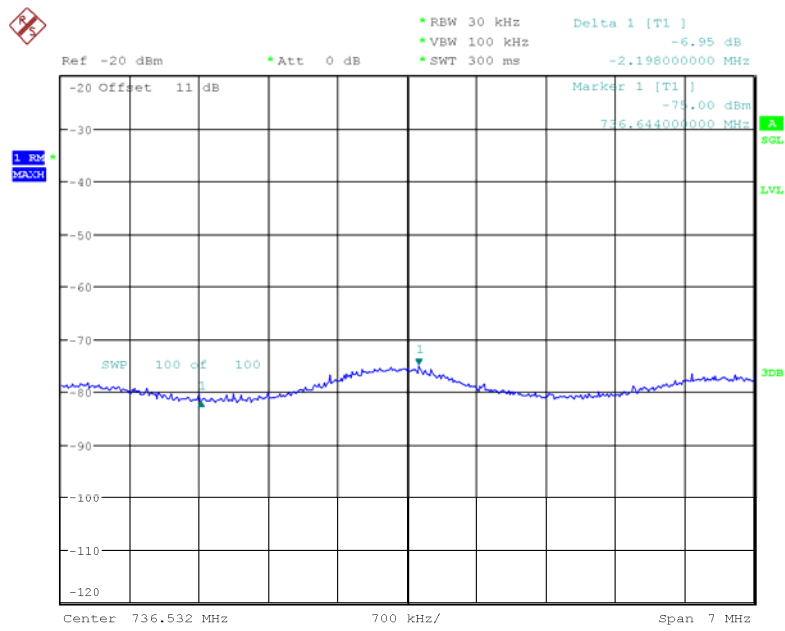

Date: 27.MAY.2018 11:29:00

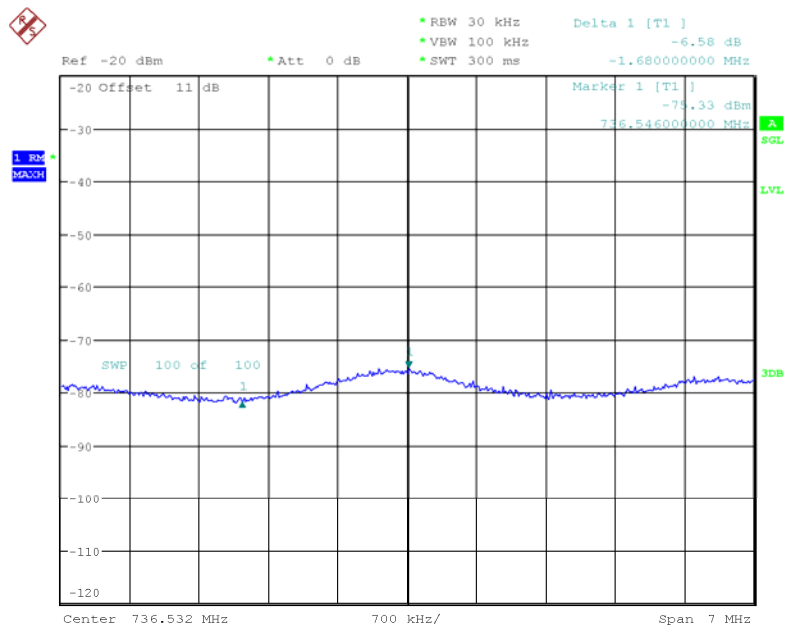

Date: 27.MAY.2018 11:29:52

Upper 700MHz Band

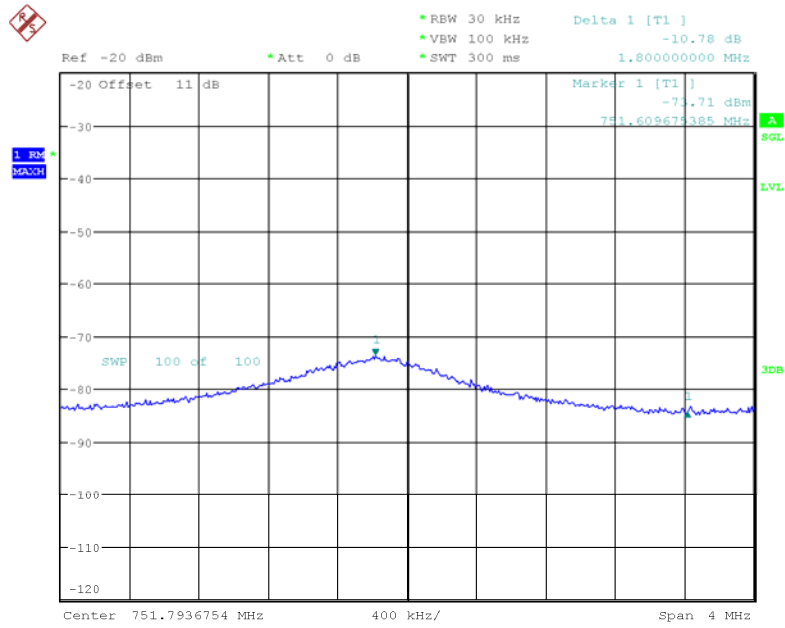

Date: 27.MAY.2018 11:42:14

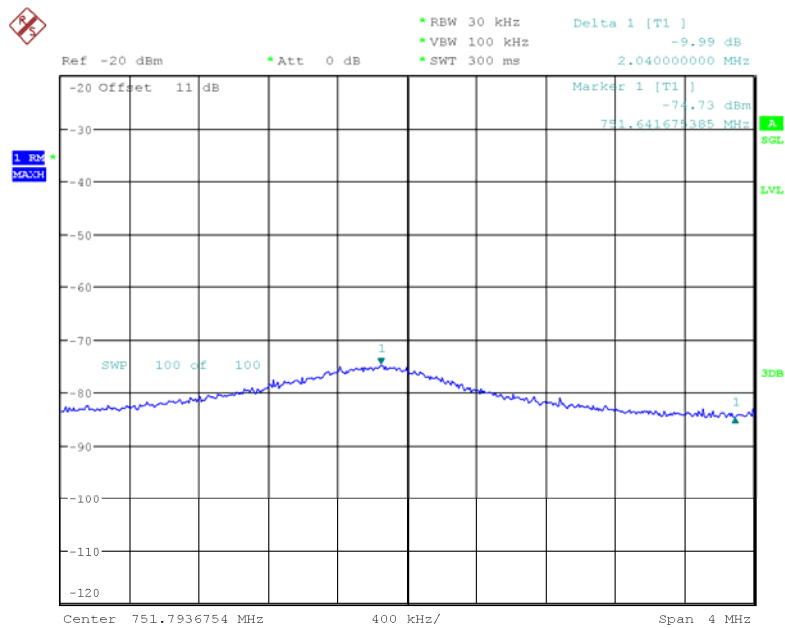

Date: 27.MAY.2018 11:43:16

Cellular Band

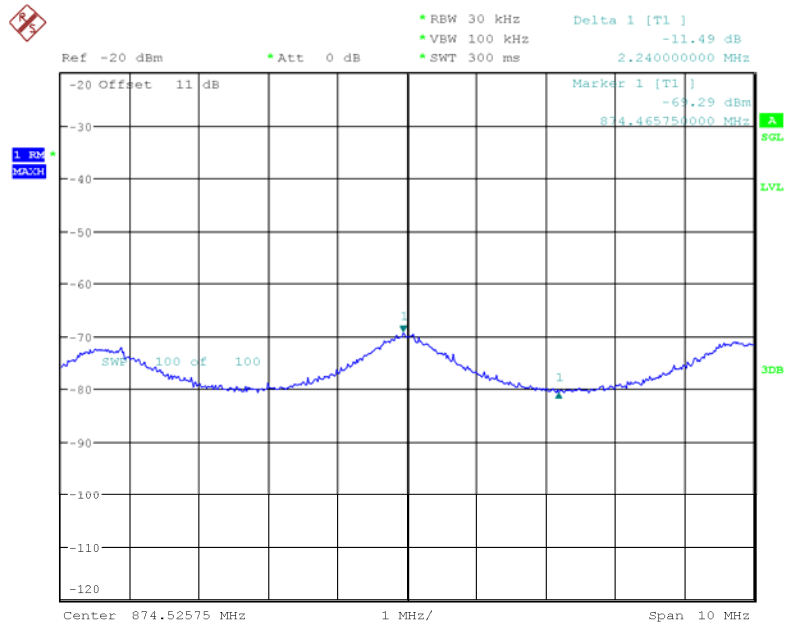

Date: 27.MAY.2018 11:56:30

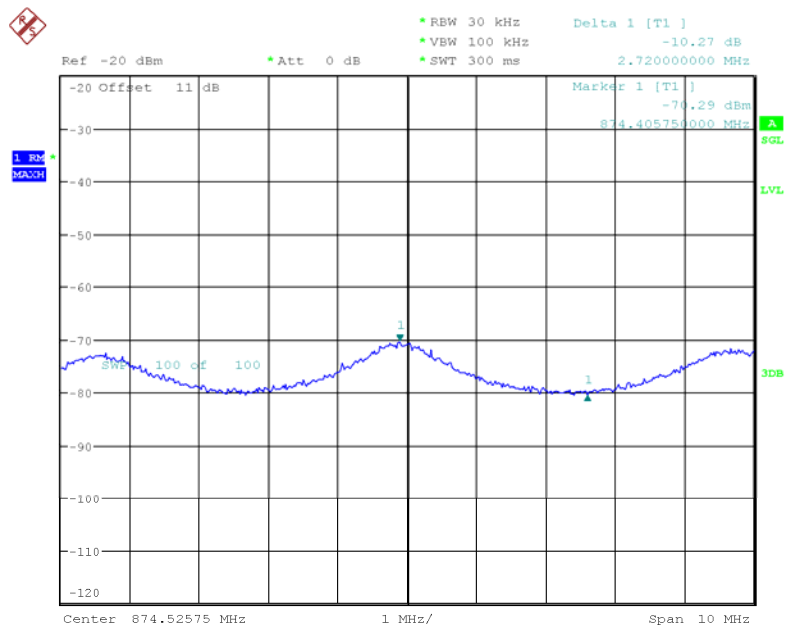

Date: 27.MAY.2018 11:57:41

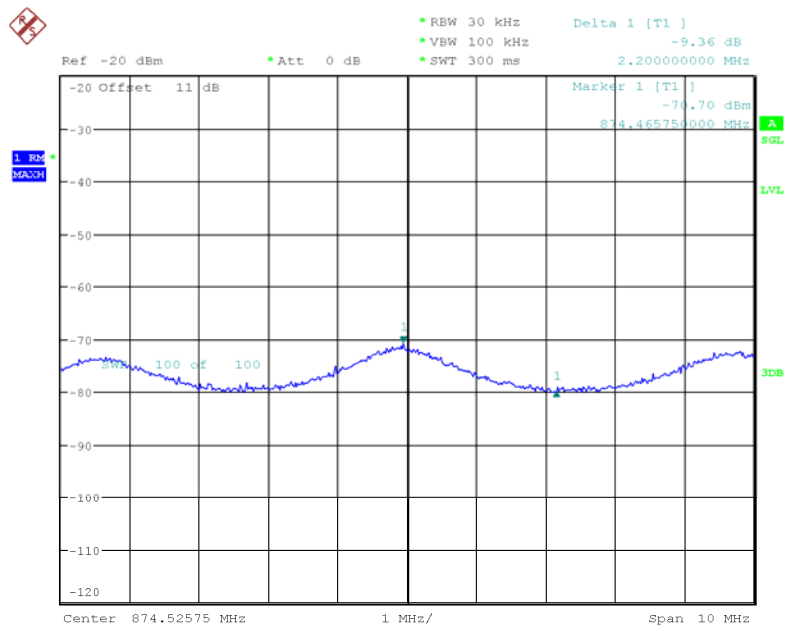

Date: 27.MAY.2018 11:58:41

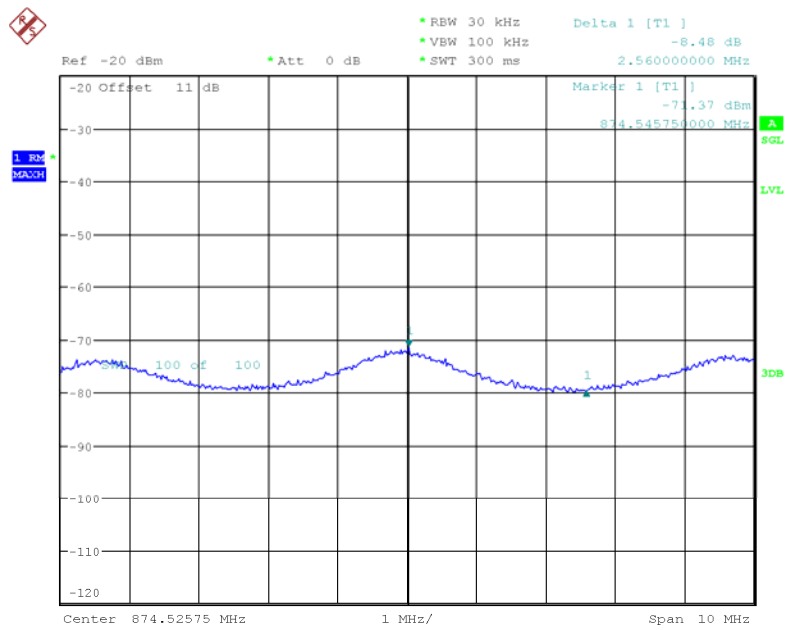

Date: 27.MAY.2018 11:59:55

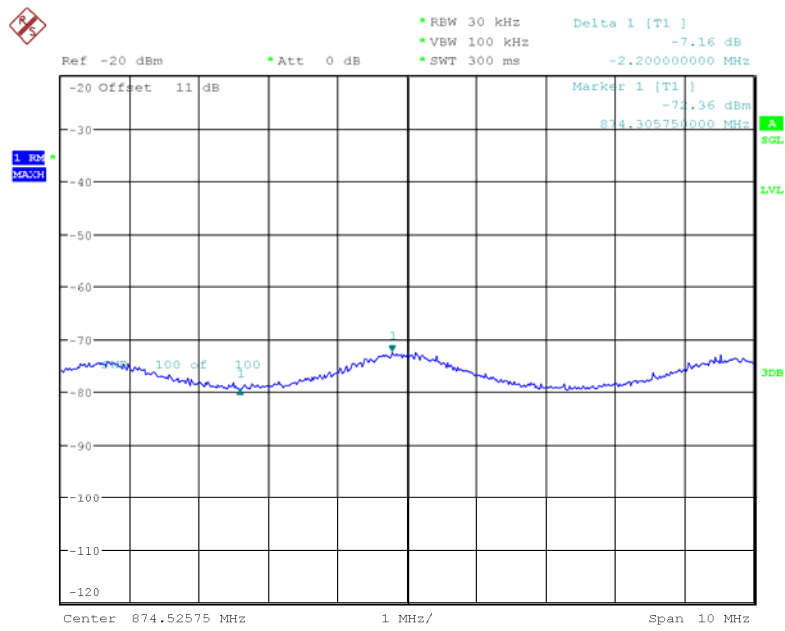

Date: 27.MAY.2018 12:00:56

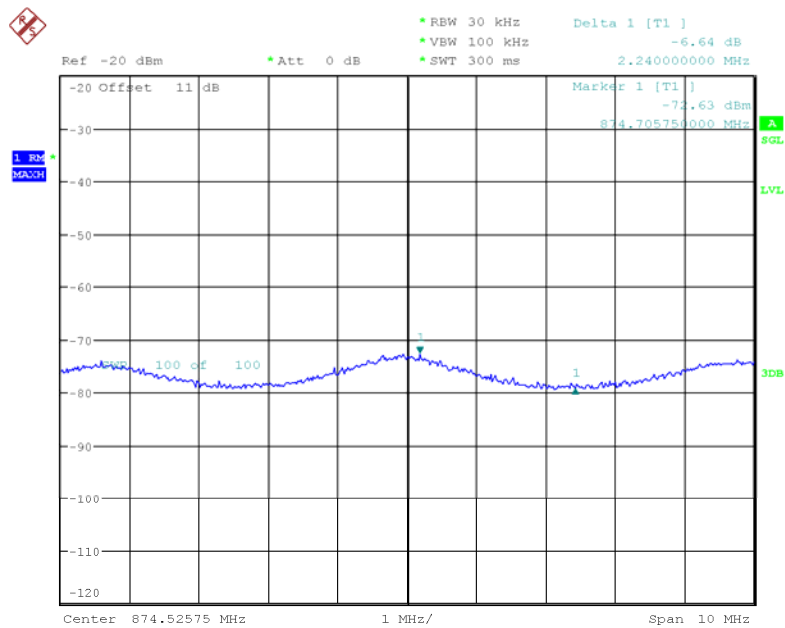

Date: 27.MAY.2018 12:01:53

AWS Band

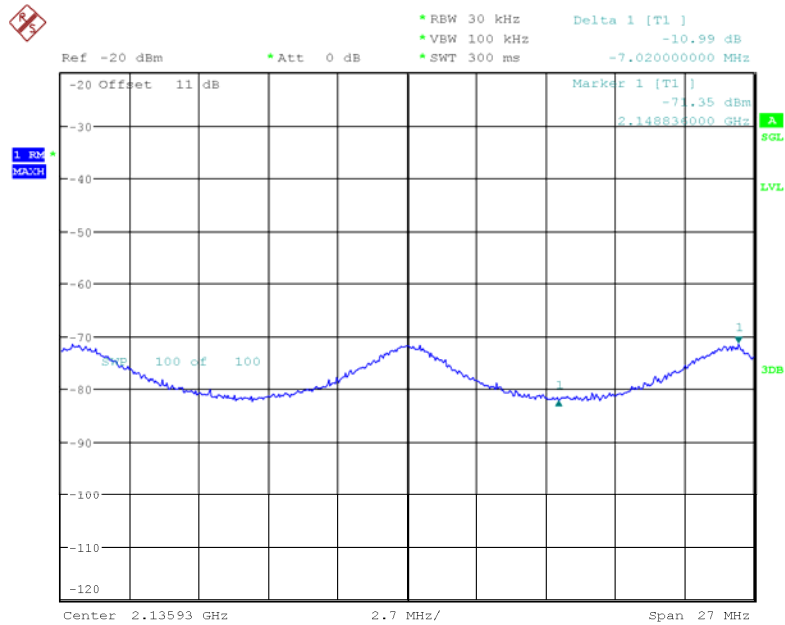

Date: 27.MAY.2018 13:22:55

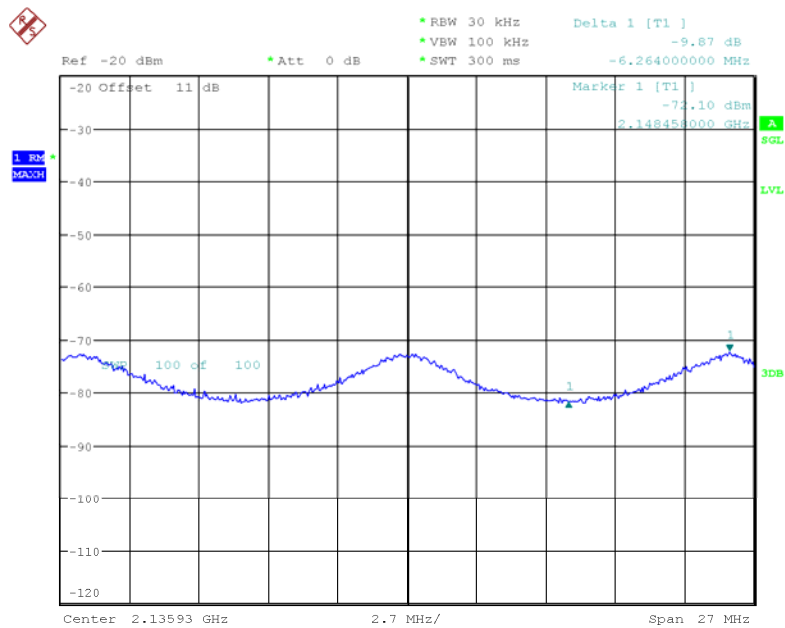

Date: 27.MAY.2018 13:24:28

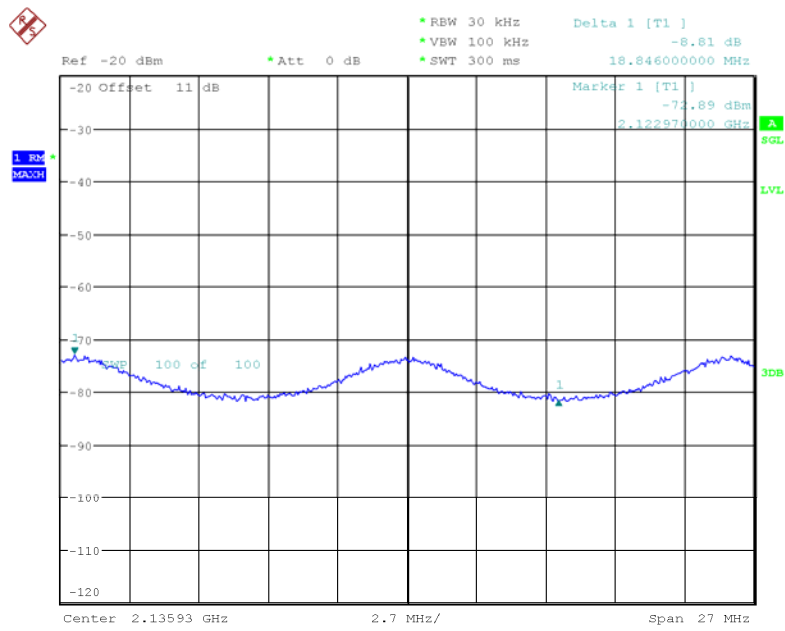

Date: 27.MAY.2018 13:25:37

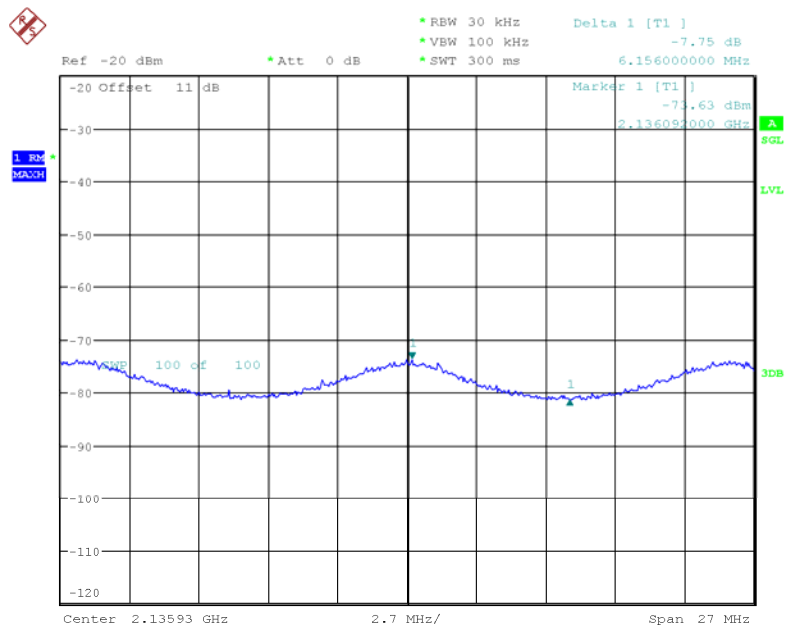

Date: 27.MAY.2018 13:27:33

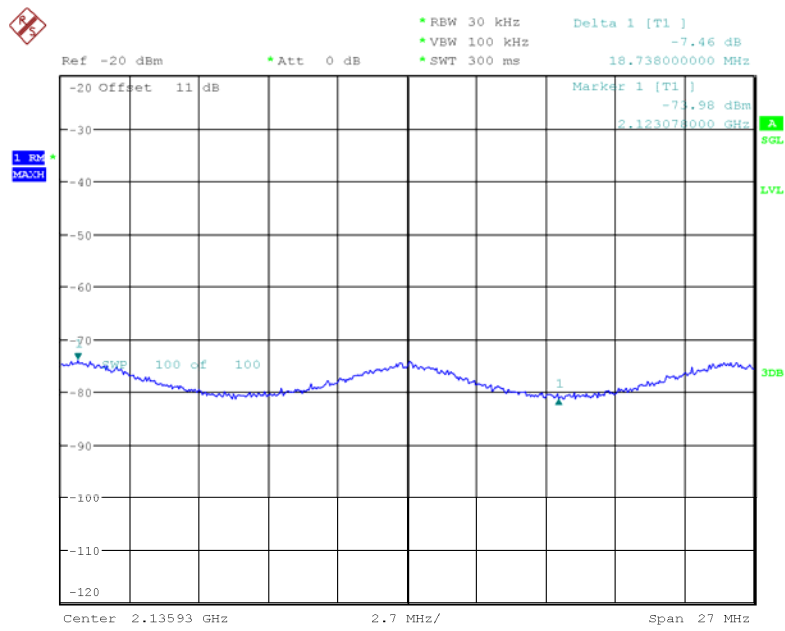

Date: 27.MAY.2018 13:29:37

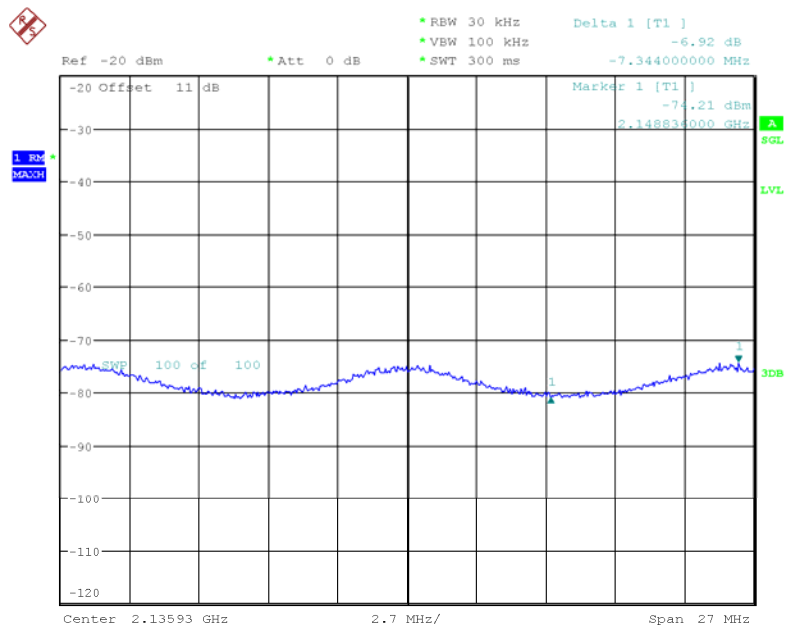

Date: 27.MAY.2018 13:30:50

PCS Band

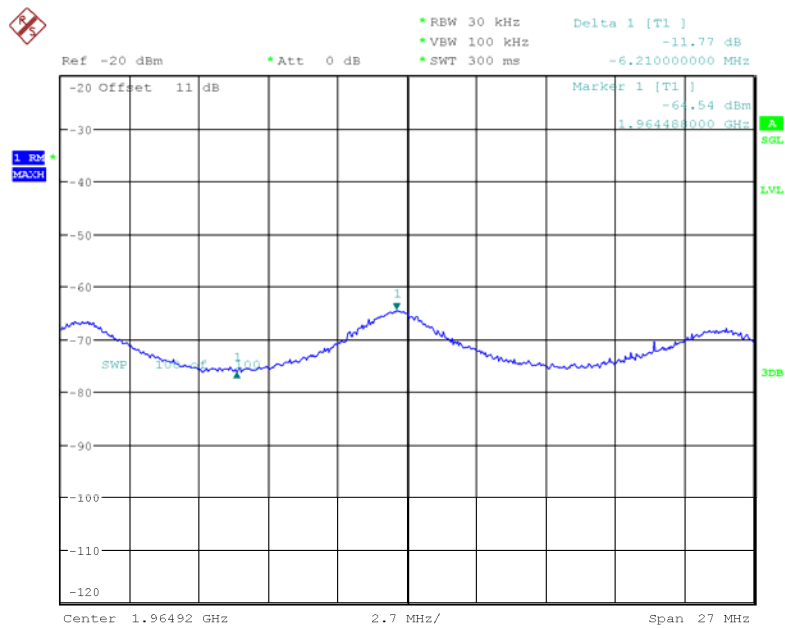

Date: 27.MAY.2018 13:10:23

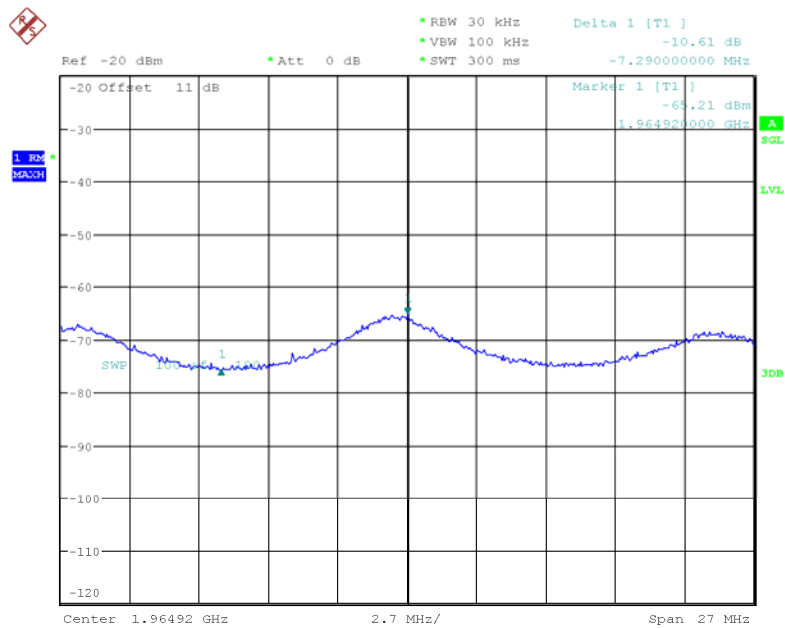

Date: 27.MAY.2018 13:11:33

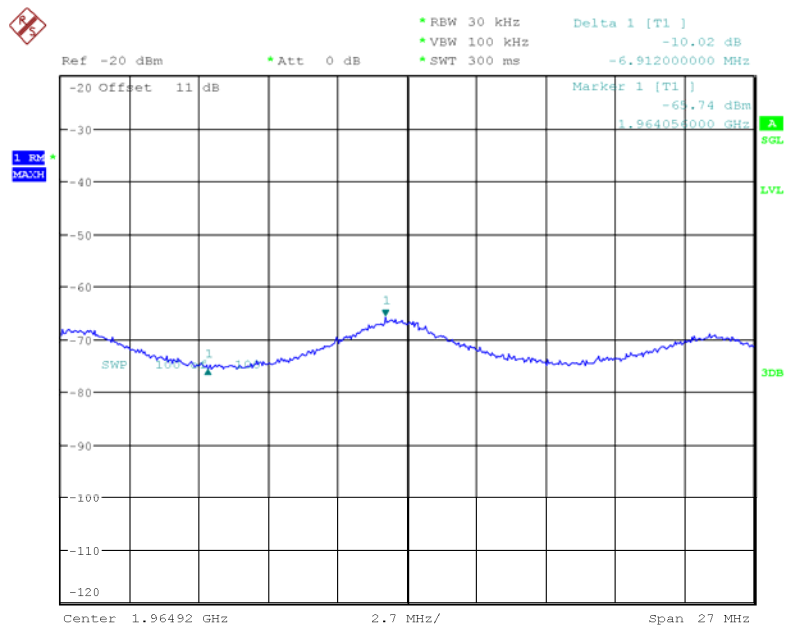

Date: 27.MAY.2018 13:14:19

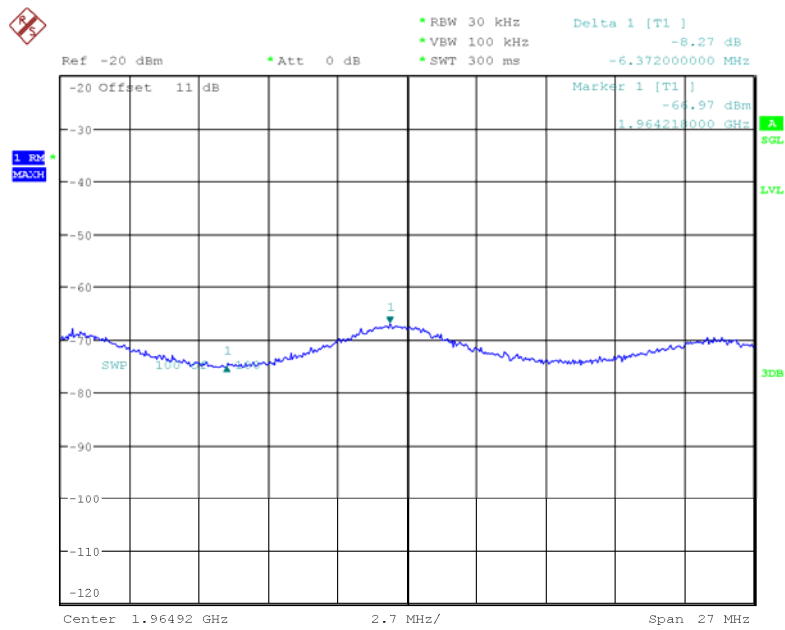

Date: 27.MAY.2018 13:15:22

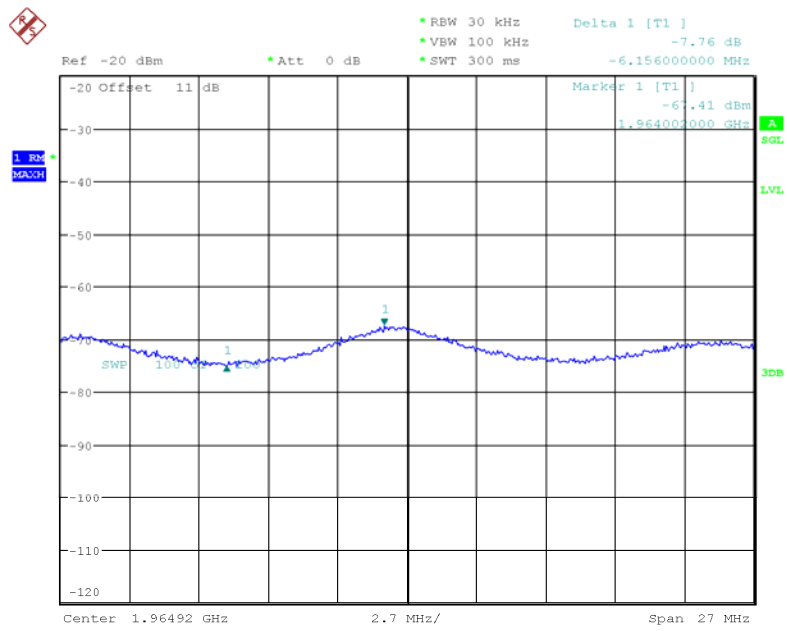

Date: 27.MAY.2018 13:16:14

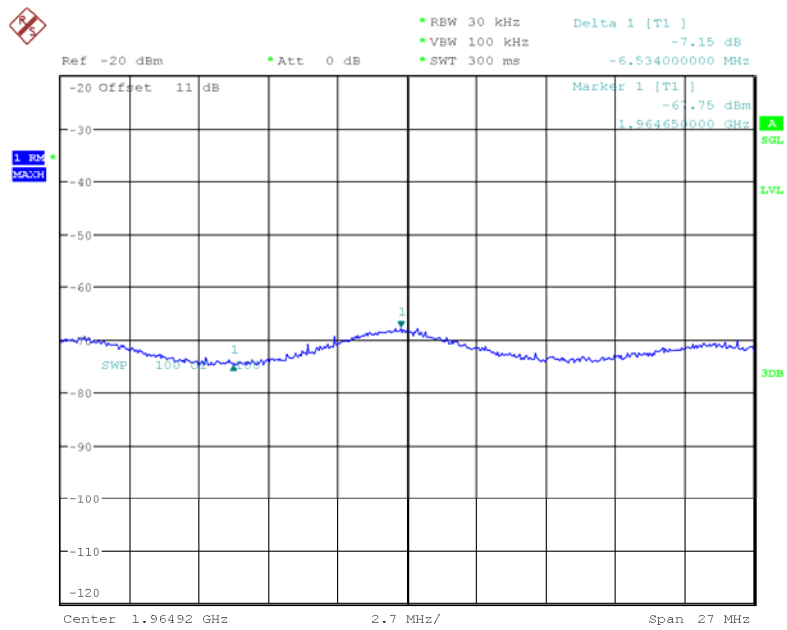

Date: 27.MAY.2018 13:17:12

Uplink:

Lower 700MHz Band

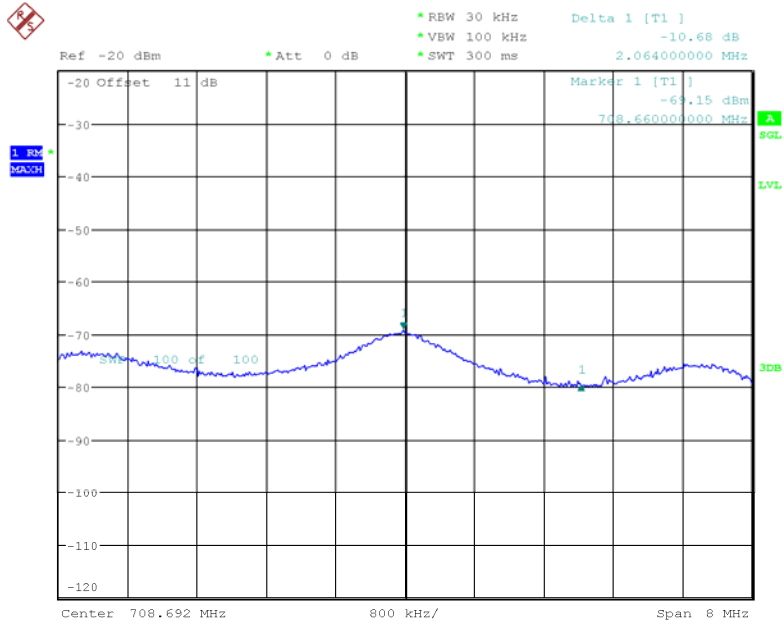

Date: 27.MAY.2018 11:02:37

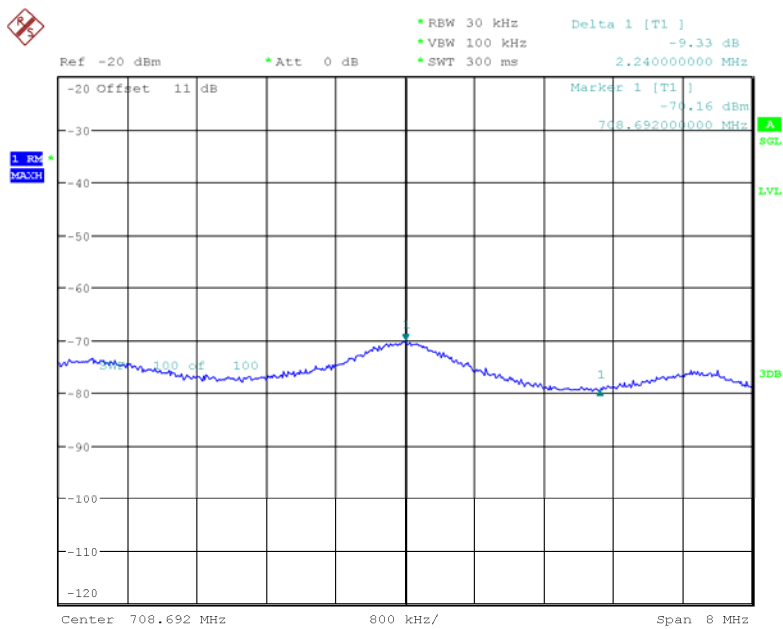

Date: 27.MAY.2018 11:04:15

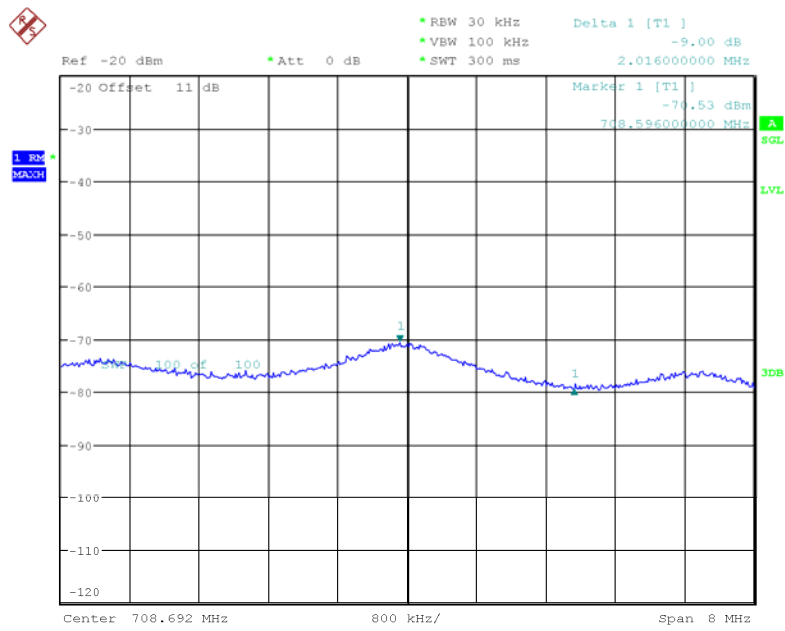

Date: 27.MAY.2018 11:05:11

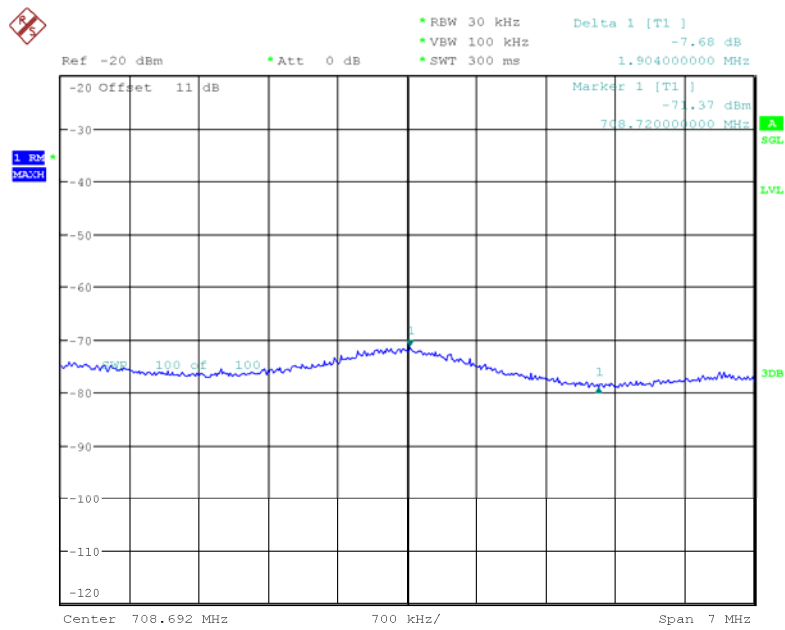

Date: 27.MAY.2018 11:08:54

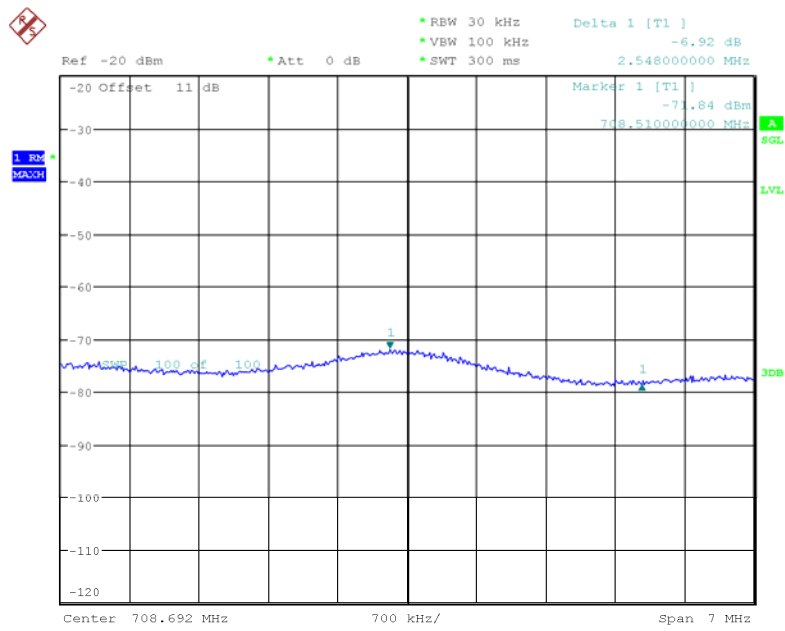

Date: 27.MAY.2018 11:09:49

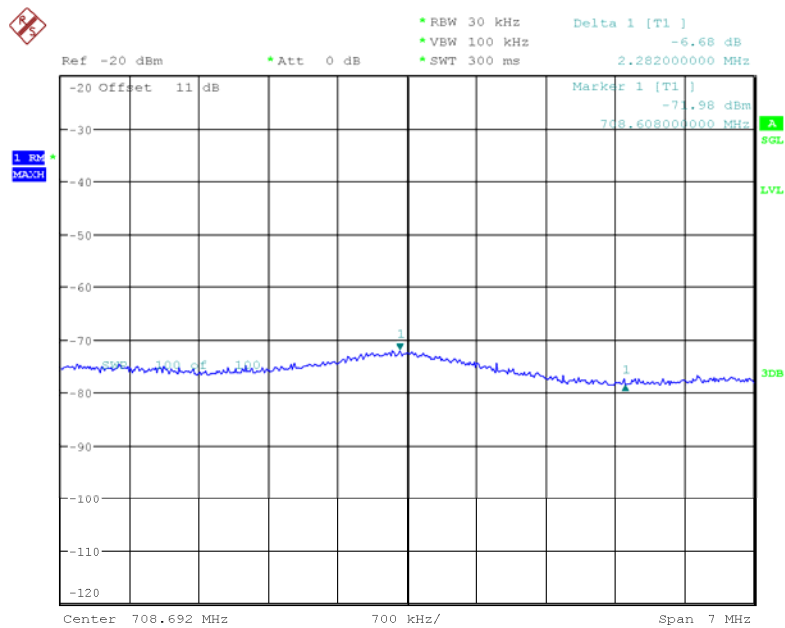

Date: 27.MAY.2018 11:11:58

Upper 700MHz Band

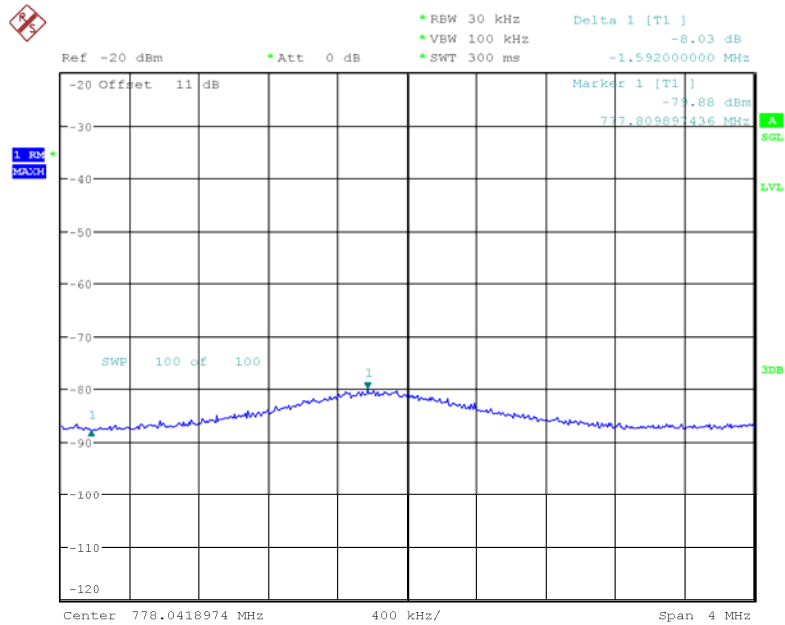

Date: 27.MAY.2018 10:36:28

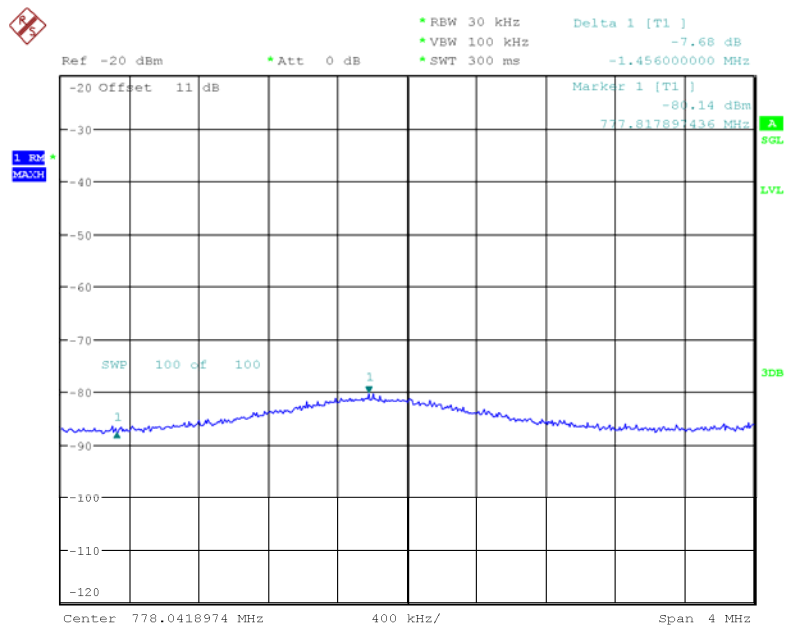

Date: 27.MAY.2018 10:38:12

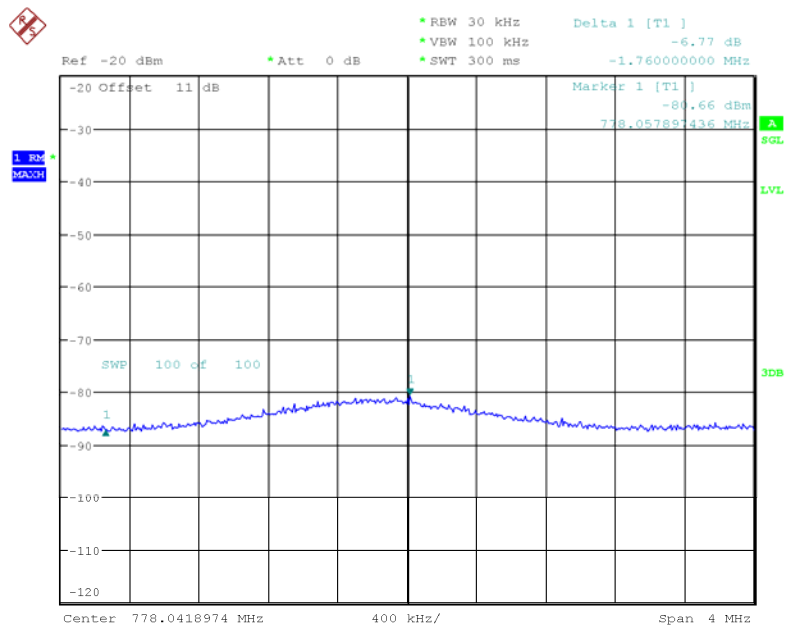

Date: 27.MAY.2018 10:40:03

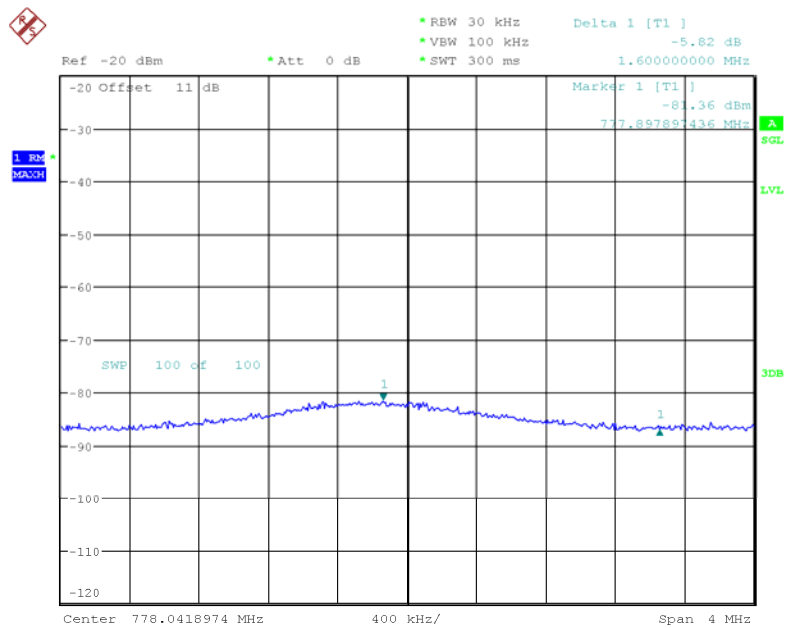

Date: 27.MAY.2018 10:41:21

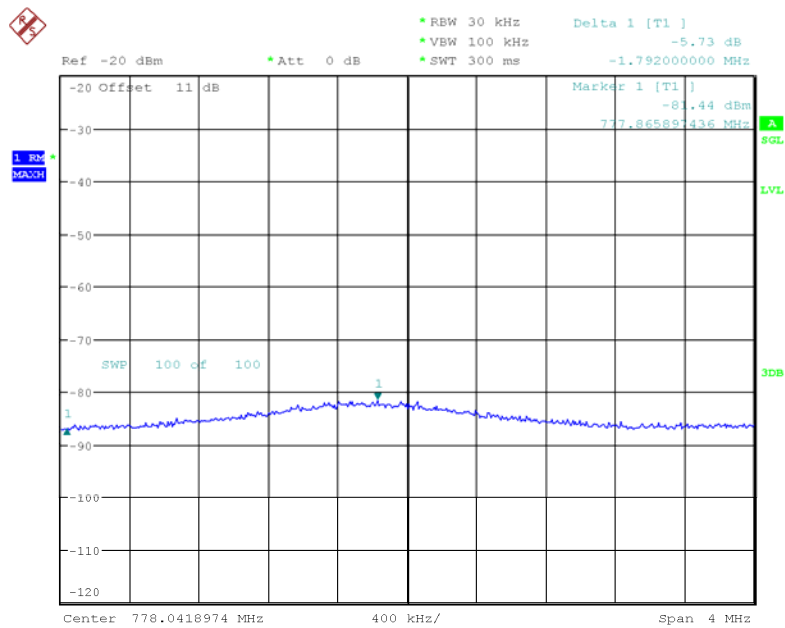

Date: 27.MAY.2018 10:42:53

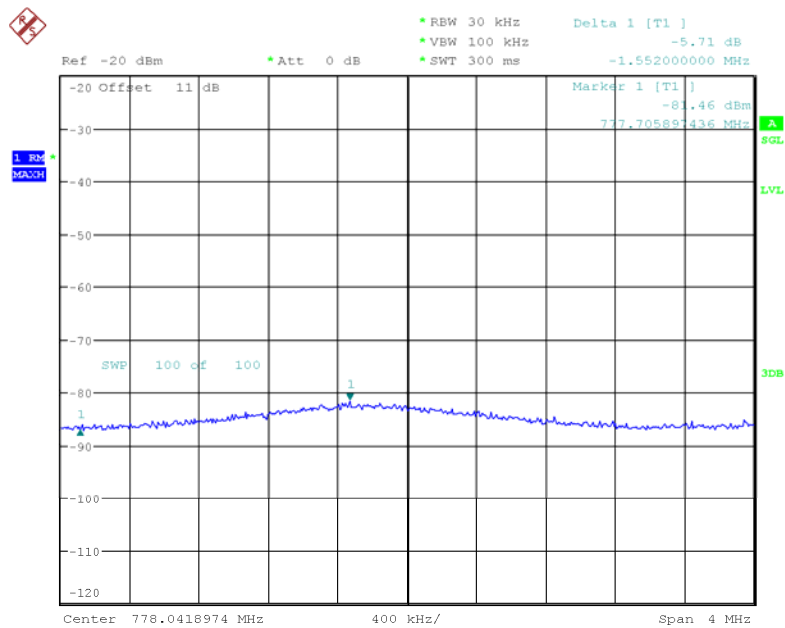

Date: 27.MAY.2018 10:44:59

Cellular Band

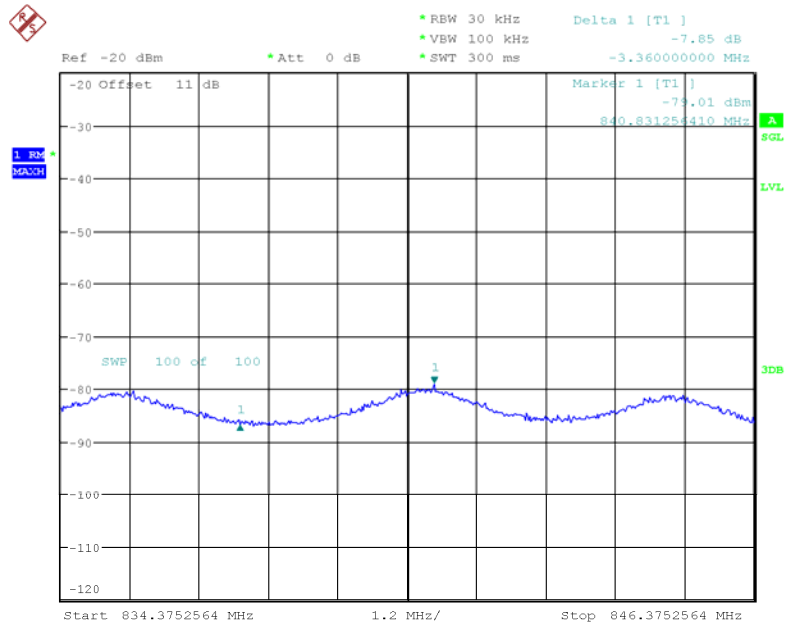

Date: 27.MAY.2018 10:17:12

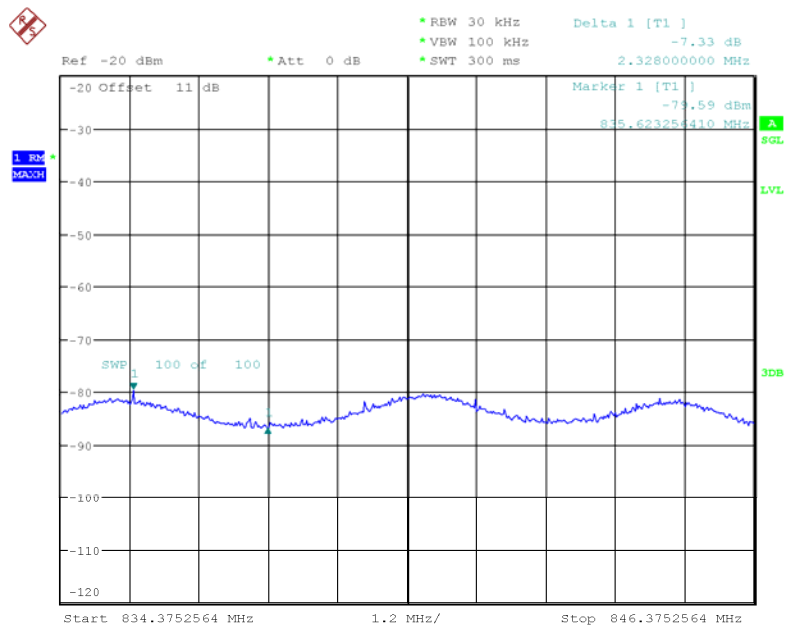

Date: 27.MAY.2018 10:18:53

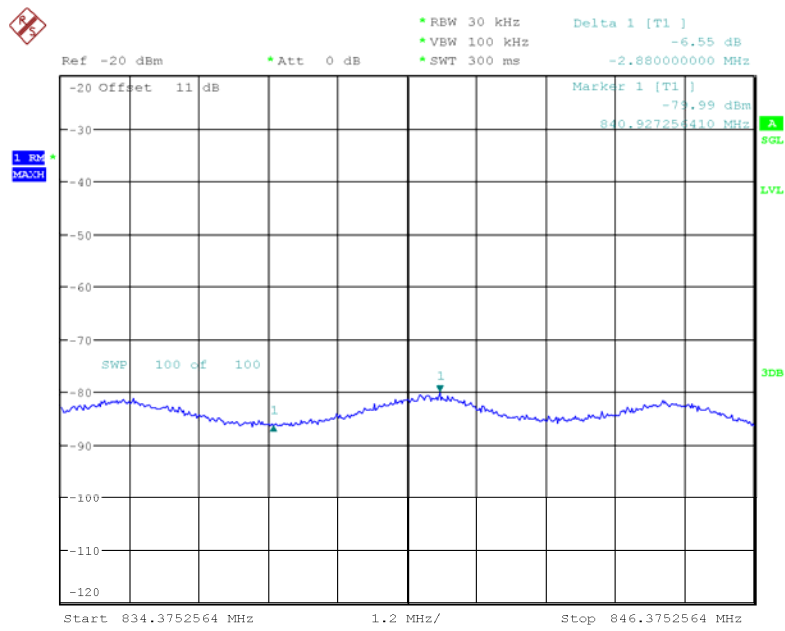

Date: 27.MAY.2018 10:20:11

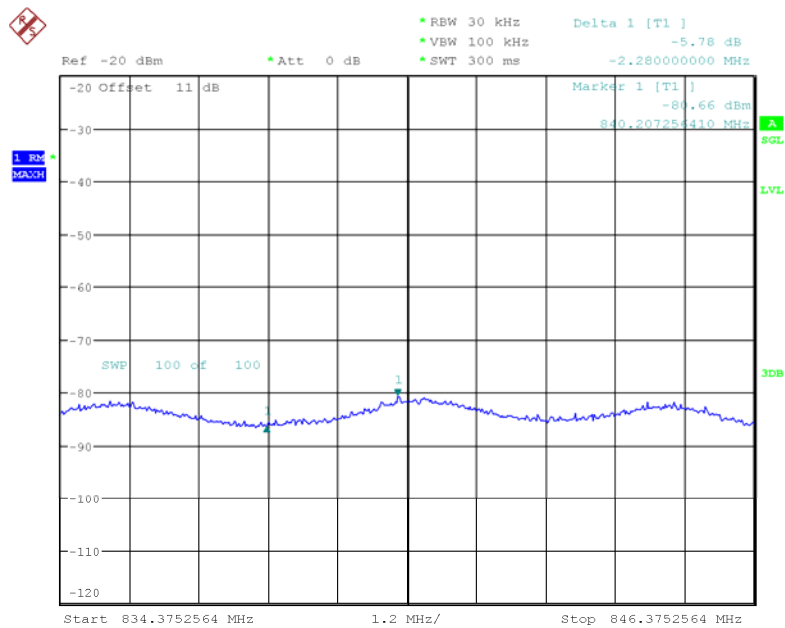

Date: 27.MAY.2018 10:23:36

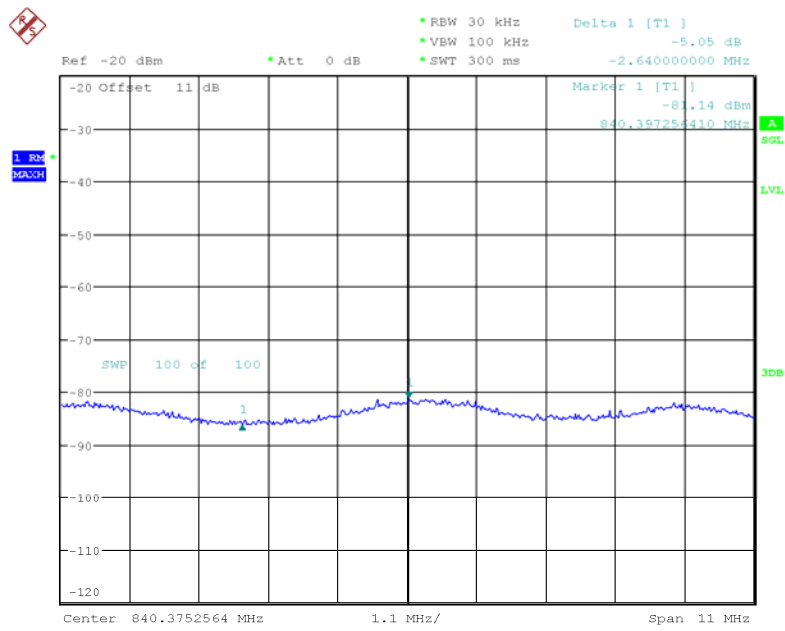

Date: 27.MAY.2018 10:27:16

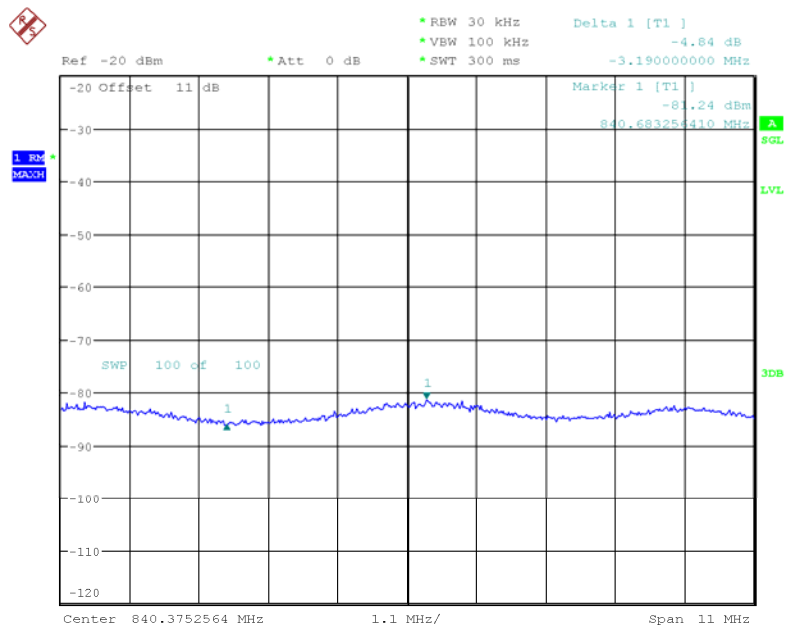

Date: 27.MAY.2018 10:29:35

AWS Band

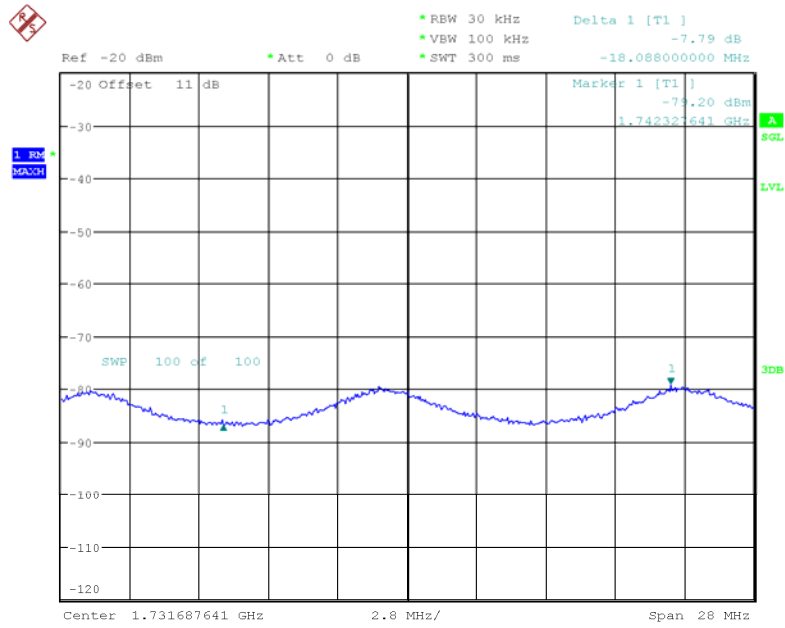

Date: 27.MAY.2018 10:53:21

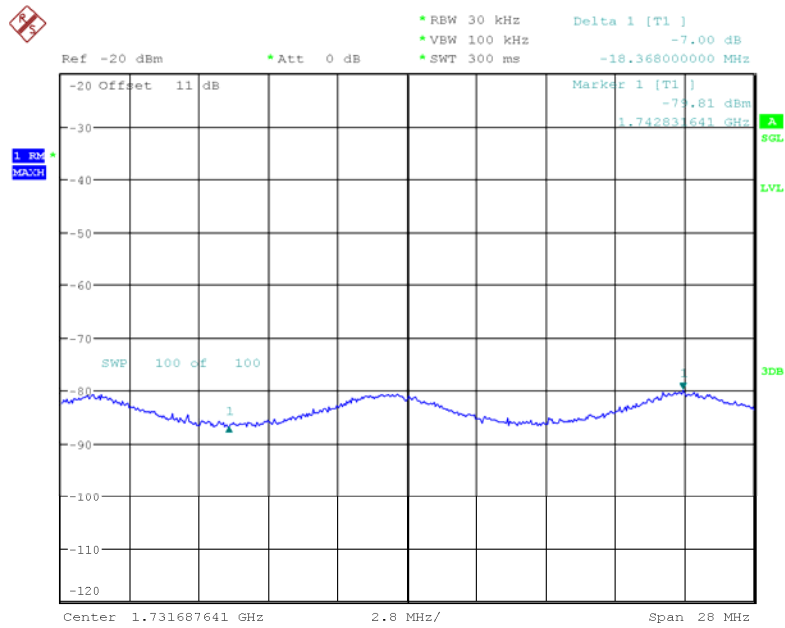

Date: 27.MAY.2018 10:54:33

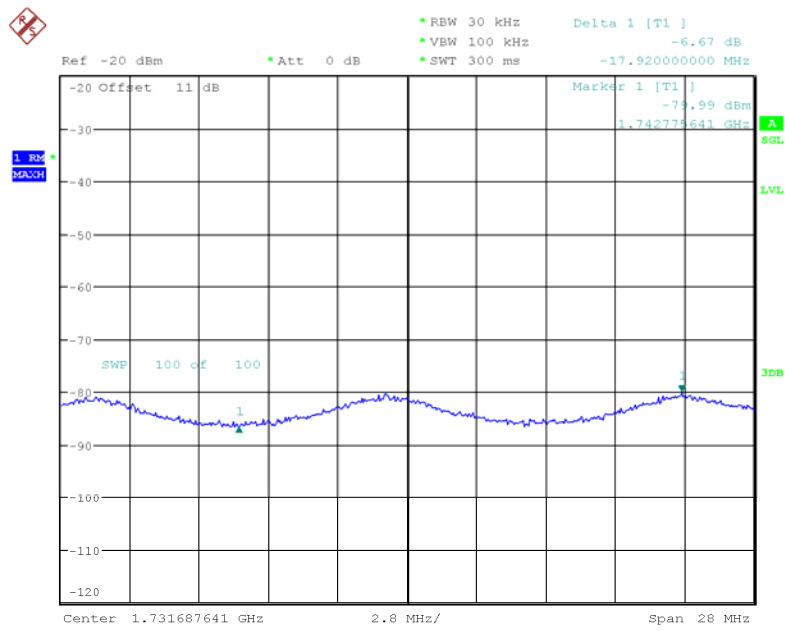

Date: 27.MAY.2018 10:55:33

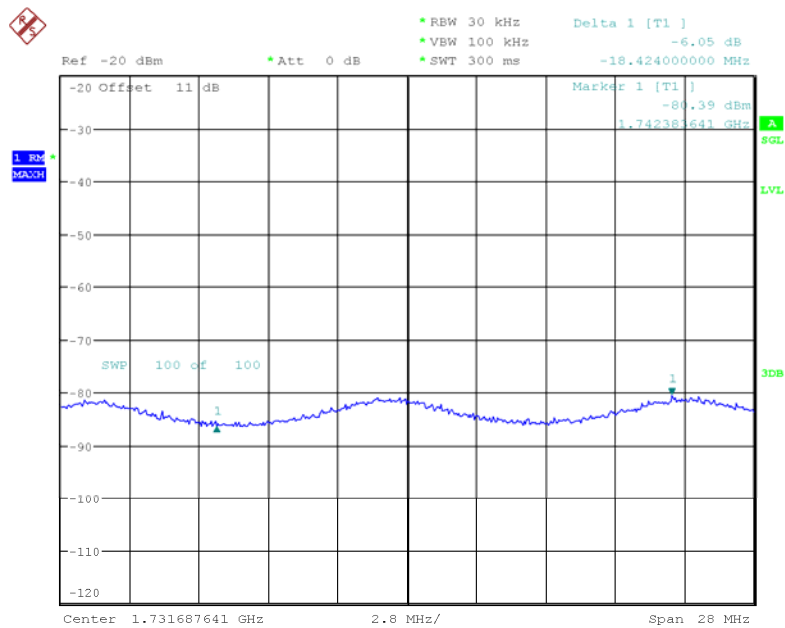

Date: 27.MAY.2018 10:56:34

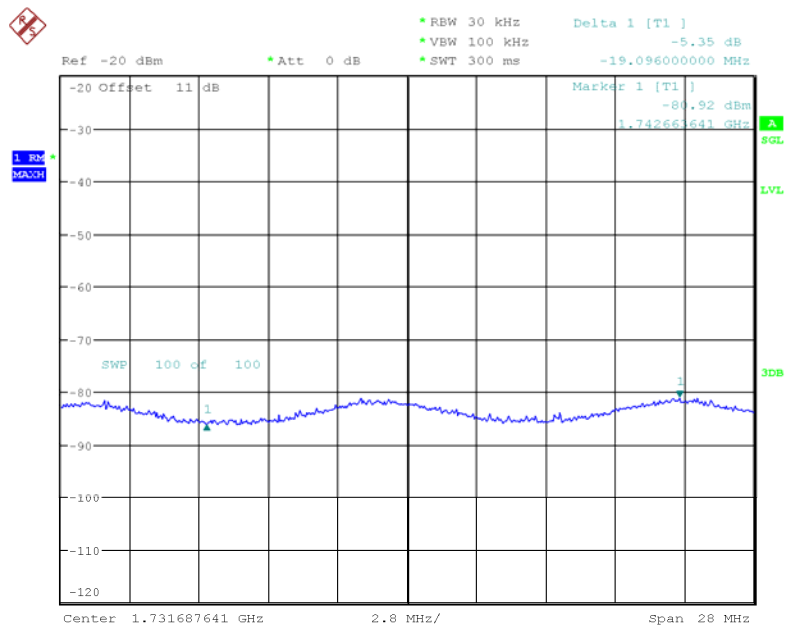

Date: 27.MAY.2018 10:57:32

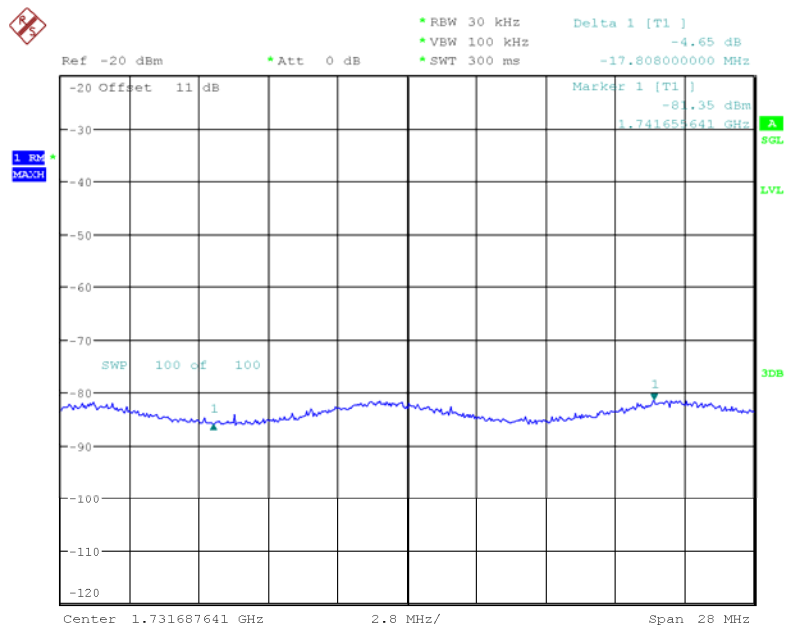

Date: 27.MAY.2018 10:58:23

PCS Band

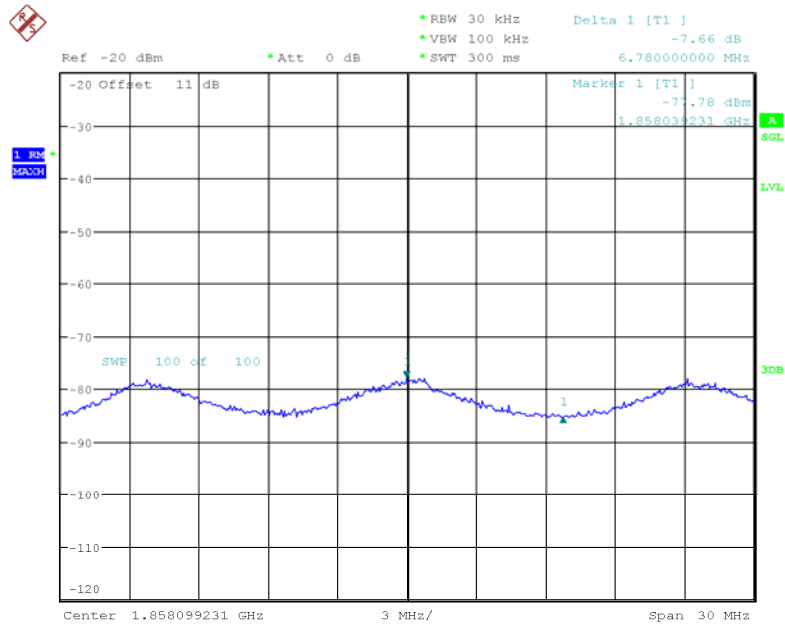

Date: 27.MAY.2018 09:56:04

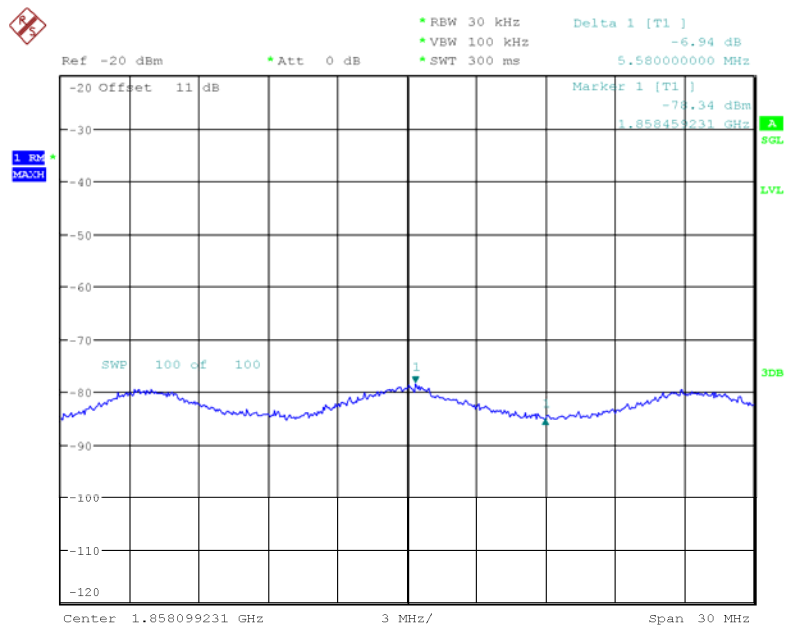

Date: 27.MAY.2018 10:01:04

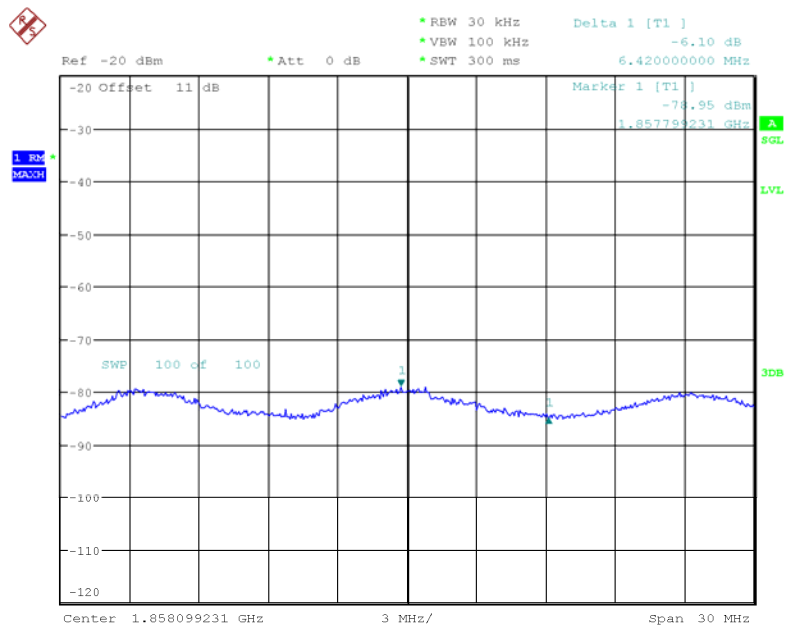

Date: 27.MAY.2018 10:04:03

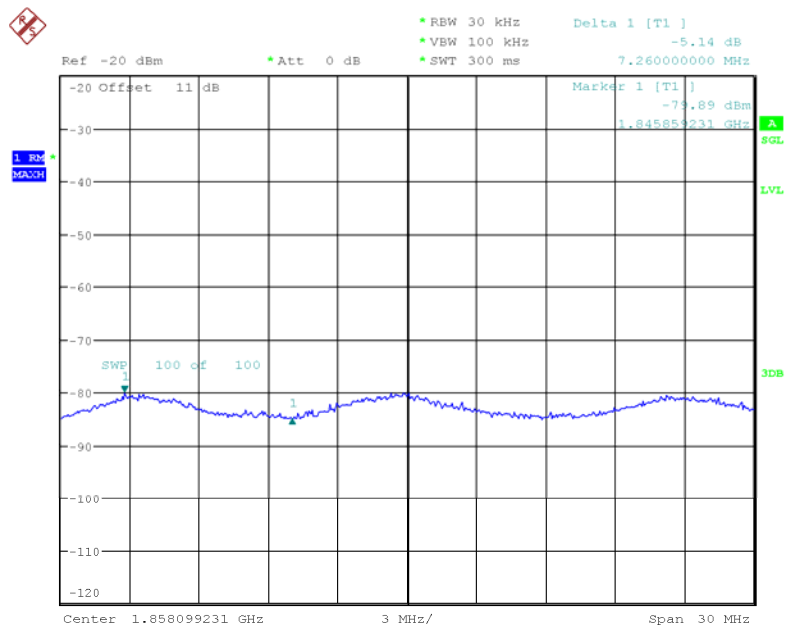

Date: 27.MAY.2018 10:06:31

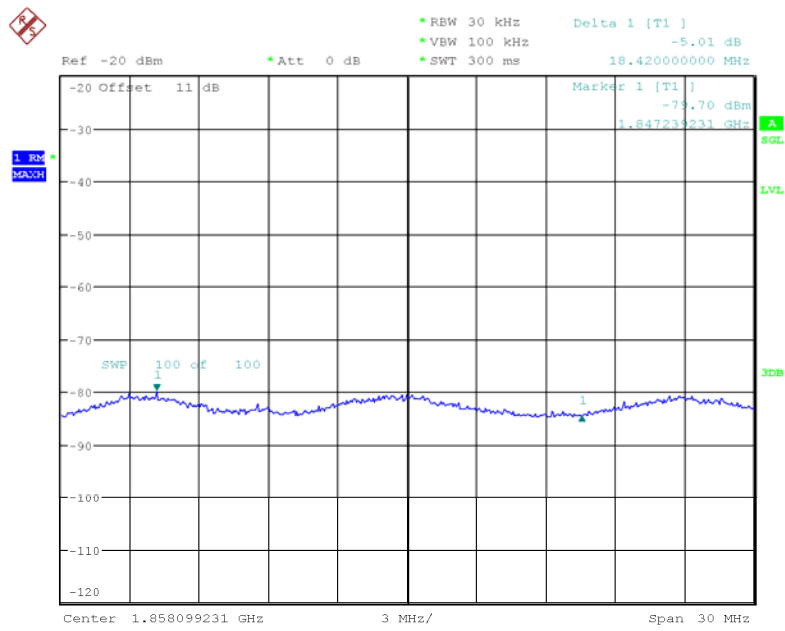

Date: 27.MAY.2018 10:07:48

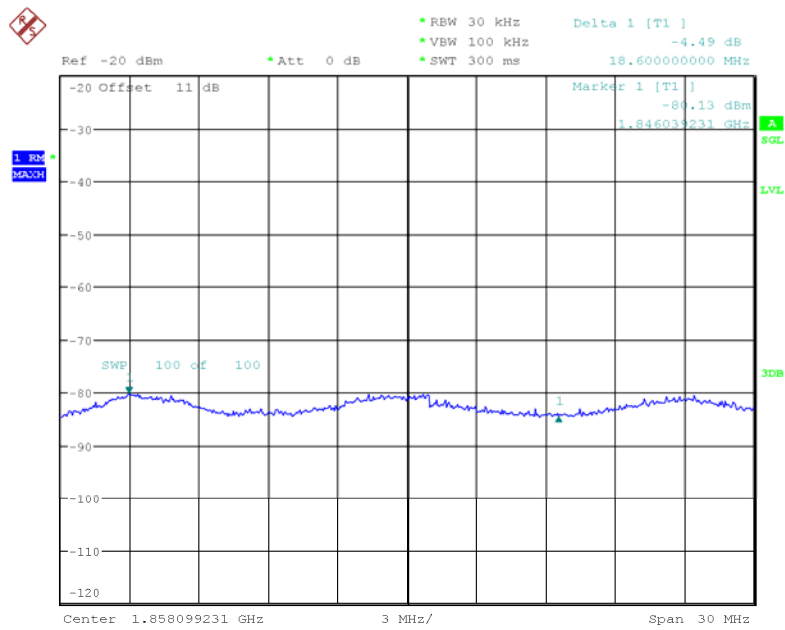

Date: 27.MAY.2018 10:09:40

§2.1051- SPURIOUS EMISSIONS AT ANTENNA TERMINALS

Applicable Standards

FCC §2.1051 *Measurements required: Spurious emissions at antenna terminals.*

§20.21(e)(8)(i)(E): Booster out of band emissions (OOBE) shall be at least 6 dB below the FCC's mobile emission limits for the supported bands of operation. Compliance to OOBE limits will utilize high peak-to-average CMRS signal types.

§22.917 (a) Out of band emissions. The power of any emission outside of the authorized operating frequency ranges must be attenuated below the transmitting power (P) by a factor of at least $43 + 10 \log(P)$ dB.

§24.238 (a) Out of band emissions. The power of any emission outside of the authorized operating frequency ranges must be attenuated below the transmitting power (P) by a factor of at least $43 + 10 \log(P)$ dB.

§27.53: the power of any emission shall be attenuated outside the band below the transmitter power (P) by at least $43 + 10 \log(P)$ dB;

Test Procedure

The following procedures shall be used to demonstrate compliance to the applicable conducted spurious emissions limits as per § 2.1051.

Note: *For frequencies below 1 GHz, an RBW of 1 MHz may be used in a preliminary measurement. If non-compliant emissions are detected, a final measurement shall be made with a 100 kHz RBW. Additionally, a peak detector may also be used for the preliminary measurement. If non-compliant emissions are detected then a final measurement of these emissions shall be made with the power averaging (RMS) detector.*

- a) Connect the EUT to the test equipment as shown in **Figure 1**. Begin with the uplink output connected to the spectrum analyzer.
- b) Configure the signal generator for AWGN with a 99% occupied bandwidth of 4.1 MHz with a center frequency corresponding to the center of the CMRS band under test.
- c) Set the signal generator amplitude to the level determined in the power measurement procedure in 7.2.
- d) Turn on the signal generator RF output and measure the spurious emission power levels with an appropriate measurement instrument as follows.
 - 1) Set RBW = measurement bandwidth specified in the applicable rule section for the operational frequency band under consideration (see Annex A for relevant cross-references). Note that many of the individual rule sections permit the use of a narrower RBW (typically $\geq 1\%$ of the emission bandwidth) to enhance measurement accuracy, but the result must then be integrated over the specified measurement bandwidth.
 - 2) Set VBW = $3 \times$ RBW.
 - 3) Select the power averaging (RMS) detector. (See above note regarding the use of a peak detector for preliminary measurements.)
 - 4) Sweep time = auto-couple.
 - 5) Set the analyzer start frequency to the lowest radio frequency signal generated in the equipment, without going below 9 kHz, and the stop frequency to the lower band/block edge frequency minus 100 kHz or 1 MHz, as specified in the applicable rule part. Note that the number of measurement points in each sweep

must be $\geq (2 \times \text{span/RBW})$ which may require that the measurement range defined by the start and stop frequencies above be subdivided, depending on the available number of measurement points provided by the spectrum analyzer. Trace average at least 10 traces in power averaging (i.e., RMS) mode.

6) Use the peak marker function to identify the highest amplitude level over each measured frequency range. Record the frequency and amplitude and capture a plot for inclusion in the test report.

7) Reset the analyzer start frequency to the upper band/block edge frequency plus 100 kHz or 1 MHz, as specified in the applicable rule part, and the analyzer stop frequency to $10 \times$ the highest frequency of the fundamental emission. Note that the number of measurement points in each sweep must be $\geq (2 \times \text{span/RBW})$ which may require that the measurement range defined by the start and stop frequencies above be subdivided, depending on the available number of measurement points provided by the spectrum analyzer.

8) Use the peak marker function to identify the highest amplitude level over each of the measured frequency ranges. Record the frequency and amplitude and capture a plot for inclusion in the test report.

e) Repeat 7.6b) through 7.6d) for each supported frequency band of operation.

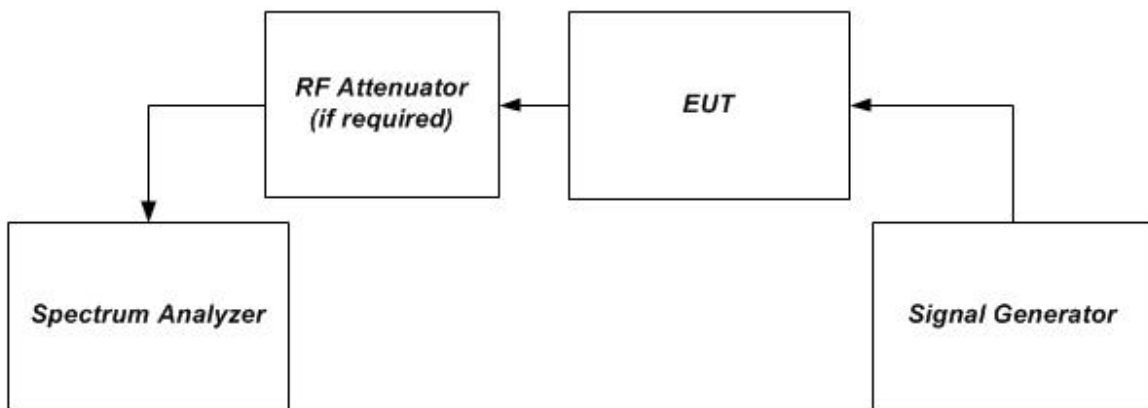

Figure 1 – Band verification test instrumentation setup

Test Data

Environmental Conditions

Temperature:	26.5~26.8 °C
Relative Humidity:	52~61 %
ATM Pressure:	101.3~101.5 kPa

The testing was performed by George Pang on 2018-05-27 and 2018-06-29.

Test Mode: Transmitting, please refer to the following plots.

Test Result: Compliance.

Note: mobile emission limits for the supported bands of operation is $43 + 10 \log(P)$ dB=-13dBm, the out of band emissions (OOBE) shall be at least 6 dB below the FCC's mobile emission limits(-19dBm), the emissions compliance the emission limits -19dBm, Please refer to the following plots.

Downlink:

Lower 700MHz Band

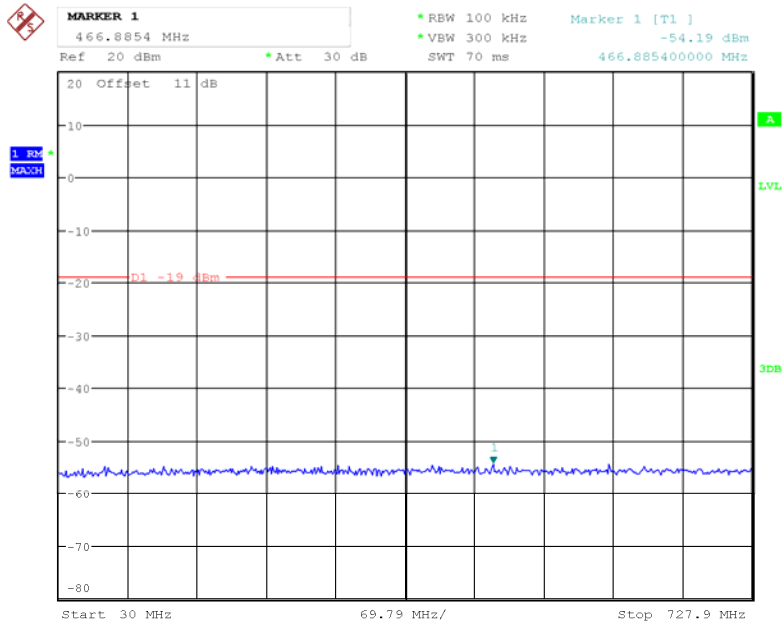

Date: 27.MAY.2018 13:43:18

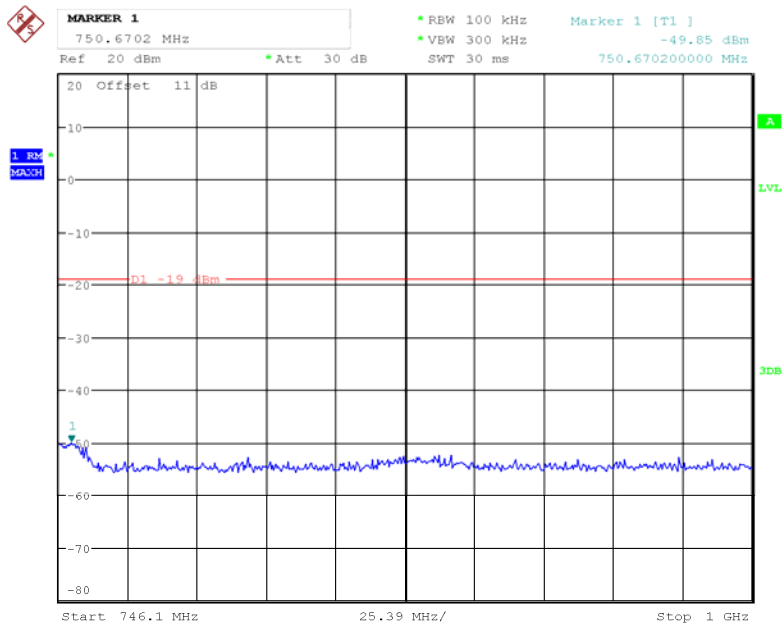

Date: 27.MAY.2018 13:44:41

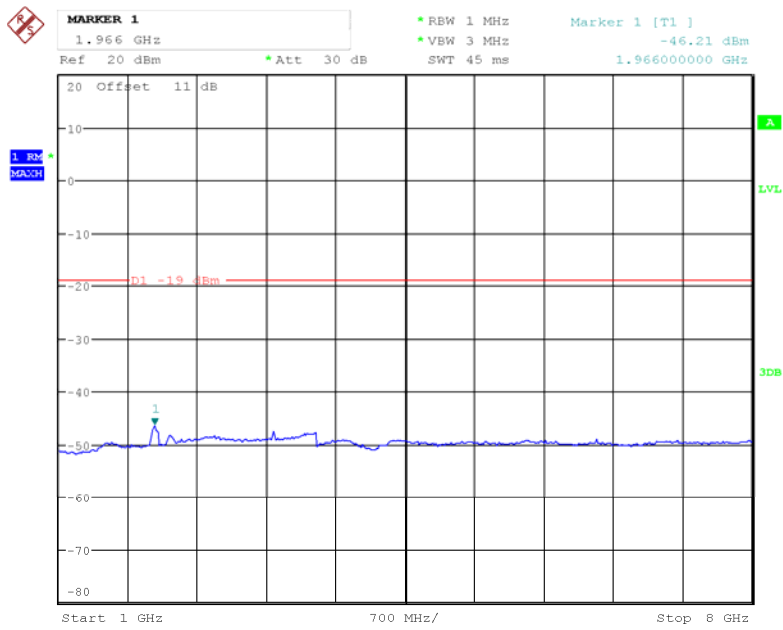

Date: 27.MAY.2018 13:45:34

Upper 700MHz Band

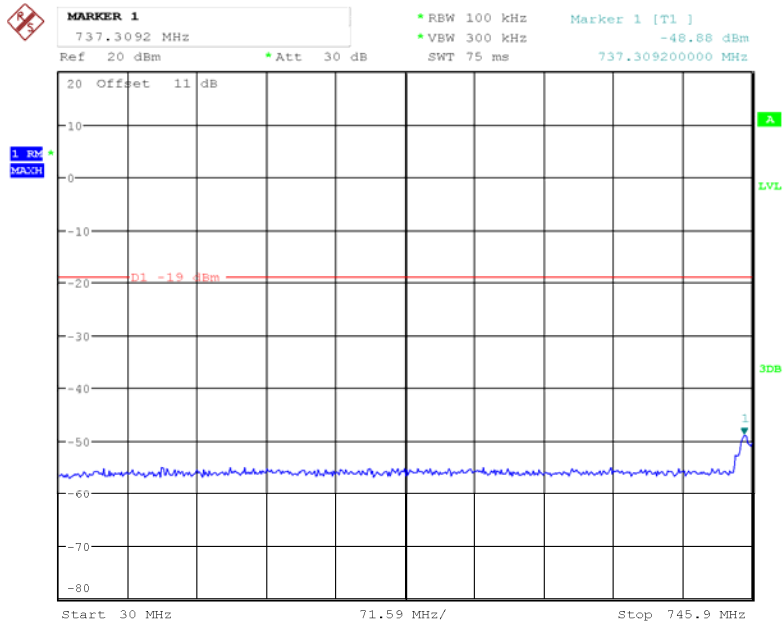

Date: 27.MAY.2018 13:50:44

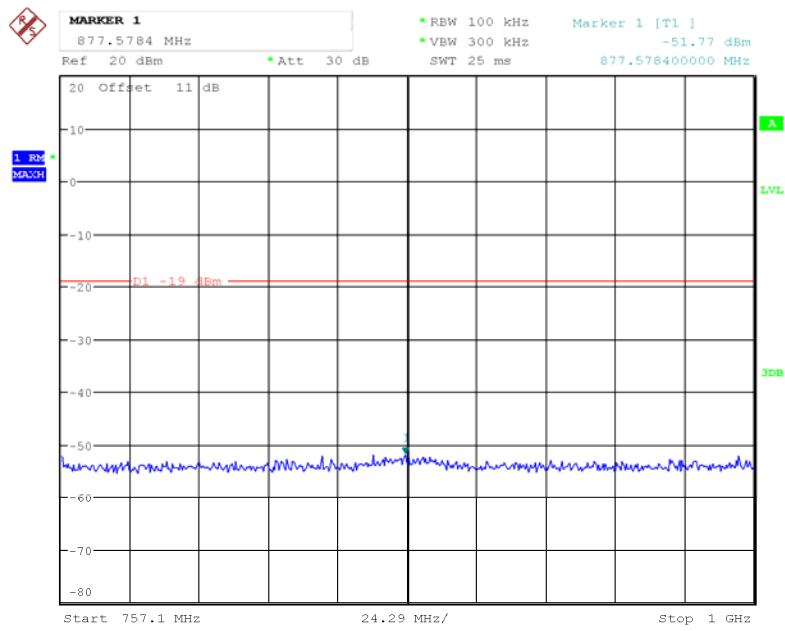

Date: 27.MAY.2018 13:49:30

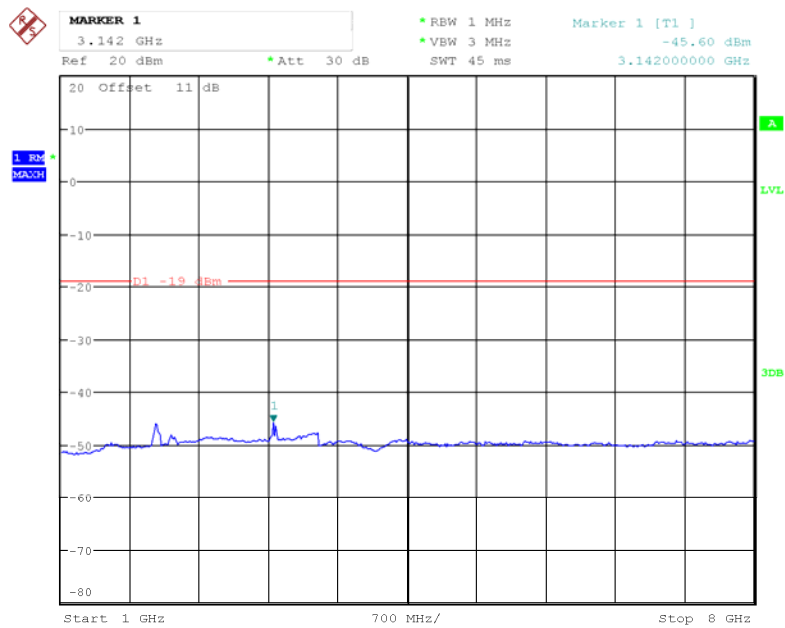

Date: 27.MAY.2018 13:47:02

Cellular Band

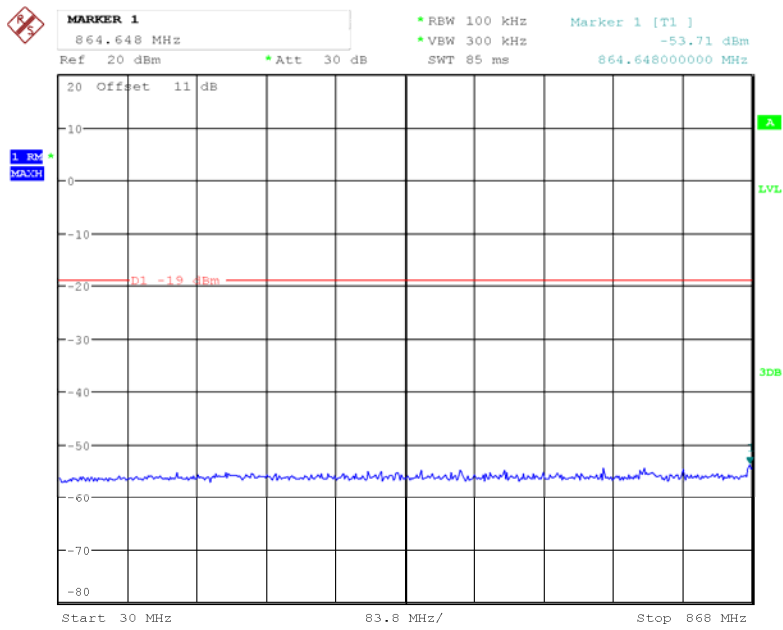

Date: 27.MAY.2018 13:54:26

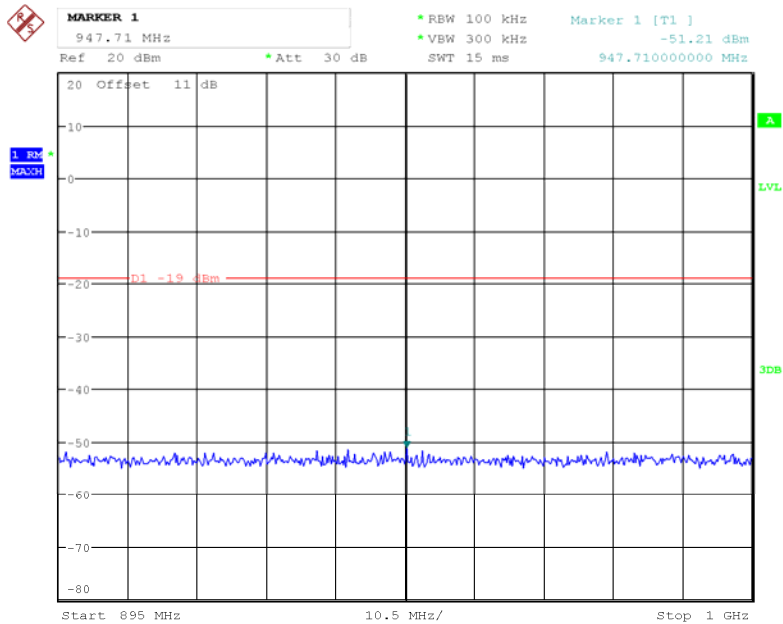

Date: 27.MAY.2018 13:54:59

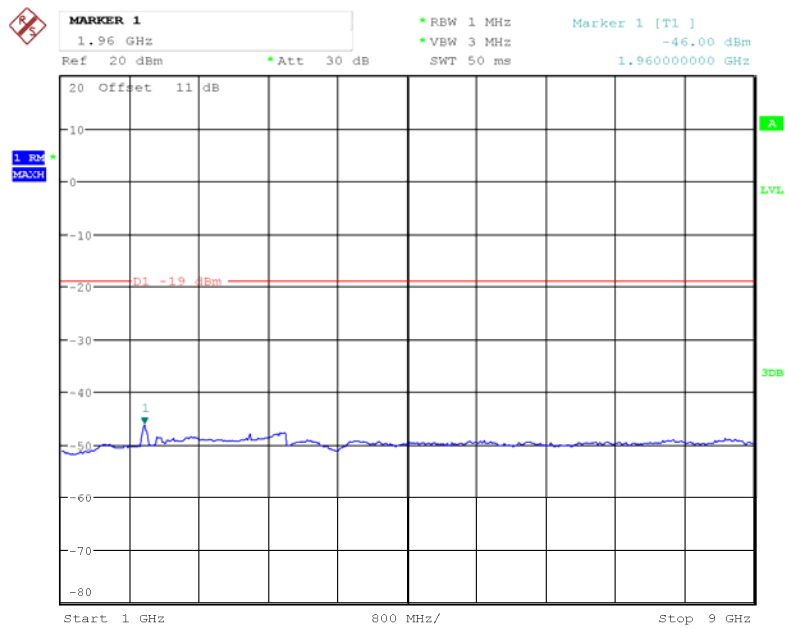

Date: 27.MAY.2018 13:55:51

AWS Band

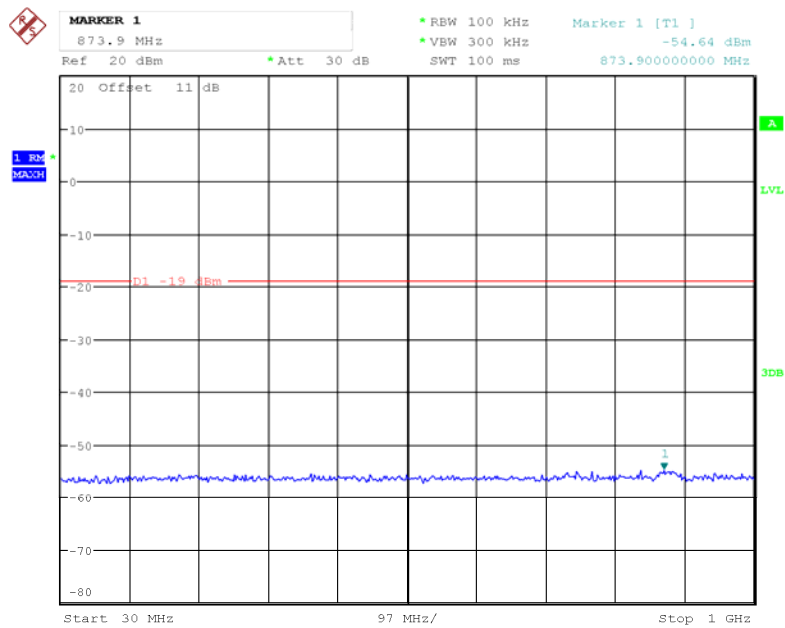

Date: 27.MAY.2018 14:01:14

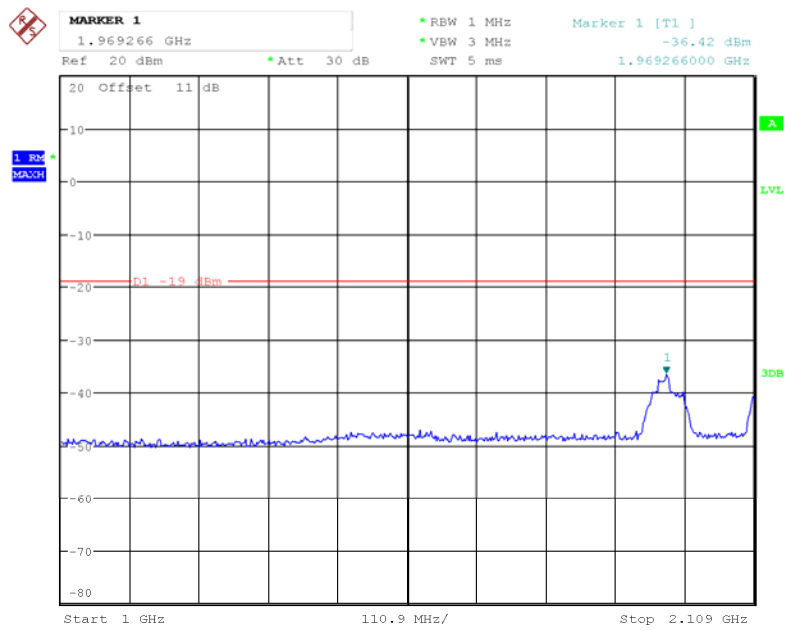

Date: 27.MAY.2018 14:03:35

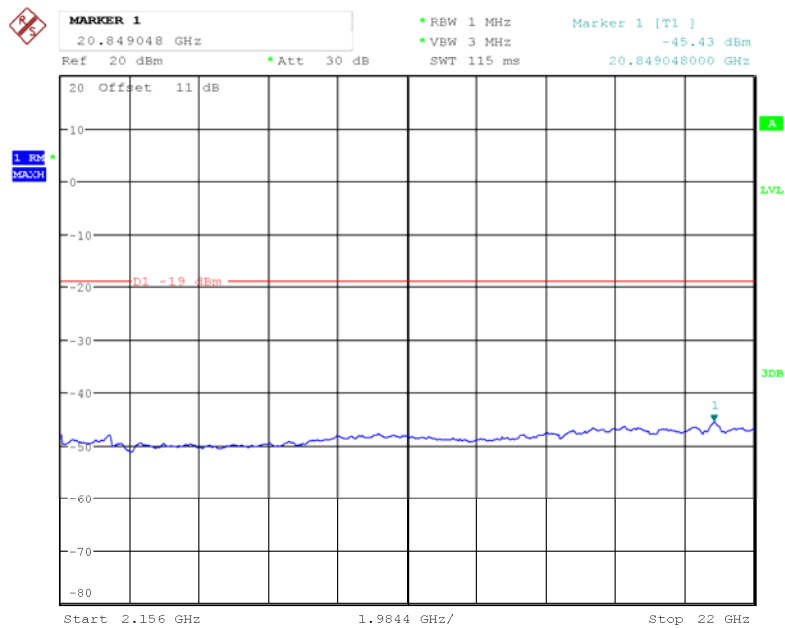

Date: 27.MAY.2018 14:04:30

PCS Band

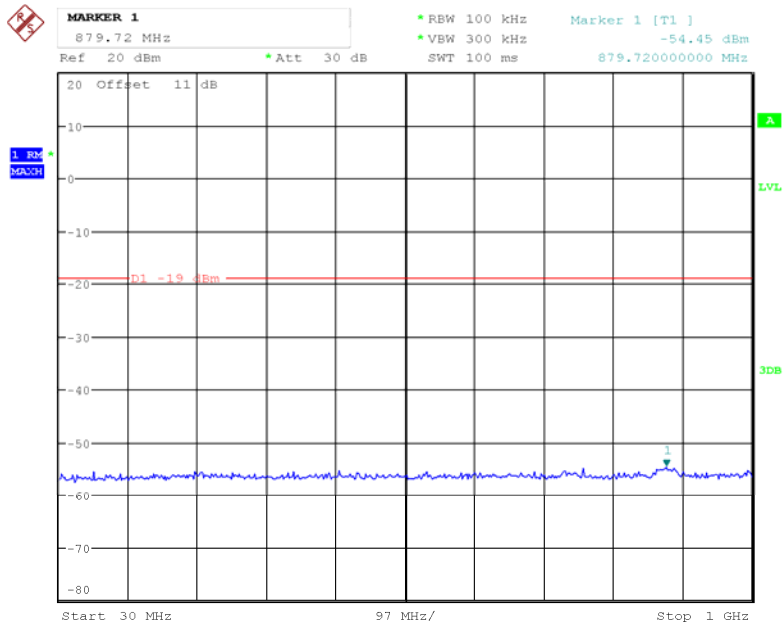

Date: 27.MAY.2018 13:59:24

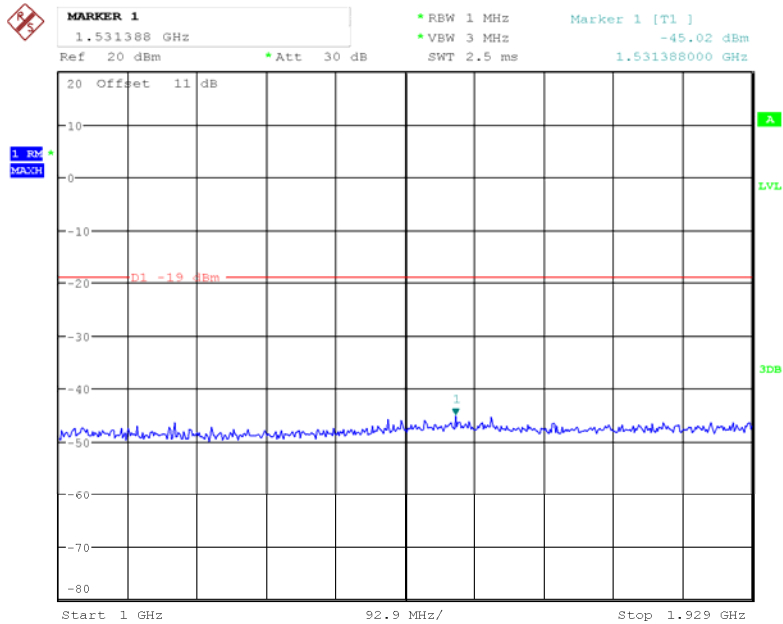

Date: 27.MAY.2018 13:57:50

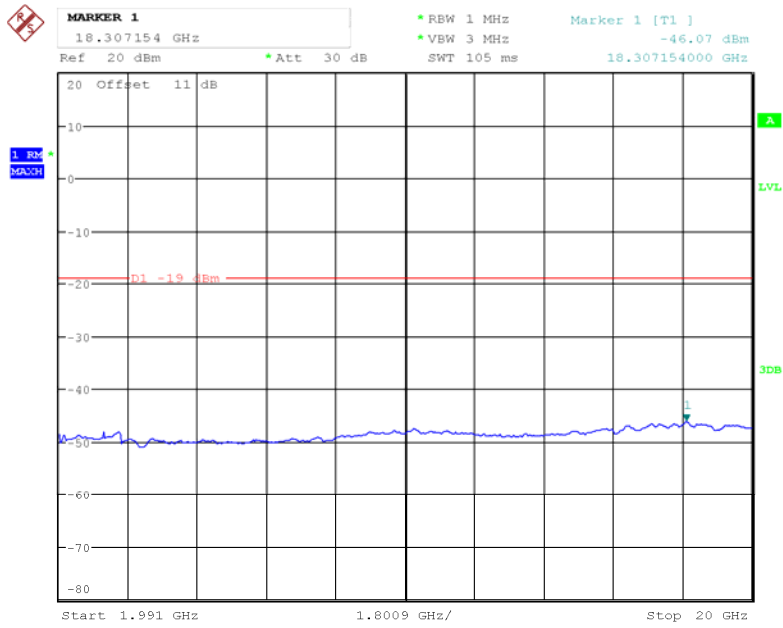

Date: 27.MAY.2018 13:58:44

Uplink:

Lower 700MHz Band

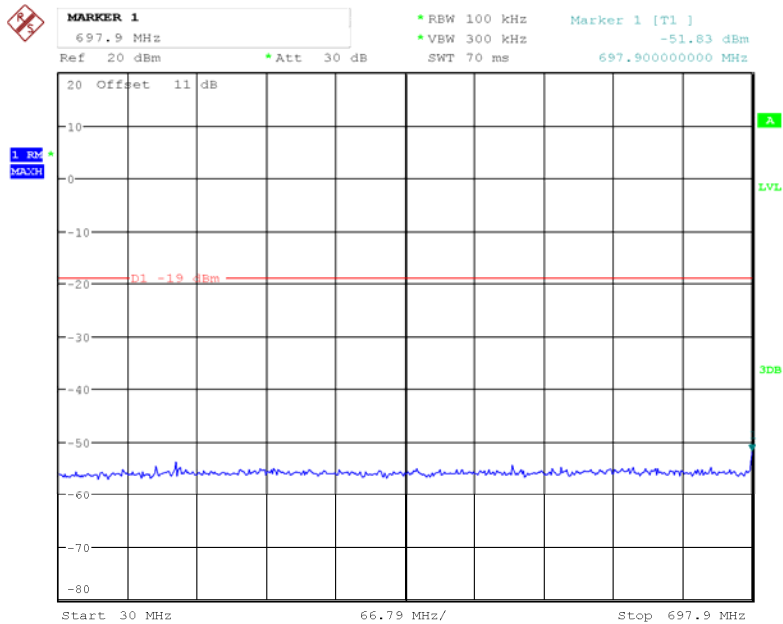

Date: 27.MAY.2018 14:10:22

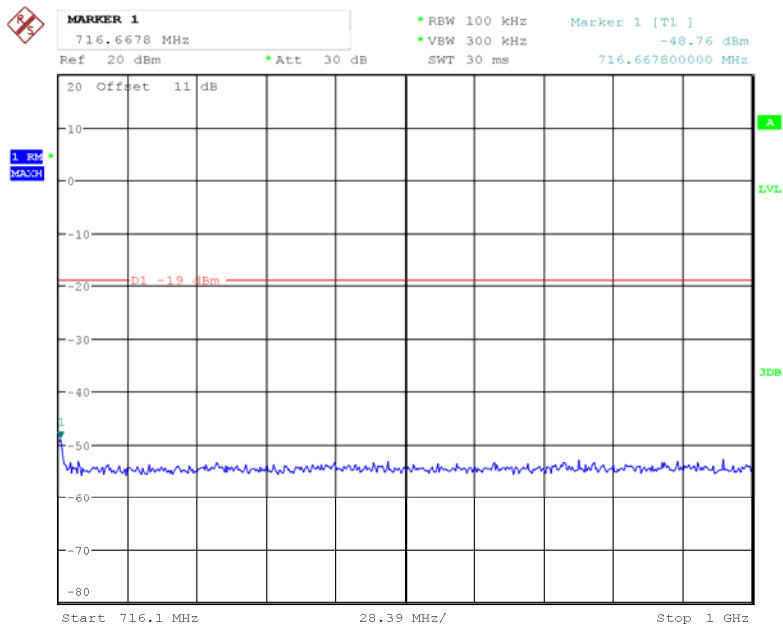

Date: 27.MAY.2018 14:10:58

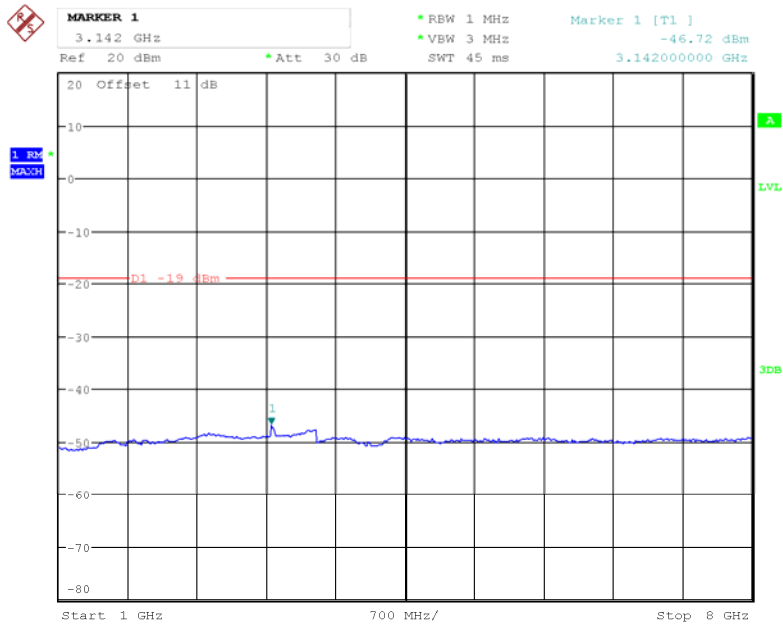

Date: 27.MAY.2018 14:09:01

Upper 700MHz Band

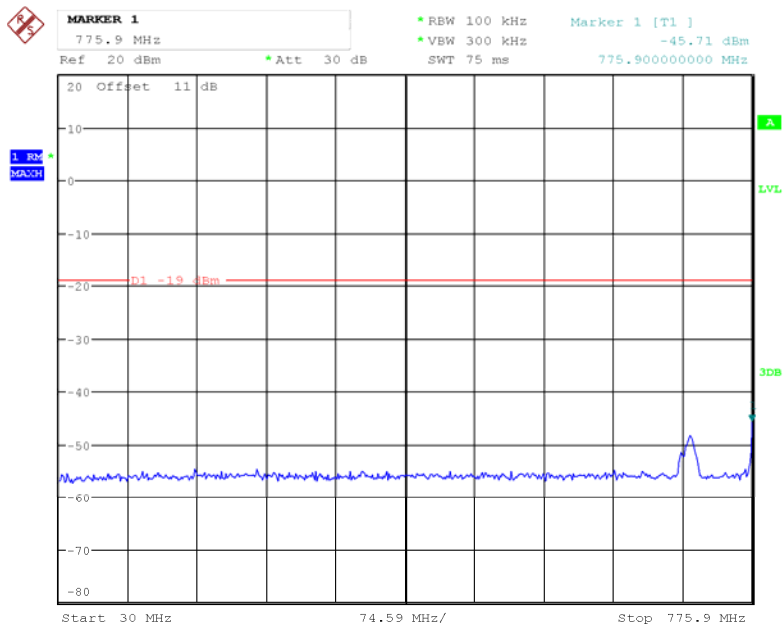

Date: 27.MAY.2018 14:12:32

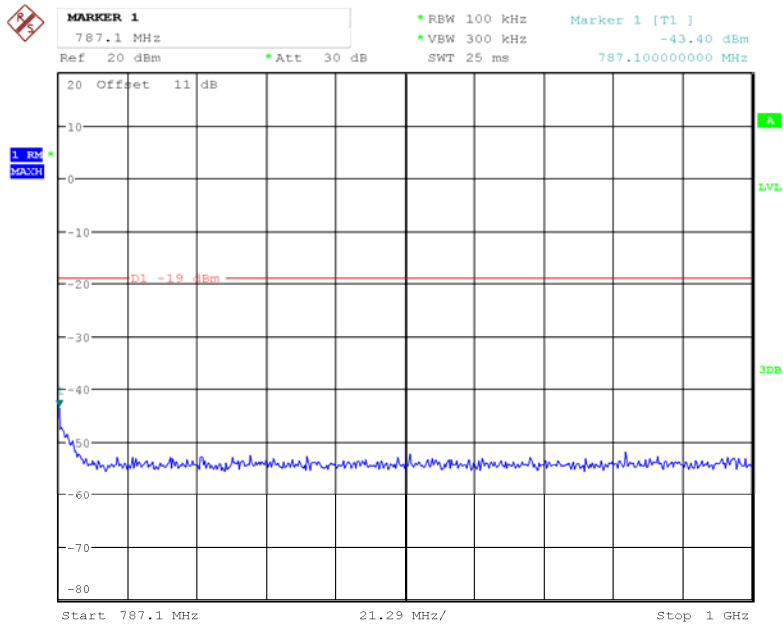

Date: 27.MAY.2018 14:13:17

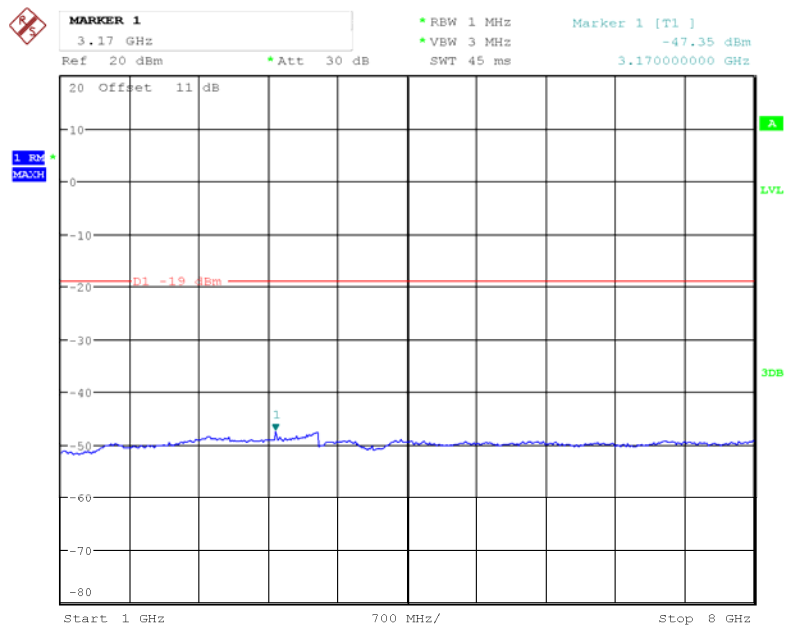

Date: 27.MAY.2018 14:14:19

Cellular Band

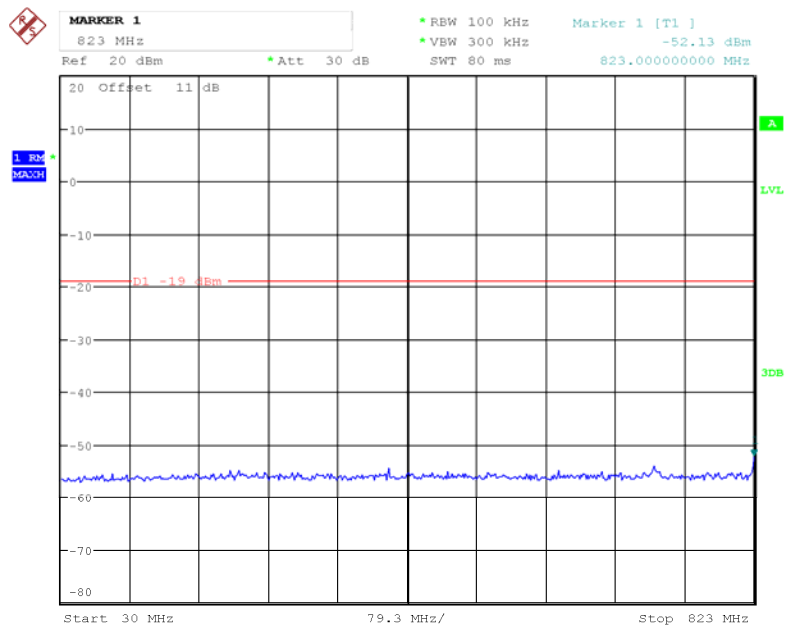

Date: 27.MAY.2018 14:19:26

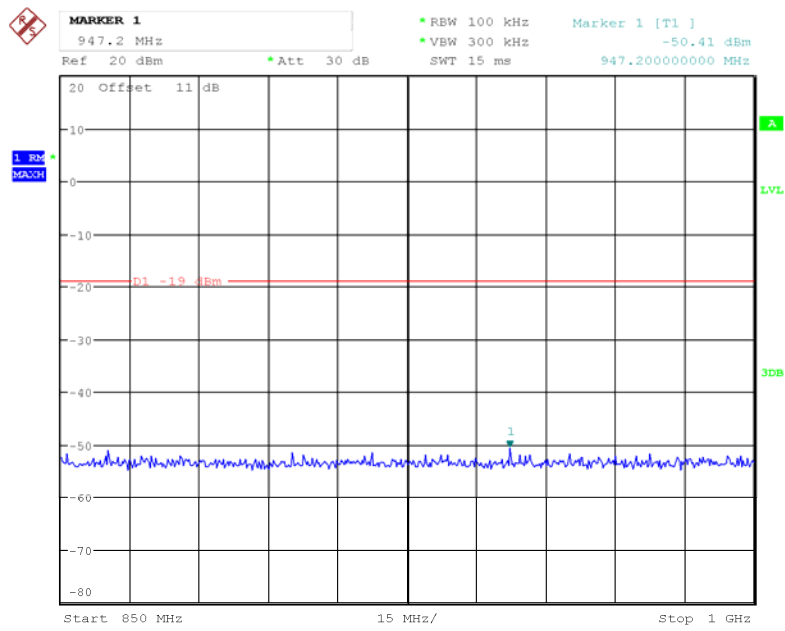

Date: 27.MAY.2018 14:19:59

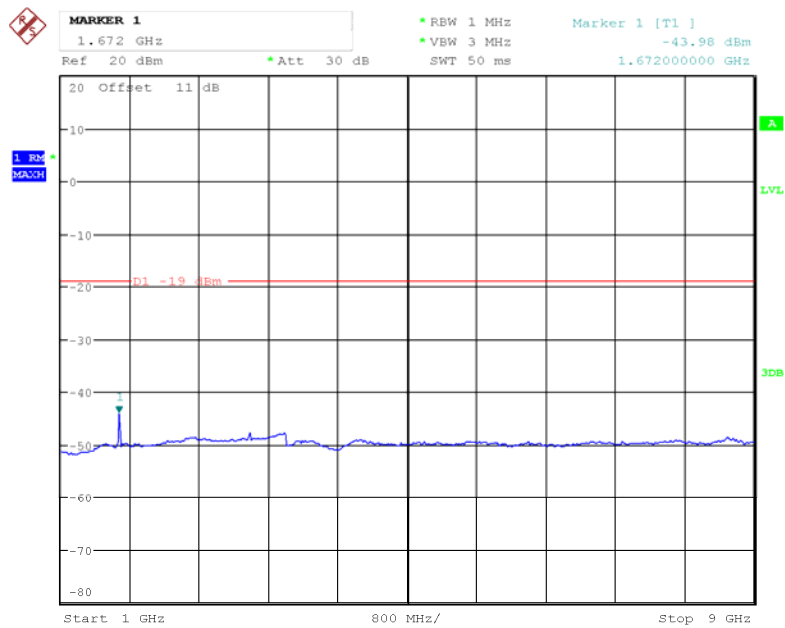

Date: 27.MAY.2018 14:18:38

AWS Band

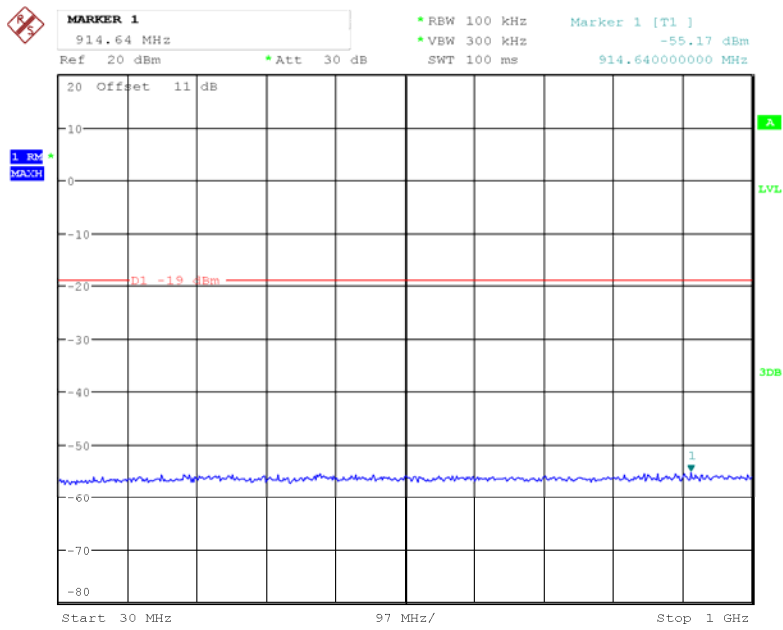

Date: 27.MAY.2018 14:26:04

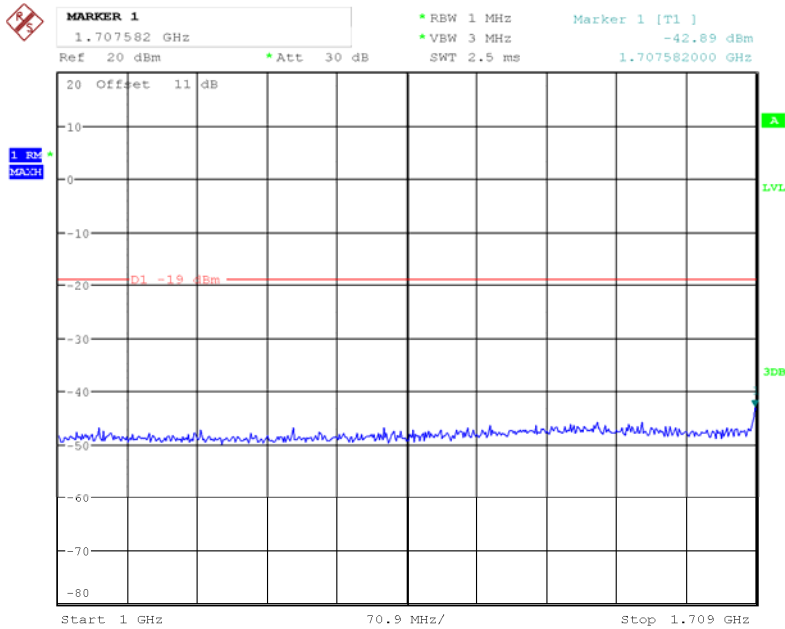

Date: 27.MAY.2018 14:24:18

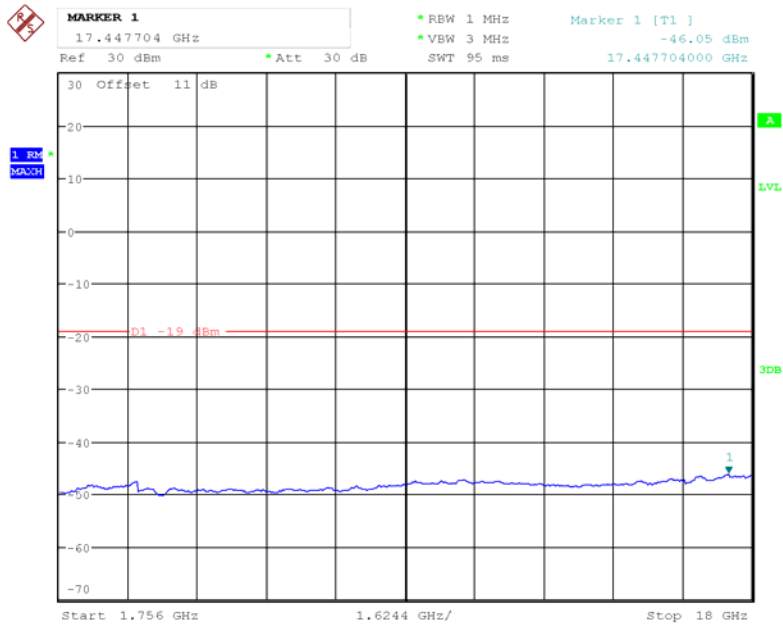

Date: 6.JUN.2018 18:11:55

PCS Band

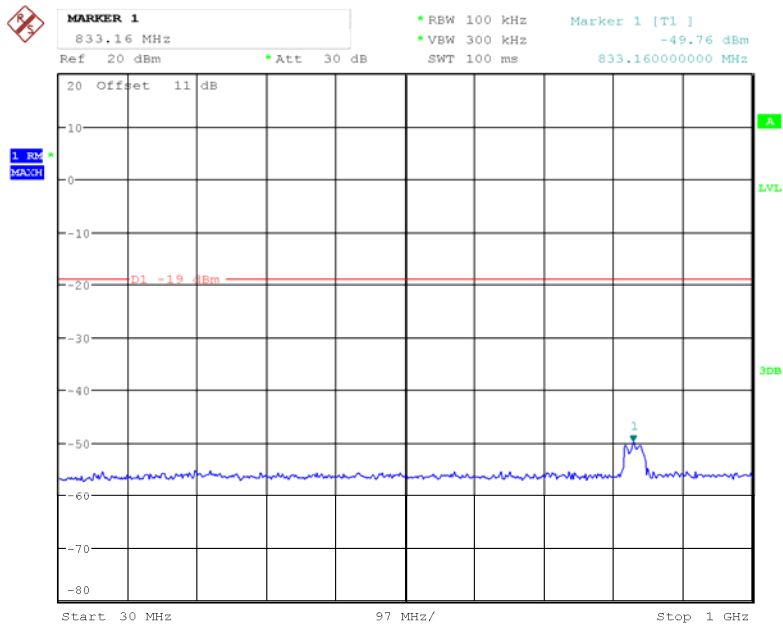

Date: 27.MAY.2018 14:21:08

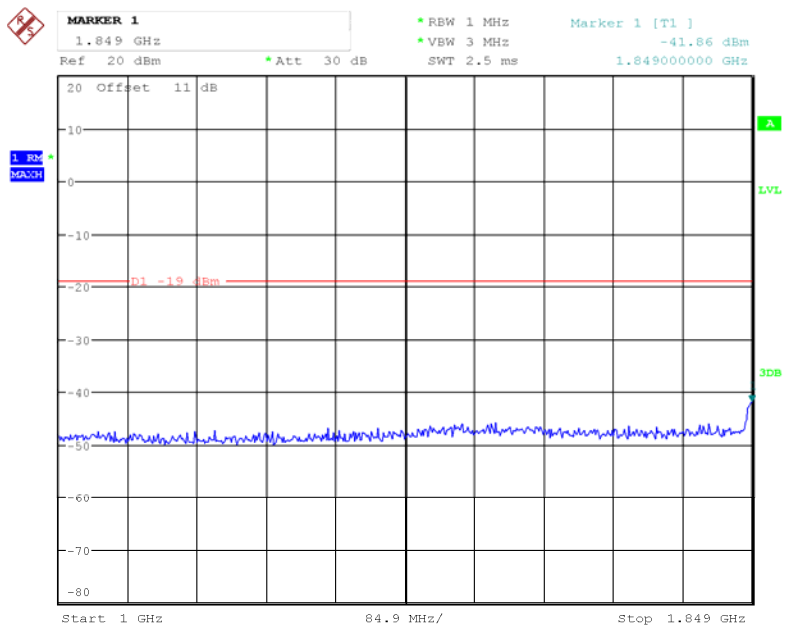

Date: 27.MAY.2018 14:21:52

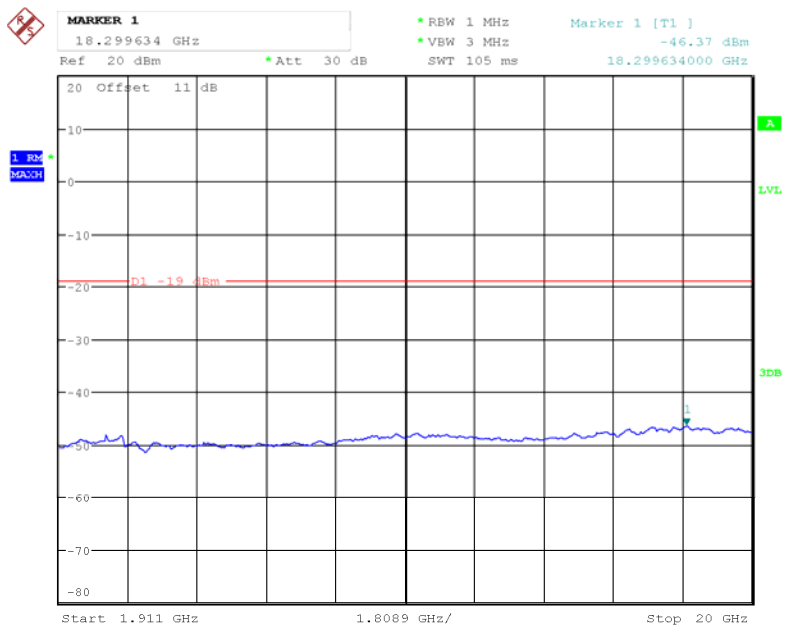

Date: 27.MAY.2018 14:22:46

§ 2.1053 - RADIATED SPURIOUS EMISSIONS

Applicable Standards

§ 2.1053 *Measurements required: Field strength of spurious radiation.*

Test Procedure

This procedure is intended to satisfy the requirements specified in § 2.1053. The applicable limits are those specified for mobile emissions in the rule part appropriate to the band of operation (see Annex A).

- Place the EUT on an OATS or semi-anechoic chamber turntable 3 m from the receiving antenna.
- Connect the EUT to the test equipment as shown in **Figure 10** beginning with the uplink output.
- Set the signal generator to produce a CW signal with the frequency set to the center of the operational band under test and the power level set at P_{IN} as determined from 7.2.
- Measure the radiated spurious emissions from the EUT from lowest to the highest frequencies as specified in § 2.1057. Maximize the radiated emissions by utilizing the procedures described in Clause 8 of ANSI C63.4-2014.
- Capture the peak emissions plots using a peak detector with Max-Hold for inclusion in the test report. Tabular data is acceptable in lieu of spectrum analyzer plots.
- Repeat 7.12c) through 7.12e) for all operational bands.

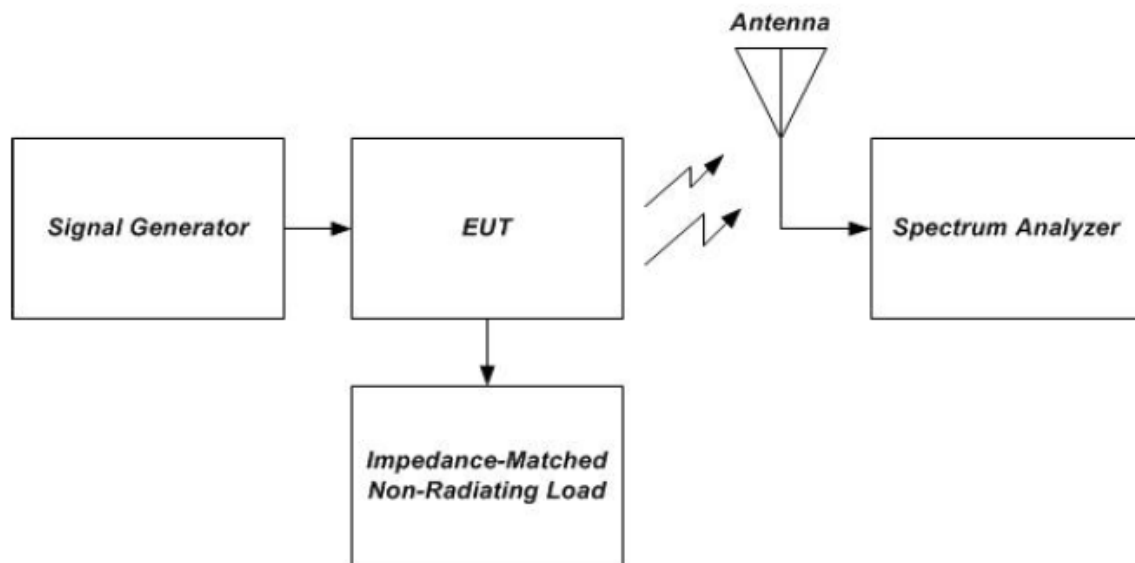

Figure 10 – Radiated spurious emissions test instrumentation setup

Test Data**Environmental Conditions**

Temperature:	23.3~25.1 °C
Relative Humidity:	51~53 %
ATM Pressure:	100.9 kPa

The testing was performed by Sunny Cen and Blake Yang on 2018-05-03.

Test Result: Compliance. Please refer to following table.

Test Mode: Transmitting

Uplink:

Frequency (MHz)	Polar (H / V)	Receiver Reading (dBμV)	Substituted Method			Absolute Level (dBm)	Limit (dBm)	Margin (dB)
			Substituted Level (dBm)	Antenna Gain (dBd/dBi)	Cable Loss(dB)			
Lower 700MHz Band, Test Frequency 707 MHz								
1253.000	H	48.37	-64.8	7.8	1.1	-58.1	-19.0	39.1
1253.000	V	49.88	-64.2	7.8	1.1	-57.5	-19.0	38.5
1504.000	H	53.57	-61.6	9.5	1.3	-53.4	-19.0	34.4
1504.000	V	56.04	-59.3	9.5	1.3	-51.1	-19.0	32.1
2332.000	H	51.84	-60.5	11.6	1.2	-50.1	-19.0	31.1
2332.000	V	53.09	-59.2	11.6	1.2	-48.8	-19.0	29.8
95.000	H	69.45	-39	0.0	0.3	-39.3	-19.0	20.3
74.000	V	69.24	-46.2	-3.0	0.3	-49.5	-19.0	30.5
Upper 700MHz Band, Test Frequency 781.5 MHz								
1504.000	H	52.87	-62.3	9.5	1.3	-54.1	-19.0	35.1
1504.000	V	55.49	-59.8	9.5	1.3	-51.6	-19.0	32.6
2332.000	H	51.47	-60.9	11.6	1.2	-50.5	-19.0	31.5
2332.000	V	52.34	-60	11.6	1.2	-49.6	-19.0	30.6
2494.000	H	50.11	-62.9	13.1	1.2	-51.0	-19.0	32.0
2494.000	V	50.87	-62.1	13.1	1.2	-50.2	-19.0	31.2
167.000	H	66.92	-41.1	0.0	0.4	-41.5	-19.0	22.5
74.000	V	68.60	-46.8	-3.0	0.3	-50.1	-19.0	31.1
Cellular Band, Test Frequency 836.5 MHz								
1502.000	H	51.71	-63.5	9.5	1.3	-55.3	-19.0	36.3
1502.000	V	55.16	-60.1	9.5	1.3	-51.9	-19.0	32.9
2332.000	H	52.65	-59.7	11.6	1.2	-49.3	-19.0	30.3
2332.000	V	53.58	-58.7	11.6	1.2	-48.3	-19.0	29.3
2746.000	H	48.12	-64.1	13.1	1.3	-52.3	-19.0	33.3
2746.000	V	50.31	-62.1	13.1	1.3	-50.3	-19.0	31.3
165.000	H	68.39	-39.4	0.0	0.4	-39.8	-19.0	20.8
74.000	V	67.93	-47.5	-3.0	0.3	-50.8	-19.0	31.8

Frequency (MHz)	Polar (H / V)	Receiver Reading (dBµV)	Substituted Method			Absolute Level (dBm)	Limit (dBm)	Margin (dB)
			Substituted Level (dBm)	Antenna Gain (dBd/dBi)	Cable Loss(dB)			
AWS Band, Test Frequency 1732.5 MHz								
1252.000	H	52.37	-60.8	7.8	1.1	-54.1	-19.0	35.1
1252.000	V	56.14	-58	7.8	1.1	-51.3	-19.0	32.3
1504.000	H	50.13	-65.1	9.5	1.3	-56.9	-19.0	37.9
1504.000	V	51.45	-63.9	9.5	1.3	-55.7	-19.0	36.7
2332.000	H	48.67	-63.7	11.6	1.2	-53.3	-19.0	34.3
2332.000	V	49.53	-62.8	11.6	1.2	-52.4	-19.0	33.4
177.000	H	66.17	-43.2	0.0	0.4	-43.6	-19.0	24.6
76.000	V	69.36	-46.9	-2.0	0.3	-49.2	-19.0	30.2
PCS Band, Test Frequency 1880MHz								
1504.000	H	51.57	-63.6	9.5	1.3	-55.4	-19.0	36.4
1504.000	V	55.84	-59.5	9.5	1.3	-51.3	-19.0	32.3
2332.000	H	50.31	-62	11.6	1.2	-51.6	-19.0	32.6
2332.000	V	52.46	-59.9	11.6	1.2	-49.5	-19.0	30.5
2746.000	H	49.83	-62.4	13.1	1.3	-50.6	-19.0	31.6
2746.000	V	51.24	-61.2	13.1	1.3	-49.4	-19.0	30.4
167.000	H	68.20	-39.8	0.0	0.4	-40.2	-19.0	21.2
78.000	V	69.19	-47.9	-1.0	0.4	-49.3	-19.0	30.3

Downlink:

Frequency (MHz)	Polar (H / V)	Receiver Reading (dBµV)	Substituted Method			Absolute Level (dBm)	Limit (dBm)	Margin (dB)
			Substituted Level (dBm)	Antenna Gain (dBd/dBi)	Cable Loss(dB)			
Lower 700MHz Band, Test Frequency 737MHz								
1504.000	H	50.81	-64.4	9.5	1.3	-56.2	-19.0	37.2
1504.000	V	55.13	-60.2	9.5	1.3	-52.0	-19.0	33.0
2008.000	H	48.22	-65.4	12.0	1.1	-54.5	-19.0	35.5
2008.000	V	50.76	-63.2	12.0	1.1	-52.3	-19.0	33.3
2332.000	H	51.05	-61.3	11.6	1.2	-50.9	-19.0	31.9
2332.000	V	52.46	-59.9	11.6	1.2	-49.5	-19.0	30.5
107.000	H	71.62	-33.7	0.0	0.3	-34.0	-19.0	15.0
92.000	V	71.96	-41	0.0	0.3	-41.3	-19.0	22.3

Frequency (MHz)	Polar (H / V)	Receiver Reading (dBµV)	Substituted Method			Absolute Level (dBm)	Limit (dBm)	Margin (dB)
			Substituted Level (dBm)	Antenna Gain (dBd/dBi)	Cable Loss (dB)			
Upper 700MHz Band, Test Frequency 751.5MHz								
1504.000	H	50.29	-64.9	9.5	1.3	-56.7	-19.0	37.7
1504.000	V	55.34	-60	9.5	1.3	-51.8	-19.0	32.8
2332.000	H	51.46	-60.9	11.6	1.2	-50.5	-19.0	31.5
2332.000	V	52.31	-60	11.6	1.2	-49.6	-19.0	30.6
2494.000	H	50.32	-62.7	13.1	1.2	-50.8	-19.0	31.8
2494.000	V	51.43	-61.6	13.1	1.2	-49.7	-19.0	30.7
107.000	H	72.06	-33.3	0.0	0.3	-33.6	-19.0	14.6
94.000	V	70.71	-42.2	0.0	0.3	-42.5	-19.0	23.5
Cellular Band, Test Frequency 881.5MHz								
1503.000	H	51.13	-64.1	9.5	1.3	-55.9	-19.0	36.9
1503.000	V	54.87	-60.4	9.5	1.3	-52.2	-19.0	33.2
2331.000	H	50.31	-62	11.5	1.2	-51.7	-19.0	32.7
2331.000	V	51.67	-60.6	11.5	1.2	-50.3	-19.0	31.3
2494.000	H	49.73	-63.2	13.1	1.2	-51.3	-19.0	32.3
2494.000	V	50.67	-62.3	13.1	1.2	-50.4	-19.0	31.4
105.000	H	67.54	-38.1	0.0	0.3	-38.4	-19.0	19.4
61.000	V	69.89	-38.1	-9.8	0.2	-48.1	-19.0	29.1
AWS Band, Test Frequency 2132.5MHz								
1503.000	H	51.63	-63.6	9.5	1.3	-55.4	-19.0	36.4
1503.000	V	53.87	-61.4	9.5	1.3	-53.2	-19.0	34.2
2008.000	H	50.13	-63.5	12.0	1.1	-52.6	-19.0	33.6
2008.000	V	52.21	-61.8	12.0	1.1	-50.9	-19.0	31.9
2331.000	H	50.11	-62.2	11.5	1.2	-51.9	-19.0	32.9
2331.000	V	52.43	-59.9	11.5	1.2	-49.6	-19.0	30.6
113.000	H	67.96	-36.5	0.0	0.3	-36.8	-19.0	17.8
61.000	V	69.67	-38.4	-9.8	0.2	-48.4	-19.0	29.4
PCS Band, Test Frequency 1960MHz								
1504.000	H	52.13	-63.1	9.5	1.3	-54.9	-19.0	35.9
1504.000	V	55.41	-59.9	9.5	1.3	-51.7	-19.0	32.7
2008.000	H	50.65	-63	12.0	1.1	-52.1	-19.0	33.1
2008.000	V	52.21	-61.8	12.0	1.1	-50.9	-19.0	31.9
2332.000	H	49.38	-62.9	11.6	1.2	-52.5	-19.0	33.5
2332.000	V	50.71	-61.6	11.6	1.2	-51.2	-19.0	32.2
111.000	H	67.97	-36.8	0.0	0.3	-37.1	-19.0	18.1
62.000	V	69.61	-39	-9.2	0.2	-48.4	-19.0	29.4

Note:

- 1) Absolute Level = Substituted Level - Cable loss + Antenna Gain
- 2) Margin = Limit- Absolute Level

***** END OF REPORT *****