

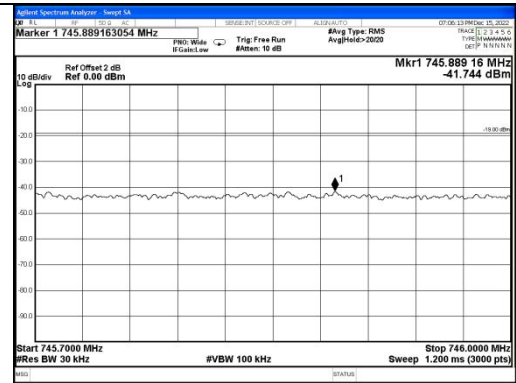

Upper 700MHz band CDMA DL Left Side Pre AGC

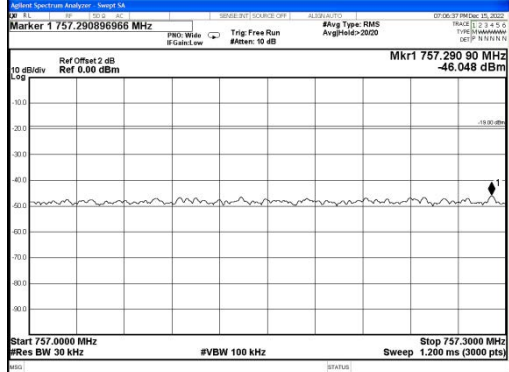

Upper 700MHz band CDMA DL Left Side 10dB Above AGC



Upper 700MHz band CDMA DL Right Side Pre AGC

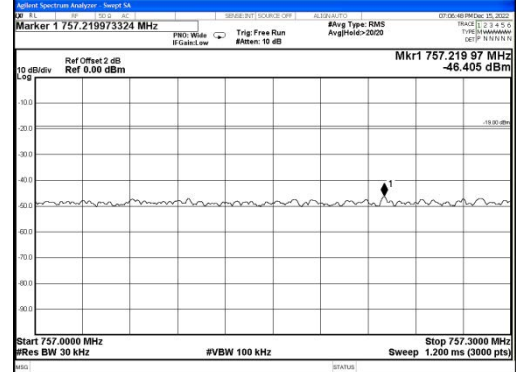

Upper 700MHz band CDMA DL Right Side 10dB Above AGC

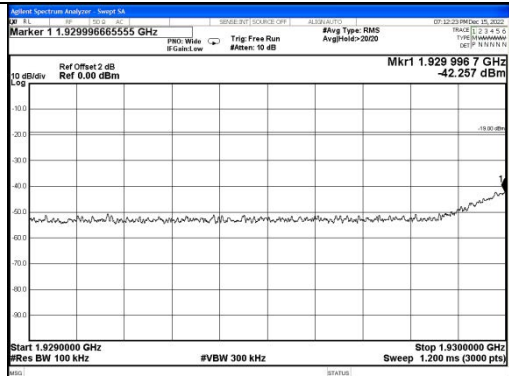

PCS Band LTE DL Left Side Pre AGC

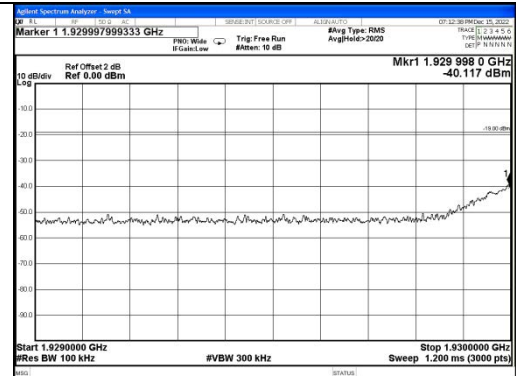

PCS Band LTE DL Left Side 10dB Above AGC

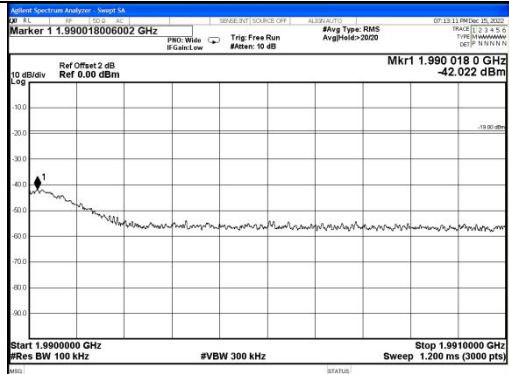

PCS Band LTE DL Right Side Pre AGC

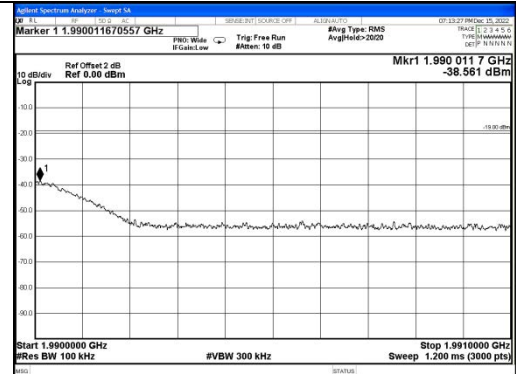

PCS Band LTE DL Right Side 10dB Above AGC

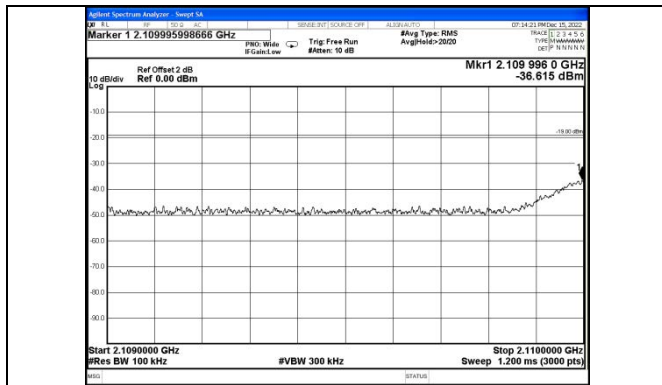

AWS Band LTE DL Left Side Pre AGC

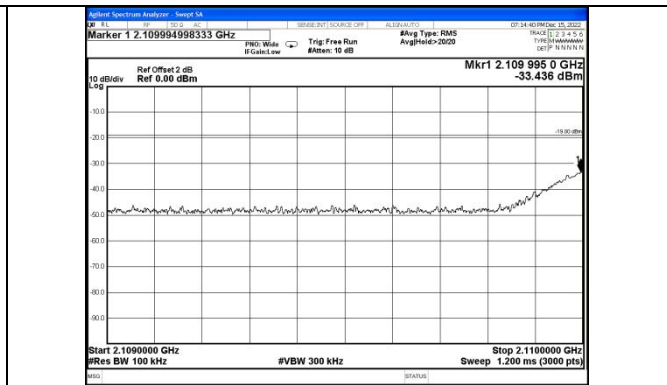

AWS Band LTE .DL Left Side 10dB Above AGC

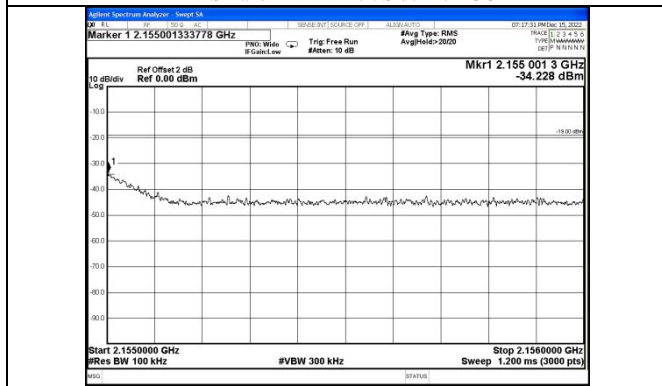

AWS Band LTE DL Right Side Pre AGC

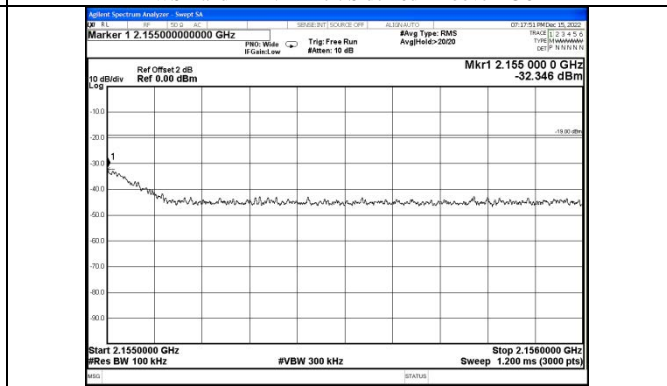

AWS Band LTE DL Right Side 10dB Above AGC

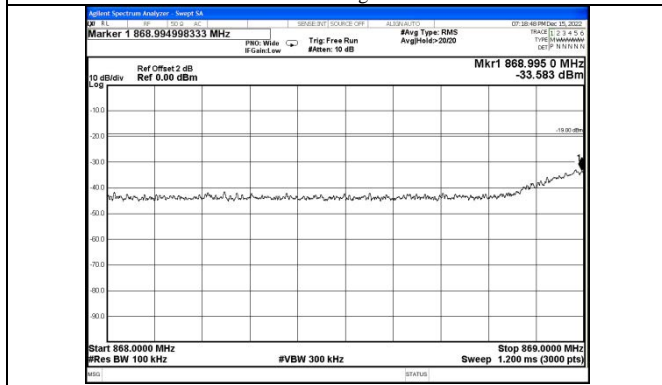

Cellular Band LTE DL Left Side Pre AGC

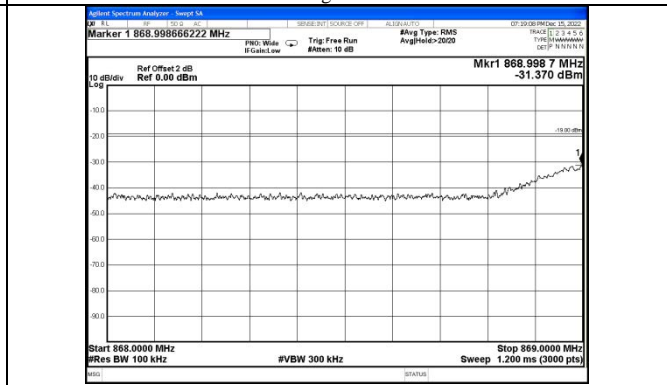

Cellular Band LTE DL Left Side 10dB Above AGC

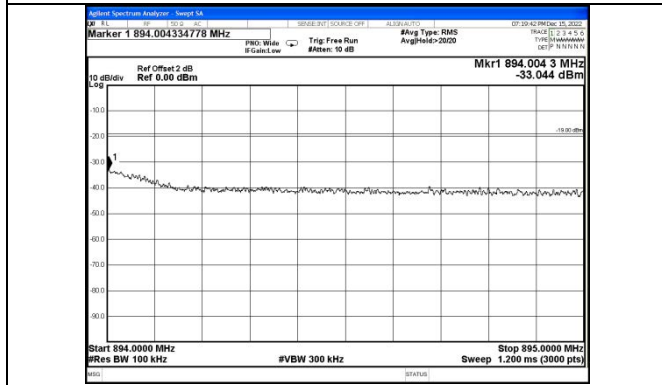

Cellular Band LTE DL Right Side Pre AGC

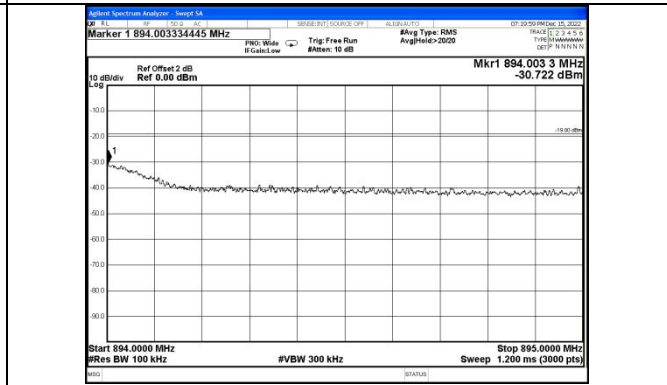

Cellular Band LTE DL Right Side 10dB Above AGC



Lower 700MHz band LTE DL Left Side Pre AGC



Lower 700MHz band LTE DL Left Side 10dB Above AGC

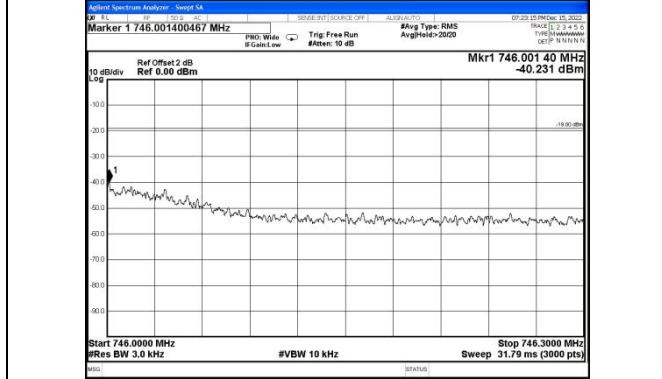

Lower 700MHz band LTE DL Right Side Pre AGC

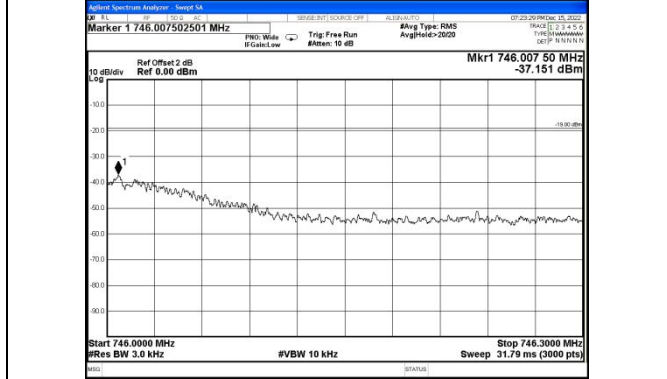

Lower 700MHz band LTE DL Right Side 10dB Above AGC

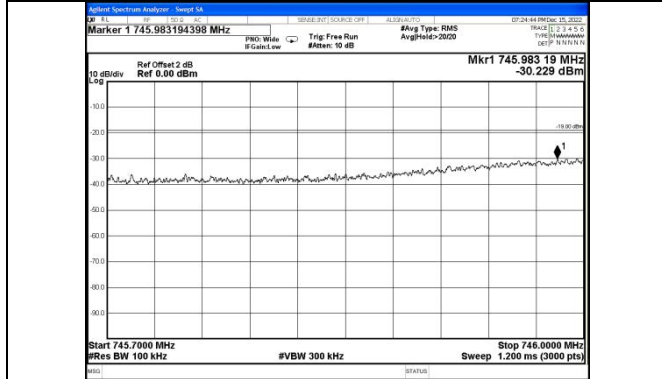

Upper 700MHz band LTE DL Left Side Pre AGC

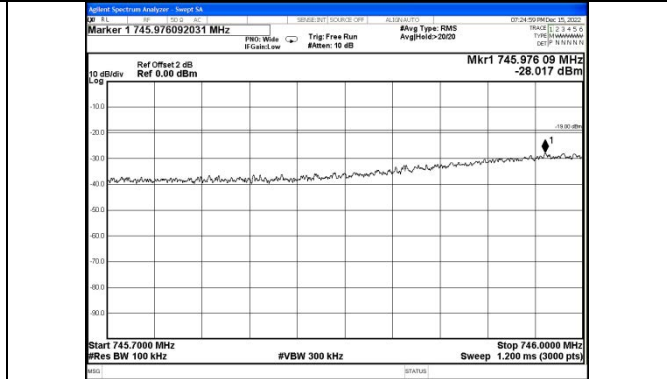

Upper 700MHz band LTE DL Right Side 10dB Above AGC

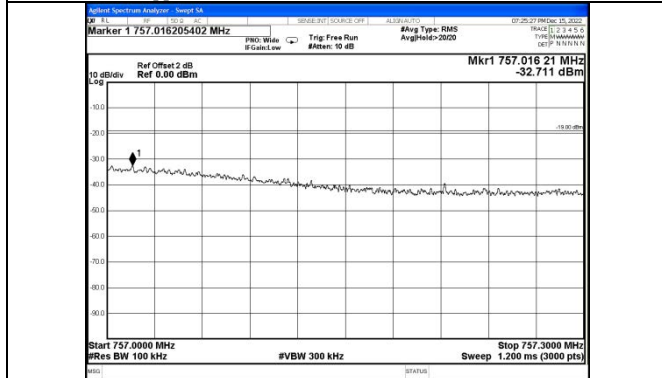

Upper 700MHz band LTE DL Left Side Pre AGC

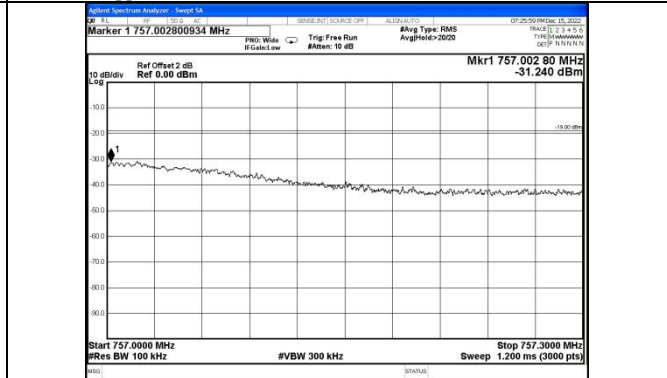

Upper 700MHz band LTE DL Right Side 10dB Above AGC



## 6.6. Conducted Spurious Emission

### Applicable Standard

According to § 20.21(e)(8)(i)(E) Out of Band Emission Limits:

Booster out of band emissions (OOBE) shall be at least 6 dB below the FCC's mobile emission limits for the supported bands of operation. Compliance to OOBE limits will utilize high peak-to-average CMRS signal types.

So the Conducted emissions limit = -19 dBm

### Test Procedure

According to section 7.6 of KDB 935210 D03 Signal Booster Measurement v04r04:

The following procedures shall be used to demonstrate compliance to the applicable conducted spurious emissions limits as per Section 2.1051.

*NOTE—For frequencies below 1 GHz, an RBW of 1 MHz may be used in a preliminary measurement. If non-compliant emissions are detected, a final measurement shall be made with a 100 kHz RBW. Additionally, a peak detector may also be used for the preliminary measurement. If non-compliant emissions are detected then a final measurement of these emissions shall be made with the power averaging (rms) detector.*

- a) Connect the EUT to the test equipment as shown in Figure 1. Begin with the uplink output (donor) port connected to the spectrum analyzer.
- b) Configure the signal generator for AWGN with a 99% OBW of 4.1 MHz, with a center frequency corresponding to the center of the CMRS band under test.
- c) Set the signal generator amplitude to the level determined in the power measurement procedure in 7.2.
- d) Turn on the signal generator RF output and measure the spurious emission power levels with an appropriate measuring instrument as follows.
  - 1) Set RBW = measurement bandwidth specified in the applicable rule section for the operational frequency band under consideration (see Appendix A for relevant cross-references). Note that many of the individual rule sections permit the use of a narrower RBW [typically  $\geq 1\%$  of the emission bandwidth (EBW)] to enhance measurement accuracy, but the result must then be integrated over the specified measurement bandwidth.
  - 2) Set VBW = 3 RBW.
  - 3) Select the power averaging (rms) detector. (See above note regarding the use of a peak detector for preliminary measurements.)
  - 4) Sweep time = auto-couple.
  - 5) Set the analyzer start frequency to the lowest radio frequency signal generated in the equipment, without going below 9 kHz, and the stop frequency to the lower band/block edge frequency minus 100 kHz or 1 MHz, as specified in the applicable rule part. Note that the number of measurement points in each sweep must be  $\geq (2 \text{ span/RBW})$ , which may require that the measurement range defined by the preceding start and stop frequencies be subdivided, depending on the available number of measurement points of the spectrum analyzer. Trace average at least 10 traces in power averaging (i.e., rms) mode.
  - 6) Sweep time = auto-couple.
  - 7) Use the peak marker function to identify the highest amplitude level over each measured frequency range. Record the frequency and amplitude and capture a plot for inclusion in the test report.
  - 8) Reset the analyzer start frequency to the upper band/block edge frequency plus 100 kHz or 1 MHz, as specified in the applicable rule part, and the analyzer stop frequency to 10 times the highest frequency of the fundamental emission. Note that the number of measurement points in each sweep must be  $\geq (2 \text{ span/RBW})$  which may require that the measurement range defined by the start and stop frequencies above be subdivided, depending on the available number of measurement points provided by the spectrum analyzer.
  - 9) Use the peak marker function to identify the highest amplitude level over each of the measured frequency ranges. Record the frequency and amplitude and capture a plot for inclusion in the test report.



e) Repeat 7.6b) through 7.6d) for each supported frequency band of operation.

Test data

Temperature	23.1°C	Humidity	54.2%
Test Engineer	Ling Zhu	Test Mode	Transmitting

Test Graphs

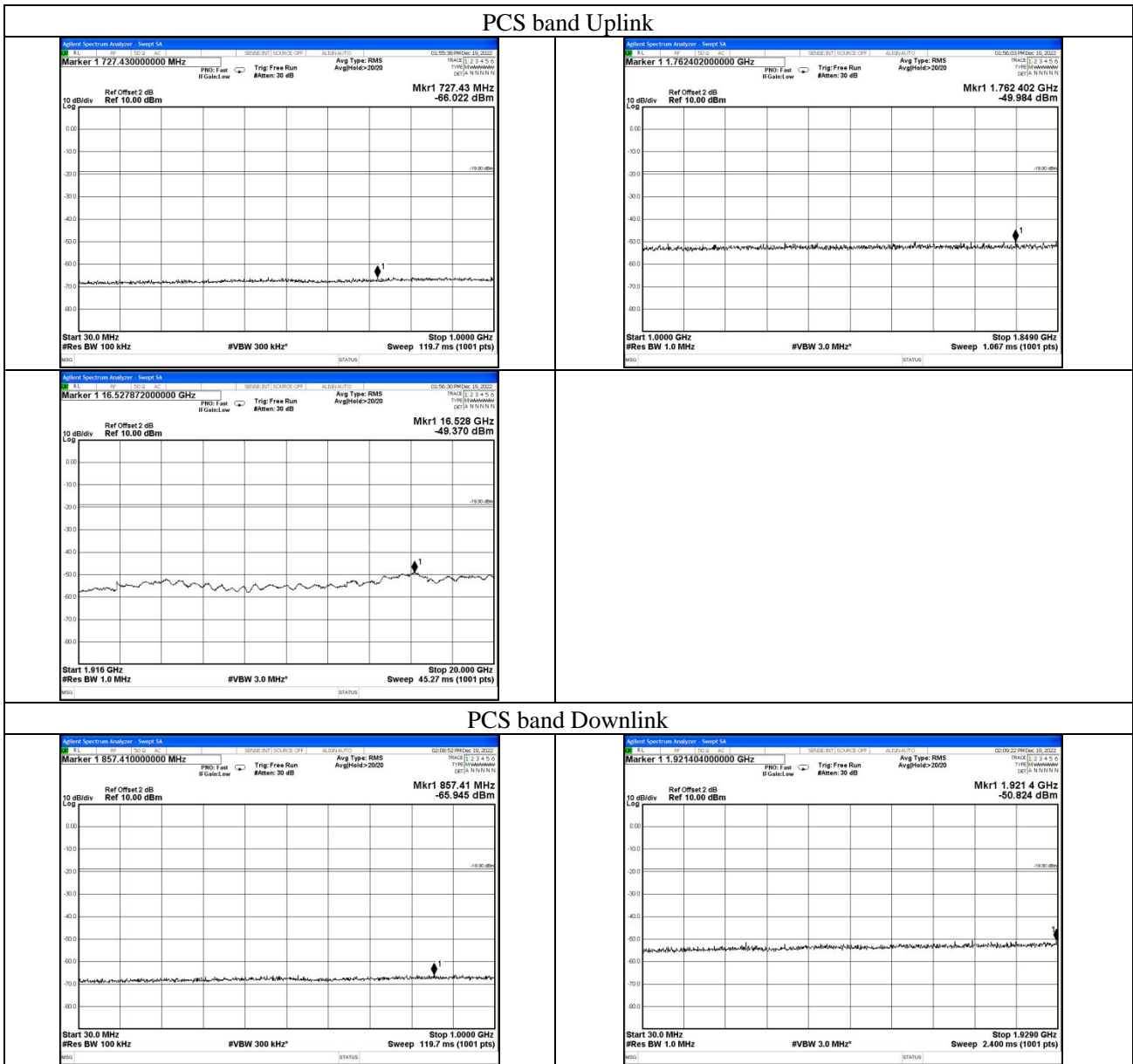

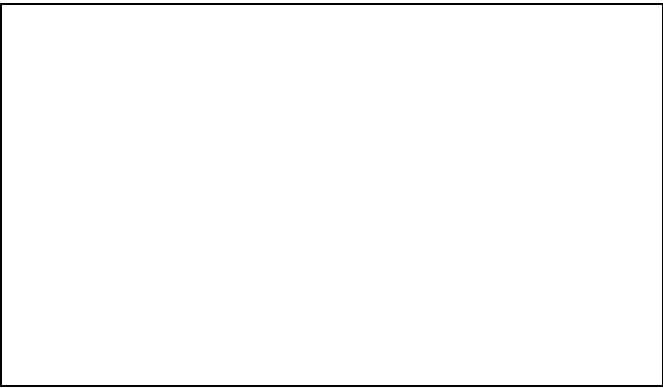
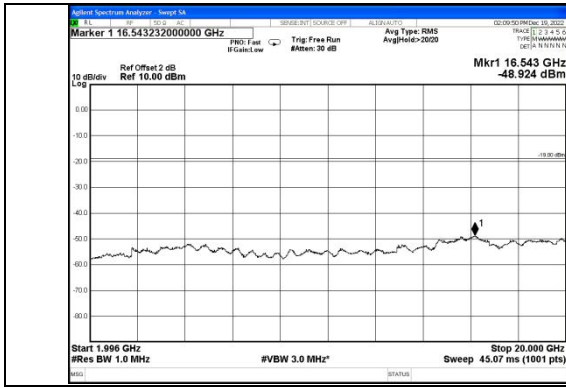

### AWS Band UL

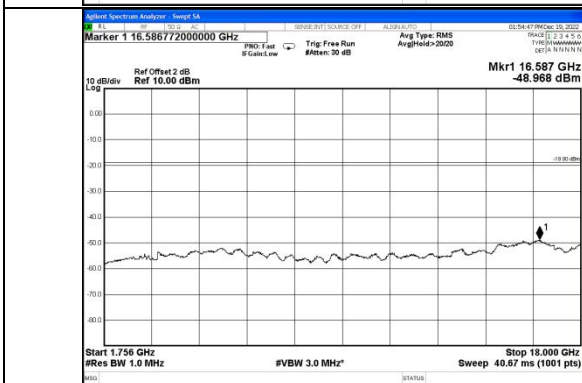
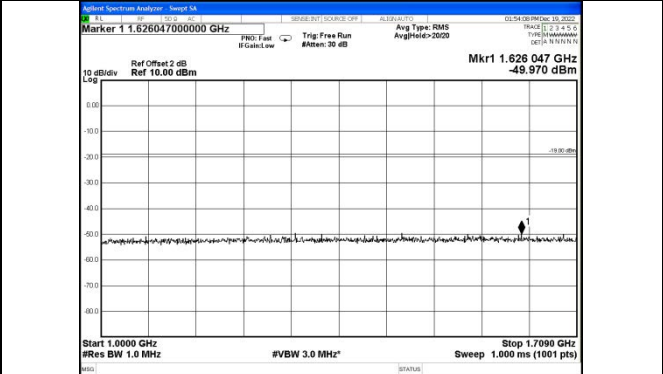
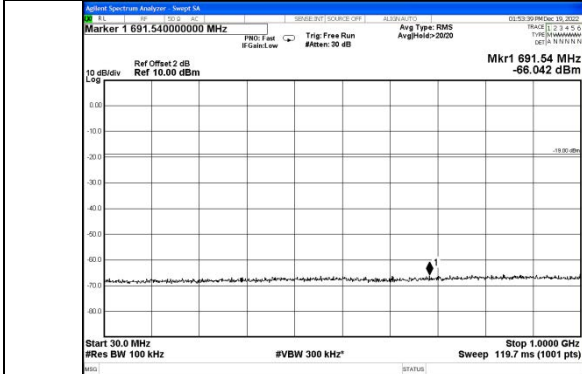

### AWS Band DL

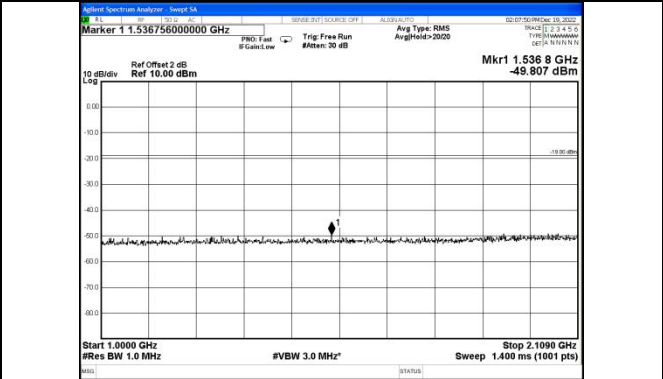

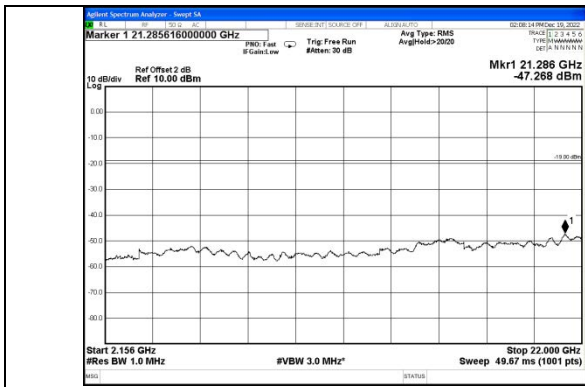

### Cellular Band UL

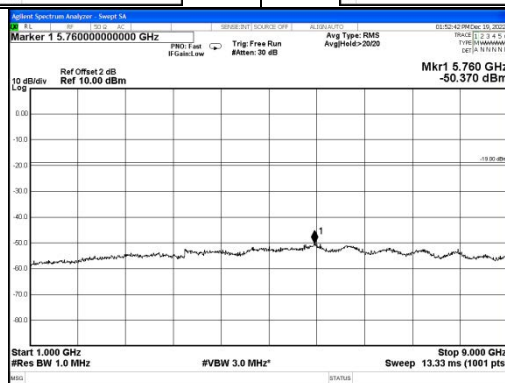

### Cellular Band DL

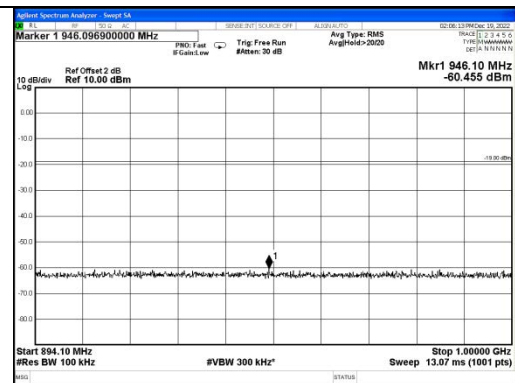
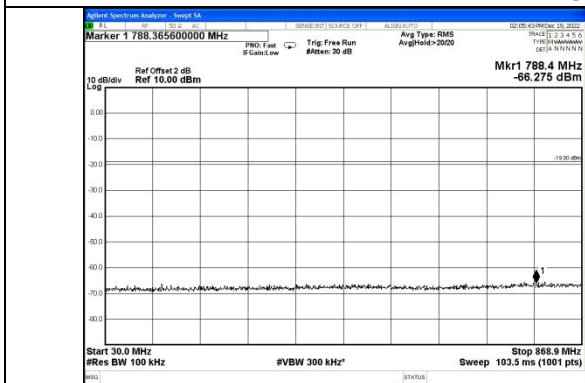

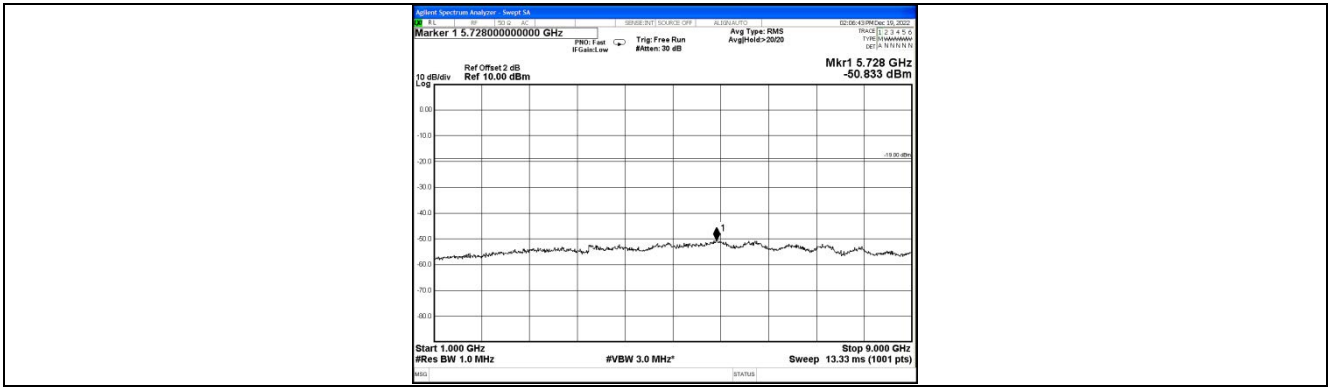

### Lower 700MHz band UL

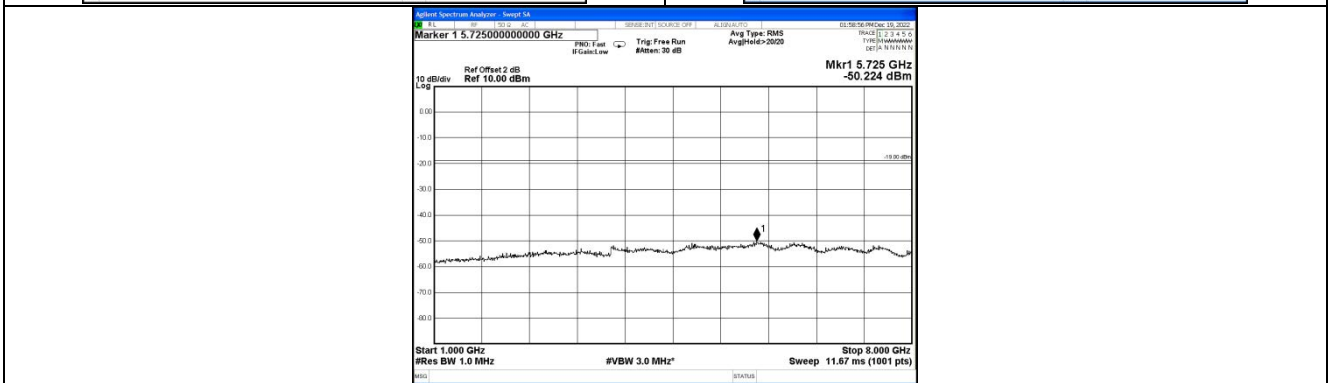
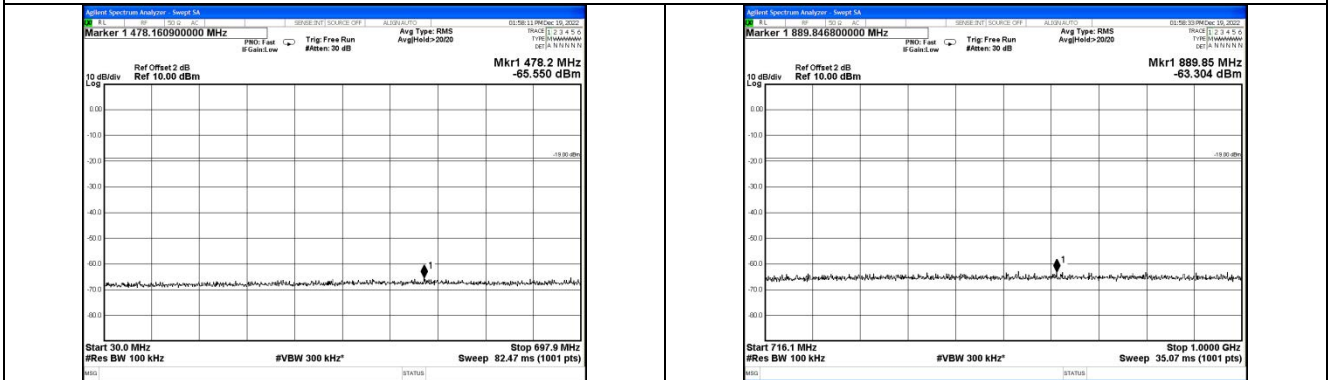

### Lower 700MHz band DL

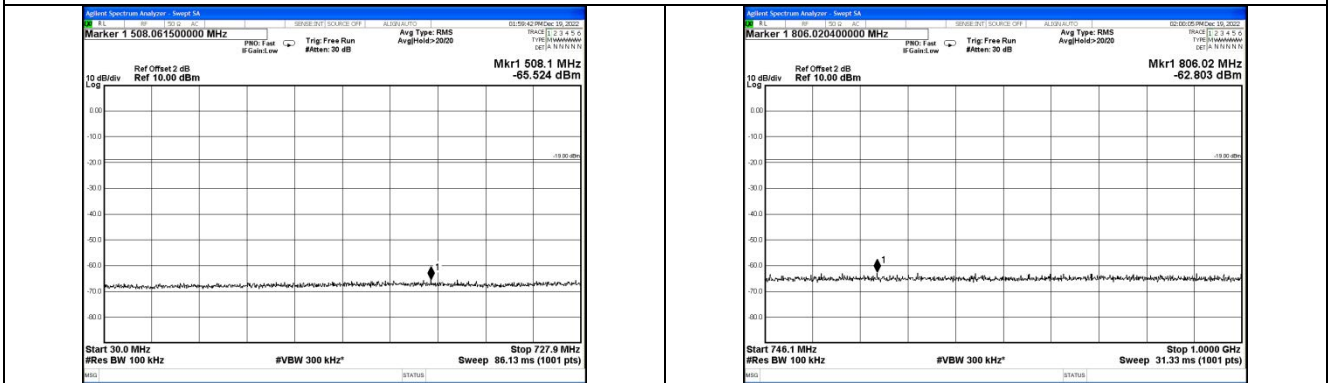



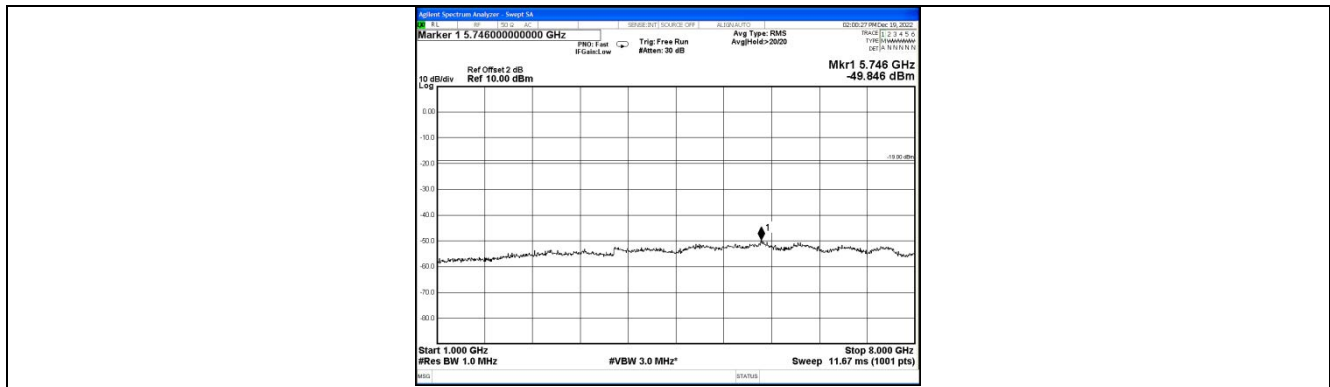

### Upper 700MHz band UL

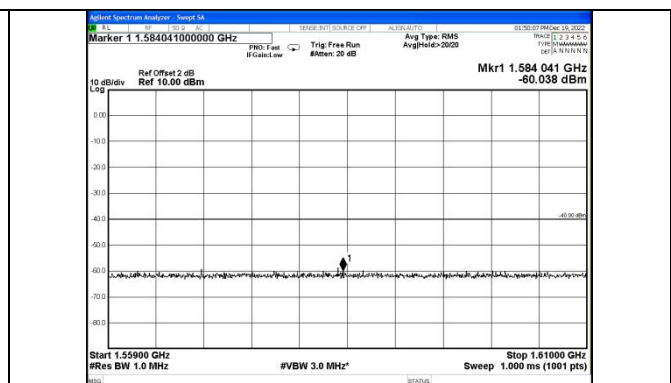
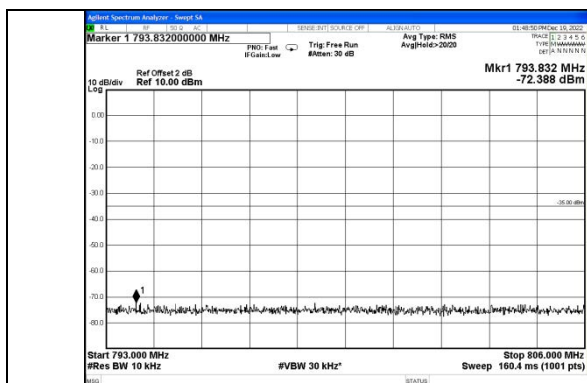
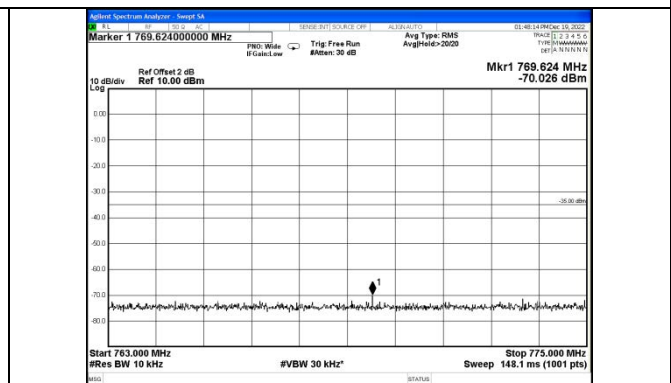
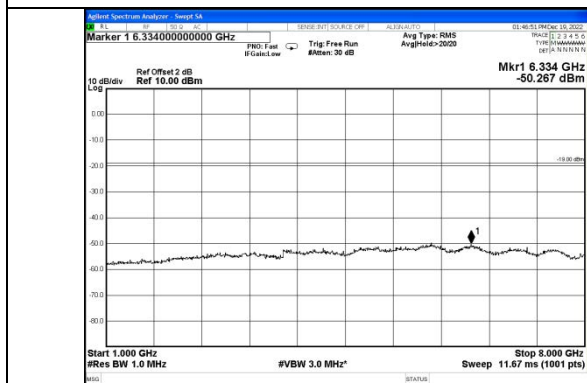
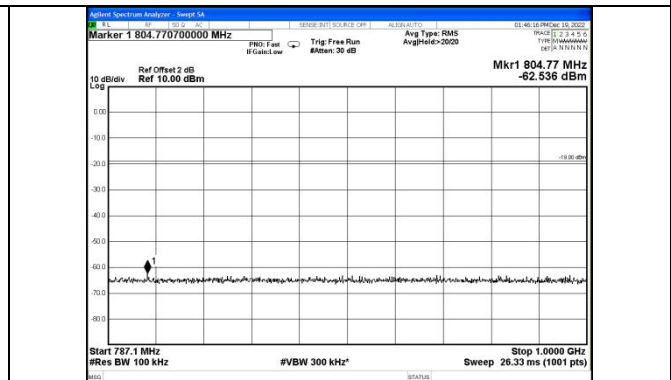



### Upper 700MHz band DL

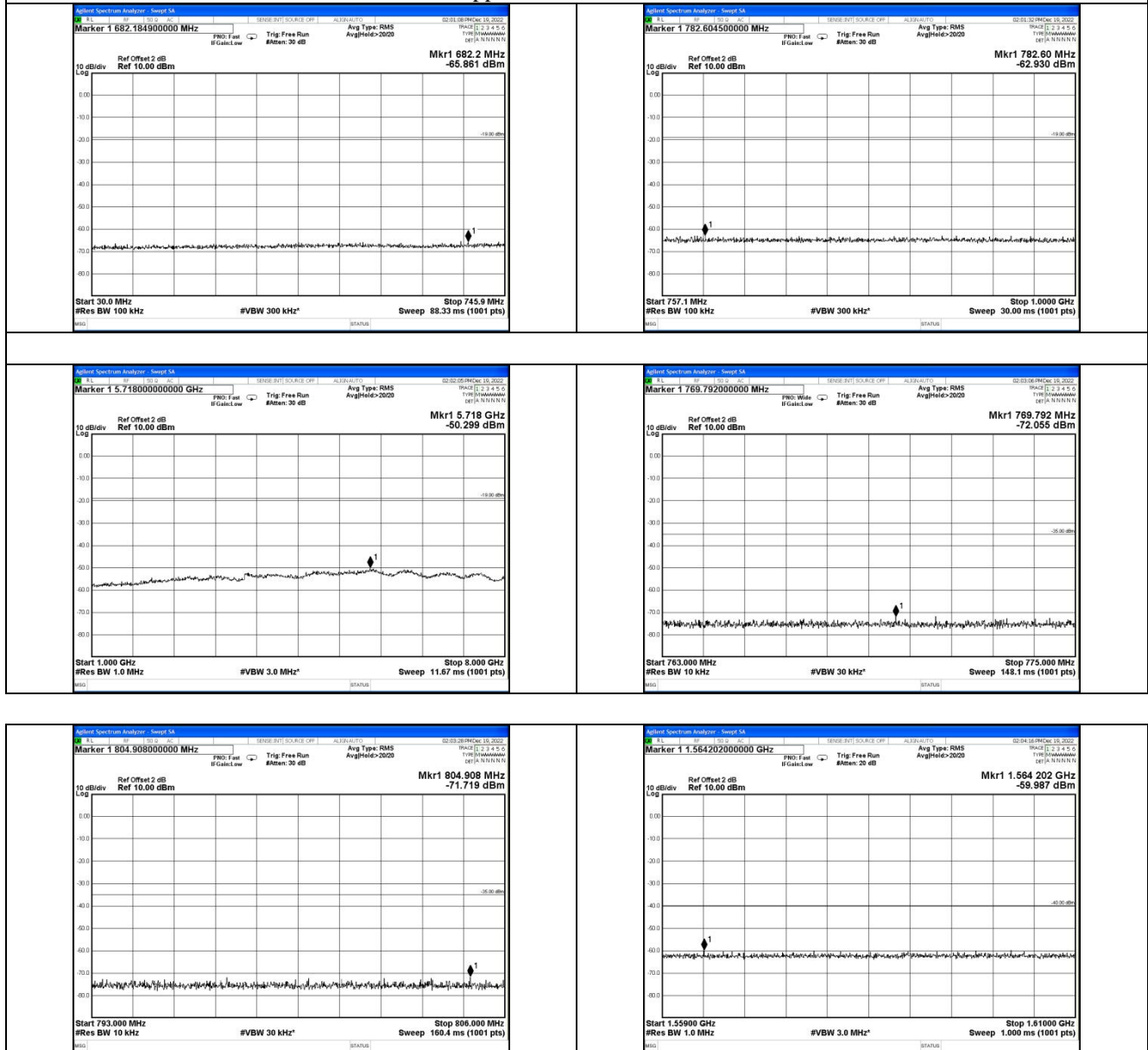



## 6.7 Noise Limits

### Applicable Standard

According to §20.21(e)(8)(i)(A) Noise Limits (uplink); §20.21(e)(8)(i)(H) Transmit Power Off Mode (uplink and downlink noise power):

1. The transmitted maximum noise power in dBm/MHz of consumer boosters at their uplink and downlink ports shall not exceed the following limits:

Fixed booster maximum noise power shall not exceed  $-102.5 \text{ dBm/MHz} + 20 \text{ Log}_{10}(\text{Frequency})$ , where Frequency is the uplink mid-band frequency of the supported spectrum bands in MHz.

2. The transmitted noise power in dBm/MHz of consumer boosters at their uplink port shall not exceed  $-103 \text{ dBm/MHz} - \text{RSSI}$ .

### Test Procedure

Maximum transmitter noise power level

According to section 7.7.1 of KDB 935210 D03 Signal Booster Measurement v04r04:

- a) Connect the EUT to the test equipment as shown in Figure 3. Begin with the uplink output (donor) port connected to the spectrum analyzer. When measuring downlink noise, connect the downlink output (server) port to the spectrum analyzer.
- b) Set the spectrum analyzer RBW to 1 MHz with the VBW  $\geq 3$  RBW.
- c) Select the power averaging (rms) detector and trace average over at least 100 traces.
- d) Set the center frequency of the spectrum analyzer to the center of the CMRS band under test with the span  $\geq 2$  the CMRS band.
- e) Measure the maximum transmitter noise power level.
- f) Save the spectrum analyzer plot as necessary for inclusion in the final test report.
- g) Repeat 7.7b) to 7.7f) for all operational uplink and downlink bands.
- h) Connect the EUT to the test equipment as shown in Figure 4 for uplink noise power measurement in the presence a downlink signal. Affirm the coupled path of the RF coupler is connected to the spectrum analyzer.
  - i) Configure the signal generator for AWGN operation with a 99% OBW of 4.1 MHz.
  - j) Set the spectrum analyzer RBW for 1 MHz, VBW  $\geq 3$  RBW, with a power averaging (rms) detector with at least 100 trace averages.
  - k) Set the center frequency of the spectrum analyzer to the center of the CMRS band under test, with the span  $\geq 2$  the CMRS band. This shall include all spectrum blocks in the particular CMRS band under test (see Appendix A).
    - l) For uplink noise measurements, set the spectrum analyzer center frequency for the uplink band under test, and tune the signal generator to the center of the paired downlink band.
    - m) Measure the maximum transmitter noise power level while varying the downlink signal generator output level from  $-90 \text{ dBm}$  to  $-20 \text{ dBm}$ , as measured at the input port (i.e., downlink signal level at the booster donor port node of Figure 4), in 1 dB steps inside the RSSI-dependent region, and in 10 dB steps outside the RSSI-dependent region. Report the six values closest to the limit, with at least two points within the RSSI-dependent region of the limit. See Appendix D for noise limits graphs.
    - n) Repeat 7.7.1h) through 7.7.1m) for all operational uplink bands.

*NOTE—Some signal boosters will require a signal generator input because they will not operate unless a signal is received at the input terminals. If this is the case, for the setups shown in Figure 3 and Figure 4 connect a second signal generator at the server port, then cycle the RF output of the second signal generator to simulate this function.*

*NOTE—Some signal boosters have a maximum transmitter noise power level that is less than the Transmit Power Off Mode of -70 dBm. For these boosters it is still necessary to confirm that the uplink noise power limits are met in the presence of a downlink signal. Test reports should show measurement data demonstrating compliance. Alternatively the applicant may provide attestation with detailed design information and explanation justifying the omission of the variable uplink testing.*

**Variable uplink noise timing**

According to section 7.7.2 of KDB 935210 D03 Signal Booster Measurement v04r04:

Variable uplink noise timing is to be measured as follows, using the test setup shown in Figure 4.

- a) Set the spectrum analyzer to the uplink frequency to be measured.
- b) Set the span to 0 Hz, with a sweep time of 10 seconds.
- c) Set the power level of signal generator to the lowest level of the RSSI-dependent noise [see 7.7.1m)].
- d) Select MAX HOLD and increase the power level of signal generator by 10 dB for mobile boosters, and 20 dB for fixed boosters.
- e) Confirm that the uplink noise decreases to the specified level within 1 second for mobile devices, and within 3 seconds for fixed devices.18
- f) Repeat 7.7.2a) to 7.7.2e) for all operational uplink bands.
- g) Include plots and summary table in test report.

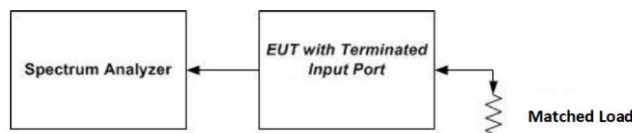

**Figure 3 – Noise limit test setup**

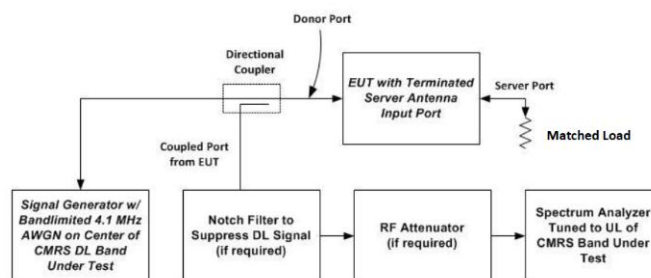

**Figure 4 – Test setup for uplink noise power measurement in the presence of a downlink signal**

**Test Data**

Temperature	23.1°C	Humidity	54.2%
Test Engineer	Ling Zhu	Test Mode	Transmitting

Max Noise Power			
Frequency Band (MHz)	Measured dBm/MHz	Limit dBm/MHz	Result (dB)
PCS Band Uplink	-53.12	-37.01	PASS
AWS Band Uplink	-52.31	-37.73	PASS
Cellular Band Uplink	-53.56	-44.05	PASS
Lower 700MHz band Uplink	-52.36	-45.51	PASS
Band13 Uplink	-50.12	-44.64	PASS
PCS Band Downlink	-50.12	-37.01	PASS
AWS Band Downlink	-50.31	-37.73	PASS
Cellular Band Downlink	-52.13	-44.05	PASS
Lower 700MHz band Downlink	-53.12	-45.51	PASS
Lower 700MHz band Downlink	-52.36	-44.64	PASS



Variable Uplink Noise				
Operation Bands	RSSI dBm	Measured dBm/MHz	Limit dBm/MHz	Results
PCS	-80	-45.62	-37.01	PASS
	-70	-41.32	-37.01	PASS
	-60	-54.32	-43	PASS
	-44	-63.42	-59	PASS
	-43	-63.12	-60	PASS
	-42	-66.28	-61	PASS
AWS	-80	-51.21	-37.73	PASS
	-70	-50.21	-37.73	PASS
	-60	-49.65	-43	PASS
	-39	-67.14	-64	PASS
	-38	-68.36	-65	PASS
	-37	-71.32	-66	PASS
Cellular	-80	-45.32	-44.05	PASS
	-70	-45.45	-44.05	PASS
	-60	-45.63	-44.05	PASS
	-50	-55.32	-53	PASS
	-49	-56.12	-54	PASS
	-48	-56.28	-55	PASS
Lower 700 MHz	-80	-47.12	-45.51	PASS
	-70	-51.32	-45.51	PASS
	-60	-50.32	-45.51	PASS
	-50	-57.21	-53	PASS
	-49	-64.52	-54	PASS
	-48	-65.32	-55	PASS
Upper 700 MHz	-80	-47.52	-44.64	PASS
	-70	-50.21	-44.64	PASS
	-60	-50.26	-44.64	PASS
	-50	-56.37	-53	PASS
	-49	-57.85	-54	PASS
	-48	-59.62	-55	PASS



Variable Uplink Noise Timing			
Operation Bands	Measured Sec	Limit Sec	Results
PCS	0.25	3	PASS
AWS	0.35	3	PASS
Cellular	0.31	3	PASS
Lower 700	0.28	3	PASS
Upper 700	0.25	3	PASS



## 6.8 Uplink Inactivity

### Applicable Standard

According to §20.21(e)(8)(i)(I) Uplink Inactivity:

When a consumer booster is not serving an active device connection after 5 minutes the uplink noise power shall not exceed  $-70$  dBm/MHz.

### Test Procedure

According to section 7.8 of KDB 935210 D03 Signal Booster Measurement v04r04:

- a. Connect the EUT to the test equipment as shown in Figure 3 with the uplink output (donor) port connected to the spectrum analyzer.
  - b. Select the power averaging (rms) detector.
  - c. Set the spectrum analyzer RBW for 1 MHz with the  $VBW \geq 3$  RBW.
  - d. Set the center frequency of the spectrum analyzer to the center of the uplink operational band.
  - e. Set the span for 0 Hz with a single sweep time for a minimum of 330 seconds.
  - f. Start to capture a new trace using MAX HOLD.
  - g. After approximately 15 seconds, turn on the EUT power.
  - h. After the full spectrum analyzer trace is complete, place a MARKER on the leading edge of the pulse, then use the DELTA MARKER METHOD to measure the time until the uplink becomes inactive.
  - i. Affirm that the noise level is below the uplink inactivity noise power limit, as specified by the rules.
  - j. Capture the plot for inclusion in the test report.
  - k. Measure noise using procedures in 7.7.1a) to 7.7.1f).
- Repeat 7.8d) through 7.8k) for all operational uplink bands.





## Test Data

Temperature	23.1 °C	Humidity	54.2%
Test Engineer	Ling Zhu	Test Mode	Transmitting

Uplink Inactivity			
Operation Bands	Measured (s)	Limit (s)	Result
PCS Band	295.36	300.0	PASS
AWS Band	297.25	300.0	PASS
Cellular Band	295.52	300.0	PASS
Lower 700MHz Band	297.52	300.0	PASS
Upper 700 Mhz Band	297.52	300.0	PASS



## 6.9 Variable Booster Gain

### Applicable Standard

According to §20.21(e)(8)(i)(C)(1) Booster Gain Limits (variable gain); §20.21(e)(8)(i)(H) Transmit Power Off Mode (uplink gain):

The uplink gain in dB of a consumer booster referenced to its input and output ports shall not exceed  $-34 \text{ dB} - \text{RSSI} + \text{MSCL}$ .

(i) Where RSSI is the downlink composite received signal power in dBm at the booster donor port for all base stations in the band of operation. RSSI is expressed in negative dB units relative to 1 mW.

(ii) Where MSCL (Mobile Station Coupling Loss) is the minimum coupling loss in dB between the wireless device and input port of the consumer booster. MSCL must be calculated or measured for each band of operation and provided in compliance test reports.

### Test Procedure

#### Variable gain

According to section 7.9.1 of KDB 935210 D03 Signal Booster Measurement v04r04:

- a) Connect the EUT to the test equipment as shown in Figure 5 with the uplink output (donor) port connected to signal generator #1. Affirm that the coupled path of the RF coupler is connected to the spectrum analyzer.
- b) Configure downlink signal generator #1 for AWGN operation with a 99% OBW of 4.1 MHz, tuned to the center of the operational band.
- c) Set the power level and frequency of signal generator #2 to a value that is 5 dB below the AGC level determined from 7.2. The signal type is AWGN with a 99% OBW of 4.1 MHz.
- d) Set RBW = 100 kHz.
- e) Set VBW  $\geq$  300 kHz.
- f) Select the CHANNEL POWER measurement mode.
- g) Select the power averaging (rms) detector.
- h) Affirm that the number of measurement points per sweep  $\geq$  (2 span)/RBW.
- i) Sweep time = auto couple or as necessary (but no less than auto couple value).
- j) Trace average at least 10 traces in power averaging (i.e., rms) mode.
- k) Measure the maximum channel power and compute maximum gain when varying the signal generator #1 output to a level from  $-90 \text{ dBm}$  to  $-20 \text{ dBm}$ , as measured at the input port (i.e., downlink signal level at the booster donor port node of Figure 5), in 1 dB steps inside the RSSI-dependent region, and 10 dB steps outside the RSSI-dependent region. Report the six values closest to the limit, including at least two points from within the RSSI-dependent region of operation. See gain limit in charts in Appendix D for uplink gain requirements. Additionally, document that the EUT provides equivalent uplink and downlink gain, and when operating in shutoff mode that the uplink and downlink gain is within the transmit power off mode gain limits.
- l) Repeat 7.9.1b) to 7.9.1k) for all operational uplink bands.

### Variable uplink gain timing

According to section 7.9.2 of KDB 935210 D03 Signal Booster Measurement v04r04:

Variable uplink gain timing is to be measured as follows, using the test setup shown in Figure 5.

- a) Set the spectrum analyzer to the uplink frequency to be measured.
- b) Set the span to 0 Hz with a sweep time of 10 seconds.
- c) Set the power level of signal generator #1 to the lowest level of the RSSI-dependent gain [see 7.9.1k)].
- d) Select MAX HOLD and increase the power level of signal generator #1 by 10 dB for mobile boosters, and by 20 dB for fixed indoor boosters. Signal generator #2 remains same, as described in 7.9.1c).
- e) Confirm that the uplink gain decreases to the specified levels, within 1 second for mobile devices, and within 3 seconds for fixed devices.19
- f) Repeat 7.9.2a) to 7.9.2e) for all operational uplink bands.

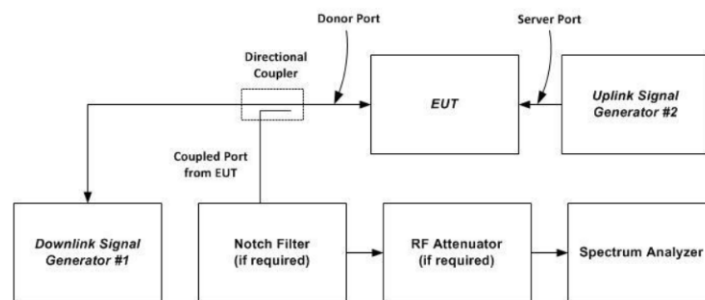

**Figure 5–Variable gain instrumentation test setup**

Mobile station coupling loss (MSCL): the minimum coupling loss (in dB) between the wireless device and the input (server) port of the consumer booster. MSCL must be calculated or measured for each band of operation and provided in compliance test reports. MSCL includes the path loss from the wireless device, and the booster's server antenna gain and cable loss. The wireless device is assumed to be an isotropic (0 dBi) antenna reference. Minimum standoff distances from inside wireless devices to the booster's server antenna must be reasonable and specified by the manufacturer in customer provided installation manuals.

**Test data**

Temperature	23.1℃	Humidity	54.2%
Test Engineer	Ling Zhu	Test Mode	Transmitting

**Omni Antenna**

MSCL Calculation							
Operation Frequency (MHz)	Frequency (MHz)	Distance (m)	Path loss (dB)	Indoor Antenna Gain(dBi)	Indoor Cable Loss(dB)	Polarity Loss(dB)	MSCL(dB)
PCS band	1882.5	1.5	41.52	3.0	1.4	3.01	42.93
Cellular band	836.5	1.5	34.47	3.0	0.8	3.01	35.28
Lower 700MHz band	707	1.5	33.01	3.0	0.8	3.01	33.82
Upper 700MHz band	781.5	1.5	33.88	3.0	0.8	3.01	34.69
AWS band	1732.5	1.5	40.80	3.0	1.4	3.01	42.21

Note :Path loss =  $20\log f + 20\log d - 27.5$

Polarity loss =  $20\log (1/\sin (45\text{deg})) \text{ dB} = 3.0\text{dB}$

d=1.5m,used in User Manual

**Panel Antenna**

MSCL Calculation							
Operation Frequency (MHz)	Frequency (MHz)	Distance (m)	Path loss (dB)	Indoor Antenna Gain(dBi)	Indoor Cable Loss(dB)	Polarity Loss(dB)	MSCL(dB)
PCS band	1882.5	1.0	37.99	9.0	1.4	3.01	33.40
Cellular band	836.5	1.0	30.95	7.0	0.8	3.01	27.76
Lower 700MHz band	707	1.0	29.49	7.0	0.8	3.01	26.30
Upper 700MHz band	781.5	1.0	30.36	7.0	0.8	3.01	27.17
AWS band	1732.5	1.0	37.27	9.0	1.4	3.01	32.68

Note :Path loss =  $20\log f + 20\log d - 27.5$

Polarity loss =  $20\log (1/\sin (45\text{deg})) \text{ dB} = 3.0\text{dB}$

d=1.0m,used in User Manual



Variable booster gain							
Operation Band	RSSI (dBm)	Input Power (dBm)	Output Power (dBm)	Measured Gain (dB)	MSCL	Limit	Results
PCS band	-60	-38.2	7.52	45.72	26.30	52.30	PASS
	-50	-38.2	1.52	39.72	26.30	42.30	PASS
	-46	-38.2	-5.52	32.68	26.30	38.30	PASS
	-43	-38.5	-6.25	32.25	26.30	35.30	PASS
	-42	-38.2	-7.52	30.68	26.30	34.30	PASS
	-40	-38.5	-9.21	29.29	26.30	32.30	PASS
Cellular band	-60	-37.5	7.34	44.84	27.76	53.76	PASS
	-50	-37.5	1.14	38.64	27.76	43.76	PASS
	-46	-37.5	-5.87	31.63	27.76	39.76	PASS
	-43	-37.5	-6.12	31.38	27.76	36.76	PASS
	-42	-37.5	-7.12	30.38	27.76	35.76	PASS
	-40	-37.6	-10.32	27.28	27.76	33.76	PASS
Lower 700MHz band	-60	-37.2	6.52	43.72	26.30	52.30	PASS
	-50	-37.5	1.12	38.62	26.30	42.30	PASS
	-46	-37.5	-6.12	31.38	26.30	38.30	PASS
	-43	-37.4	-6.12	31.28	26.30	35.30	PASS
	-42	-37.5	-7.12	30.38	26.30	34.30	PASS
	-40	-37.5	-10.32	27.18	26.30	32.30	PASS
Upper 700MHz band	-60	-36.5	6.52	43.02	27.17	53.17	PASS
	-50	-36.2	0.63	36.83	27.17	43.17	PASS
	-46	-36.5	-6.52	29.98	27.17	39.17	PASS
	-43	-36.2	-7.52	28.68	27.17	36.17	PASS
	-42	-36.5	-8.12	28.38	27.17	35.17	PASS
	-40	-36.5	-9.41	27.09	27.17	33.17	PASS
AWS band	-60	-37.3	7.36	44.66	32.68	58.68	PASS



	-50	-37.5	1.12	45.72	32.68	48.68	PASS
	-46	-37.5	-6.21	39.72	32.68	44.68	PASS
	-43	-37.3	-6.12	32.68	32.68	41.68	PASS
	-42	-37.5	-7.62	32.25	32.68	40.68	PASS
	-40	-37.5	-8.12	30.68	32.68	38.68	PASS



Variable Uplink Gain Timing			
Operation Band	Measured Sec	Limit Sec	Result
PCS band	0.24	3.0	PASS
AWS band	0.24	3.0	PASS
Cellular band	0.18	3.0	PASS
Lower 700MHz band	0.24	3.0	PASS
Upper 700MHz band	0.19	3.0	PASS

## 6.10 Occupied Bandwidth

### Applicable Standard

According to §2.1049 Measurements required: Occupied bandwidth.

This measurement is required to compare the consistency of the output signal relative to the input signal, and to satisfy the requirements of Section 2.1049.

### Test Procedure

According to section 7.10 of KDB 935210 D03 Signal Booster Measurement v04r04:

- a) Connect the test equipment as shown in Figure 6 to firstly measure the characteristics of the test signals produced by the signal generator.
- b) Set  $VBW \geq 3 RBW$ .
- c) Set the center frequency of the spectrum analyzer to the center of the operational band. The span will be adjusted for each modulation type and OBW as necessary for accurately viewing the signals.
- d) Set the signal generator for power level to match the values obtained from the tests of 7.2.
- e) Set the signal generator modulation type for GSM with a PRBS pattern and allow the trace on the signal generator to stabilize adjusting the span as necessary.
- f) Set the spectrum analyzer RBW for 1% to 5% of the EBW.
- g) Capture the spectrum analyzer trace for inclusion in the test report.
- h) Repeat 7.10c) to 7.10g) for CDMA and W-CDMA modulation, adjusting the span as necessary. AWGN or LTE may be used in place of W-CDMA, as an option.
- i) Repeat 7.10c) to 7.10h) for all uplink and downlink operational bands.
- j) Connect the test equipment as shown in Figure 1, with the uplink output (donor) port connected to the spectrum analyzer, and the server port connected to the signal generator.
- k) Repeat 7.10c) to 7.10i) with this EUT uplink path test setup.
- l) Connect the test equipment as shown in Figure 1, with the downlink output (server) port connected to the spectrum analyzer, and the donor port connected to the signal generator.
- m) Repeat 7.10c) to 7.10i) with this EUT downlink path test setup.

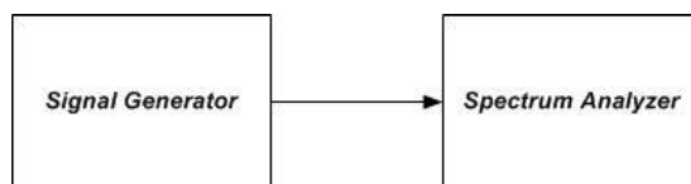

**Figure 6 – Test setup for measuring characteristics of test signals used for subsequent EUT occupied bandwidth testing**





**Test data**

Temperature	23.1 °C	Humidity	54.2%
Test Engineer	Ling Zhu	Test Mode	Transmitting

Operation Band		Signal Type	Input OBW [MHz]	Output OBW [MHz]
Uplink	PCS	GSM	0.246	0.250
		CDMA	1.226	1.236
		AWGN	4.277	4.399
	AWS	GSM	0.247	0.247
		CDMA	1.234	1.234
		AWGN	4.265	4.392
	Cellular	GSM	0.248	0.244
		CDMA	1.222	1.228
		AWGN	4.240	4.354
	Lower 700	GSM	0.251	0.244
		CDMA	1.220	1.222
		AWGN	4.251	4.385
	Upper 700	GSM	0.247	0.247
		CDMA	1.225	1.223
		AWGN	4.252	4.384
Downlink	PCS	GSM	0.252	0.248
		CDMA	1.232	1.222
		AWGN	4.304	4.393
	AWS	GSM	0.249	0.244
		CDMA	1.231	1.226
		AWGN	4.290	4.402
	Cellular	GSM	0.245	0.246
		CDMA	1.241	1.221
		AWGN	4.263	4.424
	Lower 700	GSM	0.247	0.245
		CDMA	1.218	1.232
		AWGN	4.264	4.372
	Upper 700	GSM	0.244	0.247
		CDMA	1.231	1.231
		AWGN	4.266	4.197



### Test Graphs

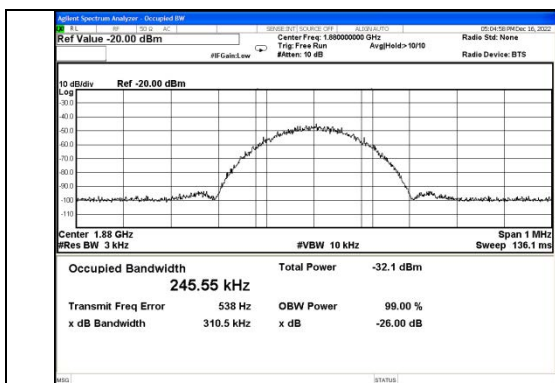

GSM-PCS band UL input

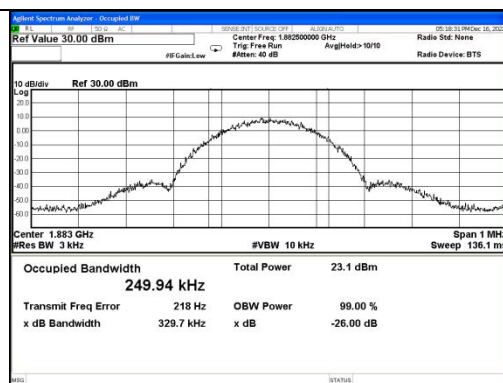

GSM-PCS band UL output

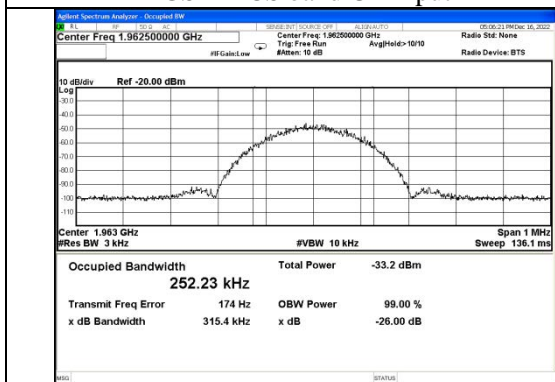

GSM-PCS band DL input

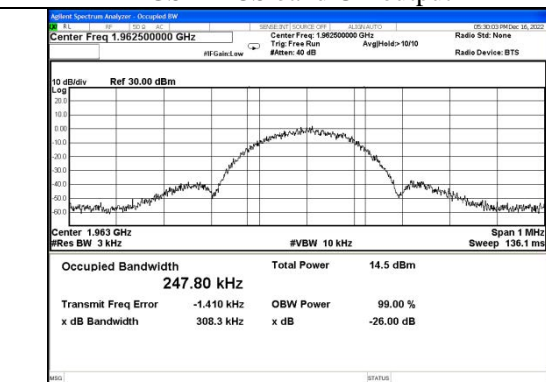

GSM-PCS band DL output

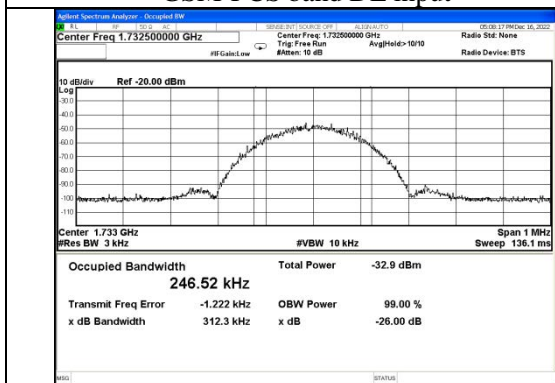

GSM-AWS band UL input

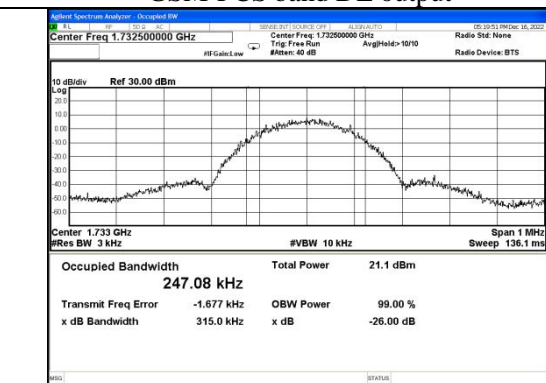

GSM-AWS band UL output

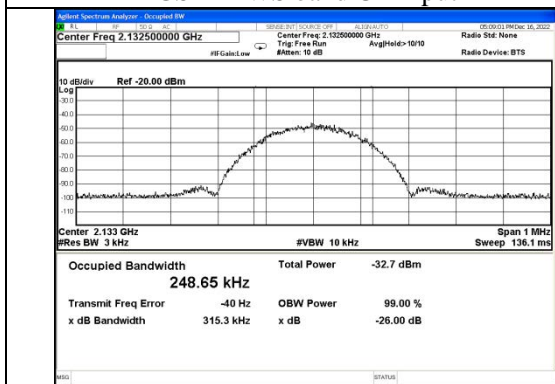

GSM-AWS band DL input

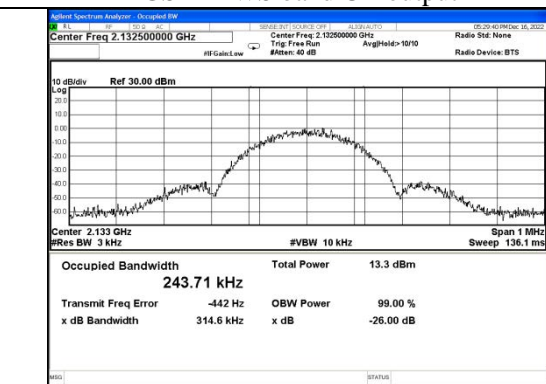

GSM-AWS band DL output

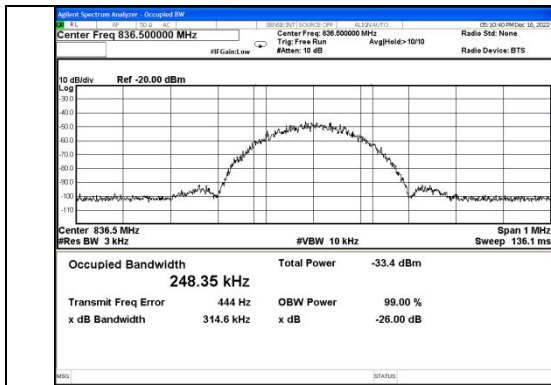

GSM-Cellular band UL input

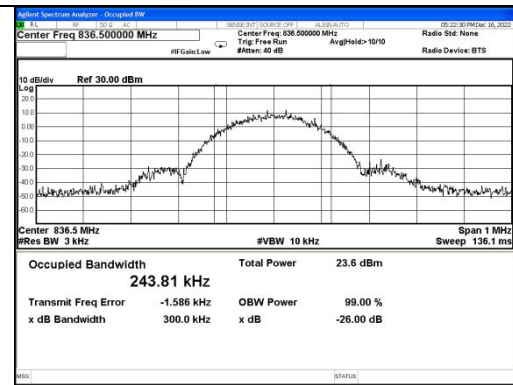

GSM-Cellular band UL output

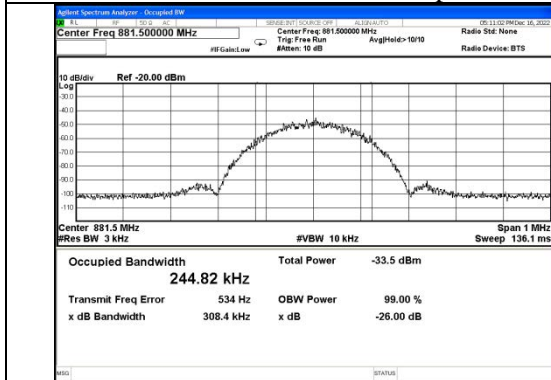

GSM-Cellular band DL input

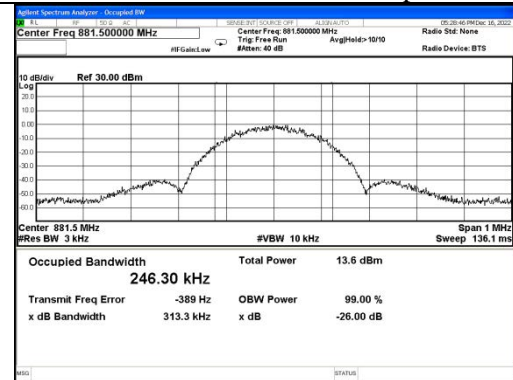

GSM-Cellular band DL output

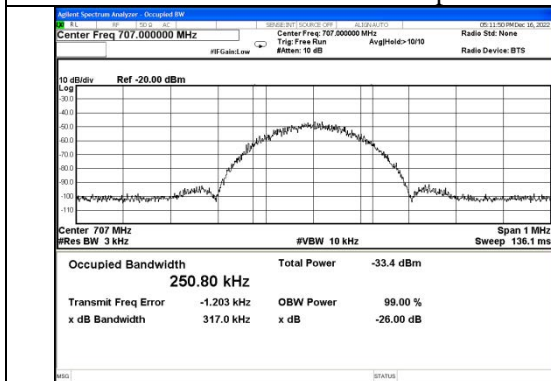

GSM-Lower 700 band UL input

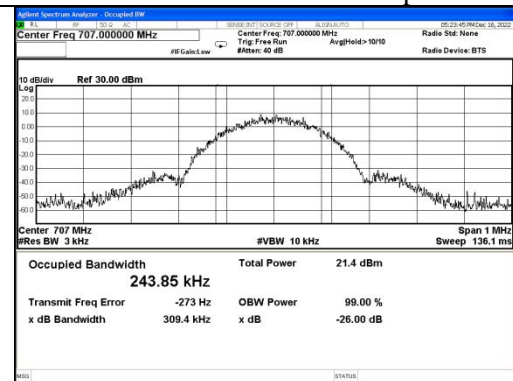

GSM-Lower 700 band UL output

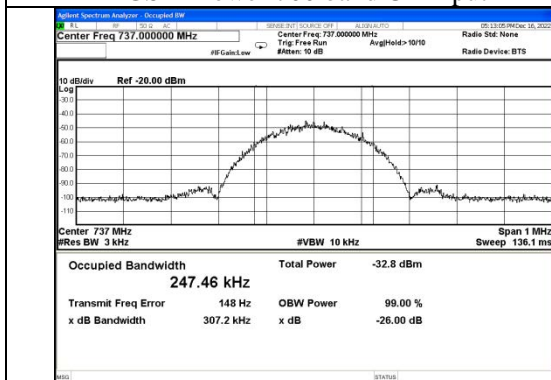

GSM-Lower 700 band DL input

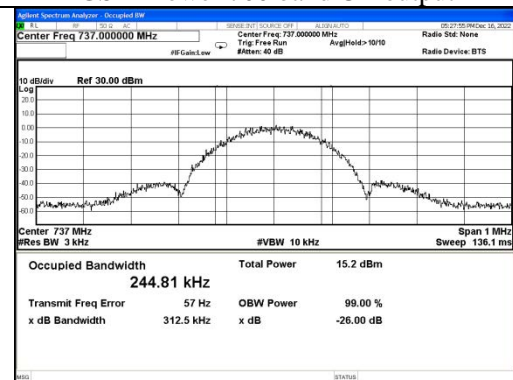

GSM-Lower 700 band DL output

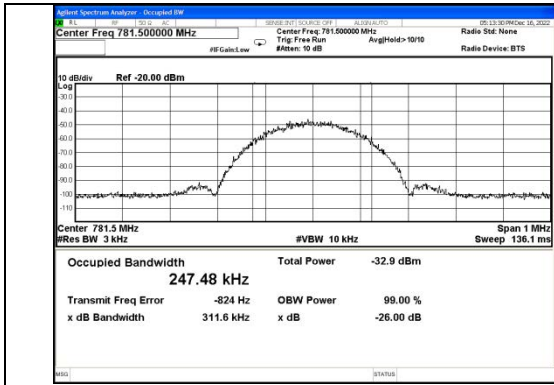

GSM-Upper 700MHz band UL input

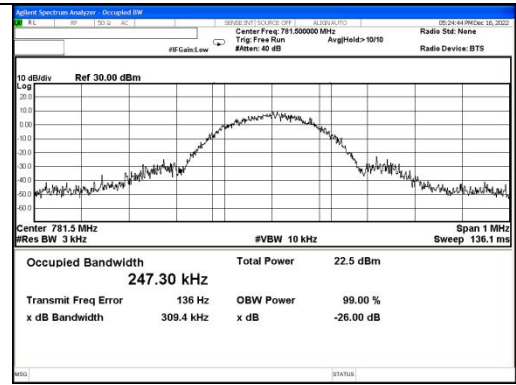

GSM-Upper 700 band UL output

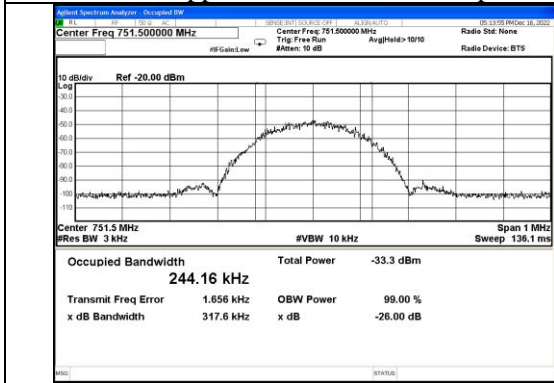

GSM-Upper 700 band DL input

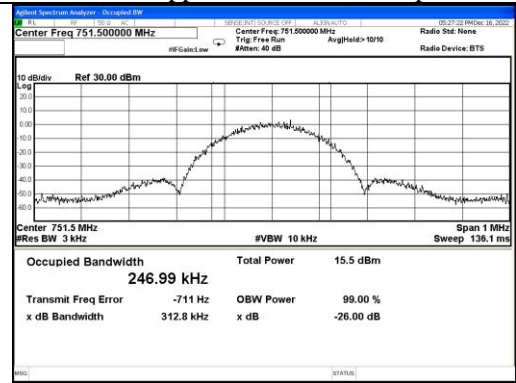

GSM-Upper 700 band DL output

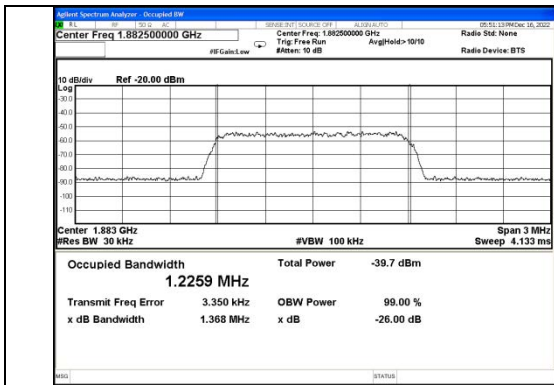

CDMA-PCS band UL input

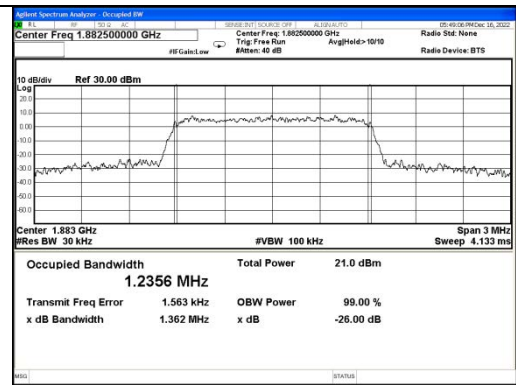

CDMA-PCS band UL output

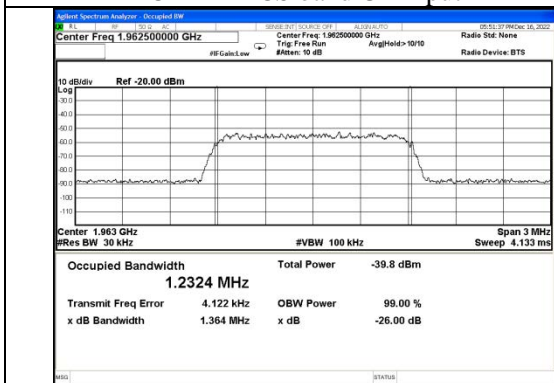

CDMA-PCS band DL input

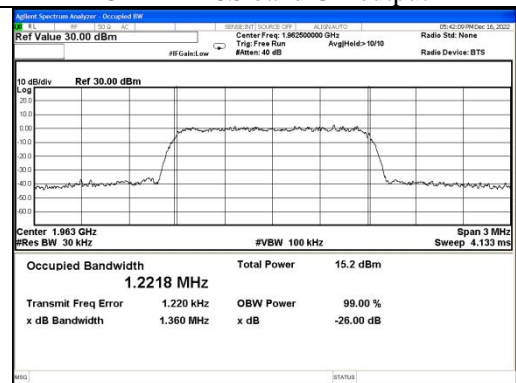

CDMA-PCS band DL output

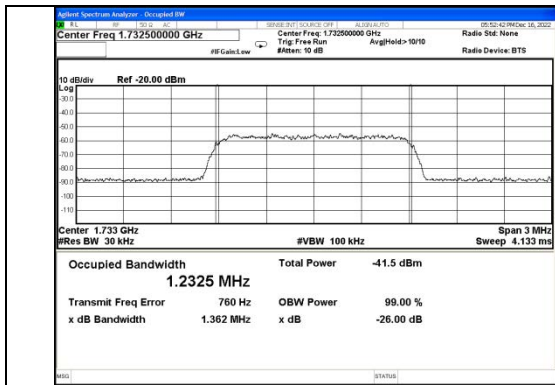

CDMA-AWS band UL input

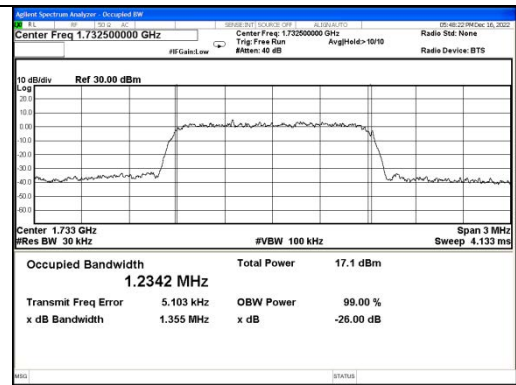

CDMA-AWS band UL output

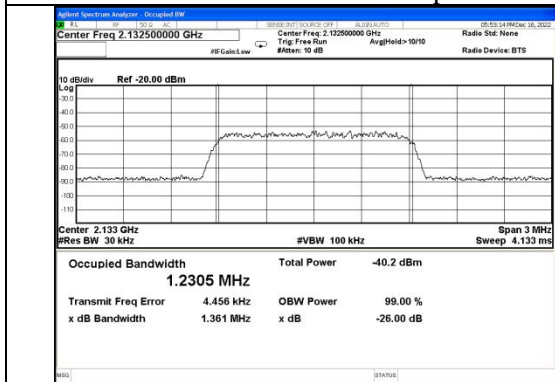

CDMA-AWS band DL input

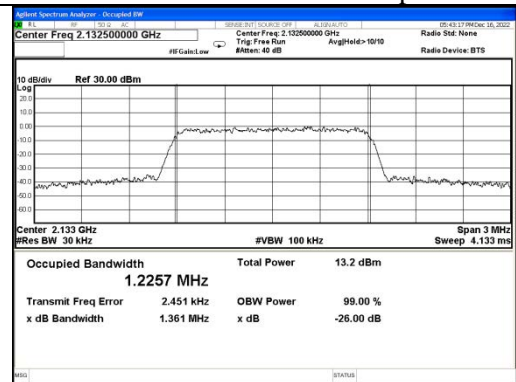

CDMA-AWS band DL output

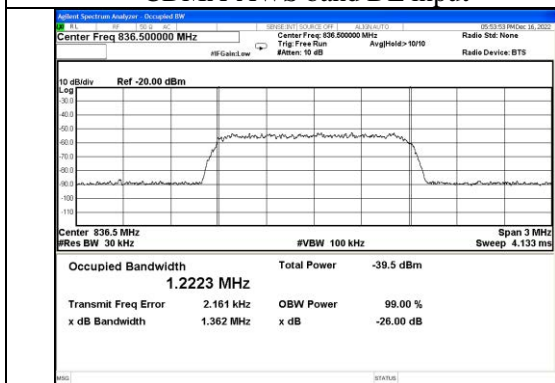

CDMA-Cellular band UL input

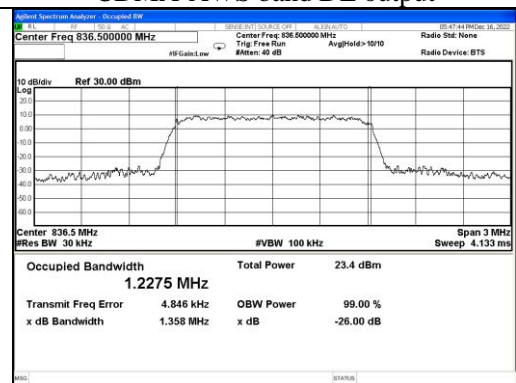

CDMA-Cellular band UL output

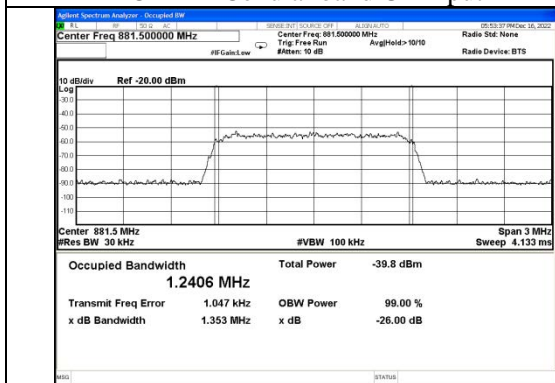

Cellular band DL input

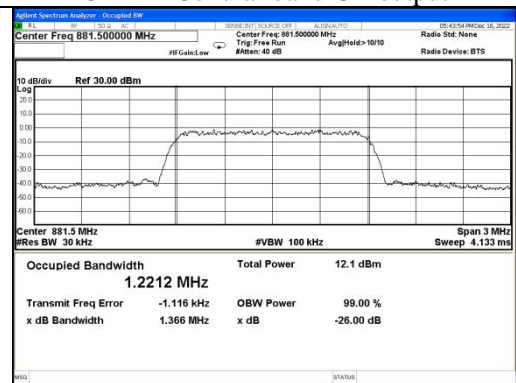

Cellular band DL output

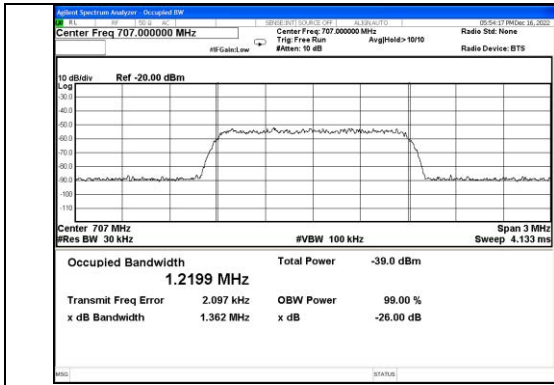

CDMA-Lower 700 band UL input

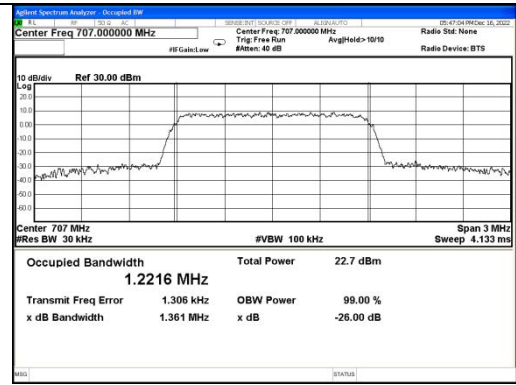

CDMA-Lower 700 band UL output

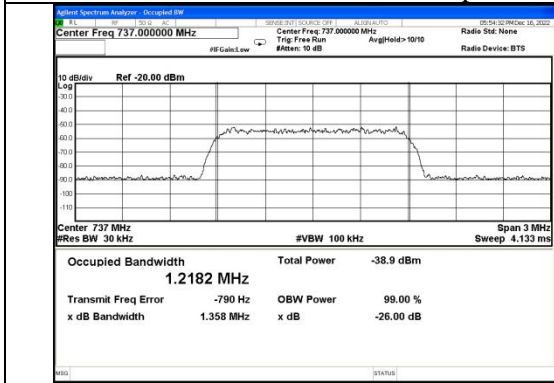

CDMA-Lower 700 band DL input

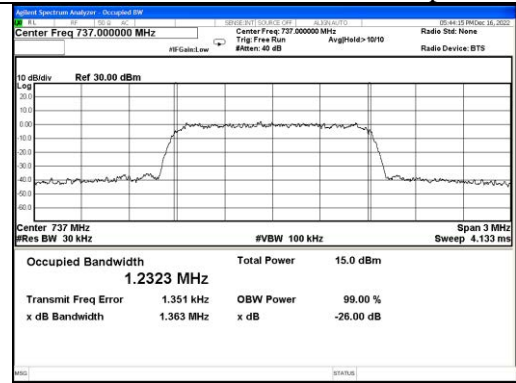

CDMA-Lower 700 band DL output

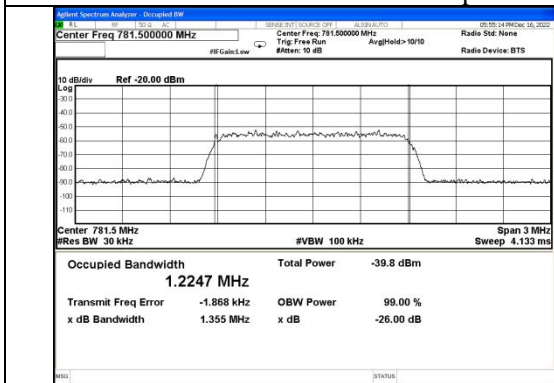

CDMA-Upper 700 band UL input

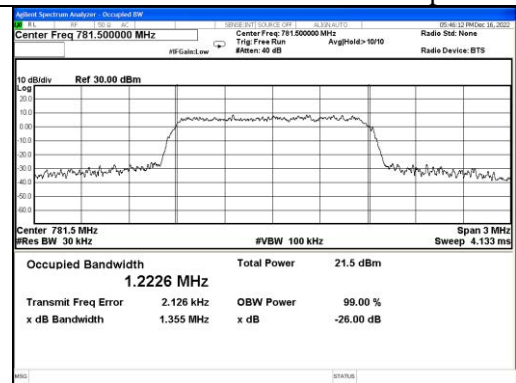

CDMA-Upper 700 band UL output

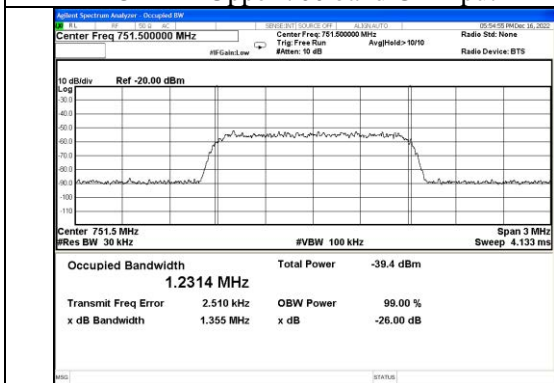

CDMA-Upper 700 band DL input

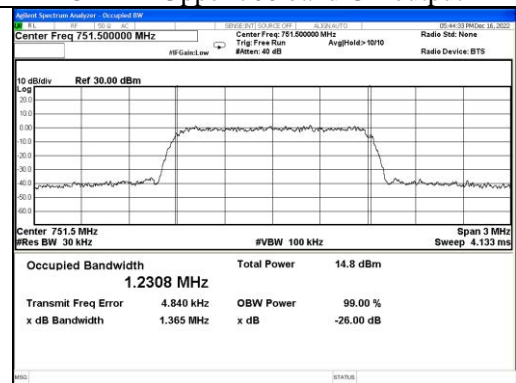

CDMA-Upper 700 band DL output

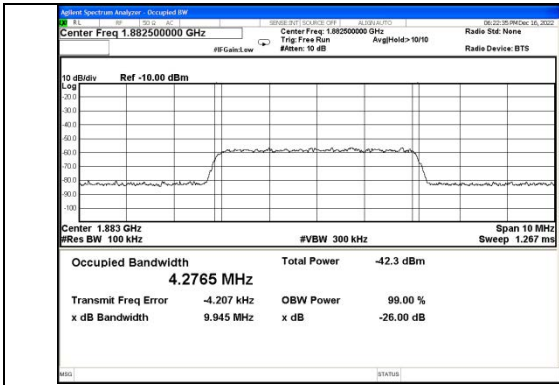

LTE-PCS band UL input

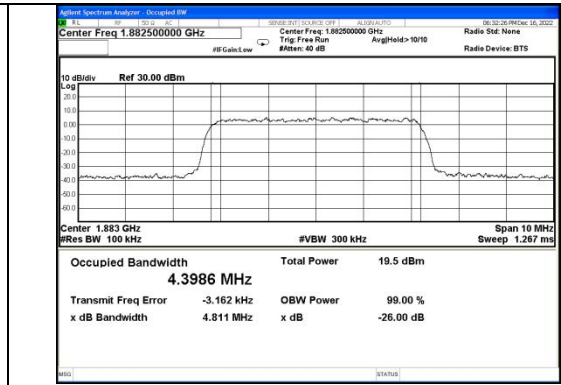

LTE-PCS band UL output

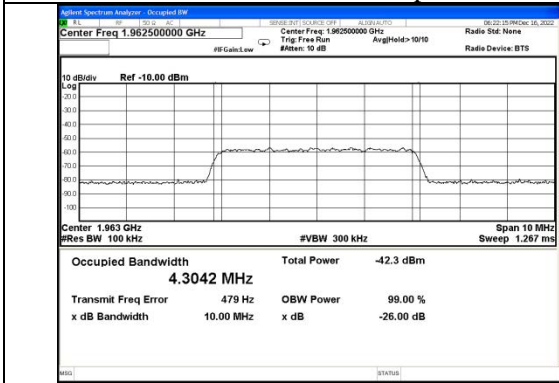

LTE-PCS band DL input

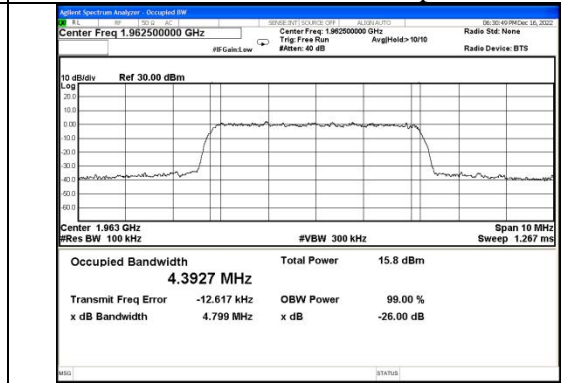

LTE-PCS band DL output

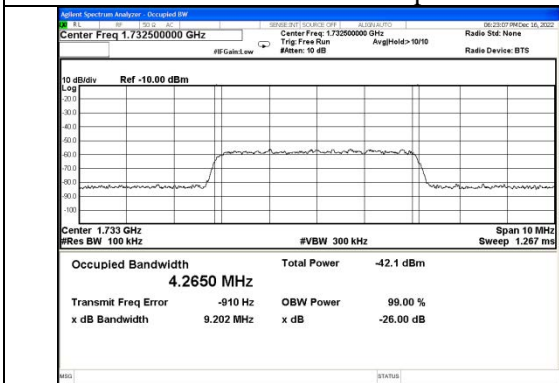

LTE-AWS band UL input

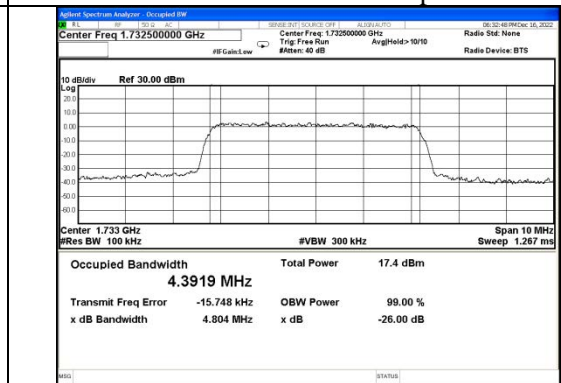

LTE-AWS band UL output

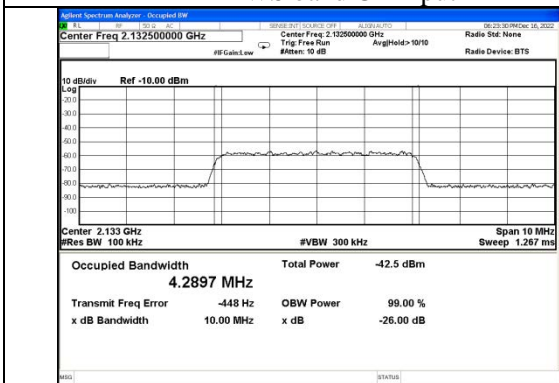

LTE-AWS band DL input

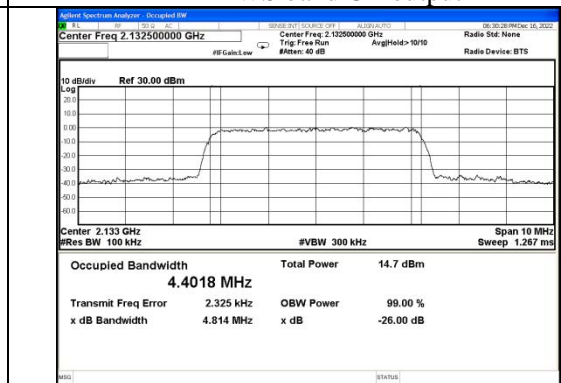

LTE-AWS band DL output

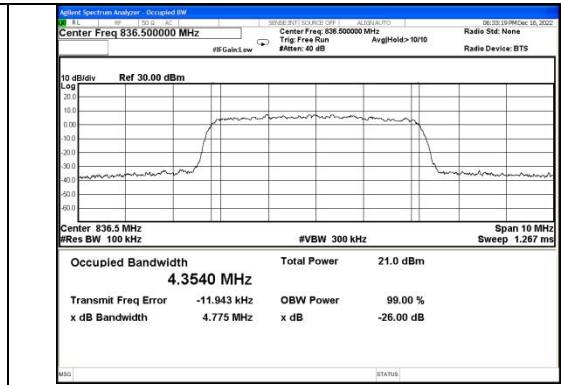
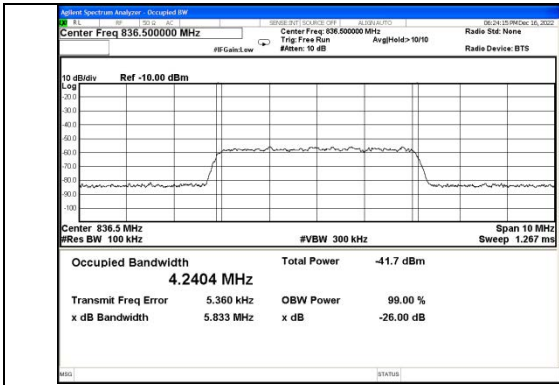

LTE-Cellular band UL input

LTE-Cellular band UL output

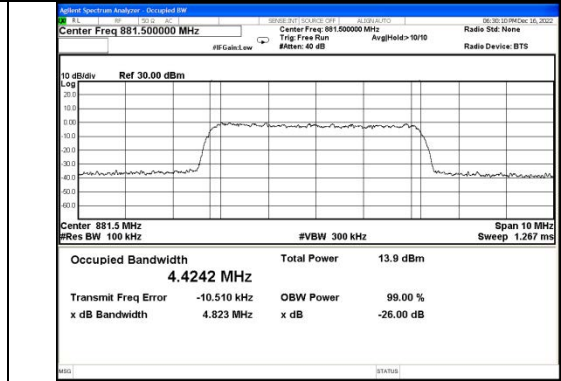
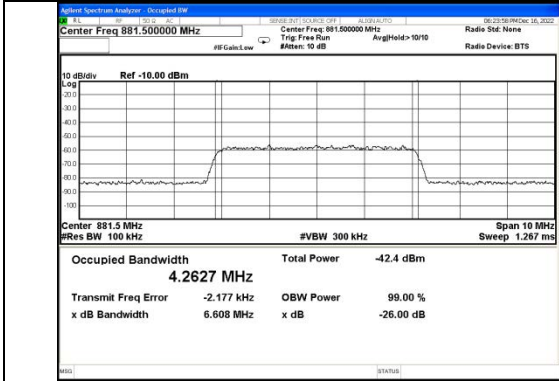

LTE-Cellular band DL input

LTE-Cellular band DL output

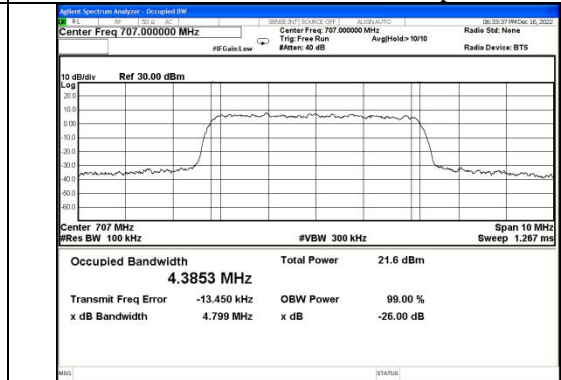
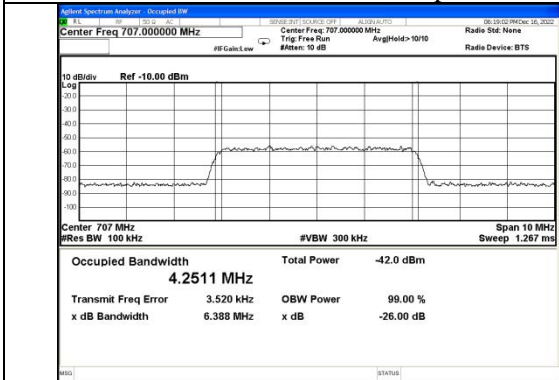

LTE-Lower 700 band UL input

LTE-Lower 700 band UL output

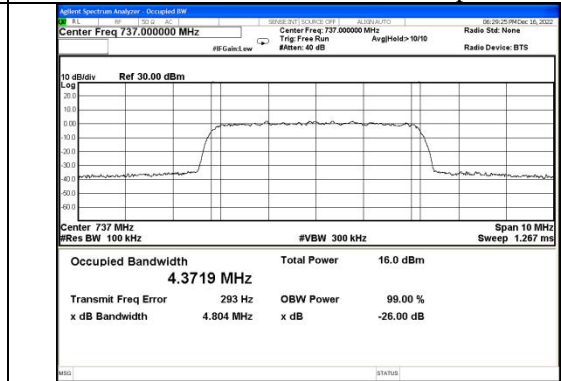
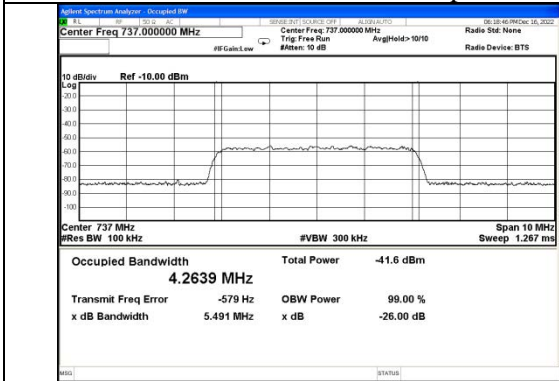

LTE-Lower 700 band DL input

LTE-Lower 700 band DL output



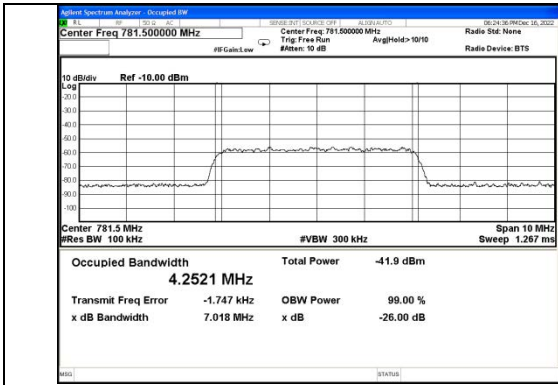

LTE-Upper 700MHz band UL input

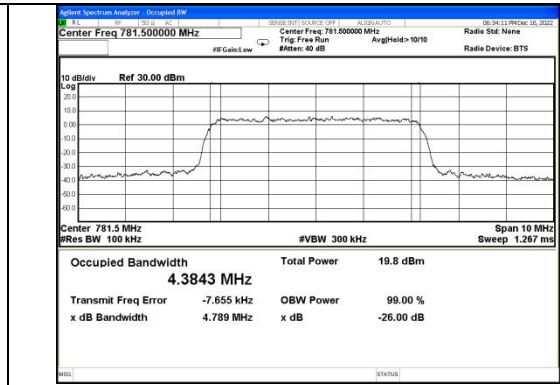

LTE-Upper 700MHz UL output

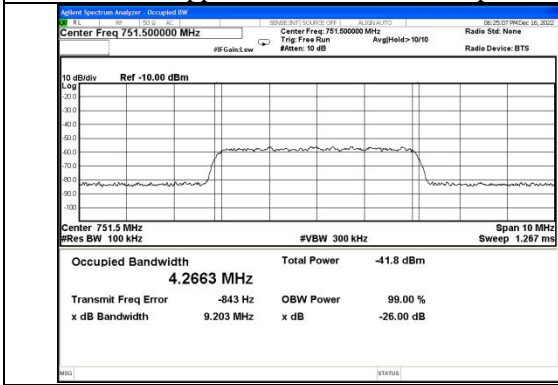

LTE-Upper 700 band DL input

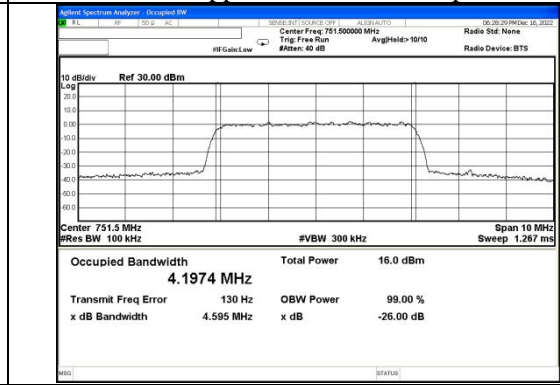

LTE-Upper 700 band DL output



## 6.11 Oscillation Detection and Mitigation

### Applicable Standard

According to §20.21(e)(8)(ii)(A) Anti-Oscillation:

1. Consumer boosters must be able to detect and mitigate (i.e., by automatic gain reduction or shut down), any oscillations in uplink and downlink bands. Oscillation detection and mitigation must occur automatically within 0.3 seconds in the uplink band and within 1 second in the downlink band. In cases where oscillation is detected, the booster must continue mitigation for at least one minute before restarting. After five such restarts, the booster must not resume operation until manually reset.
2. Use of two EUTs is permitted for this measurement, which can greatly reduce the test time required. One EUT shall operate in a normal mode, and the second EUT shall operate in a test mode that is capable of disabling the uplink inactivity function and/or allows a reduction to 5 seconds of the time between restarts.

The procedures in 7.11.3 and 7.11.4 do not apply for devices that operate only as direct-connection mobile boosters having gain of less than or equal to 15 dB.

### Test Procedure

Oscillation restart tests

According to section 7.11.2 of KDB 935210 D03 Signal Booster Measurement v04r04:

a) Connect the normal-operating mode EUT to the test equipment as shown in Figure 7 beginning with the spectrum analyzer on the uplink output (donor) port. Confirm that the RF coupled path is connected to the spectrum analyzer.

NOTE—The band-pass filter shall provide sufficient out-of-band rejection to prevent oscillations from occurring in bands not under test.

b) Spectrum analyzer settings:

- 1) Center frequency at the center of the band under test
- 2) Span equal or slightly exceeding the width of the band under test
- 3) Continuous sweep, max-hold
- 4)  $RBW \cong 1 \text{ MHz}$ ,  $VBW > 3 \text{ RBW}$

c) Decrease the variable attenuator until the spectrum analyzer displays a signal within the band under test. Using a marker, identify the approximate center frequency of this signal on the max-hold display, increase the attenuation by 10 dB, then reset the EUT (e.g., cycle ac/dc power).

d) Repeat 7.11.2c) twice to ensure that the center of the signal created by the booster remains within 250 kHz of the spectrum analyzer display center frequency. If the frequency of the signal is unstable, confirm that the spectrum analyzer display is centered between the frequency extremes observed. If the signal is wider than 1 MHz, ensure that the spectrum analyzer display is centered on the signal by increasing the RBW. Reset the EUT (e.g., cycle ac/dc power) after each oscillation event, if necessary. Set the spectrum analyzer sweep trigger level to just below the peak amplitude of the displayed EUT oscillation signal.

e) Set the spectrum analyzer to zero-span, with a sweep time of 5 seconds, and single-sweep with max-hold. The spectrum analyzer sweep trigger level in this and the subsequent steps shall be the level identified in 7.11.2d).

f) Decrease the variable attenuator until the spectrum analyzer sweep is triggered, increase the attenuation by 10 dB, then reset the EUT (e.g., cycle ac/dc power).

g) Reset the zero-span trigger of the spectrum analyzer, then repeat 7.11.2f) twice to ensure that the spectrum analyzer is reliably triggered, resetting the EUT (e.g., cycle ac/dc power) after each oscillation event if necessary.

h) Reset the zero-span sweep trigger of the spectrum analyzer, and reset the EUT (e.g., cycle ac/dc power).



- i) Force the EUT into oscillation by reducing the attenuation.
- j) Use the marker function of the spectrum analyzer to measure the time from the onset of oscillation until the EUT turns off, by setting Marker 1 on the leading edge of the oscillation signal and Marker 2 on the trailing edge. The spectrum analyzer sweep time may be adjusted to improve the time resolution of these cursors.
- k) Capture the spectrum analyzer zero-span trace for inclusion in the test report. Report the power level associated with the oscillation separately if it can't be displayed on the trace.
- l) Repeat 7.11.2b) to 7.11.2k) for all operational uplink and downlink bands.
- m) Set the spectrum analyzer zero-span sweep time for longer than 60 seconds, then measure the restart time for each operational uplink and downlink band.
- n) Replace the normal-operating mode EUT with the EUT that supports an anti-oscillation test mode.
- o) Set the spectrum analyzer zero-span time for a minimum of 120 seconds, and a single sweep.
- p) Manually trigger the spectrum analyzer zero-span sweep, and manually force the booster into oscillation as described in 7.11.2i).
- q) When the sweep is complete, place cursors between the first two oscillation detections, and save the plot for inclusion in the test report. The time between restarts must match the manufacturer's timing for the test mode, and there shall be no more than 5 restarts.
- r) Repeat 7.11.2m) to 7.11.2q) for all operational uplink and downlink bands.

oscillation mitigation or shutdown

According to section 7.11.3 of KDB 935210 D03 Signal Booster Measurement v04r04:

- a) Connect the normal-operating mode EUT to the test equipment as shown in Figure 8.
- b) Set the spectrum analyzer center frequency to the center of band under test, and use the following settings:
  - 1)  $RBW=30\text{ kHz}$ ,  $VBW \geq 3 \times RBW$ ,
  - 2) power averaging (rms) detector,
  - 3) trace averages  $\geq 100$ ,
  - 4) span  $\geq 120\%$  of operational band under test,
  - 5) number of sweep points  $\geq 2 \times \text{Span}/RBW$ .
- c) Configure the signal generator for AWGN operation with a 99% OBW of 4.1 MHz, tuned to the frequency of 2.5 MHz above the lower edge or below the upper edge of the operating band under test. Adjust the RF output level of the signal generator such that the measured power level of the AWGN signal at the output port of the booster is 30 dB less than the maximum power of the booster for the band under test. Affirm that the input signal is not obstructing the measurement of the strongest oscillation peak in the band, and is not included within the span in the measurement.
  - 1) Boosters with operating spectrum passbands of 10 MHz or less may use a CW signal source at the band edge rather than AWGN.
  - 2) For device passbands greater than 10 MHz, standard CMRS signal sources (i.e., CDMA, W-CDMA, LTE) may be used instead of AWGN at the band edge.
- d) Set the variable attenuator to a high attenuation setting such that the booster will operate at maximum gain when powered on. Reset the EUT (e.g., cycle ac/dc power). Allow the EUT to complete its boot-up process, to reach full operational gain, and to stabilize its operation.
- e) Set the variable attenuator such that the insertion loss for the center of the band under test (isolation) between the booster donor port and server port is 5 dB greater than the maximum gain, as recorded in the maximum gain test procedure (see 7.3), for the band under test.
- f) Verify the EUT shuts down, i.e., to mitigate the oscillations. If the booster does not shut down, measure and verify the peak oscillation level as follows.
  - 1) Allow the spectrum analyzer trace to stabilize.
  - 2) Place the marker at the highest oscillation level occurring within the span, and record its output level and frequency.
  - 3) Set the spectrum analyzer center frequency to the frequency with the highest oscillation signal level,

- and reduce the span such that the upper and lower adjacent oscillation peaks are within the span.
- 4) Use the Minimum Search Marker function to find the lowest output level that is within the span, and within the operational band under test, and record its output level and frequency.
  - 5) Affirm that the peak oscillation level measured in 7.11.3f2), does not exceed by 12.0 dB the minimal output level measured in 7.11.3f4). Record the measurement results of 7.11.3f2) and 7.11.3f4) in tabular format for inclusion in the test report.
  - 6) The procedure of 7.11.3f1) to 7.11.3f5) allows the spectrum analyzer trace to stabilize, and verification of shutdown or oscillation level measurement must occur within 300 seconds.20
  - g) Decrease the variable attenuator in 1 dB steps, and repeat step 7.11.3f) for each 1 dB step. Continue testing to the level when the insertion loss for the center of band under test (isolation) between the booster donor port and server port is 5 dB lower than the maximum gain (see 7.3).
  - h) Repeat 7.11.3a) to 7.11.3g) for all operational uplink and downlink bands.

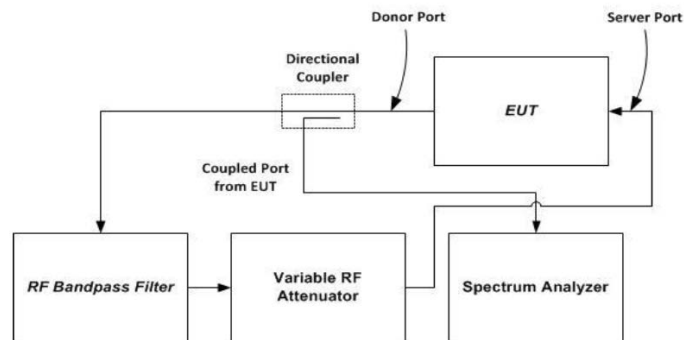

NOTE—This figure shows the test setup for uplink bands transmission path tests; i.e., signal flow is out from the donor port into the directional coupler. For downlink bands transmission path tests, the feedback signal flow path direction and equipment connections shall be reversed, i.e., signal flow is out from the server port into the directional coupler, and signal flow is into the donor port from the variable RF attenuator.

**Figure 7 – Oscillation detection (7.11.2) test setup**

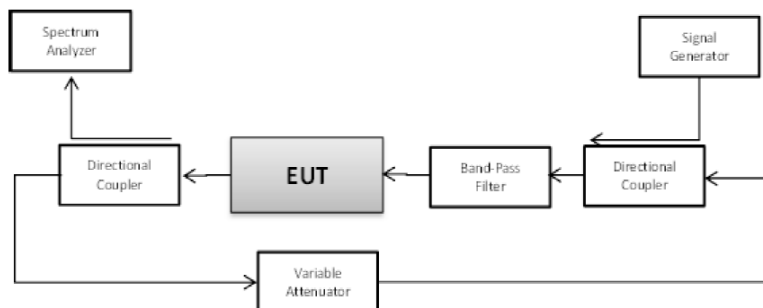

**Figure 8 – Oscillation mitigation/shutdown test setup**

**Test data**

Temperature	23.1℃	Humidity	54.2%
Test Engineer	Ling Zhu	Test Mode	Transmitting

Test results of detection time					
Operation Bands		Detection Time (s)	Limit (s)	Result	
Uplink	PCS	0.270	0.300	PASS	
	AWS	0.270	0.300	PASS	
	Cellular	0.270	0.300	PASS	
	Lower 700	0.270	0.300	PASS	
	Upper 700	0.270	0.300	PASS	
Downlink	PCS	0.270	1.000	PASS	
	AWS	0.270	1.000	PASS	
	Cellular	0.270	1.000	PASS	
	Lower 700	0.270	1.000	PASS	
	Upper 700	0.270	1.000	PASS	

Test results of detection time						
Operation Bands		Restarting Time(s)	Limit (s)	Restarting Counts	Limit	Result
Uplink	PCS	64.34	60	3	5	PASS
	AWS	65.12	60	3	5	PASS
	Cellular	64.52	60	3	5	PASS
	Lower 700	65.12	60	2	5	PASS
	Upper 700	65.21	60	2	5	PASS
Downlink	PCS	64.63	60	4	5	PASS
	AWS	64.25	60	3	5	PASS
	Cellular	65.12	60	3	5	PASS
	Lower 700	65.52	60	2	5	PASS
	Upper 700	64.52	60	3	5	PASS

**oscillation mitigation or shutdown:**

PCS Band	Uplink(1850-1915MHz)		
Signal Type	AWGN		
Isolation	Deffrence	Limit	Result
dB	dB	dB	
+5	8.73	<12	Pass
+4	9.12	<12	Pass
+3	9.25	<12	Pass
+2	10.12	<12	Pass
+1	10.20	<12	Pass
0	11.49	<12	Pass
-1	shutdown		

PCS Band	Downlink(1930-1995MHz)		
Signal Type	AWGN		
Isolation	Deffrence	Limit	Result
dB	dB	dB	
+5	7.42	<12	Pass
+4	7.35	<12	Pass
+3	7.87	<12	Pass
+2	8.99	<12	Pass
+1	10.23	<12	Pass
0	11.54	<12	Pass
-1	shutdown		

AWS band	Uplink(1710-1755MHz)		
Signal Type	AWGN		
Isolation	Deffrence	Limit	Result
dB	dB	dB	
+5	7.73	<12	Pass
+4	8.82	<12	Pass
+3	8.45	<12	Pass
+2	9.52	<12	Pass
+1	10.23	<12	Pass
0	11.22	<12	Pass
-1	shutdown		



AWS band	Downlink(2110-2155MHz)		
Signal Type	AWGN		
Isolation	Deffrence	Limit	Result
dB	dB	dB	
+5	6.52	<12	Pass
+4	6.45	<12	Pass
+3	6.52	<12	Pass
+2	6.52	<12	Pass
+1	6.52	<12	Pass
0	6.52	<12	Pass
-1	shutdown		

Cellular Band	Uplink(824-849MHz)		
Signal Type	AWGN		
Isolation	Deffrence	Limit	Result
dB	dB	dB	
+5	7.87	<12	Pass
+4	8.45	<12	Pass
+3	8.56	<12	Pass
+2	9.47	<12	Pass
+1	10.63	<12	Pass
0	11.23	<12	Pass
-1	shutdown		

Cellular Band	Downlink(869-894MHz)		
Signal Type	AWGN		
Isolation	Deffrence	Limit	Result
dB	dB	dB	
+5	7.45	<12	Pass
+4	8.26	<12	Pass
+3	8.15	<12	Pass
+2	9.36	<12	Pass
+1	10.52	<12	Pass
0	11.36	<12	Pass
-1	shutdown		



Lower700MHz band	Uplink(698-716MHz)		
Signal Type	AWGN		
Isolation	Deffrence	Limit	Result
dB	dB	dB	
+5	8.12	<12	Pass
+4	9.12	<12	Pass
+3	9.12	<12	Pass
+2	9.32	<12	Pass
+1	10.32	<12	Pass
0	11.25	<12	Pass
-1	shutdown		

Lower700MHz band	Downlink(728-746MHz)		
Signal Type	AWGN		
Isolation	Deffrence	Limit	Result
dB	dB	dB	
+5	8.15	<12	Pass
+4	9.32	<12	Pass
+3	9.27	<12	Pass
+2	9.46	<12	Pass
+1	11.03	<12	Pass
0	11.24	<12	Pass
-1	shutdown		

Upper 700Mhz Band	Uplink(776-787MHz)		
Signal Type	AWGN		
Isolation	Deffrence	Limit	Result
dB	dB	dB	
+5	8.43	<12	Pass
+4	9.52	<12	Pass
+3	10.01	<12	Pass
+2	10.32	<12	Pass
+1	11.32	<12	Pass
0	11.41	<12	Pass
-1	shutdown		





Upper 700Mhz Band	Downlink(746-757MHz)		
Signal Type	AWGN		
Isolation	Deffrence	Limit	Result
dB	dB	dB	
+5	9.12	<12	Pass
+4	9.21	<12	Pass
+3	10.56	<12	Pass
+2	10.84	<12	Pass
+1	11.32	<12	Pass
0	11.45	<12	Pass
-1	shutdown		

## 7. RADIATION SPURIOUS EMISSION

### Applicable Standard

According to §2.1053 Measurements required: Field strength of spurious radiation.

The power of any emission outside a licensee's frequency block shall be attenuated below the transmitter power (P) by at least  $43 + 10 \log_{10}(P)$  dB.

So the Conducted emissions limit = -13 dBm

### Test Procedure

According to section 7.12 of KDB 935210 D03 Signal Booster Measurement v04r04:

This procedure is intended to satisfy the requirements specified in Section 2.1053. The applicable limits are those specified for mobile station emissions in the rule part appropriate to the band of operation (see Appendix A).

Separate compliance requirements are applicable for any digital device circuitry that controls additional functions or capabilities and that is not used only to enable operation of the transmitter in a booster device [i.e., Section 15.3(k) digital device definition]. Separate compliance requirements are applicable for any receiver components/functions that tune within 30 MHz to 960 MHz contained in booster devices [Section 15.101(b)].

- Place the EUT on an OATS or semi-anechoic chamber turntable 3 m from the receiving antenna.
- Connect the EUT to the test equipment as shown in Figure 10 beginning with the uplink output (donor) port.
- Set the signal generator to produce a CW signal with the frequency set to the center of the operational band under test, and the power level set at PIN as determined from measurement results per 7.2.
- Measure the radiated spurious emissions from the EUT from the lowest to the highest frequencies as specified in Section 2.1057. Maximize the radiated emissions by using the procedures described in ANSI C63.26.
- Capture the peak emissions plots using a peak detector with Max-Hold for inclusion in the test report. Tabular data is acceptable in lieu of spectrum analyzer plots.
- Repeat 7.12c) through 7.12e) for all uplink and downlink operational bands.

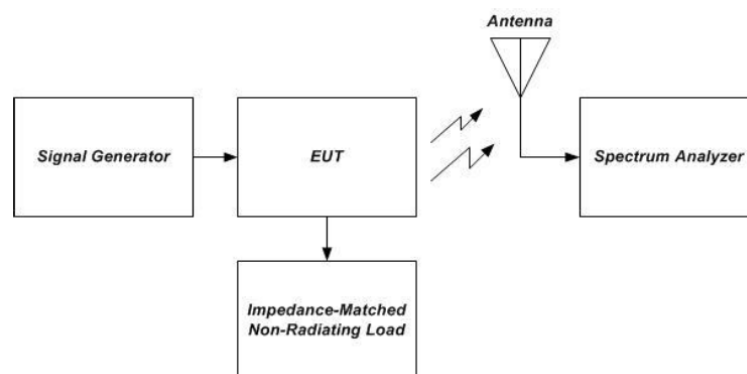

Figure 10 – Radiated spurious emissions test and instrumentation setup

**Test Data**

Temperature	23.1°C	Humidity	54.2%
Test Engineer	Ling Zhu	Test Mode	Transmitting

## Uplink, Test Frequency 1882.5MHz

Frequency (MHz)	PMea (dBm)	Pcl (dB)	Diatance	Ga Antenna Gain(dB)	Peak EIRP (dBm)	Limit (dBm)	Margin	Polarization
834.29	-49.21	2.32	3.00	10.03	-41.50	-19.00	22.50	H
3765.23	-48.12	6.19	3.00	11.41	-42.90	-19.00	23.90	H
834.29	-44.01	2.32	3.00	10.03	-36.30	-19.00	17.30	V
3765.23	-41.32	6.19	3.00	11.41	-36.10	-19.00	17.10	V

## Uplink, Test Frequency 1732.5MHz

Frequency (MHz)	PMea (dBm)	Pcl (dB)	Diatance	Ga Antenna Gain(dB)	Peak EIRP (dBm)	Limit (dBm)	Margin	Polarization
776.24	-48.52	2.63	3.00	7.84	-43.31	-19.00	24.31	H
3465.23	-52.31	5.94	3.00	10.86	-47.39	-19.00	28.39	H
776.24	-44.62	2.63	3.00	7.84	-39.41	-19.00	20.41	V
3465.23	-45.32	5.94	3.00	10.86	-40.40	-19.00	21.40	V

## Uplink, Test Frequency 836.5MHz

Frequency (MHz)	PMea (dBm)	Pcl (dB)	Diatance	Ga Antenna Gain(dB)	Peak ERP (dBm)	Limit (dBm)	Margin	Polarization
634.77	-50.32	1.98	3.00	11.12	-41.18	-19.00	22.18	H
1670.36	-48.62	4.45	3.00	12.02	-41.05	-19.00	22.05	H
634.77	-44.62	1.98	3.00	11.12	-35.48	-19.00	16.48	V
1670.36	-44.32	4.45	3.00	12.02	-36.75	-19.00	17.75	V

## Uplink, Test Frequency 707.5MHz

Frequency (MHz)	PMea (dBm)	Pcl (dB)	Diatance	Ga Antenna Gain(dB)	Peak ERP (dBm)	Limit (dBm)	Margin	Polarization
823.19	-46.52	1.75	3.00	10.44	-37.83	-19.00	18.83	H
1415.38	-47.12	4.66	3.00	12.33	-39.45	-19.00	20.45	H
823.19	-45.32	1.75	3.00	10.44	-36.63	-19.00	17.63	V
1415.38	-44.32	4.66	3.00	12.33	-36.65	-19.00	17.65	V



## Uplink, Test Frequency 782MHz

Frequency (MHz)	PMea (dBm)	Pcl (dB)	Diatance	Ga Antenna Gain(dB)	Peak ERP (dBm)	Limit (dBm)	Margin	Polarization
588.24	-46.52	1.99	3.00	11.12	-37.39	-19.00	18.39	H
1564.21	-48.63	4.85	3.00	12.02	-41.46	-19.00	22.46	H
588.24	-43.52	1.99	3.00	11.12	-34.39	-19.00	15.39	V
1564.21	-42.95	4.85	3.00	12.02	-35.78	-19.00	16.78	V

## Downlink, Test Frequency1962.5MHz

Frequency (MHz)	PMea (dBm)	Pcl (dB)	Diatance	Ga Antenna Gain(dB)	Peak EIRP (dBm)	Limit (dBm)	Margin	Polarization
833.52	-48.51	2.36	3.00	9.62	-41.25	-19.00	22.25	H
3925.664	-49.12	6.24	3.00	11.46	-43.90	-19.00	24.90	H
833.52	-47.12	2.36	3.00	9.62	-39.86	-19.00	20.86	V
3925.664	-42.63	6.24	3.00	11.46	-37.41	-19.00	18.41	V

## Downlink, Test Frequency2132.5MHz

Frequency (MHz)	PMea (dBm)	Pcl (dB)	Diatance	Ga Antenna Gain(dB)	Peak EIRP (dBm)	Limit (dBm)	Margin	Polarization
741.88	-53.52	2.65	3.00	9.9	-46.27	-19.00	27.27	H
4265.21	-54.21	5.95	3.00	10.91	-49.25	-19.00	30.25	H
741.88	-45.21	2.65	3.00	9.9	-37.96	-19.00	18.96	V
4265.21	-44.52	5.95	3.00	10.91	-39.56	-19.00	20.56	V

## Downlink, Test Frequency 881.5MHz

Frequency (MHz)	PMea (dBm)	Pcl (dB)	Diatance	Ga Antenna Gain(dB)	Peak ERP (dBm)	Limit (dBm)	Margin	Polarization
569.14	-46.52	2.95	3.00	9.98	-39.49	-19.00	20.49	H
1763.28	-47.52	6.63	3.00	11.66	-42.49	-19.00	23.49	H
569.14	-44.63	2.95	3.00	9.98	-37.60	-19.00	18.60	V
1763.28	-43.52	6.63	3.00	11.66	-38.49	-19.00	19.49	V

## Downlink, Test Frequency 737MHz

Frequency (MHz)	PMea (dBm)	Pcl (dB)	Diatance	Ga Antenna Gain(dB)	Peak ERP (dBm)	Limit (dBm)	Margin	Polarization
596.28	-50.35	1.77	3.00	10.45	-41.67	-19.00	22.67	H
1474.38	-46.52	5.69	3.00	12.36	-39.85	-19.00	20.85	H
596.28	-45.21	1.77	3.00	10.45	-36.53	-19.00	17.53	V
1474.38	-42.32	5.69	3.00	12.36	-35.65	-19.00	16.65	V



Downlink, Test Frequency 751.5MHz

Frequency (MHz)	PMea (dBm)	Pcl (dB)	Diatance	Ga Antenna Gain(dB)	Peak ERP (dBm)	Limit (dBm)	Margin	Polarization
469.25	-51.52	2.12	3.00	9.98	-43.66	-19.00	24.66	H
1503.68	-46.12	5.93	3.00	11.66	-40.39	-19.00	21.39	H
469.25	-45.62	2.12	3.00	9.98	-37.76	-19.00	18.76	V
1503.68	-40.57	5.93	3.00	11.66	-34.84	-19.00	15.84	V

Remark:

1. We were not recorded other points as values lower than limits.
2.  $Peak(EIRP) = P_{Mea} - P_{cl} + G_a$
3.  $Margin = EIRP - Limit$
4. For Outdoor Antenna(Yagi antenna),Indoor Antenna(Omni Antenna); Outdoor Antenna(Panel antenna),Indoor Antenna(Panel Antenna) were estimated ,the report recorded the worst result of Outdoor Antenna (Yagi antenna),Indoor Antenna(Panel Antenna).



## **8. TEST SETUP PHOTOGRAPHS OF EUT**

Please refer to separated files for Test Setup Photos of the EUT.

## **9. EXTERIOR PHOTOGRAPHS OF THE EUT**

Please refer to separated files for External Photos of the EUT.

## **10. INTERIOR PHOTOGRAPHS OF THE EUT**

Please refer to separated files for Internal Photos of the EUT.

-----THE END OF TEST REPORT-----