

RADIO TEST REPORT

FCC 47 CFR PART 15 SUBPART C

Test Standard	FCC Part 15.247
Brand name	WattBox
Product name	WattBox IP Power Strip & Surge Protector Wi-Fi 2 Individually Controlled Outlets
Model No.	WB-250-IPW-2
Test Result	Pass
Statements of Conformity	Determination of compliance is based on the results of the compliance measurement, not taking into account measurement instrumentation uncertainty.

The test Result was tested by Compliance Certification Services Inc. The test data, data evaluation, test procedures, and equipment configurations shown in this report were given in ANSI C63.10: 2013 and compliance standards.

The test results of this report relate only to the tested sample (EUT) identified in this report.

The test Report of full or partial shall not copy. Without written approval of Compliance Certification Services Inc. (Wugu Laboratory).

Approved by:

Tested by:

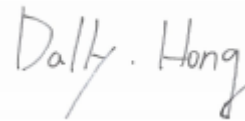

Kevin Tsai
Deputy Manager

Dally Hong
Engineer

Unless otherwise stated the results shown in this test report refer only to the sample(s) tested and such sample(s) are retained for 90 days only.
除非另有說明，此報告結果僅對測試之樣品負責，同時此樣品僅保留90天。本報告未經本公司書面許可，不可部分複製。

This document is issued by the Company subject to its General Conditions of Service printed overleaf, available on request or accessible at www.sgs.com/terms_and_conditions.htm and for electronic format documents, subject to Terms and Conditions for Electronic Documents at www.sgs.com/terms_e-document.htm. Attention is drawn to the limitation of liability, indemnification and jurisdiction issues defined therein. Any holder of this document is advised that information contained hereon reflects the Company's findings at the time of its intervention only and within the limits of Client's instructions, if any. The Company's sole responsibility is to its Client and this document does not exonerate parties to a transaction from exercising all their rights and obligations under the transaction documents. This document cannot be reproduced except in full, without prior written approval of the Company. Any unauthorized alteration, forgery or falsification of the content or appearance of this document is unlawful and offenders may be prosecuted to the fullest extent of the law.



Report No.: T190513D01-RP

Page: 2 / 86

Rev.: 01

Revision History

Rev.	Issue Date	Revisions	Effect Page	Revised By
00	July 16, 2019	Initial Issue	ALL	Allison Chen
01	July 24, 2019	See the following Note Rev.(01)	P.1, P.4, P.7-8, P.15-16, P.61-62, A-1, A-3~4	Allison Chen

Rev.(01)

1. *Modify product name.*
2. *Modify data of test in section 1.1 and instrument calibration in section 1.6.*
3. *Modify test data in section 5.1 for AC power line conducted emission and section 5.6 for spurious emission below 1GHz.*
4. *Modify setup photo for radiation (below 1GHz) and conduction setup photo.*

Table of contents

1.	GENERAL INFORMATION.....	4
1.1	EUT INFORMATION.....	4
1.2	EUT CHANNEL INFORMATION.....	5
1.3	ANTENNA INFORMATION.....	5
1.4	MEASUREMENT UNCERTAINTY	6
1.5	FACILITIES AND TEST LOCATION.....	7
1.6	INSTRUMENT CALIBRATION	7
1.7	SUPPORT AND EUT ACCESSORIES EQUIPMENT	9
1.8	TEST METHODOLOGY AND APPLIED STANDARDS.....	9
2.	TEST SUMMERY.....	10
3.	DESCRIPTION OF TEST MODES.....	11
3.1	THE WORST MODE OF OPERATING CONDITION	11
3.2	THE WORST MODE OF MEASUREMENT.....	12
4.	EUT DUTY CYCLE	13
5.	TEST RESULT.....	14
5.1	AC POWER LINE CONDUCTED EMISSION.....	14
5.2	6dB BANDWIDTH AND OCCUPIED BANDWIDTH(99%).....	17
5.3	OUTPUT POWER MEASUREMENT	27
5.4	POWER SPECTRAL DENSITY	30
5.5	CONDUCTED BANDEDGE AND SPURIOUS EMISSION.....	36
5.6	RADIATION BANDEDGE AND SPURIOUS EMISSION.....	49
	APPENDIX-A TEST PHOTO.....	A-1
	APPENDIX 1 - PHOTOGRAPHS OF EUT	

1. GENERAL INFORMATION

1.1 EUT INFORMATION

Applicant	Wirepath Home Systems, LLC, DBA SnapAV 1800 Continental Blvd Suite 300 Charlotte, North Carolina 28273 USA		
Manufacturer	Emplus Technologies, Inc. NO. 42, SEC. 1, MINSHENG NORTH RD, GUISHAN DISTRICT, TAOYUAN CITY 33391, TAIWAN		
Equipment	WattBox IP Power Strip & Surge Protector Wi-Fi 2 Individually Controlled Outlets		
Model Name	WB-250-IPW-2		
Model Discrepancy	N/A		
Trade Name	WattBox		
Received Date	May 13, 2019		
Date of Test	May 22 ~ July 23, 2019		
Output Power(W)	Mode	Output Power (W)	
	IEEE 802.11b Mode	0.1396	
	IEEE 802.11g Mode	0.2415	
	IEEE 802.11n HT20 Mode	0.2449	
	IEEE 802.11n HT40 Mode	0.2173	
Power Supply	I/P: 120VAC, 12A, 60Hz O/P: 120VAC, 12A, 60Hz, 1440W		

Report No.: T190513D01-RP

1.2 EUT CHANNEL INFORMATION

Frequency Range	802.11b/g/n HT20: 2412MHz ~ 2462MHz 802.11n HT40: 2422MHz ~ 2452MHz
Modulation Type	1. IEEE 802.11b Mode: DSSS(DBPSK/DQPSK/CCK) 2. IEEE 802.11g Mode: OFDM (BPSK/QPSK/16QAM/64QAM) 3. IEEE 802.11n HT20 Mode : OFDM (BPSK/QPSK/16QAM/64QAM) 4. IEEE 802.11n HT40 Mode : OFDM (BPSK/QPSK/16QAM/64QAM)
Number of channels	1. IEEE 802.11b Mode: 11 Channels 2. IEEE 802.11g Mode: 11 Channels 3. IEEE 802.11n HT20 Mode : 11 Channels 4. IEEE 802.11n HT40 Mode : 7 Channels

Remark:

Refer as ANSI C63.10: 2013 clause 5.6.1 Table 4 for test channels

Number of frequencies to be tested		
Frequency range in which device operates	Number of frequencies	Location in frequency range of operation
<input type="checkbox"/> 1 MHz or less	1	Middle
<input type="checkbox"/> 1 MHz to 10 MHz	2	1 near top and 1 near bottom
<input checked="" type="checkbox"/> More than 10 MHz	3	1 near top, 1 near middle, and 1 near bottom

1.3 ANTENNA INFORMATION

Antenna Type	<input checked="" type="checkbox"/> PIFA <input type="checkbox"/> PCB <input type="checkbox"/> Dipole <input type="checkbox"/> Coils
Antenna Gain	Gain: 1.46dBi
Antenna Connector	N/A

1.4 MEASUREMENT UNCERTAINTY

PARAMETER	UNCERTAINTY
AC Powerline Conducted Emission	+/- 1.2575
Emission bandwidth, 20dB bandwidth	+/- 0.0014
RF output power, conducted	+/- 1.14
Power density, conducted	+/- 1.40
3M Semi Anechoic Chamber / 30M~200M	+/- 4.12
3M Semi Anechoic Chamber / 200M~1000M	+/- 4.68
3M Semi Anechoic Chamber / 1G~8G	+/- 5.18
3M Semi Anechoic Chamber / 8G~18G	+/- 5.47
3M Semi Anechoic Chamber / 18G~26G	+/- 3.81
3M Semi Anechoic Chamber / 26G~40G	+/- 3.87

Remark:

- 1. This uncertainty represents an expanded uncertainty expressed at approximately the 95% confidence level using a coverage factor of $k=2$*
- 2. ISO/IEC 17025 requires that an estimate of the measurement uncertainties associated with the emissions test results be included in the report.*

Report No.: T190513D01-RP

1.5 FACILITIES AND TEST LOCATION

All measurement facilities used to collect the measurement data are located at No.11, Wugong 6th Rd., Wugu Dist., New Taipei City 24891, Taiwan. (R.O.C.)

Test site	Test Engineer	Remark
AC Conduction Room	Dally Hong	-
Radiation	Dally Hong	-
RF Conducted	Dally Hong	-

Remark: The sites are constructed in conformance with the requirements of ANSI C63.7, ANSI C63.4 and CISPR Publication 22.

1.6 INSTRUMENT CALIBRATION

AC Conduction Test Room					
Name of Equipment	Manufacturer	Model	Serial Number	Calibration Date	Calibration Due
CABLE	EMCI	CFD300-NL	CERF	06/27/2019	06/26/2020
EMI Test Receiver	R&S	ESCI	100064	07/24/2018	07/23/2019
LISN	SCHWARZBECK	NSLK 8127	8127-541	01/31/2019	01/30/2020
LISN	SCHAFFNER	NNB 41	03/10013	02/13/2019	02/12/2020
Software	EZ-EMC(CCS-3A1-CE)				

For Section 5.6: Radiation bandedge and spruous emission

Wugu 966 Chamber A					
Name of Equipment	Manufacturer	Model	Serial Number	Calibration Date	Calibration Due
Band Reject Filters	MICRO TRONICS	BRM 50702	120	02/26/2019	02/25/2020
Bilog Antenna	Sunol Sciences	JB1	A052609	03/06/2019	03/05/2020
Cable	HUBER SUHNER	SUCOFLEX 104PEA	25157	02/26/2019	02/25/2020
Cable	HUBER SUHNER	SUCOFLEX 104PEA	20995	02/26/2019	02/25/2020
Digital Thermo-Hygro Meter	WISEWIND	1206	D07	01/30/2019	01/29/2020
double Ridged Guide Horn Antenna	ETC	MCTD 1209	DRH13M02003	08/20/2018	08/19/2019
Loop Ant	COM-POWER	AL-130	121051	03/22/2019	03/21/2020
Pre-Amplifier	EMEC	EM330	060609	02/26/2019	02/25/2020
Pre-Amplifier	HP	8449B	3008A00965	02/26/2019	02/25/2020
PSA Series Spectrum Analyzer	Agilent	E4446A	MY46180323	05/29/2019	05/28/2020
Antenna Tower	CCS	CC-A-1F	N/A	N.C.R	N.C.R
Controller	CCS	CC-C-1F	N/A	N.C.R	N.C.R
Turn Table	CCS	CC-T-1F	N/A	N.C.R	N.C.R
Software	e3 6.11-20180413				

Report No.: T190513D01-RP

For Section 4: EUT Duty Cycle

Wugu 966 Chamber A					
Name of Equipment	Manufacturer	Model	Serial Number	Calibration Date	Calibration Due
Band Reject Filters	MICRO TRONICS	BRM 50702	120	02/26/2019	02/25/2020
Bilog Antenna	Sunol Sciences	JB3	A030105	07/13/2018	07/12/2019
Cable	HUBER SUHNER	SUCOFLEX 104PEA	25157	02/26/2019	02/25/2020
Cable	HUBER SUHNER	SUCOFLEX 104PEA	20995	02/26/2019	02/25/2020
Digital Thermo-Hygro Meter	WISEWIND	1206	D07	01/30/2019	01/29/2020
double Ridged Guide Horn Antenna	ETC	MCTD 1209	DRH13M02003	08/20/2018	08/19/2019
Loop Ant	COM-POWER	AL-130	121051	03/22/2019	03/21/2020
Pre-Amplifier	EMEC	EM330	060609	02/26/2019	02/25/2020
Pre-Amplifier	HP	8449B	3008A00965	02/26/2019	02/25/2020
PSA Series Spectrum Analyzer	Agilent	E4446A	MY46180323	05/30/2018	05/29/2019
Antenna Tower	CCS	CC-A-1F	N/A	N.C.R	N.C.R
Controller	CCS	CC-C-1F	N/A	N.C.R	N.C.R
Turn Table	CCS	CC-T-1F	N/A	N.C.R	N.C.R
Software	e3 6.11-20180413				

Conducted Test Site					
Name of Equipment	Manufacturer	Model	Serial Number	Calibration Date	Calibration Due
Power Meter	Anritsu	ML2495A	1149001	02/12/2019	02/11/2020
Power Seneor	Anritsu	MA2491A	030982	02/12/2019	02/11/2020
Signal Analyzer	R&S	FSV 40	101073	09/27/2018	09/26/2019
Software	N/A				

Remark:

1. Each piece of equipment is scheduled for calibration once a year.
2. N.C.R. = No Calibration Request.



Report No.: T190513D01-RP

Page: 9 / 86

Rev.: 01

1.7 SUPPORT AND EUT ACCESSORIES EQUIPMENT

EUT Accessories Equipment					
No.	Equipment	Brand	Model	Series No.	FCC ID
	N/A				

Support Equipment					
No.	Equipment	Brand	Model	Series No.	FCC ID
1	NB(L)	Toshiba	PORTEGE R30-A	N/A	PD97260H

1.8 TEST METHODOLOGY AND APPLIED STANDARDS

The test methodology, setups and results comply with all requirements in accordance with ANSI C63.10:2013, FCC Part 2, FCC Part 15.247, KDB 558074 D01.

2. TEST SUMMERY

FCC Standard Section	Report Section	Test Item	Result
15.203	1.3	Antenna Requirement	Pass
15.207(a)	5.1	AC Conducted Emission	Pass
15.247(a)(2)	5.2	6 dB Bandwidth	Pass
2.1049	5.2	Occupied Bandwidth (99%)	Pass
15.247(b)(3)	5.3	Output Power Measurement	Pass
15.247(e)	5.4	Power Spectral Density	Pass
15.247(d)	5.5	Conducted Band Edge	Pass
15.247(d)	5.5	Conducted Spurious Emission	Pass
15.247(d)	5.6	Radiation Band Edge	Pass
15.247(d)	5.6	Radiation Spurious Emission	Pass

Report No.: T190513D01-RP

3. DESCRIPTION OF TEST MODES

3.1 THE WORST MODE OF OPERATING CONDITION

<p>Operation mode</p>	<p>IEEE 802.11b Mode: 1Mbps IEEE 802.11g Mode: 6Mbps IEEE 802.11n HT20 Mode: MCS0 IEEE 802.11n HT40 Mode: MCS0</p>
<p>Test Channel Frequencies</p>	<p>IEEE 802.11b Mode : 1. Lowest Channel : 2412MHz 2. Middle Channel : 2437MHz 3. Highest Channel : 2462MHz IEEE 802.11g Mode : 1. Lowest Channel : 2412MHz 2. Middle Channel : 2437MHz 3. Highest Channel : 2462MHz IEEE 802.11n HT20 Mode : 1. Lowest Channel : 2412MHz 2. Middle Channel : 2437MHz 3. Highest Channel : 2462MHz IEEE 802.11n HT40 Mode : 1. Lowest Channel : 2422MHz 2. Middle Channel : 2437MHz 3. Highest Channel : 2452MHz</p>
<p>Operation Transmitter</p>	<p>IEEE 802.11b Mode :1T1R IEEE 802.11g Mode : 1T1R IEEE 802.11n HT20 Mode : 1T1R IEEE 802.11n HT40 Mode : 1T1R</p>

Remark:

1. EUT pre-scanned data rate of output power for each mode, the worst data rate were recorded in this report.

Report No.: T190513D01-RP

3.2 THE WORST MODE OF MEASUREMENT

AC Power Line Conducted Emission	
Test Condition	AC Power line conducted emission for line and neutral
Power supply Mode	Mode 1:EUT power by AC 120V
Worst Mode	<input checked="" type="checkbox"/> Mode 1 <input type="checkbox"/> Mode 2 <input type="checkbox"/> Mode 3 <input type="checkbox"/> Mode 4

Radiated Emission Measurement Above 1G	
Test Condition	Band edge, Emission for Unwanted and Fundamental
Power supply Mode	Mode 1:EUT power by AC 120V
Worst Mode	<input checked="" type="checkbox"/> Mode 1 <input type="checkbox"/> Mode 2 <input type="checkbox"/> Mode 3 <input type="checkbox"/> Mode 4
Worst Position	<input type="checkbox"/> Placed in fixed position. <input checked="" type="checkbox"/> Placed in fixed position at X-Plane (E2-Plane) <input type="checkbox"/> Placed in fixed position at Y-Plane (E1-Plane) <input type="checkbox"/> Placed in fixed position at Z-Plane (H-Plane)
Worst Polarity	<input type="checkbox"/> Horizontal <input checked="" type="checkbox"/> Vertical

Radiated Emission Measurement Below 1G	
Test Condition	Radiated Emission Below 1G
Power supply Mode	Mode 1:EUT power by AC 120V
Worst Mode	<input checked="" type="checkbox"/> Mode 1 <input type="checkbox"/> Mode 2 <input type="checkbox"/> Mode 3 <input type="checkbox"/> Mode 4

Remark:

1. The worst mode was record in this test report.
2. EUT pre-scanned in three axis ,X,Y, Z and two polarity, Horizontal and Vertical for radiated measurement. The worst case(Z-Plane and Vertical) were recorded in this report
3. AC power line conducted emission and for below 1G radiation emission were performed the EUT transmit at the highest output power channel as worse case.

Report No.: T190513D01-RP

4. EUT DUTY CYCLE

Duty Cycle			
Configuration	TX ON (ms)	TX ALL (ms)	Duty Cycle (%)
802.11b	8.4170	8.4500	99.61%
802.11g	1.3830	1.5080	91.71%
802.11n HT20	1.3000	1.3700	94.89%
802.11n HT40	0.6133	0.7433	82.51%

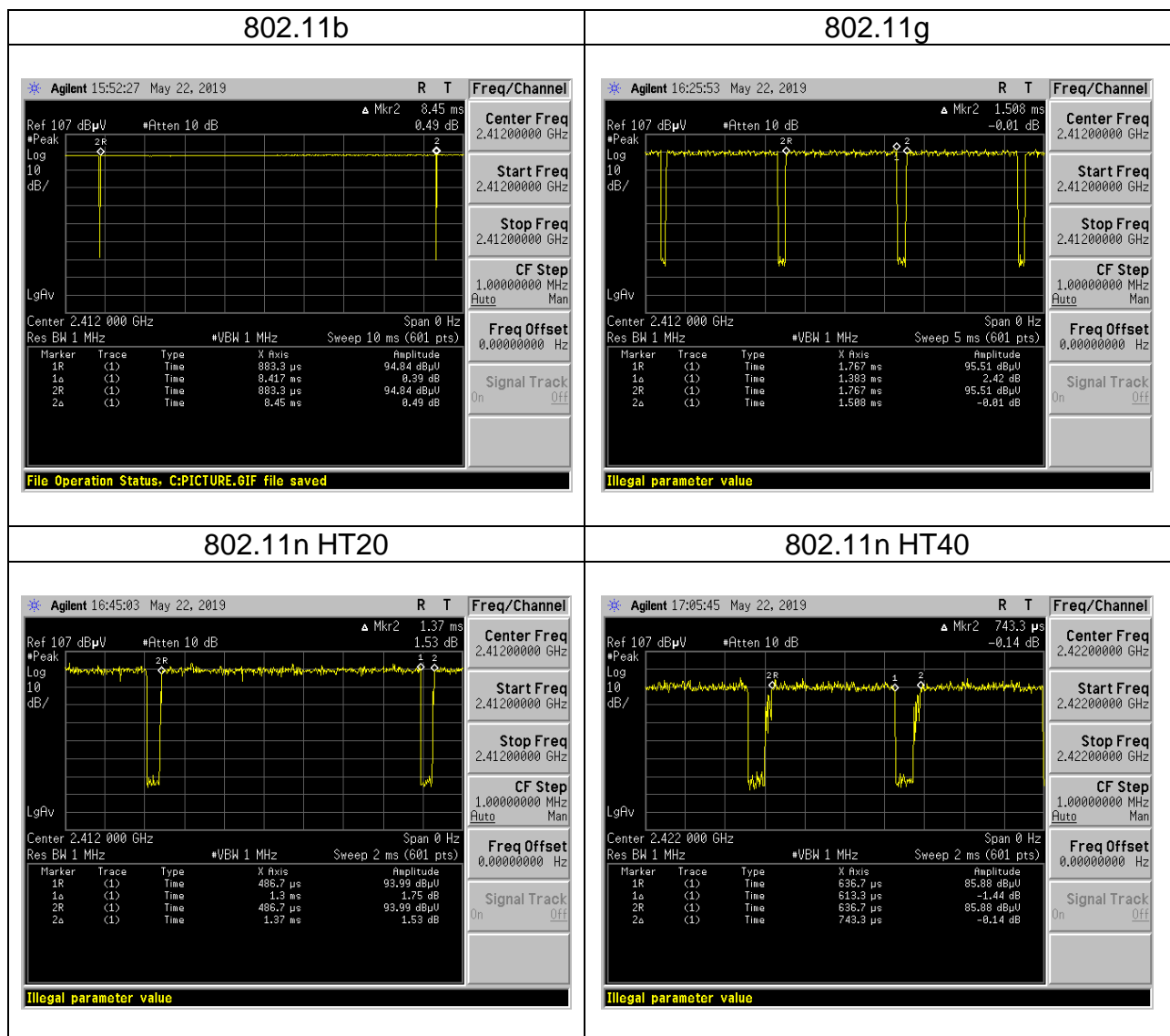

Report No.: T190513D01-RP

5. TEST RESULT

5.1 AC POWER LINE CONDUCTED EMISSION

5.1.1 Test Limit

According to §15.207(a),

Frequency Range (MHz)	Limits(dBµV)	
	Quasi-peak	Average
0.15 to 0.50	66 to 56*	56 to 46*
0.50 to 5	56	46
5 to 30	60	50

* Decreases with the logarithm of the frequency.

5.1.2 Test Procedure

Test method Refer as ANSI C63.10: 2013 clause 6.2,

1. The EUT was placed on a non-conducted table, which is 0.8m above horizontal ground plane and 0.4m above vertical ground plane.
2. EUT connected to the line impedance stabilization network (LISN)
3. Receiver set RBW of 9kHz and Detector Peak, and note as quasi-peak and average.
4. Maximum procedure was performed on the six highest emissions to ensure EUT compliance.
5. Recorded Line for Neutral and Line.

5.1.3 Test Setup

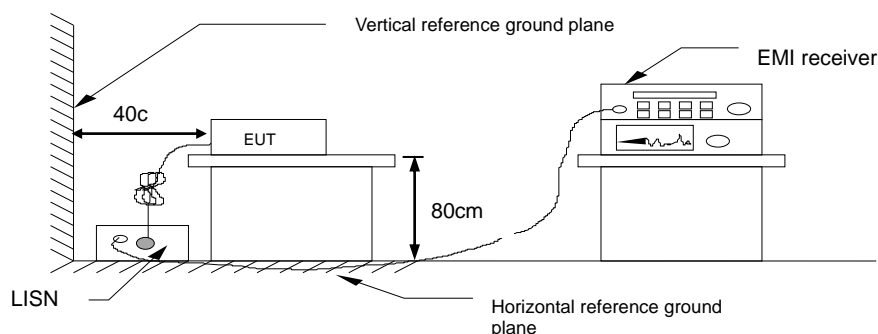

5.1.4 Test Result

Pass.

Report No.: T190513D01-RP

Test Data

Test Mode:	Mode 1	Temp/Hum	24(°C) / 50%RH
Phase:	Line	Test Date	July 23, 2019
		Test Engineer	Dally Hong

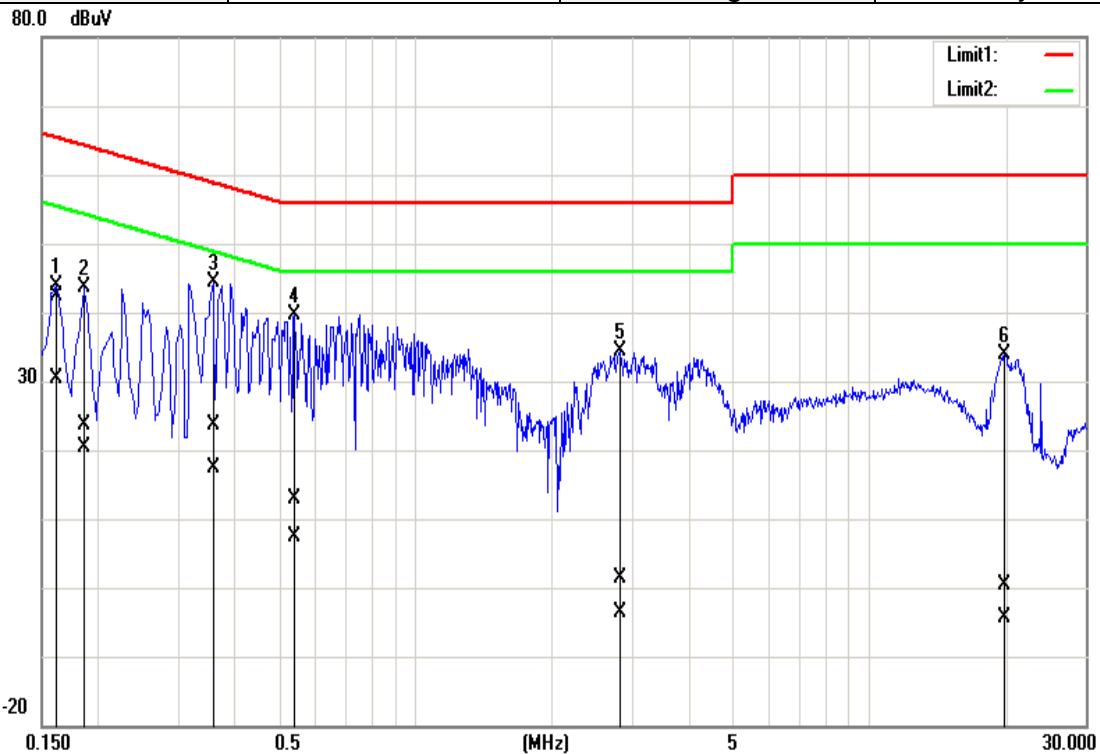

Frequency (MHz)	Quasi Peak reading (dBuV)	Average reading (dBuV)	Correction factor (dB)	Quasi Peak result (dBuV)	Average result (dBuV)	Quasi Peak limit (dBuV)	Average limit (dBuV)	Quasi Peak margin (dB)	Average margin (dB)	Remark
0.1620	42.19	30.29	0.16	42.35	30.45	65.36	55.36	-23.01	-24.91	Pass
0.1860	23.55	20.25	0.15	23.70	20.40	64.21	54.21	-40.51	-33.81	Pass
0.3580	23.40	17.11	0.16	23.56	17.27	58.77	48.77	-35.21	-31.50	Pass
0.5420	12.79	7.11	0.16	12.95	7.27	56.00	46.00	-43.05	-38.73	Pass
2.8260	1.17	-3.74	0.23	1.40	-3.51	56.00	46.00	-54.60	-49.51	Pass
19.9460	-0.22	-4.99	0.71	0.49	-4.28	60.00	50.00	-59.51	-54.28	Pass

Report No.: T190513D01-RP

Test Mode:	Mode 1	Temp/Hum	24(°C) / 50%RH
Phase:	Neutral	Test Date	July 23, 2019
		Test Engineer	Dally Hong

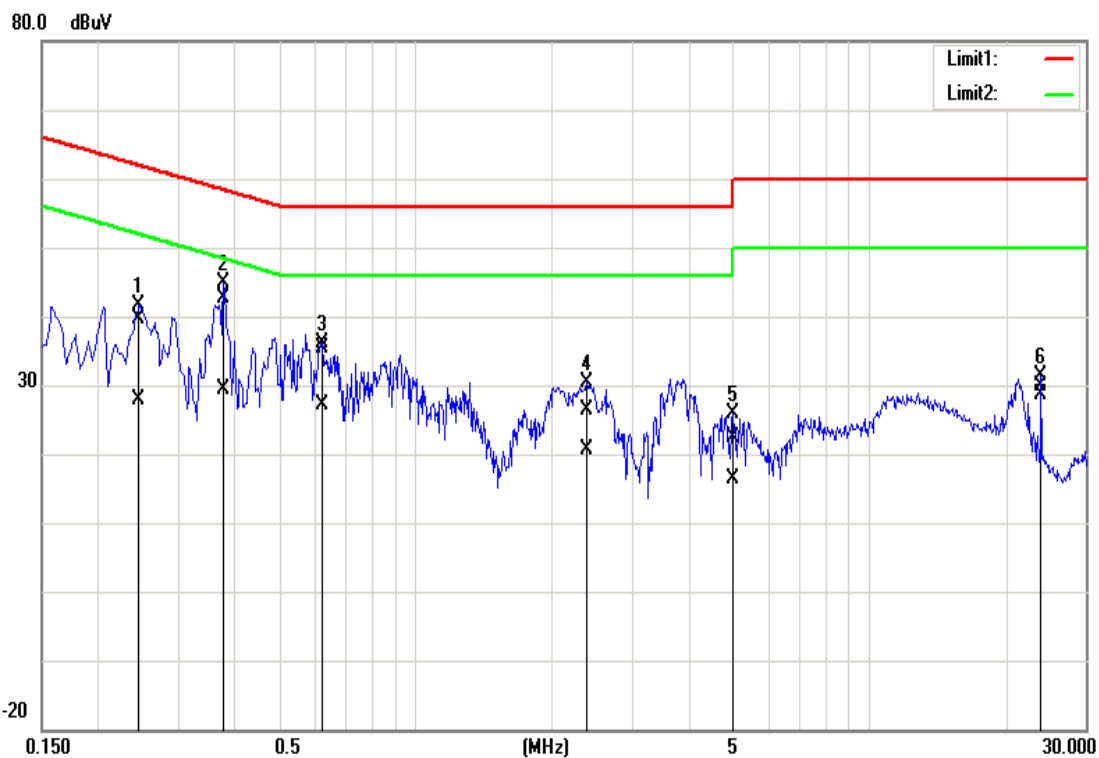

Frequency (MHz)	Quasi Peak reading (dBuV)	Average reading (dBuV)	Correction factor (dB)	Quasi Peak result (dBuV)	Average result (dBuV)	Quasi Peak limit (dBuV)	Average limit (dBuV)	Quasi Peak margin (dB)	Average margin (dB)	Remark
0.2460	39.56	27.79	0.10	39.66	27.89	61.89	51.89	-22.23	-24.00	Pass
0.3780	42.64	29.35	0.11	42.75	29.46	58.32	48.32	-15.57	-18.86	Pass
0.6260	35.36	26.97	0.11	35.47	27.08	56.00	46.00	-20.53	-18.92	Pass
2.3860	26.11	20.48	0.17	26.28	20.65	56.00	46.00	-29.72	-25.35	Pass
5.0060	22.20	16.06	0.23	22.43	16.29	60.00	50.00	-37.57	-33.71	Pass
23.9260	29.30	27.94	0.64	29.94	28.58	60.00	50.00	-30.06	-21.42	Pass

5.2 6dB BANDWIDTH AND OCCUPIED BANDWIDTH(99%)

5.2.1 Test Limit

According to §15.247(a)(2),

6 dB Bandwidth :

Limit	Shall be at least 500kHz
-------	--------------------------

Occupied Bandwidth(99%) : For reporting purposes only.

5.2.2 Test Procedure

Test method Refer as KDB 558074 D01 and ANSI C63.10: 2013 clause 6.9.2,

1. The EUT RF output connected to the spectrum analyzer by RF cable.
2. Setting maximum power transmit of EUT
3. SA set RBW =100KHz , VBW = 300KHz and Detector = Peak, to measurement 6dB Bandwidth
4. SA set RBW = 1% ~ 5% OBW, VBW = three times the RBW and Detector = Peak, to measurement 99% Bandwidth
5. Measure and record the result of 6 dB Bandwidth and 99% Bandwidth. in the test report.

5.2.3 Test Setup

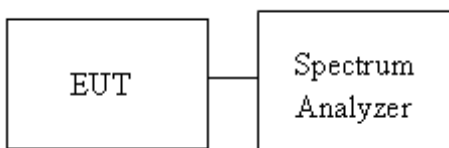

Report No.: T190513D01-RP

5.2.4 Test Result

Test mode: IEEE 802.11b Mode / 2412-2462 MHz				
Channel	Frequency (MHz)	OBW(99%) (MHz)	6dB BW (MHz)	6dB limit (kHz)
Low	2412	14.8046	10.072	≥500
Mid	2437	14.6309	9.942	
High	2462	14.6309	10.029	

Test mode: IEEE 802.11g Mode / 2412-2462 MHz				
Channel	Frequency (MHz)	OBW(99%) (MHz)	6dB BW (MHz)	6dB limit (kHz)
Low	2412	16.9753	15.326	≥500
Mid	2437	16.7583	15.152	
High	2462	16.4109	15.145	

Test mode: IEEE 802.11n HT20 Mode / 2412-2462 MHz				
Channel	Frequency (MHz)	OBW(99%) (MHz)	6dB BW (MHz)	6dB limit (kHz)
Low	2412	17.8871	15.152	≥500
Mid	2437	17.7568	15.152	
High	2462	17.7568	15.152	

Test mode: IEEE 802.11n HT40 Mode / 2422-2452 MHz				
Channel	Frequency (MHz)	OBW(99%) (MHz)	6dB BW (MHz)	6dB limit (kHz)
Low	2422	36.5846	33.92	≥500
Mid	2437	36.3531	33.92	
High	2452	36.4688	33.92	

Report No.: T190513D01-RP

Test Data

6dB BANDWIDTH

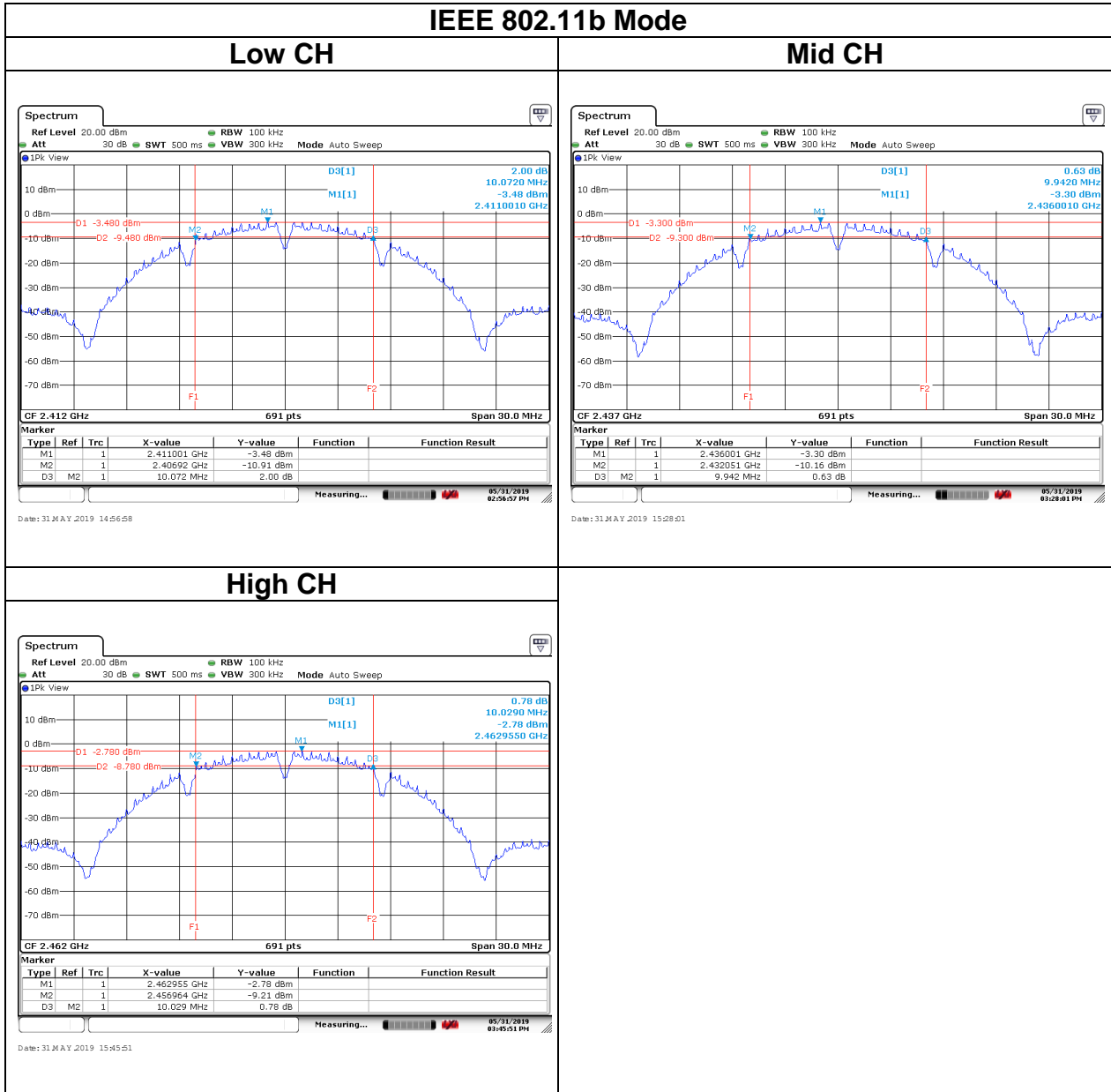

IEEE 802.11g Mode

Low CH

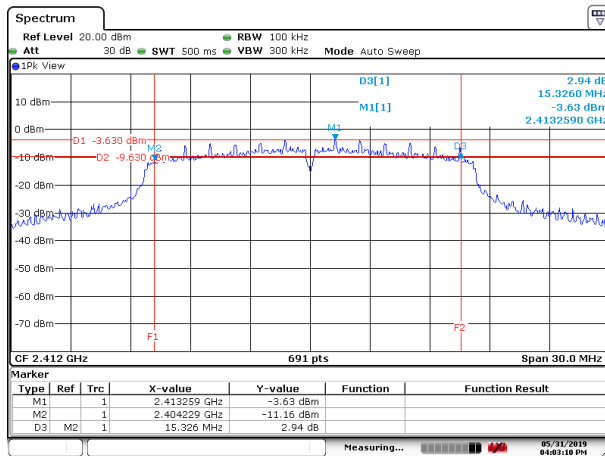

Date: 31 MAY 2019 16:03:00

Mid CH

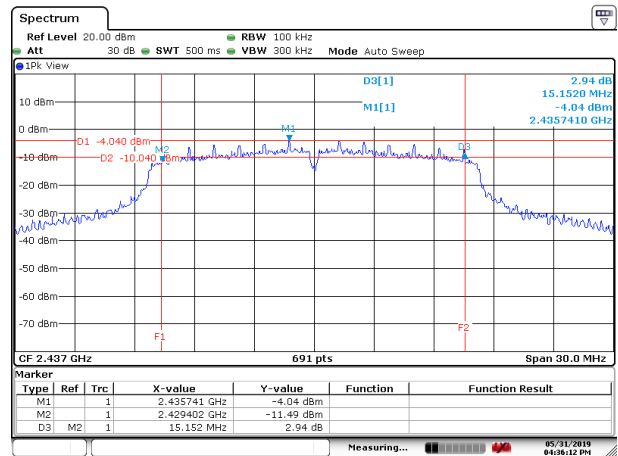

Date: 31 MAY 2019 16:36:12

High CH

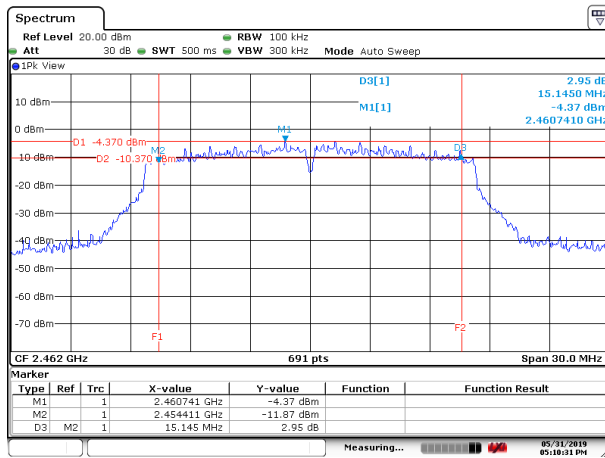

Date: 31 MAY 2019 17:00:31

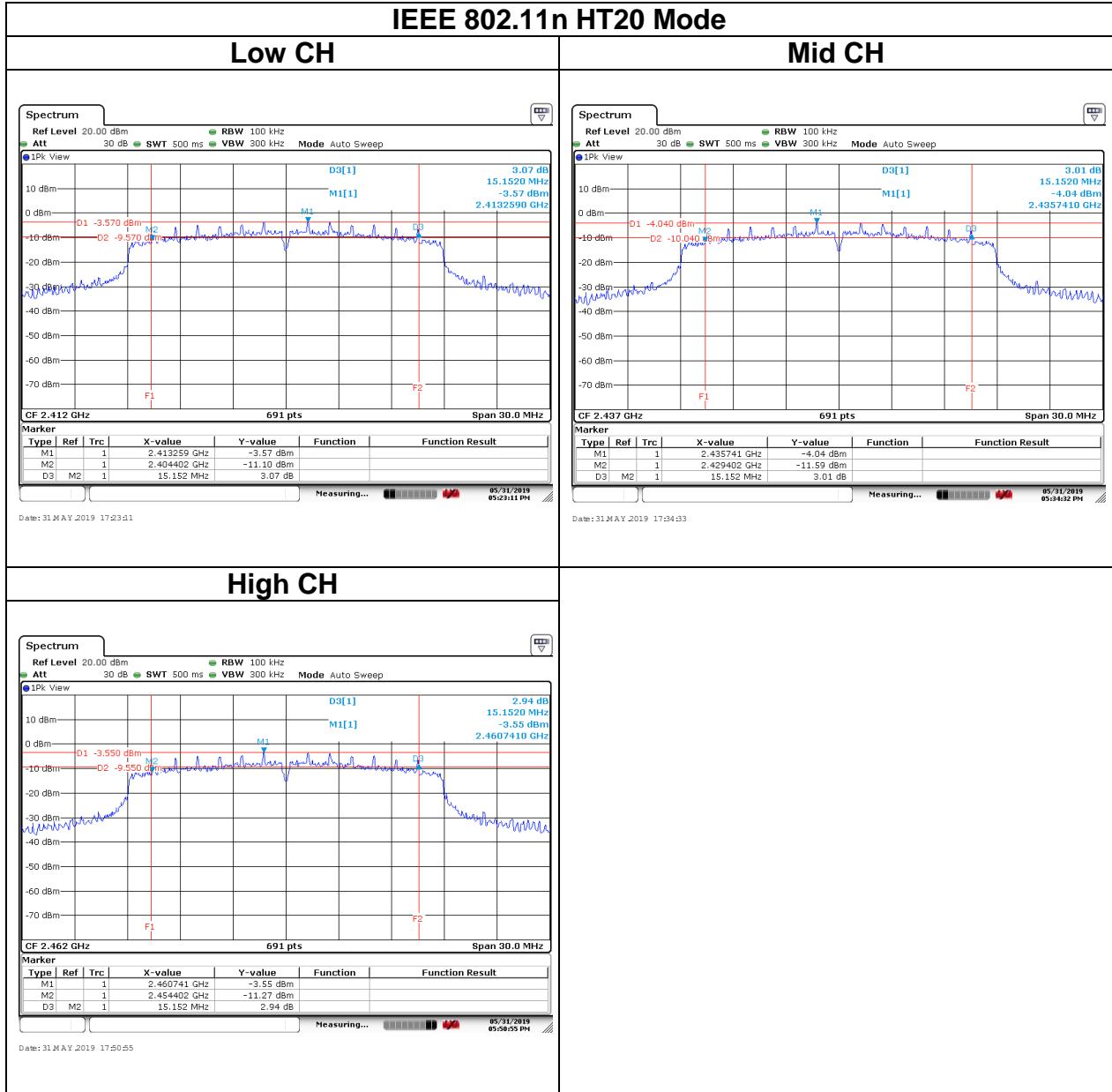

Report No.: T190513D01-RP

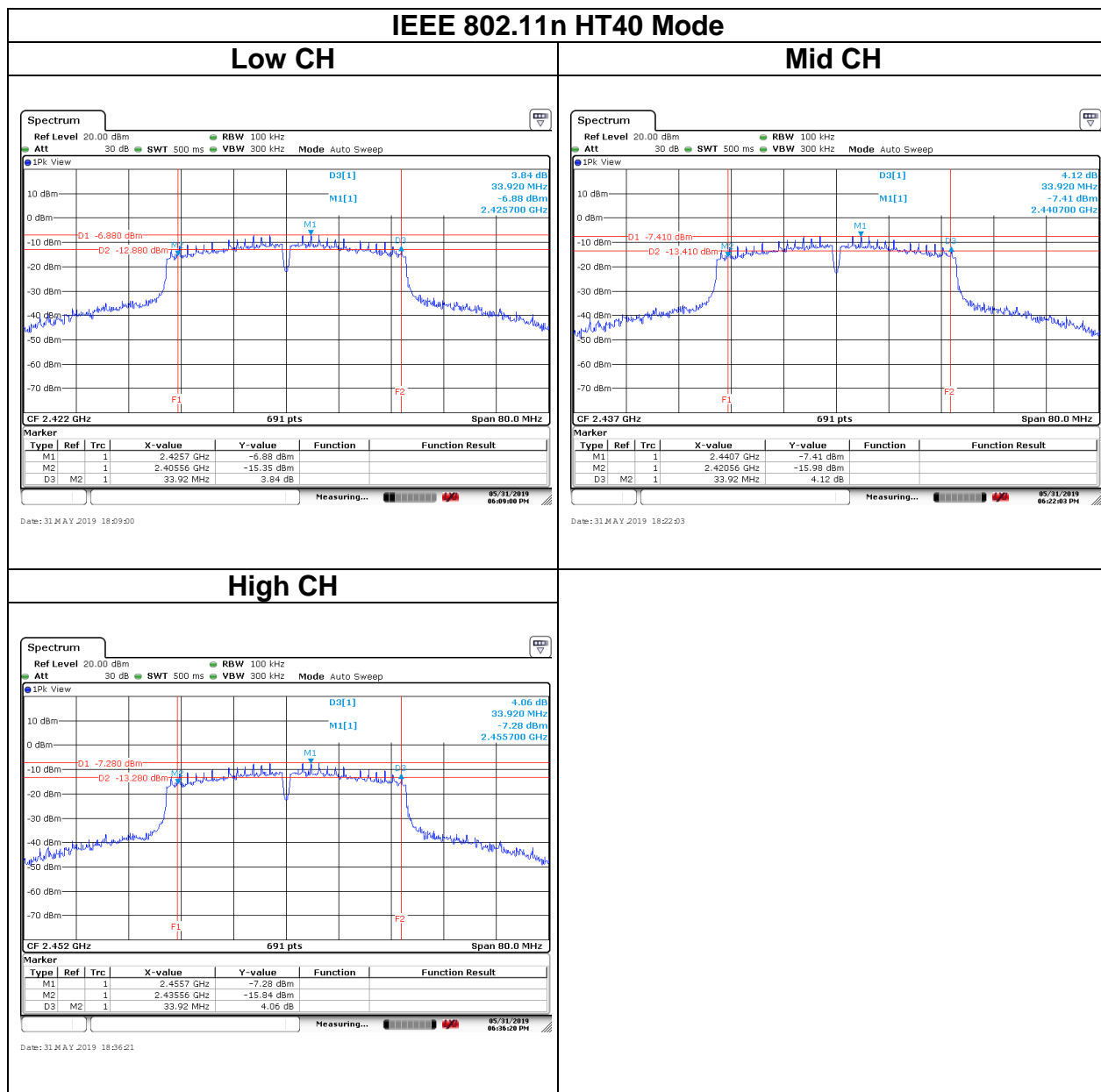

Test Data

BANDWIDTH (99%)

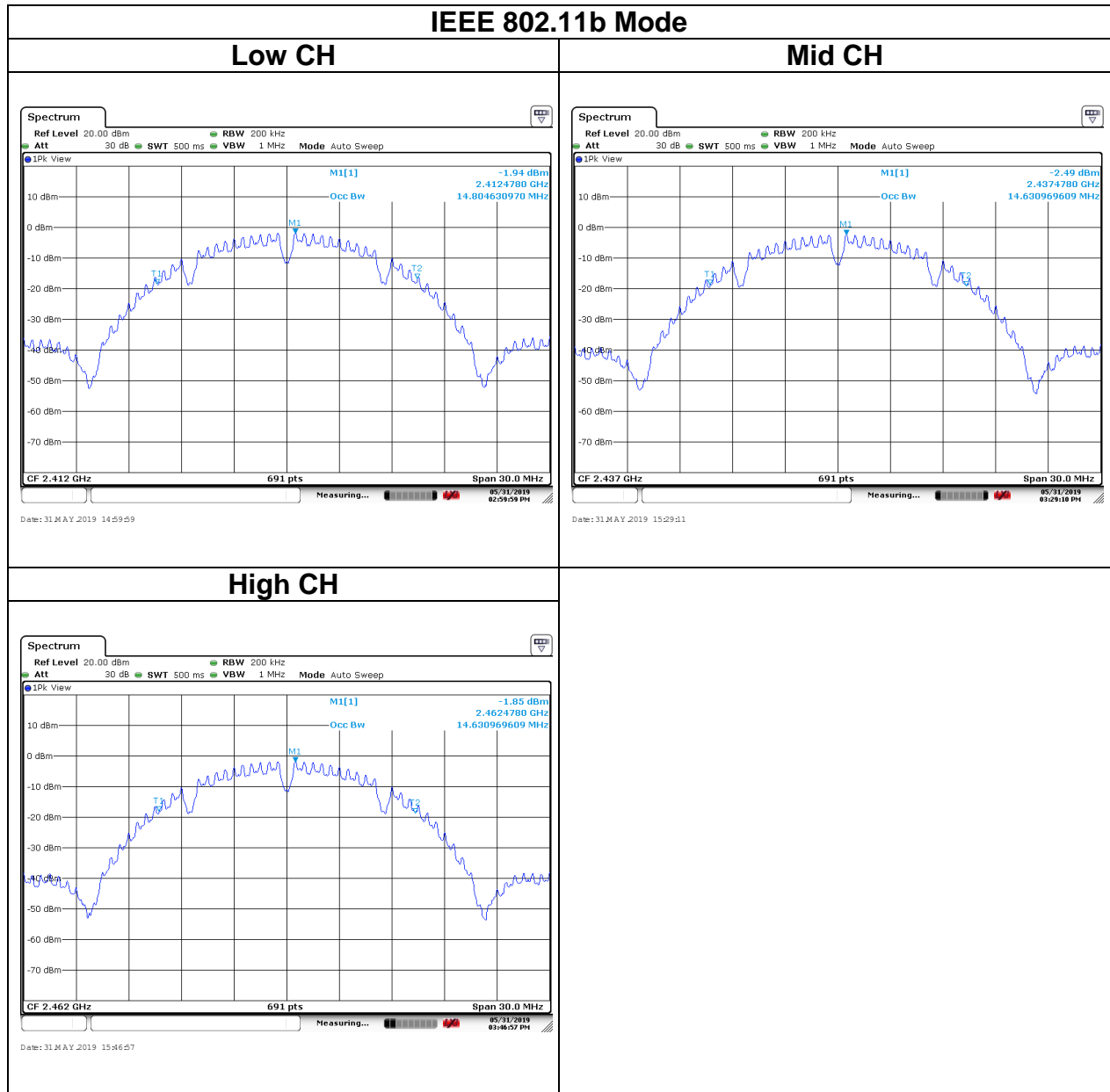

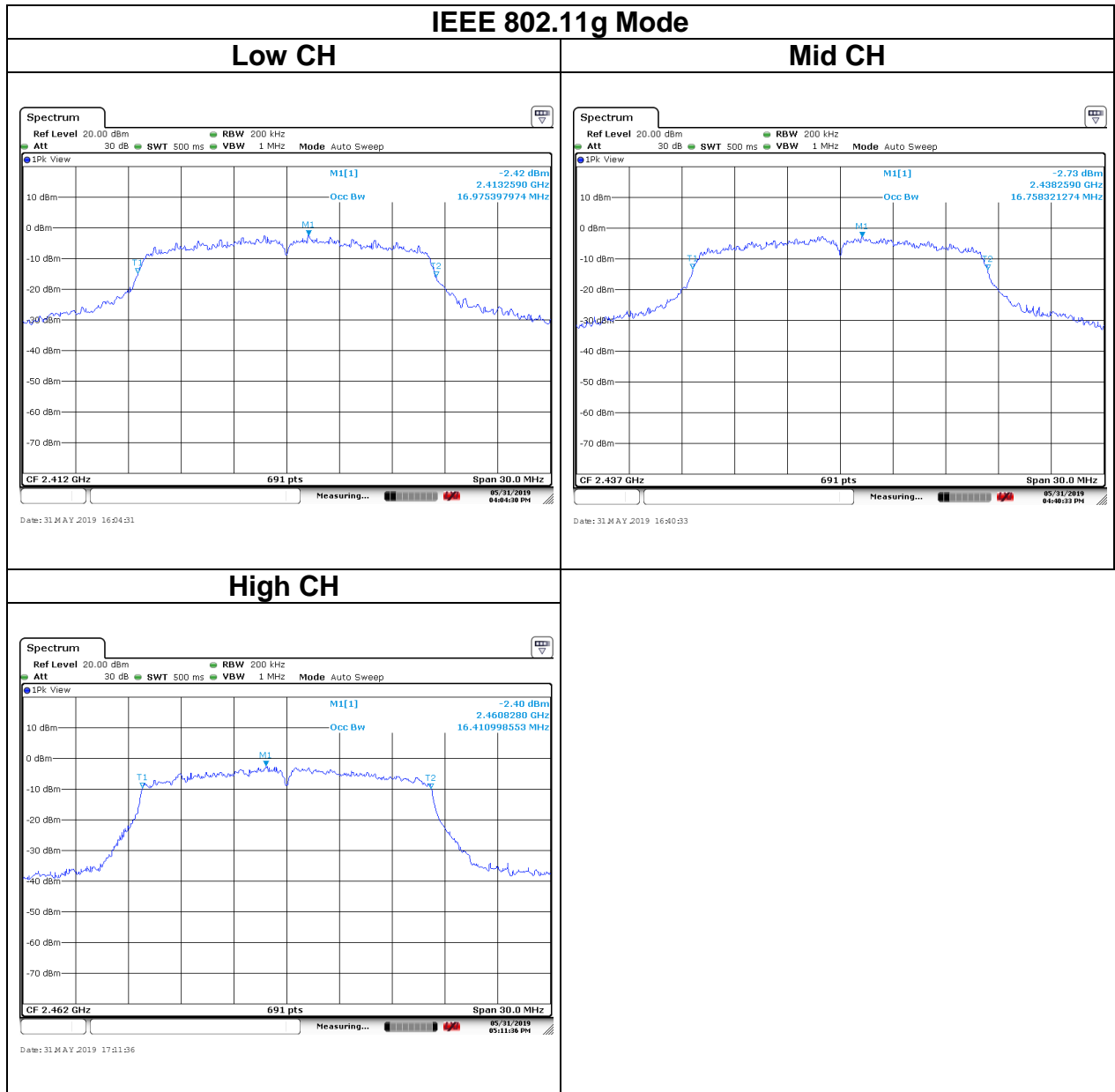

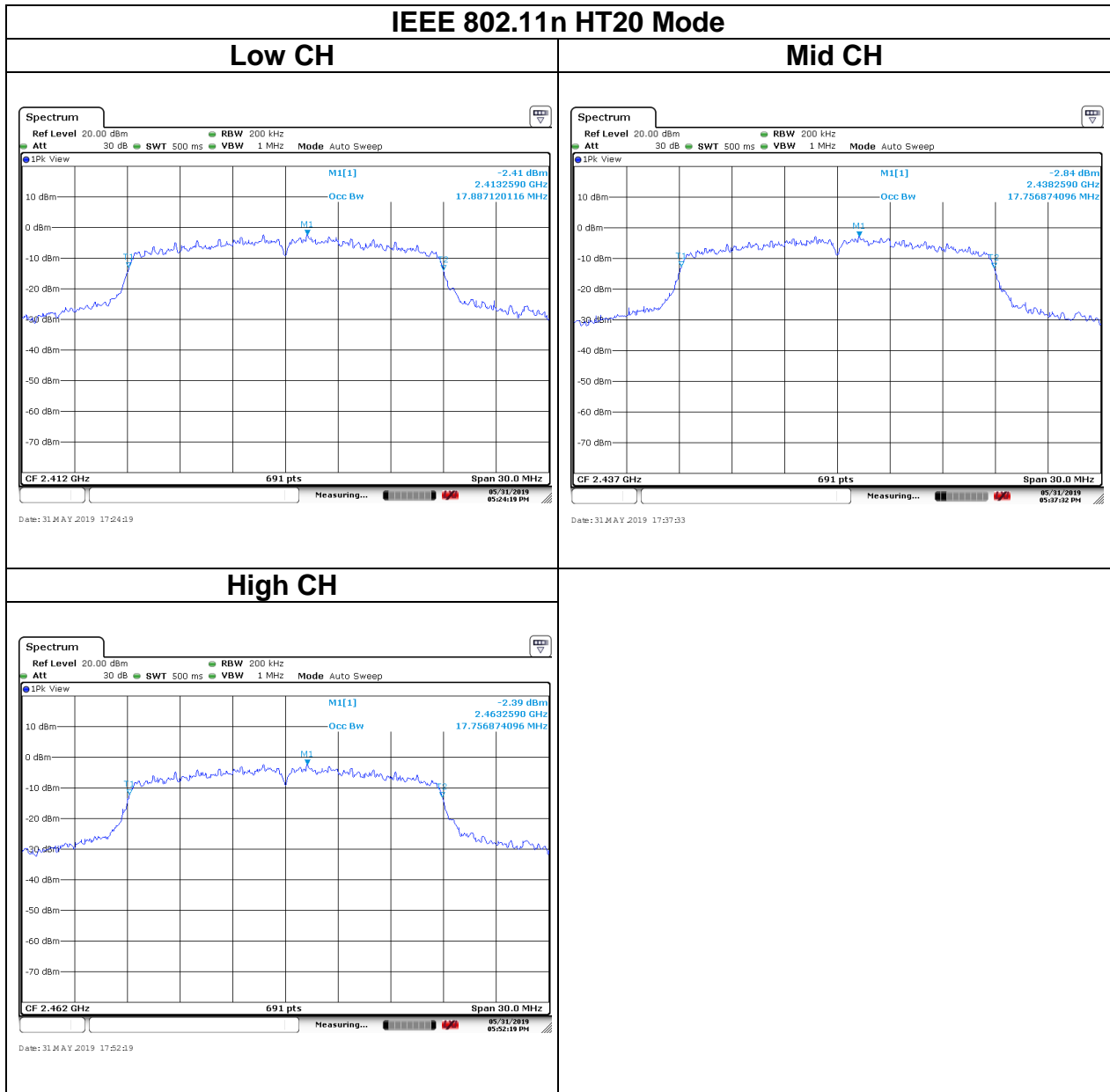

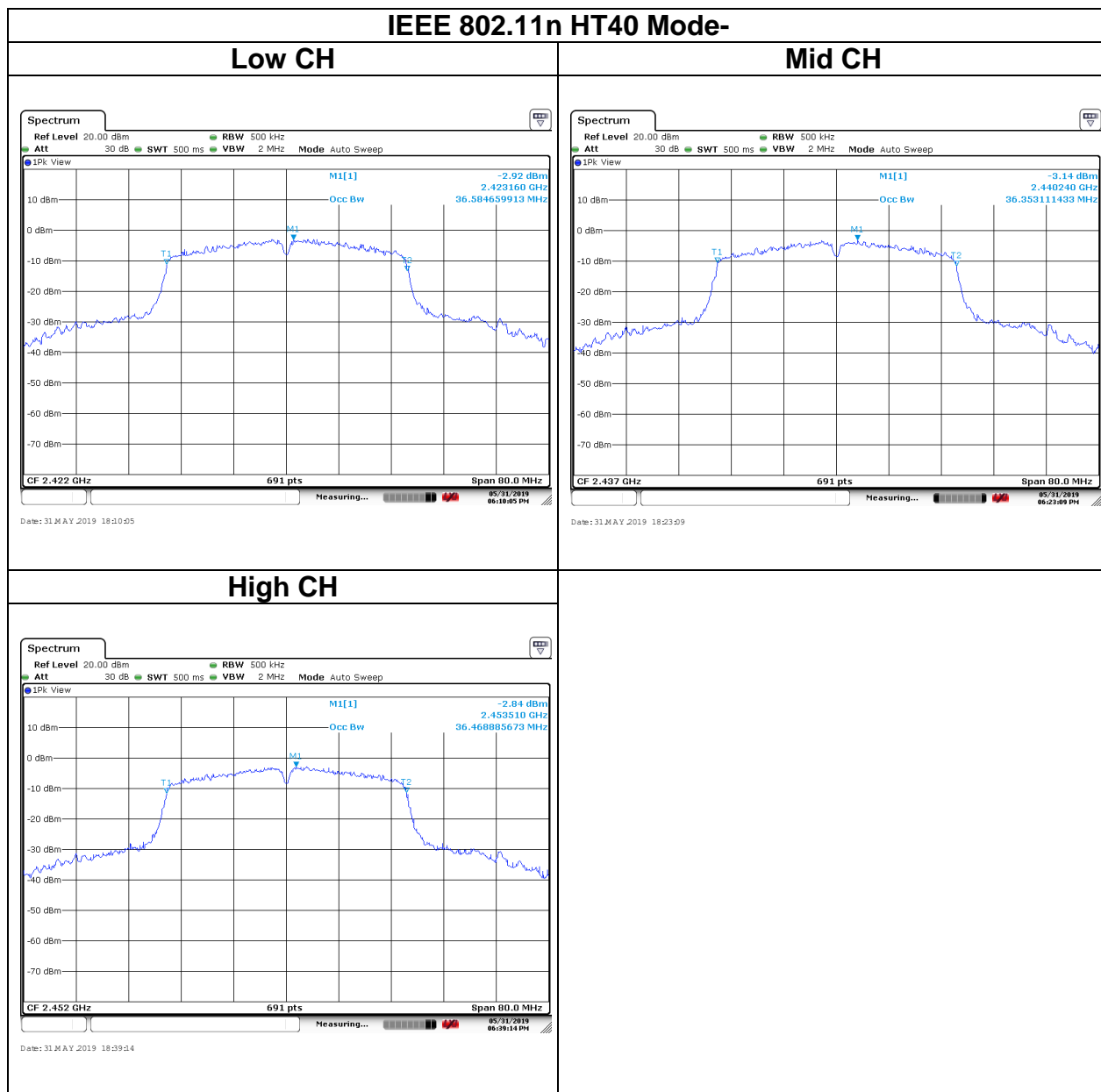

Report No.: T190513D01-RP

5.3 OUTPUT POWER MEASUREMENT

5.3.1 Test Limit

According to §15.247(b)(3),

Peak output power :

For systems using digital modulation in the 2400-2483.5 MHz: 1 Watt(30 dBm), base on the use of antennas with directional gain not exceed 6 dBi. If transmitting antennas of directional gain greater than 6dBi are used the peak output power the conducted output power from the intentional radiator shall be reduced by the amount in dB that the directional gain of the antenna exceeds 6 dBi. In case of point-to-point operation, the limit has to be reduced by 1dB for every 3 dB that the directional gain of the antenna exceeds 6 dBi.

Limit	<input checked="" type="checkbox"/> Antenna not exceed 6 dBi : 30dBm <input type="checkbox"/> Antenna with DG greater than 6 dBi : [Limit = 30 – (DG – 6)] <input type="checkbox"/> Point-to-point operation :
-------	---

Average output power : For reporting purposes only.

5.3.2 Test Procedure

Test method Refer as KDB 558074 D01.

1. The EUT RF output connected to the power meter by RF cable.
2. Setting maximum power transmit of EUT.
3. The path loss was compensated to the results for each measurement.
4. Measure and record the result of Peak output power and Average output power. in the test report.

5.3.3 Test Setup

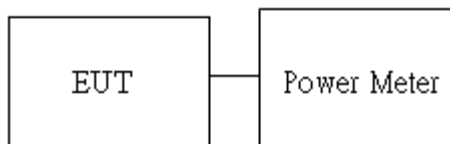

Report No.: T190513D01-RP

5.3.4 Test Result

Peak output power :

Wifi 2.4G						
Config	CH	Freq. (MHz)	power set	PK Power (dBm)	PK Total Power (W)	Limit (dBm)
IEEE 802.11b Data rate: 1Mbps	Low	2412	1E	19.42	0.0875	30
	Mid	2437	1E	20.80	0.1202	
	High	2462	1E	21.45	0.1396	
IEEE 802.11g Data rate: 6Mbps	Low	2412	1E	22.19	0.1656	
	Mid	2437	1E	23.83	0.2415	
	High	2462	1A	23.18	0.2080	
IEEE 802.11n 20MHz Data rate: MCS0	Low	2412	1A	21.74	0.1493	
	Mid	2437	1E	23.89	0.2449	
	High	2462	18	22.87	0.1936	
IEEE 802.11n 40MHz Data rate: MCS0	Low	2422	15	19.84	0.0964	
	Mid	2437	1E	23.37	0.2173	
	High	2452	15	20.98	0.1253	

Report No.: T190513D01-RP

Average output power :

Wifi 2.4G				
Config	CH	Freq. (MHz)	Power Setting	AV Power (dBm)
IEEE 802.11b Data rate: 1Mbps	Low	2412	1E	17.65
	Mid	2437	1E	18.97
	High	2462	1E	19.50
IEEE 802.11g Data rate: 6Mbps	Low	2412	1E	16.57
	Mid	2437	1E	17.77
	High	2462	1A	15.90
IEEE 802.11n HT20 Data rate: MCS0	Low	2412	1A	14.64
	Mid	2437	1E	17.80
	High	2462	18	14.81
IEEE 802.11n HT40 Data rate: MCS0	Low	2422	15	11.94
	Mid	2437	1E	16.81
	High	2452	15	12.23

Report No.: T190513D01-RP

5.4 POWER SPECTRAL DENSITY

5.4.1 Test Limit

According to §15.247(e),

For digitally modulated systems, the power spectral density conducted from the intentional radiator to the antenna shall not be greater than 8 dBm in any 3 kHz band during any time interval of continuous transmission.

Limit	<input checked="" type="checkbox"/> Antenna not exceed 6 dBi : 8dBm <input type="checkbox"/> Antenna with DG greater than 6 dBi : [Limit = 8 – (DG – 6)] <input type="checkbox"/> Point-to-point operation :
-------	---

5.4.2 Test Procedure

Test method Refer as KDB 558074 D01.

1. The EUT RF output connected to the spectrum analyzer by RF cable.
2. Setting maximum power transmit of EUT
3. SA set RBW = 3kHz, VBW = 30kHz, Span = 1.5 times DTS Bandwidth (6 dB BW), Detector = Peak, Sweep Time = Auto and Trace = Max hold.
4. The path loss was compensated to the results for each measurement by SA.
5. Mark the maximum level.
6. Measure and record the result of power spectral density. in the test report.

5.4.3 Test Setup

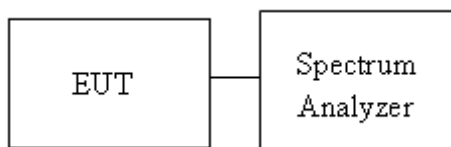

Report No.: T190513D01-RP

5.4.4 Test Result

Test mode: IEEE 802.11b Mode / 2412-2462 MHz			
Channel	Frequency (MHz)	PPSD (dBm)	Limit (dBm)
Low	2412	-7.54	8
Mid	2437	-8.2	
High	2462	-8.1	

Test mode: IEEE 802.11g Mode / 2412-2462 MHz			
Channel	Frequency (MHz)	PPSD (dBm)	Limit (dBm)
Low	2412	-9.13	8
Mid	2437	-8.58	
High	2462	-9.28	

Test mode: IEEE 802.11n HT20 Mode / 2412-2462 MHz			
Channel	Frequency (MHz)	PPSD (dBm)	Limit (dBm)
Low	2412	-8.71	8
Mid	2437	-8.21	
High	2462	-8.84	

Test mode: IEEE 802.11n HT40 Mode / 2422-2452 MHz			
Channel	Frequency (MHz)	PPSD (dBm)	Limit (dBm)
Low	2422	-10.3	8
Mid	2437	-10.56	
High	2452	-10.31	

Test Data

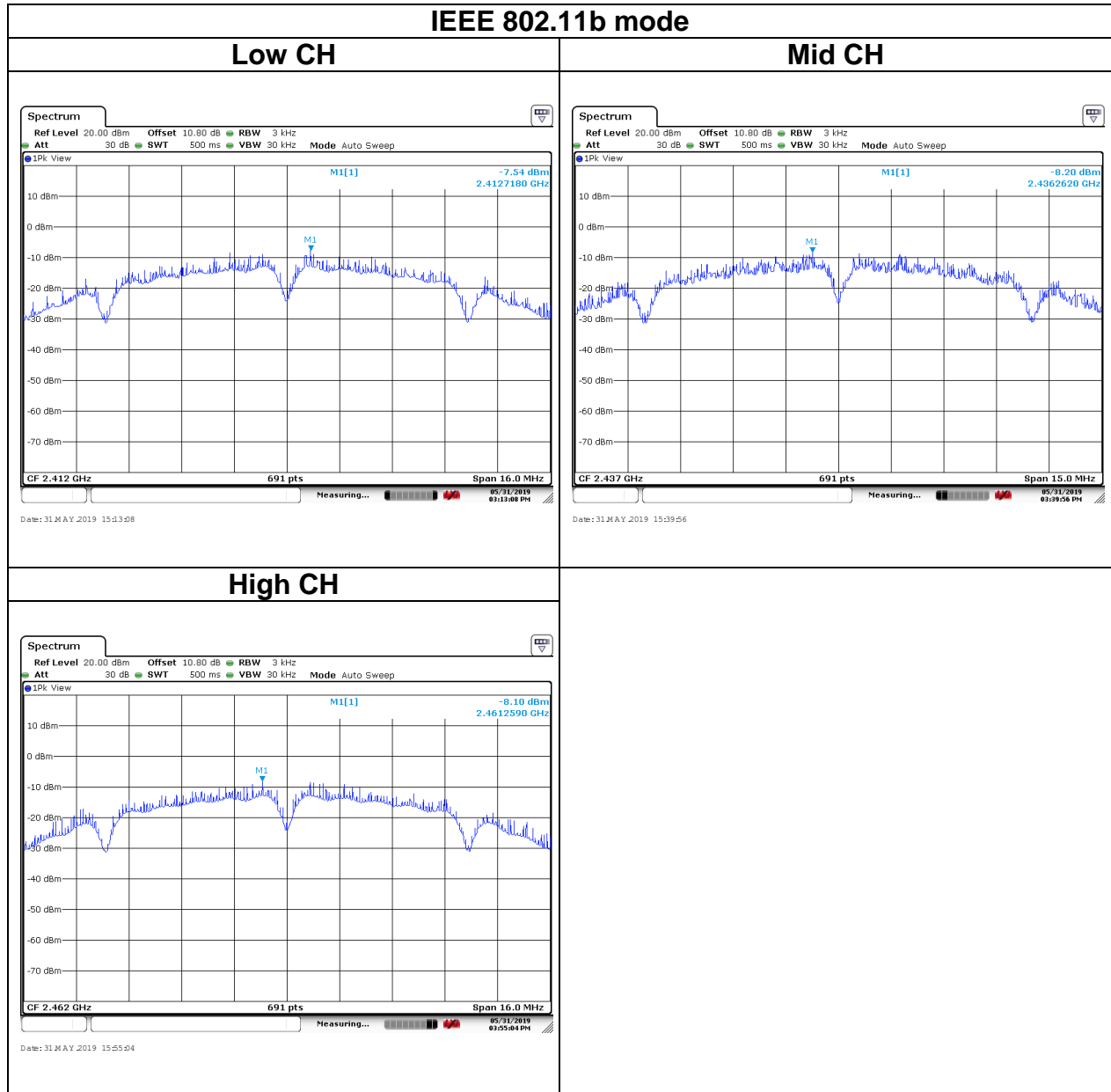

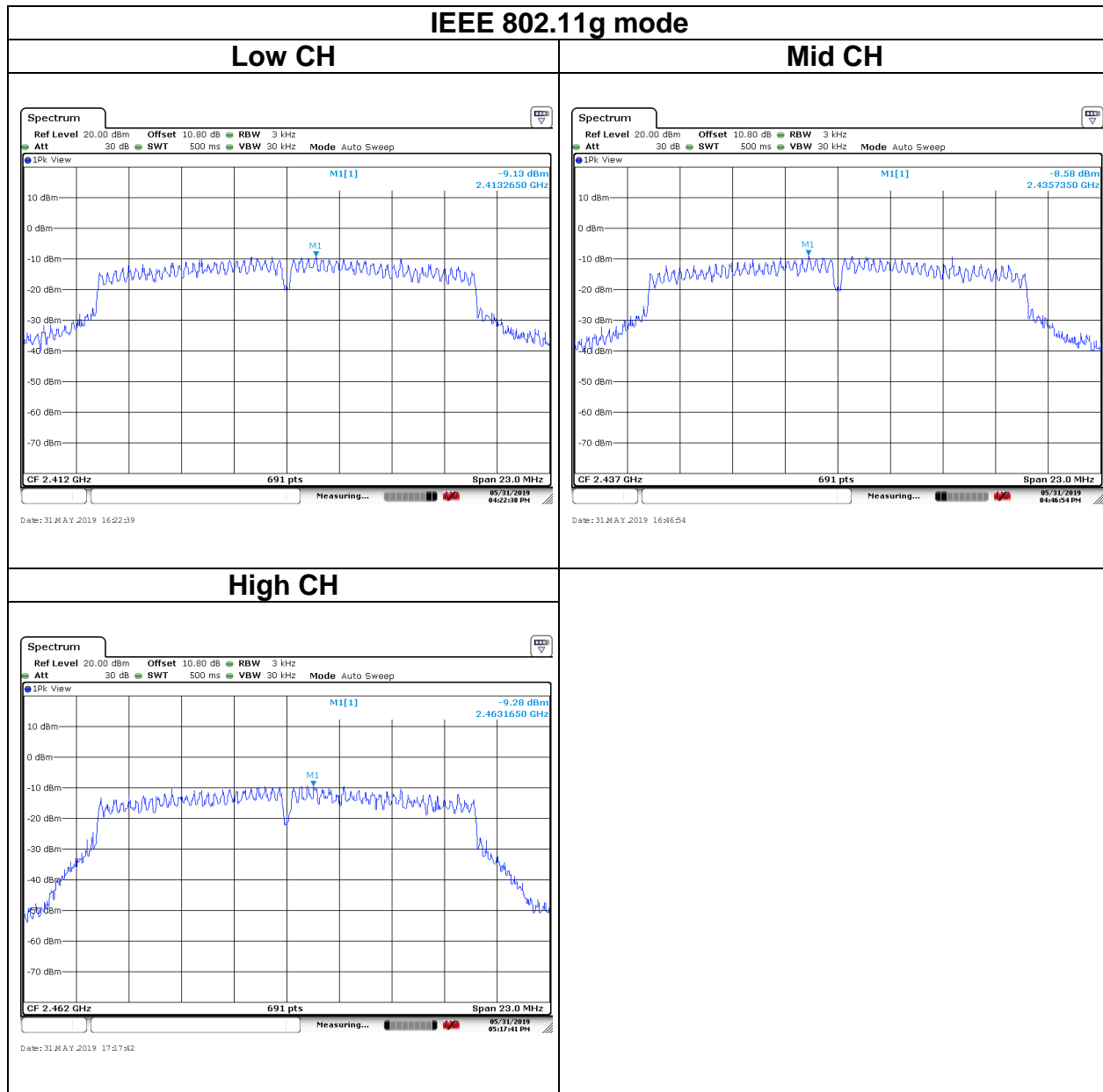

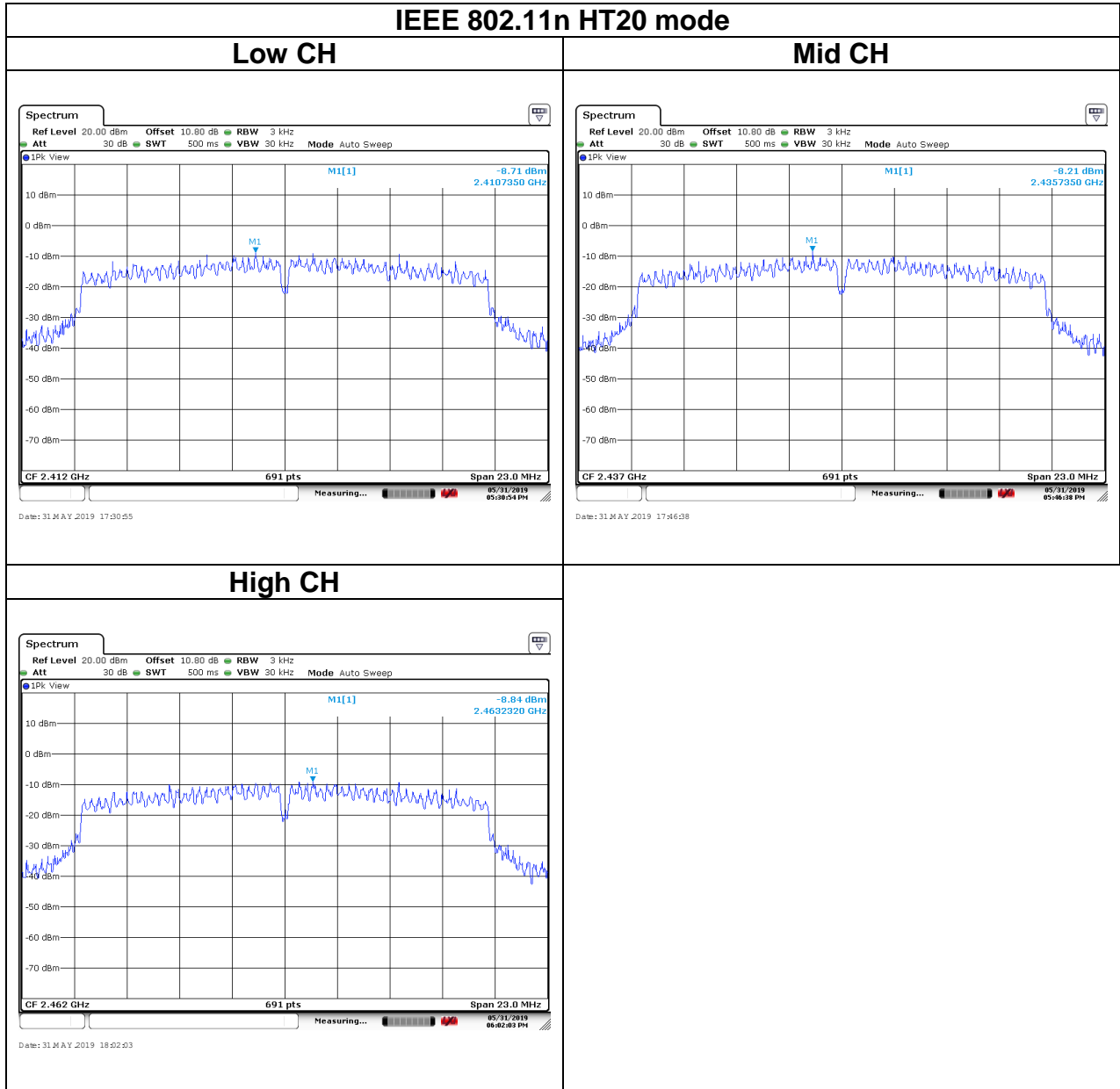

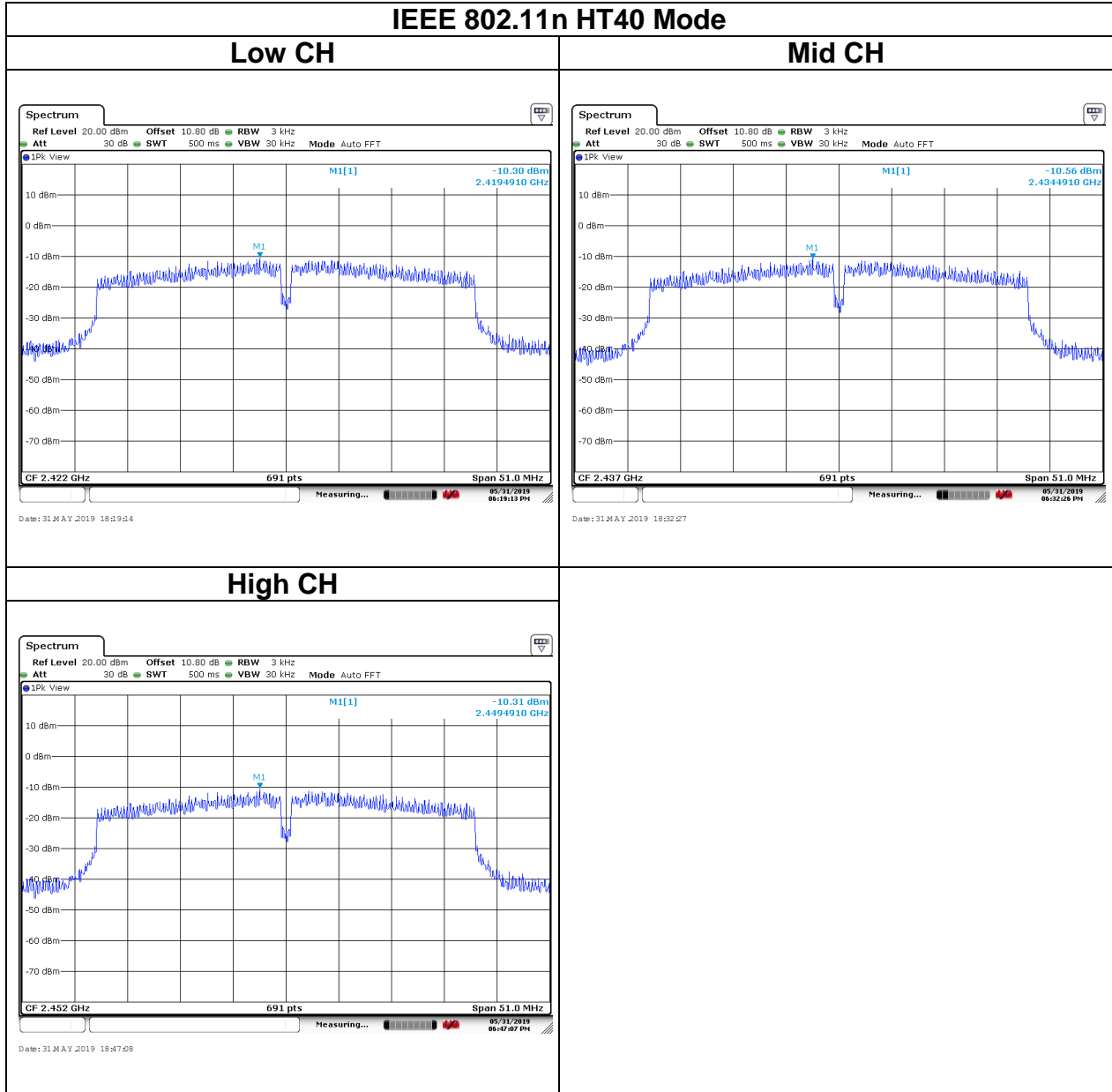

Report No.: T190513D01-RP

5.5 CONDUCTED BANDEDGE AND SPURIOUS EMISSION

5.5.1 Test Limit

According to §15.247(d),

In any 100 kHz bandwidth outside the authorized frequency band,

Non-restricted bands shall be attenuated at least 20 dB/30 dB relative to the maximum PSD level in 100 kHz by RF conducted or a radiated measurement which fall in the restricted bands, as defined in §15.205(a), must also comply with the radiated emission limits specified in §15.209(a).

5.5.2 Test Procedure

Test method Refer as KDB 558074 D01.

1. EUT RF output port connected to the SA by RF cable, and the path loss was compensated to result.
2. SA setting, RBW=100kHz, VBW=300kHz, Detector=Peak, Trace mode = max hold, SWT = Auto.
3. In any 100 kHz bandwidth outside the authorized frequency band, shall be attenuated at least 20 dB relative to the maximum in-band peak PSD level in 100 kHz when conducted power procedure is used. If the transmitter complies with the conducted power limits based on the use of RMS averaging over a time interval, the attenuation required under this paragraph shall be 30 dB instead of 20 dB.

5.5.3 Test Setup



Report No.: T190513D01-RP

5.5.4 Test Result

Test Data

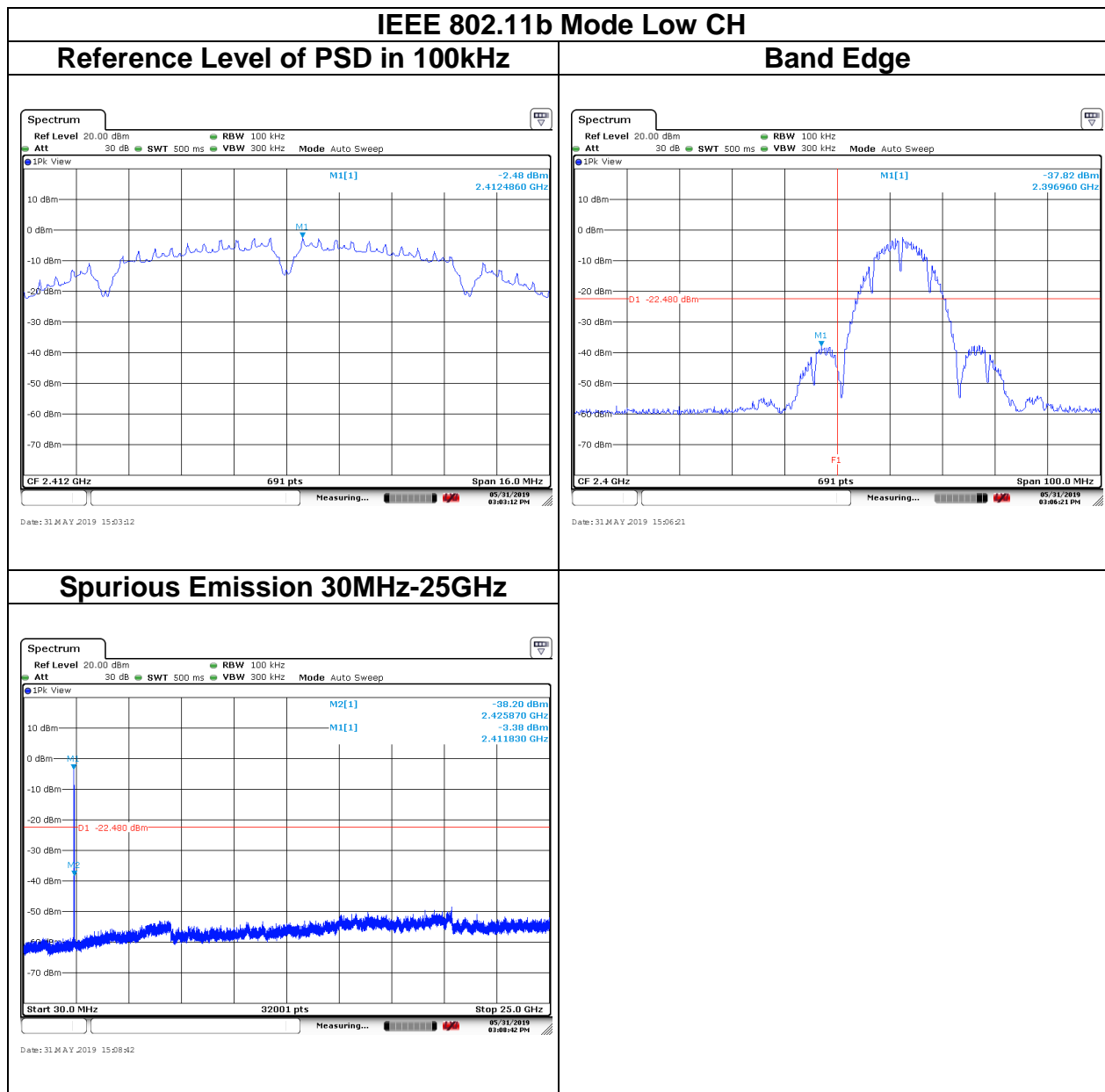

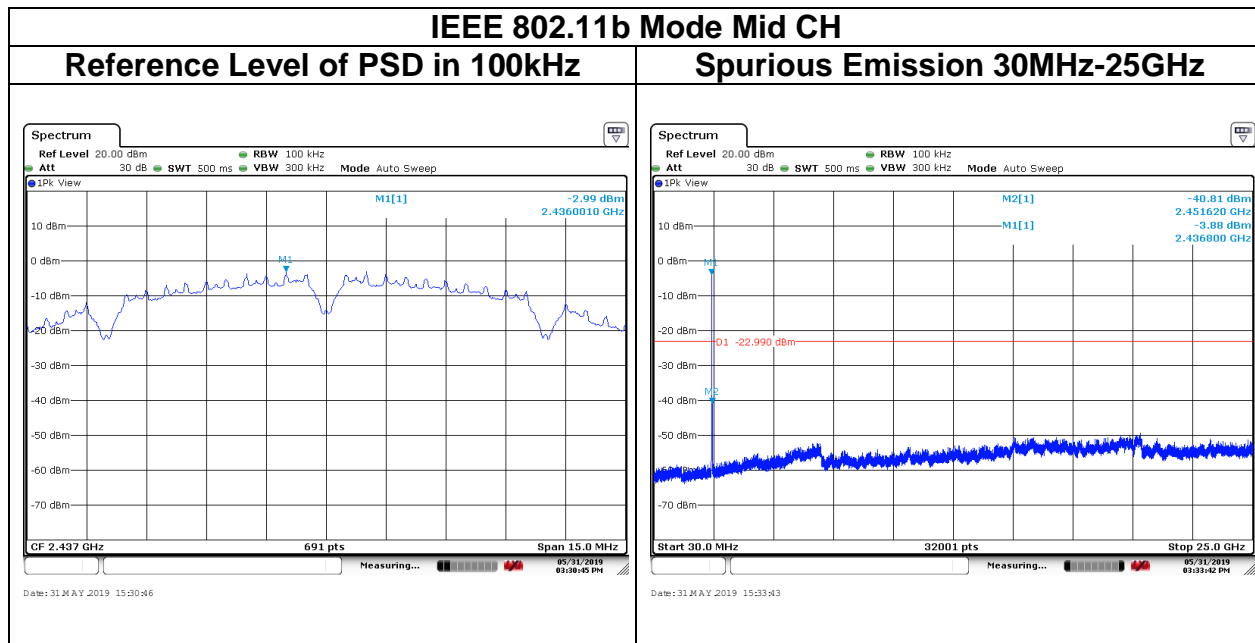

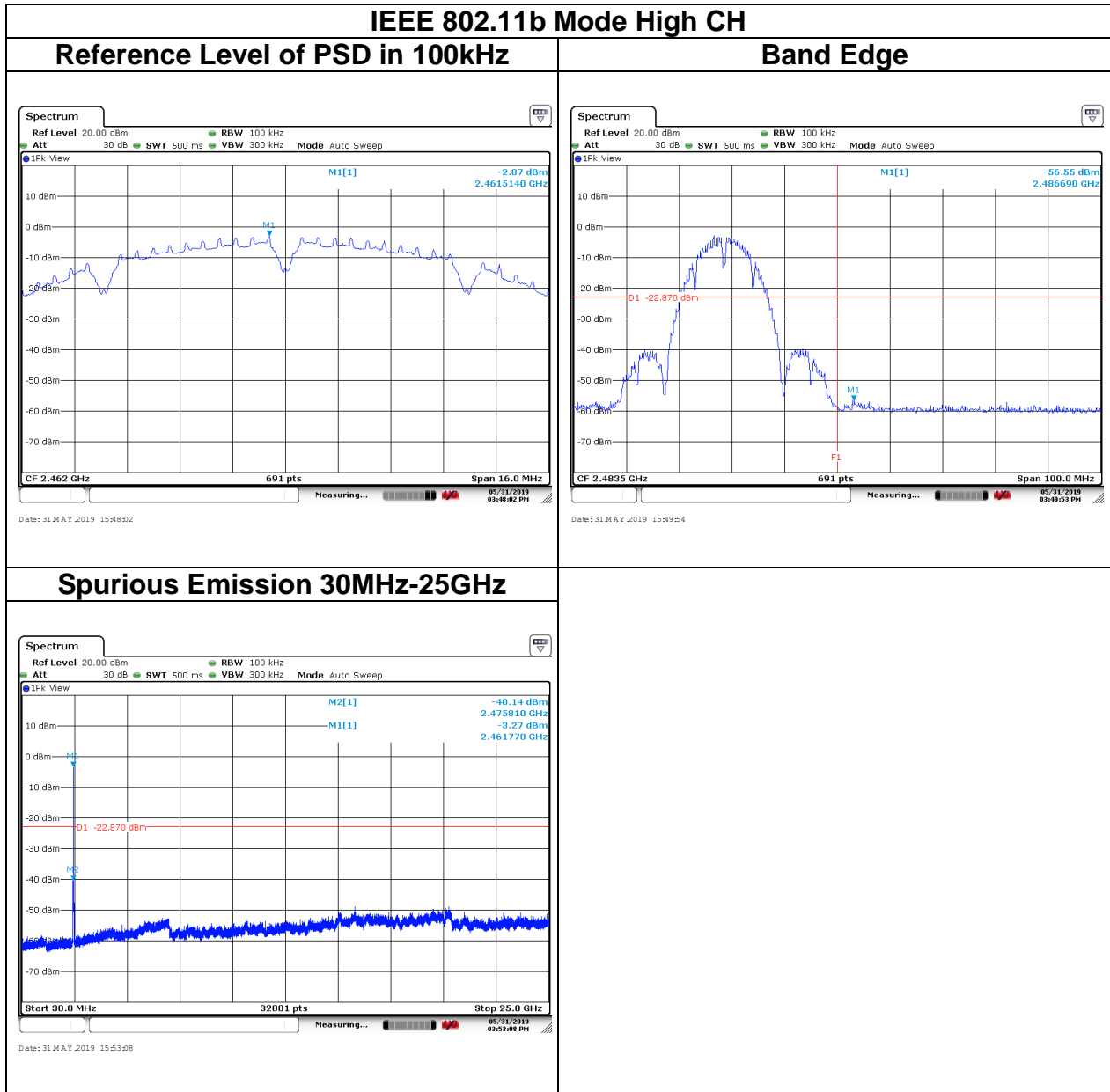

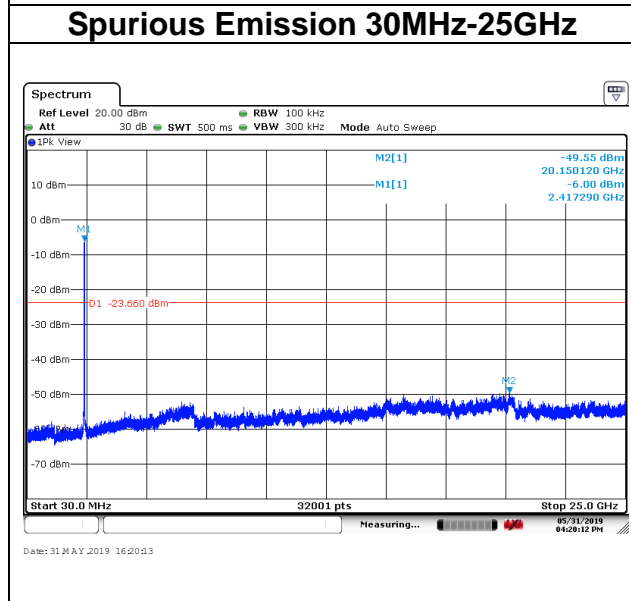
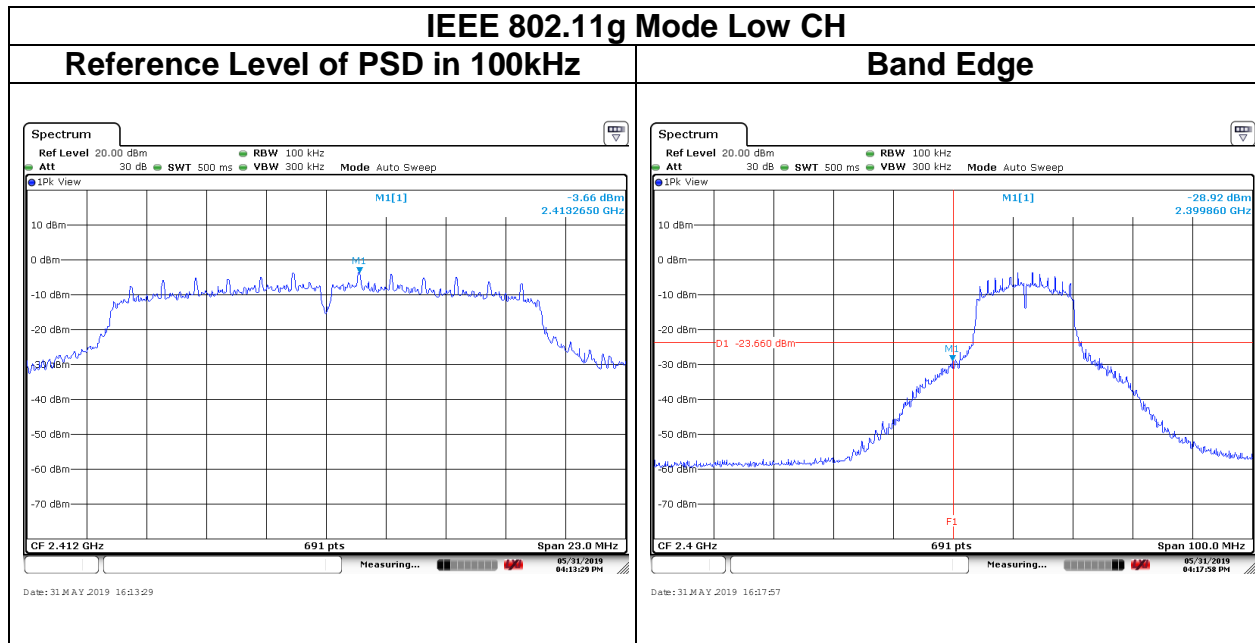

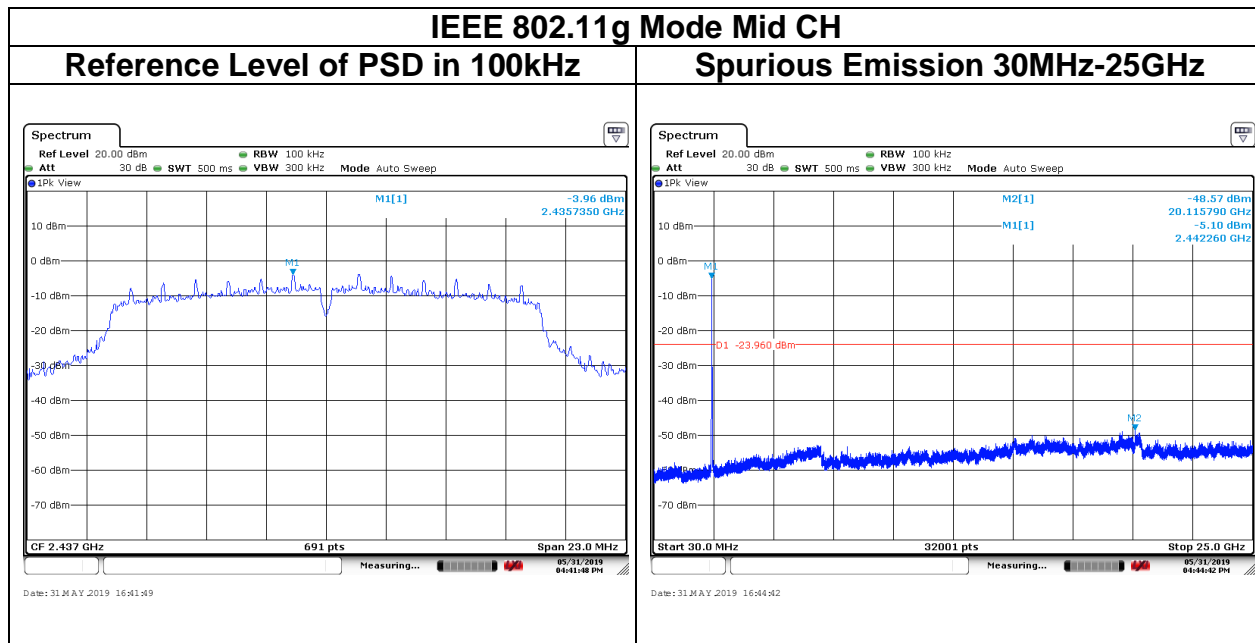

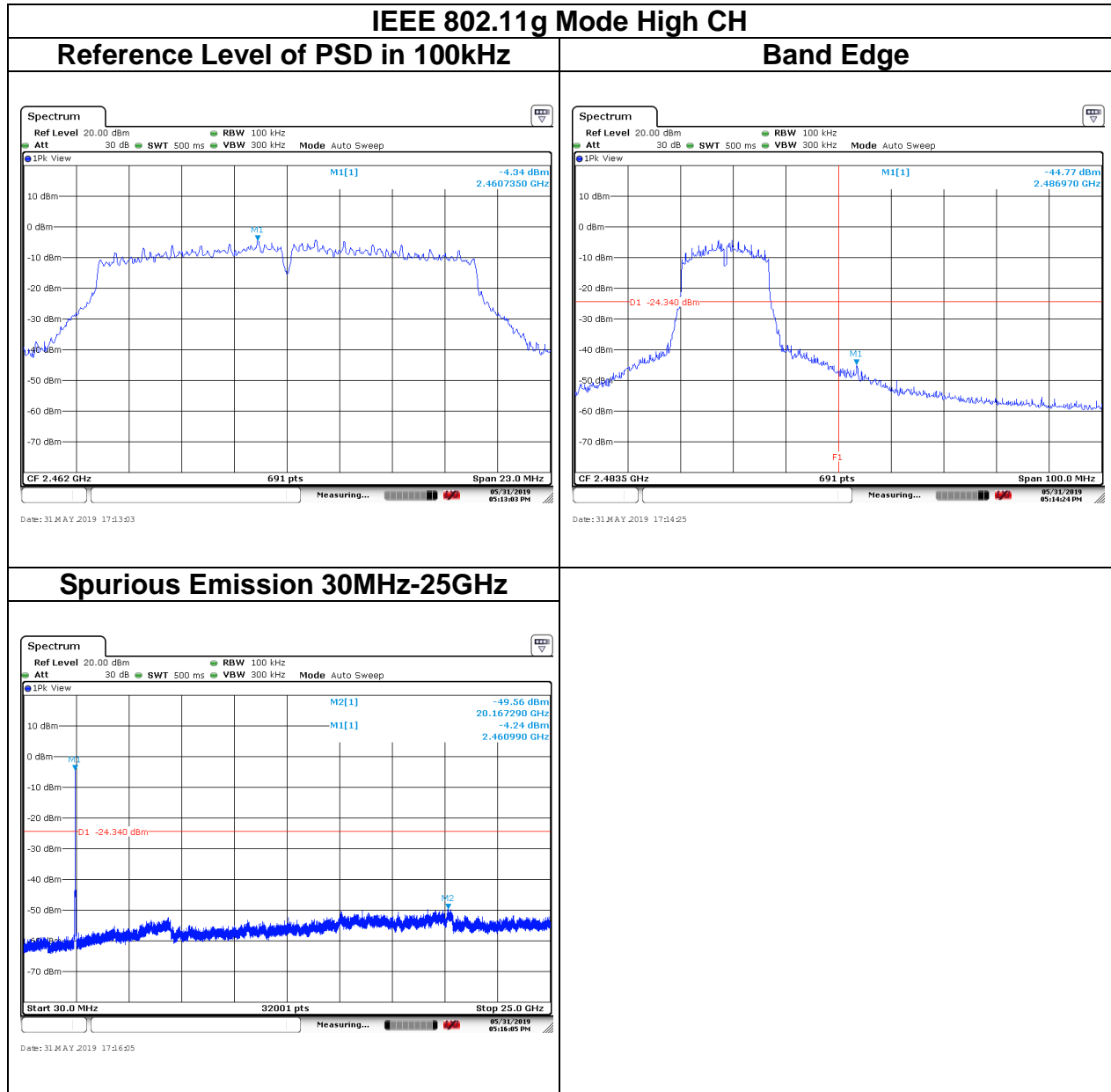

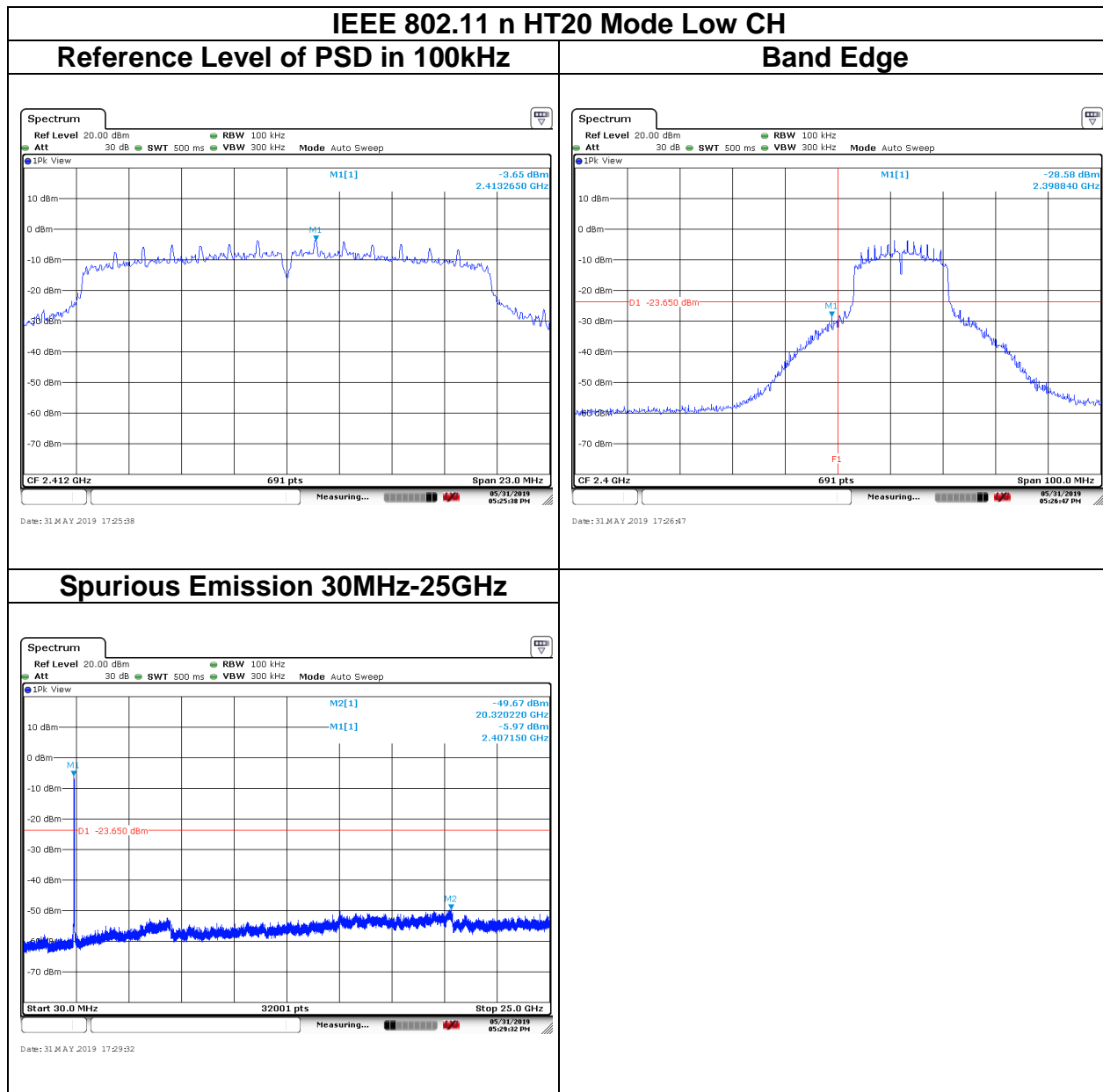

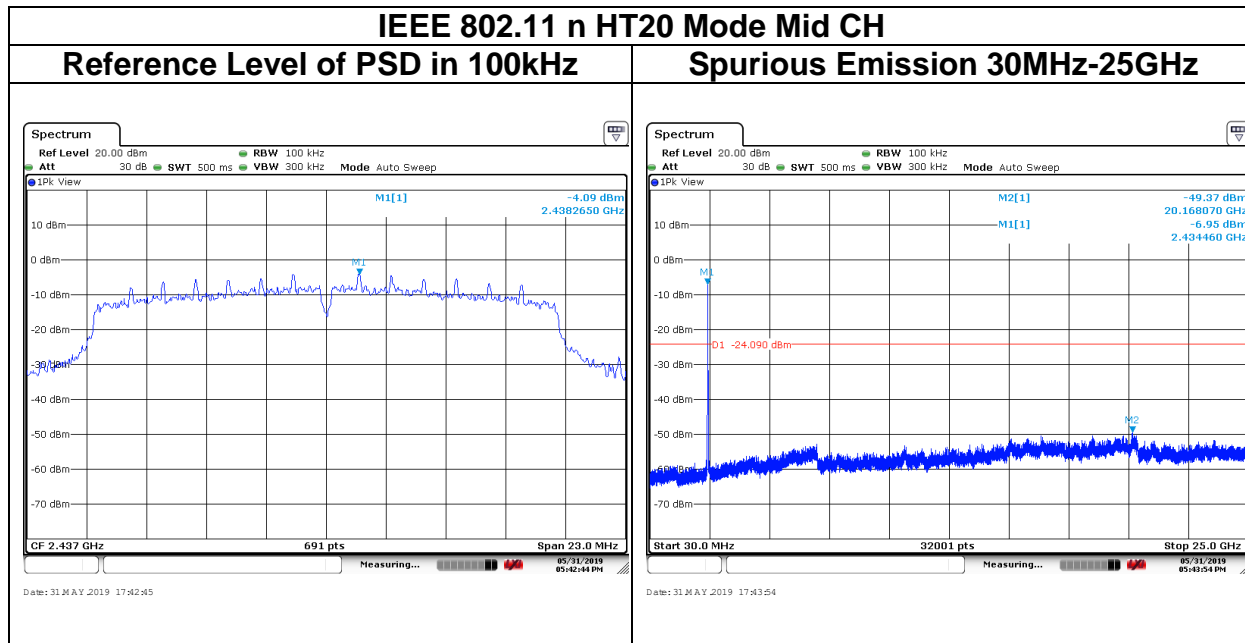

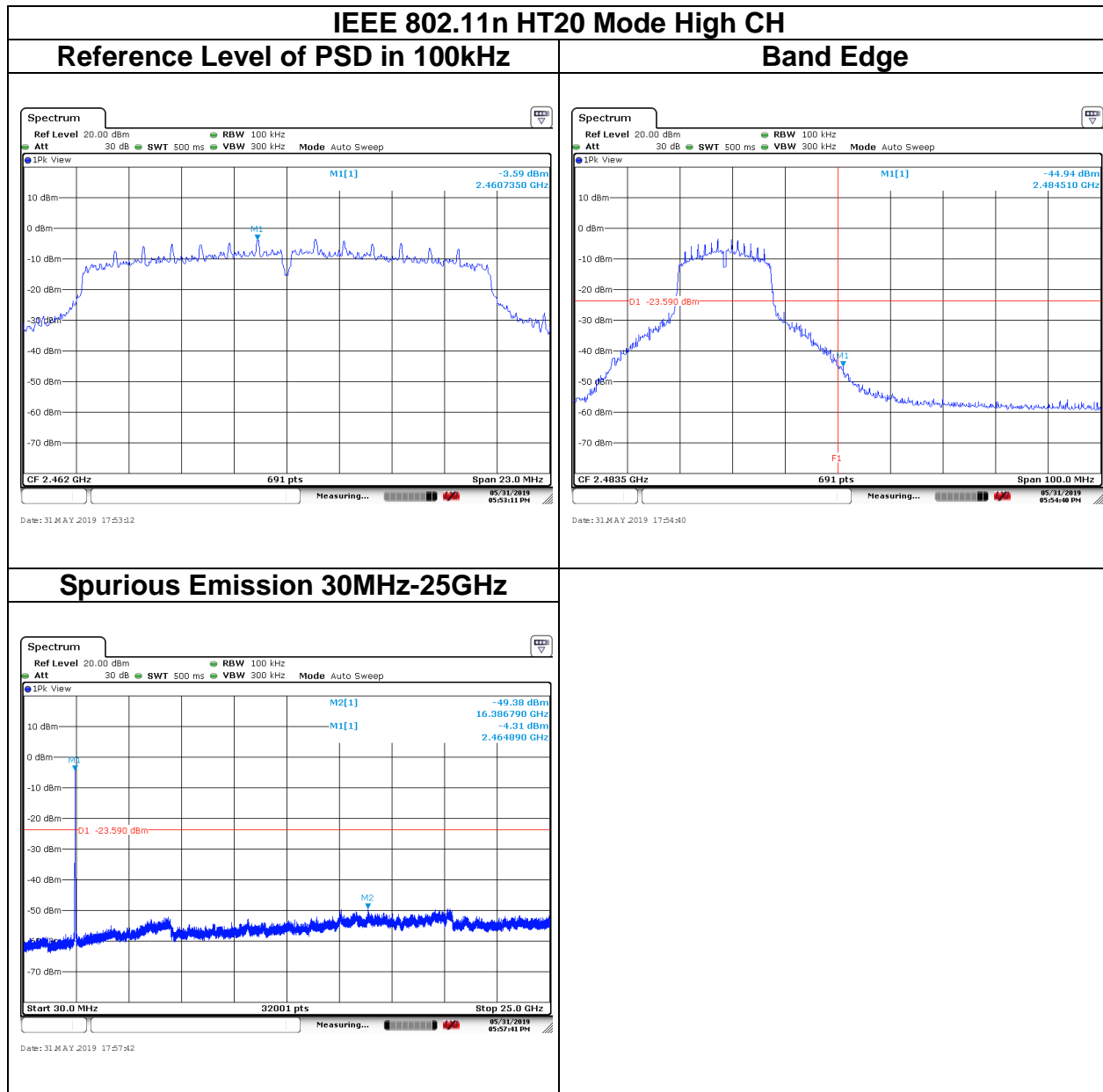

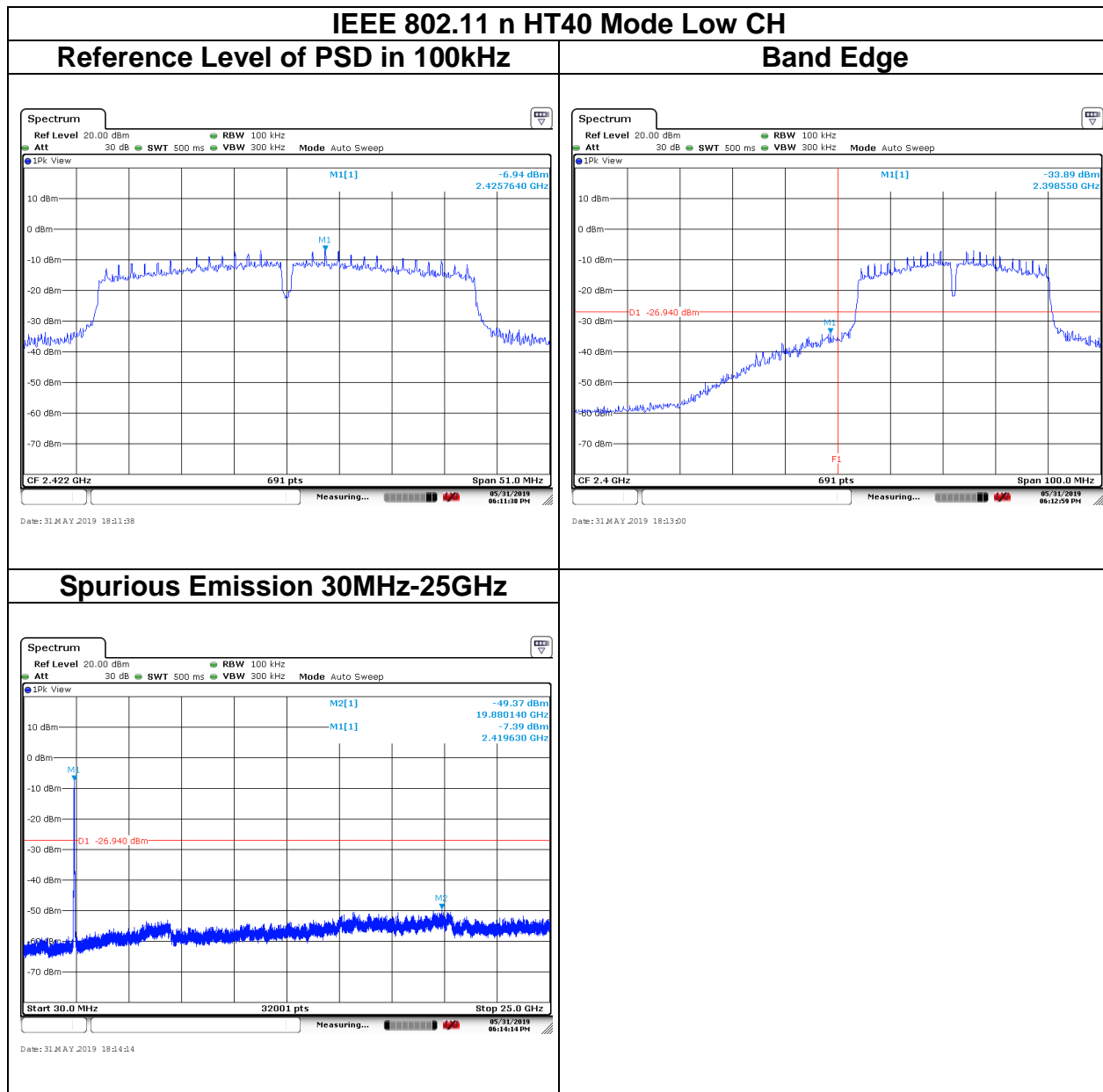

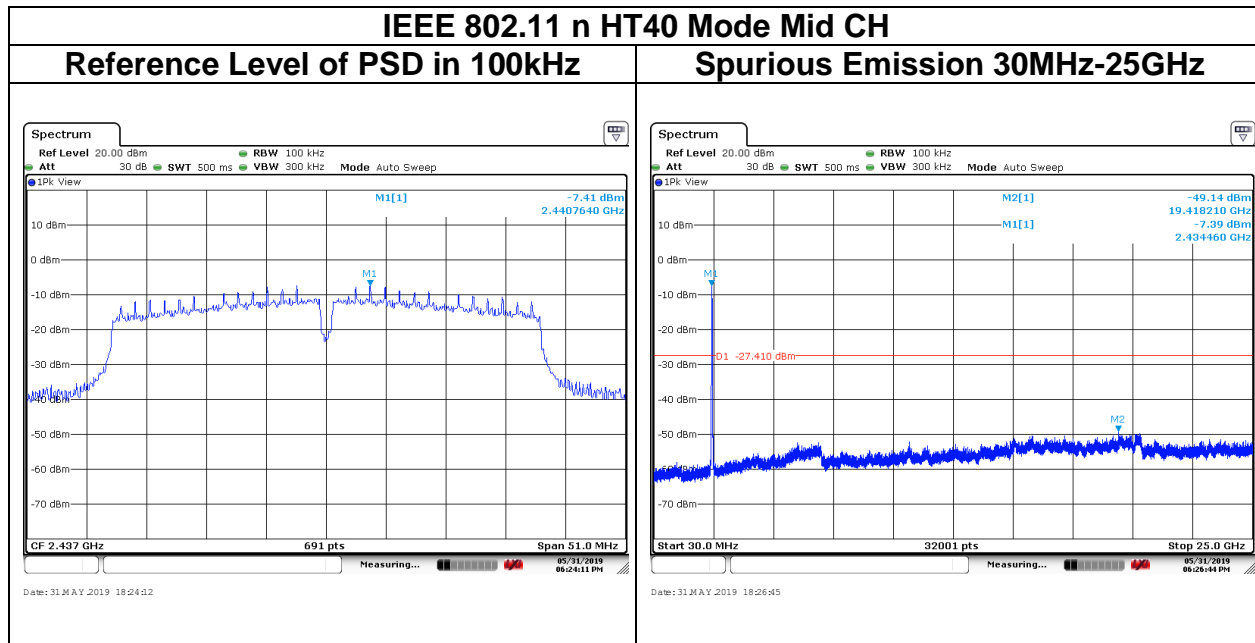



Report No.: T190513D01-RP

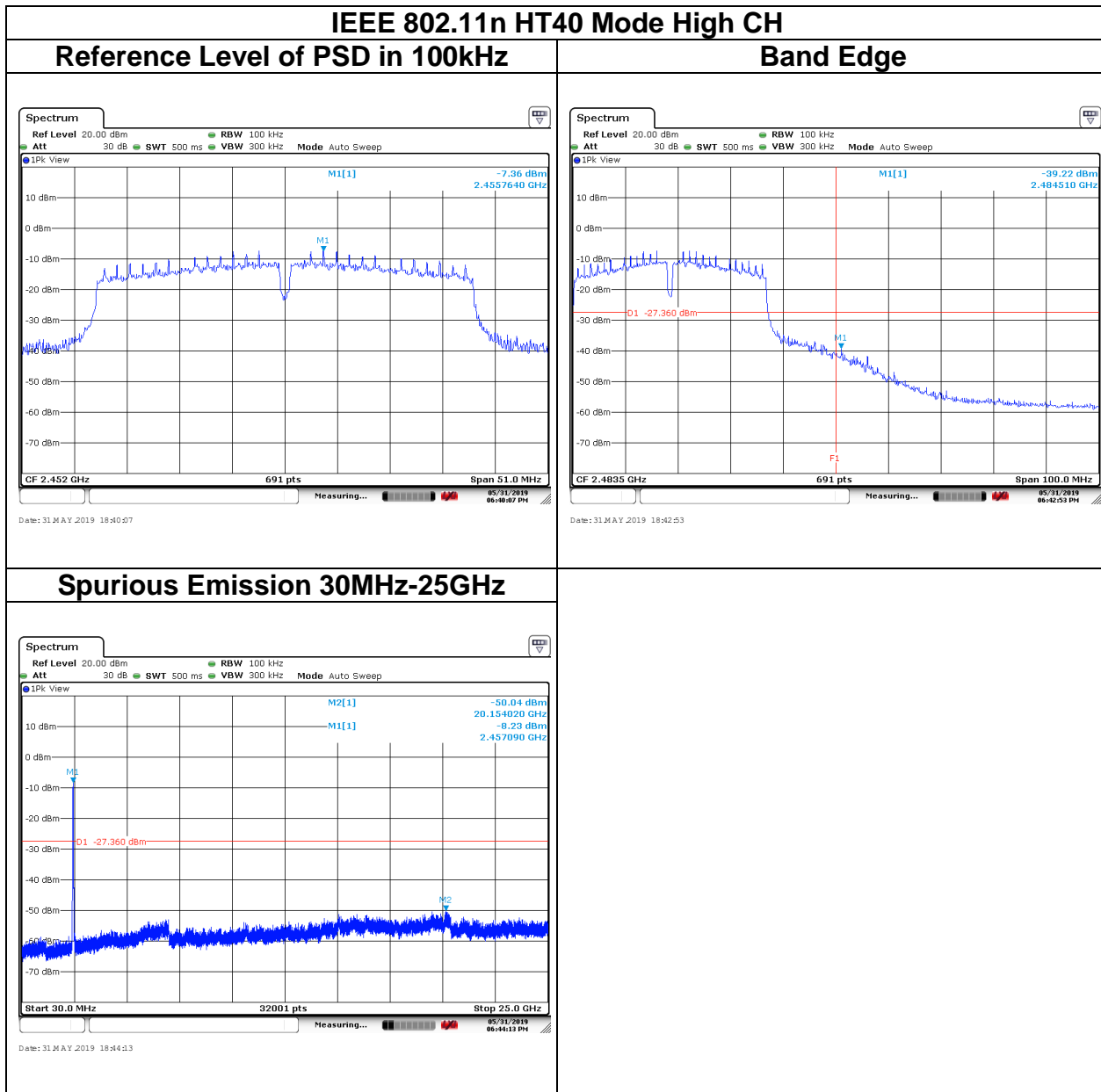

5.6 RADIATION BANDEDGE AND SPURIOUS EMISSION

5.6.1 Test Limit

FCC according to §15.247(d), §15.209 and §15.205,

In any 100 kHz bandwidth outside the authorized frequency band, all harmonic and spurious must be least 20 dB below the highest emission level with the authorized frequency band. Radiation emission which fall in the restricted bands must also follow the FCC section 15.209 as below limit in table.

Below 30 MHz

Frequency	Field Strength (microvolts/m)	Magnetic H-Field (microamperes/m)	Measurement Distance (metres)
9-490 kHz	2,400/F (F in kHz)	2,400/F (F in kHz)	300
490-1,705 kHz	24,000/F (F in kHz)	24,000/F (F in kHz)	30
1.705-30 MHz	30	N/A	30

Above 30 MHz

Frequency	Field Strength (microvolts/m)	Measurement Distance (metres)
30-88	100	3
88-216	150	3
216-960	200	3
Above 960	500	3

Report No.: T190513D01-RP

5.6.2 Test Procedure

Test method Refer as KDB 558074 D01.

1. The EUT is placed on a turntable, Above 1 GHz is 1.5m and below 1 GHz is 0.8m above ground plane. The EUT Configured un accordance with ANSI C63.10: 2013, and the EUT set in a continuous mode.
2. The turntable shall be rotated for 360 degrees to determine the position of maximum emission level. And EUT is set 3m away from the receiving antenna, which is scanned from 1m to 4m above the ground plane to find out the highest emissions. Measurement are made polarized in both the vertical and the horizontal positions with antenna.
3. Span shall wide enough to full capture the emission measured. The SA from 9kHz to 26.5GHz set to the low, Mid and High channels with the EUT transmit.
4. The SA setting following :
 - (1) Below 1G : RBW = 100kHz, VBW \geq 3 RBW, Sweep = Auto, Detector = Peak, Trace = Max hold.
 - (2) Above 1G :
 - (2.1) For Peak measurement : RBW = 1MHz, VBW \geq 3 RBW, Sweep = Auto, Detector = Peak, Trace = Max hold.
 - (2.2) For Average measurement : RBW = 1MHz, VBW
 - If Duty Cycle \geq 98%, VBW=10Hz.
 - If Duty Cycle < 98%, VBW=1/T.

Configuration	Duty Cycle (%)	T(ms)	1/T (kHz)	VBW Setting
802.11b	99.61%	8.4170	-	10Hz
802.11g	91.71%	1.3830	0.723	750Hz
802.11n HT20	94.89%	1.3000	0.769	820Hz
802.11n HT40	82.51%	0.6133	1.631	1.8kHz

Remark:

1. No emission found between lowest internal used/generated frequency to 30MHz (9KHz~30MHz)
2. Although these tests were performed other than open area test site, adequate comparison measurements were confirmed against 30 m open are test site. Therefore sufficient tests were made to demonstrate that the alternative site produces results that correlate with the ones of tests made in an open field based on KDB 414788.

5.6.3 Test Setup

9kHz ~ 30MHz

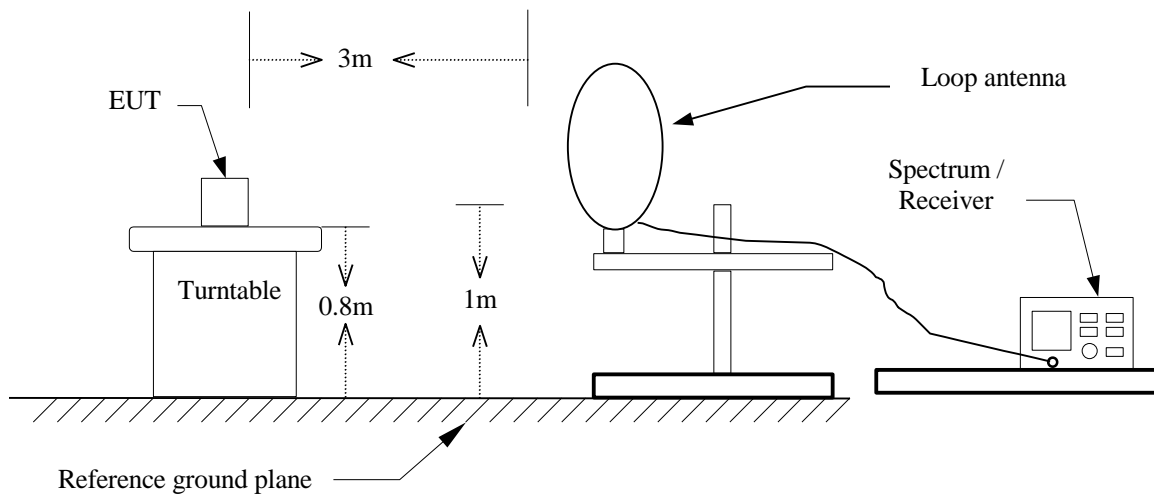

30MHz ~ 1GHz

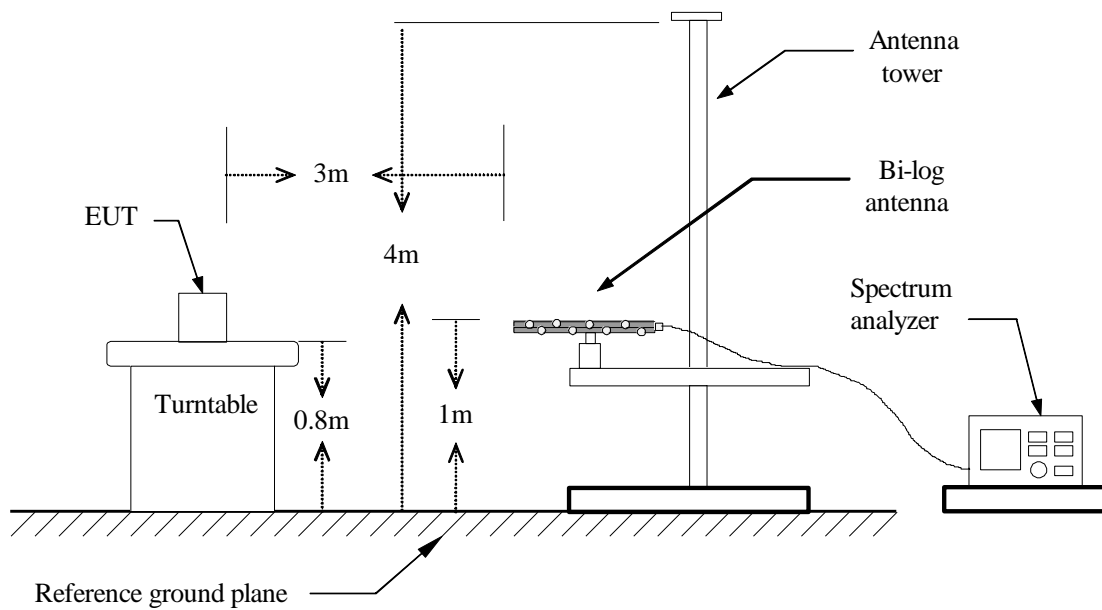

Above 1 GHz

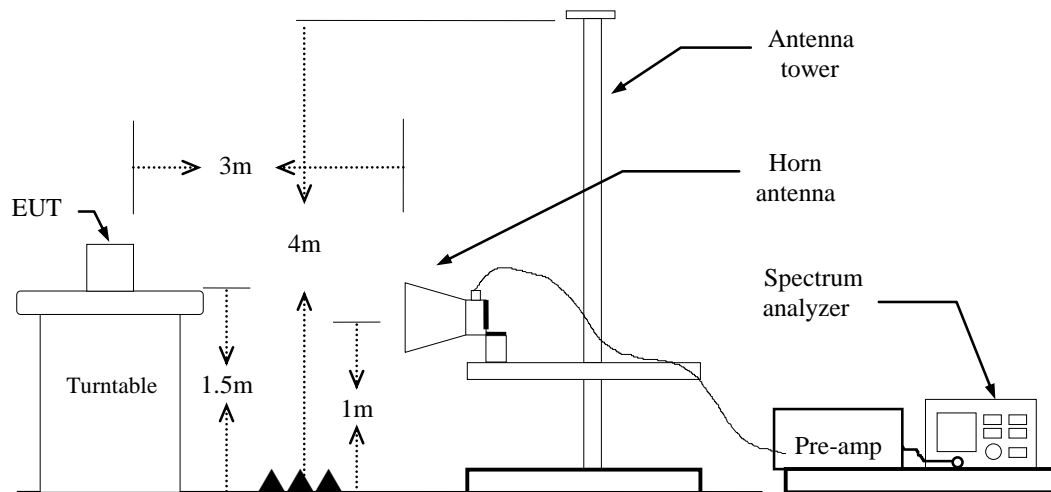

Report No.: T190513D01-RP

5.6.4 Test Result

Band Edge Test Data

Test Mode	IEEE 802.11b Low CH	Temp/Hum	25(°C)/ 53%RH
Test Item	Band Edge	Test Date	June 4, 2019
Polarize	Vertical	Test Engineer	Dally Hong
Detector	Peak & Average		

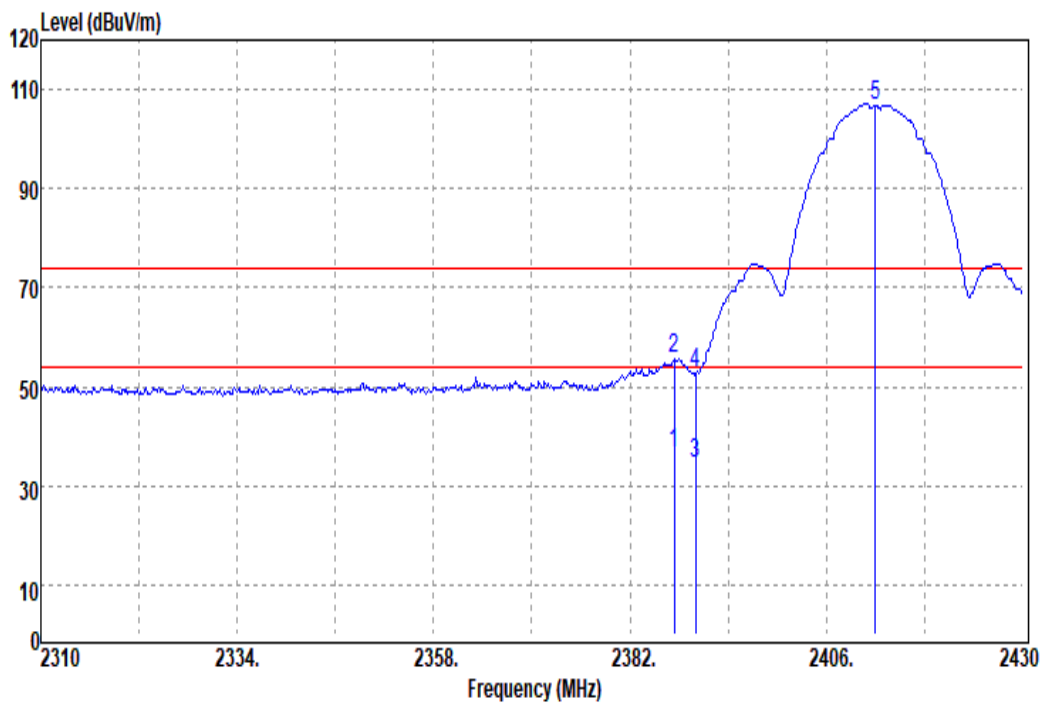

Frequency (MHz)	Reading (dBuV)	Correct Factor (dB/m)	Result (dBuV/m)	Limit (dBuV/m)	Margin (dB)	Remark
2387.40	39.89	-3.38	36.51	54.00	-17.49	Average
2387.40	58.98	-3.38	55.60	74.00	-18.40	Peak
2390.00	38.05	-3.38	34.67	54.00	-19.33	Average
2390.00	56.03	-3.38	52.65	74.00	-21.35	Peak
2412.00	110.21	-3.35	106.86	-	-	Peak

Report No.: T190513D01-RP

Test Mode	IEEE 802.11b High CH	Temp/Hum	25(°C)/ 53%RH
Test Item	Band Edge	Test Date	June 4, 2019
Polarize	Vertical	Test Engineer	Dally Hong
Detector	Peak & Average		

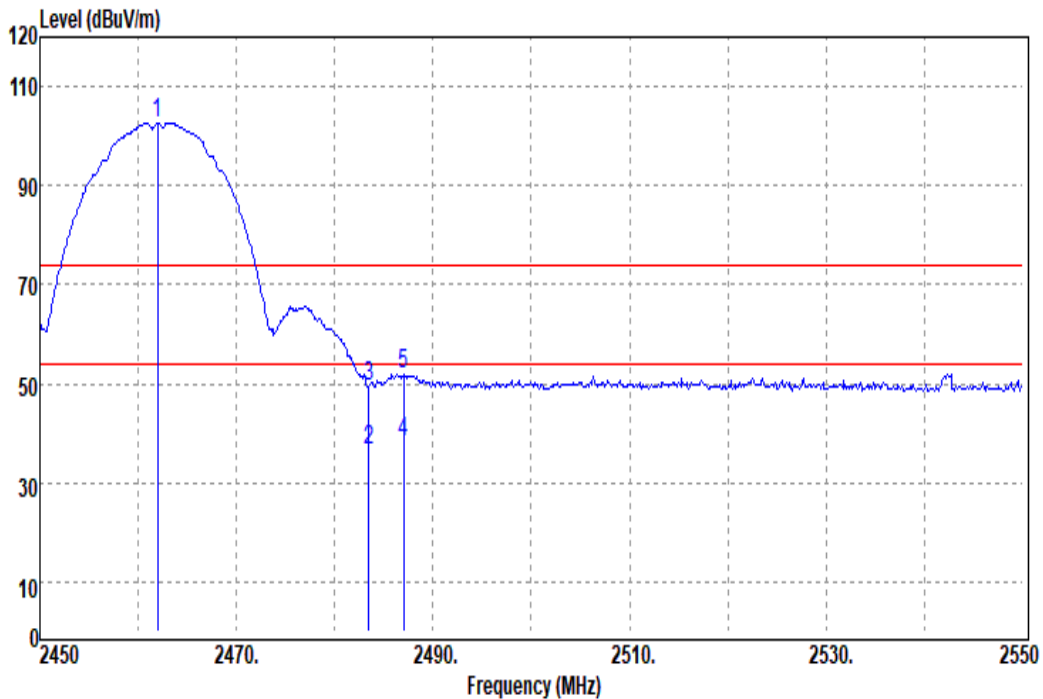

Frequency (MHz)	Reading (dBuV)	Correct Factor (dB/m)	Result (dBuV/m)	Limit (dBuV/m)	Margin (dB)	Remark
2462.00	105.51	-3.03	102.48	-	-	Peak
2483.50	39.36	-2.83	36.53	54.00	-17.47	Average
2483.50	52.18	-2.83	49.35	74.00	-24.65	Peak
2487.00	41.05	-2.80	38.25	54.00	-15.75	Average
2487.00	54.63	-2.80	51.83	74.00	-22.17	Peak

Report No.: T190513D01-RP

Test Mode	IEEE 802.11g Low CH	Temp/Hum	25(°C)/ 53%RH
Test Item	Band Edge	Test Date	June 4, 2019
Polarize	Vertical	Test Engineer	Dally Hong
Detector	Peak & Average		

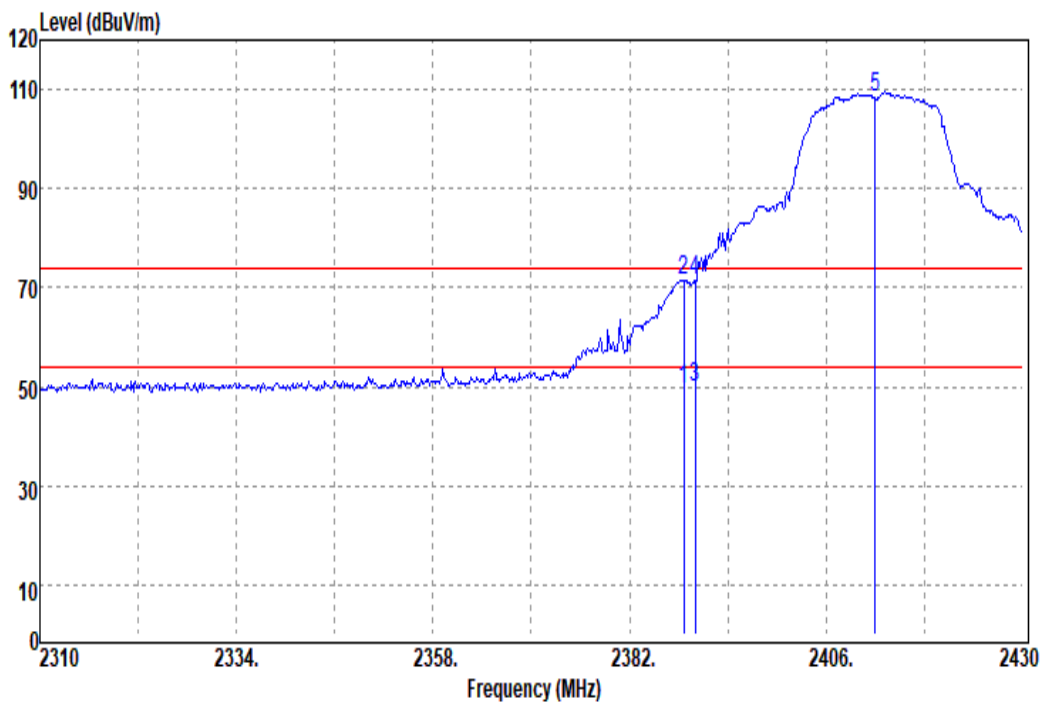

Frequency (MHz)	Reading (dBuV)	Correct Factor (dB/m)	Result (dBuV/m)	Limit (dBuV/m)	Margin (dB)	Remark
2388.60	52.99	-3.39	49.60	54.00	-4.40	Average
2388.60	75.01	-3.39	71.62	74.00	-2.38	Peak
2390.00	53.15	-3.38	49.77	54.00	-4.23	Average
2390.00	74.98	-3.38	71.60	74.00	-2.40	Peak
2412.00	111.62	-3.35	108.27	-	-	Peak

Report No.: T190513D01-RP

Test Mode	IEEE 802.11g High CH	Temp/Hum	25(°C)/ 53%RH
Test Item	Band Edge	Test Date	June 4, 2019
Polarize	Vertical	Test Engineer	Dally Hong
Detector	Peak & Average		

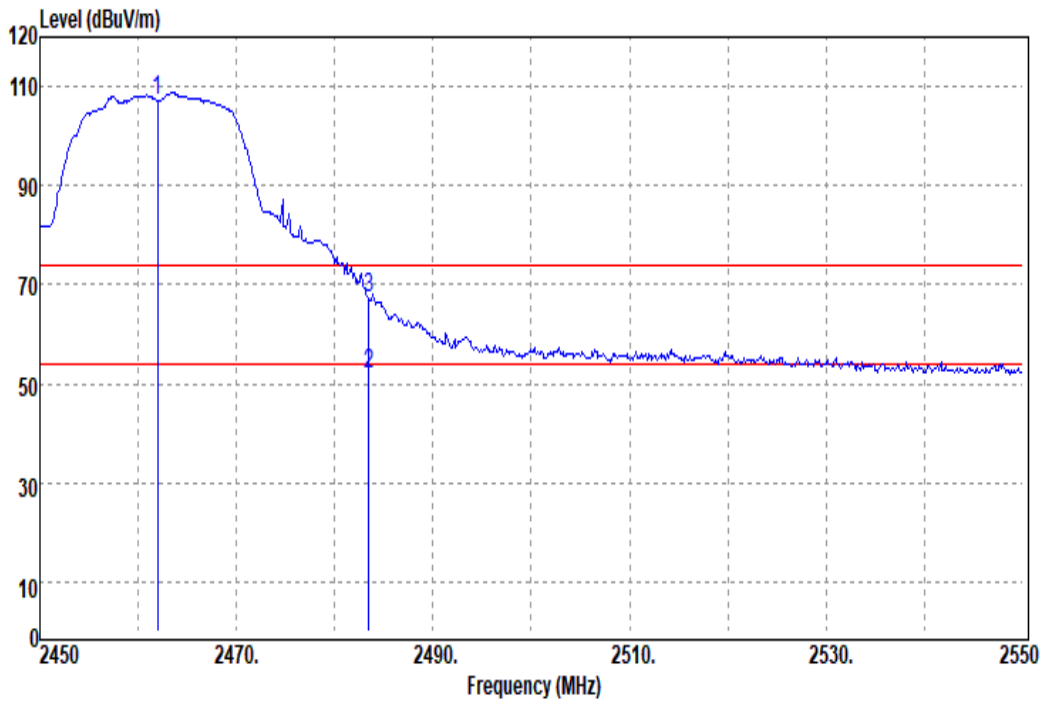

Frequency (MHz)	Reading (dBuV)	Correct Factor (dB/m)	Result (dBuV/m)	Limit (dBuV/m)	Margin (dB)	Remark
2462.00	110.06	-3.03	107.03	-	-	Peak
2483.50	54.54	-2.83	51.71	54.00	-2.29	Average
2483.50	70.09	-2.83	67.26	74.00	-6.74	Peak

Report No.: T190513D01-RP

Test Mode	IEEE 802.11n20 Low CH	Temp/Hum	25(°C)/ 53%RH
Test Item	Band Edge	Test Date	June 4, 2019
Polarize	Vertical	Test Engineer	Dally Hong
Detector	Peak & Average		

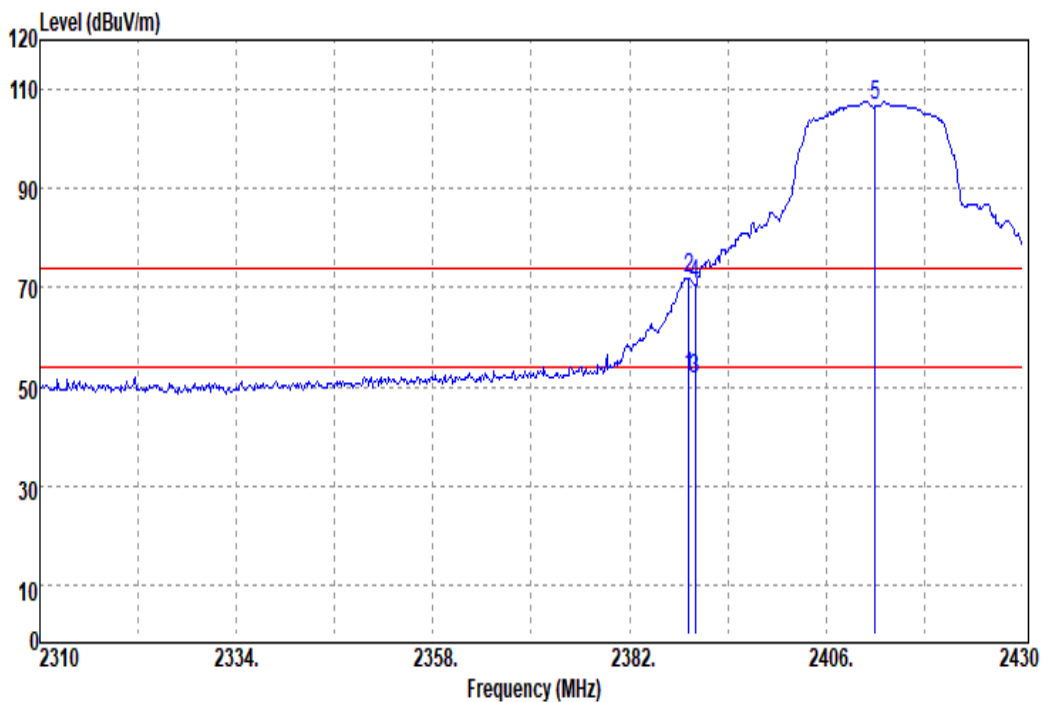

Frequency (MHz)	Reading (dBuV)	Correct Factor (dB/m)	Result (dBuV/m)	Limit (dBuV/m)	Margin (dB)	Remark
2389.20	55.32	-3.39	51.93	54.00	-2.07	Average
2389.20	75.32	-3.39	71.93	74.00	-2.07	Peak
2390.00	54.71	-3.38	51.33	54.00	-2.67	Average
2390.00	74.01	-3.38	70.63	74.00	-3.37	Peak
2412.00	110.15	-3.35	106.80	-	-	Peak

Report No.: T190513D01-RP

Test Mode	IEEE 802.11n20 High CH	Temp/Hum	25(°C)/ 53%RH
Test Item	Band Edge	Test Date	June 4, 2019
Polarize	Vertical	Test Engineer	Dally Hong
Detector	Peak & Average		

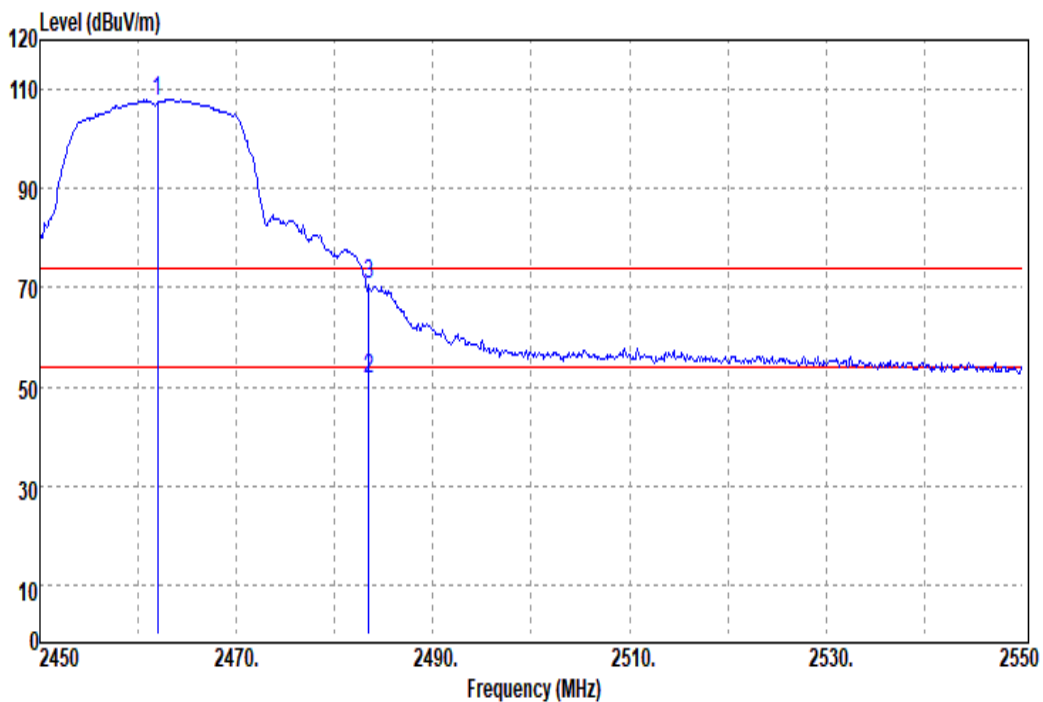

Frequency (MHz)	Reading (dBuV)	Correct Factor (dB/m)	Result (dBuV/m)	Limit (dBuV/m)	Margin (dB)	Remark
2462.00	110.45	-3.03	107.42	-	-	Peak
2483.50	54.16	-2.83	51.33	54.00	-2.67	Average
2483.50	73.30	-2.83	70.47	74.00	-3.53	Peak

Report No.: T190513D01-RP

Test Mode	IEEE 802.11n40 Low CH	Temp/Hum	25(°C)/ 53%RH
Test Item	Band Edge	Test Date	June 4, 2019
Polarize	Vertical	Test Engineer	Dally Hong
Detector	Peak & Average		

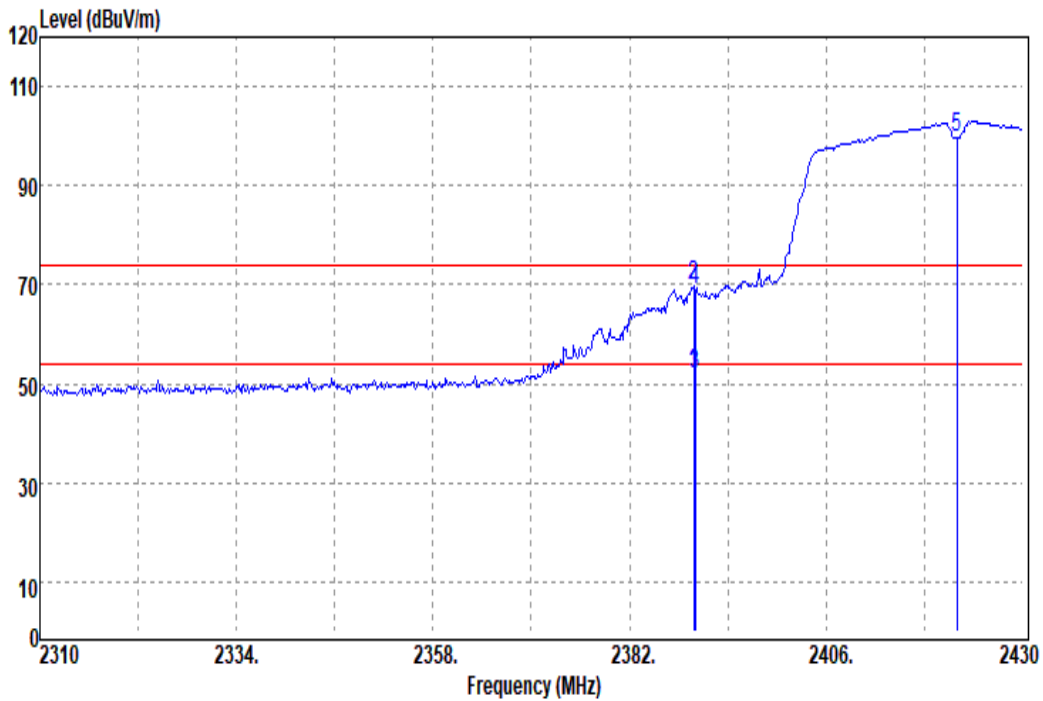

Frequency (MHz)	Reading (dBuV)	Correct Factor (dB/m)	Result (dBuV/m)	Limit (dBuV/m)	Margin (dB)	Remark
2389.80	55.12	-3.39	51.73	54.00	-2.27	Average
2389.80	72.94	-3.39	69.55	74.00	-4.45	Peak
2390.00	55.36	-3.38	51.98	54.00	-2.02	Average
2390.00	72.51	-3.38	69.13	74.00	-4.87	Peak
2422.00	102.79	-3.31	99.48	-	-	Peak

Report No.: T190513D01-RP

Test Mode	IEEE 802.11n40 High CH	Temp/Hum	25(°C)/ 53%RH
Test Item	Band Edge	Test Date	June 4, 2019
Polarize	Vertical	Test Engineer	Dally Hong
Detector	Peak & Average		

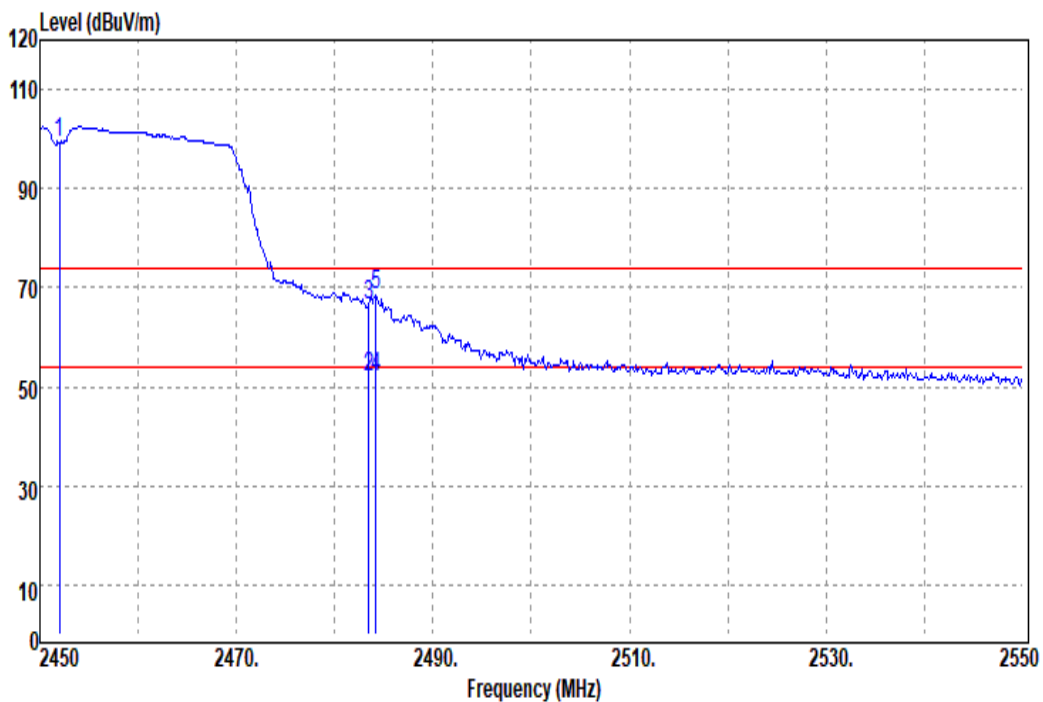

Frequency (MHz)	Reading (dBuV)	Correct Factor (dB/m)	Result (dBuV/m)	Limit (dBuV/m)	Margin (dB)	Remark
2452.00	102.25	-3.13	99.12	-	-	Peak
2483.50	54.81	-2.83	51.98	54.00	-2.02	Average
2483.50	69.40	-2.83	66.57	74.00	-7.43	Peak
2484.20	54.86	-2.82	52.04	54.00	-1.96	Average
2484.20	71.35	-2.82	68.53	74.00	-5.47	Peak

Report No.: T190513D01-RP

Below 1G Test Data

Test Mode	Mode 1	Temp/Hum	25(°C)/ 53%RH
Test Item	30MHz-1GHz	Test Date	July 23, 2019
Polarize	Vertical	Test Engineer	Jerry
Detector	Peak		

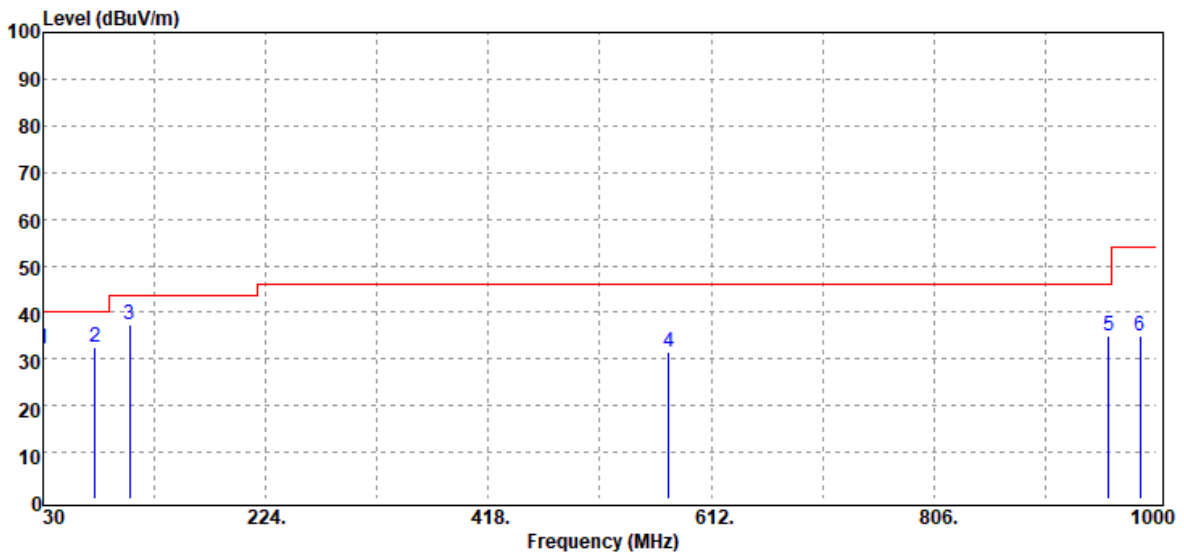

Frequency (MHz)	Reading (dBuV)	Correct Factor (dB/m)	Result (dBuV/m)	Limit (dBuV/m)	Margin (dB)	Remark
30.00	33.84	-1.51	32.33	40.00	-7.67	peak
75.59	47.40	-14.79	32.61	40.00	-7.39	peak
105.66	48.45	-11.02	37.43	43.50	-6.07	peak
575.14	33.45	-1.79	31.66	46.00	-14.34	peak
958.29	30.68	4.42	35.10	46.00	-10.90	peak
985.45	29.40	5.38	34.78	54.00	-19.22	peak

Note: No emission found between lowest internal used/generated frequency to 30MHz(9KHz~30MHz)

Report No.: T190513D01-RP

Test Mode	Mode 1	Temp/Hum	25(°C)/ 53%RH
Test Item	30MHz-1GHz	Test Date	July 23, 2019
Polarize	Horizontal	Test Engineer	Jerry
Detector	Peak		

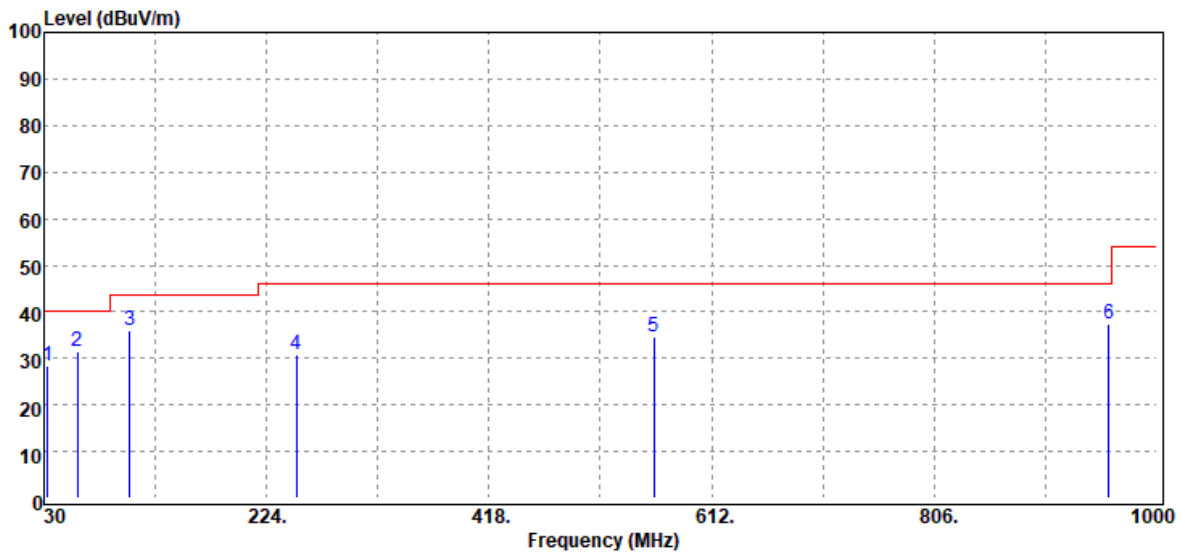

Frequency (MHz)	Reading (dBuV)	Correct Factor (dB/m)	Result (dBuV/m)	Limit (dBuV/m)	Margin (dB)	Remark
32.91	32.52	-4.28	28.24	40.00	-11.76	peak
59.10	47.28	-15.96	31.32	40.00	-8.68	peak
104.69	47.34	-11.18	36.16	43.50	-7.34	peak
250.19	41.06	-10.40	30.66	46.00	-15.34	peak
561.56	36.86	-2.20	34.66	46.00	-11.34	peak
958.29	32.81	4.42	37.23	46.00	-8.77	peak

Note: No emission found between lowest internal used/generated frequency to 30MHz(9KHz~30MHz)

Report No.: T190513D01-RP

Above 1G Test Data

Test Mode	IEEE 802.11b Low CH	Temp/Hum	25(°C)/ 53%RH
Test Item	Harmonic	Test Date	June 4, 2019
Polarize	Vertical	Test Engineer	Dally Hong
Detector	Peak		

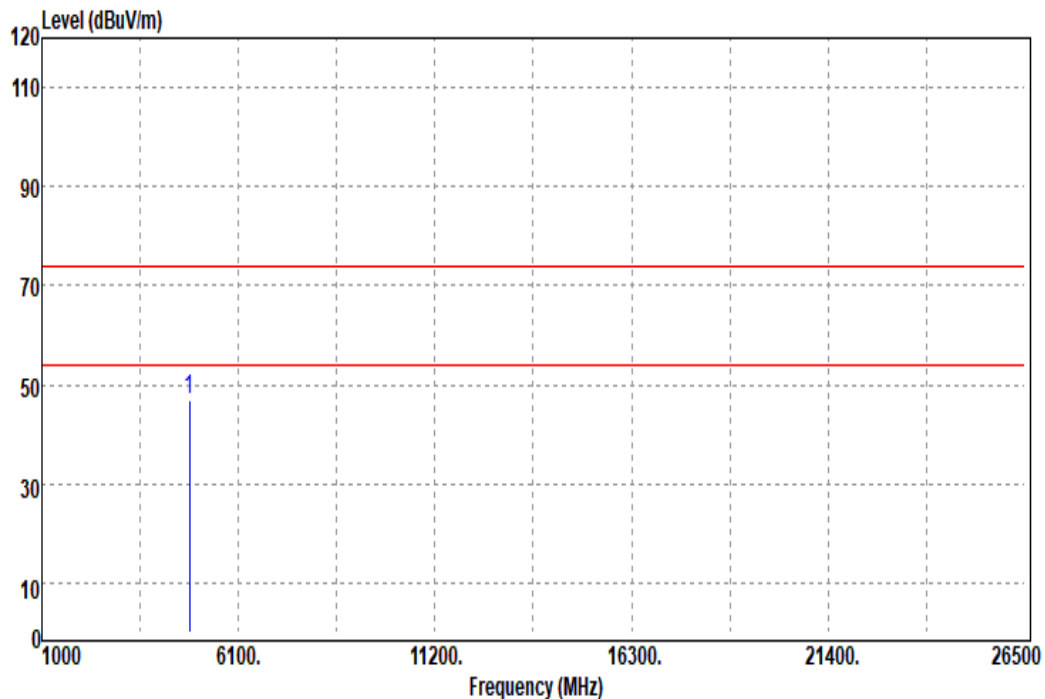

Frequency (MHz)	Reading (dBuV)	Correct Factor (dB/m)	Result (dBuV/m)	Limit (dBuV/m)	Margin (dB)	Remark
4824.00	44.05	2.84	46.89	74.00	-27.11	peak
N/A						

Remark:

1. Measuring frequencies from 1 GHz to the 10th harmonic of highest fundamental frequency.
2. For above 1GHz, the EUT peak value was under average limit, therefore the Average value compliance with the average limit

Test Mode	IEEE 802.11b Low CH	Temp/Hum	25(°C)/ 53%RH
Test Item	Harmonic	Test Date	June 4, 2019
Polarize	Horizontal	Test Engineer	Dally Hong
Detector	Peak		

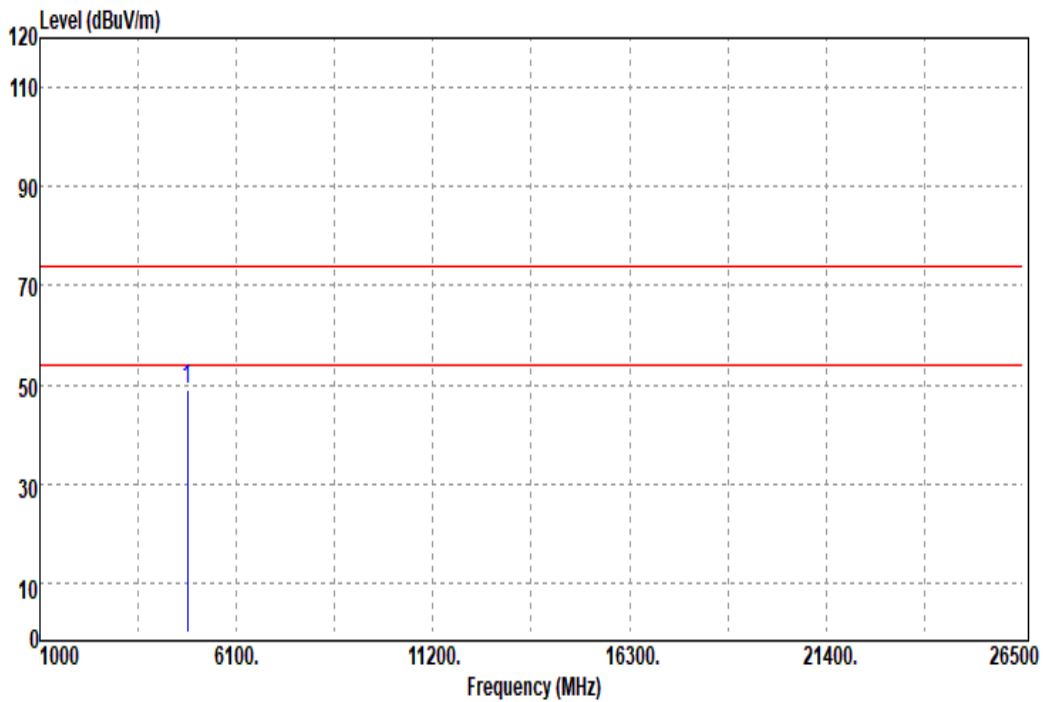

Frequency (MHz)	Reading (dBuV)	Correct Factor (dB/m)	Result (dBuV/m)	Limit (dBuV/m)	Margin (dB)	Remark
4824.00	46.15	2.84	48.99	74.00	-25.01	peak
N/A						

Remark:

1. Measuring frequencies from 1 GHz to the 10th harmonic of highest fundamental frequency.
2. For above 1GHz, the EUT peak value was under average limit, therefore the Average value compliance with the average limit

Report No.: T190513D01-RP

Test Mode	IEEE 802.11b Mid CH	Temp/Hum	25(°C)/ 53%RH
Test Item	Harmonic	Test Date	June 4, 2019
Polarize	Vertical	Test Engineer	Dally Hong
Detector	Peak		

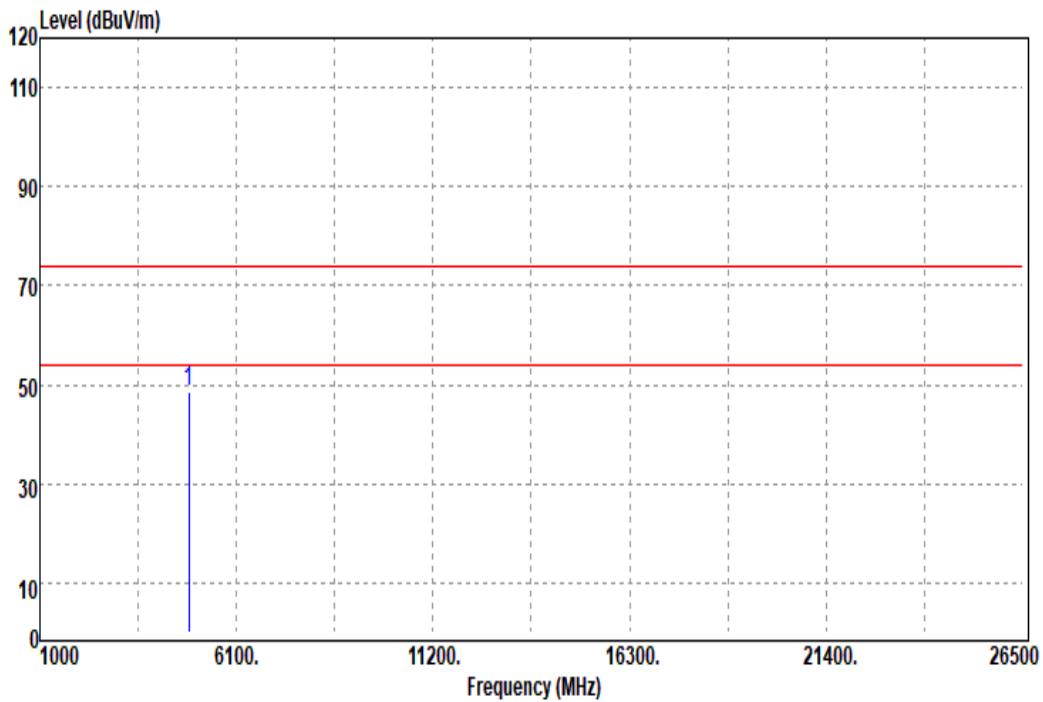

Frequency (MHz)	Reading (dBuV)	Correct Factor (dB/m)	Result (dBuV/m)	Limit (dBuV/m)	Margin (dB)	Remark
4874.00	45.79	2.98	48.77	74.00	-25.23	peak
N/A						

Remark:

1. Measuring frequencies from 1 GHz to the 10th harmonic of highest fundamental frequency.
2. For above 1GHz, the EUT peak value was under average limit, therefore the Average value compliance with the average limit

Test Mode	IEEE 802.11b Mid CH	Temp/Hum	25(°C)/ 53%RH
Test Item	Harmonic	Test Date	June 4, 2019
Polarize	Horizontal	Test Engineer	Dally Hong
Detector	Peak		

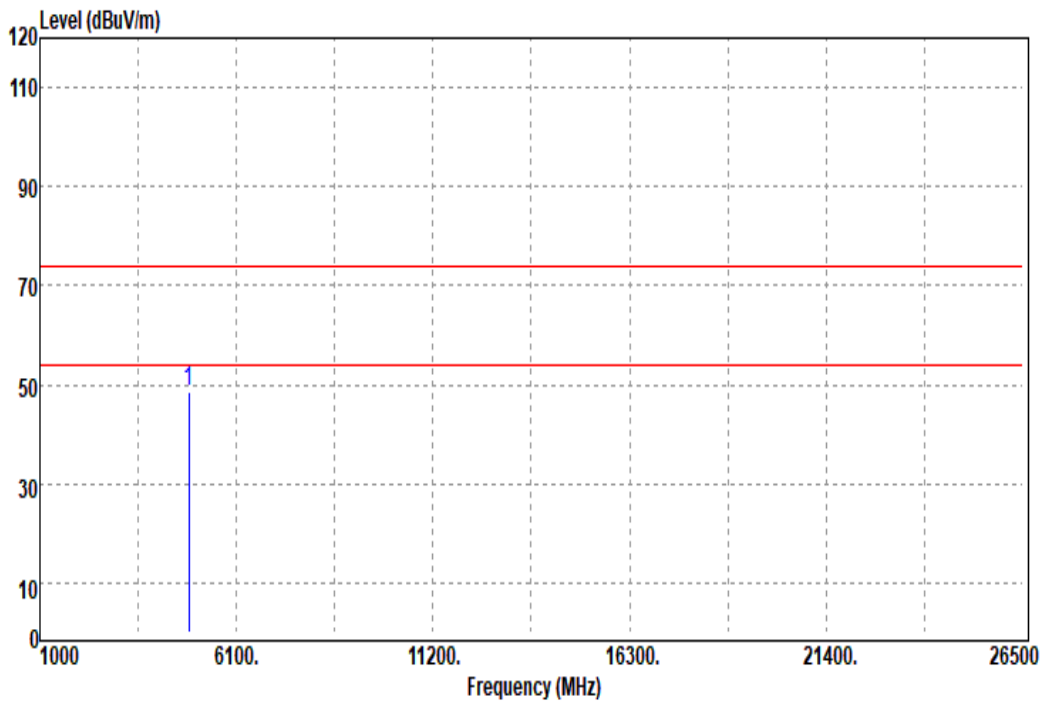

Frequency (MHz)	Reading (dBuV)	Correct Factor (dB/m)	Result (dBuV/m)	Limit (dBuV/m)	Margin (dB)	Remark
4874.00	45.60	2.98	48.58	74.00	-25.42	peak
N/A						

Remark:

1. Measuring frequencies from 1 GHz to the 10th harmonic of highest fundamental frequency.
2. For above 1GHz, the EUT peak value was under average limit, therefore the Average value compliance with the average limit

Report No.: T190513D01-RP

Test Mode	IEEE 802.11b High CH	Temp/Hum	25(°C)/ 53%RH
Test Item	Harmonic	Test Date	June 4, 2019
Polarize	Vertical	Test Engineer	Dally Hong
Detector	Peak		

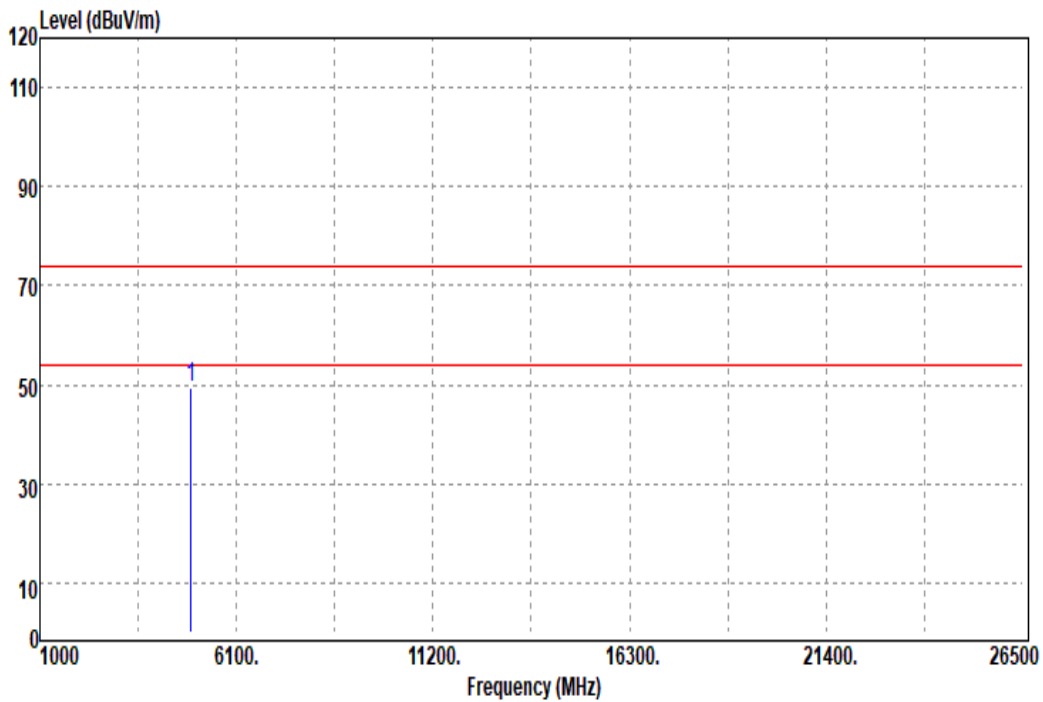

Frequency (MHz)	Reading (dBuV)	Correct Factor (dB/m)	Result (dBuV/m)	Limit (dBuV/m)	Margin (dB)	Remark
4924.00	45.99	3.46	49.45	74.00	-24.55	peak
N/A						

Remark:

1. Measuring frequencies from 1 GHz to the 10th harmonic of highest fundamental frequency.
2. For above 1GHz, the EUT peak value was under average limit, therefore the Average value compliance with the average limit

Test Mode	IEEE 802.11b High CH	Temp/Hum	25(°C)/ 53%RH
Test Item	Harmonic	Test Date	June 4, 2019
Polarize	Horizontal	Test Engineer	Dally Hong
Detector	Peak		

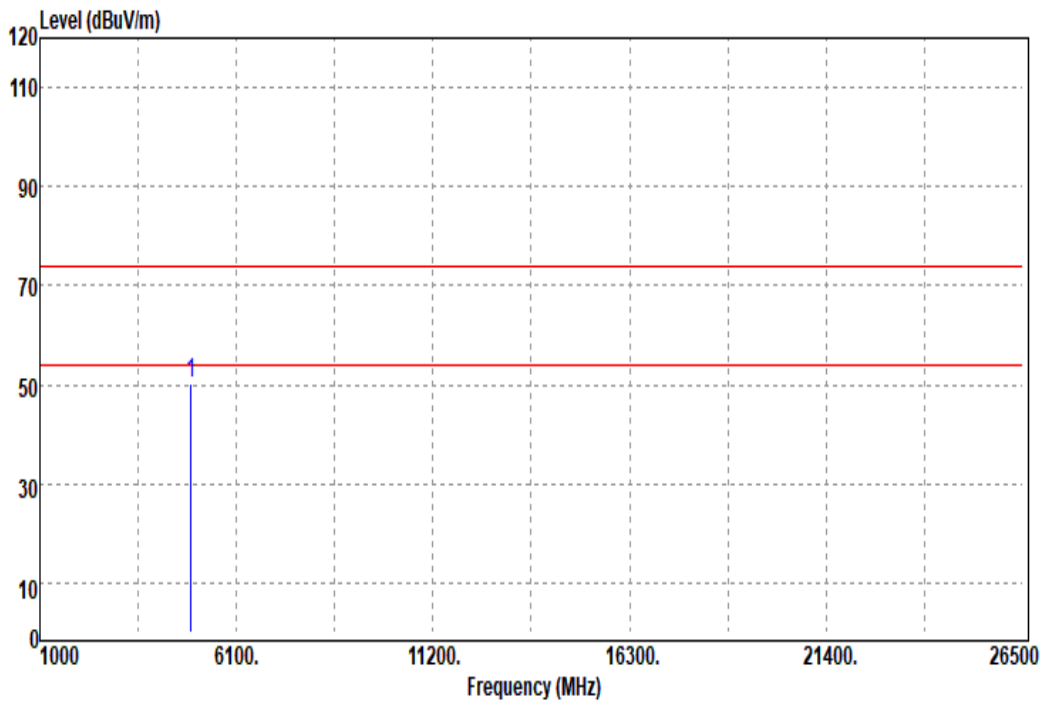

Frequency (MHz)	Reading (dBuV)	Correct Factor (dB/m)	Result (dBuV/m)	Limit (dBuV/m)	Margin (dB)	Remark
4924.00	46.91	3.46	50.37	74.00	-23.63	peak
N/A						

Remark:

1. Measuring frequencies from 1 GHz to the 10th harmonic of highest fundamental frequency.
2. For above 1GHz, the EUT peak value was under average limit, therefore the Average value compliance with the average limit

Test Mode	IEEE 802.11g Low CH	Temp/Hum	25(°C)/ 53%RH
Test Item	Harmonic	Test Date	June 4, 2019
Polarize	Vertical	Test Engineer	Dally Hong
Detector	Peak		

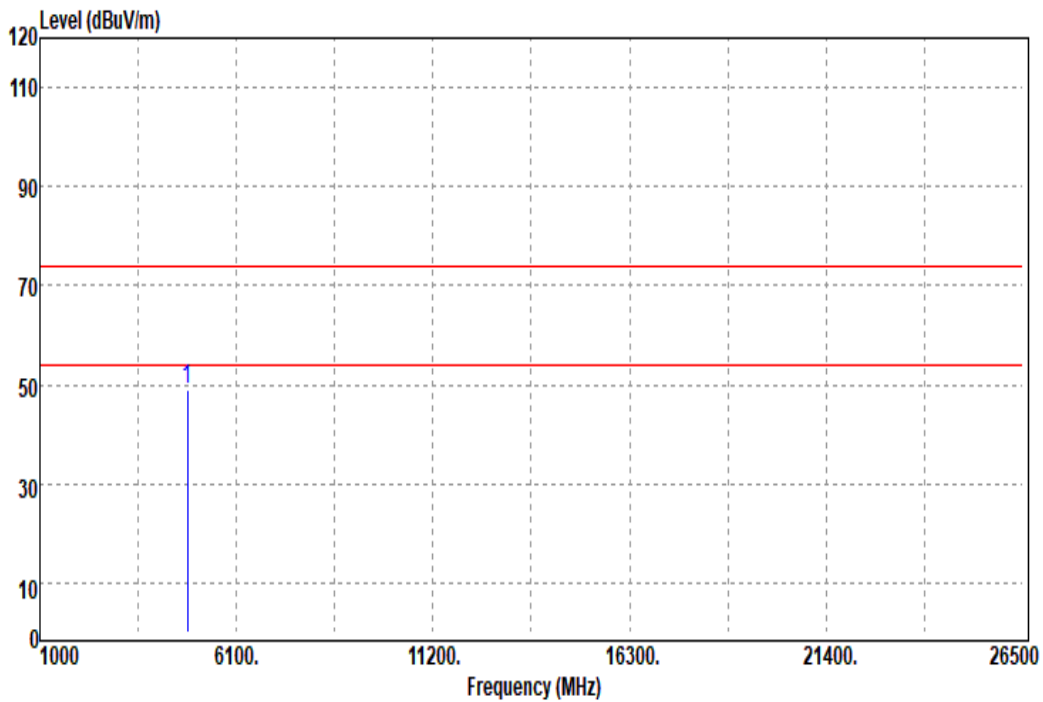

Frequency (MHz)	Reading (dBuV)	Correct Factor (dB/m)	Result (dBuV/m)	Limit (dBuV/m)	Margin (dB)	Remark
4824.00	46.05	2.84	48.89	74.00	-25.11	peak
N/A						

Remark:

1. Measuring frequencies from 1 GHz to the 10th harmonic of highest fundamental frequency.
2. For above 1GHz, the EUT peak value was under average limit, therefore the Average value compliance with the average limit

Test Mode	IEEE 802.11g Low CH	Temp/Hum	25(°C)/ 53%RH
Test Item	Harmonic	Test Date	June 4, 2019
Polarize	Horizontal	Test Engineer	Dally Hong
Detector	Peak		

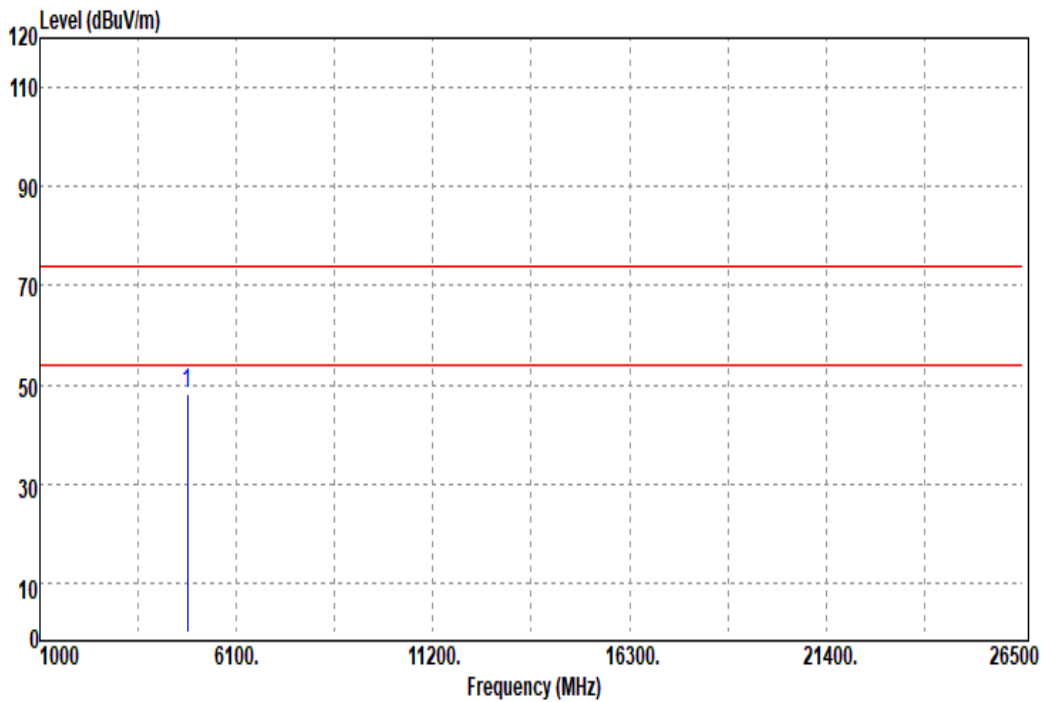

Frequency (MHz)	Reading (dBuV)	Correct Factor (dB/m)	Result (dBuV/m)	Limit (dBuV/m)	Margin (dB)	Remark
4824.00	45.37	2.84	48.21	74.00	-25.79	peak
N/A						

Remark:

1. Measuring frequencies from 1 GHz to the 10th harmonic of highest fundamental frequency.
2. For above 1GHz, the EUT peak value was under average limit, therefore the Average value compliance with the average limit

Test Mode	IEEE 802.11g Mid CH	Temp/Hum	25(°C)/ 53%RH
Test Item	Harmonic	Test Date	June 4, 2019
Polarize	Vertical	Test Engineer	Dally Hong
Detector	Peak		

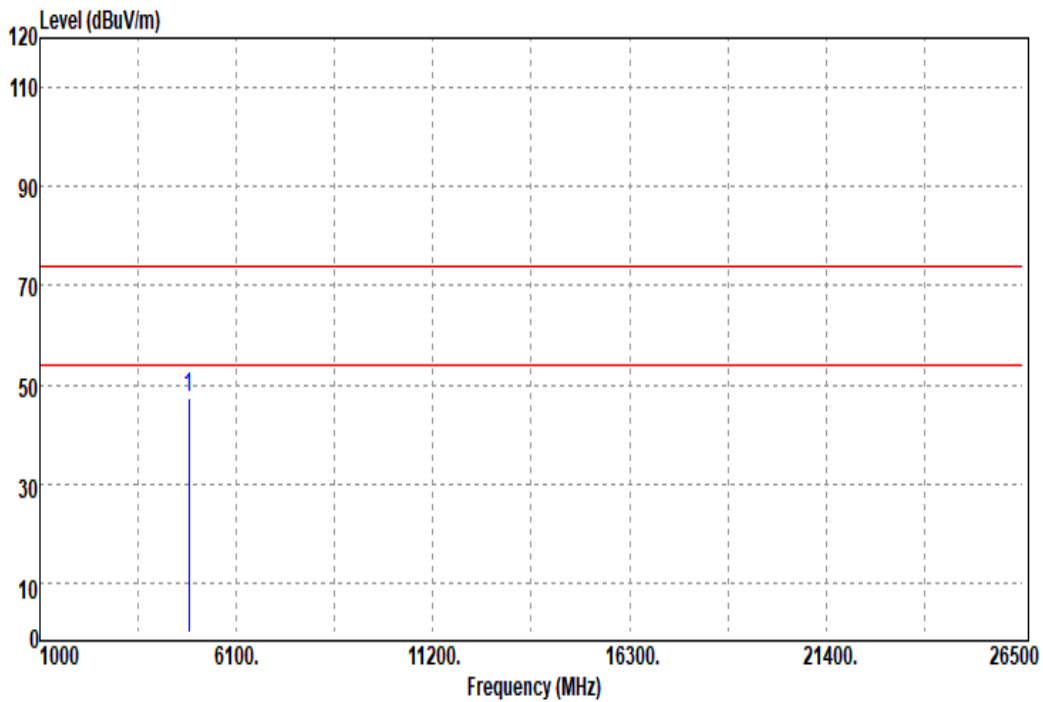

Frequency (MHz)	Reading (dBuV)	Correct Factor (dB/m)	Result (dBuV/m)	Limit (dBuV/m)	Margin (dB)	Remark
4874.00	44.32	2.98	47.30	74.00	-26.70	peak
N/A						

Remark:

1. Measuring frequencies from 1 GHz to the 10th harmonic of highest fundamental frequency.
2. For above 1GHz, the EUT peak value was under average limit, therefore the Average value compliance with the average limit

Test Mode	IEEE 802.11g Mid CH	Temp/Hum	25(°C)/ 53%RH
Test Item	Harmonic	Test Date	June 4, 2019
Polarize	Horizontal	Test Engineer	Dally Hong
Detector	Peak		

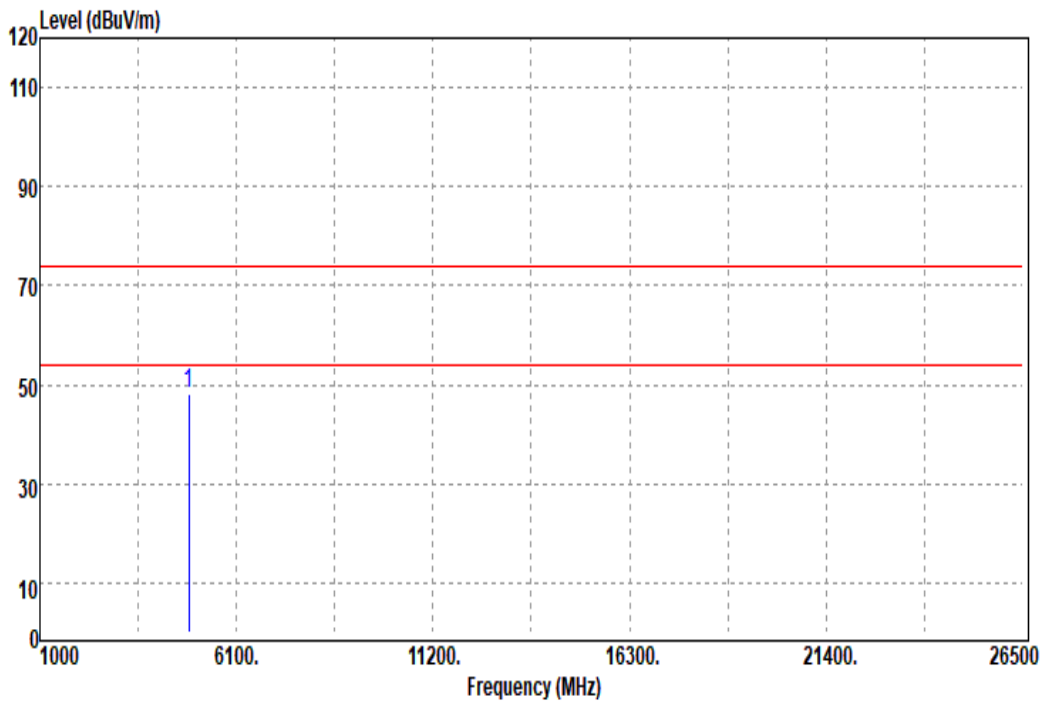

Frequency (MHz)	Reading (dBuV)	Correct Factor (dB/m)	Result (dBuV/m)	Limit (dBuV/m)	Margin (dB)	Remark
4874.00	45.07	2.98	48.05	74.00	-25.95	peak
N/A						

Remark:

1. Measuring frequencies from 1 GHz to the 10th harmonic of highest fundamental frequency.
2. For above 1GHz, the EUT peak value was under average limit, therefore the Average value compliance with the average limit

Test Mode	IEEE 802.11g High CH	Temp/Hum	25(°C)/ 53%RH
Test Item	Harmonic	Test Date	June 4, 2019
Polarize	Vertical	Test Engineer	Dally Hong
Detector	Peak		

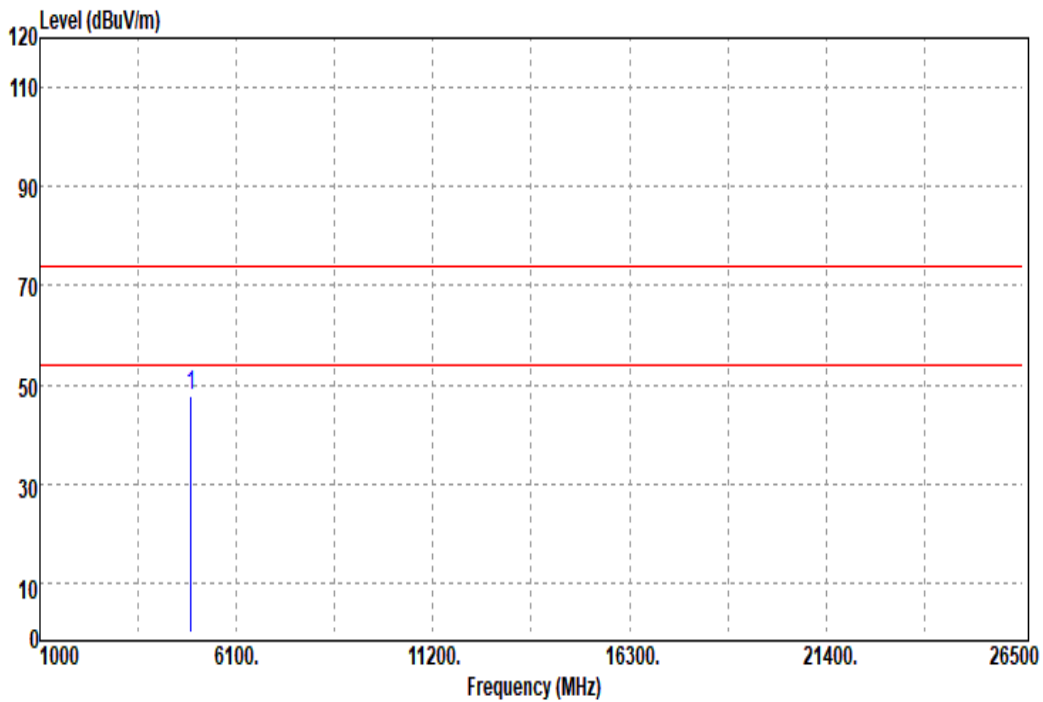

Frequency (MHz)	Reading (dBuV)	Correct Factor (dB/m)	Result (dBuV/m)	Limit (dBuV/m)	Margin (dB)	Remark
4924.00	44.33	3.46	47.79	74.00	-26.21	peak
N/A						

Remark:

1. Measuring frequencies from 1 GHz to the 10th harmonic of highest fundamental frequency.
2. For above 1GHz, the EUT peak value was under average limit, therefore the Average value compliance with the average limit

Report No.: T190513D01-RP

Test Mode	IEEE 802.11g High CH	Temp/Hum	25(°C)/ 53%RH
Test Item	Harmonic	Test Date	June 4, 2019
Polarize	Horizontal	Test Engineer	Dally Hong
Detector	Peak		

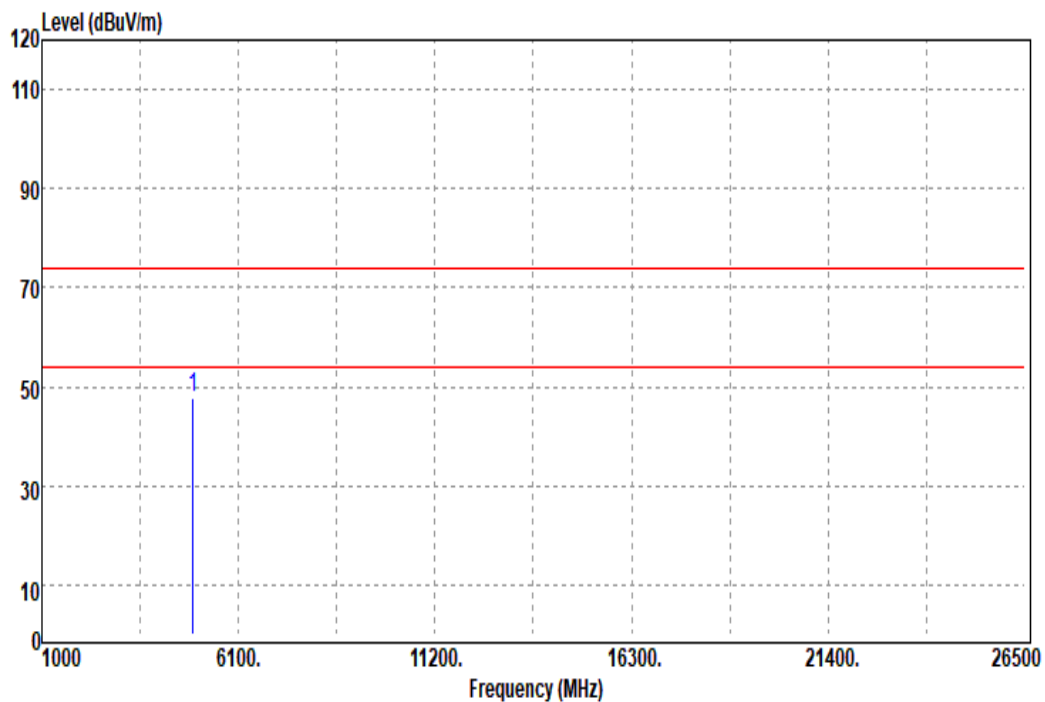

Frequency (MHz)	Reading (dBuV)	Correct Factor (dB/m)	Result (dBuV/m)	Limit (dBuV/m)	Margin (dB)	Remark
4924.00	44.19	3.46	47.65	74.00	-26.35	peak
N/A						

Remark:

1. Measuring frequencies from 1 GHz to the 10th harmonic of highest fundamental frequency.
2. For above 1GHz, the EUT peak value was under average limit, therefore the Average value compliance with the average limit

Test Mode	IEEE 802.11n HT20 Low CH	Temp/Hum	25(°C)/ 53%RH
Test Item	Harmonic	Test Date	June 4, 2019
Polarize	Vertical	Test Engineer	Dally Hong
Detector	Peak		

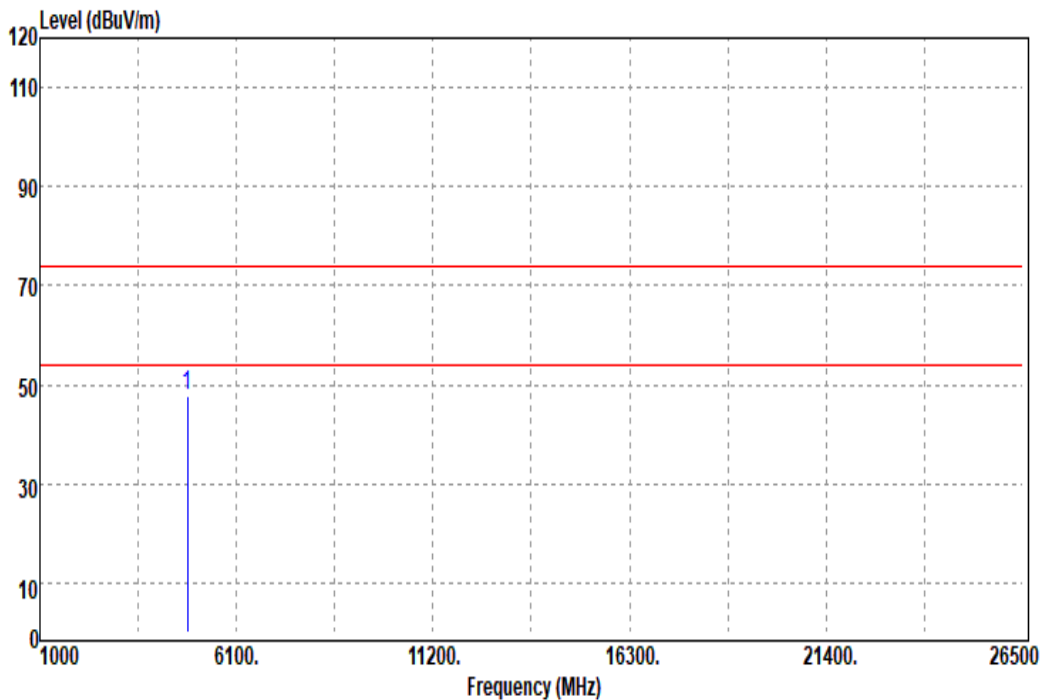

Frequency (MHz)	Reading (dBuV)	Correct Factor (dB/m)	Result (dBuV/m)	Limit (dBuV/m)	Margin (dB)	Remark
4824.00	44.76	2.84	47.60	74.00	-26.40	peak
N/A						

Remark:

1. Measuring frequencies from 1 GHz to the 10th harmonic of highest fundamental frequency.
2. For above 1GHz, the EUT peak value was under average limit, therefore the Average value compliance with the average limit

Report No.: T190513D01-RP

Test Mode	IEEE 802.11n HT20 Low CH	Temp/Hum	25(°C)/ 53%RH
Test Item	Harmonic	Test Date	June 4, 2019
Polarize	Horizontal	Test Engineer	Dally Hong
Detector	Peak		

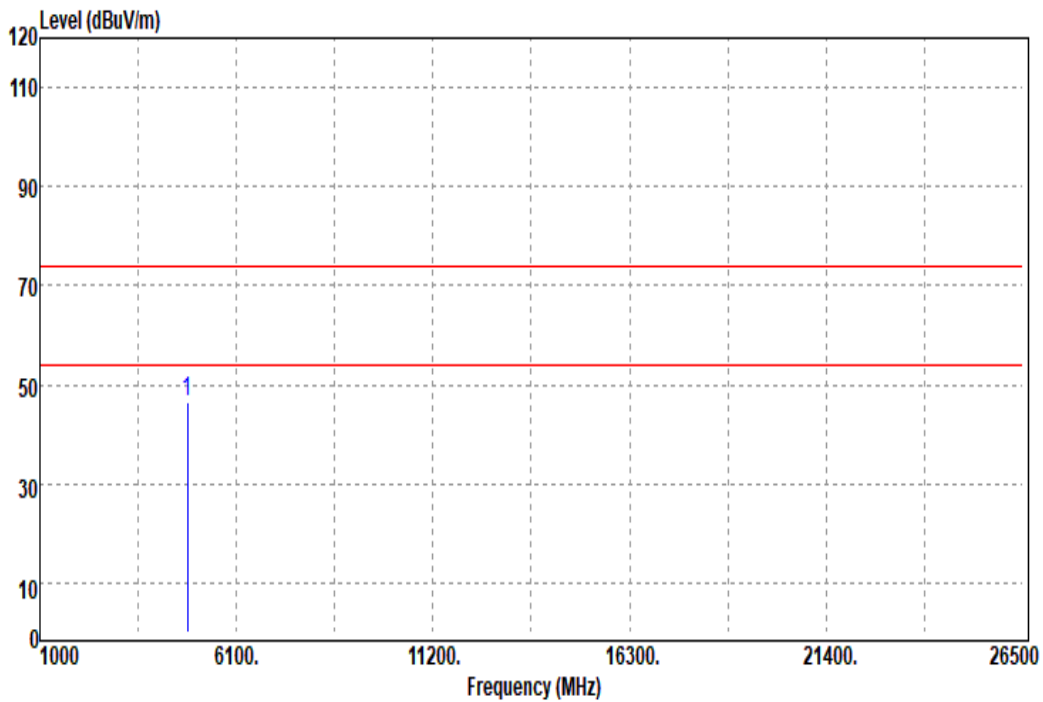

Frequency (MHz)	Reading (dBuV)	Correct Factor (dB/m)	Result (dBuV/m)	Limit (dBuV/m)	Margin (dB)	Remark
4824.00	43.81	2.84	46.65	74.00	-27.35	peak
N/A						

Remark:

1. Measuring frequencies from 1 GHz to the 10th harmonic of highest fundamental frequency.
2. For above 1GHz, the EUT peak value was under average limit, therefore the Average value compliance with the average limit

Report No.: T190513D01-RP

Test Mode	IEEE 802.11n HT20 Mid CH	Temp/Hum	25(°C)/ 53%RH
Test Item	Harmonic	Test Date	June 4, 2019
Polarize	Vertical	Test Engineer	Dally Hong
Detector	Peak		

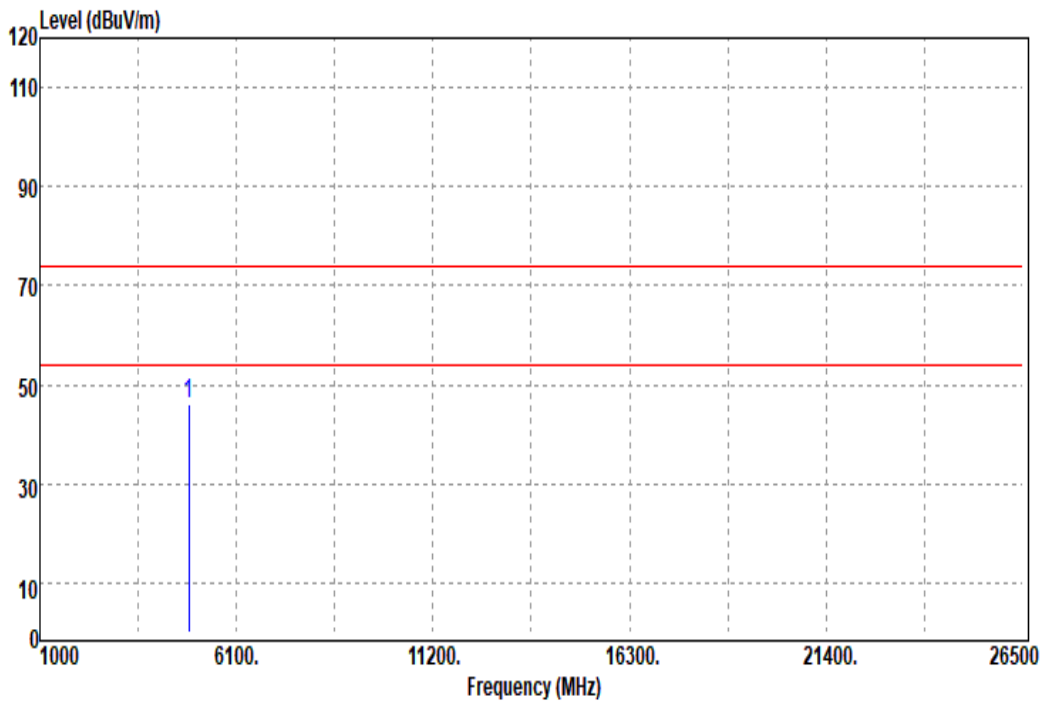

Frequency (MHz)	Reading (dBuV)	Correct Factor (dB/m)	Result (dBuV/m)	Limit (dBuV/m)	Margin (dB)	Remark
4874.00	43.21	2.98	46.19	74.00	-27.81	peak
N/A						

Remark:

1. Measuring frequencies from 1 GHz to the 10th harmonic of highest fundamental frequency.
2. For above 1GHz, the EUT peak value was under average limit, therefore the Average value compliance with the average limit

Test Mode	IEEE 802.11n HT20 Mid CH	Temp/Hum	25(°C)/ 53%RH
Test Item	Harmonic	Test Date	June 4, 2019
Polarize	Horizontal	Test Engineer	Dally Hong
Detector	Peak		

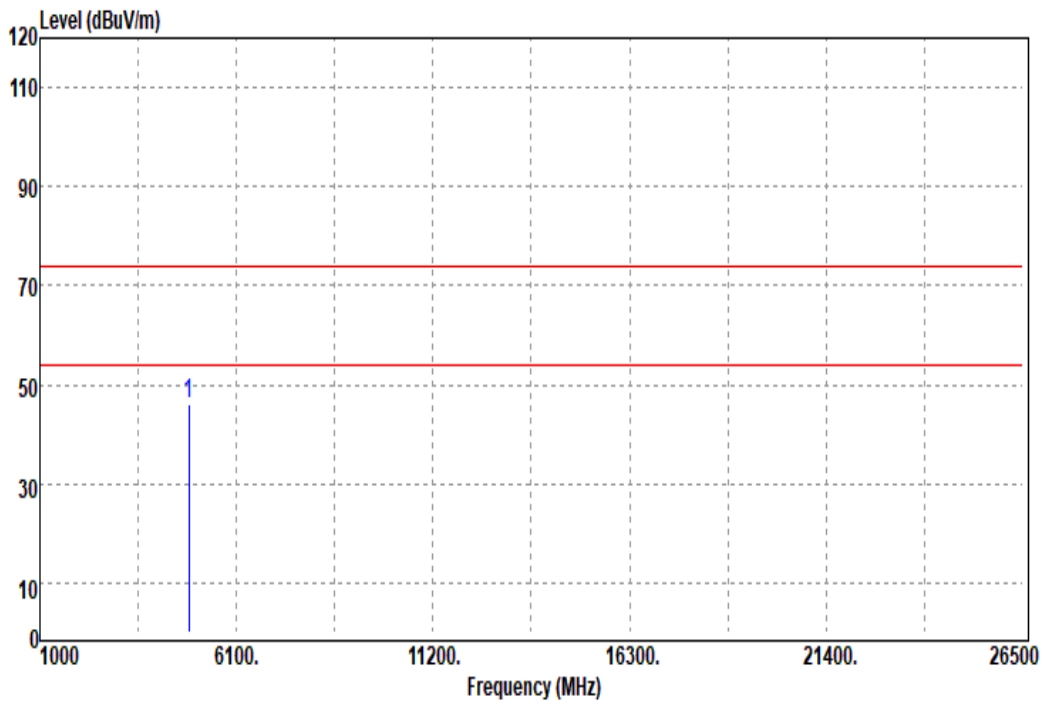

Frequency (MHz)	Reading (dBuV)	Correct Factor (dB/m)	Result (dBuV/m)	Limit (dBuV/m)	Margin (dB)	Remark
4874.00	43.20	2.98	46.18	74.00	-27.82	peak
N/A						

Remark:

1. Measuring frequencies from 1 GHz to the 10th harmonic of highest fundamental frequency.
2. For above 1GHz, the EUT peak value was under average limit, therefore the Average value compliance with the average limit

Report No.: T190513D01-RP

Test Mode	IEEE 802.11n HT20 High CH	Temp/Hum	25(°C)/ 53%RH
Test Item	Harmonic	Test Date	June 4, 2019
Polarize	Vertical	Test Engineer	Dally Hong
Detector	Peak		

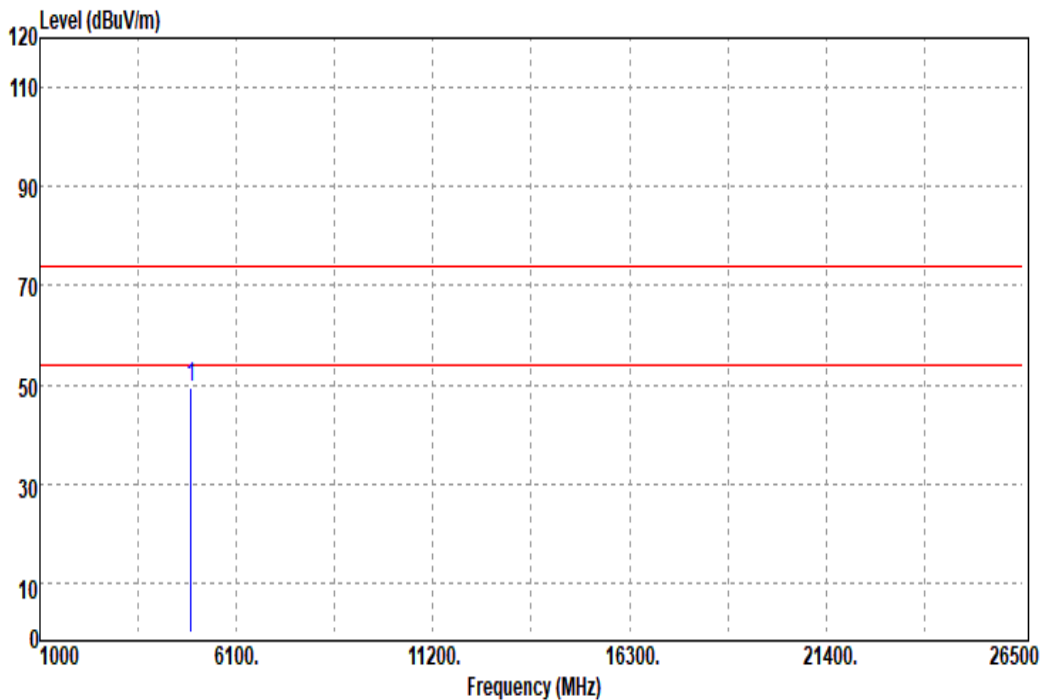

Frequency (MHz)	Reading (dBuV)	Correct Factor (dB/m)	Result (dBuV/m)	Limit (dBuV/m)	Margin (dB)	Remark
4924.00	45.97	3.46	49.43	74.00	-24.57	peak
N/A						

Remark:

1. Measuring frequencies from 1 GHz to the 10th harmonic of highest fundamental frequency.
2. For above 1GHz, the EUT peak value was under average limit, therefore the Average value compliance with the average limit

Test Mode	IEEE 802.11n HT20 High CH	Temp/Hum	25(°C)/ 53%RH
Test Item	Harmonic	Test Date	June 4, 2019
Polarize	Horizontal	Test Engineer	Dally Hong
Detector	Peak		

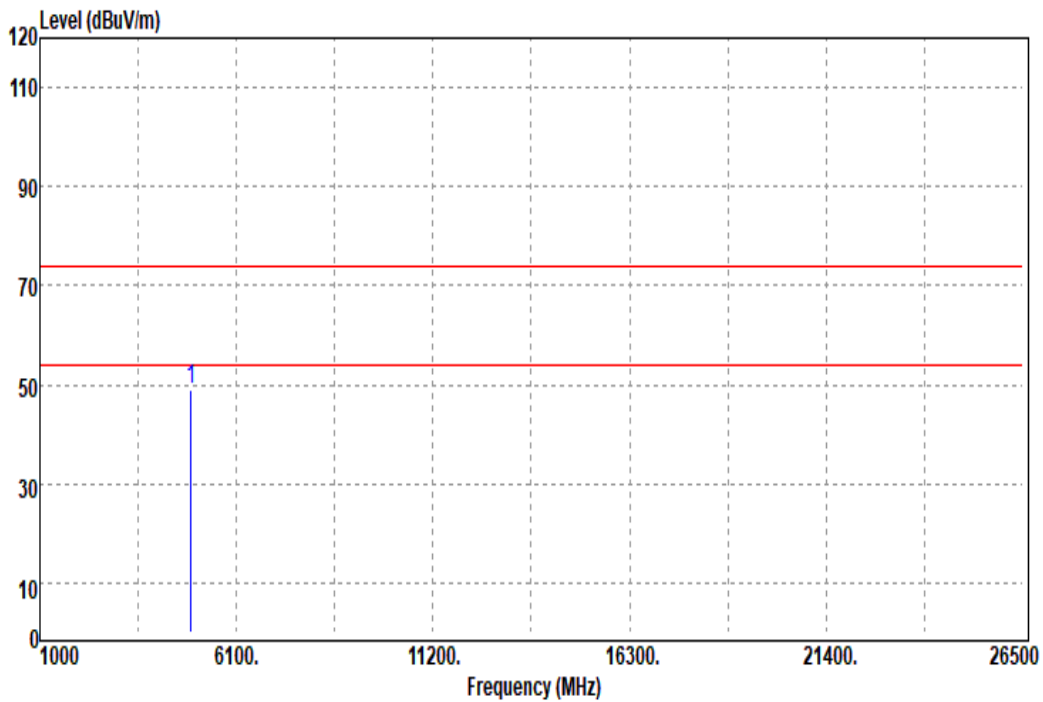

Frequency (MHz)	Reading (dBuV)	Correct Factor (dB/m)	Result (dBuV/m)	Limit (dBuV/m)	Margin (dB)	Remark
4924.00	45.34	3.46	48.80	74.00	-25.20	peak
N/A						

Remark:

1. Measuring frequencies from 1 GHz to the 10th harmonic of highest fundamental frequency.
2. For above 1GHz, the EUT peak value was under average limit, therefore the Average value compliance with the average limit

Test Mode	IEEE 802.11n HT40 Low CH	Temp/Hum	25(°C)/ 53%RH
Test Item	Harmonic	Test Date	June 4, 2019
Polarize	Vertical	Test Engineer	Dally Hong
Detector	Peak		

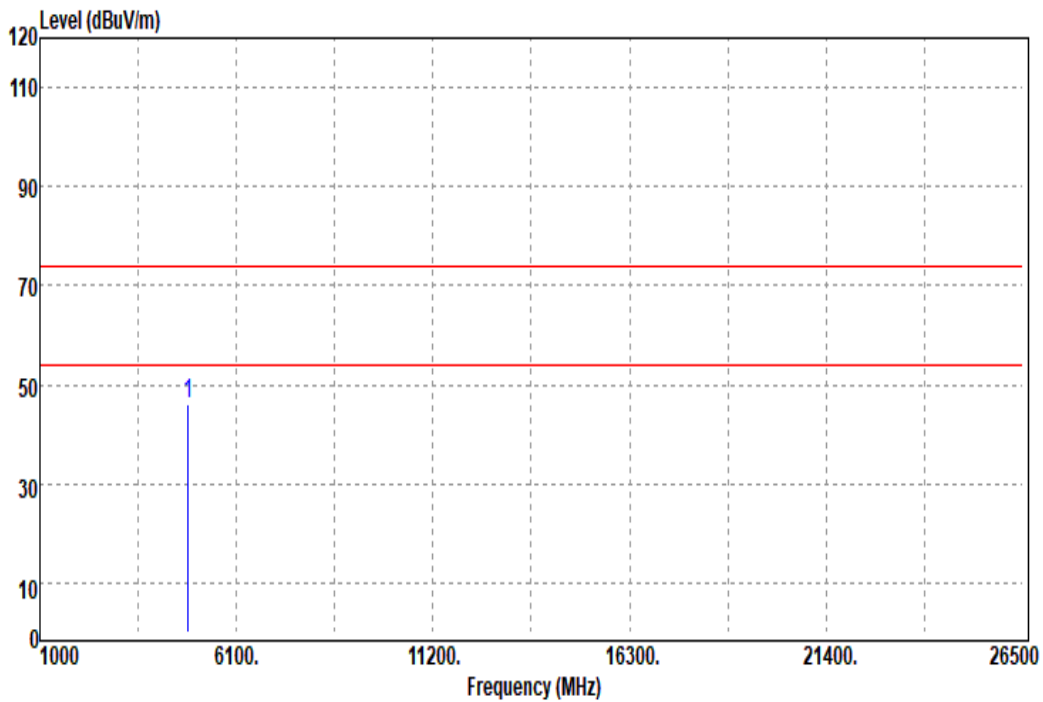

Frequency (MHz)	Reading (dBuV)	Correct Factor (dB/m)	Result (dBuV/m)	Limit (dBuV/m)	Margin (dB)	Remark
4844.00	43.26	2.84	46.10	74.00	-27.90	peak
N/A						

Remark:

1. Measuring frequencies from 1 GHz to the 10th harmonic of highest fundamental frequency.
2. For above 1GHz, the EUT peak value was under average limit, therefore the Average value compliance with the average limit

Report No.: T190513D01-RP

Test Mode	IEEE 802.11n HT40 Low CH	Temp/Hum	25(°C)/ 53%RH
Test Item	Harmonic	Test Date	June 4, 2019
Polarize	Horizontal	Test Engineer	Dally Hong
Detector	Peak		

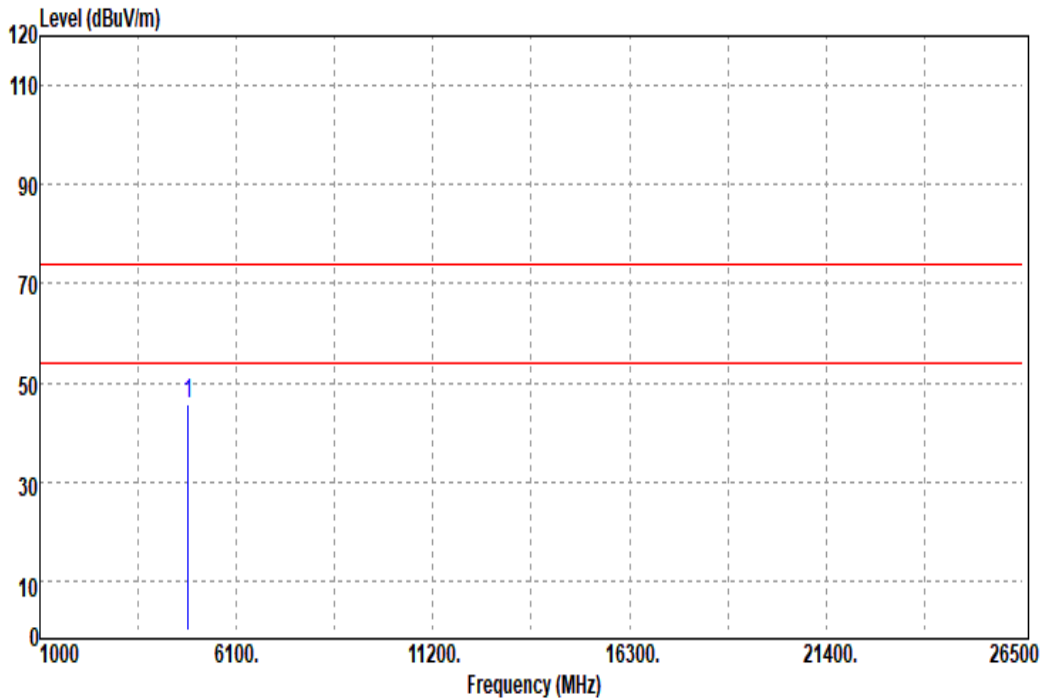

Frequency (MHz)	Reading (dBuV)	Correct Factor (dB/m)	Result (dBuV/m)	Limit (dBuV/m)	Margin (dB)	Remark
4844.00	42.74	2.84	45.58	74.00	-28.42	peak
N/A						

Remark:

1. Measuring frequencies from 1 GHz to the 10th harmonic of highest fundamental frequency.
2. For above 1GHz, the EUT peak value was under average limit, therefore the Average value compliance with the average limit

Test Mode	IEEE 802.11n HT40 Mid CH	Temp/Hum	25(°C)/ 53%RH
Test Item	Harmonic	Test Date	June 4, 2019
Polarize	Vertical	Test Engineer	Dally Hong
Detector	Peak		

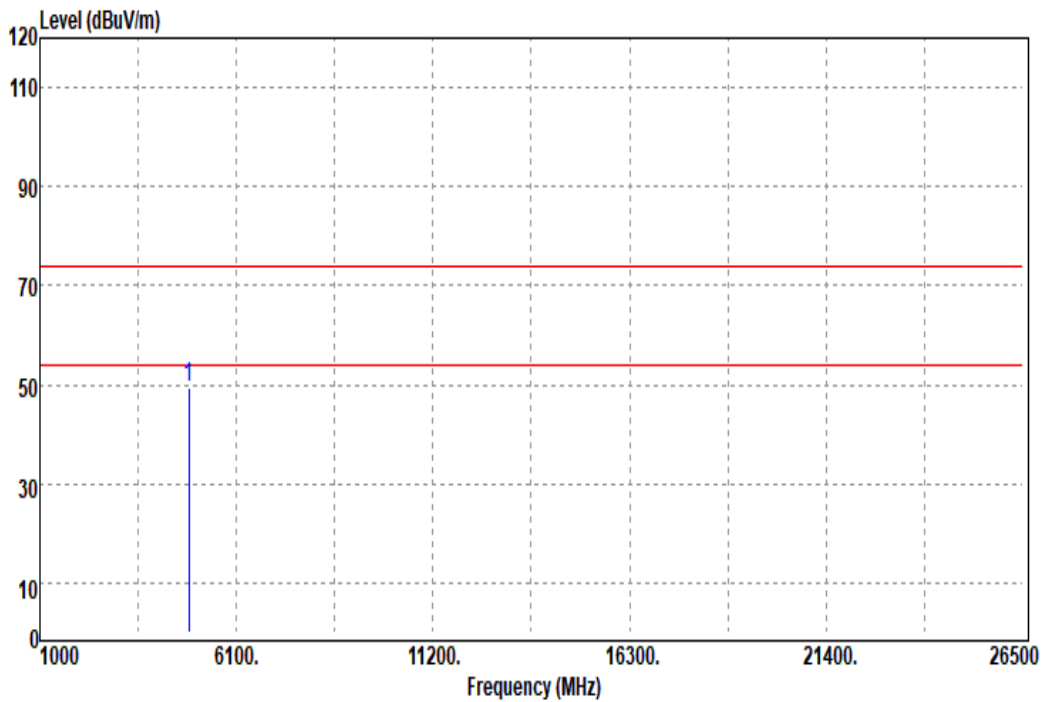

Frequency (MHz)	Reading (dBuV)	Correct Factor (dB/m)	Result (dBuV/m)	Limit (dBuV/m)	Margin (dB)	Remark
4874.00	46.30	2.98	49.28	74.00	-24.72	peak
N/A						

Remark:

1. Measuring frequencies from 1 GHz to the 10th harmonic of highest fundamental frequency.
2. For above 1GHz, the EUT peak value was under average limit, therefore the Average value compliance with the average limit

Test Mode	IEEE 802.11n HT40 Mid CH	Temp/Hum	25(°C)/ 53%RH
Test Item	Harmonic	Test Date	June 4, 2019
Polarize	Horizontal	Test Engineer	Dally Hong
Detector	Peak		

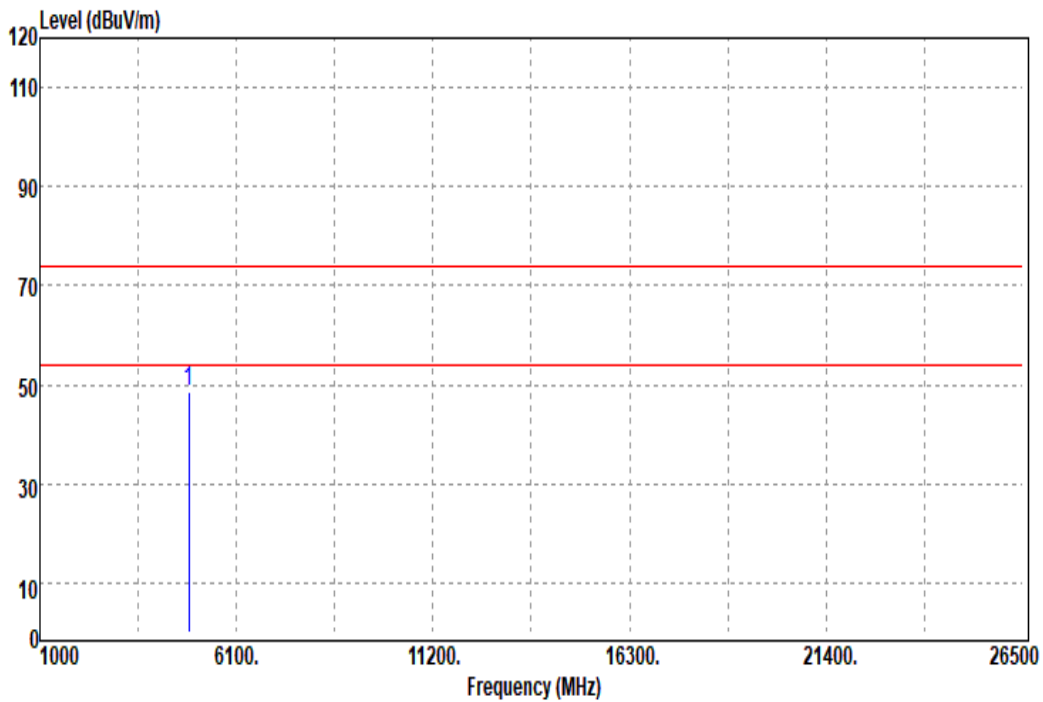

Frequency (MHz)	Reading (dBuV)	Correct Factor (dB/m)	Result (dBuV/m)	Limit (dBuV/m)	Margin (dB)	Remark
4874.00	45.72	2.98	48.70	74.00	-25.30	peak
N/A						

Remark:

1. Measuring frequencies from 1 GHz to the 10th harmonic of highest fundamental frequency.
2. For above 1GHz, the EUT peak value was under average limit, therefore the Average value compliance with the average limit

Report No.: T190513D01-RP

Test Mode	IEEE 802.11n HT40 High CH	Temp/Hum	25(°C)/ 53%RH
Test Item	Harmonic	Test Date	June 4, 2019
Polarize	Vertical	Test Engineer	Dally Hong
Detector	Peak		

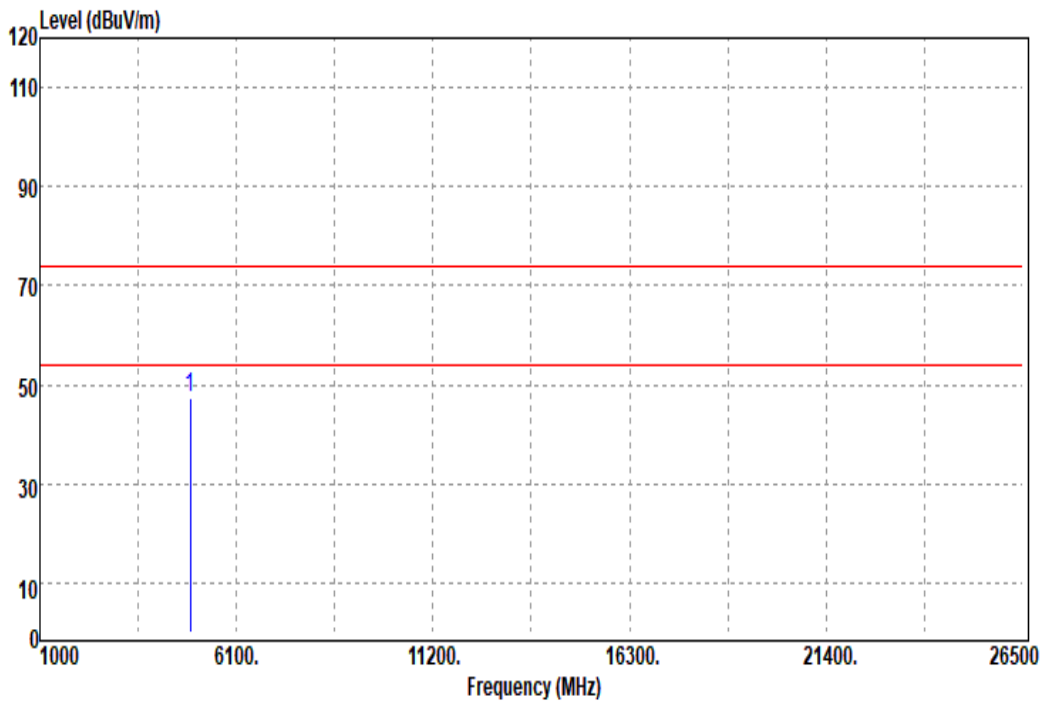

Frequency (MHz)	Reading (dBuV)	Correct Factor (dB/m)	Result (dBuV/m)	Limit (dBuV/m)	Margin (dB)	Remark
4904.00	44.16	3.22	47.38	74.00	-26.62	peak
N/A						

Remark:

1. Measuring frequencies from 1 GHz to the 10th harmonic of highest fundamental frequency.
2. For above 1GHz, the EUT peak value was under average limit, therefore the Average value compliance with the average limit

Report No.: T190513D01-RP

Test Mode	IEEE 802.11n HT40 High CH	Temp/Hum	25(°C)/ 53%RH
Test Item	Harmonic	Test Date	June 4, 2019
Polarize	Horizontal	Test Engineer	Dally Hong
Detector	Peak		

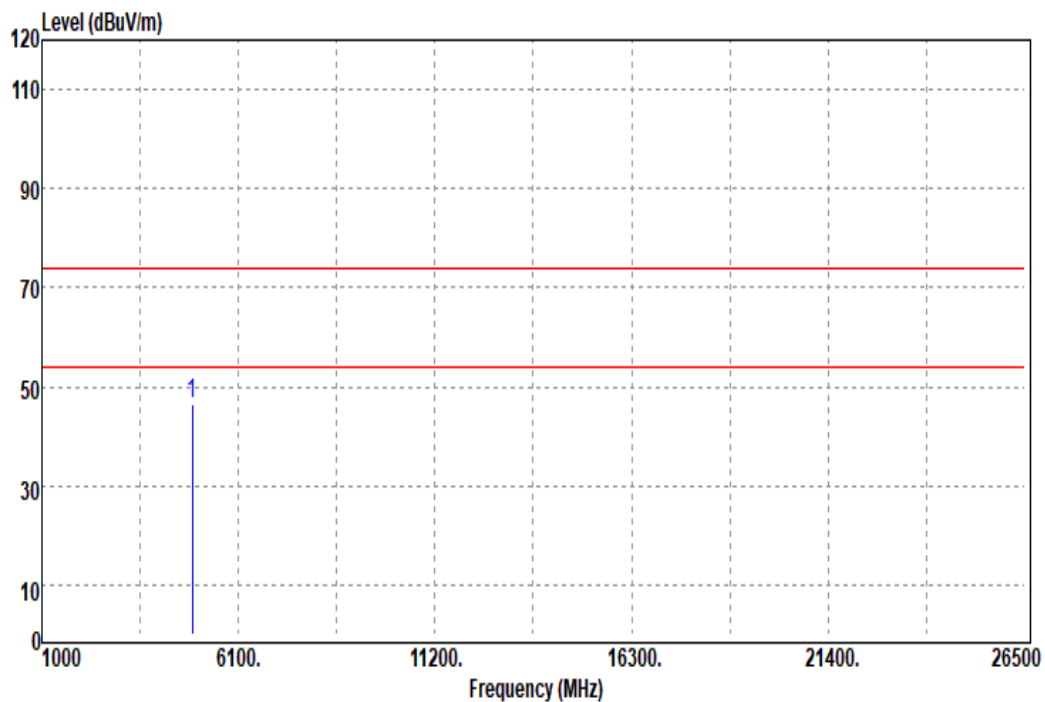

Frequency (MHz)	Reading (dBuV)	Correct Factor (dB/m)	Result (dBuV/m)	Limit (dBuV/m)	Margin (dB)	Remark
4904.00	43.44	3.22	46.66	74.00	-27.34	peak
N/A						

Remark:

1. Measuring frequencies from 1 GHz to the 10th harmonic of highest fundamental frequency.
2. For above 1GHz, the EUT peak value was under average limit, therefore the Average value compliance with the average limit

- End of Test Report -