

TEST REPORT

Report No.: BCTC2310448636-2E

Applicant: Snap One, LLC

Product Name: Video Doorbell

Model/Type reference: CLR-V200-VDB

Tested Date: 2023-10-16 to 2023-11-01

Issued Date: 2023-12-11

Shenzhen BCTC Testing Co., Ltd.

FCC ID: 2AJAC-CLRV200VDB

Product Name: Video Doorbell
Trademark: Clare
Model/Type Ref.: CLR-V200-VDB
Prepared For: Snap One, LLC
Address: 1800 Continental Blvd Suite 200-300, Charlotte, North Carolina 28273 USA
Manufacturer: Snap One, LLC
Address: 1800 Continental Blvd Suite 200-300, Charlotte, North Carolina 28273 USA
Prepared By: Shenzhen BCTC Testing Co., Ltd.
Address: 1-2/F., Building B, Pengzhou Industrial Park, No.158, Fuyuan 1st Road, Tangwei, Fuhai Subdistrict, Bao'an District, Shenzhen, Guangdong, China
Sample Received Date: 2023-10-16
Sample tested Date: 2023-10-16 to 2023-11-01
Report No.: BCTC2310448636-2E
Test Standards: FCC Part15 15.407
ANSI C63.10-2013
KDB 662911 D01 v02r01
KDB 789033 D02 v02r01
Test Results: PASS

Tested by:

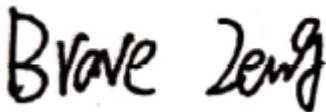

Brave Zeng/ Project Handler

The test report is effective only with both signature and specialized stamp. This result(s) shown in this report refer only to the sample(s) tested. Without written approval of Shenzhen BCTC Testing Co., Ltd, this report can't be reproduced except in full. The tested sample(s) and the sample information are provided by the client.

Approved by:



Zero Zhou/Reviewer

Table of Content

Test Report Declaration	Page
1. Version	5
2. Test Summary	6
3. Measurement Uncertainty	7
4. Product Information and Test Setup	8
4.1 Product Information	8
4.2 Test Setup Configuration	9
4.3 Support Equipment	9
4.4 Channel List	9
4.5 Test Mode	10
4.6 Table Of Parameters Of Text Software Setting	10
5. Test Facility And Test Instrument Used	11
5.1 Test Facility	11
5.2 Test Instrument Used	11
6. Conducted Emissions	13
6.1 Block Diagram Of Test Setup	13
6.2 Limit	13
6.3 Test Procedure	13
6.4 EUT Operating Conditions	14
6.5 Test Result	15
7. Radiated Emissions	17
7.1 Block Diagram Of Test Setup	17
7.2 Limit	18
7.3 Test Procedure	19
7.4 EUT Operating Conditions	20
7.5 Test Result	20
8. Power Spectral Density Test	29
8.1 Block Diagram Of Test Setup	29
8.2 Limit	29
8.3 Test Procedure	30
8.4 EUT Operating Conditions	30
8.5 Test Result	31
9. 26dB & 6dB & 99% Emission Bandwidth	36
9.1 Block Diagram Of Test Setup	36
9.2 Limit	36
9.3 Test Procedure	36
9.4 EUT Operating Conditions	36
9.5 Test Result	37
10. Maximum Conducted Output Power	46
10.1 Block Diagram Of Test Setup	46
10.2 Limit	46
10.3 Test Procedure	46
10.4 EUT Operating Conditions	47
10.5 Test Result	48

11. Out Of Band Emissions	49
11.1 Block Diagram Of Test Setup.....	49
11.2 Limit	49
11.3 Test Procedure	49
11.4 EUT Operating Conditions	49
11.5 Test Result.....	49
12. Spurious RF Conducted Emissions.....	53
12.1 Block Diagram Of Test Setup.....	53
12.2 Limit	53
12.3 Test Procedure	53
12.4 Test Result.....	53
13. Frequency Stability Measurement.....	58
13.1 Block Diagram Of Test Setup.....	58
13.2 Limit	58
13.3 Test Procedure	58
13.4 Test Result.....	59
14. Duty Cycle Of Test Signal	62
14.1 Standard Requirement	62
14.2 Formula.....	62
14.3 Test Procedure	62
14.4 Test Result.....	62
15. Antenna Requirement	63
15.1 Limit	63
15.2 Test Result.....	63
16. EUT Test Setup Photographs.....	64

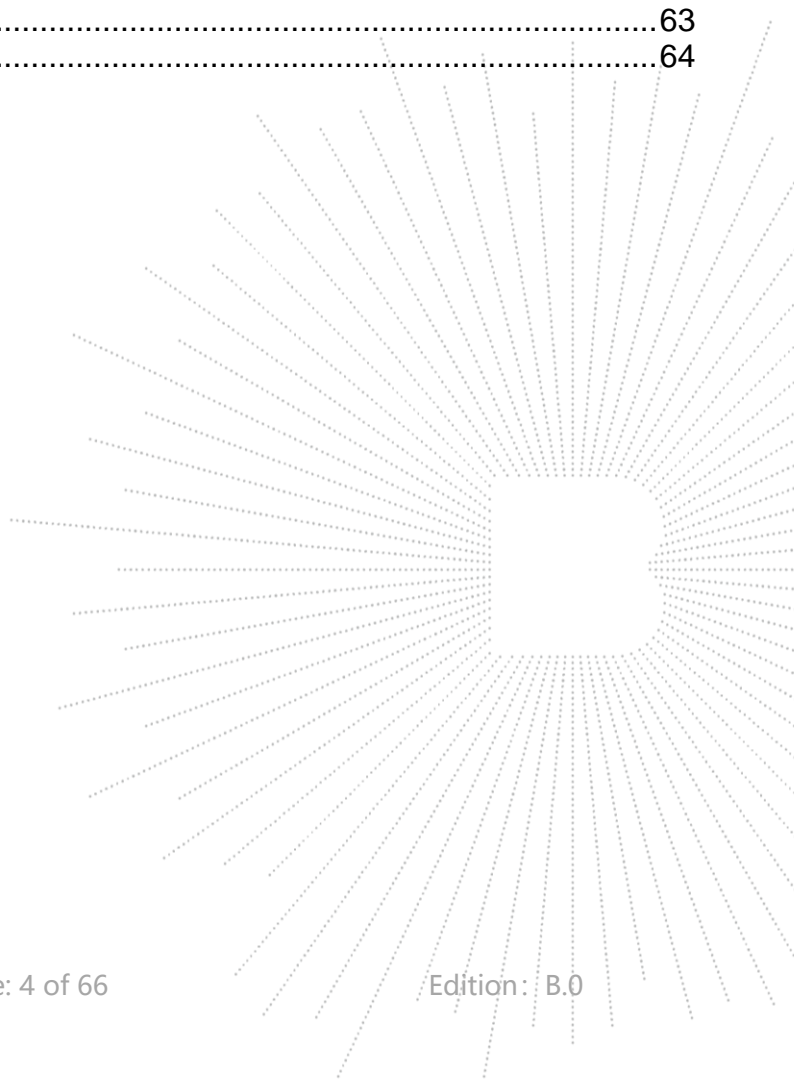

1. Version

Report No.	Issue Date	Description	Approved
BCTC2310448636-2E	2023-12-11	Original	Valid

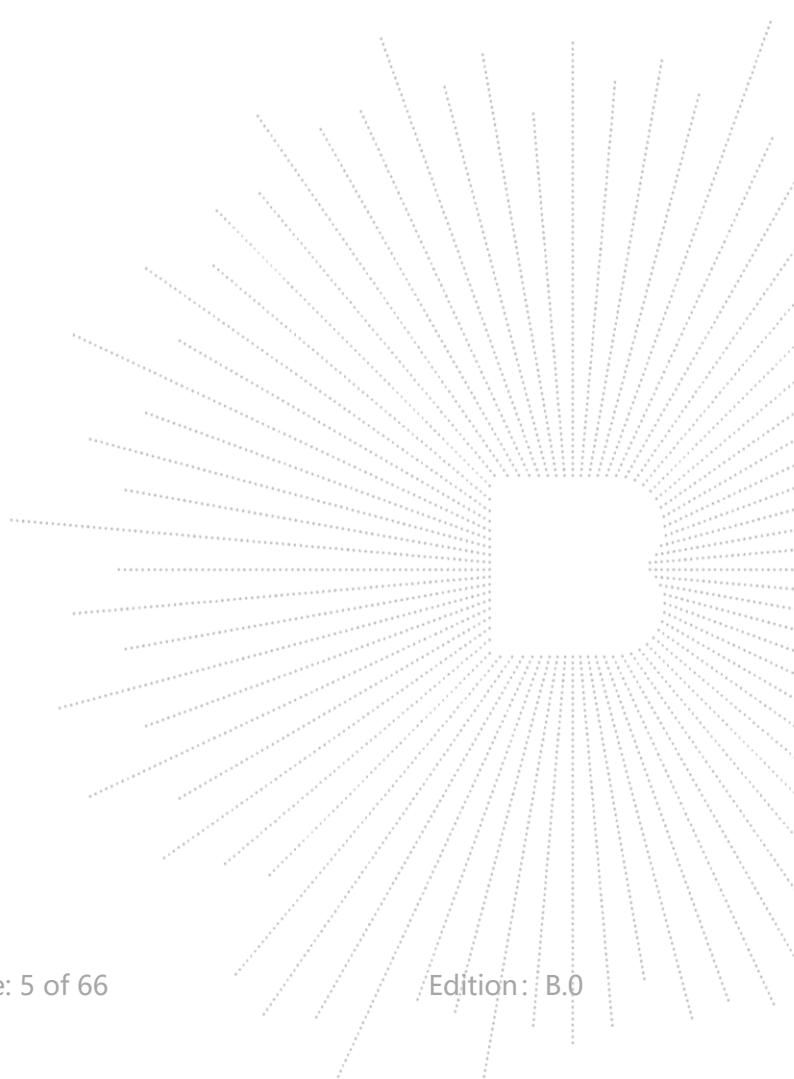

2. Test Summary

The Product has been tested according to the following specifications:

No.	Test Parameter	Clause No.	Results
1	Spurious Radiated Emissions	15.209(a), 15.407 (b)	PASS
2	Conducted Emission	15.207	PASS
3	26 dB and 99% Emission Bandwidth	15.407 (a)	PASS
4	Minimum 6 dB bandwidth	15.407(e)	PASS
5	Maximum Conducted Output Power	15.407 (a)	PASS
6	Band Edge	15.407(b)	PASS
7	Power Spectral Density	15.407 (a)	PASS
8	Spurious Emissions at Antenna Terminals	15.407(b)	PASS
9	Antenna Requirement	15.203	PASS

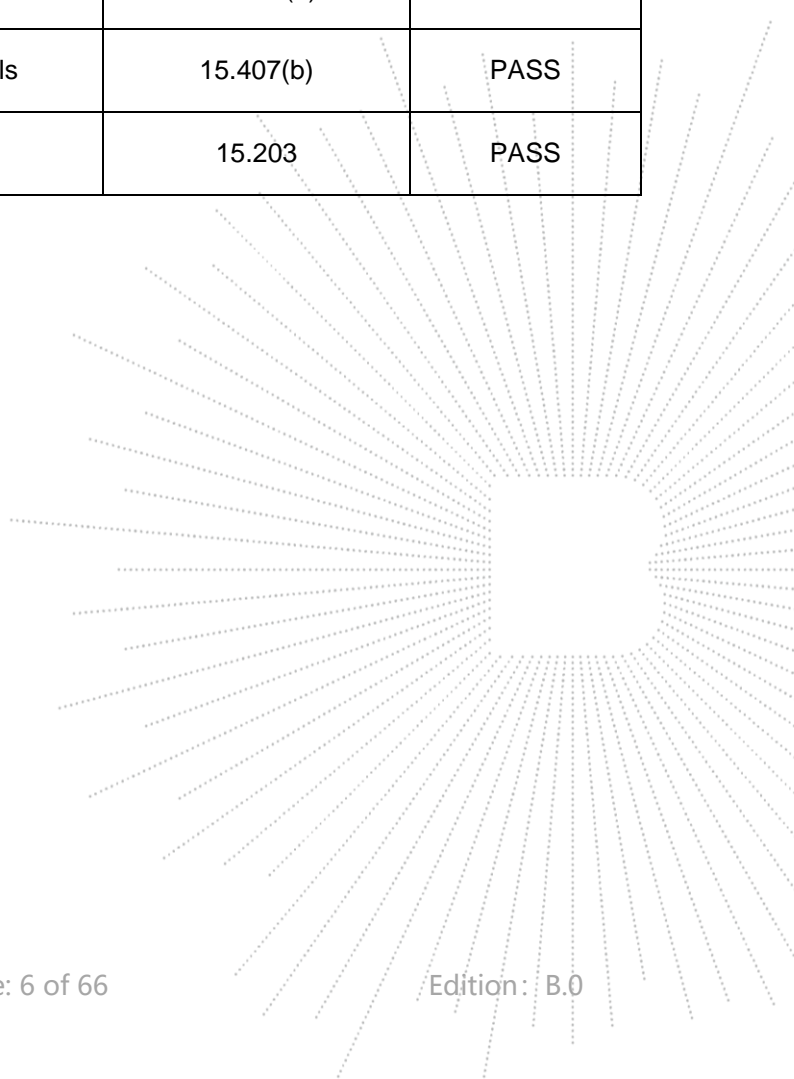

3. Measurement Uncertainty

Where relevant, the following measurement uncertainty levels have been estimated for tests performed on the Product as specified in CISPR 16-4-2. This uncertainty represents an expanded uncertainty expressed at approximately the 95% confidence level using a coverage factor of $k=2$.

No.	Item	Uncertainty
1	3m chamber Radiated spurious emission(9kHz-30MHz)	U=3.7dB
2	3m chamber Radiated spurious emission(30MHz-1GHz)	U=4.3dB
3	3m chamber Radiated spurious emission(1GHz-18GHz)	U=4.5dB
4	3m chamber Radiated spurious emission(18GHz-40GHz)	U=3.34dB
5	Conducted Emission(150kHz-30MHz)	U=3.20dB
6	Conducted Adjacent channel power	U=1.38dB
7	Conducted output power uncertainty Above 1G	U=1.576dB
8	Conducted output power uncertainty below 1G	U=1.28dB
9	humidity uncertainty	U=5.3%
10	Temperature uncertainty	U=0.59°C

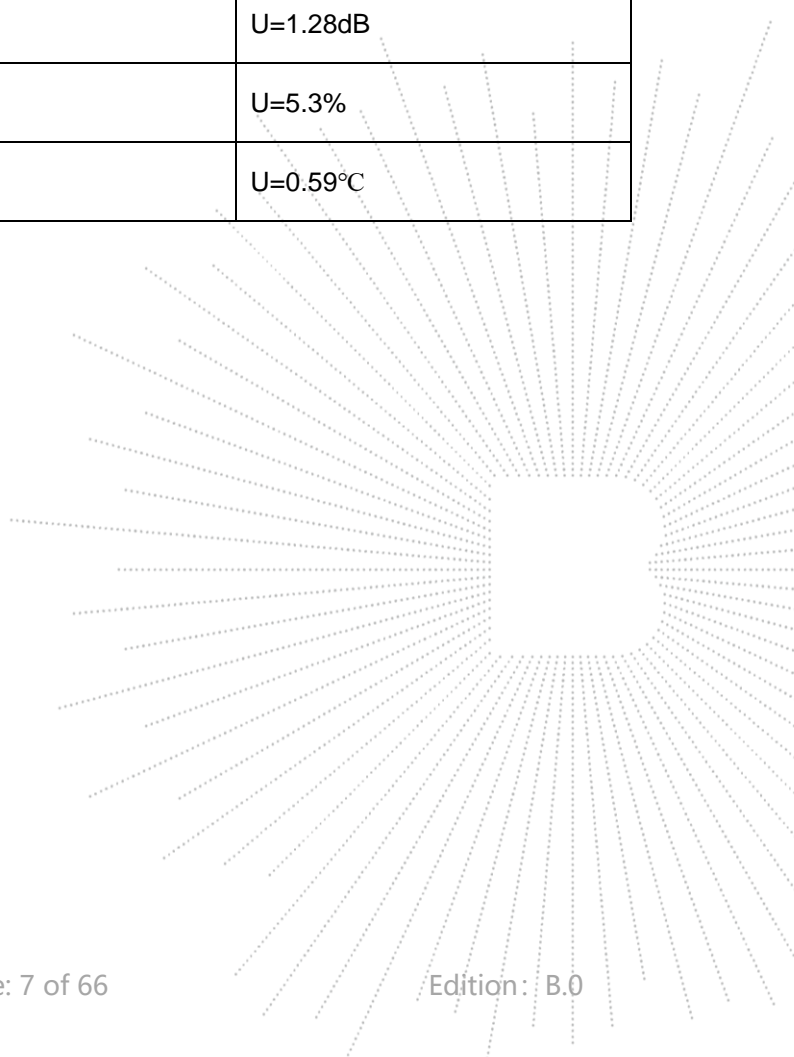

4. Product Information and Test Setup

4.1 Product Information

Model/Type Ref.:	CLR-V200-VDB
Model differences:	N/A
Hardware Version:	N/A
Software Version:	N/A
IEEE 802.11 WLAN Mode Supported	<input checked="" type="checkbox"/> 802.11a <input checked="" type="checkbox"/> 802.11n(20MHz channel bandwidth) <input checked="" type="checkbox"/> 802.11n(40MHz channel bandwidth)
Operation Frequency:	5180-5240MHz for 802.11a/n (HT20); 5190-5230MHz for 802.11n (HT40);
Data Rate	<input checked="" type="checkbox"/> 802.11a:54/48/36/24/18/12/9/6Mbps <input checked="" type="checkbox"/> 802.11n:up to 300 Mbps
Type of Modulation:	<input checked="" type="checkbox"/> OFDM with BPSK/QPSK/16QAM/64QAM for 802.11a/n
Number Of Channel	4 channels for 802.11a/n20 in the 5180-5240MHz band ; 2 channels for 802.11 n40 in the 5190-5230MHz band
Transmit Power:	WIFI5.1G:12.89dBm
Antenna installation:	Internal antenna
Antenna Gain:	WIFI5.1G:4.21dBi
power supply:	AC16V-30V, 50/60Hz,2.1W-3.5W

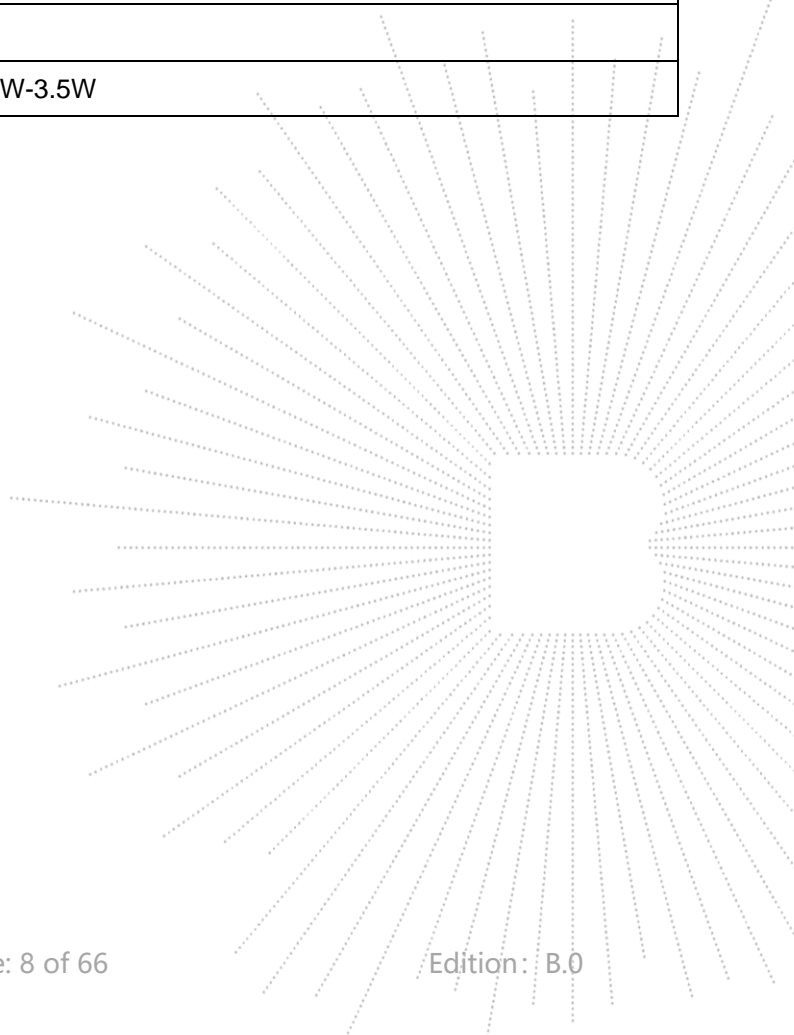

4.2 Test Setup Configuration

See test photographs attached in *EUT TEST SETUP PHOTOGRAPHS* for the actual connections between Product and support equipment.

Conducted Emission:

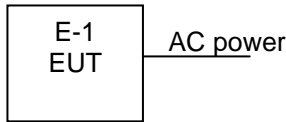

Radiated Spurious Emission

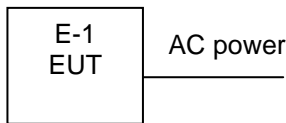

4.3 Support Equipment

No.	Device Type	Brand	Model	Series No.	Note
E-1	Video Doorbell	N/A	CLR-V200-VDB	N/A	EUT
E-2	AC power	N/A	BCTC-45	N/A	Auxiliary

Item	Shielded Type	Ferrite Core	Length	Note
C-1	N/A	N/A	N/A	N/A

Notes:

1. All the equipment/cables were placed in the worst-case configuration to maximize the emission during the test.
2. Grounding was established in accordance with the manufacturer's requirements and conditions for the intended use.

4.4 Channel List

Frequency and Channel list for 802.11a/n (20MHz):

802.11a/n (20MHz) Carrier Frequency Channel							
Channel	Frequency (MHz)	Channel	Frequency (MHz)	Channel	Frequency (MHz)	Channel	Frequency (MHz)
36	5180	44	5220	-	-	-	-
40	5200	48	5240	-	-	-	-

802.11n (40MHz) Carrier Frequency Channel							
Channel	Frequency (MHz)	Channel	Frequency (MHz)	Channel	Frequency (MHz)	Channel	Frequency (MHz)
38	5190	-	-	-	-	-	-
46	5230	-	-	-	-	-	-

4.5 Test Mode

To investigate the maximum EMI emission characteristics generates from EUT, the test system was pre-scanning tested base on the consideration of following EUT operation mode or test configuration mode which possible have effect on EMI emission level. Each of these EUT operation mode(s) or test configuration mode(s) mentioned above was evaluated respectively.

Pretest Mode	Description
Mode 1	802.11a / n20 CH36/CH40
Mode 2	802.11n40 CH38/CH 46
Mode 3	Link Mode

4.6 Table Of Parameters Of Text Software Setting

During testing channel & power controlling software provided by the customer was used to control the operating channel as well as the output power level. The RF output power selection is for the setting of RF output power expected by the customer and is going to be fixed on the firmware of the final end product power parameters

Test software Version	CMD		
Parameters	DEF	DEF	DEF

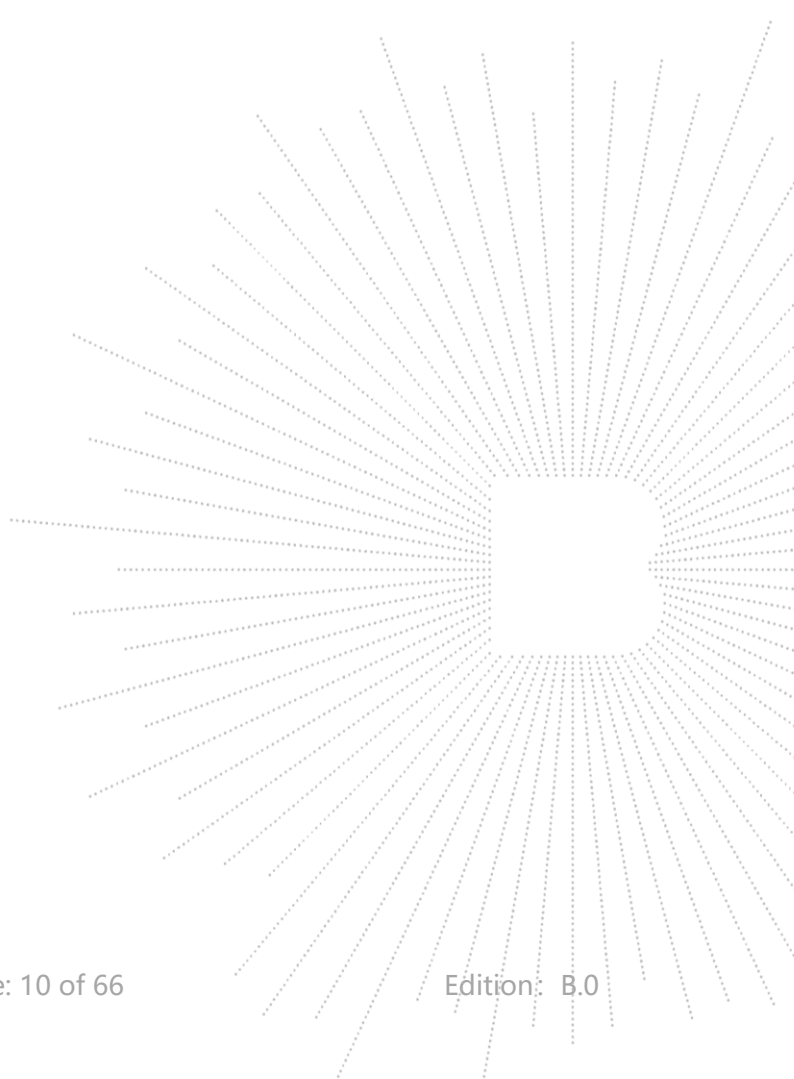

5. Test Facility And Test Instrument Used

5.1 Test Facility

All measurement facilities used to collect the measurement data are located at Shenzhen BCTC Testing Co., Ltd. Address: 1-2/F., Building B, Pengzhou Industrial Park, No.158, Fuyuan 1st Road, Zhancheng, Fuha i Subdistrict, Bao'an District, Shenzhen, Guangdong, China. The site and apparatus are constructed in conformance with the requirements of ANSI C63.4 and CISPR 16-1-1 other equivalent standards.

FCC Test Firm Registration Number: 712850

A2LA certificate registration number is: CN1212

ISED Registered No.: 23583

ISED CAB identifier: CN0017

5.2 Test Instrument Used

Conducted Emissions Test					
Equipment	Manufacturer	Model#	Serial#	Last Cal.	Next Cal.
Receiver	R&S	ESR3	102075	May 15, 2023	May 14, 2024
LISN	R&S	ENV216	101375	May 15, 2023	May 14, 2024
Software	Frad	EZ-EMC	EMC-CON 3A1	\	\
Attenuator	\	10dB DC-6GHz	1650	May 15, 2023	May 14, 2024

RF Conducted Test					
Equipment	Manufacturer	Model#	Serial#	Last Cal.	Next Cal.
Power Metter	Keysight	E4419	\	May 15, 2023	May 14, 2024
Power Sensor (AV)	Keysight	E9300A	\	May 15, 2023	May 14, 2024
Signal Analyzer 20kHz-26.5GHz	Keysight	N9020A	MY49100060	May 15, 2023	May 14, 2024
Spectrum Analyzer 9kHz-40GHz	R&S	FSP40	\	May 15, 2023	May 14, 2024

Radiated Emissions Test (966 Chamber)					
Equipment	Manufacturer	Model#	Serial#	Last Cal.	Next Cal.
966 chamber	ChengYu	966 Room	966	May 15, 2023	May 14, 2026
Receiver	R&S	ESR3	102075	May 15, 2023	May 14, 2024
Receiver	R&S	ESRP	101154	May 15, 2023	May 14, 2024
Amplifier	SKET	LAPA_01G18 G-45dB	\	May 15, 2023	May 14, 2024
Amplifier	Schwarzbeck	BBV9744	9744-0037	May 15, 2023	May 14, 2024
TRILOG Broadband Antenna	Schwarzbeck	VULB9163	942	May 15, 2023	May 14, 2024
Horn Antenna	Schwarzbeck	BBHA9120D	1541	May 15, 2023	May 14, 2024
Horn Antenn(18GH z-40GHz)	Schwarzbeck	BBHA9170	00822	May 15, 2023	May 14, 2024
Amplifier(18G Hz-40GHz)	MITEQ	TTA1840-35- HG	2034381	May 15, 2023	May 14, 2024
Loop Antenna(9KHz -30MHz)	Schwarzbeck	FMZB1519B	00014	May 15, 2023	May 14, 2024
RF cables1(9kHz- 30MHz)	Huber+Suhnar	9kHz-30MHz	B1702988-000 8	May 15, 2023	May 14, 2024
RF cables2(30MH z-1GHz)	Huber+Suhnar	30MHz-1GHz	1486150	May 15, 2023	May 14, 2024
RF cables3(1GHz -40GHz)	Huber+Suhnar	1GHz-40GHz	1607106	May 15, 2023	May 14, 2024
Power Metter	Keysight	E4419	\	May 15, 2023	May 14, 2024
Power Sensor (AV)	Keysight	E9300A	\	May 15, 2023	May 14, 2024
Signal Analyzer20kH z-26.5GHz	Keysight	N9020A	MY49100060	May 15, 2023	May 14, 2024
Spectrum Analyzer9kHz- 40GHz	R&S	FSP40	\	May 15, 2023	May 14, 2024
Software	Frad	EZ-EMC	FA-03A2 RE	\	\

6. Conducted Emissions

6.1 Block Diagram Of Test Setup

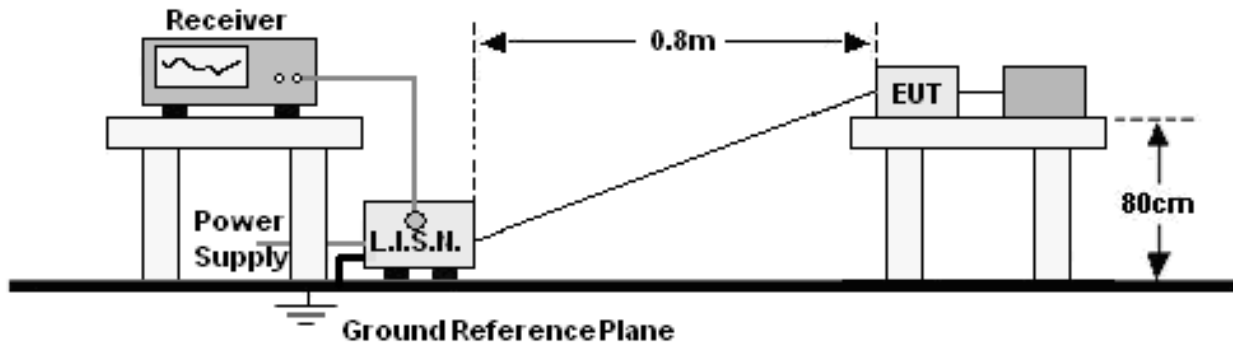

6.2 Limit

Frequency (MHz)	Limit (dBuV)	
	Quas-peak	Average
0.15 -0.5	66 - 56 *	56 - 46 *
0.50 -5.0	56.00	46.00
5.0 -30.0	60.00	50.00

Notes:
 1. *Decreasing linearly with logarithm of frequency.
 2. The lower limit shall apply at the transition frequencies.

6.3 Test Procedure

Receiver Parameters	Setting
Attenuation	10 dB
Start Frequency	0.15 MHz
Stop Frequency	30 MHz
IF Bandwidth	9 kHz

- The Product was placed on a nonconductive table 0.8 m above the horizontal ground reference plane, and 0.4 m from the vertical ground reference plane, and connected to the main through Line Impedance Stability Network (L.I.S.N).
- The RBW of the receiver was set at 9 kHz in 150 kHz ~ 30MHz with Peak and AVG detector in Max Hold mode. Run the receiver's pre-scan to record the maximum disturbance generated from Product in all power lines in the full band.
- For each frequency whose maximum record was higher or close to limit, measure its QP and AVG values and record.

6.4 EUT Operating Conditions

The EUT was configured for testing in a typical fashion (as a customer would normally use it). The EUT has been programmed to continuously transmit during test. This operating condition was tested and used to collect the included data.

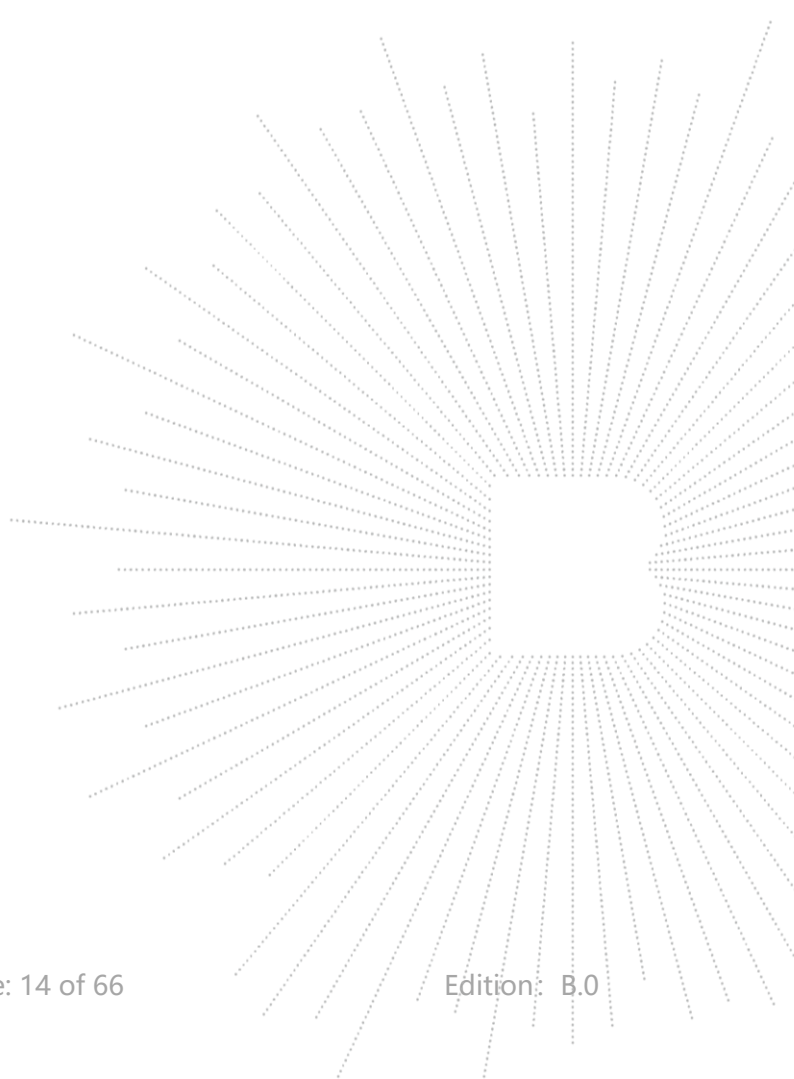

6.5 Test Result

Temperature:	26 °C	Relative Humidity:	54%
Pressure:	101KPa	Test Voltage :	AC 30V/60Hz
Test Mode:	Mode 3	Polarization :	L

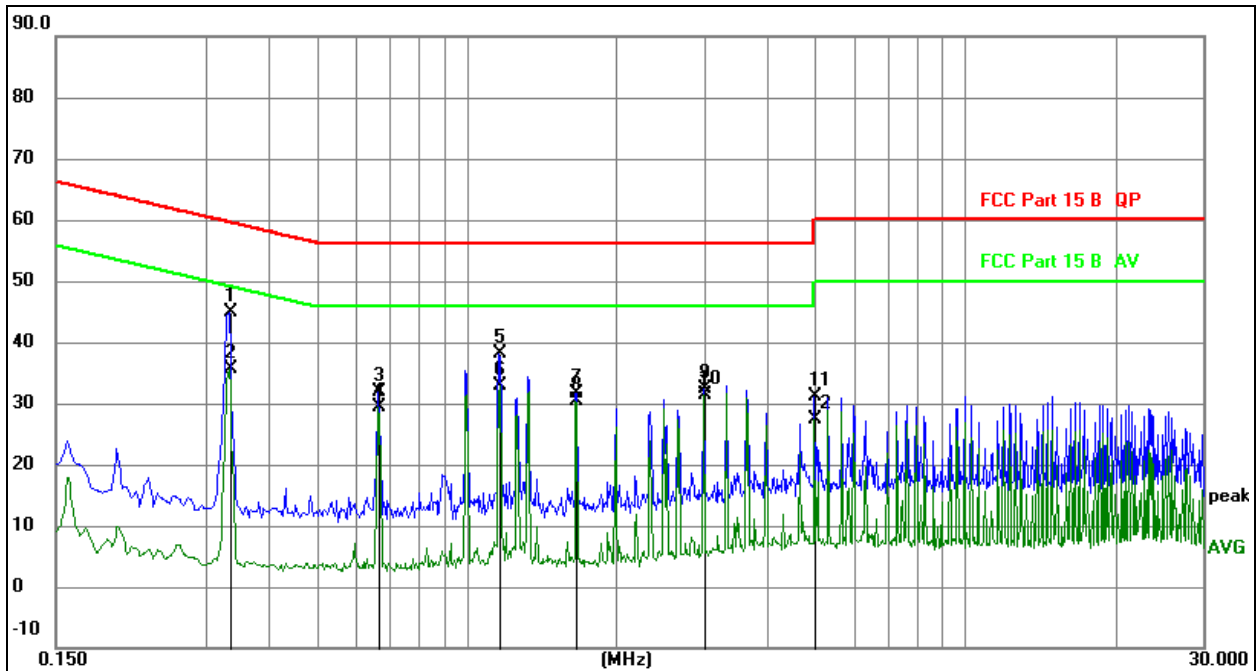

Remark:

1. All readings are Quasi-Peak and Average values.
2. Factor = Insertion Loss + Cable Loss.
3. Measurement=Reading Level+ Correct Factor
4. Over= Measurement-Limit

No.	Mk.	Freq.	Reading Level	Correct Factor	Measurement	Limit	Over	Detector	Comment
		MHz	dB	dB	dBuV	dBuV	dB		
1		0.3345	25.09	19.83	44.92	59.34	-14.42	QP	
2		0.3345	15.89	19.83	35.72	49.34	-13.62	AVG	
3		0.6674	12.12	19.84	31.96	56.00	-24.04	QP	
4		0.6674	9.56	19.84	29.40	46.00	-16.60	AVG	
5		1.1624	18.29	19.95	38.24	56.00	-17.76	QP	
6	*	1.1624	12.99	19.95	32.94	46.00	-13.06	AVG	
7		1.6619	11.78	19.95	31.73	56.00	-24.27	QP	
8		1.6619	10.40	19.95	30.35	46.00	-15.65	AVG	
9		2.9940	12.17	20.30	32.47	56.00	-23.53	QP	
10		2.9940	11.10	20.30	31.40	46.00	-14.60	AVG	
11		4.9920	10.75	20.43	31.18	56.00	-24.82	QP	
12		4.9920	7.00	20.43	27.43	46.00	-18.57	AVG	

Temperature:	26 °C	Relative Humidity:	54%
Pressure:	101KPa	Test Voltage :	AC 30V/60Hz
Test Mode:	Mode 3	Polarization :	N

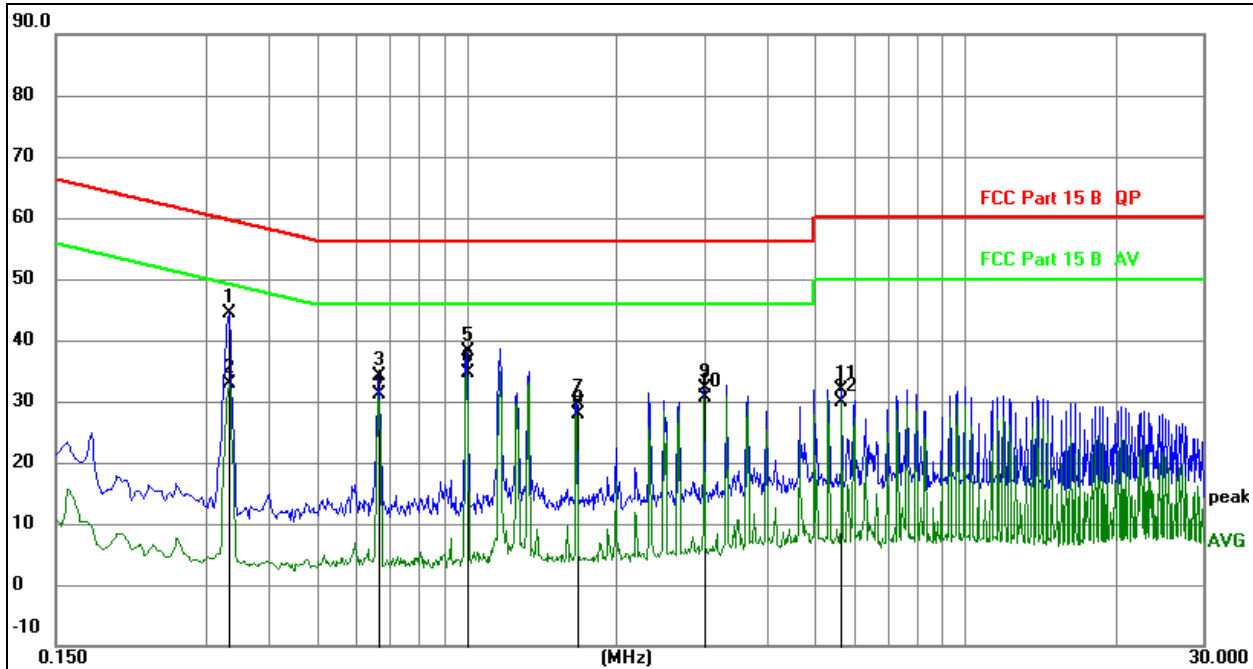
Remark:

1. All readings are Quasi-Peak and Average values.
2. Factor = Insertion Loss + Cable Loss.
3. Measurement=Reading Level+ Correct Factor
4. Over= Measurement-Limit

No. Mk.	Freq.	Reading Level	Correct Factor	Measurement	Limit	Over	Detector	Comment
	MHz		dB	dBuV	dBuV	dB		
1	0.3338	24.59	19.83	44.42	59.36	-14.94	QP	
2	0.3338	13.15	19.83	32.98	49.36	-16.38	AVG	
3	0.6648	14.35	19.84	34.19	56.00	-21.81	QP	
4	0.6648	11.17	19.84	31.01	46.00	-14.99	AVG	
5	0.9997	18.08	19.95	38.03	56.00	-17.97	QP	
6 *	0.9997	14.71	19.95	34.66	46.00	-11.34	AVG	
7	1.6625	9.76	19.95	29.71	56.00	-26.29	QP	
8	1.6625	7.94	19.95	27.89	46.00	-18.11	AVG	
9	2.9935	11.75	20.30	32.05	56.00	-23.95	QP	
10	2.9935	10.33	20.30	30.63	46.00	-15.37	AVG	
11	5.6531	11.70	20.27	31.97	60.00	-28.03	QP	
12	5.6531	9.61	20.27	29.88	50.00	-20.12	AVG	

7. Radiated Emissions

7.1 Block Diagram Of Test Setup

(A) Radiated Emission Test-Up Frequency Below 30MHz

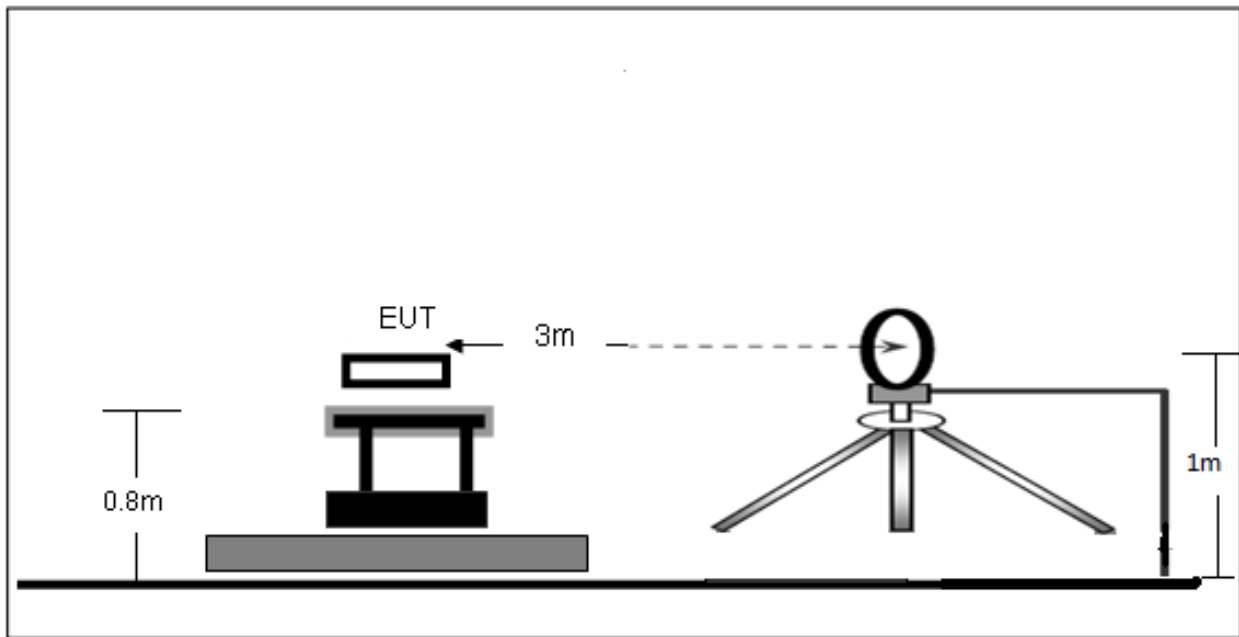

(B) Radiated Emission Test-Up Frequency 30MHz~1GHz

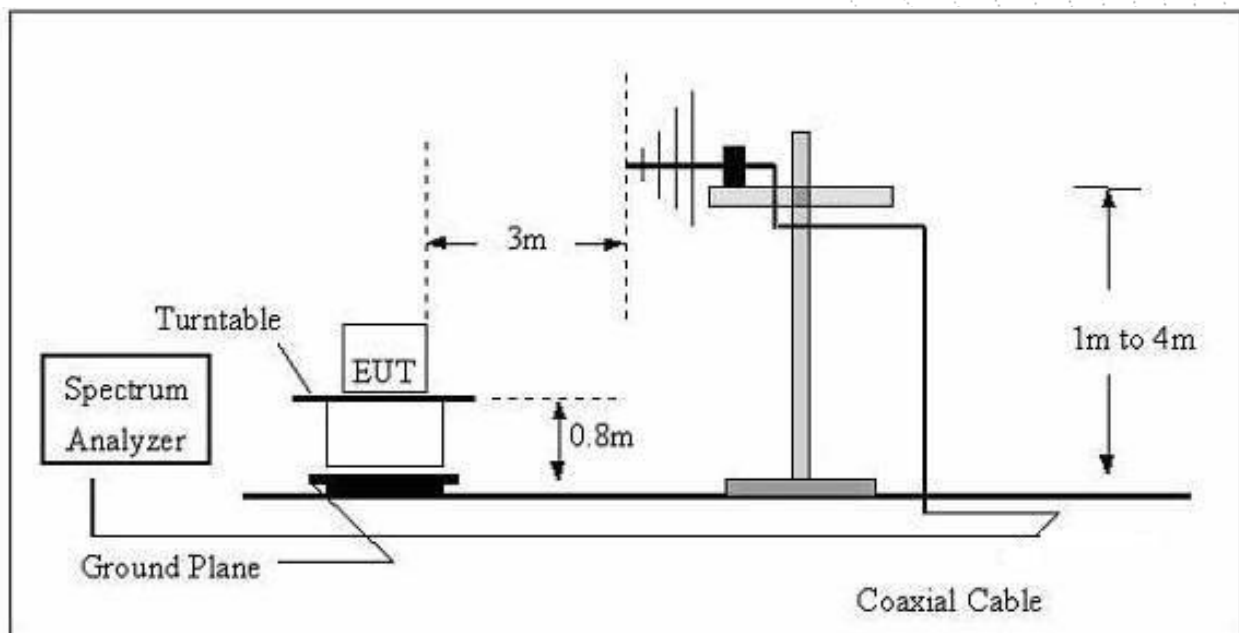

(C) Radiated Emission Test-Up Frequency Above 1GHz

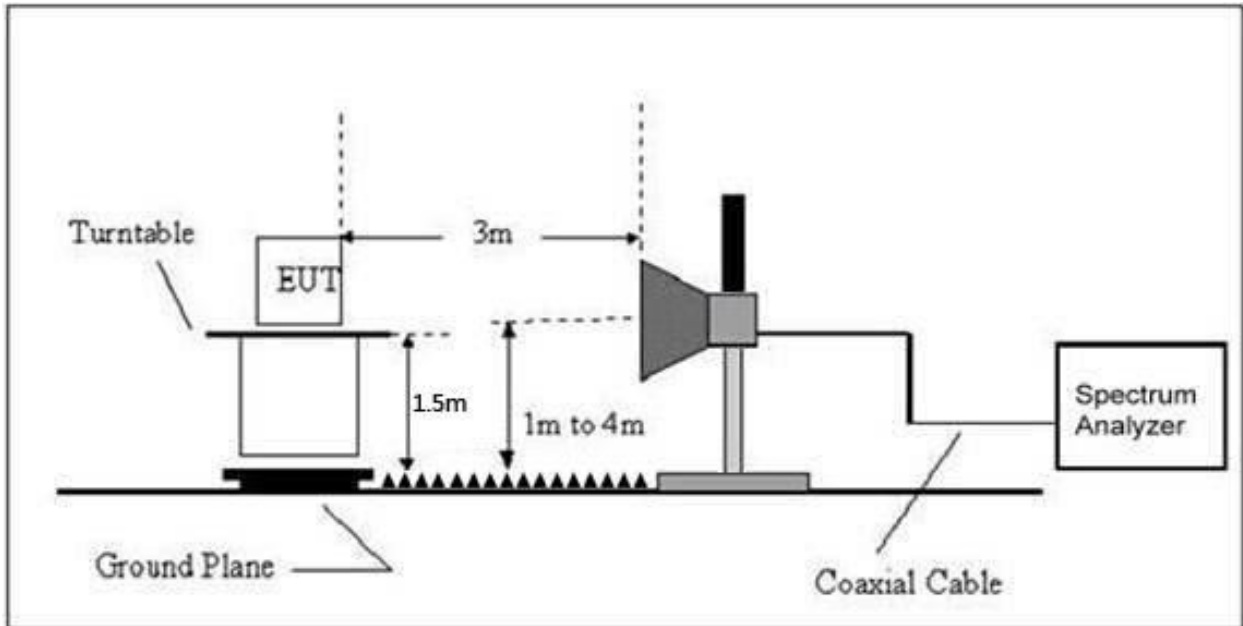

7.2 Limit

20dBc in any 100 kHz bandwidth outside the operating frequency band. In case the emission fall within the restricted band specified on 15.205(a), then the 15.209(a) limit in the table below has to be followed.

Frequency (MHz)	Field Strength uV/m	Distance (m)	Field Strength Limit at 3m Distance	
			uV/m	dBuV/m
0.009 ~ 0.490	$2400/F(\text{kHz})$	300	$10000 * 2400/F(\text{kHz})$	$20\log^{(2400/F(\text{kHz}))} + 80$
0.490 ~ 1.705	$24000/F(\text{kHz})$	30	$100 * 24000/F(\text{kHz})$	$20\log^{(24000/F(\text{kHz}))} + 40$
1.705 ~ 30	30	30	$100 * 30$	$20\log^{(30)} + 40$
30 ~ 88	100	3	100	$20\log^{(100)}$
88 ~ 216	150	3	150	$20\log^{(150)}$
216 ~ 960	200	3	200	$20\log^{(200)}$
Above 960	500	3	500	$20\log^{(500)}$

Limits Of Radiated Emission Measurement (Above 1000MHz)

Frequency (MHz)	Limit (dBuV/m) (at 3M)	
	Peak	Average
Above 1000	74	54

Notes:

- (1)The limit for radiated test was performed according to FCC PART 15C.
- (2)The tighter limit applies at the band edges.
- (3) Emission level (dBuV/m)=20log Emission level (uV/m).

7.3 Test Procedure

The test site semi-anechoic chamber has met the requirement of NSA tolerance 4 dB according to the standards: ANSI C63.10-2013. The test distance is 3m. The setup is according to the requirements in Section 13.1.4.1 of ANSI C63.10-2013 and CAN/CSA-CEI/IEC CISPR 22.

This test is required for any spurious emission that falls in a Restricted Band, as defined in Section 15.205.

It must be performed with the highest gain of each type of antenna proposed for use with the EUT. Use the following spectrum analyzer settings:

Spectrum Parameter	Setting
Attenuation	Auto
Start Frequency	1000 MHz
Stop Frequency	10th carrier harmonic
RB / VB (emission in restricted band)	1 MHz / 1 MHz for Peak, 1 MHz / 10Hz for Average

Receiver Parameter	Setting
Attenuation	Auto
Start ~ Stop Frequency	9kHz~150kHz / RB 200Hz for QP
Start ~ Stop Frequency	150kHz~30MHz / RB 9kHz for QP
Start ~ Stop Frequency	30MHz~1000MHz / RB 120kHz for QP

- a. The measuring distance of at 3 m shall be used for measurements at frequency up to 1GHz. For frequencies above 1GHz, any suitable measuring distance may be used.
- b. The EUT was placed on the top of a rotating table 0.8 m for below 1GHz and 1.5m for above 1GHz the ground at a 3 meter. The table was rotated 360 degrees to determine the position of the highest radiation.
- c. The height of the equipment or of the substitution antenna shall be 0.8 m for below 1GHz and 1.5m for above 1GHz; the height of the test antenna shall vary between 1 m to 4 m. Both horizontal and vertical polarizations of the antenna are set to make the measurement.
- d. The initial step in collecting conducted emission data is a spectrum analyzer peak detector mode pre-scanning the measurement frequency range. Significant peaks are then marked and then Quasi Peak detector mode re-measured.
- e. If the Peak Mode measured value compliance with and lower than Quasi Peak Mode Limit, the EUT shall be deemed to meet QP Limits and then no additional QP Mode measurement performed.
- f. For the actual test configuration, please refer to the related Item –EUT Test Photos.

Note:

Both horizontal and vertical antenna polarities were tested and performed pretest to three orthogonal axis. The worst case emissions were reported

During the radiated emission test, the Spectrum Analyzer was set with the following configurations:

Frequency Band (MHz)	Function	Resolution bandwidth	Video Bandwidth
30 to 1000	QP	120 kHz	300 kHz
Above 1000	Peak	1 MHz	1 MHz
	Average	1 MHz	10 Hz

Note: for the frequency ranges below 30 MHz, a narrower RBW is used for these ranges but the measured value should add a RBW correction factor (RBWCF) where $RBWCF [dB] = 10 \cdot \lg(100 [kHz]/\text{narrower RBW [kHz]})$. , the narrower RBW is 1 kHz and RBWCF is 20 dB for the frequency 9 kHz to 150 kHz, and the narrower RBW is 10 kHz and RBWCF is 10 dB for the frequency 150 kHz to 30 MHz.

7.4 EUT Operating Conditions

The EUT was configured for testing in a typical fashion (as a customer would normally use it). The EUT has been programmed to continuously transmit during test. This operating condition was tested and used to collect the included data.

7.5 Test Result

Below 30MHz

Temperature:	26°C	Relative Humidity:	24%
Pressure:	101 kPa	Test Voltage:	AC 30V/60Hz
Test Mode:	Mode 3	Polarization:	--

Freq. (MHz)	Reading (dBuV/m)	Limit (dBuV/m)	Margin (dB)	State P/F
--	--	--	--	PASS
--	--	--	--	PASS

Note:

The amplitude of spurious emissions which are attenuated by more than 20dB below the permissible value has no need to be reported.

Distance extrapolation factor = $40 \log(\text{specific distance}/\text{test distance})(dB)$;

Limit line = specific limits(dBuv) + distance extrapolation factor.

Between 30MHz – 1GHz

Temperature:	26°C	Relative Humidity:	54%
Pressure:	101 kPa	Test Voltage :	AC 30V/60Hz
Test Mode :	Mode 3	Polarization :	Horizontal

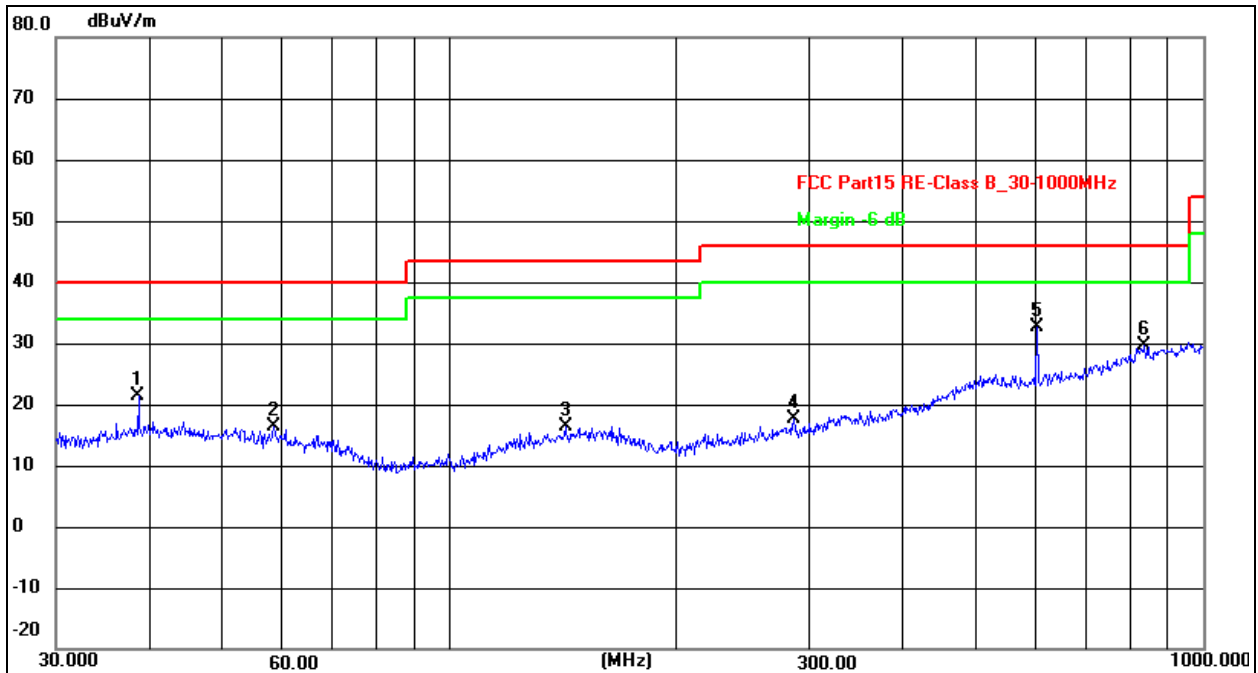
Remark:

1. Factor = Antenna Factor + Cable Loss – Pre-amplifier.
2. Measurement=Reading Level+ Correct Factor
3. Over= Measurement-Limit

No.	Frequency (MHz)	Reading (dBuV)	Factor (dB/m)	Level (dBuV/m)	Limit (dBuV/m)	Margin (dB)	Detector
1	38.6160	31.99	-10.50	21.49	40.00	-18.51	QP
2	58.4074	27.79	-11.52	16.27	40.00	-23.73	QP
3	142.3243	27.28	-10.99	16.29	43.50	-27.21	QP
4	285.9778	27.51	-9.82	17.69	46.00	-28.31	QP
5 *	601.4265	34.16	-1.42	32.74	46.00	-13.26	QP
6	836.2443	26.51	3.02	29.53	46.00	-16.47	QP

Temperature:	26°C	Relative Humidity:	54%
Pressure:	101 kPa	Test Voltage :	AC 30V/60Hz
Test Mode :	Mode 3	Polarization :	Vertical

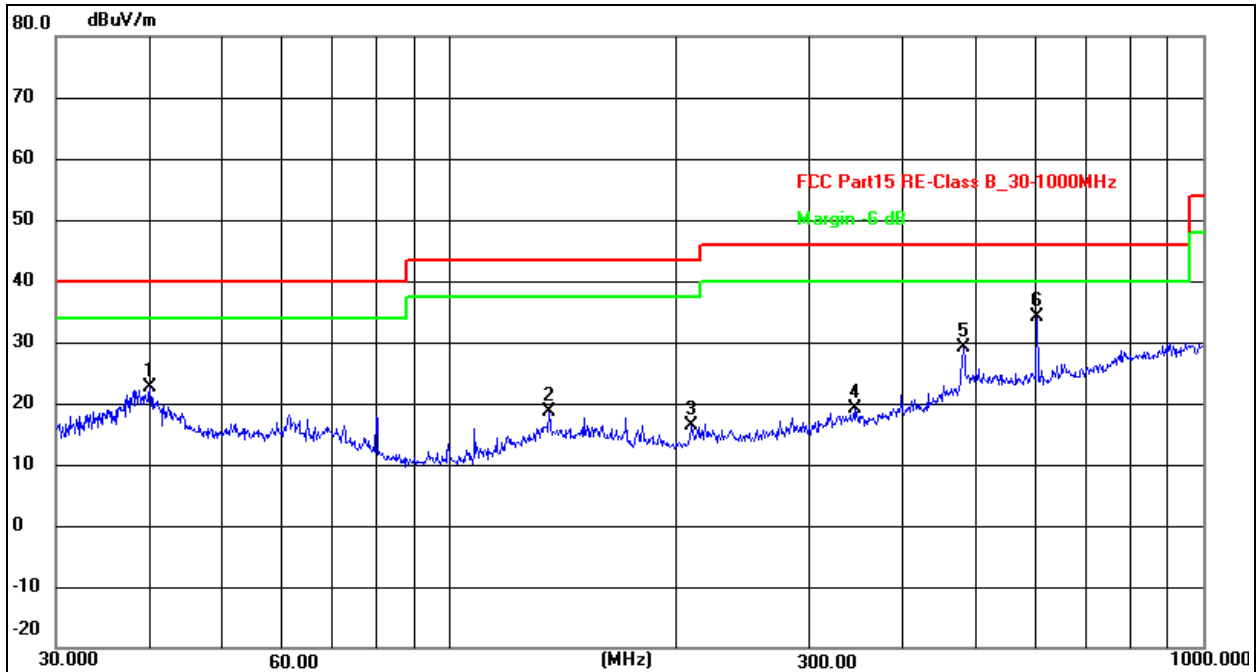
Remark:

1. Factor = Antenna Factor + Cable Loss – Pre-amplifier.
2. Measurement=Reading Level+ Correct Factor
3. Over= Measurement-Limit

No.	Frequency (MHz)	Reading (dBuV)	Factor (dB/m)	Level (dBuV/m)	Limit (dBuV/m)	Margin (dB)	Detector
1	39.9942	32.99	-10.24	22.75	40.00	-17.25	QP
2	135.5061	29.93	-11.30	18.63	43.50	-24.87	QP
3	209.3129	29.67	-13.18	16.49	43.50	-27.01	QP
4	344.3855	27.20	-8.18	19.02	46.00	-26.98	QP
5	480.5276	32.07	-2.87	29.20	46.00	-16.80	QP
6 *	601.4265	35.64	-1.42	34.22	46.00	-11.78	QP

Test Mode :	TX(5.1G) - 802.11a
-------------	--------------------

Polar (H/V)	Frequency (MHz)	Reading Level (dBuV/m)	Correct Factor (dB)	Measurement (dBuV/m)	Limits (dBuV/m)	Over (dB)	Detector Type
Low Channel (5180 MHz)-Above 1G							
Vertical	4434.000	73.48	-20.73	52.75	68.2	-15.45	Pk
Vertical	4434.000	60.00	-20.73	39.27	54	-14.73	AV
Vertical	10360.113	62.47	-9.36	53.11	68.2	-15.09	Pk
Vertical	10360.113	49.60	-9.36	40.24	54	-13.76	AV
Vertical	15540.068	64.44	-7.84	56.60	74	-17.40	Pk
Vertical	15540.068	49.92	-7.84	42.08	54	-11.92	AV
Horizontal	4434.119	71.68	-20.73	50.95	68.2	-17.25	Pk
Horizontal	4434.119	59.62	-20.73	38.89	54	-15.11	AV
Horizontal	10360.086	60.65	-9.36	51.29	68.2	-16.91	Pk
Horizontal	10360.086	49.06	-9.36	39.70	54	-14.30	AV
Horizontal	15540.124	62.27	-7.84	54.43	74	-19.57	Pk
Horizontal	15540.124	49.06	-7.84	41.22	54	-12.78	AV
middle Channel (5200 MHz)-Above 1G							
Vertical	4592.051	72.72	-20.42	52.30	74	-21.70	Pk
Vertical	4592.051	59.69	-20.42	39.28	54	-14.72	AV
Vertical	10400.083	63.02	-9.30	53.72	68.2	-14.48	Pk
Vertical	10400.083	49.37	-9.30	40.07	54	-13.93	AV
Vertical	15600.146	61.27	-7.82	53.45	74	-20.55	Pk
Vertical	15600.146	49.28	-7.82	41.46	54	-12.54	AV
Horizontal	4592.189	70.77	-20.42	50.36	74	-23.64	Pk
Horizontal	4592.189	59.37	-20.42	38.95	54	-15.05	AV
Horizontal	10400.022	60.31	-9.30	51.01	68.2	-17.19	Pk
Horizontal	10400.022	49.28	-9.30	39.98	54	-14.02	AV
Horizontal	15600.146	62.05	-7.82	54.23	74	-19.77	Pk
Horizontal	15600.146	49.91	-7.82	42.09	54	-11.91	AV
High Channel (5240 MHz)-Above 1G							
Vertical	4739.153	70.21	-20.12	50.09	74	-23.91	Pk
Vertical	4739.153	59.08	-20.12	38.96	54	-15.04	AV
Vertical	10480.014	63.46	-9.18	54.28	68.2	-13.92	Pk
Vertical	10480.014	49.37	-9.18	40.19	54	-13.81	AV
Vertical	15720.080	61.67	-7.78	53.89	74	-20.11	Pk
Vertical	15720.080	49.66	-7.78	41.88	54	-12.12	AV
Horizontal	4739.075	73.24	-20.12	53.11	74	-20.89	Pk
Horizontal	4739.075	59.53	-20.12	39.41	54	-14.59	AV
Horizontal	10480.194	63.01	-9.18	53.83	68.2	-14.37	Pk
Horizontal	10480.194	49.69	-9.18	40.51	54	-13.49	AV
Horizontal	15720.106	63.83	-7.78	56.05	74	-17.95	Pk
Horizontal	15720.106	49.35	-7.78	41.57	54	-12.43	AV

Note: PK value is lower than the Average value limit, So average didn't record.

The 26.5-40G amplitude of spurious emissions that are attenuated by more than 20dB below the permissible value has no need to be reported.

Emission level (dBuV/m) = 20 log Emission level (uV/m).

Corrected Reading: Antenna Factor + Cable Loss + Read Level - Preamp Factor = Level.

Test Mode :	TX(5.1G) - 802.11n-HT20
-------------	-------------------------

Polar	Frequency	Reading Level	Correct Factor	Measurement	Limits	Over	Detector Type
(H/V)	(MHz)	(dBuV/m)	(dB)	(dBuV/m)	(dBuV/m)	(dB)	
Low Channel (5180 MHz)-Above 1G							
Vertical	4434.046	71.01	-20.73	50.28	68.2	-17.92	Pk
Vertical	4434.046	59.32	-20.73	38.59	54	-15.41	AV
Vertical	10360.037	62.67	-9.36	53.31	68.2	-14.89	Pk
Vertical	10360.037	49.52	-9.36	40.16	54	-13.84	AV
Vertical	15540.131	64.52	-7.84	56.68	74	-17.32	Pk
Vertical	15540.131	49.39	-7.84	41.55	54	-12.45	AV
Horizontal	4434.073	73.40	-20.73	52.67	68.2	-15.53	Pk
Horizontal	4434.073	59.86	-20.73	39.13	54	-14.87	AV
Horizontal	10360.080	64.72	-9.36	55.36	68.2	-12.84	Pk
Horizontal	10360.080	49.47	-9.36	40.11	54	-13.89	AV
Horizontal	15540.144	62.13	-7.84	54.29	74	-19.71	Pk
Horizontal	15540.144	49.25	-7.84	41.41	54	-12.59	AV
middle Channel (5200 MHz)-Above 1G							
Vertical	4592.041	74.44	-20.42	54.03	74	-19.97	Pk
Vertical	4592.041	59.17	-20.42	38.75	54	-15.25	AV
Vertical	10400.008	64.85	-9.30	55.55	68.2	-12.65	Pk
Vertical	10400.008	49.50	-9.30	40.20	54	-13.80	AV
Vertical	15600.013	60.77	-7.82	52.95	74	-21.05	Pk
Vertical	15600.013	49.10	-7.82	41.28	54	-12.72	AV
Horizontal	4592.075	72.13	-20.42	51.71	74	-22.29	Pk
Horizontal	4592.075	59.62	-20.42	39.20	54	-14.80	AV
Horizontal	10400.048	63.46	-9.30	54.16	68.2	-14.04	Pk
Horizontal	10400.048	49.61	-9.30	40.31	54	-13.69	AV
Horizontal	15600.051	61.38	-7.82	53.56	74	-20.44	Pk
Horizontal	15600.051	49.07	-7.82	41.25	54	-12.75	AV
High Channel (5240 MHz)-Above 1G							
Vertical	4739.032	73.11	-20.12	52.99	74	-21.01	Pk
Vertical	4739.032	59.97	-20.12	39.85	54	-14.15	AV
Vertical	10480.128	61.97	-9.18	52.79	68.2	-15.41	Pk
Vertical	10480.128	49.49	-9.18	40.31	54	-13.69	AV
Vertical	15720.133	61.41	-7.78	53.63	74	-20.37	Pk
Vertical	15720.133	49.59	-7.78	41.81	54	-12.19	AV
Horizontal	4739.065	70.40	-20.12	50.27	74	-23.73	Pk
Horizontal	4739.065	59.98	-20.12	39.86	54	-14.14	AV
Horizontal	10480.066	64.65	-9.18	55.47	68.2	-12.73	Pk
Horizontal	10480.066	49.34	-9.18	40.16	54	-13.84	AV
Horizontal	15720.015	64.90	-7.78	57.12	74	-16.88	Pk
Horizontal	15720.015	49.74	-7.78	41.96	54	-12.04	AV

Note: PK value is lower than the Average value limit, So average didn't record.

The 26.5-40G amplitude of spurious emissions that are attenuated by more than 20dB below the permissible value has no need to be reported.

Emission level (dBuV/m) = 20 log Emission level (uV/m).

Corrected Reading: Antenna Factor + Cable Loss + Read Level - Preamp Factor = Level.

Test Mode :	TX(5.1G) - 802.11n-HT40
-------------	-------------------------

Polar	Frequency	Reading Level	Correct Factor	Measurement	Limits	Over	Detector Type
(H/V)	(MHz)	(dBuV/m)	(dB)	(dBuV/m)	(dBuV/m)	(dB)	
Low Channel (5190 MHz)-Above 1G							
Vertical	4434.143	70.79	-20.73	50.05	68.2	-18.15	Pk
Vertical	4434.143	59.11	-20.73	38.38	54	-15.62	AV
Vertical	10380.180	60.50	-9.33	51.17	68.2	-17.03	Pk
Vertical	10380.180	49.50	-9.33	40.17	54	-13.83	AV
Vertical	15570.189	64.78	-7.83	56.95	74	-17.05	Pk
Vertical	15570.189	49.72	-7.83	41.89	54	-12.11	AV
Horizontal	4434.006	72.97	-20.73	52.24	74	-21.76	Pk
Horizontal	4434.006	59.58	-20.73	38.85	54	-15.15	AV
Horizontal	10380.031	63.99	-9.33	54.66	68.2	-13.54	Pk
Horizontal	10380.031	49.16	-9.33	39.83	54	-14.17	AV
Horizontal	15570.023	60.08	-7.83	52.25	74	-21.75	Pk
Horizontal	15570.023	49.40	-7.83	41.57	54	-12.43	AV
High Channel (5230 MHz)-Above 1G							
Vertical	4739.029	70.38	-20.12	50.26	68.2	-17.94	Pk
Vertical	4739.029	59.25	-20.12	39.13	54	-14.87	AV
Vertical	10460.022	60.51	-9.21	51.30	68.2	-16.90	Pk
Vertical	10460.022	49.02	-9.21	39.81	54	-14.19	AV
Vertical	15690.006	63.76	-7.79	55.97	74	-18.03	Pk
Vertical	15690.006	49.40	-7.79	41.61	54	-12.39	AV
Horizontal	4739.064	71.09	-20.12	50.97	68.2	-17.23	Pk
Horizontal	4739.064	59.27	-20.12	39.14	54	-14.86	AV
Horizontal	10460.082	60.66	-9.21	51.45	68.2	-16.75	Pk
Horizontal	10460.082	49.16	-9.21	39.95	54	-14.05	AV
Horizontal	15690.034	64.26	-7.79	56.47	74	-17.53	Pk
Horizontal	15690.034	49.18	-7.79	41.39	54	-12.61	AV

Note: PK value is lower than the Average value limit, So average didn't record.
 The 26.5-40G amplitude of spurious emissions that are attenuated by more than 20dB below the permissible value has no need to be reported.
 Emission level (dBuV/m) = 20 log Emission level (uV/m).
 Corrected Reading: Antenna Factor + Cable Loss + Read Level - Preamp Factor = Level.

- Undesirable radiated Undesirable radiated Spurious Emission in Band Edge
- All the modes 802.11a/n has been tested and the worst result 802.11n20 recorded as below:

Test mode: 802.11n20 Frequency(MHz): 5180

Frequency (MHz)	Polarity	PK(dBuV/m) (VBW=3MHz)	Limit 3m (dBuV/m)	AV(dBuV/m) (VBW=10Hz)	Limit 3m (dBuV/m)
5149.30	H	59.62	74	46.21	54
5148.10	V	57.73	74	45.71	54

Test mode: 802.11n20 Frequency(MHz): 5240

Frequency (MHz)	Polarity	PK(dBuV/m) (VBW=3MHz)	Limit 3m (dBuV/m)	AV(dBuV/m) (VBW=10Hz)	Limit 3m (dBuV/m)
5300.70	H	62.14	74	48.37	54
5300.30	V	56.76	74	45.21	54

- Note:** (1) All Readings are Peak Value (VBW=3MHz) and Average Value (VBW=10Hz).
 (2) Emission Level= Reading Level+Correct Factor.
 (3) Correct Factor= Ant_F + Cab_L - Preamp

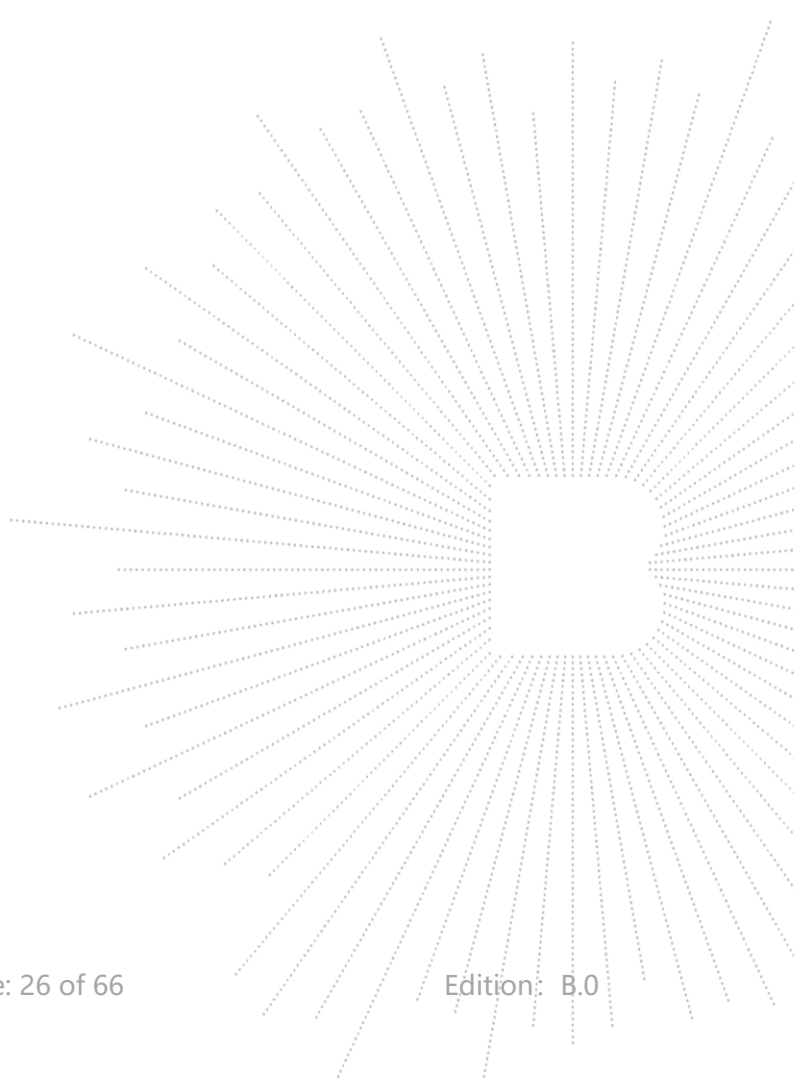

U-NII - 1

Test Model Undesirable radiated Spurious Emission in Restricted Band (5100-5150MHz)

802.11a 802.11n(HT20) 802.11n(HT40)
 5180 5200 5240 Ant.Pol H

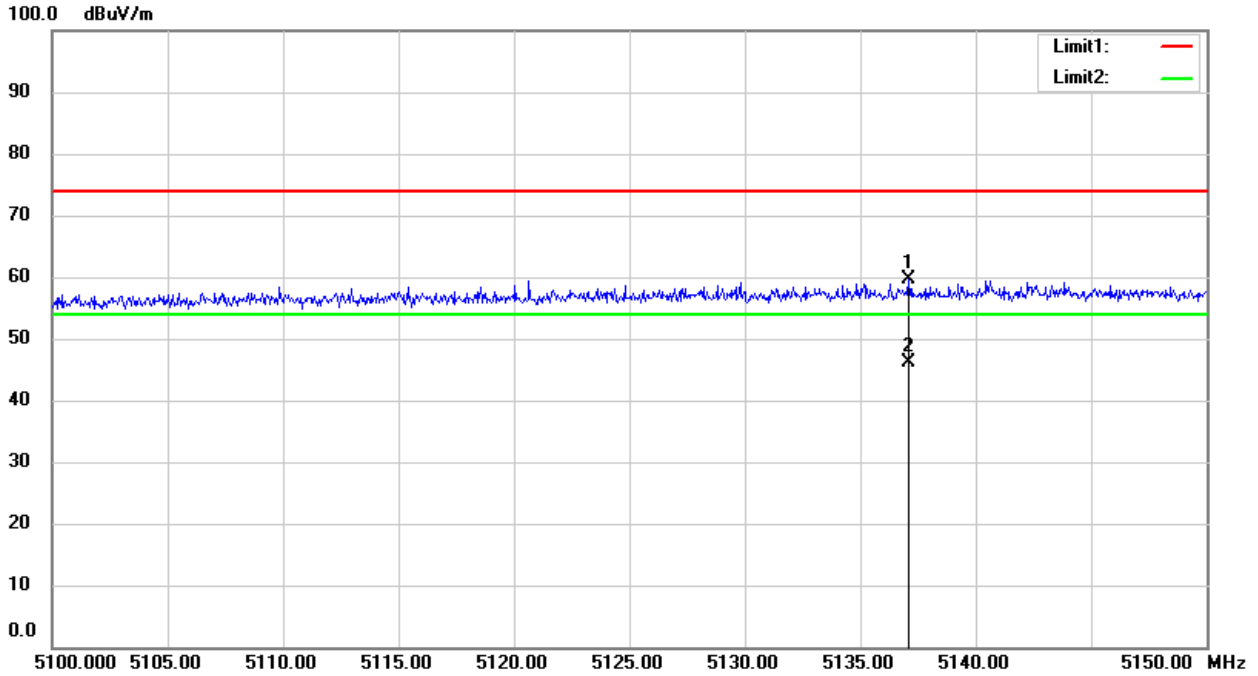

U-NII - 1

Test Model Undesirable radiated Spurious Emission in Restricted Band (5100-5150MHz)

802.11a 802.11n(HT20) 802.11n(HT40)
 5180 5200 5240 Ant.Pol V

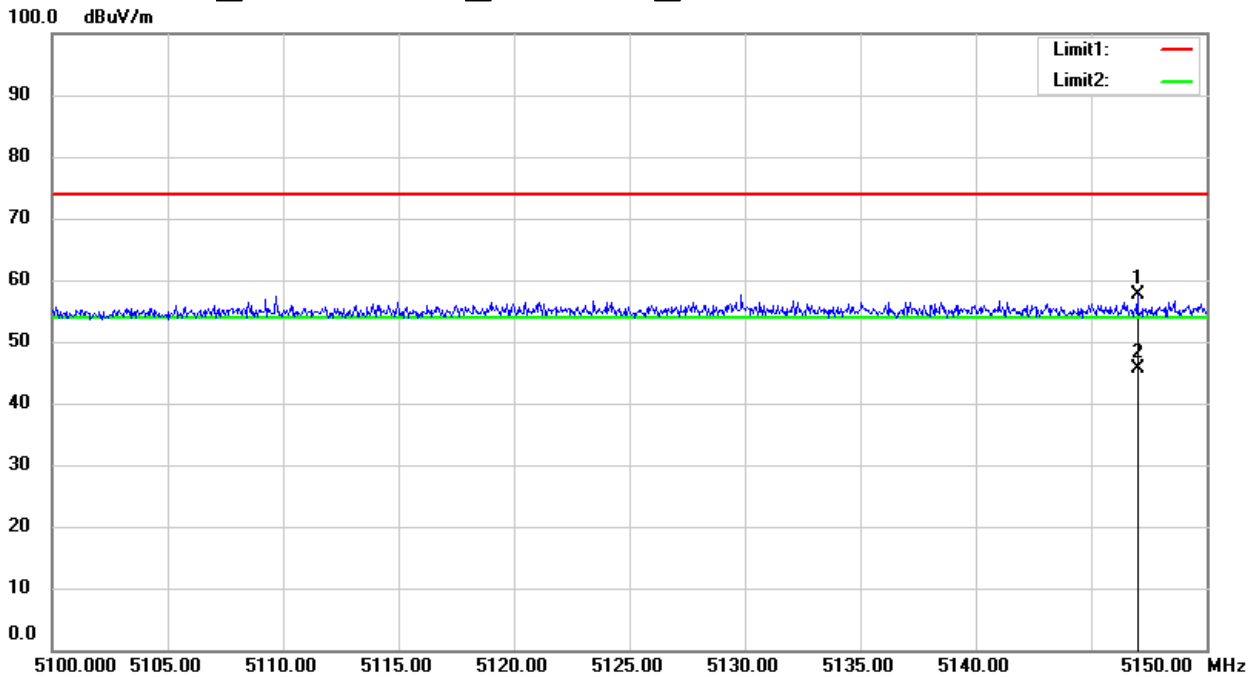

U-NII - 1

Test Model Undesirable radiated Spurious Emission in Restricted Band (5350-5400MHz)

802.11a 802.11n(HT20) 802.11n(HT40)
 5180 5200 5240 Ant.Pol H

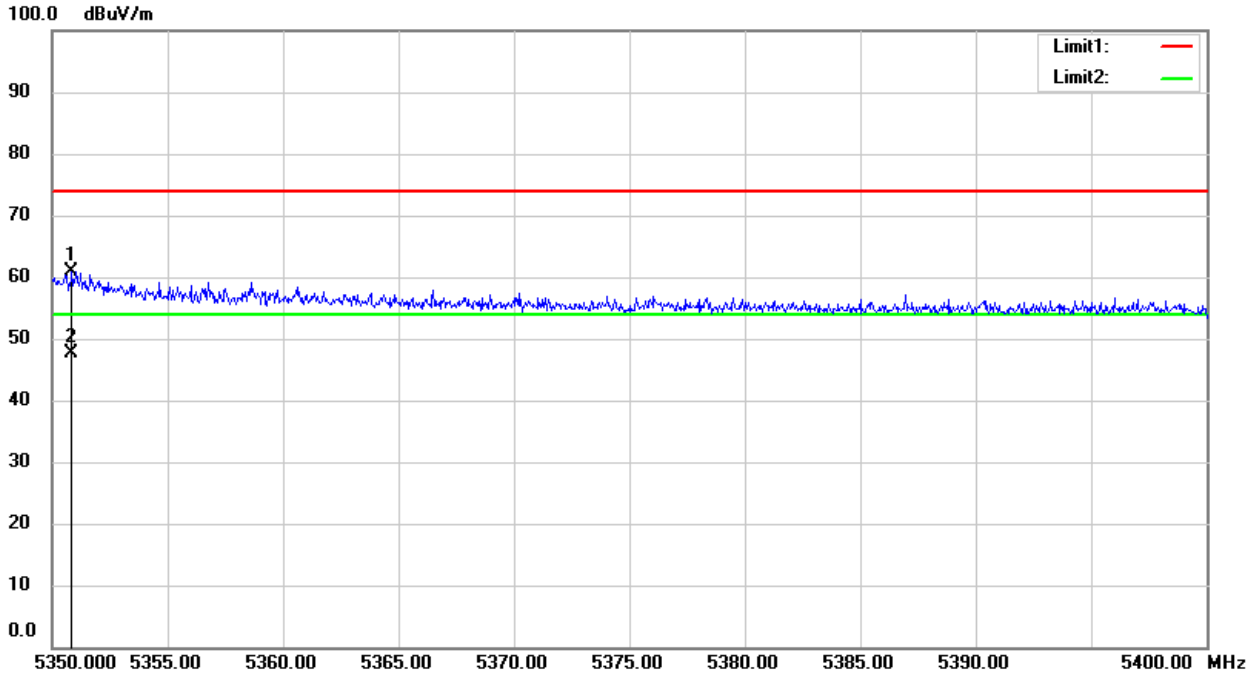

U-NII - 1

Test Model Undesirable radiated Spurious Emission in Restricted Band (5350-5400MHz)

802.11a 802.11n(HT20) 802.11n(HT40)
 5180 5200 5240 Ant.Pol V

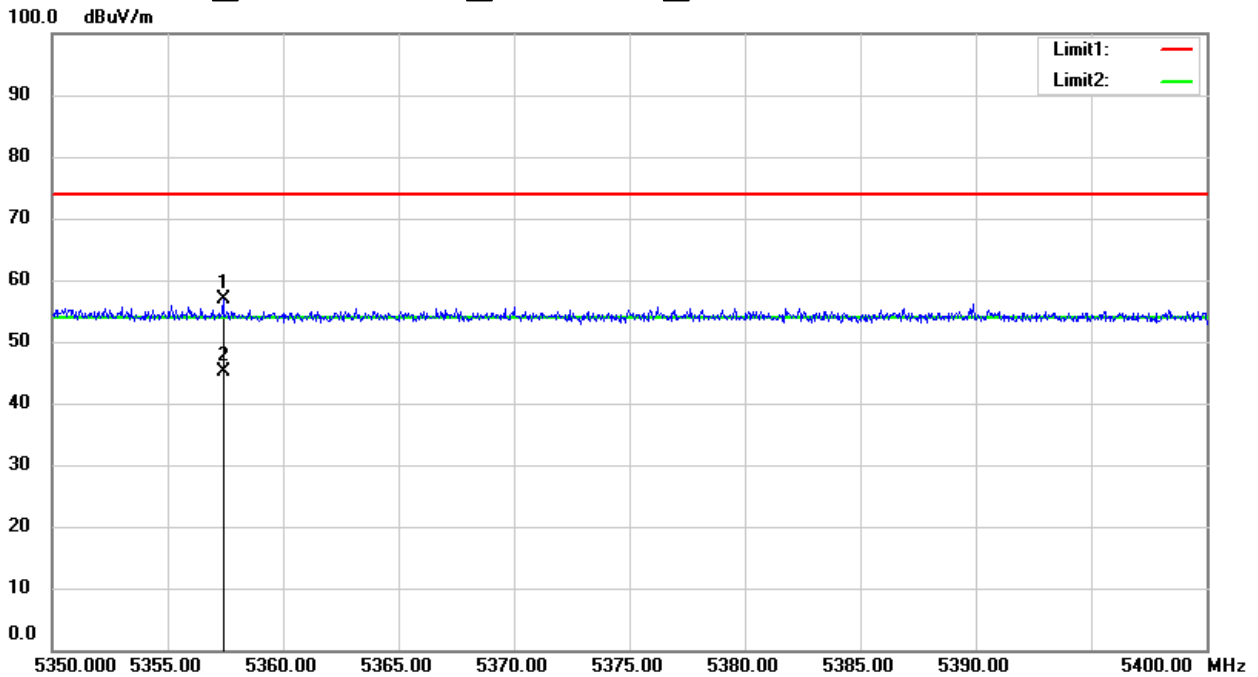

8. Power Spectral Density Test

8.1 Block Diagram Of Test Setup

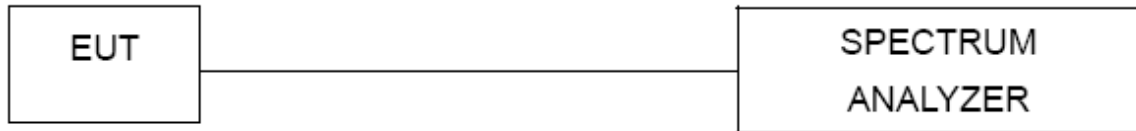

8.2 Limit

For the band 5.15-5.25 GHz,

(i) For an outdoor access point operating in the band 5.15-5.25 GHz, the maximum power spectral density shall not exceed 17 dBm in any 1 megahertz band. If transmitting antennas of directional gain greater than 6 dBi are used, both the maximum conducted output power and the maximum power spectral density shall be reduced by the amount in dB that the directional gain of the antenna exceeds 6 dBi. The maximum e.i.r.p. at any elevation angle above 30 degrees as measured from the horizon must not exceed 125 mW (21 dBm).

(ii) For an indoor access point operating in the band 5.15-5.25 GHz, the maximum power spectral density shall not exceed 17 dBm in any 1 megahertz band. If transmitting antennas of directional gain greater than 6 dBi are used, both the maximum conducted output power and the maximum power spectral density shall be reduced by the amount in dB that the directional gain of the antenna exceeds 6 dBi.

(iii) For fixed point-to-point access points operating in the band 5.15-5.25 GHz, the maximum power spectral density shall not exceed 17 dBm in any 1 megahertz band. Fixed point-to-point U-NII devices may employ antennas with directional gain up to 23 dBi without any corresponding reduction in the maximum conducted output power or maximum power spectral density. For fixed point-to-point transmitters that employ a directional antenna gain greater than 23 dBi, a 1 dB reduction in maximum conducted output power and maximum power spectral density is required for each 1 dB of antenna gain in excess of 23 dBi. Fixed, point-to-point operations exclude the use of point-to-multipoint systems, omnidirectional applications, and multiple collocated transmitters transmitting the same information. The operator of the U-NII device, or if the equipment is professionally installed, the installer, is responsible for ensuring that systems employing high gain directional antennas are used exclusively for fixed, point-to-point operations.

(iv) For client devices in the 5.15-5.25 GHz band, the maximum power spectral density shall not exceed 11 dBm in any 1 megahertz band. If transmitting antennas of directional gain greater than 6 dBi are used, both the maximum conducted output power and the maximum power spectral density shall be reduced by the amount in dB that the directional gain of the antenna exceeds 6 dBi.

For the band 5.725-5.85 GHz

(3) For the band 5.725-5.85 GHz, the maximum power spectral density shall not exceed 30 dBm in any 500-kHz band. If transmitting antennas of directional gain greater than 6 dBi are used, both the maximum conducted output power and the maximum power spectral density shall be reduced by the amount in dB that the directional gain of the antenna exceeds 6 dBi.

8.3 Test Procedure

For devices operating in the bands 5.15-5.25 GHz, 5.25-5.35 GHz, and 5.47-5.725 GHz, the above procedures make use of 1 MHz RBW to satisfy directly the 1 MHz reference bandwidth specified in § 15.407(a)(5). For devices operating in the band 5.725-5.85 GHz, the rules specify a measurement bandwidth of 500 kHz. Many spectrum analyzers do not have 500 kHz RBW, thus a narrower RBW may need to be used. The rules permit the use of a RBWs less than 1 MHz, or 500 kHz, “provided that the measured power is integrated over the full reference bandwidth” to show the total power over the specified measurement bandwidth (i.e., 1 MHz, or 500 kHz). If measurements are performed using a reduced resolution bandwidth (< 1 MHz, or < 500 kHz) and integrated over 1 MHz, or 500 KHz bandwidth, the following adjustments to the procedures apply:

- a) Set $RBW \geq 1/T$, where T is defined in section II.B.I.a).
- b) Set $VBW \geq 3 RBW$.
- c) If measurement bandwidth of Maximum PSD is specified in 500 kHz, add $10\log(500\text{kHz}/RBW)$ to the measured result, whereas $RBW (< 500 \text{ KHz})$ is the reduced resolution bandwidth of the spectrum analyzer set during measurement.
- d) If measurement bandwidth of Maximum PSD is specified in 1 MHz, add $10\log(1\text{MHz}/RBW)$ to the measured result, whereas $RBW (< 1 \text{ MHz})$ is the reduced resolution bandwidth of spectrum analyzer set during measurement.
- e) Care must be taken to ensure that the measurements are performed during a period of continuous transmission or are corrected upward for duty cycle.

Note: As a practical matter, it is recommended to use reduced RBW of 100 KHz for the sections 5.c) and 5.d) above, since $RBW=100 \text{ KHz}$ is available on nearly all spectrum analyzers.

8.4 EUT Operating Conditions

The EUT was configured for testing in a typical fashion (as a customer would normally use it). The EUT has been programmed to continuously transmit during test. This operating condition was tested and used to collect the included data.

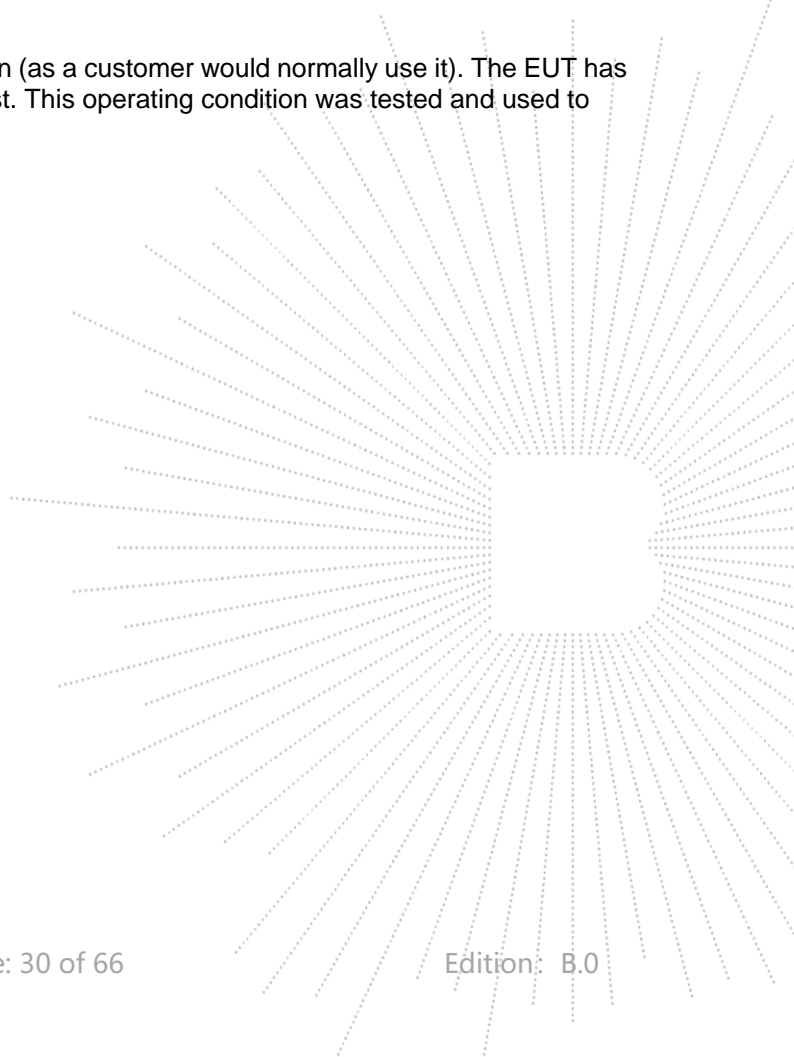

8.5 Test Result

Temperature:	26 °C	Relative Humidity:	54%
Pressure:	101KPa	Test Voltage:	AC 30V
Test Mode:	(5180-5240MHz)		

Condition	Mode	Frequency (MHz)	Conducted PSD (dBm/MHz)	Limit (dBm/MHz)	Verdict
NVNT	a	5180	0.56	11	Pass
NVNT	a	5200	0.76	11	Pass
NVNT	a	5240	0.47	11	Pass
NVNT	n20	5180	0	11	Pass
NVNT	n20	5200	-0.42	11	Pass
NVNT	n20	5240	-0.53	11	Pass
NVNT	n40	5190	-2.35	11	Pass
NVNT	n40	5230	-1.48	11	Pass

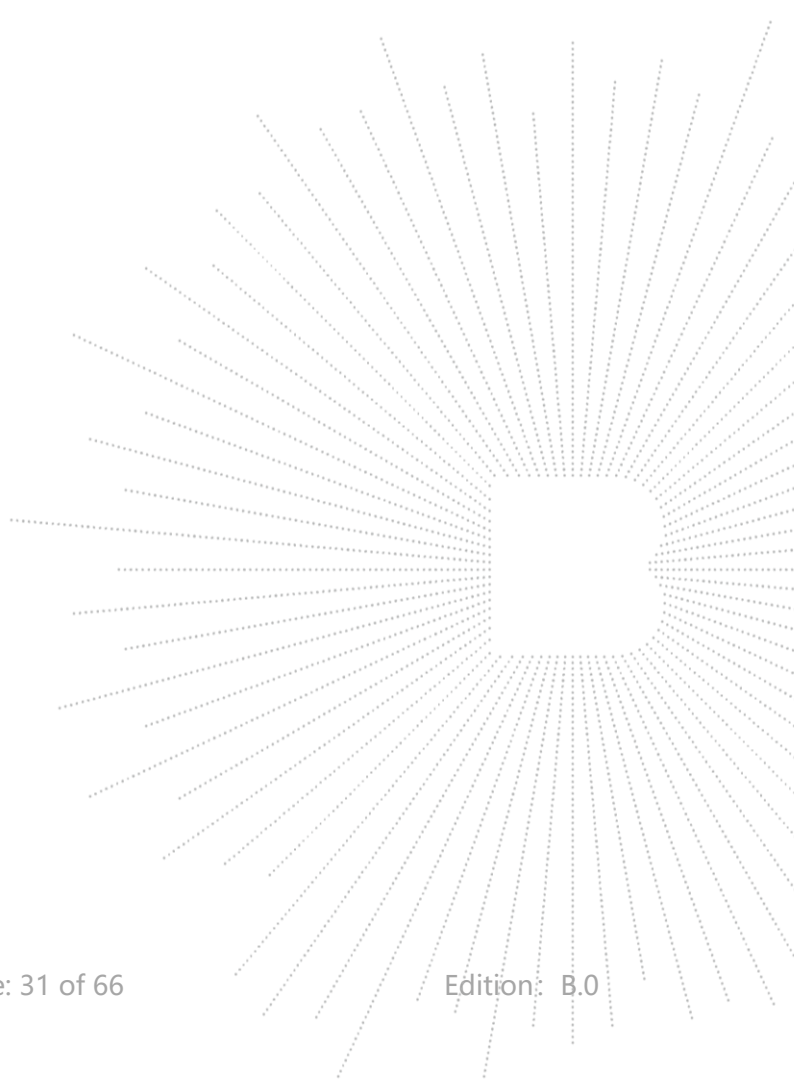

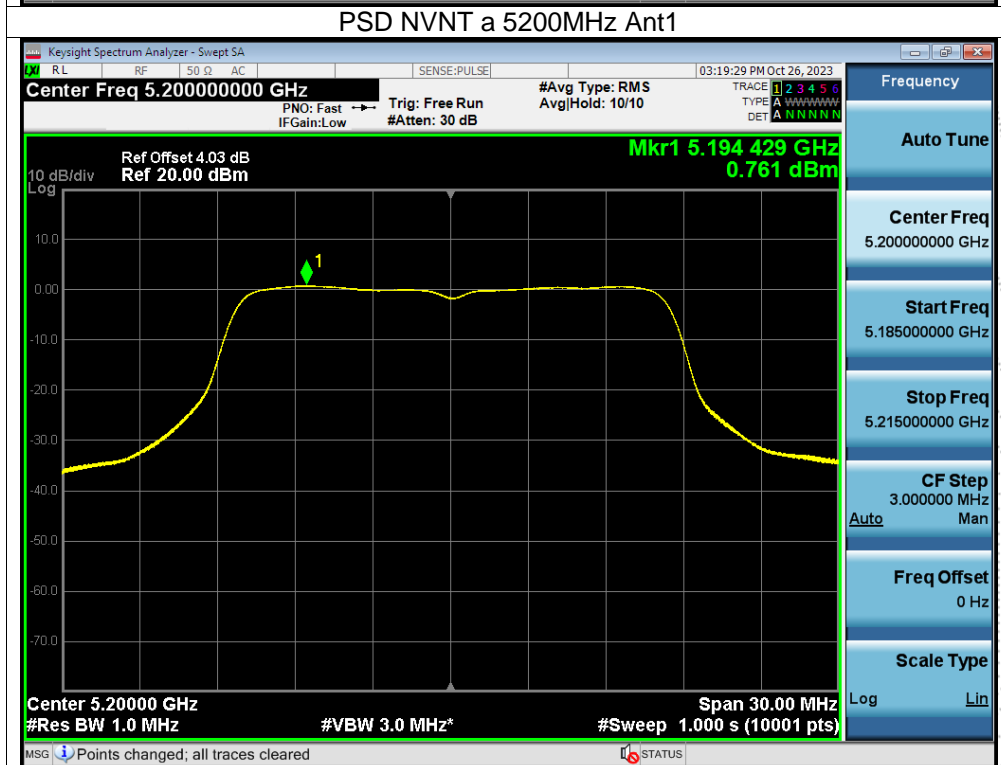
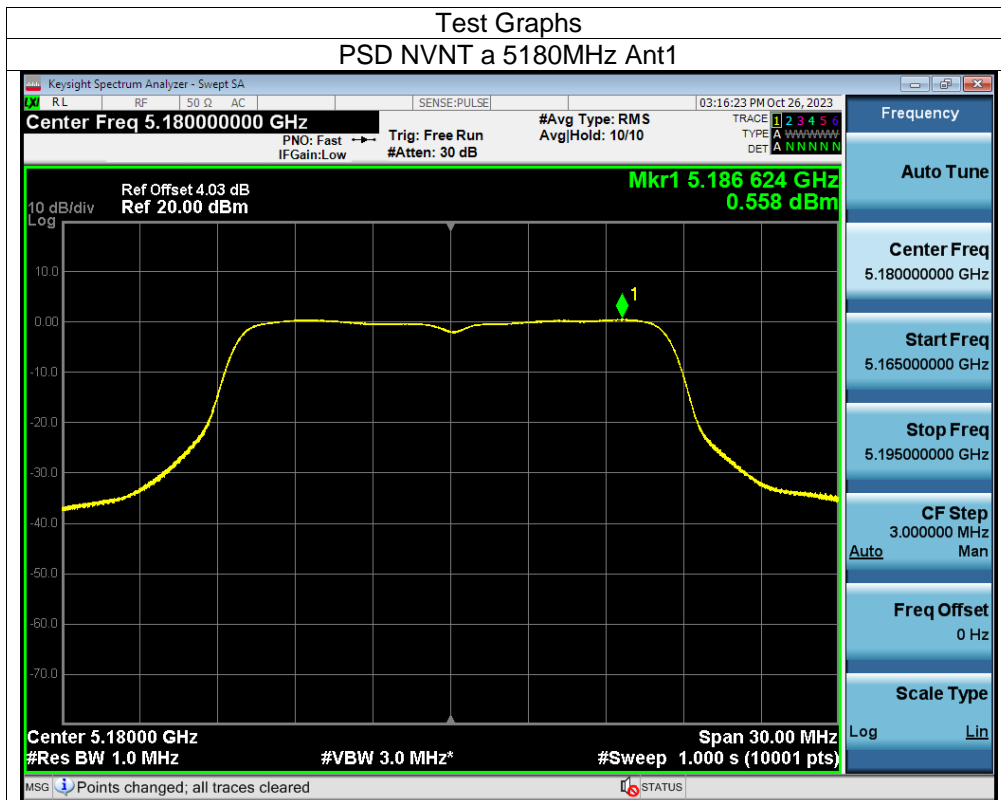

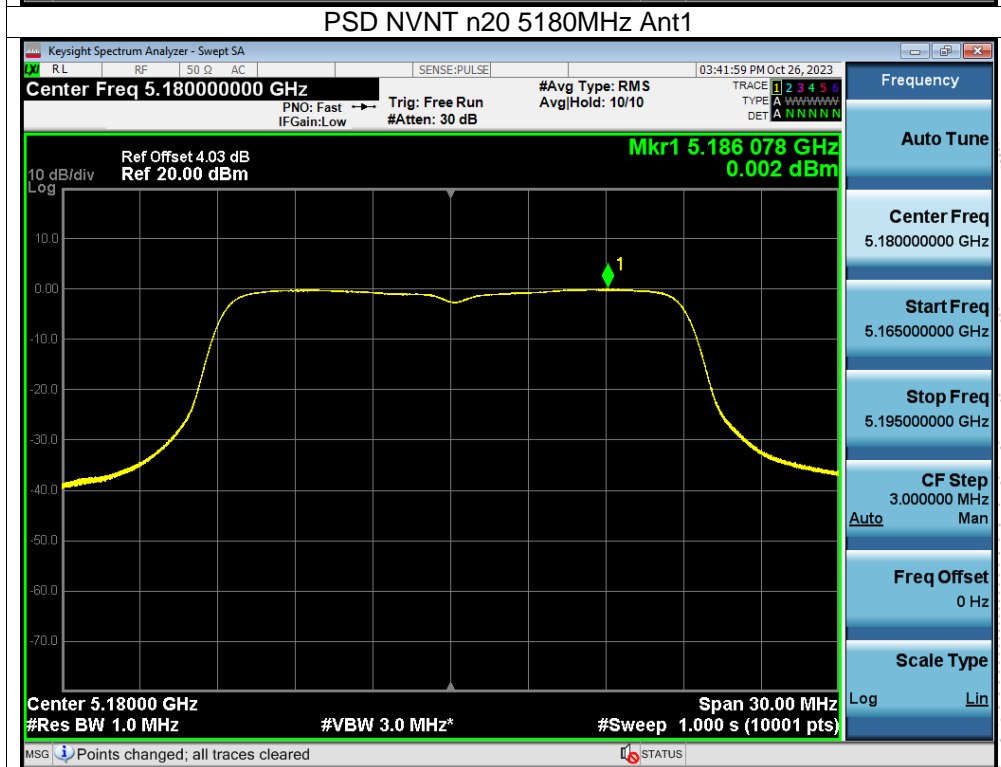
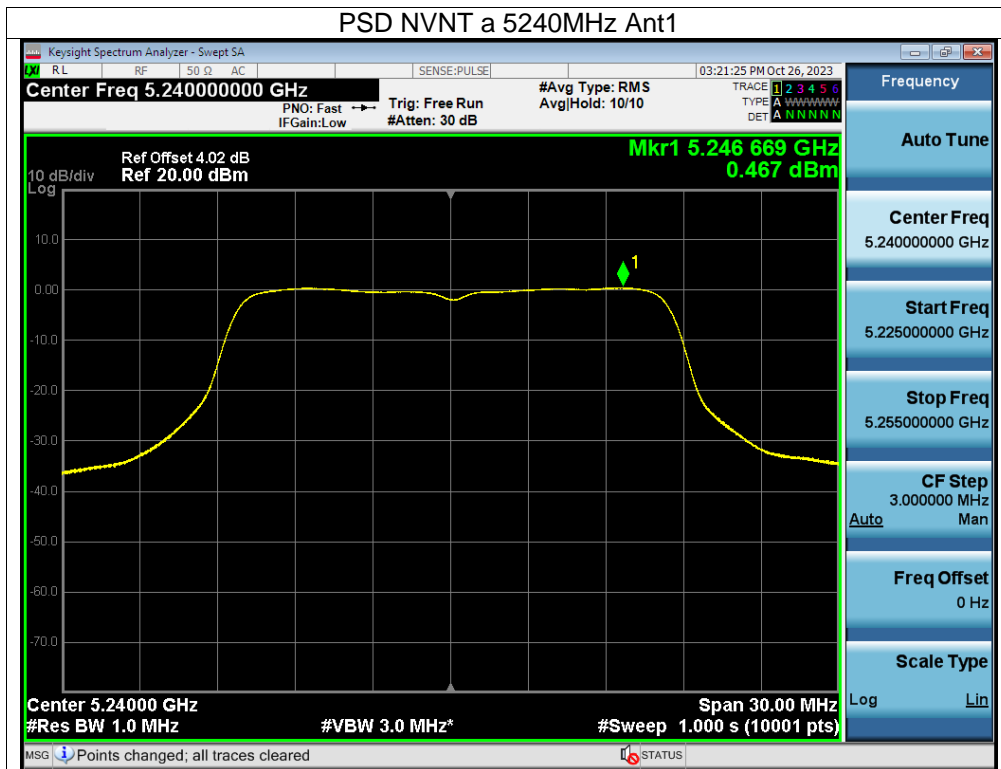

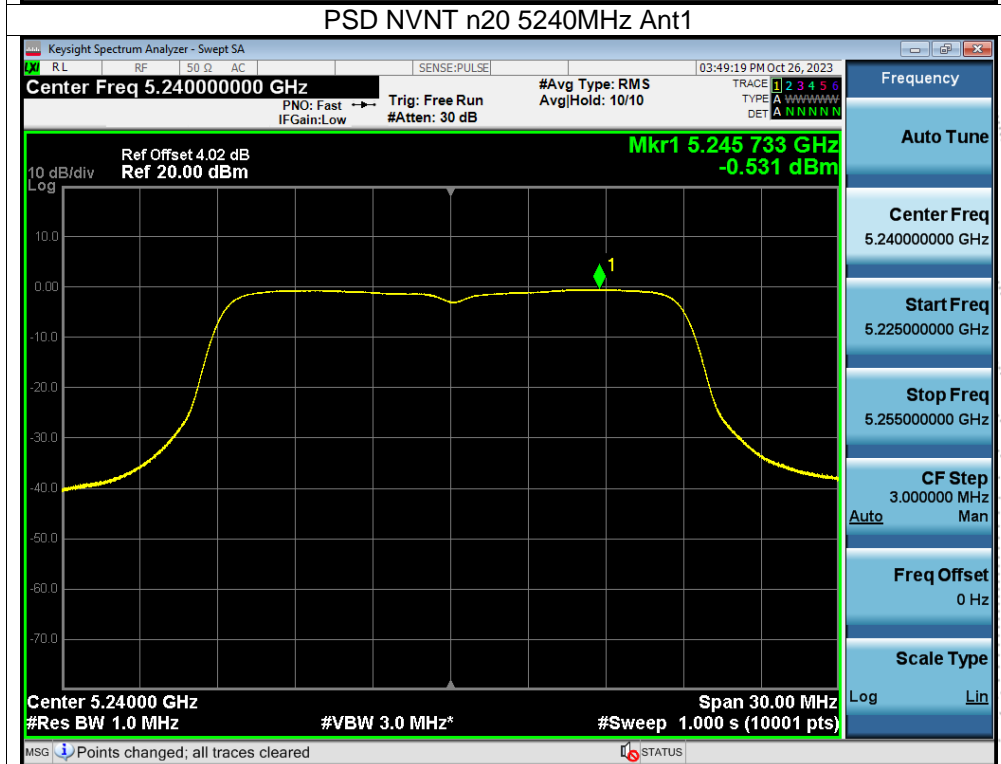
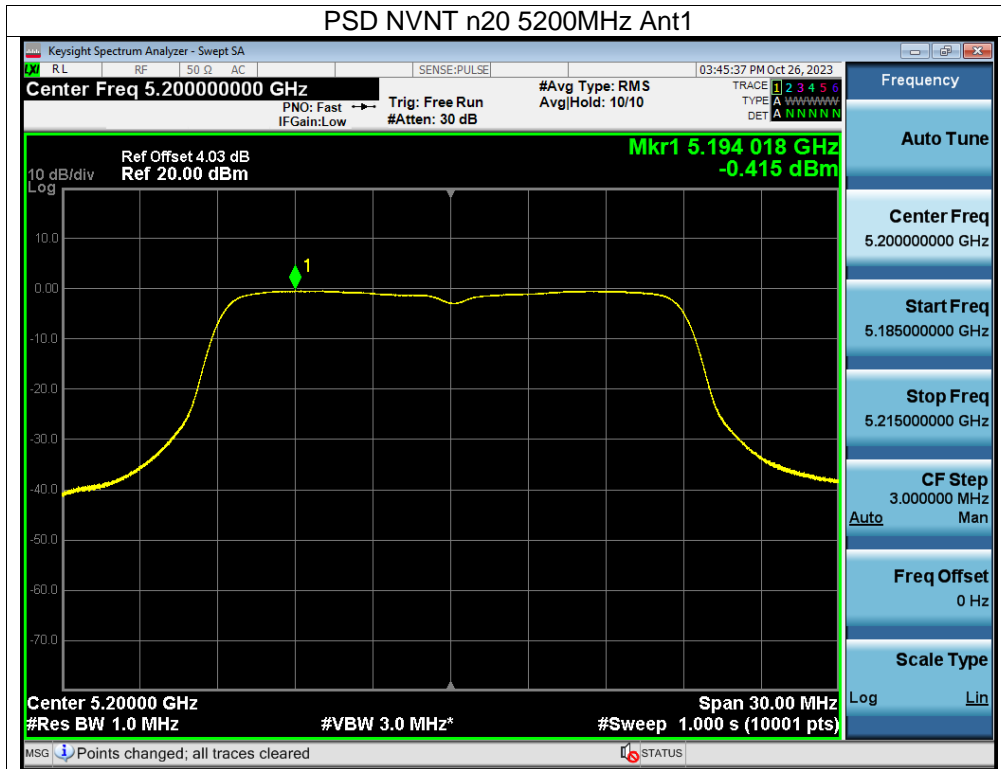

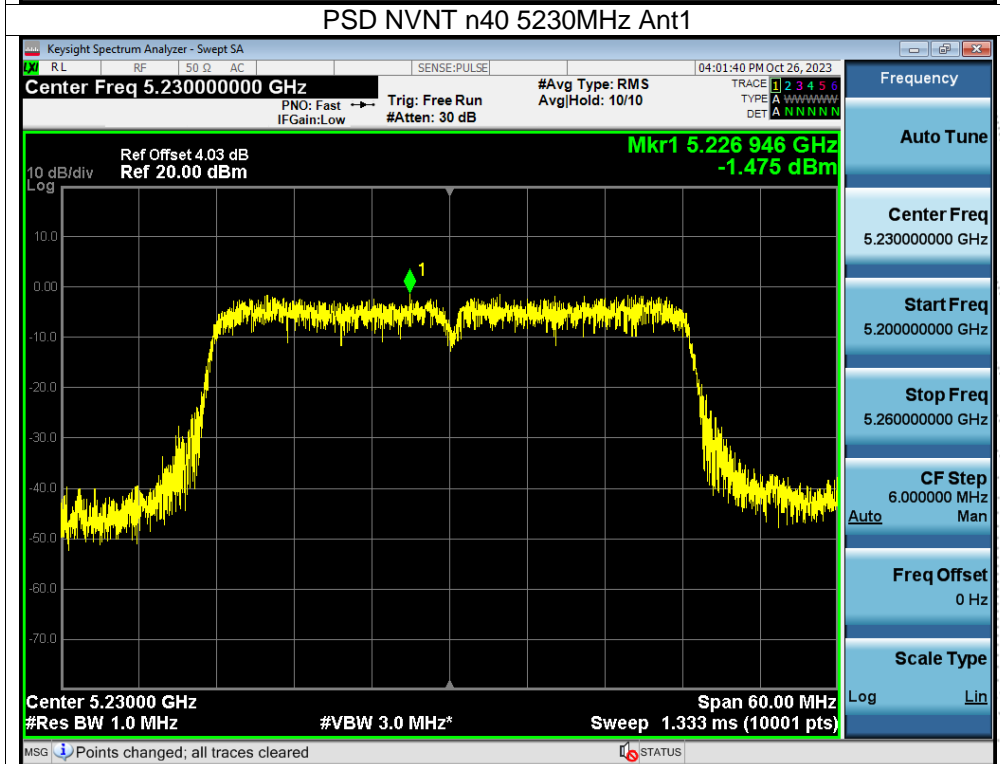
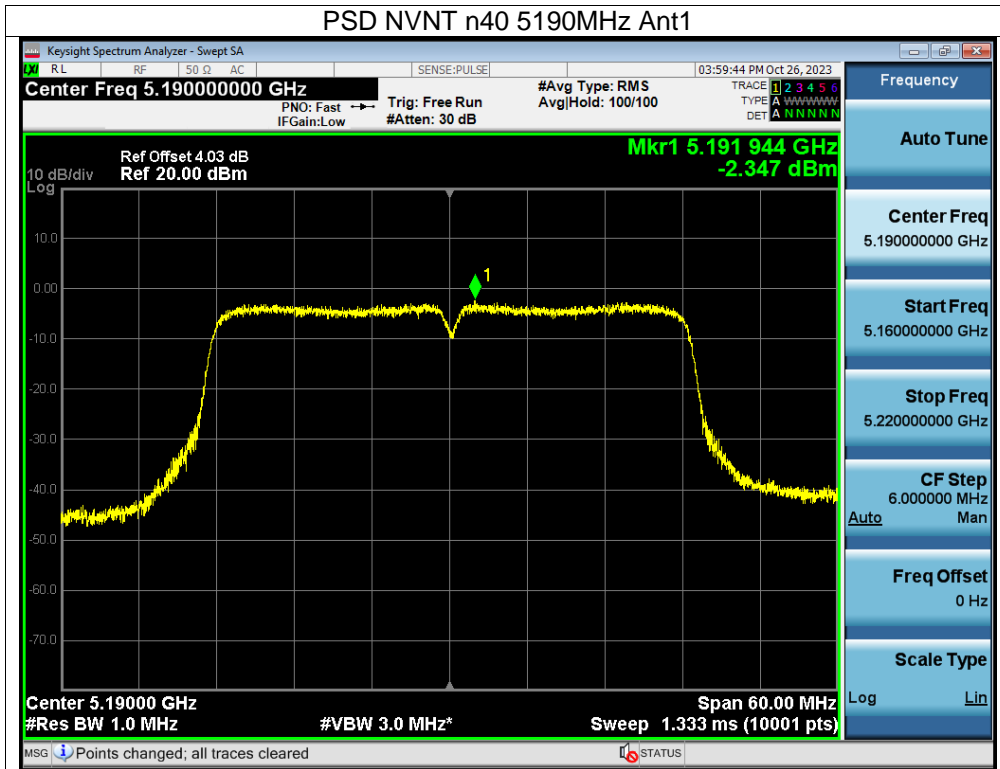

9. 26dB & 6dB & 99% Emission Bandwidth

9.1 Block Diagram Of Test Setup

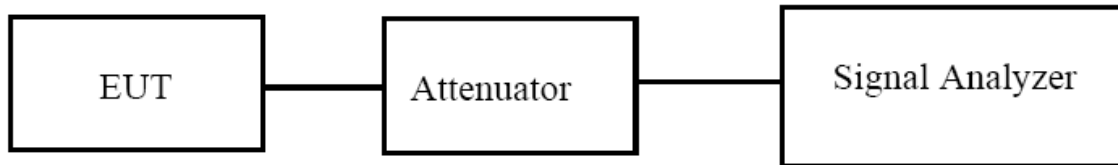

9.2 Limit

The maximum power spectral density is measured as a conducted emission by direct connection of a calibrated test instrument to the equipment under test. If the device cannot be connected directly, alternative techniques acceptable to the Commission may be used. Measurements in the 5.725-5.85 GHz band are made over a reference bandwidth of 500 kHz or the 26 dB emission bandwidth of the device, whichever is less. Measurements in the 5.15-5.25 GHz, 5.25-5.35 GHz, and the 5.47-5.725 GHz bands are made over a bandwidth of 1 MHz or the 26 dB emission bandwidth of the device, whichever is less. A narrower resolution bandwidth can be used, provided that the measured power is integrated over the full reference bandwidth.

9.3 Test Procedure

- a) Set RBW = approximately 1% of the emission bandwidth.
- b) Set the VBW > RBW.
- c) Detector = Peak.
- d) Trace mode = max hold.
- e) Measure the maximum width of the emission that is 26 dB down from the maximum of the emission. Compare this with the RBW setting of the analyzer. Readjust RBW and repeat measurement as needed until the RBW/EBW ratio is approximately 1%.

The following procedure shall be used for measuring (99 %) power bandwidth:

1. Set center frequency to the nominal EUT channel center frequency.
2. Set span = 1.5 times to 5.0 times the OBW.
3. Set RBW = 1 % to 5 % of the OBW
4. Set VBW $\geq 3 \cdot$ RBW
5. Video averaging is not permitted. Where practical, a sample detection and single sweep mode shall be used. Otherwise, peak detection and max hold mode (until the trace stabilizes) shall be used.
6. Use the 99 % power bandwidth function of the instrument (if available).
7. If the instrument does not have a 99 % power bandwidth function, the trace data points are recovered and directly summed in power units. The recovered amplitude data points, beginning at the lowest frequency, are placed in a running sum until 0.5 % of the total is reached; that frequency is recorded as the lower frequency. The process is repeated until 99.5 % of the total is reached; that frequency is recorded as the upper frequency. The 99% occupied bandwidth is the difference between these two frequencies.

9.4 EUT Operating Conditions

The EUT was configured for testing in a typical fashion (as a customer would normally use it). The EUT has been programmed to continuously transmit during test. This operating condition was tested and used to collect the included data.

9.5 Test Result

Temperature:	26 °C	Relative Humidity:	54%
Pressure:	101KPa	Test Voltage:	AC 30V
Test Mode:	(5180-5240MHz)		

Condition	Mode	Frequency (MHz)	-26 dB Bandwidth (MHz)	Verdict
NVNT	a	5180	21.298	Pass
NVNT	a	5200	21.198	Pass
NVNT	a	5240	21.344	Pass
NVNT	n20	5180	20.904	Pass
NVNT	n20	5200	20.923	Pass
NVNT	n20	5240	20.861	Pass
NVNT	n40	5190	40.848	Pass
NVNT	n40	5230	40.371	Pass

Condition	Mode	Frequency (MHz)	99% OBW (MHz)
NVNT	a	5180	16.536
NVNT	a	5200	16.507
NVNT	a	5240	16.526
NVNT	n20	5180	17.65
NVNT	n20	5200	17.618
NVNT	n20	5240	17.665
NVNT	n40	5190	36.176
NVNT	n40	5230	36.189

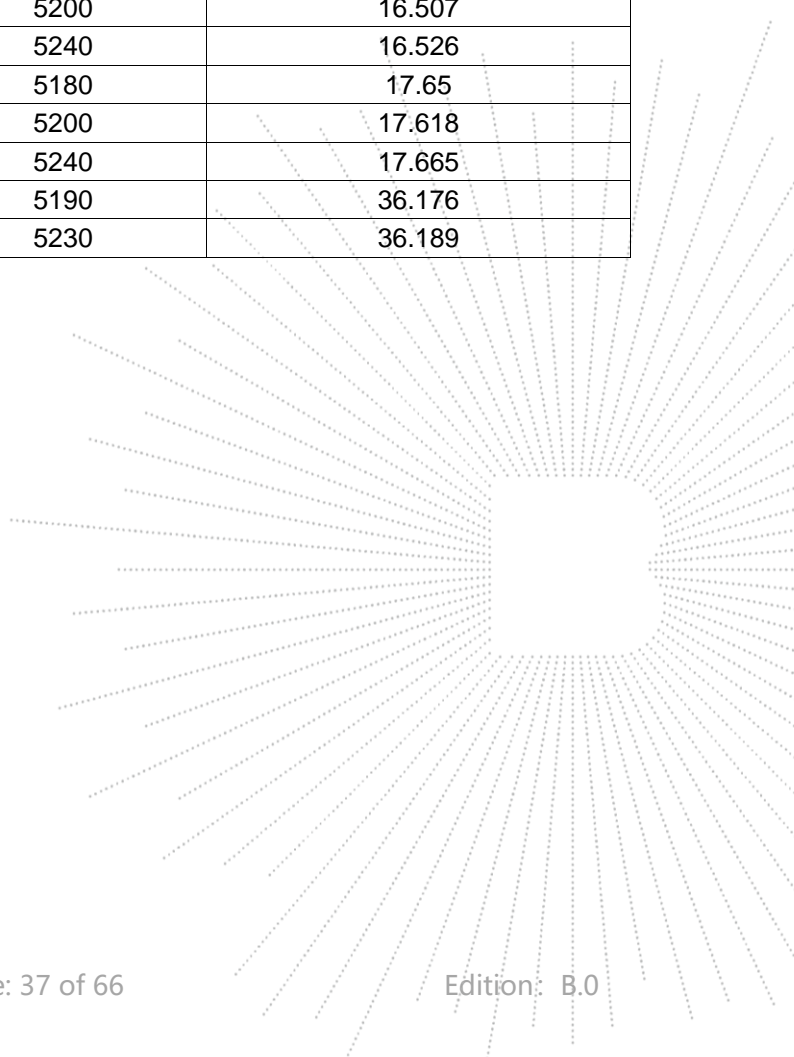

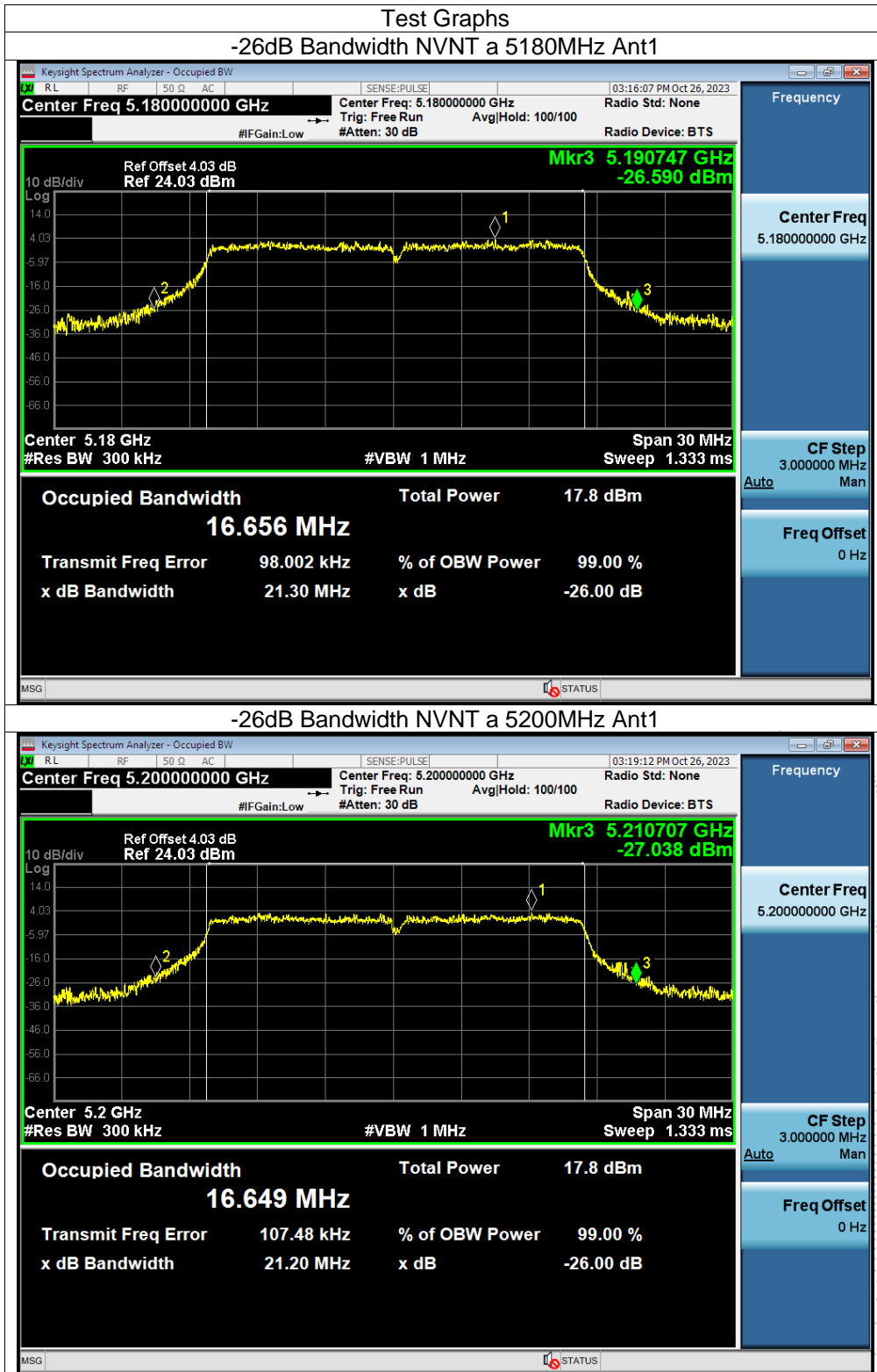

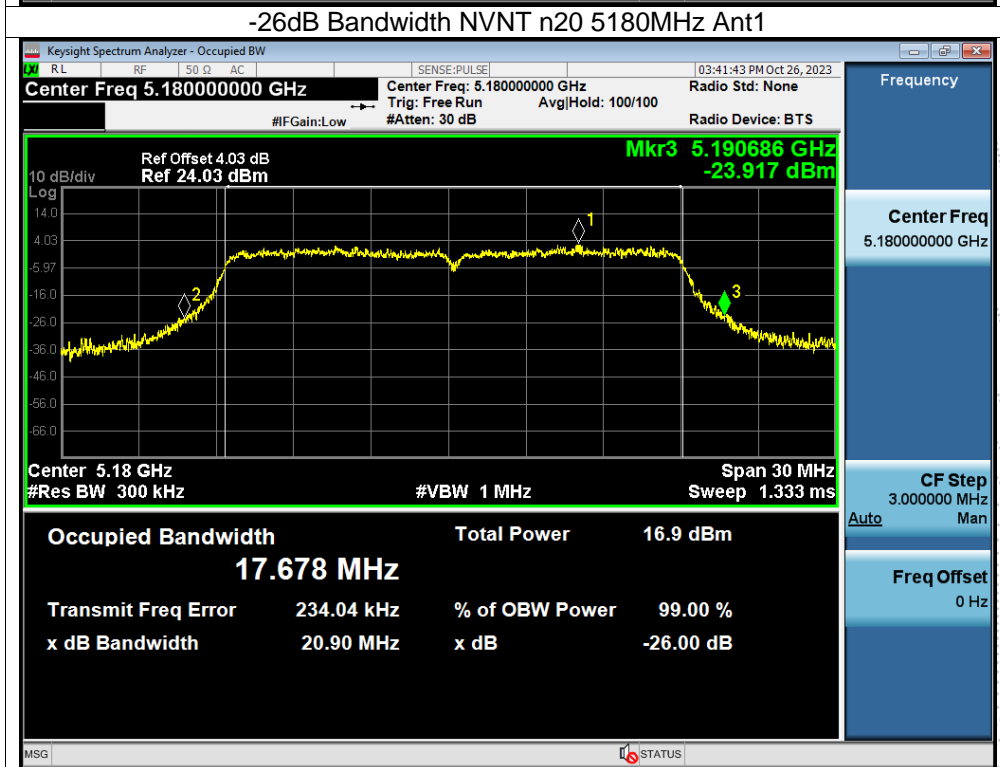
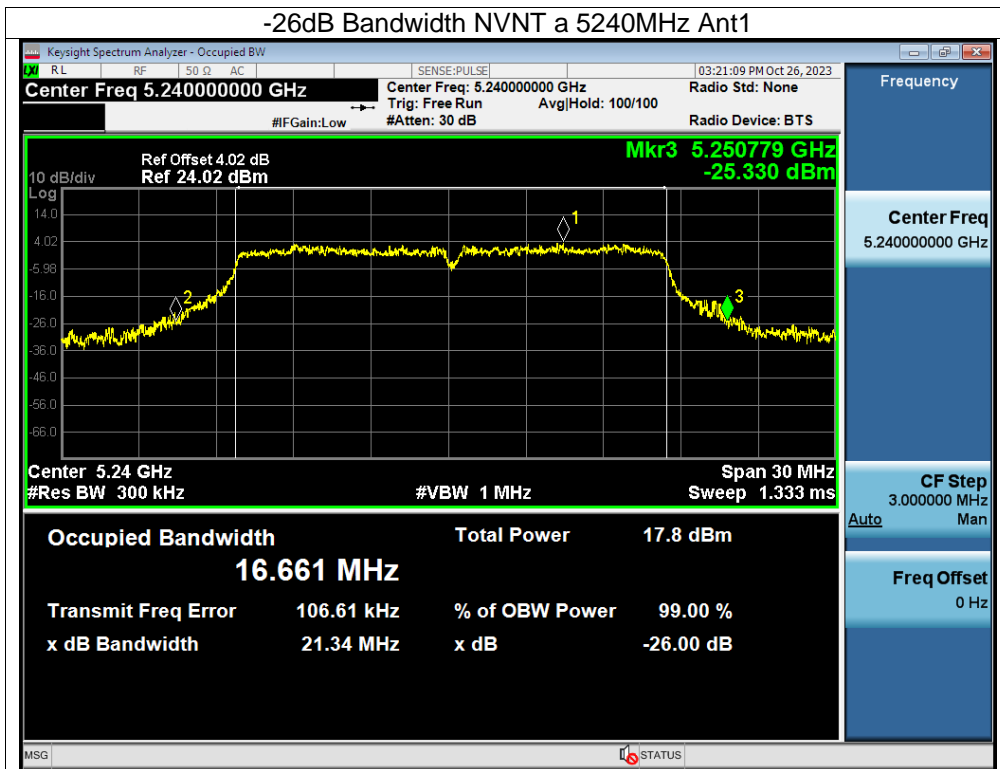

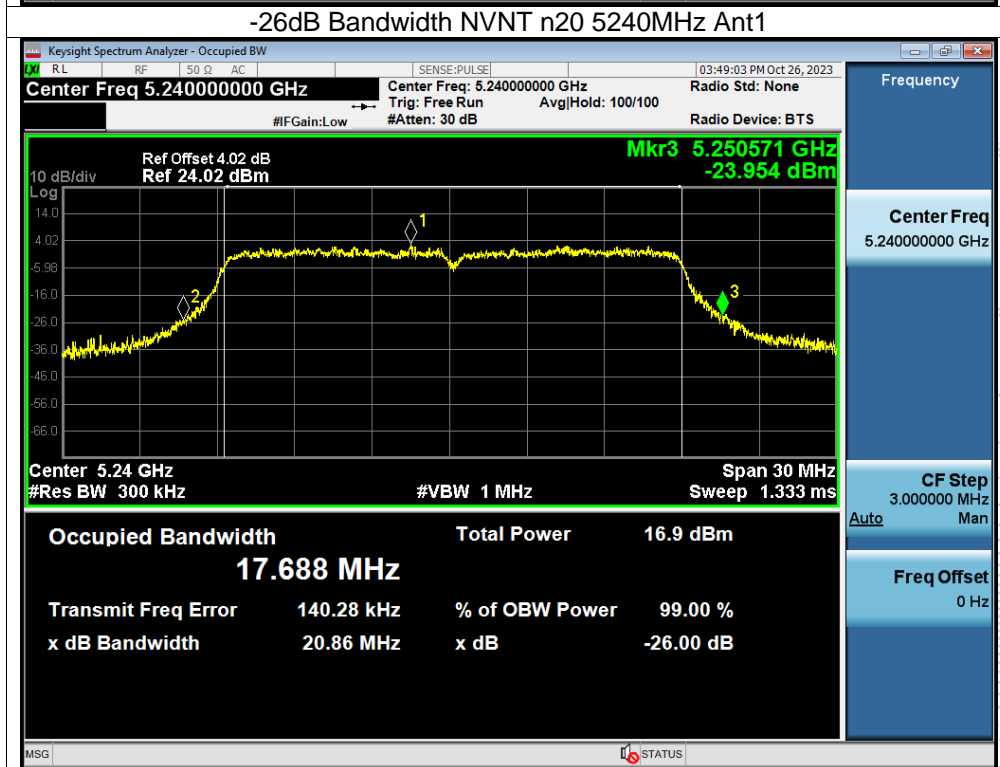
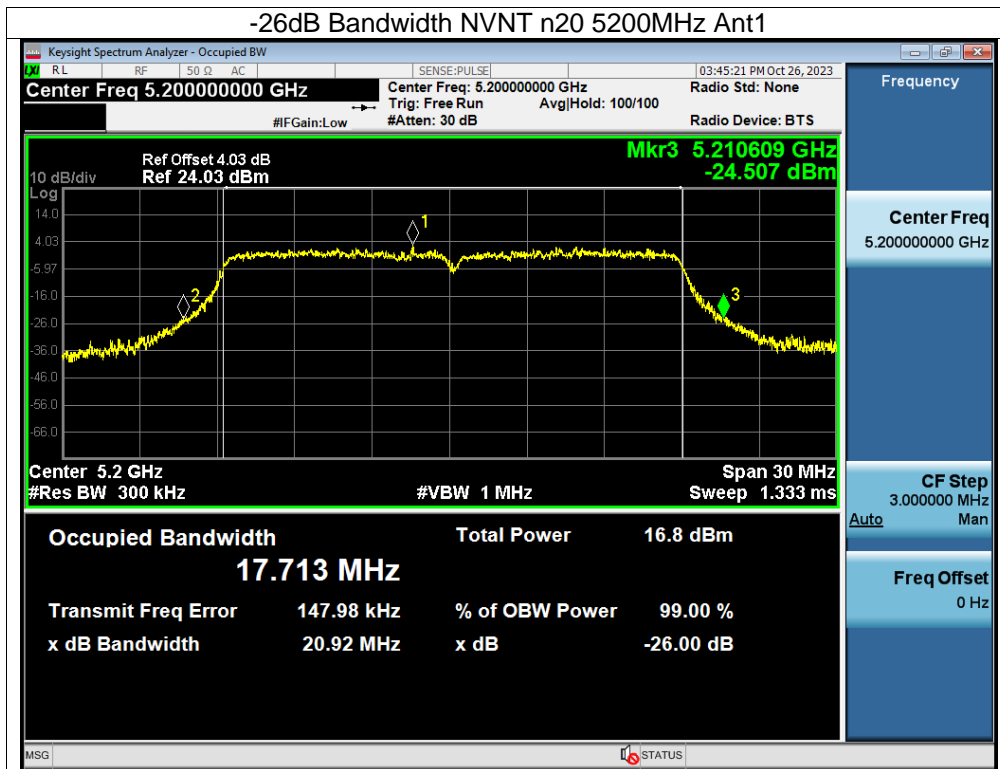

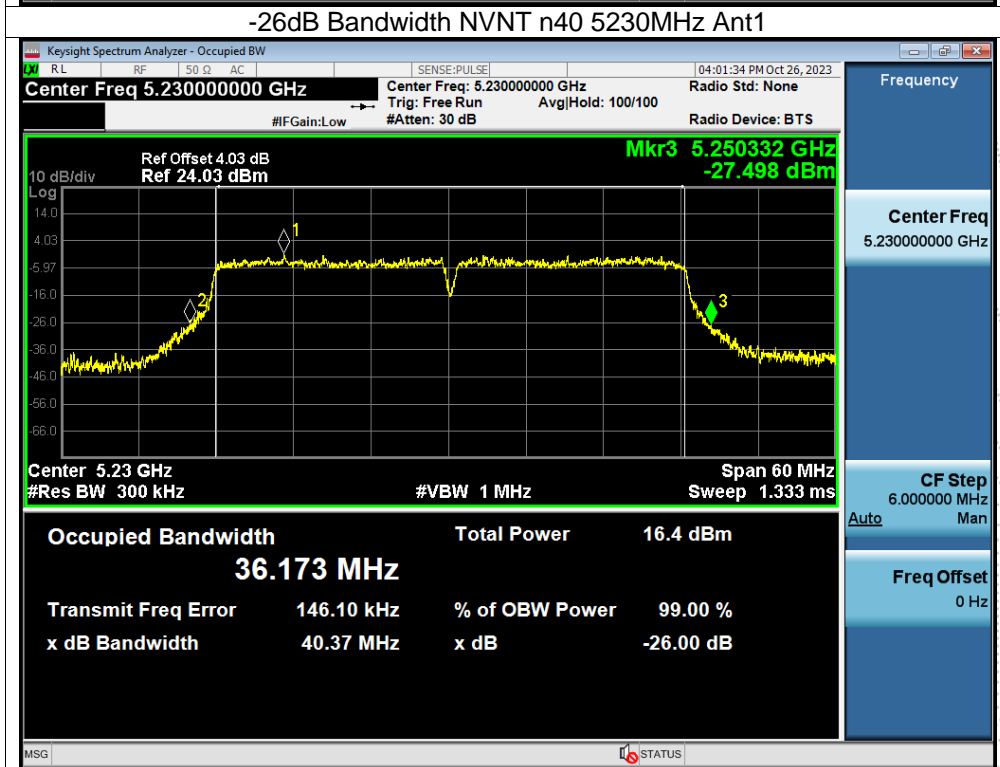
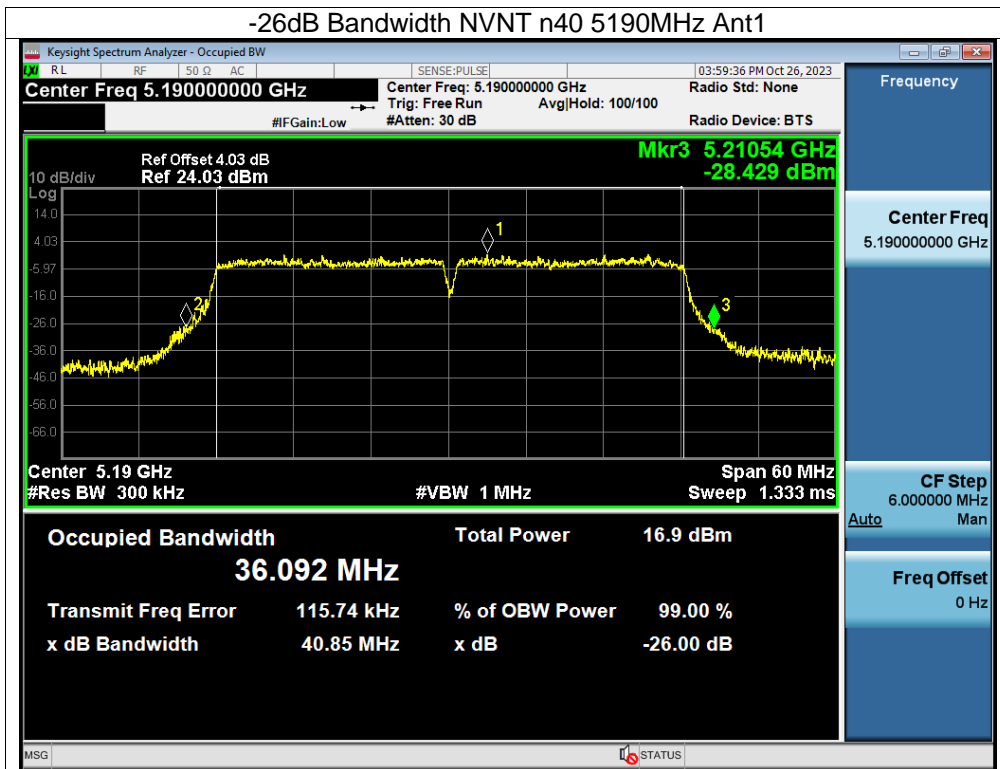

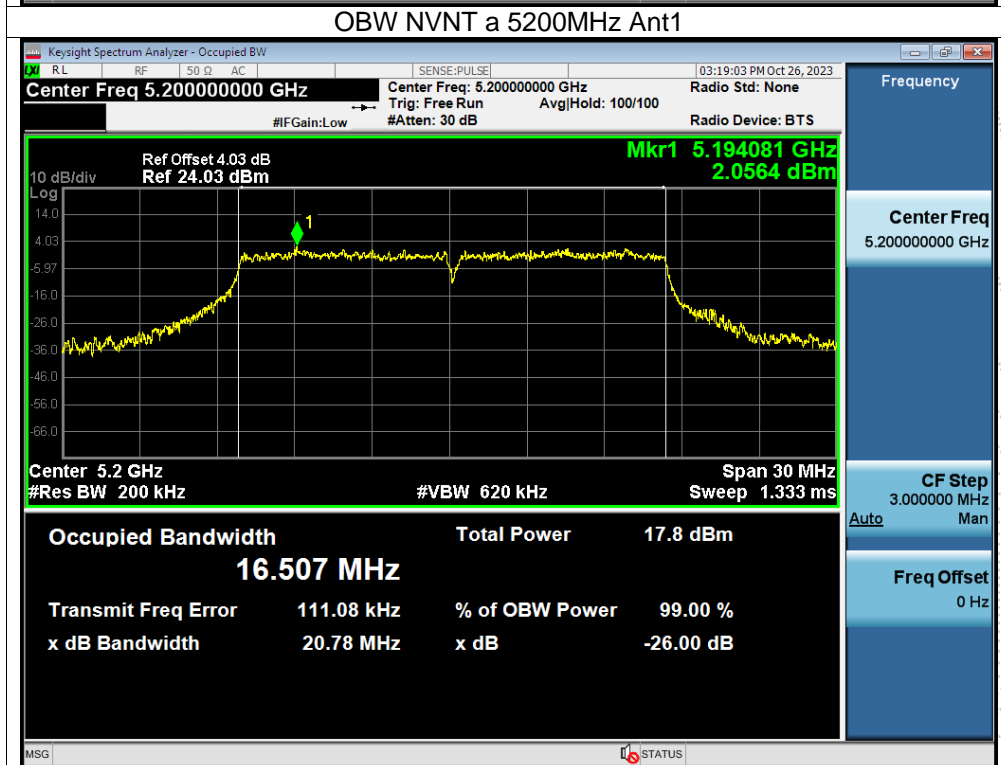
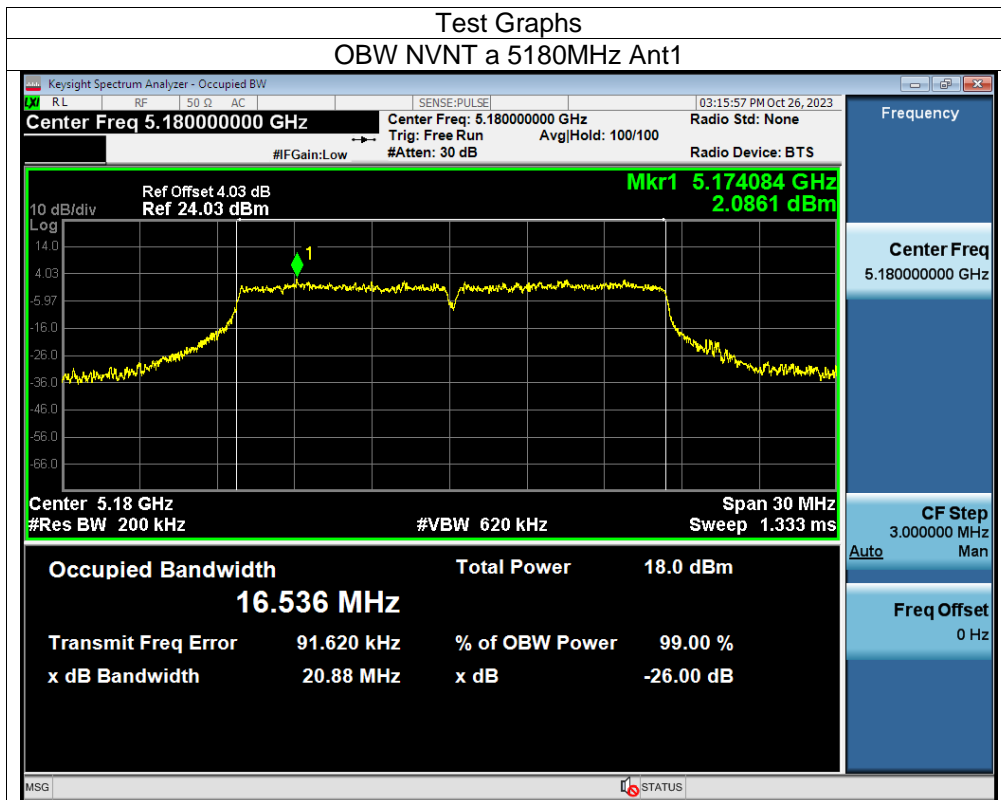

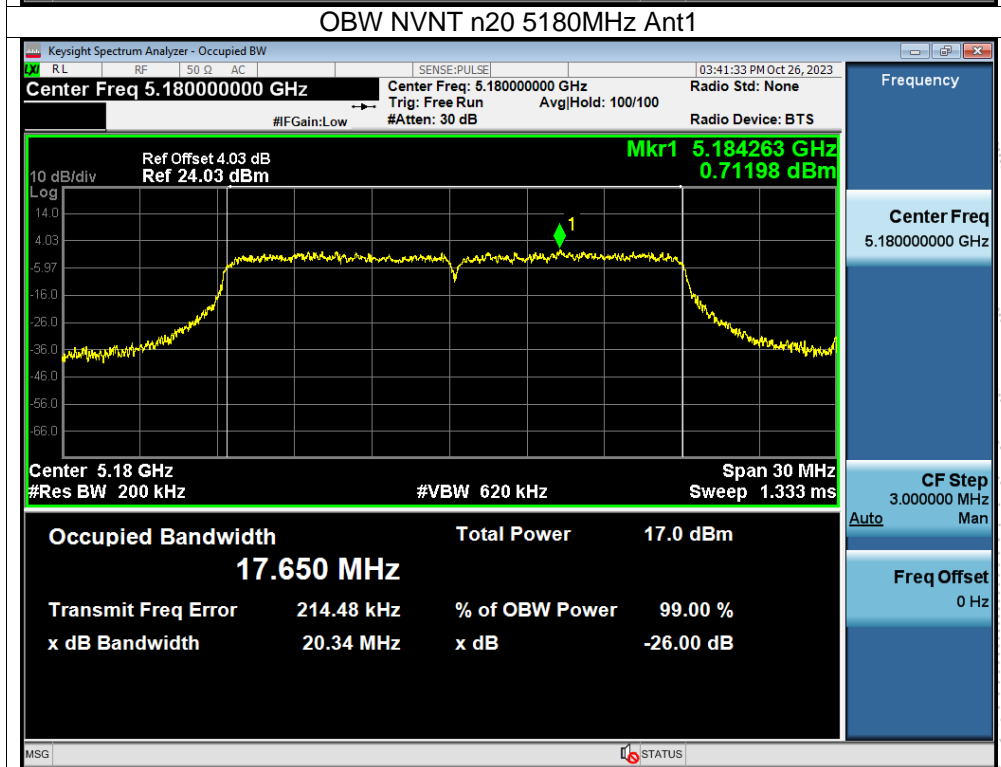
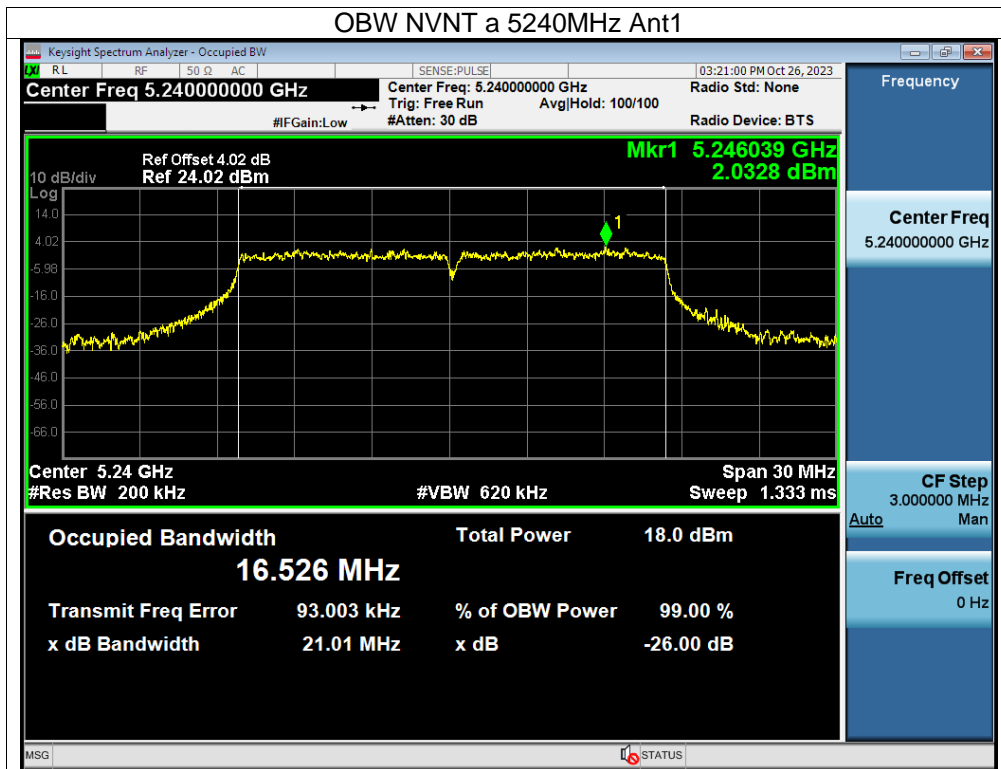

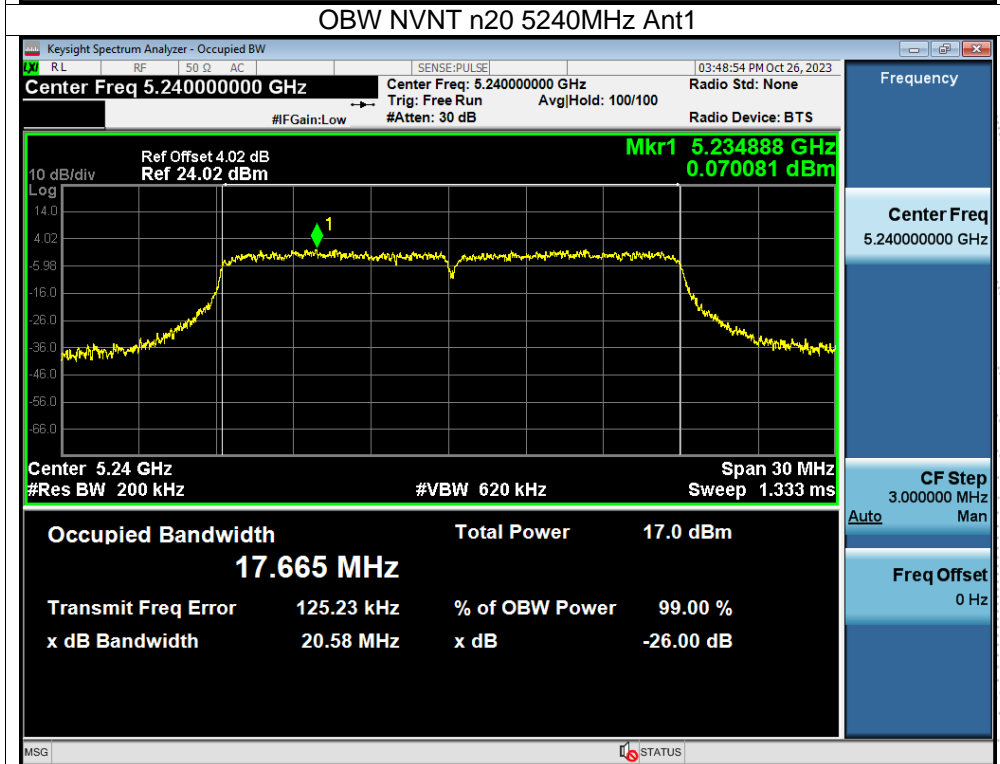
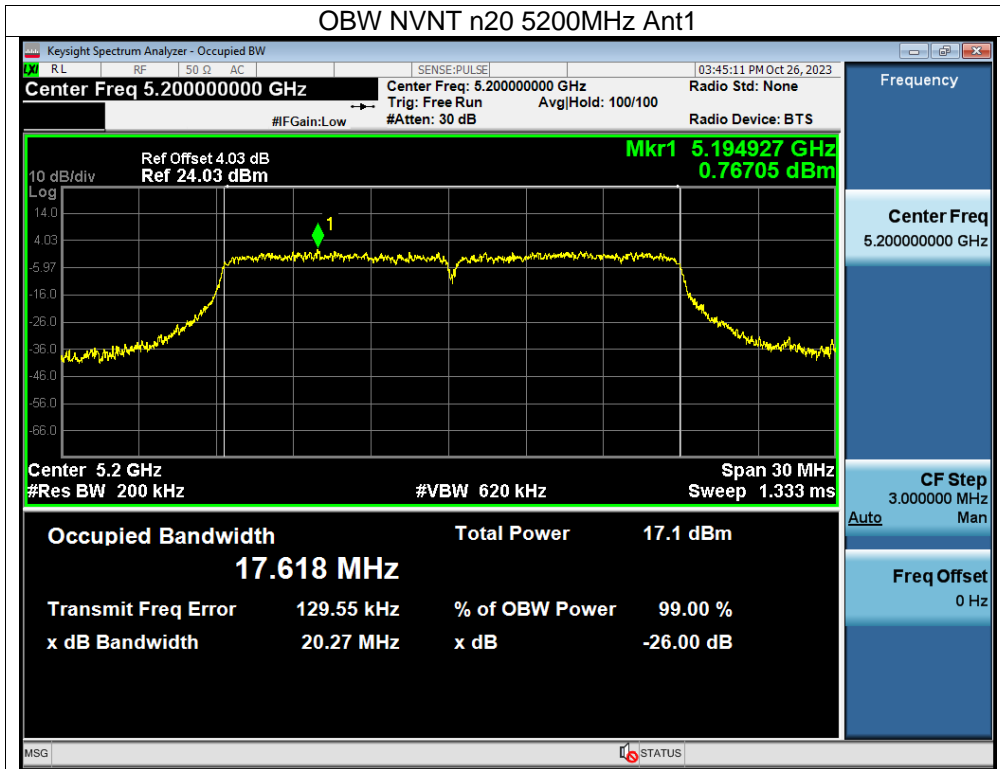

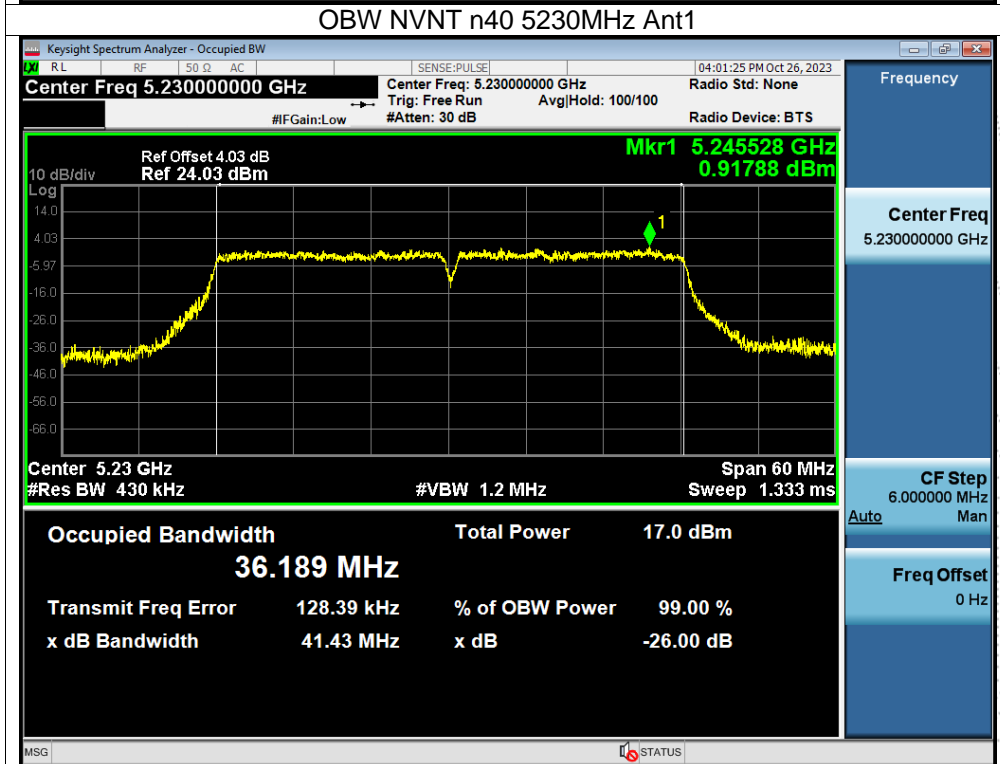
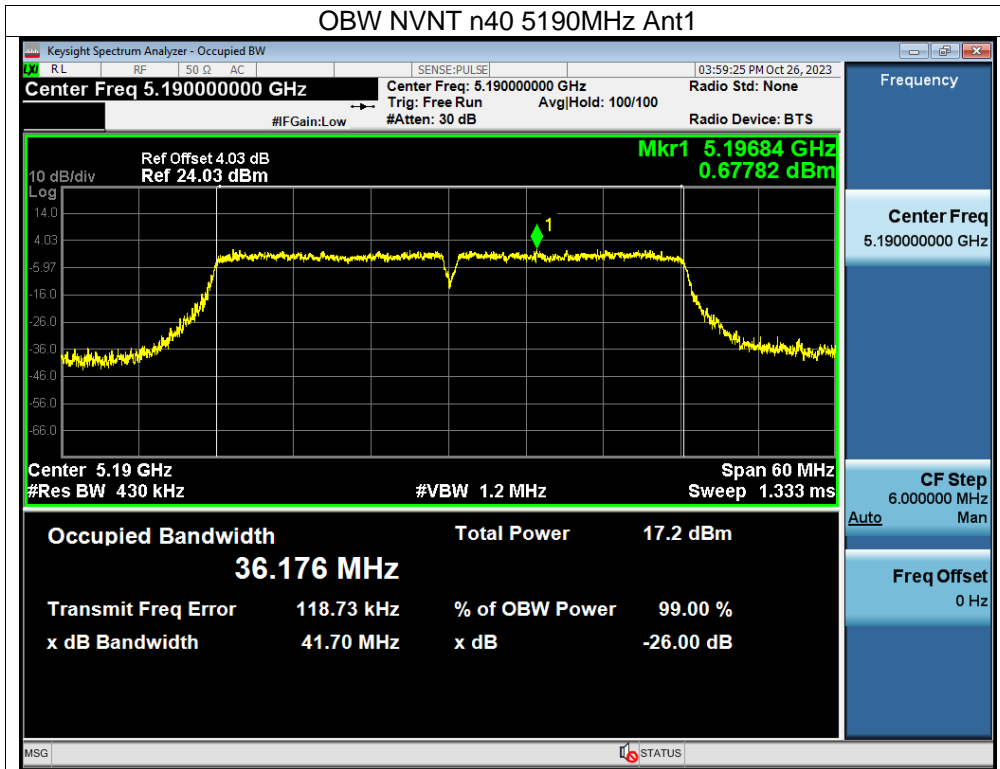

10. Maximum Conducted Output Power

10.1 Block Diagram Of Test Setup

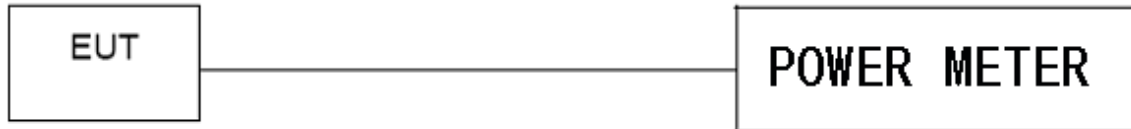

10.2 Limit

According to FCC §15.407

The maximum conducted output power should not exceed:

Frequency Band(MHz)	Limit
5150~5250	0.25W
5250~5350	0.25W
5725~5850	1W

10.3 Test Procedure

Maximum conducted output power may be measured using a spectrum analyzer/EMI receiver or an RF power meter.

1. Device Configuration

If possible, configure or modify the operation of the EUT so that it transmits continuously at its maximum power control level (see section II.B.).

a) The intent is to test at 100 percent duty cycle; however a small reduction in duty cycle (to no lower than 98 percent) is permitted if required by the EUT for amplitude control purposes. Manufacturers are expected to provide software to the test lab to permit such continuous operation.

b) If continuous transmission (or at least 98 percent duty cycle) cannot be achieved due to hardware limitations (e.g., overheating), the EUT shall be operated at its maximum power control level with the transmit duration as long as possible and the duty cycle as high as possible.

2. Measurement using a Spectrum Analyzer or EMI Receiver (SA)

Measurement of maximum conducted output power using a spectrum analyzer requires integrating the spectrum across a frequency span that encompasses, at a minimum, either the EBW or the 99-percent occupied bandwidth of the signal.¹ However, the EBW must be used to determine bandwidth dependent limits on maximum conducted output power in accordance with § 15.407(a).

a) The test method shall be selected as follows: (i) Method SA-1 or SA-1 Alternative (averaging with the EUT transmitting at full power throughout each sweep) shall be applied if either of the following conditions can be satisfied:

- The EUT transmits continuously (or with a duty cycle ≥ 98 percent).

- Sweep triggering or gating can be implemented in a way that the device transmits at the maximum power control level throughout the duration of each of the instrument sweeps to be averaged. This condition can generally be achieved by triggering the instrument's sweep if the duration of the sweep (with the analyzer configured as in Method SA-1, below) is equal to or shorter than the duration T of each transmission from the EUT and if those transmissions exhibit full power throughout their durations.

(ii) Method SA-2 or SA-2 Alternative (averaging across on and off times of the EUT transmissions, followed by duty cycle correction) shall be applied if the conditions of (i) cannot be achieved and the transmissions exhibit a constant duty cycle during the measurement duration. Duty cycle will be considered to be constant if variations are less than ± 2 percent.

(iii) Method SA-3 (RMS detection with max hold) or SA-3 Alternative (reduced VBW with max hold) shall be applied if the conditions of (i) and (ii) cannot be achieved.

b) Method SA-1 (trace averaging with the EUT transmitting at full power throughout each sweep): (i) Set span to encompass the entire emission bandwidth (EBW) (or, alternatively, the entire 99% occupied bandwidth) of the signal.

(ii) Set RBW = 1 MHz.

(iii) Set VBW ≥ 3 MHz.

(iv) Number of points in sweep ≥ 2 Span / RBW. (This ensures that bin-to-bin spacing is \leq RBW/2, so that narrowband signals are not lost between frequency bins.)

(v) Sweep time = auto.

(vi) Detector = RMS (i.e., power averaging), if available. Otherwise, use sample detector mode.

(vii) If transmit duty cycle < 98 percent, use a video trigger with the trigger level set to enable triggering only on full power pulses. Transmitter must operate at maximum power control level for the entire duration of every sweep. If the EUT transmits continuously (i.e., with no off intervals) or at duty cycle ≥ 98 percent, and if each transmission is entirely at the maximum power control level, then the trigger shall be set to "free run".

(viii) Trace average at least 100 traces in power averaging (i.e., RMS) mode.

(ix) Compute power by integrating the spectrum across the EBW (or, alternatively, the entire 99% occupied bandwidth) of the signal using the instrument's band power measurement function with band limits set equal to the EBW (or occupied bandwidth) band edges. If the instrument does not have a band power function, sum the spectrum

10.4 EUT Operating Conditions

The EUT was configured for testing in a typical fashion (as a customer would normally use it). The EUT has been programmed to continuously transmit during test. This operating condition was tested and used to collect the included data.

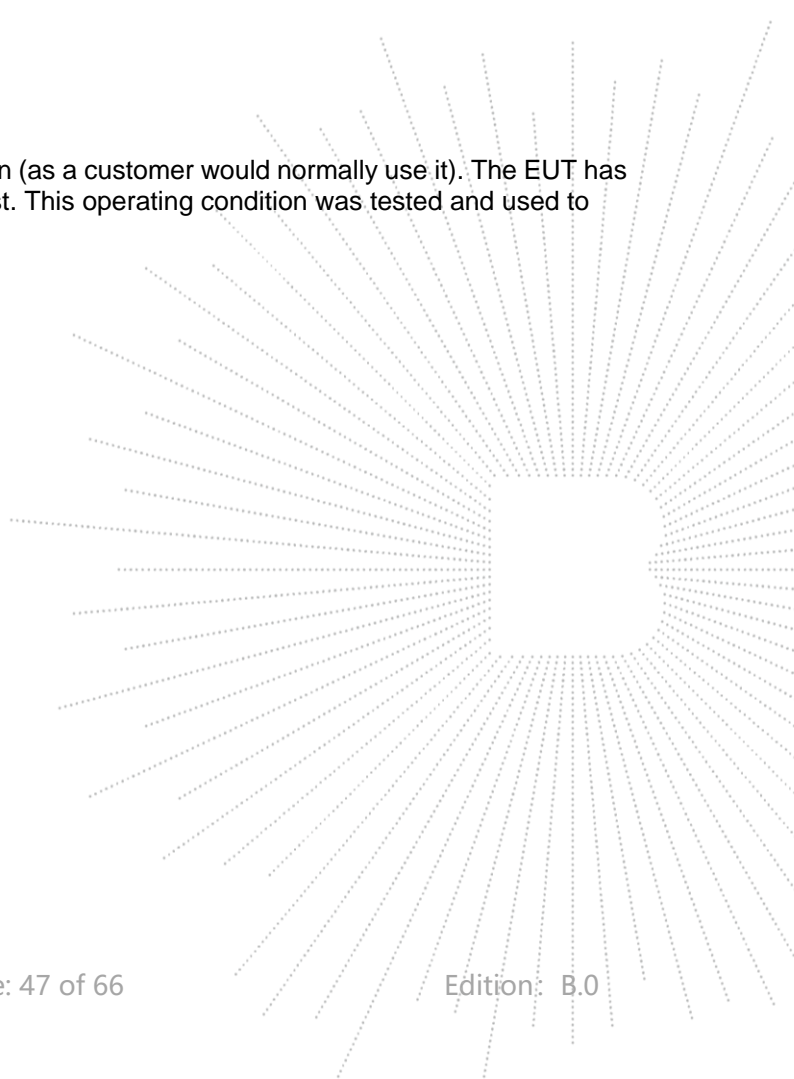

10.5 Test Result

Temperature:	26 °C	Relative Humidity:	54%
Pressure:	101KPa	Test Voltage:	AC 30V
Test Mode:	5180-5240MHz		

Condition	Mode	Frequency (MHz)	Conducted Power (dBm)	Limit (dBm)	Verdict
NVNT	a	5180	12.89	24	Pass
NVNT	a	5200	12.54	24	Pass
NVNT	a	5240	12.32	24	Pass
NVNT	n20	5180	12.39	24	Pass
NVNT	n20	5200	12.13	24	Pass
NVNT	n20	5240	11.85	24	Pass
NVNT	n40	5190	12.04	24	Pass
NVNT	n40	5230	11.21	24	Pass

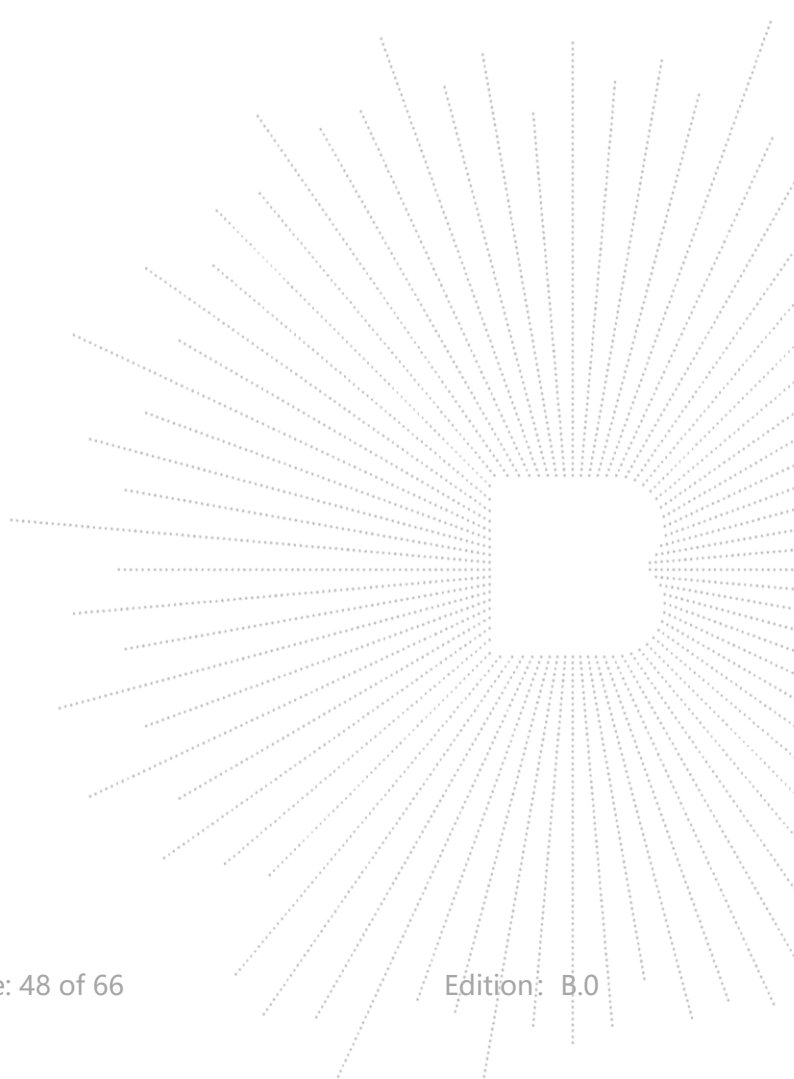

11. Out Of Band Emissions

11.1 Block Diagram Of Test Setup



11.2 Limit

According to FCC §15.407(b)

Undesirable emission limits. Except as shown in paragraph (b)(7) of this section, the maximum emissions outside of the frequency bands of operation shall be attenuated in accordance with the following limits:

- (1) For transmitters operating in the 5.15-5.25 GHz band: All emissions outside of the 5.15-5.35 GHz band shall not exceed an e.i.r.p. of -27 dBm/MHz.
- (2) All emissions shall be limited to a level of -27 dBm/MHz at 75 MHz or more above or below the band edge increasing linearly to 10 dBm/MHz at 25 MHz above or below the band edge, and from 25 MHz above or below the band edge increasing linearly to a level of 15.6 dBm/MHz at 5 MHz above or below the band edge, and from 5 MHz above or below the band edge increasing linearly to a level of 27 dBm/MHz at the band edge.

11.3 Test Procedure

1. Check the calibration of the measuring instrument using either an internal calibrator or a known signal from an external generator.
2. Position the EUT without connection to measurement instrument. Turn on the EUT and connect its antenna terminal to measurement instrument via a low loss cable. Then set it to any one measured frequency within its operating range, and make sure the instrument is operated in its linear range.
3. Set RBW of spectrum analyzer to 1 MHz with a convenient frequency span.
4. Measure the highest amplitude appearing on spectral display and set it as a reference level. Plot the graph with marking the highest point and edge frequency.
5. Repeat above procedures until all measured frequencies were complete.

11.4 EUT Operating Conditions

The EUT was configured for testing in a typical fashion (as a customer would normally use it). The EUT has been programmed to continuously transmit during test. This operating condition was tested and used to collect the included data

11.5 Test Result

Temperature:	26 °C	Relative Humidity:	54%
Pressure:	101kPa	Test Voltage:	AC 30V

5180-5240MHz

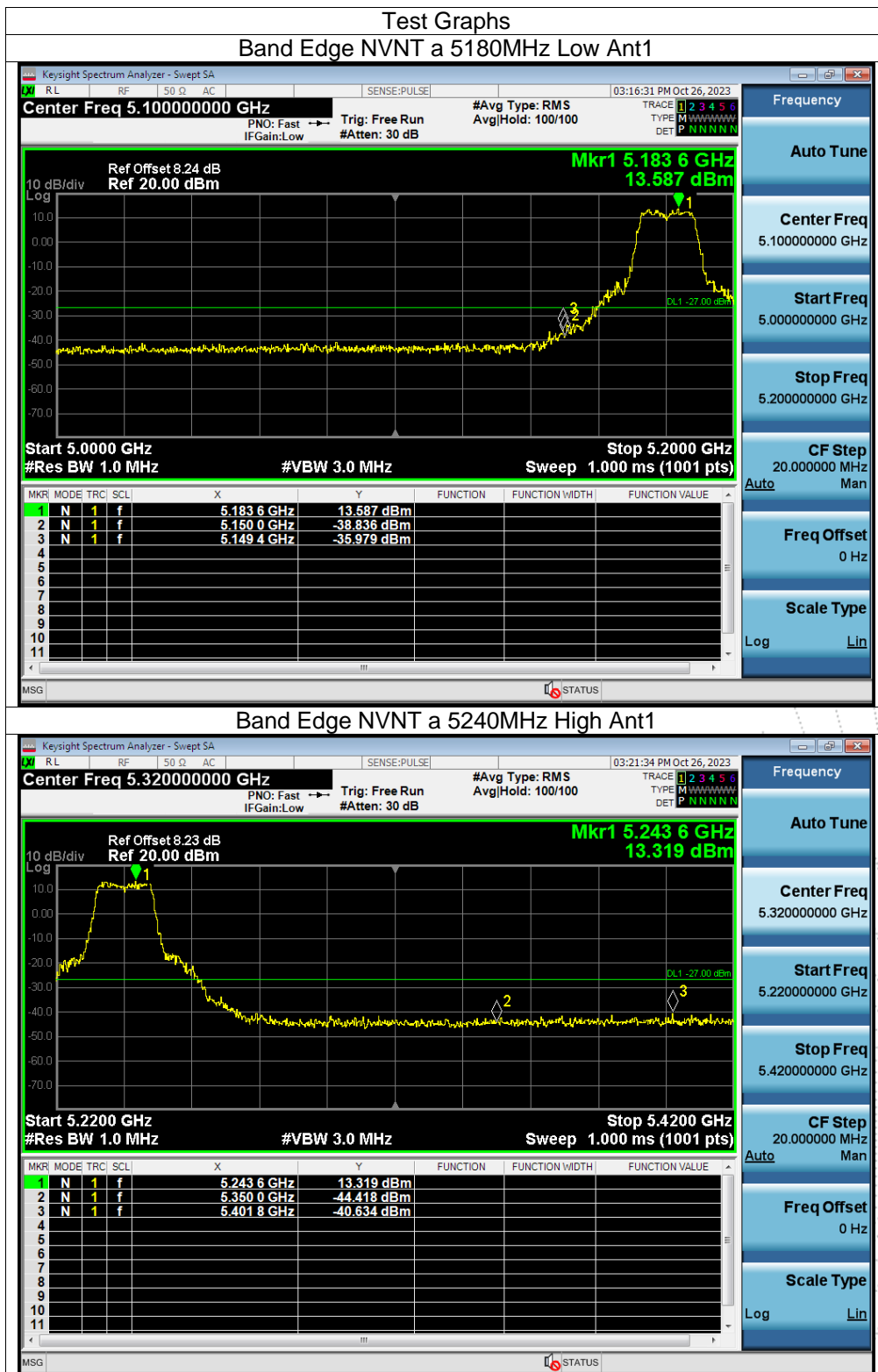

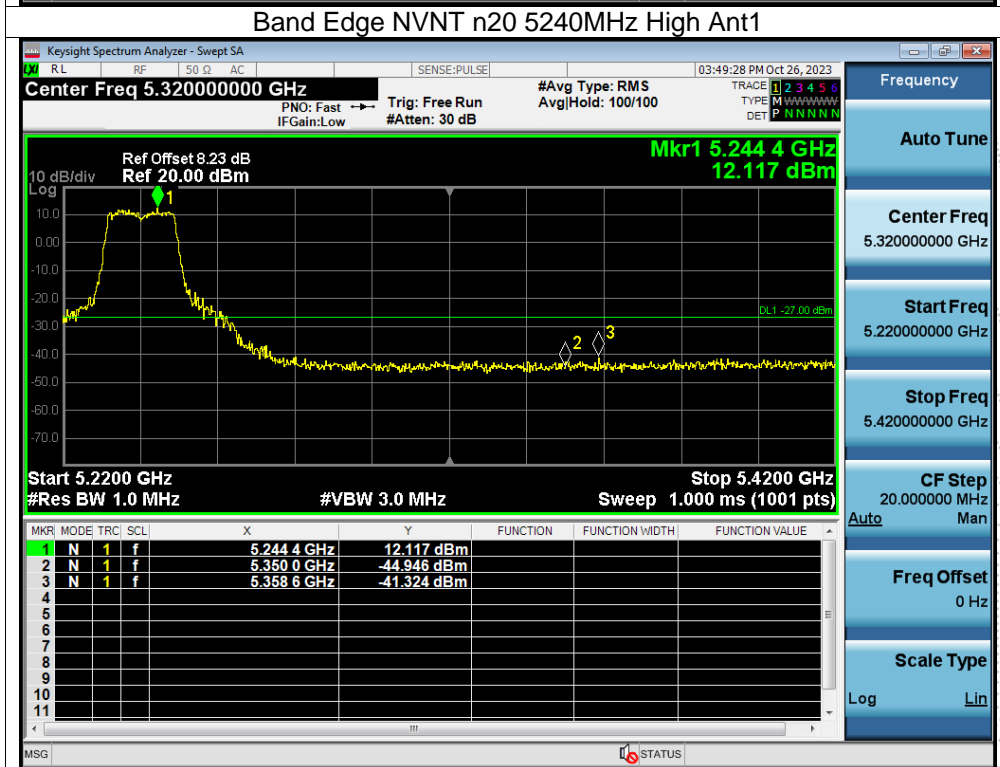
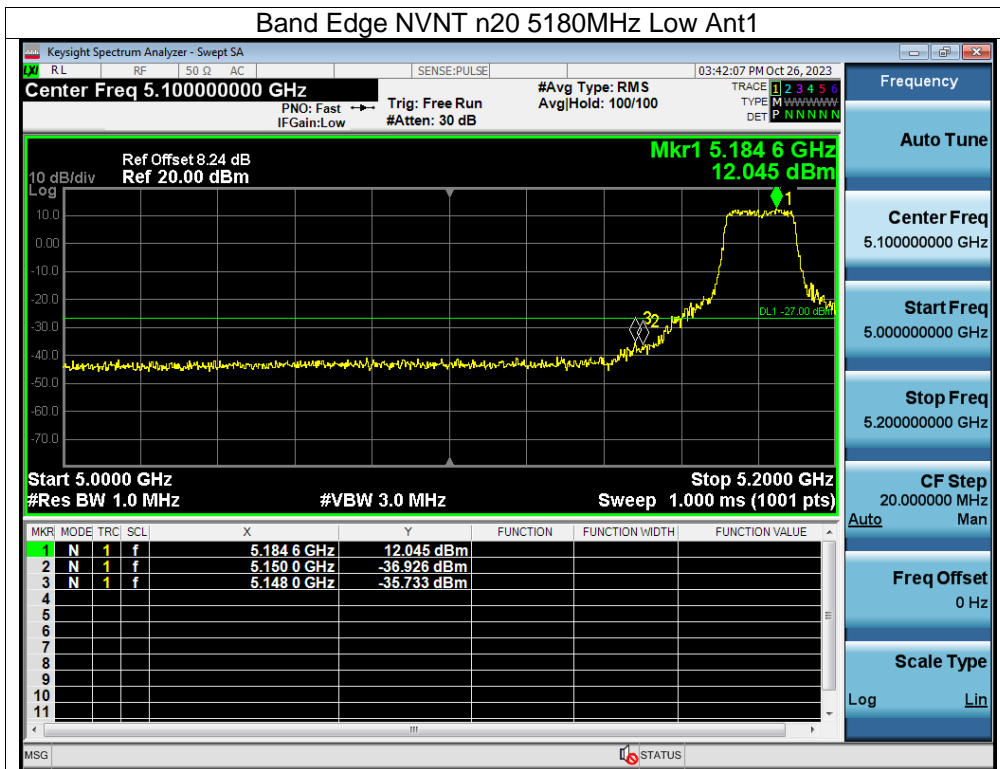

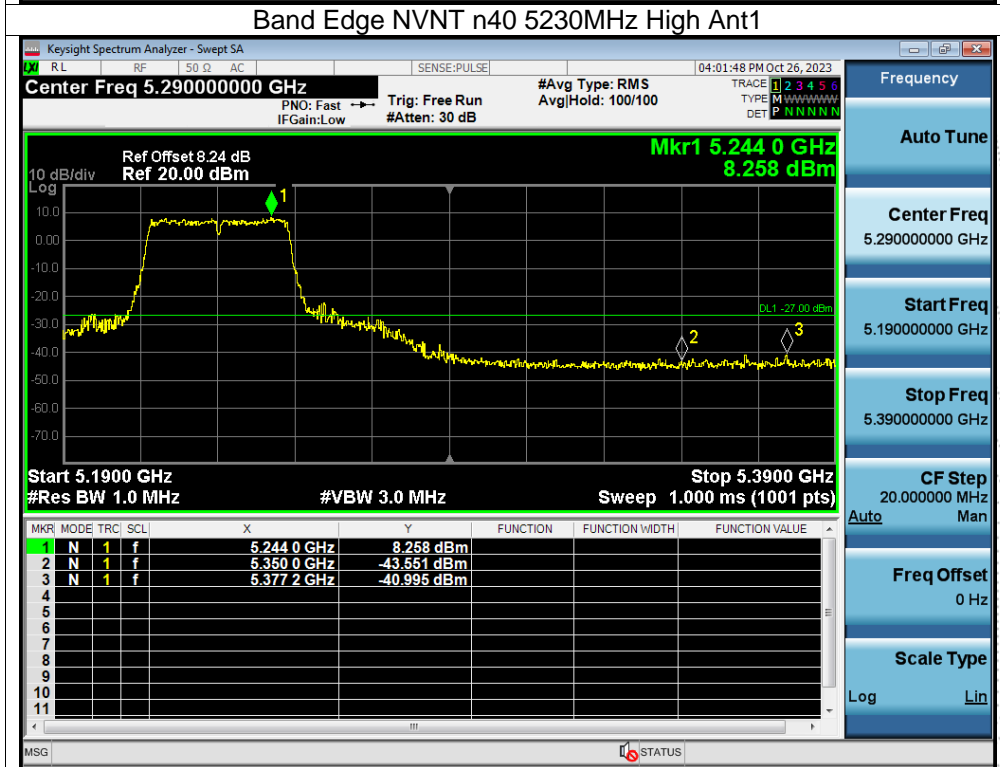
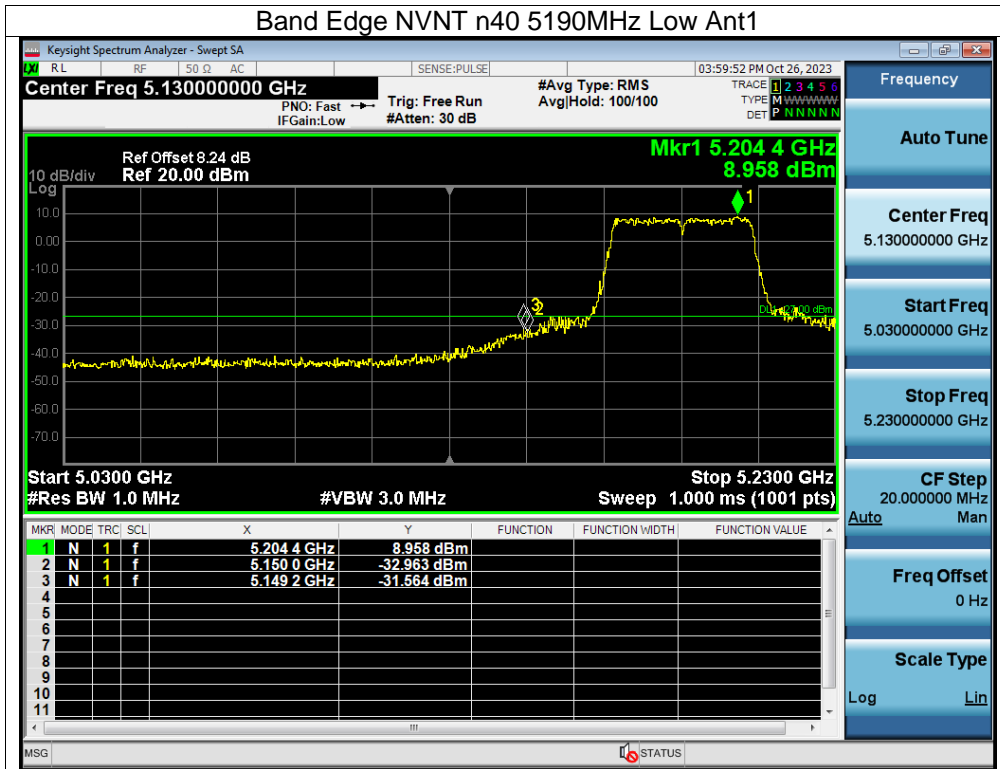

12. Spurious RF Conducted Emissions

12.1 Block Diagram Of Test Setup



12.2 Limit

Undesirable emission limits. Except as shown in paragraph (b)(7) of this section, the maximum emissions outside of the frequency bands of operation shall be attenuated in accordance with the following limits:

(1) For transmitters operating in the 5.15-5.25 GHz band: All emissions outside of the 5.15-5.35 GHz band shall not exceed an e.i.r.p. of -27 dBm/MHz.

(2) For transmitters operating in the 5.725-5.85 GHz band(i) All emissions shall be limited to a level of -27 dBm/MHz at 75 MHz or more above or below the band edge increasing linearly to 10 dBm/MHz at 25 MHz above or below the band edge, and from 25 MHz above or below the band edge increasing linearly to a level of 15.6 dBm/MHz at 5 MHz above or below the band edge, and from 5 MHz above or below the band edge increasing linearly to a level of 27 dBm/MHz at the band edge..

12.3 Test Procedure

1. Check the calibration of the measuring instrument using either an internal calibrator or a known signal from an external generator.
2. Position the EUT without connection to measurement instrument. Turn on the EUT and connect its antenna terminal to measurement instrument via a low loss cable. Then set it to any one measured frequency within its operating range, and make sure the instrument is operated in its linear range.
3. Set RBW of spectrum analyzer to 1 MHz with a convenient frequency span.
4. Measure the highest amplitude appearing on spectral display and set it as a reference level. Plot the graph with marking the highest point and edge frequency.
5. Repeat above procedures until all measured frequencies were complete.

12.4 Test Result

Remark: The measurement frequency range is from 9KHz to the 10th harmonic of the fundamental frequency. The lowest, middle and highest channels are tested to verify the spurious emissions and bandedge measurement data.

About: 26.5GHz-40GHz, The amplitude of spurious emissions which are attenuated by more than 20dB below the permissible value has no need to be reported.

5180-5240MHz

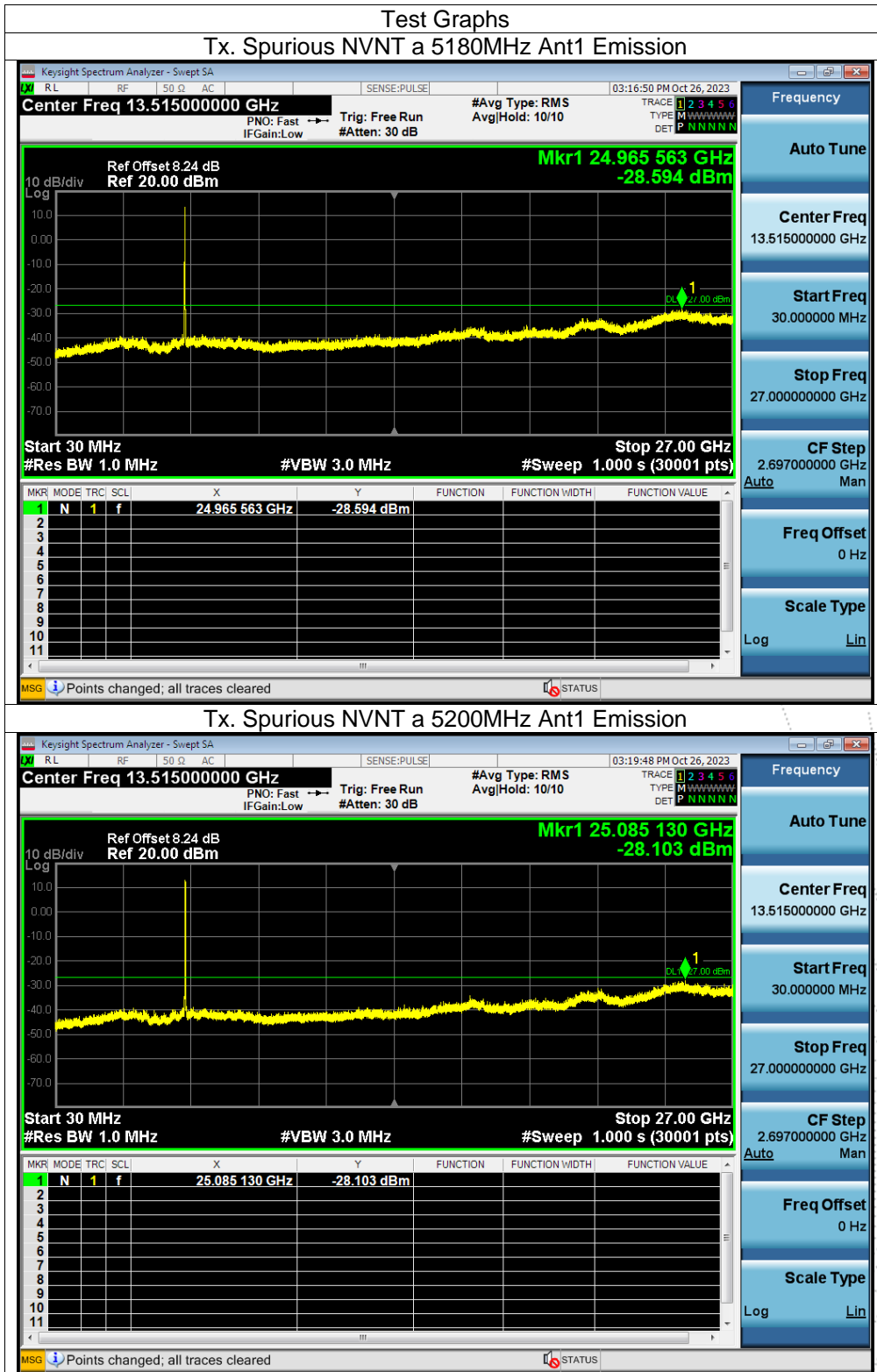

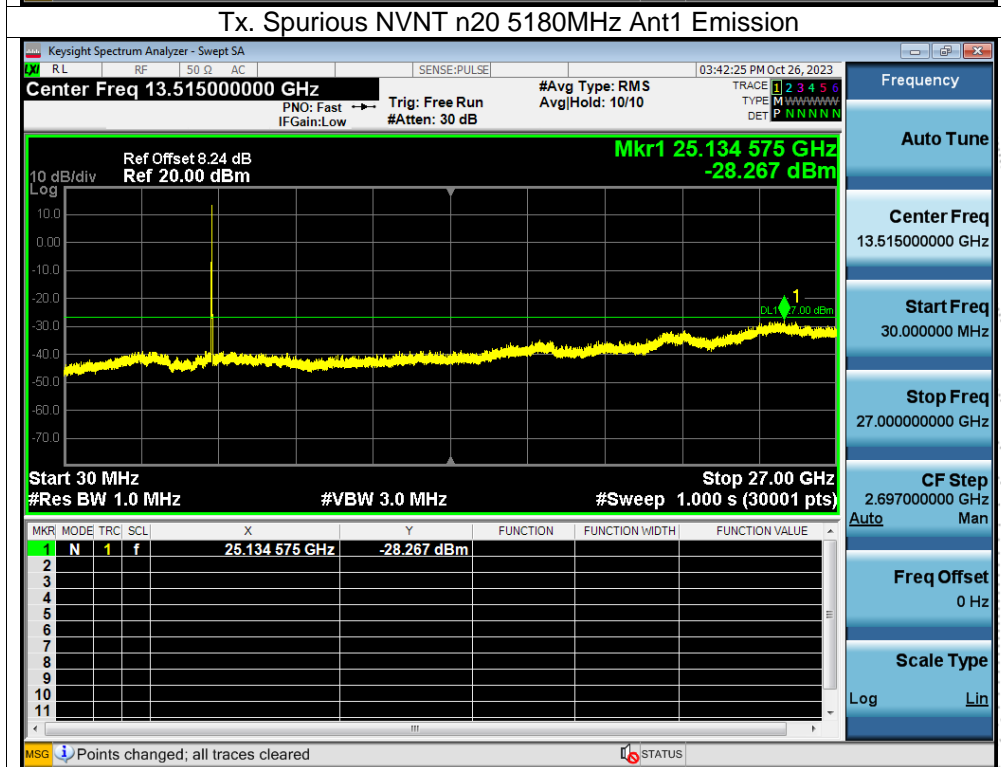
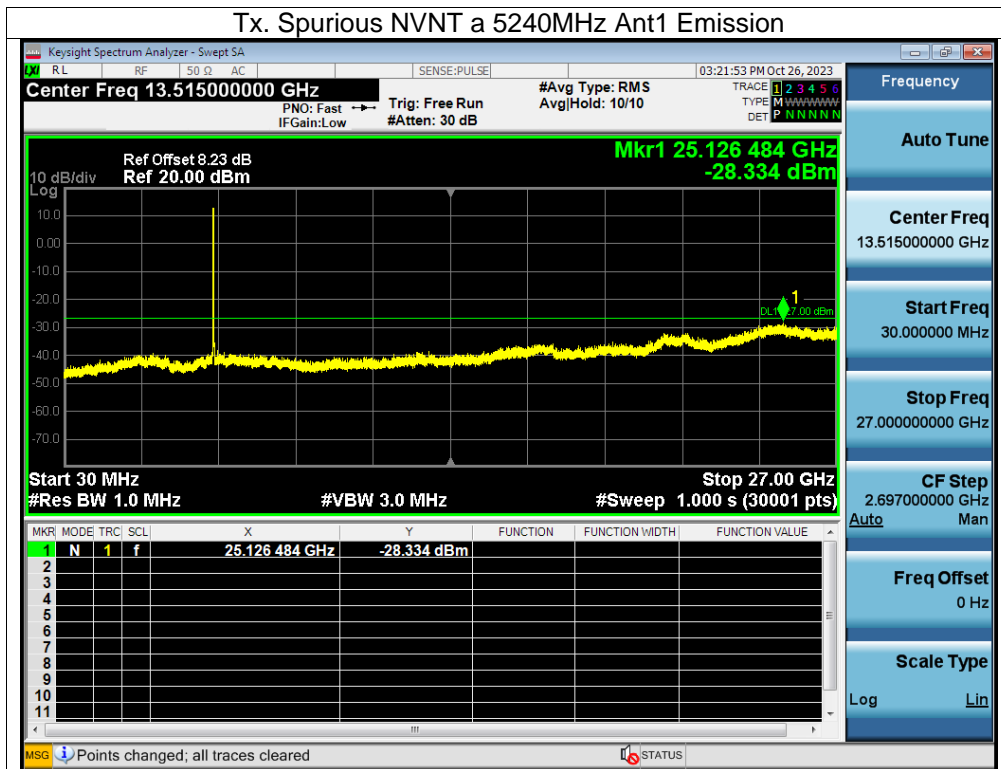

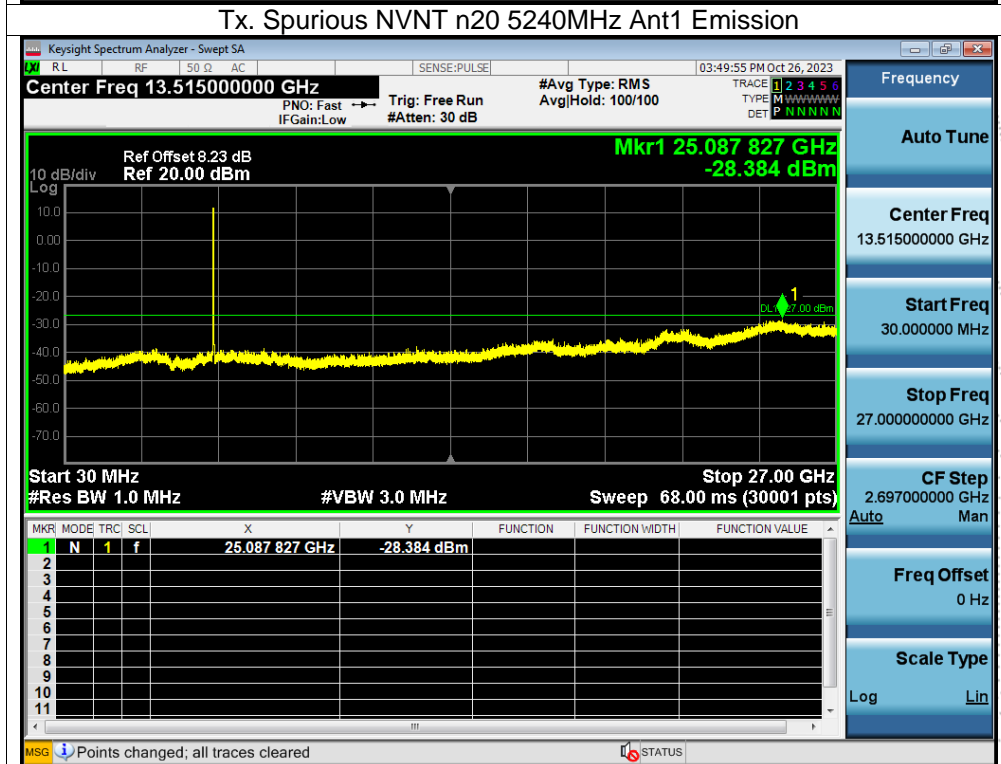
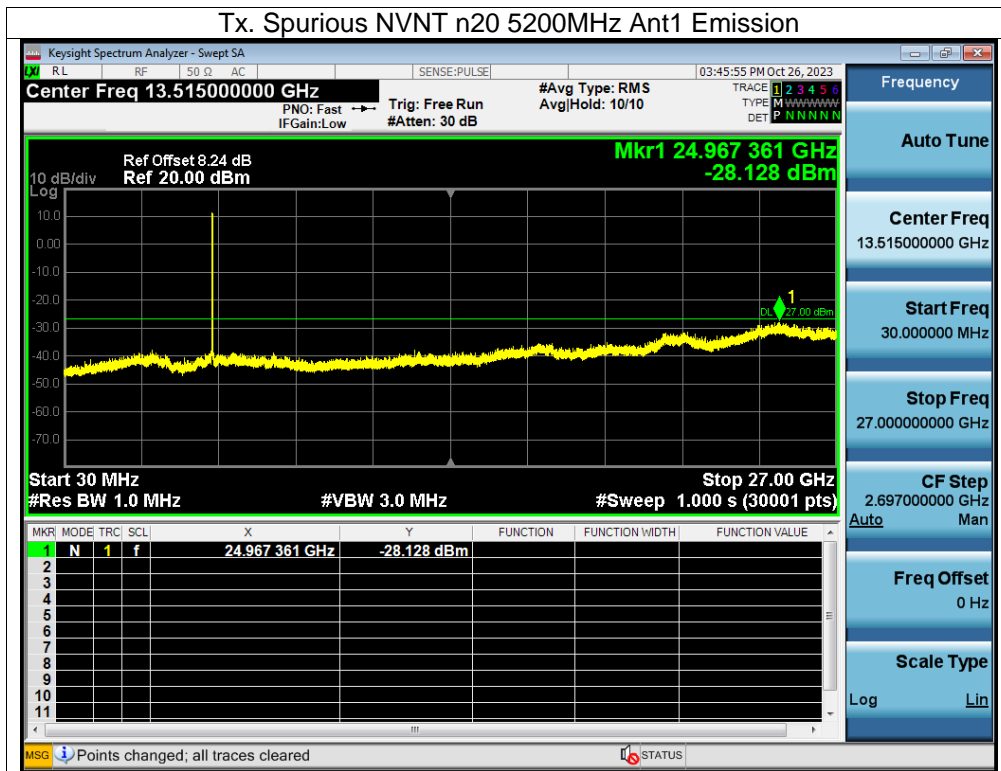

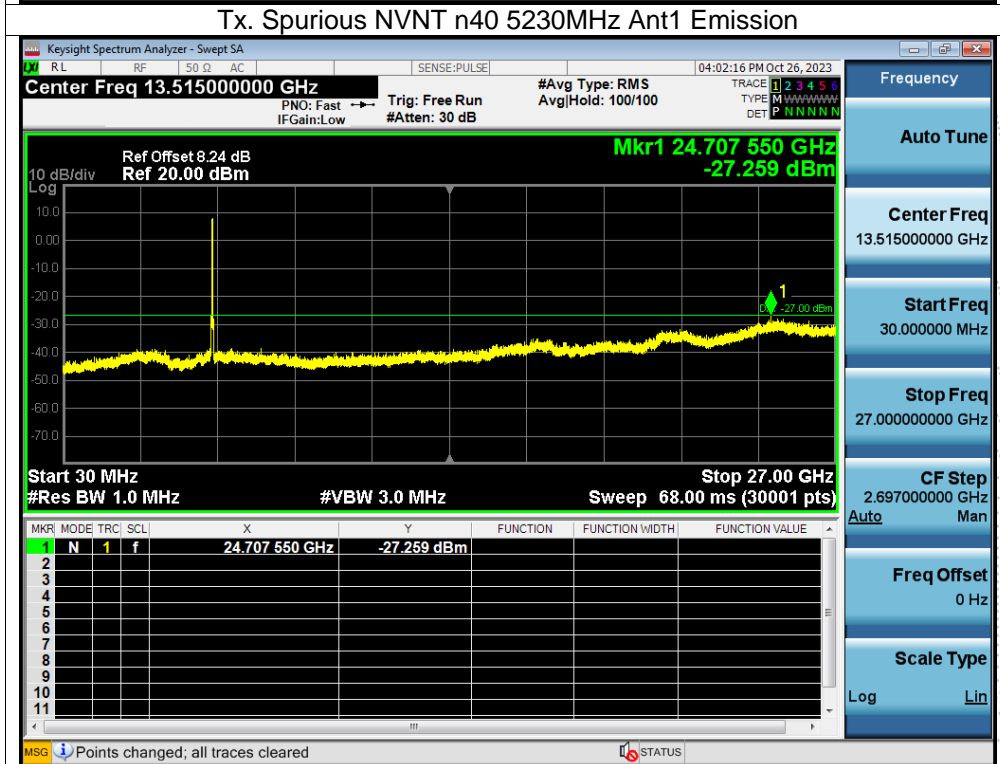
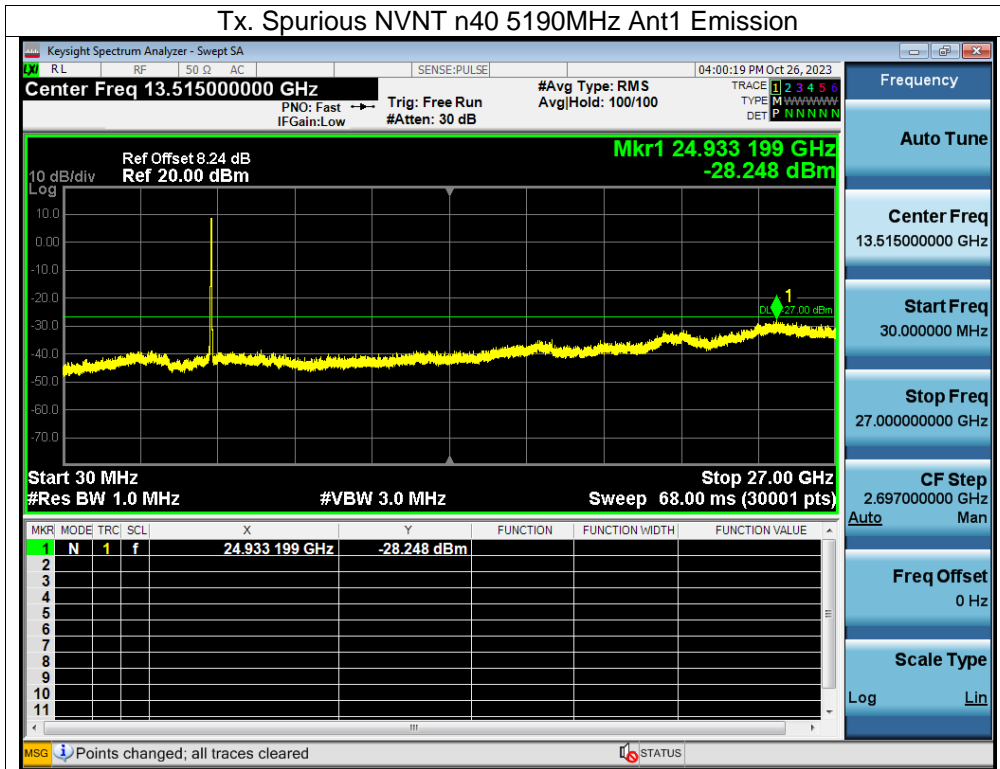

13. Frequency Stability Measurement

13.1 Block Diagram Of Test Setup



13.2 Limit

Manufactures of U-NII devices are responsible for ensuring frequency stability such that an emission is maintained within the band of operation under all conditions of normal operation as specified in the user's manual.

The transmitter center frequency tolerance shall be ± 20 ppm maximum for the 5 GHz band (IEEE 802.11n specification)..

13.3 Test Procedure

1. The transmitter output (antenna port) was connected to the spectrum analyzer.
2. EUT have transmitted absence of modulation signal and fixed channelize.
3. Set the spectrum analyzer span to view the entire absence of modulation emissions bandwidth.
4. Set RBW = 10 kHz, VBW = 10 kHz with peak detector and maxhold settings.
5. f_c is declaring of channel frequency. Then the frequency error formula is $(f_c - f) / f_c \times 10^6$ ppm and he limit is less than ± 20 ppm (IEEE 802.11n specification).
6. The test extreme voltage is to change the primary supply voltage from 85 to 115 percent of the nominal value
7. Extreme temperature is $-20^\circ\text{C} \sim 70^\circ\text{C}$.

13.4 Test Result

Temperature:	26 °C	Relative Humidity:	54%
Pressure:	101KPa	Test Voltage:	AC 30V
Test Mode:	TX (5.1G) Mode Frequency U-NII-1 (5180-5240MHz)		

Voltage vs. Frequency Stability

TEST CONDITIONS				Reference Frequency: 5180MHz			
				f	fc	Max. Deviation (MHz)	Max. Deviation (ppm)
T nom (°C)	20	V nom (V)	30.00	5180.0135	5180	0.0135	2.60
		V max (V)	34.50	5180.0106	5180	0.0106	2.06
		V min (V)	25.50	5180.0141	5180	0.0141	2.72
Limits				5150-5250 MHz			
Result				Complies			

Temperature vs. Frequency Stability

TEST CONDITIONS				Reference Frequency: 5180MHz			
				f	fc	Max. Deviation (MHz)	Max. Deviation (ppm)
V nom (V)	30	T (°C)	-20	5179.9803	5180	-0.0197	-3.80
		T (°C)	-10	5179.9884	5180	-0.0116	-2.24
		T (°C)	0	5179.9864	5180	-0.0136	-2.63
		T (°C)	10	5179.9875	5180	-0.0125	-2.41
		T (°C)	20	5179.9806	5180	-0.0194	-3.75
		T (°C)	30	5179.9852	5180	-0.0148	-2.86
		T (°C)	40	5179.9848	5180	-0.0152	-2.93
		T (°C)	50	5179.9885	5180	-0.0115	-2.22
		T (°C)	60	5179.9836	5180	-0.0164	-3.17
		T (°C)	70	5179.9837	5180	-0.0163	-3.15
Limits				5150-5250 MHz			
Result				Complies			

Voltage vs. Frequency Stability

TEST CONDITIONS				Reference Frequency: 5200MHz			
				f	fc	Max. Deviation (MHz)	Max. Deviation (ppm)
T nom (°C)	20	V nom (V)	30.00	5200.0009	5200	0.0009	0.16
		V max (V)	34.50	5200.0104	5200	0.0104	1.99
		V min (V)	25.50	5200.0131	5200	0.0131	2.53
Limits				5150-5250 MHz			
Result				Complies			

Temperature vs. Frequency Stability

TEST CONDITIONS				Reference Frequency: 5200MHz			
				f	fc	Max. Deviation (MHz)	Max. Deviation (ppm)
V nom (V)	30	T (°C)	-20	5200.00814	5200	0.00814	1.57
		T (°C)	-10	5200.00240	5200	0.00240	0.46
		T (°C)	0	5200.00662	5200	0.00662	1.27
		T (°C)	10	5200.00915	5200	0.00915	1.76
		T (°C)	20	5200.00645	5200	0.00645	1.24
		T (°C)	30	5200.00748	5200	0.00748	1.44
		T (°C)	40	5200.00154	5200	0.00154	0.30
		T (°C)	50	5200.01019	5200	0.01019	1.96
		T (°C)	60	5200.00952	5200	0.00952	1.83
		T (°C)	70	5200.01030	5200	0.01030	1.98
Limits				5150-5250 MHz			
Result				Complies			

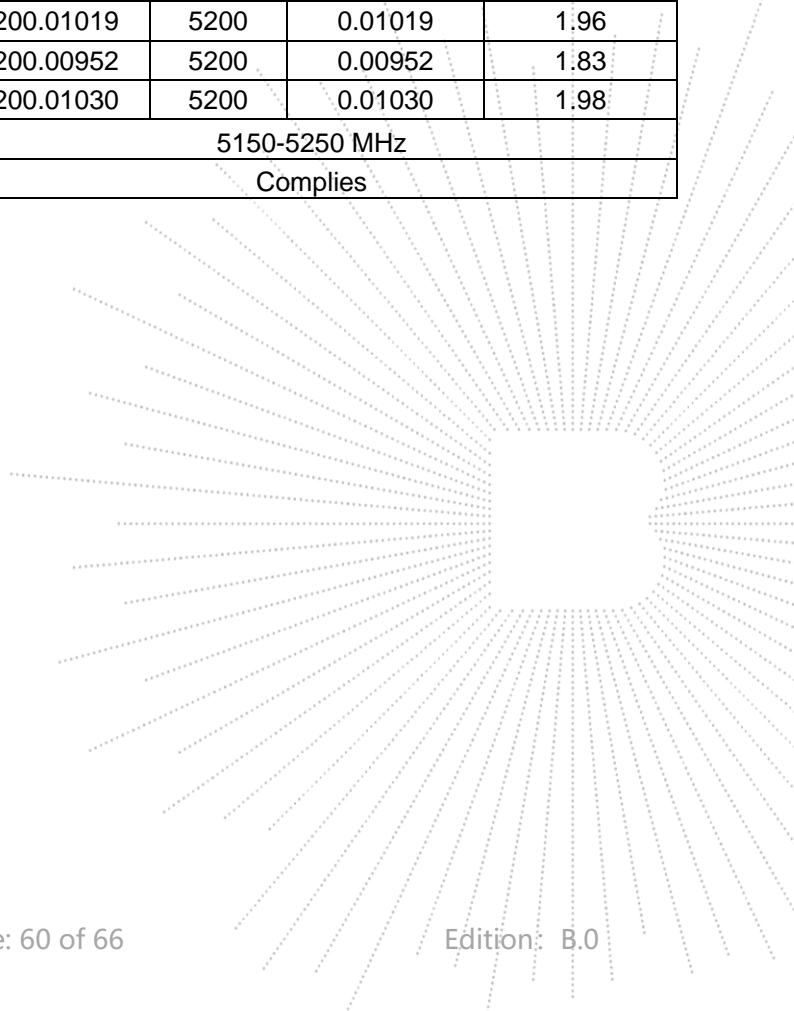

Voltage vs. Frequency Stability

TEST CONDITIONS				Reference Frequency: 5240MHz			
				f	fc	Max. Deviation (MHz)	Max. Deviation (ppm)
T nom (°C)	20	V nom (V)	30.00	5240.0102	5240	0.0102	1.95
		V max (V)	34.50	5240.0098	5240	0.0098	1.88
		V min (V)	25.50	5240.0133	5240	0.0133	2.54
Limits				5150-5250 MHz			
Result				Complies			

Temperature vs. Frequency Stability

TEST CONDITIONS				Reference Frequency: 5240MHz			
				f	fc	Max. Deviation (MHz)	Max. Deviation (ppm)
V nom (V)	30	T (°C)	-20	5240.0121	5240	0.0121	2.32
		T (°C)	-10	5240.0031	5240	0.0031	0.59
		T (°C)	0	5240.0074	5240	0.0074	1.42
		T (°C)	10	5240.0045	5240	0.0045	0.87
		T (°C)	20	5240.0062	5240	0.0062	1.17
		T (°C)	30	5240.0118	5240	0.0118	2.25
		T (°C)	40	5240.0033	5240	0.0033	0.62
		T (°C)	50	5240.0130	5240	0.0130	2.47
		T (°C)	60	5240.0067	5240	0.0067	1.27
		T (°C)	70	5240.0088	5240	0.0088	1.68
Limits				5150-5250 MHz			
Result				Complies			

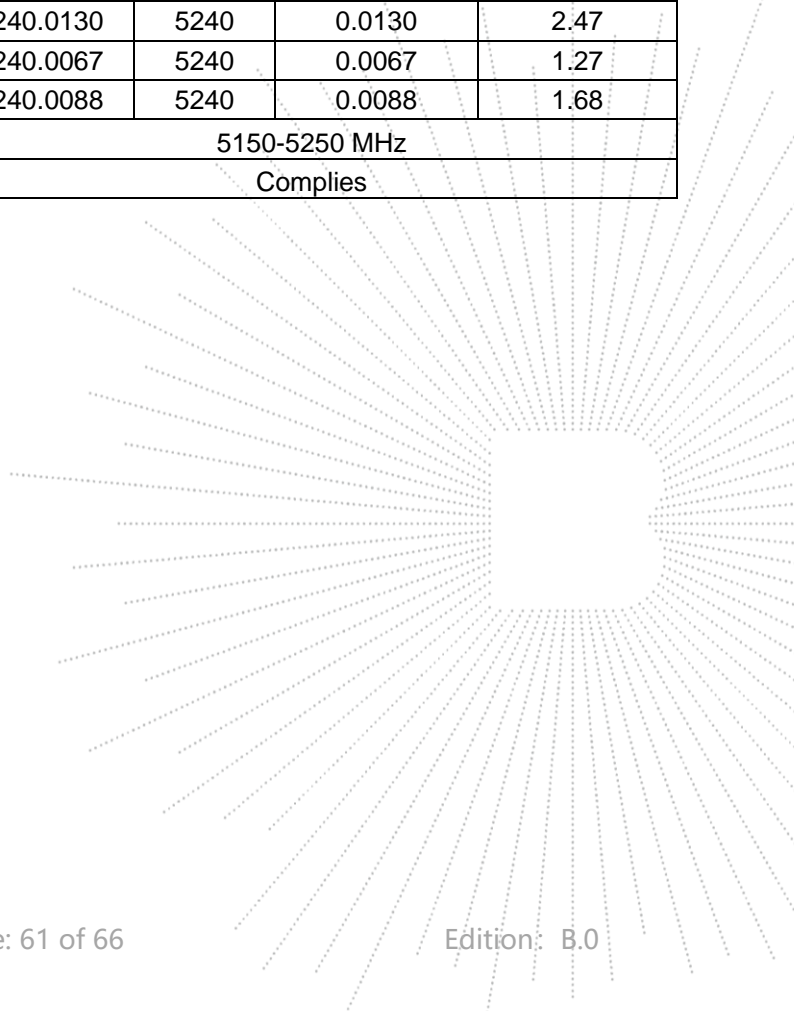

14. Duty Cycle Of Test Signal

14.1 Standard Requirement

Pre-analysis Check: While conducting average power measurement, duty cycle of each mode shall be checked to ensure its duty cycle in order to compensate for the loss due to insufficient ratio of duty cycle. All duty cycle is pre-scanned, and result as obtained below shows only the most representative ones where duty cycle is conducted as the given transmission with given virtual operation that expresses the percentage.

14.2 Formula

Duty Cycle = $T_{on} / (T_{on} + T_{off})$

14.3 Test Procedure

1. Set span = Zero
2. RBW = 8MHz
3. VBW = 8MHz,
4. Detector = Peak

14.4 Test Result

Condition	Mode	Frequency (MHz)	Duty Cycle (%)	Correction Factor (dB)	1/T (kHz)
NVNT	a	5180	100	0	0
NVNT	a	5200	100	0	0
NVNT	a	5240	100	0	0
NVNT	n20	5180	100	0	0
NVNT	n20	5200	100	0	0
NVNT	n20	5240	100	0	0
NVNT	n40	5190	100	0	0
NVNT	n40	5230	100	0	0

15. Antenna Requirement

15.1 Limit

15.203 requirement: For intentional device, according to 15.203: an intentional radiator shall be designed to ensure that no antenna other than that furnished by the responsible party shall be used with the device.

15.2 Test Result

The EUT antenna is internal antenna, fulfill the requirement of this section.

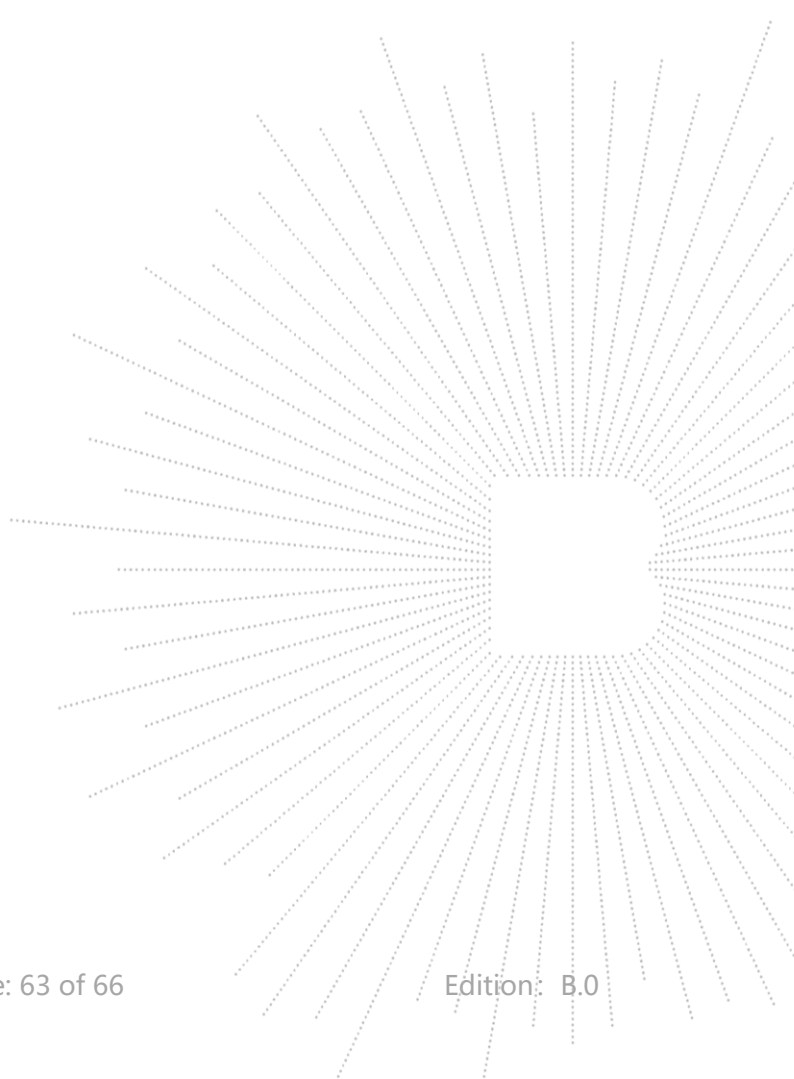

16. EUT Test Setup Photographs

Conducted emissions

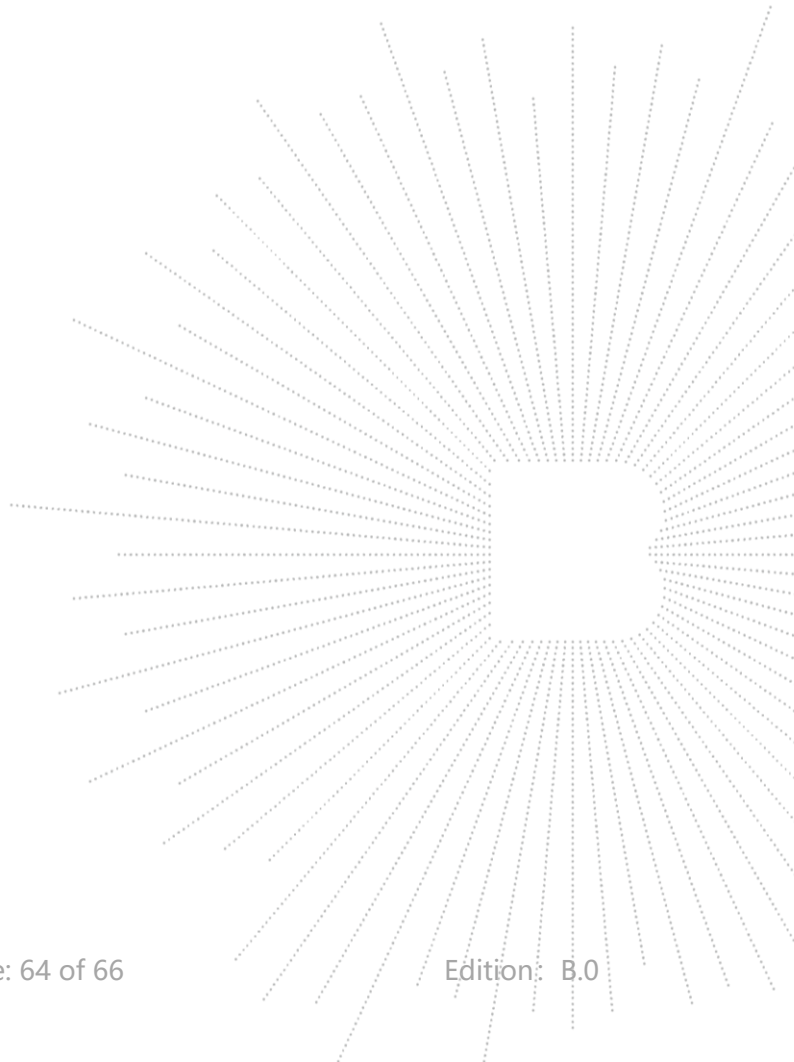

Radiated Measurement Photos

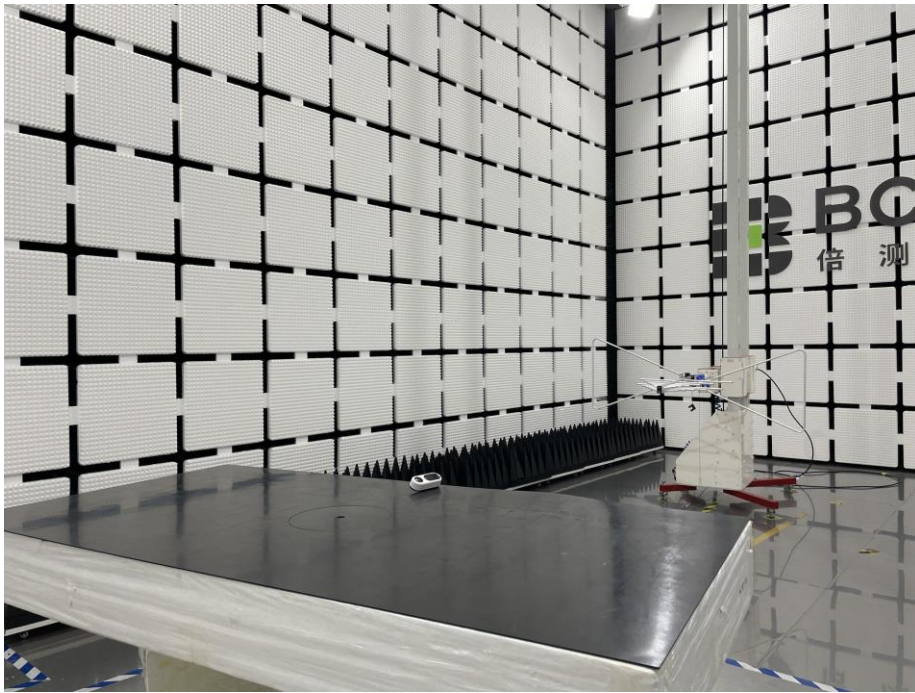

STATEMENT

1. The equipment lists are traceable to the national reference standards.
2. The test report can not be partially copied unless prior written approval is issued from our lab.
3. The test report is invalid without the "special seal for inspection and testing".
4. The test report is invalid without the signature of the approver.
5. The test process and test result is only related to the Unit Under Test.
6. Sample information is provided by the client and the laboratory is not responsible for its authenticity.
7. The quality system of our laboratory is in accordance with ISO/IEC17025.
8. If there is any objection to this test report, the client should inform issuing laboratory within 15 days from the date of receiving test report.

Address:

1-2/F., Building B, Pengzhou Industrial Park, No.158, Fuyuan 1st Road, Zhancheng, Fuhai Subdistrict, Bao'an District, Shenzhen, Guangdong, China

TEL:400-788-9558

P.C.: 518103

FAX:0755-33229357

Website:<http://www.chnbctc.com>

E-Mail:bctc@bctc-lab.com.cn

***** END *****

