



TEST REPORT

Report No.: **CHTEW20040115** Report verification : 

Project No.: **SHT1910069302EW**

FCC ID.....: **2AJ9T-ZL400**

Applicant's name.....: **ZKTECO CO., LTD.**

Address.....: No.26,Pingshan 188 Industry zone,Tangxia Town,Dongguan City,Guangdong Province,China 523728

Manufacturer.....: **ZKTECO CO., LTD.**

Address.....: No.26,Pingshan 188 Industry zone,Tangxia Town,Dongguan City,Guangdong Province,China 523728

Test item description: **Wireless Hotel Lock**

Trade Mark: **ZKTECO**

Model/Type reference.....: **ZL400**

Listed Model(s): **-**

Standard: **FCC CFR Title 47 Part 15 Subpart C Section 15.225**

Date of receipt of test sample.....: **Nov.04, 2019**

Date of testing.....: **Nov.04, 2019- Apr.15, 2020**

Date of issue.....: **Apr.16, 2020**

Result.....: **PASS**

Compiled by
 (position+printedname+signature)....: File administrators Echo Wei

Echo Wei

Supervised by
 (position+printedname+signature).....: Project Engineer Kiki Kong

Kiki Kong

Approved by
 (position+printedname+signature).....: RF Manager Hans Hu

Hans Hu

Testing Laboratory Name: **Shenzhen Huatongwei International Inspection Co., Ltd.**

Address.....: 1/F, Bldg 3, Hongfa Hi-tech Industrial Park, Genyu Road, Tianliao, Gongming, Shenzhen, China

Shenzhen Huatongwei International Inspection Co., Ltd. All rights reserved.

This publication may be reproduced in whole or in part for non-commercial purposes as long as the Shenzhen Huatongwei International Inspection Co., Ltd. is acknowledged as copyright owner and source of the material. Shenzhen Huatongwei International Inspection Co., Ltd. takes no responsibility for and will not assume liability for damages resulting from the reader's interpretation of the reproduced material due to its placement and context.

The test report merely correspond to the test sample.

Contents

1.	<u>TEST STANDARDS AND REPORT VERSION</u>	3
1.1.	Test Standards	3
1.2.	Report version information	3
2.	<u>TEST DESCRIPTION</u>	4
3.	<u>SUMMARY</u>	5
3.1.	Client Information	5
3.2.	Product Description	5
3.3.	EUT operation mode	6
3.4.	EUT configuration	6
4.	<u>TEST ENVIRONMENT</u>	7
4.1.	Address of the test laboratory	7
4.2.	Test Facility	7
4.3.	Environmental conditions	8
4.4.	Statement of the measurement uncertainty	8
4.5.	Equipments Used during the Test	9
5.	<u>TEST CONDITIONS AND RESULTS</u>	11
5.1.	Antenna requirement	11
5.2.	AC Power Conducted Emissions	12
5.3.	Field Strength of the Fundamental and Mask Measurement	13
5.4.	20dB Bandwidth	15
5.5.	Radiated Emission	17
5.6.	Frequency Stability	21
6.	<u>TEST SETUP PHOTOS OF THE EUT</u>	22
7.	<u>EXTERNAL AND INTERNAL PHOTOS OF THE EUT</u>	23

1. TEST STANDARDS AND REPORT VERSION

1.1. Test Standards

The tests were performed according to following standards:

[FCC Rules Part 15.225](#): Operation within the band 13.110-14.010 MHz.

[ANSI C63.10-2013](#): American National Standard for Testing Unlicensed Wireless Devices.

1.2. Report version information

Revision No.	Date of issue	Description
N/A	2020-04-16	Original

2. TEST DESCRIPTION

Test Item	Section in CFR 47	Result	Test Engineer
Antenna requirement	15.203	PASS	N/A
AC Power Line Conducted Emissions	15.207	N/A	N/A
Field Strength of the Fundamental and Mask Measurement	15.225(a)(b)(c)	PASS	Pan Xie
20dB Bandwidth	15.215	PASS	Bruce Wong
Radiated Emission	15.225(d)&15.209	PASS	Pan Xie
Frequency Stability	15.225(e)	PASS	Pan Xie

3. SUMMARY

3.1. Client Information

Applicant:	ZKTECO CO., LTD.
Address:	No.26,Pingshan 188 Industry zone,Tangxia Town,Dongguan City,Guangdong Province,China 523728
Manufacturer:	ZKTECO CO., LTD.
Address:	No.26,Pingshan 188 Industry zone,Tangxia Town,Dongguan City,Guangdong Province,China 523728

3.2. Product Description

Name of EUT:	Wireless Hotel Lock
Trade Mark:	ZKTECO
Model No.:	ZL400
Listed Model(s):	-
Power supply:	DC 6V by 1.5*4AA battery
Adapter information:	-
Hardware version:	V1.02
Software version:	V1.03
RF Specification	
Operation frequency:	13.56MHz
Channel number:	1
Modulation Type:	ASK
Antenna type:	Coil antenna
Antenna Gain:	0.5 dBi

3.3. EUT operation mode

TEST MODE

For RF test items
The engineering test program was provided and enabled to make EUT continuous transmit.
For AC power line conducted emissions:
The EUT was set to connect with large package sizes transmission.

3.4. EUT configuration

The following peripheral devices and interface cables were connected during the measurement:

- - supplied by the manufacturer
- - supplied by the lab

	Manufacturer :	/
	Model No. :	/
	Manufacturer :	/
	Model No. :	/

4. TEST ENVIRONMENT

4.1. Address of the test laboratory

Laboratory: Shenzhen Huatongwei International Inspection Co., Ltd.

Address: 1/F, Bldg 3, Hongfa Hi-tech Industrial Park, Genyu Road, Tianliao, Gongming, Shenzhen, China

Phone: 86-755-26748019 Fax: 86-755-26748089

4.2. Test Facility

The test facility is recognized, certified, or accredited by the following organizations:

CNAS-Lab Code: L1225

Shenzhen Huatongwei International Inspection Co., Ltd. has been assessed and proved to be in compliance with CNAS-CL01 Accreditation Criteria for Testing and Calibration Laboratories (identical to ISO/IEC17025: 2005 General Requirements) for the Competence of Testing and Calibration Laboratories.

A2LA-Lab Cert. No. 3902.01

Shenzhen Huatongwei International Inspection Co., Ltd. EMC Laboratory has been accredited by A2LA for technical competence in the field of electrical testing, and proved to be in compliance with ISO/IEC 17025: 2005 General Requirements for the Competence of Testing and Calibration Laboratories and any additional program requirements in the identified field of testing.

FCC-Registration No.: 762235

Shenzhen Huatongwei International Inspection Co., Ltd. EMC Laboratory has been registered and fully described in a report filed with the FCC (Federal Communications Commission). The acceptance letter from the FCC is maintained in our files. Registration 762235.

IC-Registration No.: 5377A

Two 3m Alternate Test Site of Shenzhen Huatongwei International Inspection Co., Ltd. has been registered by Certification and Engineering Bureau of Industry Canada for the performance of radiated measurements with Registration No. 5377A.

ACA

Shenzhen Huatongwei International Inspection Co., Ltd. EMC Laboratory can also perform testing for the Australian C-Tick mark as a result of our A2LA accreditation.

4.3. Environmental conditions

During the measurement the environmental conditions were within the listed ranges:

Temperature:	15~35°C
Relative Humidity:	30~60 %
Air Pressure:	950~1050mba

4.4. Statement of the measurement uncertainty

The data and results referenced in this document are true and accurate. The reader is cautioned that there may be errors in calibration limits of the equipment and facilities. The measurement uncertainty was calculated for all measurements listed in this test report according to TR-100028-01 "Electromagnetic compatibility and Radio spectrum Matters (ERM);Uncertainties in the measurement of mobile radio equipment characteristics;Part 1" and TR-100028-02 "Electromagnetic compatibility and Radio spectrum Matters (ERM);Uncertainties in the measurementof mobile radio equipment characteristics;Part 2" and is documented in the Shenzhen Huatongwei International Inspection Co., Ltd quality system according to ISO/IEC 17025. Further more, component and process variability of devices similar to that tested may result in additional deviation. The manufacturer has the sole responsibility of continued compliance of the device.

Here after the best measurement capability for Shenzhen Huatongwei is reported:

Test Items	Measurement Uncertainty	Notes
Conducted Disturbance 9KHz-30MHz	3.02 dB	(1)
Radiated emissions below 1GHz	4.90 dB	(1)
Radiated emissions above 1GHz	4.96 dB	(1)
Occupied Bandwidth	15 Hz	(1)

(1) This uncertainty represents an expanded uncertainty expressed at approximately the 95% confidence level using a coverage factor of k=1.96.

4.5. Equipments Used during the Test

● Conducted Emission							
Used	Test Equipment	Manufacturer	Equipment No.	Model No.	Serial No.	Last Cal. Date (YY-MM-DD)	Next Cal. Date (YY-MM-DD)
●	Shielded Room	Albatross projects	HTWE0114	N/A	N/A	2018/09/28	2023/09/27
●	EMI Test Receiver	R&S	HTWE0111	ESCI	101247	2019/10/26	2020/10/25
●	Artificial Mains	SCHWARZBECK	HTWE0113	NNLK 8121	573	2019/10/23	2020/10/22
●	Pulse Limiter	R&S	HTWE0033	ESH3-Z2	100499	2019/10/23	2020/10/22
●	RF Connection Cable	HUBER+SUHNER	HTWE0113-02	ENVIROFLE X_142	EF-NM-BNCM-2M	2019/10/23	2020/10/22
●	Test Software	R&S	N/A	ES-K1	N/A	N/A	N/A

● Radiated emission-6th test site							
Used	Test Equipment	Manufacturer	Equipment No.	Model No.	Serial No.	Last Cal. Date (YY-MM-DD)	Next Cal. Date (YY-MM-DD)
●	Semi-Anechoic Chamber	Albatross projects	HTWE0127	SAC-3m-02	C11121	2018/09/30	2021/09/29
●	EMI Test Receiver	R&S	HTWE0099	ESCI	100900	2019/10/26	2020/10/25
●	Loop Antenna	R&S	HTWE0170	HFH2-Z2	100020	2018/04/02	2021/04/01
●	Ultra-Broadband Antenna	SCHWARZBECK	HTWE0119	VULB9163	546	2020/04/05	2023/04/04
●	Pre-Amplifier	SCHWARZBECK	HTWE0295	BBV 9742	N/A	2019/11/14	2020/11/13
●	RF Connection Cable	HUBER+SUHNER	HTWE0062-01	N/A	N/A	2019/08/21	2020/08/20
●	RF Connection Cable	HUBER+SUHNER	HTWE0062-02	SUCOFLEX 104	501184/4	2019/05/27	2020/05/26
●	Test Software	R&S	N/A	ES-K1	N/A	N/A	N/A

● Radiated emission-7th test site							
Used	Test Equipment	Manufacturer	Equipment No.	Model No.	Serial No.	Last Cal. Date (YY-MM-DD)	Next Cal. Date (YY-MM-DD)
●	Semi-Anechoic Chamber	Albatross projects	HTWE0122	SAC-3m-01	N/A	2018/09/27	2021/09/26
●	Spectrum Analyzer	R&S	HTWE0098	FSP40	100597	2019/10/26	2020/10/25
●	Horn Antenna	SCHWARZBECK	HTWE0126	9120D	1011	2020/04/01	2023/03/31
●	Horn Antenna	SCHWARZBECK	HTWE0103	BBHA9170	25841	2018/10/11	2021/10/10
●	Broadband Horn Antenna	SCHWARZBECK	HTWE0103	BBHA9170	BBHA9170472	2018/10/11	2021/10/10
●	Pre-amplifier	CD	HTWE0071	PAP-0102	12004	2019/11/14	2020/11/13
●	Broadband Pre-amplifier	SCHWARZBECK	HTWE0201	BBV 9718	9718-248	2019/05/23	2020/05/22
●	RF Connection Cable	HUBER+SUHNER	HTWE0120-01	6m 18GHz S Serisa	N/A	2019/05/10	2020/05/09
●	RF Connection Cable	HUBER+SUHNER	HTWE0120-02	6m 3GHz RG Serisa	N/A	2019/05/10	2020/05/09
●	RF Connection Cable	HUBER+SUHNER	HTWE0120-03	6m 3GHz RG Serisa	N/A	2019/05/10	2020/05/09
●	RF Connection Cable	HUBER+SUHNER	HTWE0120-04	6m 3GHz RG Serisa	N/A	2019/05/10	2020/05/09
●	RF Connection Cable	HUBER+SUHNER	HTWE0121-01	6m 18GHz S Serisa	N/A	2019/05/10	2020/05/09
●	Test Software	Audix	N/A	E3	N/A	N/A	N/A

● RF Conducted Method						
Used	Test Equipment	Manufacturer	Model No.	Serial No.	Last Cal. Date (YY-MM-DD)	Next Cal. Date (YY-MM-DD)
●	Signal and spectrum Analyzer	R&S	FSV40	100048	2019/10/26	2020/10/25
●	Spectrum Analyzer	Agilent	N9020A	MY50510187	2019/10/26	2020/10/25
○	Radio communication tester	R&S	CMW500	137688-Lv	2019/10/26	2020/10/25

5. TEST CONDITIONS AND RESULTS

5.1. Antenna requirement

Requirement

FCC CFR Title 47 Part 15 Subpart C Section 15.203:

An intentional radiator shall be designed to ensure that no antenna other than that furnished by the responsible party shall be used with the device. The use of a permanently attached antenna or of an antenna that uses a unique coupling to the intentional radiator, the manufacturer may design the unit so that a broken antenna can be replaced by the user, but the use of a standard antenna jack or electrical connector is prohibited.

Refer to statement below for compliance.

The manufacturer may design the unit so that the user can replace a broken antenna, but the use of a standard antenna jack or electrical connector is prohibited. Further, this requirement does not apply to intentional radiators that must be professionally installed.

TEST RESULTS

Passed **Not Applicable**

The directional gain of the antenna less than 6 dBi, please refer to the below antenna photo.

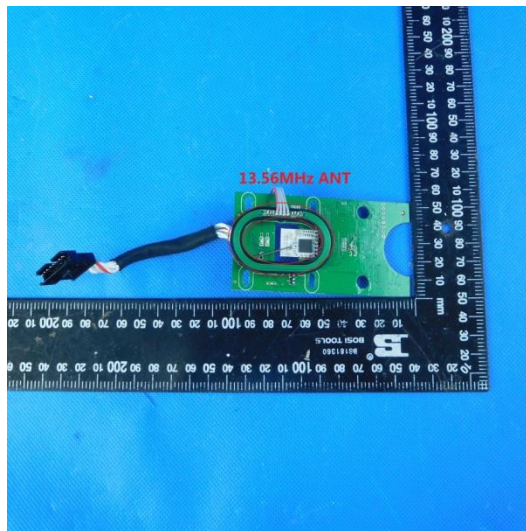

5.2. AC Power Conducted Emissions

LIMIT

FCC CFR Title 47 Part 15 Subpart C Section 15.207:

Frequency range (MHz)	Limit (dBuV)	
	Quasi-peak	Average
0.15-0.5	66 to 56*	56 to 46*
0.5-5	56	46
5-30	60	50

* Decreases with the logarithm of the frequency.

TEST CONFIGURATION

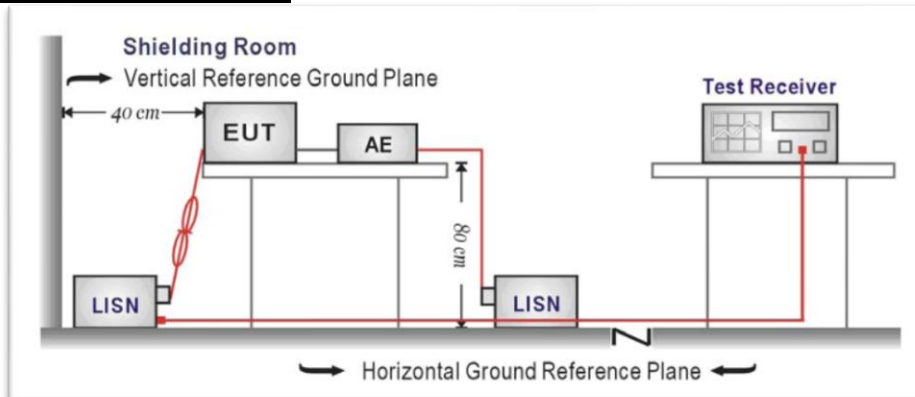

TEST PROCEDURE

1. The EUT was setup according to ANSI C63.10:2013
2. The EUT was placed on a plat form of nominal size, 1 m by 1.5 m, raised 80 cm above the conducting ground plane. The vertical conducting plane was located 40 cm to the rear of the EUT. All other surfaces of EUT were at least 80 cm from any other grounded conducting surface.
3. The EUT and simulators are connected to the main power through a line impedance stabilization network (LISN). The LISN provides a 50ohm / 50uH coupling impedance for the measuring equipment.
4. The peripheral devices are also connected to the main power through a LISN. (Please refer to the block diagram of the test setup and photographs)
5. Each current-carrying conductor of the EUT power cord, except the ground (safety) conductor, was individually connected through a LISN to the input power source.
6. The excess length of the power cord between the EUT and the LISN receptacle were folded back and forth at the center of the lead to form a bundle not exceeding 40 cm in length.
7. Conducted emissions were investigated over the frequency range from 0.15MHz to 30MHz using a receiver bandwidth of 9 kHz.
8. During the above scans, the emissions were maximized by cable manipulation.

TEST MODE:

Please refer to the clause 3.3

TEST RESULTS

Passed Not Applicable

5.3. Field Strength of the Fundamental and Mask Measurement

LIMIT

FCC CFR Title 47 Part 15 Subpart C Section 15.225(a)(b)(c)

Fundamental frequency(MHz)	Field strength of fundamental (uV/m @30m)	Field strength of fundamental (dBuV/m @3m)
13.553-13.567	15848	124.0
13.410-13.553&13.567-13.710	334	90.5
13.110-13.410&13.710-14.010	106	80.5

Note: Limit dBuV/m @3m =Limit dBuV/m @30m +40*log(30/3)= Limit dBuV/m @30m + 40.

TEST CONFIGURATION

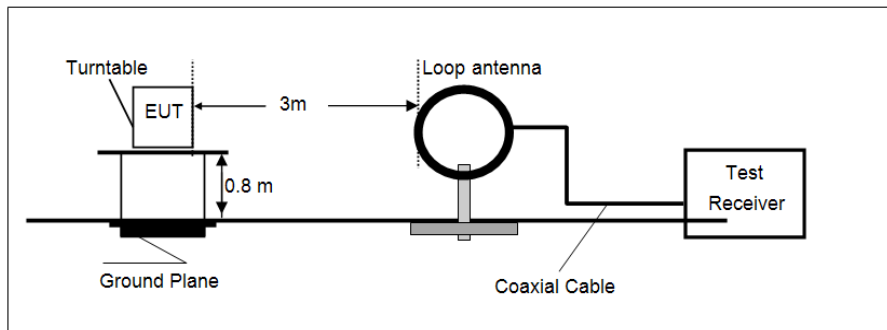

TEST PROCEDURE

1. The EUT was setup and tested according to ANSI C63.10:2013 requirements.
2. The EUT is placed on a turn table which is 0.8 meter above ground. The turn table is rotated 360 degrees to determine the position of the maximum emission level.
3. The EUT was positioned such that the distance from antenna to the EUT was 3 meters.
4. The antenna is scanned from 1 meter to 4 meters to find out the maximum emission level. This is repeated for both horizontal and vertical polarization of the antenna. In order to find the maximum emission, all of the interface cables were manipulated according to ANSI C63.10:2013 on radiated measurement.

TEST MODE:

Please refer to the clause 3.3

TEST RESULTS

Passed Not Applicable

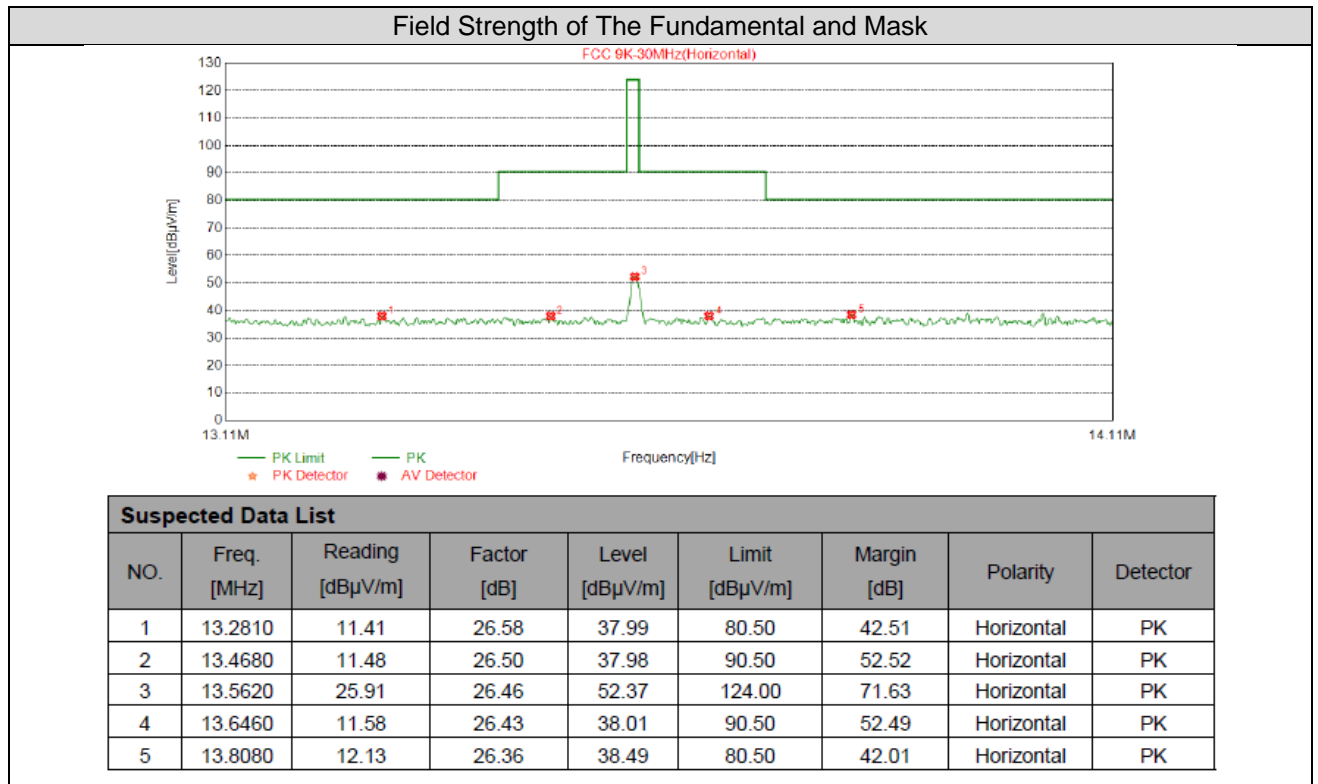

5.4. 20dB Bandwidth

Limit

FCC CFR Title 47 Part 15 Subpart C Section 15.215

Intentional radiators must be designed to ensure that the 20dB emission bandwidth in the specific band 13.553~13.567MHz.

TEST CONFIGURATION

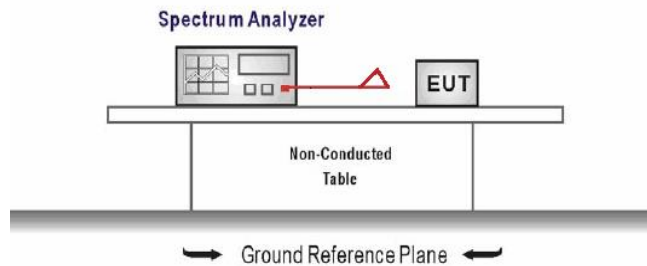

TEST PROCEDURE

1. The transmitter output was connected to the spectrum analyzer through an attenuator, the path loss was compensated to the results for each measurement.
2. Set to the maximum power setting and enable the EUT transmit continuously
3. Use the following spectrum analyzer settings:
Span = approximately 2 to 3 times the 20 dB bandwidth, centered on a hopping channel
RBW \geq 1% of the 20 dB bandwidth, VBW \geq RBW
Sweep = auto, Detector function = peak, Trace = max hold
4. Measure and record the results in the test report.

TEST MODE:

Please refer to the clause 3.3

TEST RESULTS

Passed Not Applicable

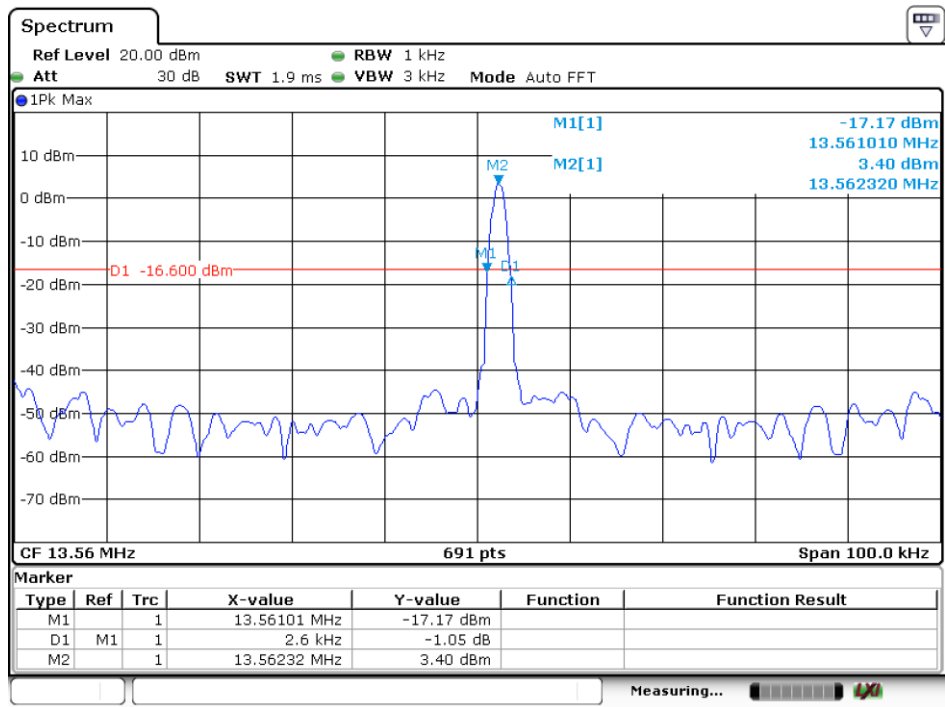

Date: 21.NOV.2019 17:49:56

Frequency Range (MHz)	$f_L > 13.553$
	$f_H < 13.567$
20dB Bandwidth(kHz):	2.60

5.5. Radiated Emission

LIMIT

FCC CFR Title 47 Part 15 Subpart C Section 15.209&15.225(d)

Limit for frequency below 30MHz:

Frequency	Limit (uV/m)	Measurement Distance(m)	Remark
0.009~0.490	2400/F(kHz)	300	Quasi-peak
0.490~1.705	24000/F(kHz)	30	Quasi-peak
1.705~30.0	30	30	Quasi-peak

Note: Limit dBuV/m @3m = Limit dBuV/m @300m + 40*log(300/3)= Limit dBuV/m @300m +80,
 Limit dBuV/m @3m = Limit dBuV/m @30m +40*log(30/3)= Limit dBuV/m @30m + 40.

Limit for frequency above 30MHz:

Frequency	Limit (dBuV/m@3m)	Remark
30MHz~88MHz	40.00	Quasi-peak
88MHz~216MHz	43.50	Quasi-peak
216MHz~960MHz	46.00	Quasi-peak
960MHz-1GHz	54.00	Quasi-peak
Above 1GHz	54.00	Average
	74.00	Peak

TEST CONFIGURATION

- 9 kHz ~ 30 MHz

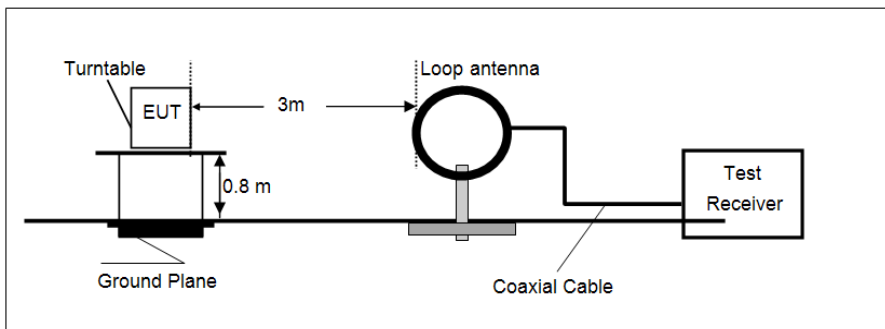

- 30 MHz ~ 1 GHz

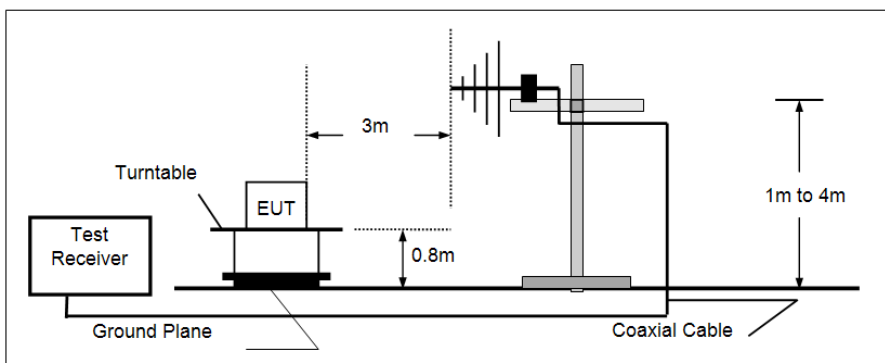

- Above 1 GHz

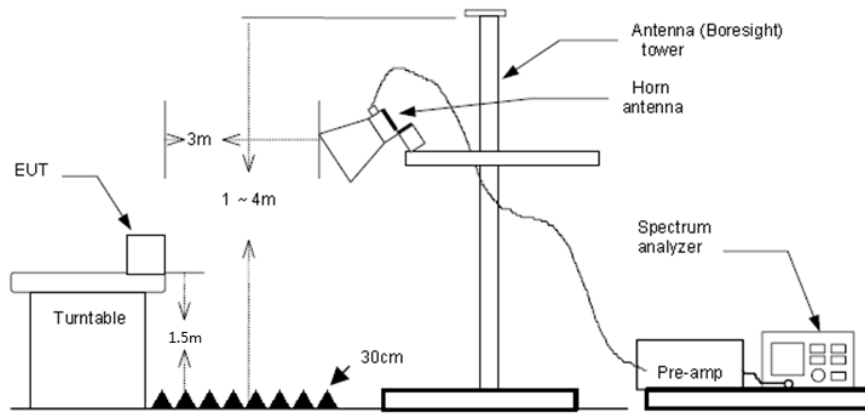

TEST PROCEDURE

1. The EUT was setup and tested according to ANSI C63.10:2013 requirements.
2. The EUT is placed on a turn table which is 0.8 meter above ground for below 1 GHz, and 1.5 m for above 1 GHz. The turn table is rotated 360 degrees to determine the position of the maximum emission level.
3. The EUT was set 3 meters from the receiving antenna, which was mounted on the top of a variable height antenna tower.
4. For each suspected emission, the EUT was arranged to its worst case and then tune the Antenna tower (from 1 m to 4 m) and turntable (from 0 degree to 360 degrees) to find the maximum reading. A pre-amp and a high pass filter are used for the test in order to get better signal level to comply with the guidelines.
5. Set to the maximum power setting and enable the EUT transmit continuously.
6. Use the following spectrum analyzer settings
 - (1) Span shall wide enough to fully capture the emission being measured;
 - (2) Below 30MHz:
RBW=10 kHz, VBW=30 kHz, Sweep=auto, Detector function=peak, Trace=max hold;
 - (3) 30MHz to 1 GHz:
RBW=120 kHz, VBW=300 kHz, Sweep=auto, Detector function=peak, Trace=max hold;
If the emission level of the EUT measured by the peak detector is 3 dB lower than the applicable limit, the peak emission level will be reported. Otherwise, the emission measurement will be repeated using the quasi-peak detector and reported.
 - (4) From 1 GHz to 10th harmonic:
RBW=1MHz, VBW=3MHz Peak detector for Peak value.
RBW=1MHz, VBW=3MHz RMS detector for Average value.

TEST MODE:

Please refer to the clause 3.3

TEST RESULTS

Passed Not Applicable

Below 30MHz:

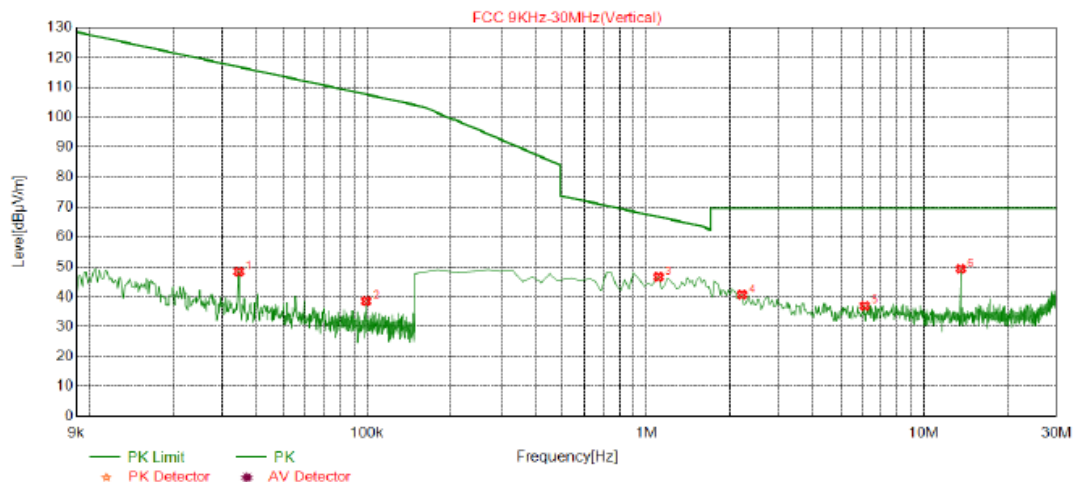

Suspected Data List							
NO.	Freq. [MHz]	Reading [dBµV/m]	Factor [dB]	Level [dBµV/m]	Limit [dBµV/m]	Margin [dB]	Detector
1	0.0345	21.50	26.91	48.41	116.83	68.42	PK
2	0.0992	11.37	27.17	38.54	107.66	69.12	PK
3	1.1052	18.81	27.79	46.60	66.70	20.10	PK
4	2.2097	12.69	27.99	40.68	69.54	28.86	PK
5	6.1200	8.81	28.18	36.99	69.54	32.55	PK
6	13.5527	22.86	26.47	49.33	69.54	20.21	PK

Above 30MHz:

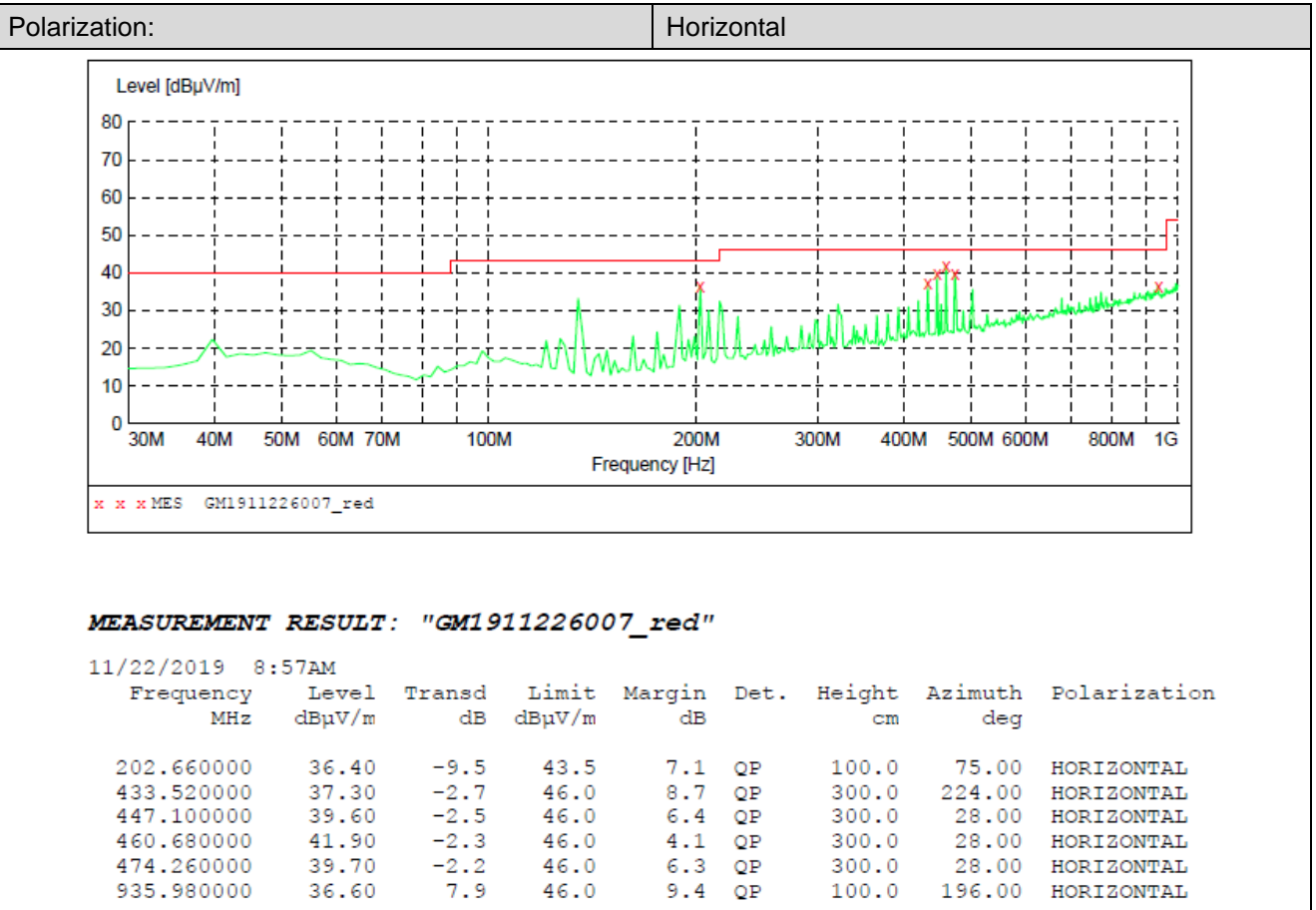
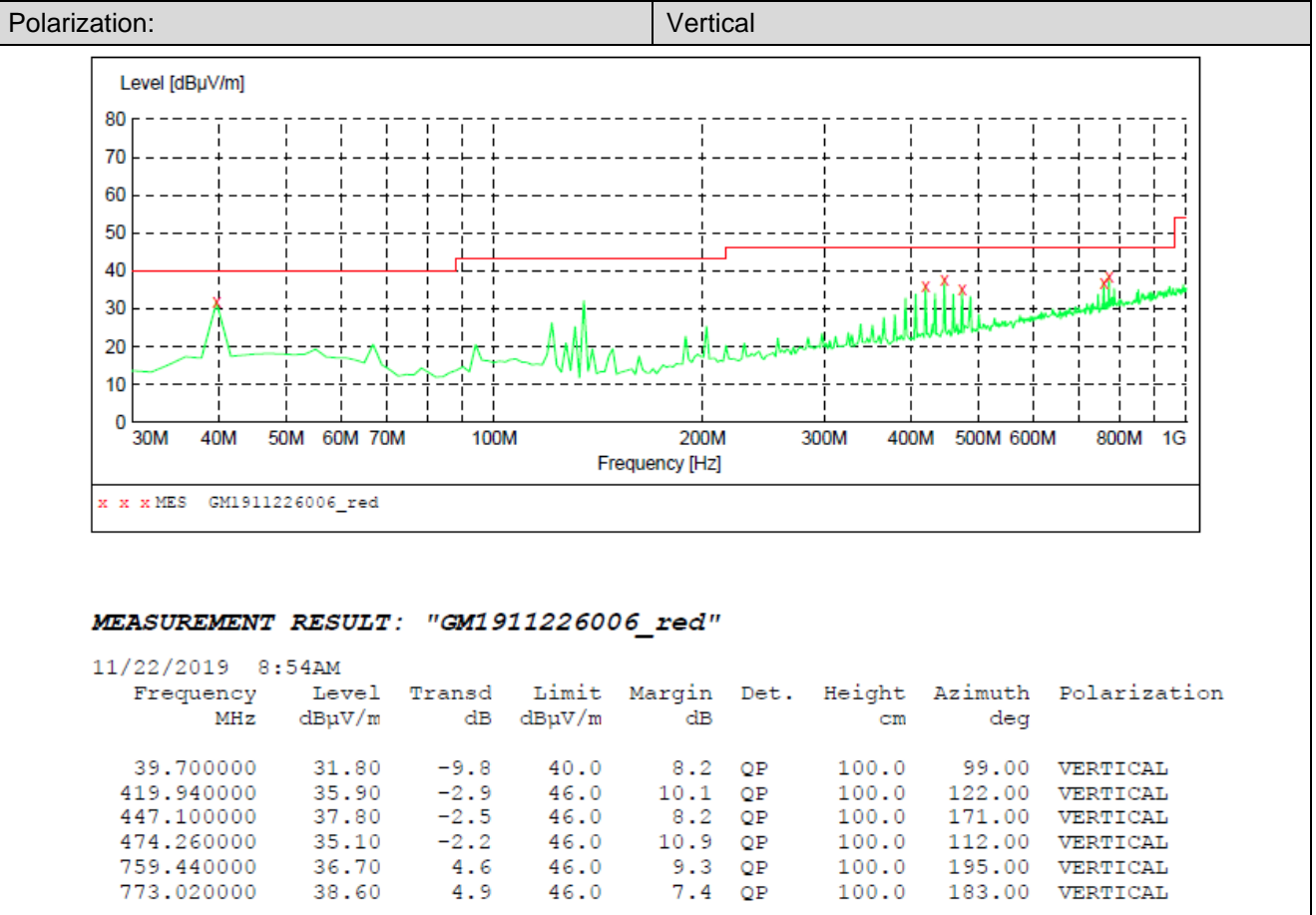

5.6. Frequency Stability

LIMIT

The frequency tolerance of the carrier signal shall be maintained within $\pm 0.01\%$ of the operating frequency over a temperature variation of -20 degrees to $+ 50$ degrees C at normal supply voltage, and for a variation in the primary supply voltage from 85% to 115% of the rated supply voltage at a temperature of 20 degrees C. For battery operated equipment, the equipment tests shall be performed using a new battery.

TEST CONFIGURATION

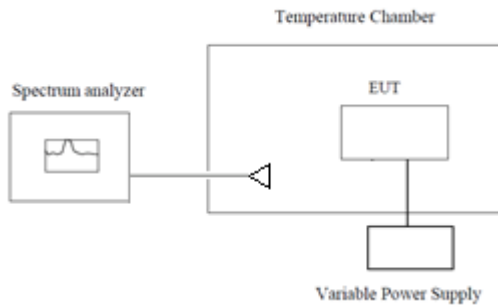

TEST PROCEDURE

1. The equipment under test was connected to an external power supply.
2. RF output was connected to a frequency counter or spectrum analyzer via feed through attenuators.
3. The EUT was placed inside the temperature chamber.
4. Set the spectrum analyzer RBW low enough to obtain the desired frequency resolution and measure EUT 25°C operating frequency as reference frequency.
5. Turn EUT off and set the chamber temperature to -20°C . After the temperature stabilized for approximately 30 minutes recorded the frequency.
6. Repeat step measure with 10°C increased per stage until the highest temperature of $+50^{\circ}\text{C}$ reached.

TEST MODE:

Please refer to the clause 3.3

TEST RESULTS

Passed Not Applicable

Test Enviroment		Frequency Reading(MHz)	Frequency Error(%)	Limit	Result
Voltage	Temperature($^{\circ}\text{C}$)				
DC6.00V	-20	13.56010	0.0007	$\pm 0.01\%$	Pass
	-10	13.56009	0.0007	$\pm 0.01\%$	Pass
	0	13.56009	0.0007	$\pm 0.01\%$	Pass
	10	13.56008	0.0006	$\pm 0.01\%$	Pass
	20	13.56009	0.0007	$\pm 0.01\%$	Pass
	30	13.56009	0.0007	$\pm 0.01\%$	Pass
	40	13.56012	0.0009	$\pm 0.01\%$	Pass
	50	13.56014	0.0010	$\pm 0.01\%$	Pass
DC6.90V	20	13.56010	0.0007	$\pm 0.01\%$	Pass
DC5.10V	20	13.56012	0.0009	$\pm 0.01\%$	Pass

6. TEST SETUP PHOTOS OF THE EUT

Radiated Emissions



7. EXTERNAL AND INTERNAL PHOTOS OF THE EUT

Reference to the test report No.: CHTEW20040114.

-----End of Report-----