

# User Manual

## XFace300

Date: August 2020

Doc Version: 1.0

English

Thank you for choosing our product. Please read the instructions carefully before operation. Follow these instructions to ensure that the product is functioning properly. The images shown in this manual are for illustrative purposes only.



For further details, please visit our Company's website  
[www.zkteco.com](http://www.zkteco.com).

Copyright © 2020 ZKTECO CO., LTD. All rights reserved.

Without the prior written consent of ZKTeco, no portion of this manual can be copied or forwarded in any way or form. All parts of this manual belong to ZKTeco and its subsidiaries (hereinafter the "Company" or "ZKTeco").

## Trademark

**ZKTeco** is a registered trademark of ZKTeco. Other trademarks involved in this manual are owned by their respective owners.

## Disclaimer

This manual contains information on the operation and maintenance of the ZKTeco equipment. The copyright in all the documents, drawings, etc. in relation to the ZKTeco supplied equipment vests in and is the property of ZKTeco. The contents hereof should not be used or shared by the receiver with any third party without express written permission of ZKTeco.

The contents of this manual must be read as a whole before starting the operation and maintenance of the supplied equipment. If any of the content(s) of the manual seems unclear or incomplete, please contact ZKTeco before starting the operation and maintenance of the said equipment.

It is an essential pre-requisite for the satisfactory operation and maintenance that the operating and maintenance personnel are fully familiar with the design and that the said personnel have received thorough training in operating and maintaining the machine/unit/equipment. It is further essential for the safe operation of the machine/unit/equipment that personnel has read, understood and followed the safety instructions contained in the manual.

In case of any conflict between terms and conditions of this manual and the contract specifications, drawings, instruction sheets or any other contract-related documents, the contract conditions/documents shall prevail. The contract specific conditions/documents shall apply in priority.

ZKTeco offers no warranty, guarantee or representation regarding the completeness of any information contained in this manual or any of the amendments made thereto. ZKTeco does not extend the warranty of any kind, including, without limitation, any warranty of design, merchantability or fitness for a particular purpose.

ZKTeco does not assume responsibility for any errors or omissions in the information or documents which are referenced by or linked to this manual. The entire risk as to the results and performance obtained from using the information is assumed by the user.

ZKTeco in no event shall be liable to the user or any third party for any incidental, consequential, indirect, special, or exemplary damages, including, without limitation, loss of business, loss of profits, business interruption, loss of business information or any pecuniary loss, arising out of, in connection with, or relating to the use of the information contained in or referenced by this manual, even if ZKTeco has been advised of the possibility of such damages.

This manual and the information contained therein may include technical, other inaccuracies or typographical errors. ZKTeco periodically changes the information herein which will be incorporated into new additions/amendments to the manual. ZKTeco reserves the right to add, delete, amend or modify the information contained in the manual from time to time in the form of circulars, letters, notes, etc. for better operation and safety of the machine/unit/equipment. The said additions or amendments are meant for improvement /better operations of the machine/unit/equipment and such amendments shall not give any right to claim any compensation or damages under any circumstances.

ZKTeco shall in no way be responsible (i) in case the machine/unit/equipment malfunctions due to any non-compliance of the instructions contained in this manual (ii) in case of operation of the machine/unit/equipment beyond the rate limits (iii) in case of operation of the machine and equipment in conditions different from the prescribed conditions of the manual.

The product will be updated from time to time without prior notice. The latest operation procedures and relevant documents are available on <http://www.zkteco.com>

If there is any issue related to the product, please contact us.

### ZKTeco Headquarters

**Address** ZKTeco Industrial Park, No. 26, 188 Industrial Road,  
Tangxia Town, Dongguan, China.

**Phone** +86 769 - 82109991

**Fax** +86 755 - 89602394

For business related queries, please write to us at: [sales@zkteco.com](mailto:sales@zkteco.com).

To know more about our global branches, visit [www.zkteco.com](http://www.zkteco.com).

## About the Company

ZKTeco is one of the world's largest manufacturer of RFID and Biometric (Fingerprint, Facial, Finger-vein) readers. Product offerings include Access Control readers and panels, Near & Far-range Facial Recognition Cameras, Elevator/floor access controllers, Turnstiles, License Plate Recognition (LPR) gate controllers and Consumer products including battery-operated fingerprint and face-reader Door Locks. Our security solutions are multi-lingual and localized in over 18 different languages. At the ZKTeco state-of-the-art 700,000 square foot ISO9001-certified manufacturing facility, we control manufacturing, product design, component assembly, and logistics/shipping, all under one roof.

The founders of ZKTeco have been determined for independent research and development of biometric verification procedures and the productization of biometric verification SDK, which was initially widely applied in PC security and identity authentication fields. With the continuous enhancement of the development and plenty of market applications, the team has gradually constructed an identity authentication ecosystem and smart security ecosystem, which are based on biometric verification techniques. With years of experience in the industrialization of biometric verifications, ZKTeco was officially established in 2007 and now has been one of the globally leading enterprises in the biometric verification industry owning various patents and being selected as the National High-tech Enterprise for 6 consecutive years. Its products are protected by intellectual property rights.

## About the Manual

This manual introduces the operations of XFace300 product.

All figures displayed are for illustration purposes only. Figures in this manual may not be exactly consistent with the actual products.





## Document Conventions

Conventions used in this manual are listed below:

### GUI Conventions

For Software	
Convention	Description
<b>Bold font</b>	Used to identify software interface names e.g. <b>OK, Confirm, Cancel</b>
>	Multi-level menus are separated by these brackets. For example, File > Create > Folder.
For Device	
Convention	Description
<>	Button or key names for devices. For example, press <OK>
[]	Window names, menu items, data table, and field names are inside square brackets. For example, pop up the [New User] window
/	Multi-level menus are separated by forwarding slashes. For example, [File/Create/Folder].

### Symbols

Convention	Description
	This implies about the notice or pays attention to, in the manual
	The general information which helps in performing the operations faster
	The information which is significant
	Care taken to avoid danger or mistakes
	The statement or event that warns of something or that serves as a cautionary example.

## Table of Contents

<b>1</b>	<b>OVERVIEW.....</b>	<b>8</b>
1.1	APPEARANCE.....	8
1.2	SYSTEM SPECIFICATIONS.....	9
1.3	PRODUCT PIN DIAGRAM.....	9
1.4	INSTALLATION SET-UP.....	10
1.4.1	SAFETY PRECAUTIONS.....	10
1.4.2	INSTALLATION SITE.....	10
1.4.3	INSTALLATION TOOLS.....	10
1.4.4	INSTALLATION STEPS.....	10
1.5	CONNECTION PROCEDURE.....	11
1.5.1	CONNECTING AUXILIARY DEVICES AND BUTTONS.....	11
1.5.2	LOCK RELAY CONNECTION.....	12
1.5.3	WEIGAND READER CONNECTION.....	12
1.5.4	ETHERNET CONNECTION.....	13
1.5.5	PRINTER CONNECTION.....	13
1.5.6	RS485 CONNECTION.....	14
1.5.7	POWER.....	14
<b>2</b>	<b>OPERATIONAL PROCEDURE .....</b>	<b>15</b>
2.1	FACE REGISTRATION.....	15
2.2	CORRECT AND INCORRECT POSITIONS.....	16
2.3	VERIFICATION MODES.....	17
2.3.1	BADGE.....	17
2.3.2	FACE.....	20
2.3.3	PASSWORD.....	23
2.3.4	COMBINATION.....	26
<b>3</b>	<b>MAIN MENU .....</b>	<b>27</b>
<b>4</b>	<b>USER MANAGEMENT.....</b>	<b>28</b>
4.1	ADDING USERS.....	28
4.2	SEARCH FOR USERS.....	31
4.3	EDIT USERS.....	32
4.4	DELETING USERS.....	33
<b>5</b>	<b>USER ROLE .....</b>	<b>34</b>
<b>6</b>	<b>COMMUNICATION SETTINGS.....</b>	<b>37</b>
6.1	NETWORK SETTINGS.....	37
6.2	SERIAL PORT SETTINGS.....	39
6.3	PC CONNECTION.....	39
6.4	WIFI SETTING.....	40
6.5	CLOUD SERVER SETTING.....	42
6.6	WIEGAND SETUP.....	43

**7 SYSTEM SETTINGS..... 47**

7.1 DATE AND TIME .....48

7.2 ACCESS LOGS SETTING.....50

7.3 FACE PARAMETERS.....51

7.4 FACTORY RESET .....53

**8 PERSONALIZE SETTINGS..... 54**

8.1 INTERFACE SETTINGS .....55

8.2 VOICE SETTINGS .....56

8.3 BELL SCHEDULES.....56

8.4 PUNCH STATES OPTIONS.....58

8.5 SHORTCUT KEYS MAPPINGS.....59

**9 DATA MANAGEMENT ..... 60**

9.1 DELETE DATA.....61

**10 ACCESS CONTROL ..... 63**

10.1 ACCESS CONTROL OPTIONS.....64

10.2 TIME SCHEDULE.....65

10.3 HOLIDAY SETTINGS.....67

10.4 COMBINED VERIFICATION SETTINGS .....68

10.5 ANTI-PASSBACK SETUP .....70

10.6 DURESS OPTIONS SETTINGS.....71

**11 ATTENDANCE SEARCH ..... 72**

**12 PRINT..... 75**

**13 AUTOTEST..... 76**

**14 SYSTEM INFORMATION..... 77**

**APPENDIX 1 ..... 78**

REQUIREMENTS OF LIVE COLLECTION AND REGISTRATION OF VISIBLE LIGHT FACE IMAGES.....78

REQUIREMENTS FOR VISIBLE LIGHT DIGITAL FACE IMAGE DATA.....79

**APPENDIX 2 ..... 80**

STATEMENT ON THE RIGHT TO PRIVACY .....80

ECO-FRIENDLY OPERATION.....81

# 1 Overview

## 1.1 Appearance

Front and Rear View

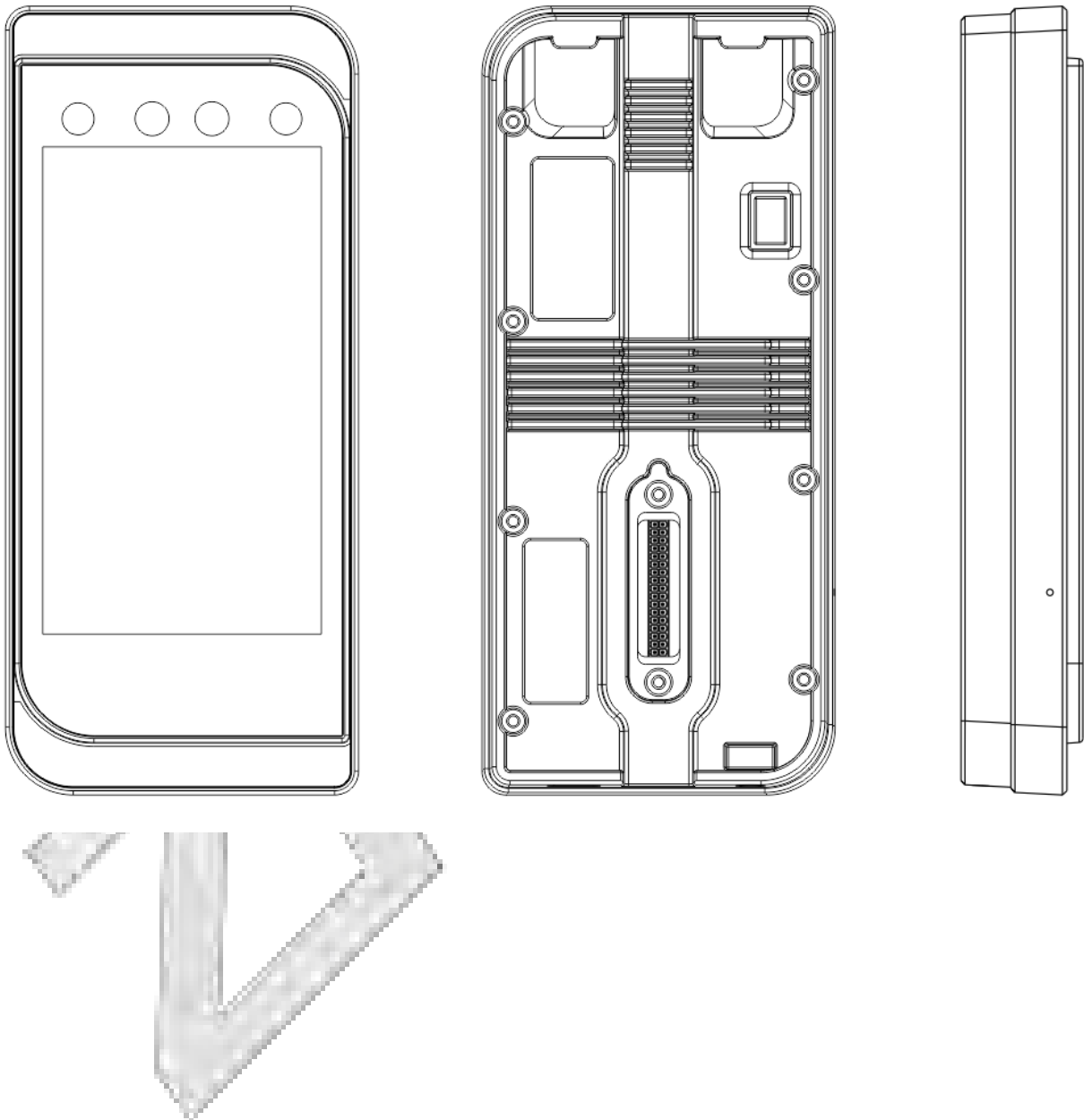



## 1.2 System Specifications

Category	Feature	Description
<b>Credentials</b>	Biometrics	Face
	Card	ID, Mifare/HID (optional)
	Password	Numbers (maximum 8 digits)
<b>General</b>	LCD Type	5-inch TFT LCD
	LCD Resolution	720*1280
	Operating Temperature	-10°C to 45°C (-50°F to 113°F)
	Operating Humidity	20% to 80% RH
	Dimensions (WxHxD)	88(W)x197(H)x30.5(D)mm
	Wi-Fi	Supported
<b>Capacity</b>	Maximum Transactions Records	1000,000
	Maximum users (1: N)	10,000 (can be expanded to 30,000)
	Maximum cards	10,000 (can be expanded to 30,000)
<b>Electrical</b>	Power	12V, 3A

## 1.3 Product PIN Diagram

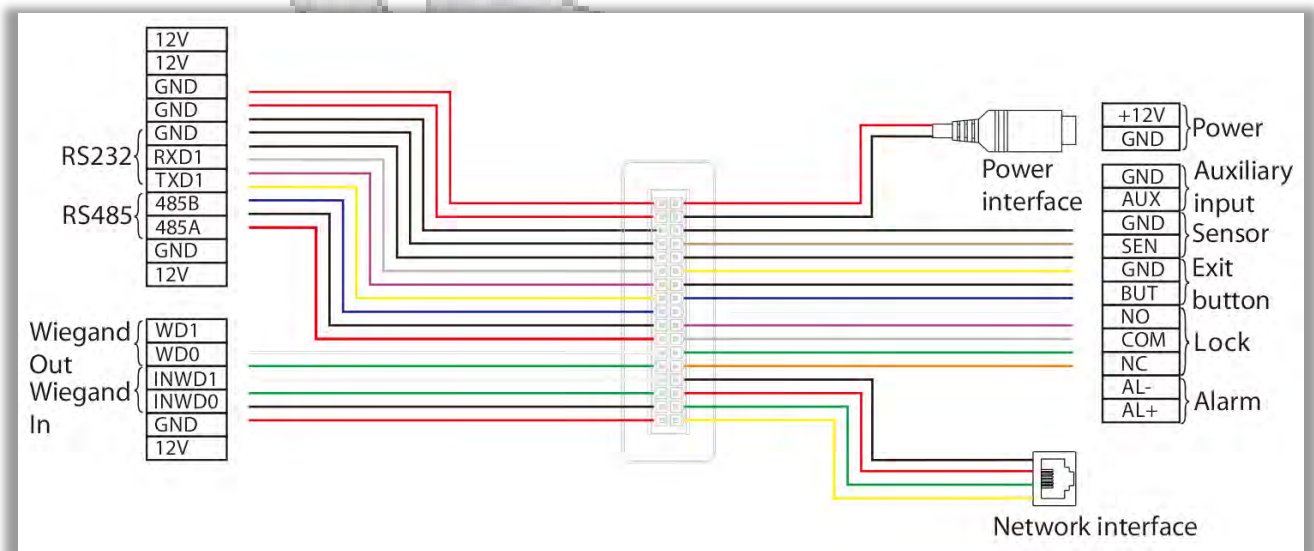

## 1.4 Installation Set-up

### 1.4.1 Safety Precautions

- Keep the device away from water or dampness. Prevent water or moisture from entering the chassis of the attendance device.
- Do not place the device on an unstable case or desk. The device might be damaged severely in case of a fall.
- Ensure proper ventilation of the equipment room and keep the ventilation vents of the device free of obstruction.
- Make sure that the operating voltage is the same one labelled on the attendance device.
- Do not open the chassis when the attendance device is operating or when electrical hazards are present to avoid electrical shocks.

### 1.4.2 Installation Site

The device must be installed in indoor and adequate clearance is reserved at the air inlet/exhaust vents for heat dissipation.

### 1.4.3 Installation Tools

- Flat-blade screwdriver
- Phillips screwdriver: P2-150mm

### 1.4.4 Installation Steps

Make sure that the device is installed as per the installation instructions. If you want to open the chassis, you should contact the agent for permission. Otherwise, you will bear any consequence resulting from your actions.

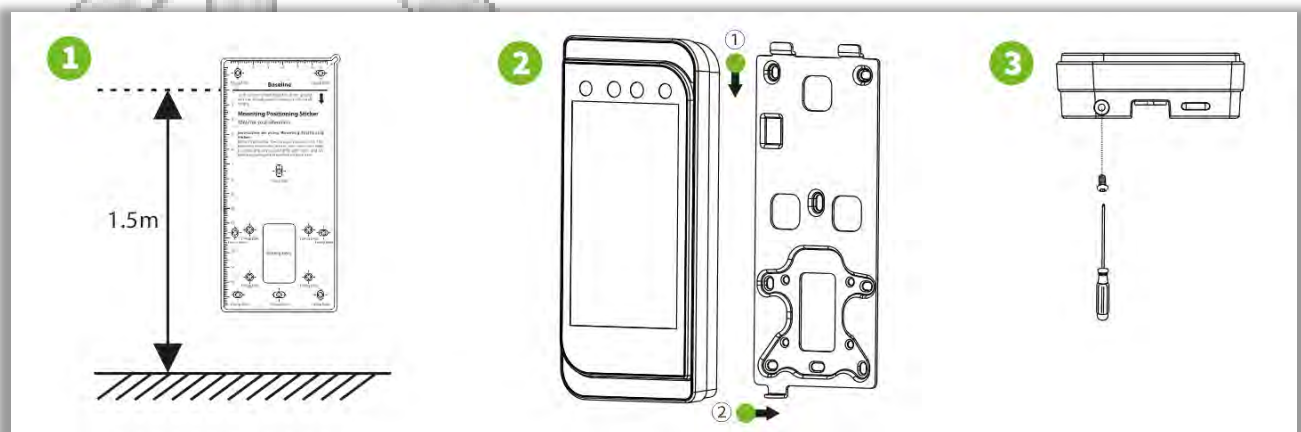

Step 1: Attach the mounting template sticker to the wall, and drill holes according to the mounting paper. Fix the back plate on the wall using wall mounting screws.

Step 2: Attach the device to the back plate.

Step 3: Fasten the device to the back plate with a security screw.

## 1.5 Connection Procedure

### 1.5.1 Connecting Auxiliary Devices and Buttons

- Connect the Exit button to the **GND** and **BUT** terminals.
- Connect the Door Sensor to the **SEN** and **GND** terminals.
- Connect the Alarm to the **AL +** and **AL-** terminals.
- Connect the Auxiliary device to the **GND** and **AUX** terminals.

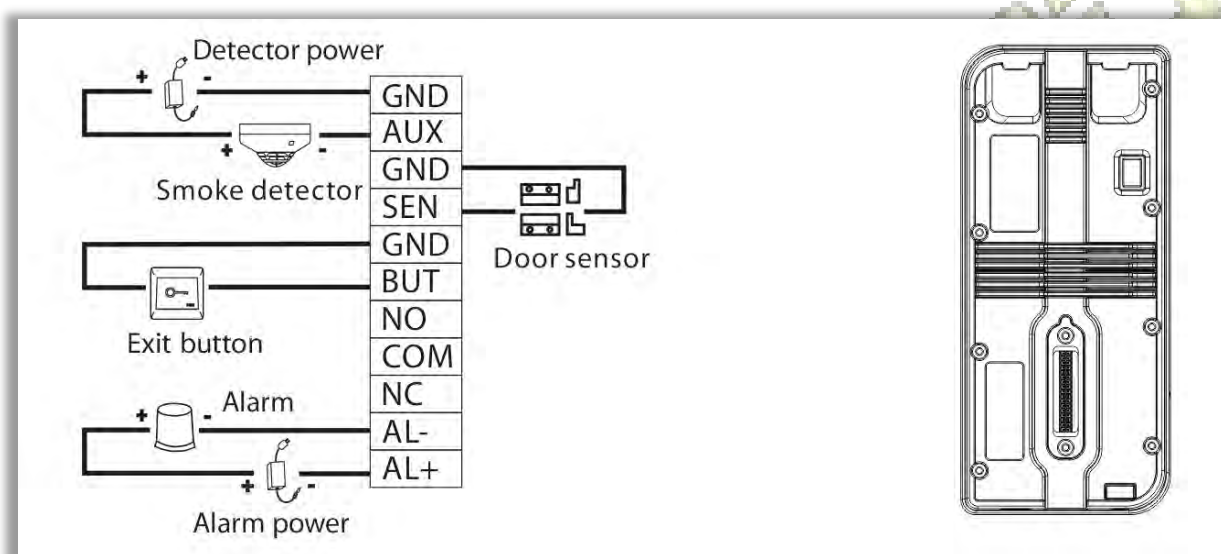

### 1.5.2 Lock Relay Connection

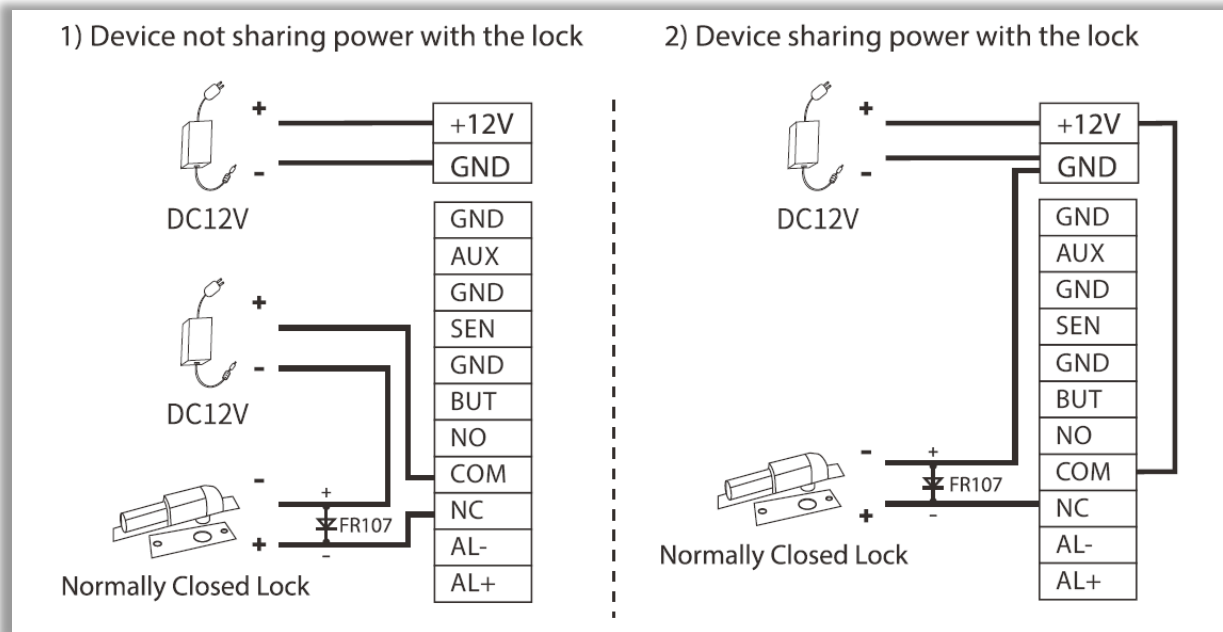

- The device supports normally opened and normally closed conditions.
- The normally closed lock is connected to **NC** and **COM** terminals.

### 1.5.3 Weigand Reader Connection

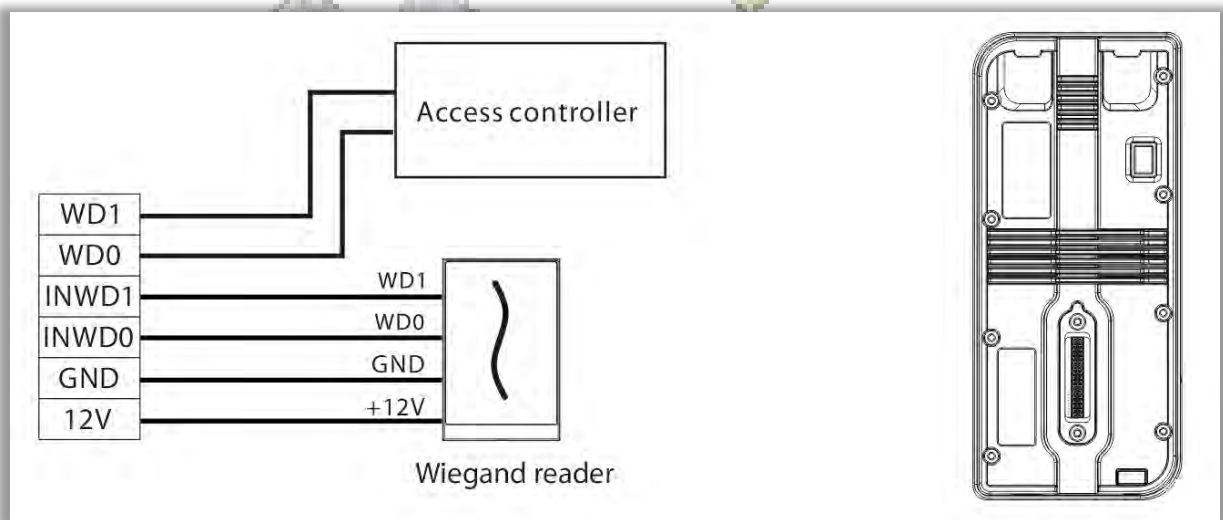

- Connect the **WD0** and **WD1** terminals to the SRB.
- Connect the **IWD0**, **IWD1**, **GND**, **+ 12V** terminals to the Wiegand Reader.

### 1.5.4 Ethernet Connection

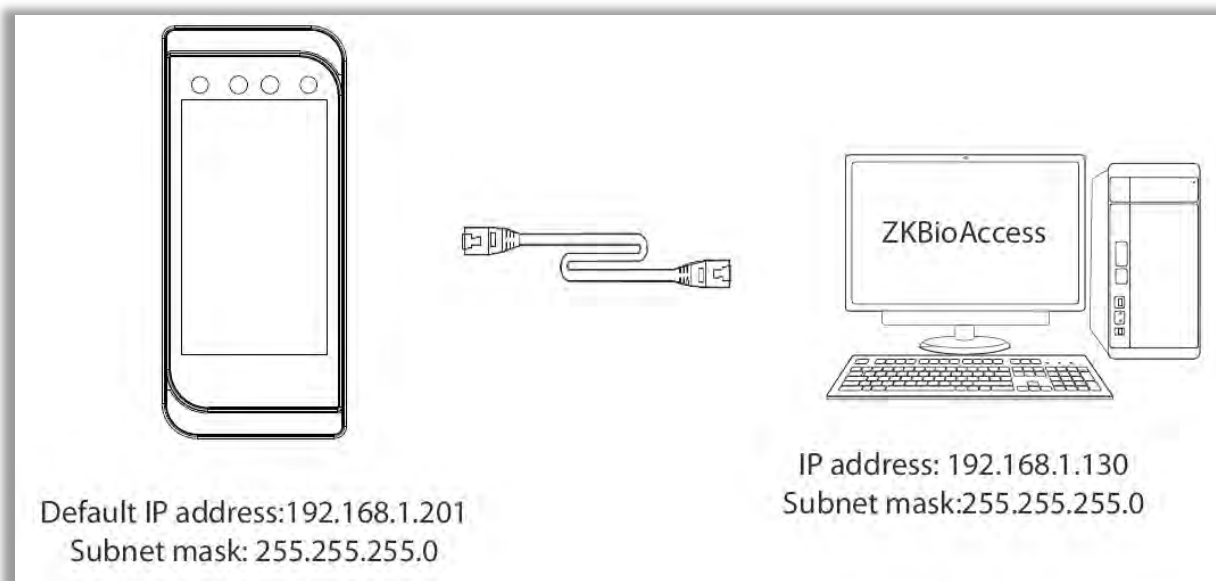

- Click **[COMM.]** > **[Ethernet]** > **[IP Address]**, input the IP address and click **[OK]**.

**Note:** In LAN, IP addresses of the server (PC) and the device must be in the same network segment when connecting to ZKBioAccess software.

### 1.5.5 Printer Connection

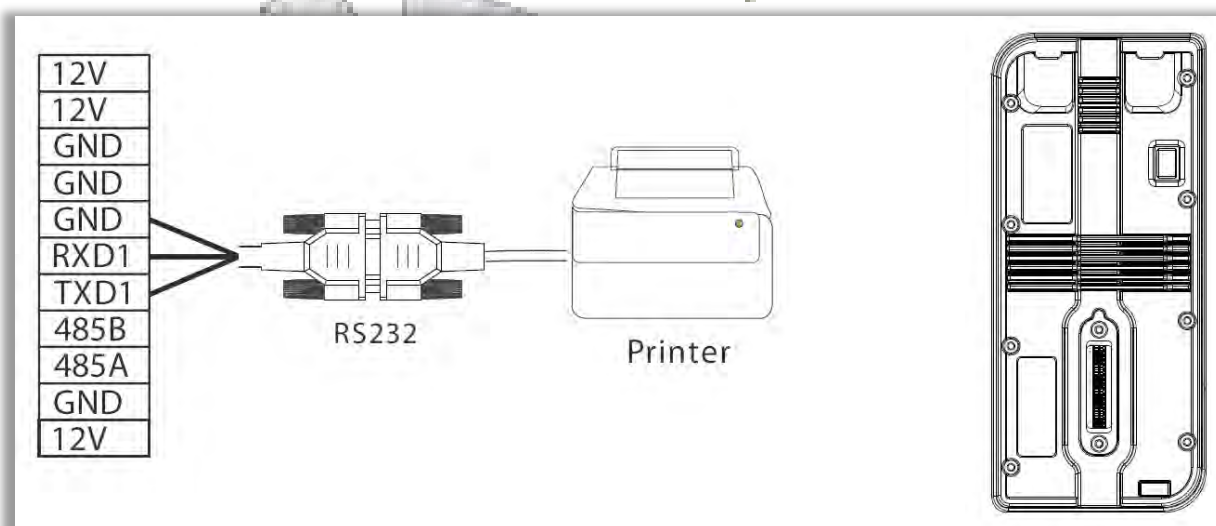

### 1.5.6 RS485 Connection

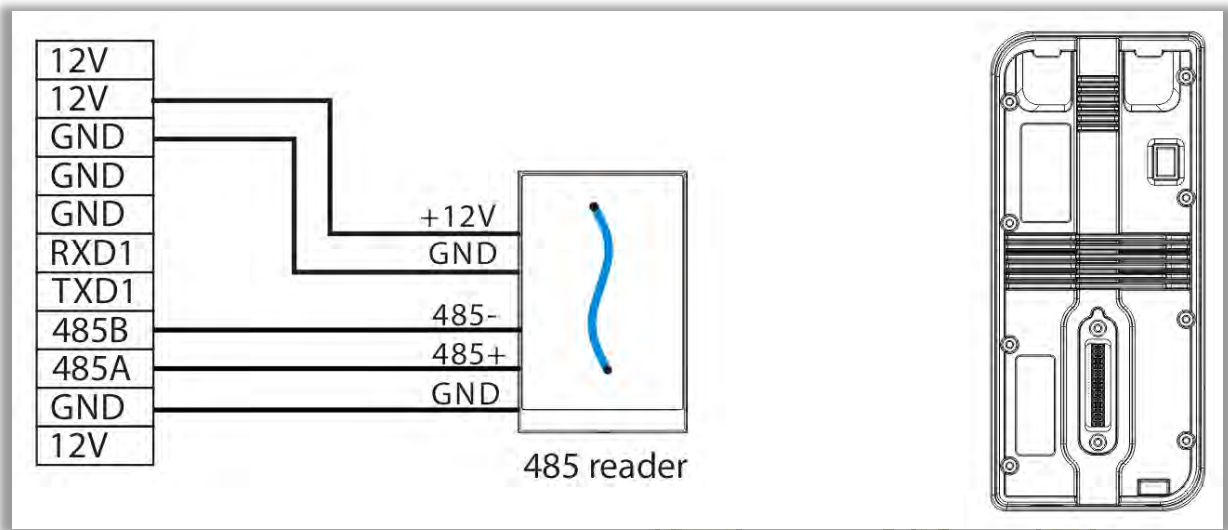

### 1.5.7 Power

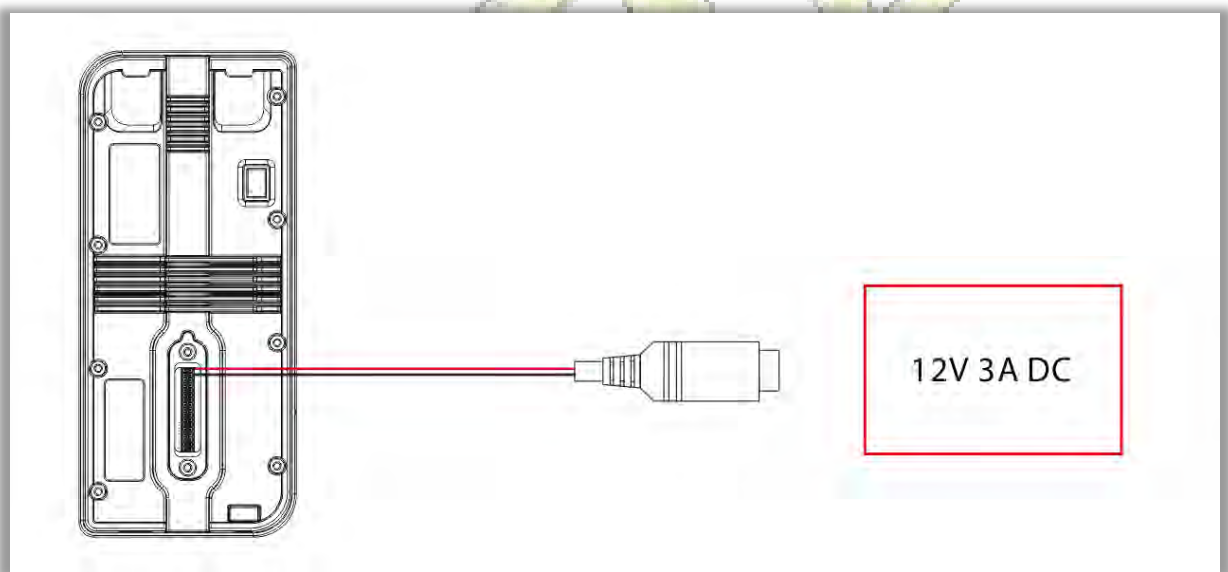

**Note:** To share the power with other devices, use a power supply with higher current ratings.

## 2 Operational Procedure

### 2.1 Face Registration

Try to keep the face in the center of the screen during registration. Please face the camera and stay still during face registration. The page looks like this:



#### **Cautions for registering a face:**

- When registering a face, maintain a distance of 40cm to 80cm between the device and the face.
- Be careful not to change the facial expression. (smiling face, drawn face, wink, etc.)
- If you do not follow the instructions on the screen, the face registration may take longer or may fail.
- Be careful not to cover the eyes or eyebrows.
- Do not wear hats, masks, sunglasses or eyeglasses.
- Be careful not to display two faces on the screen. Register one person at a time.
- It is recommended for a user wearing glasses to register both faces with and without glasses.

#### **Cautions for authenticating a face:**

- Ensure that the face appears inside the guideline displayed on the screen of the device.

- If glasses have been changed, authentication may fail. If the face without glasses has been registered, authenticate the face without glasses. If only the face with glasses has been registered, authenticate the face with the previously worn glasses again.
- If a part of the face is covered with a hat, a mask, an eye patch, or sunglasses authentication may fail. Do not cover the face; allow the device to recognize both the eyebrows and the face.

## 2.2 Correct and Incorrect Positions

Standing Position, Facial Expression and Standing Posture:

- **The recommended distance**

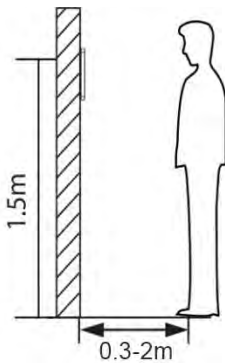

The distance between the device and a user whose height is within 1.4m-1.8m is recommended to be 0.3-2m. Users may slightly move forwards and backwards to improve the quality of facial images captured.

- **Facial expression and standing posture**



**Note:** During enrolment and verification, please remain natural facial expression and standing posture.



## 2.3 Verification Modes

### 2.3.1 Badge

- **1 : N Badge verification**

Please place the registered card on the card reading area.

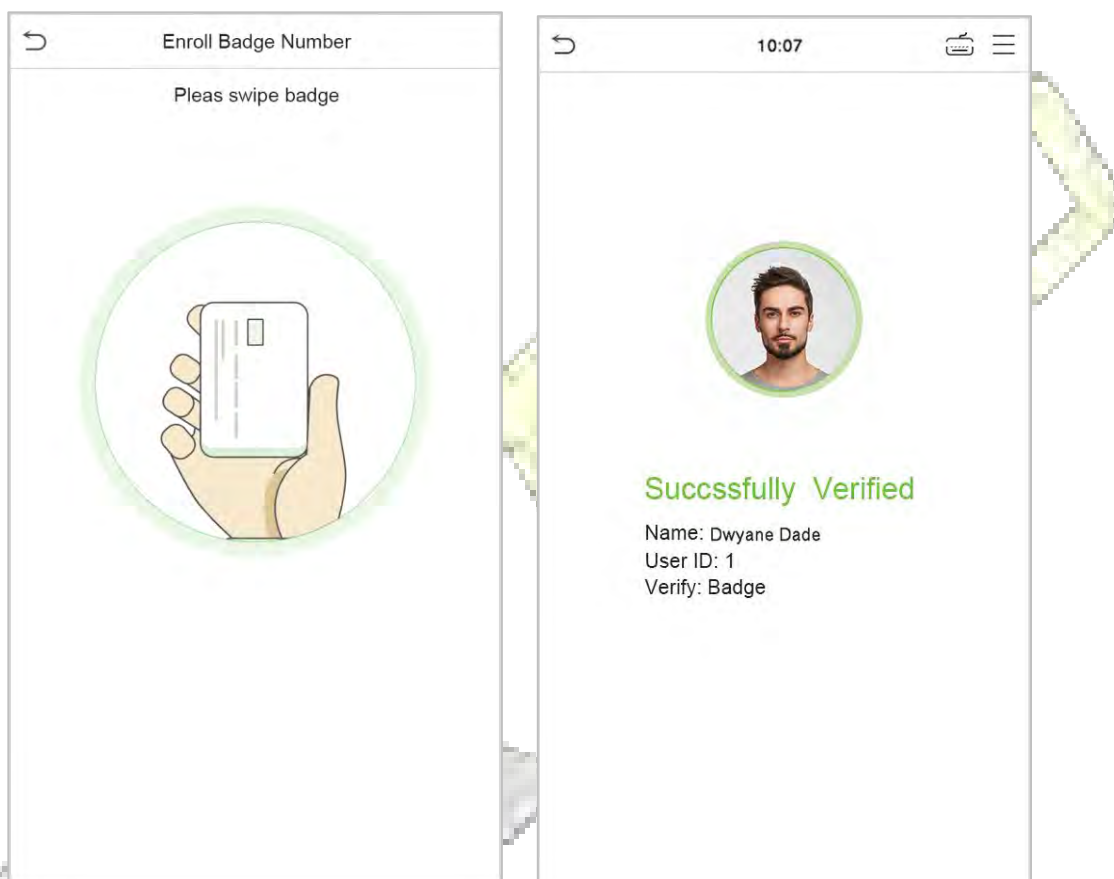

- **1:1 Badge verification**

Press  on the main screen to enter the 1:1 badge verification:

1. Enter your User ID and click **OK**.

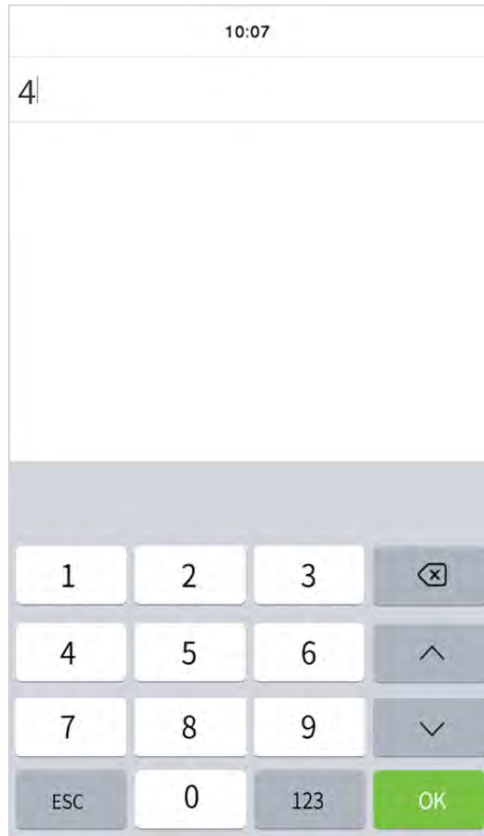

- 2. If the employee registers face and password in addition to badge, the following screen will appear. Select the  icon to enter badge verification mode.



**Verify successfully:**

**Verification failed:**

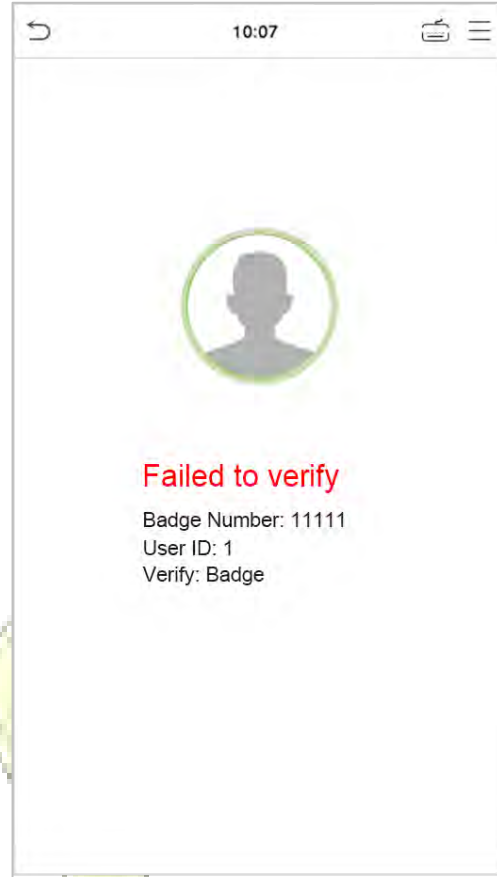
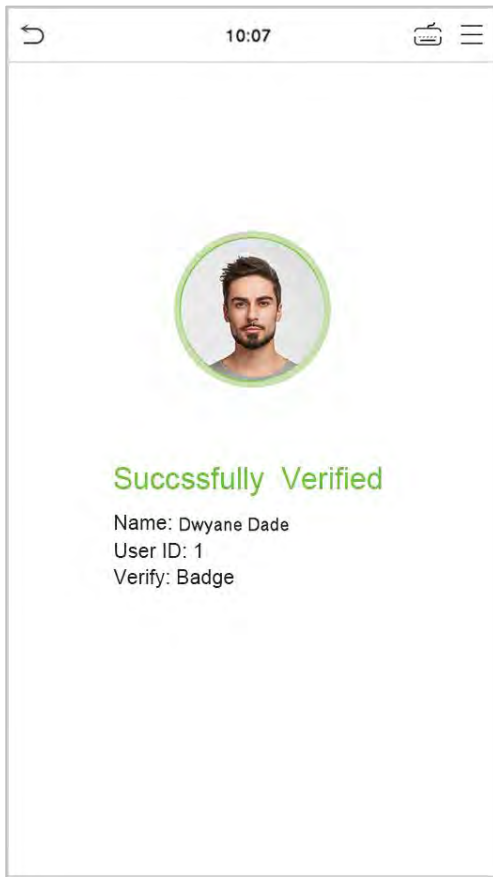

## 2.3.2 Face

- **1:N face verification**

Compare the acquired facial images with all face data registered in the device. The following is the pop-up prompt box of comparison result.

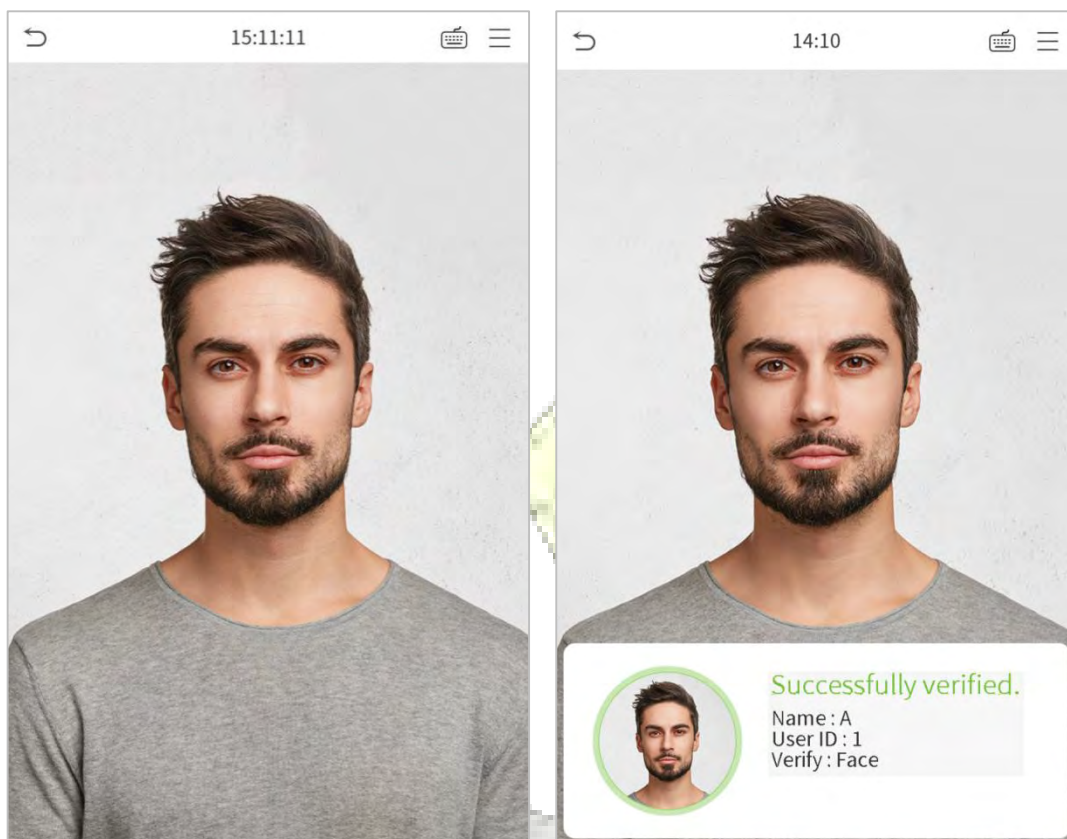

- **1:1 face verification**

Compare the face captured by the camera with the facial template related to the entered user ID.

Press  on the main interface and enter the 1:1 facial verification mode.

1. Enter the user ID and click **OK**.



If an employee registers password and badge, in addition to face, the following screen will appear. Select the

 icon to enter face verification mode.



After successful verification, the prompt box "successfully verified" will appear.

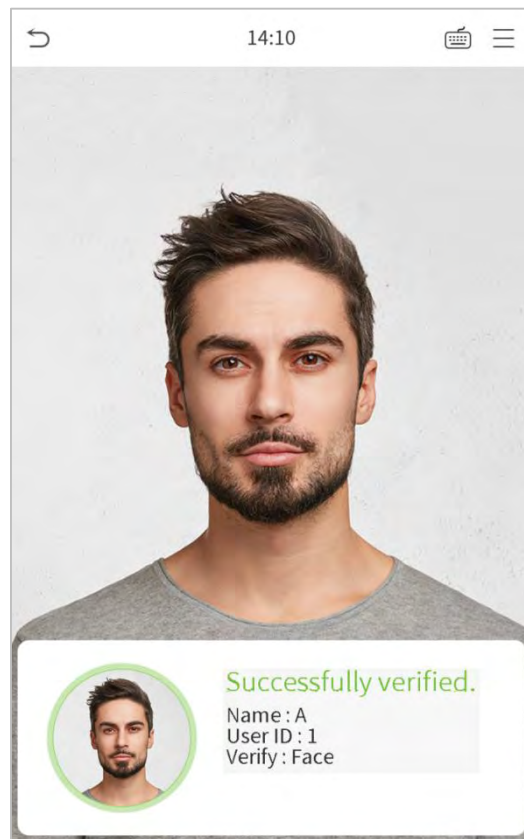

If the verification is failed, it will prompts "Please adjust your position!".

### 2.3.3 Password

Compare the entered password with the registered User ID and password.

Click the  button on the main screen to enter the 1:1 password verification mode.

1. Input the user ID and click **OK**.

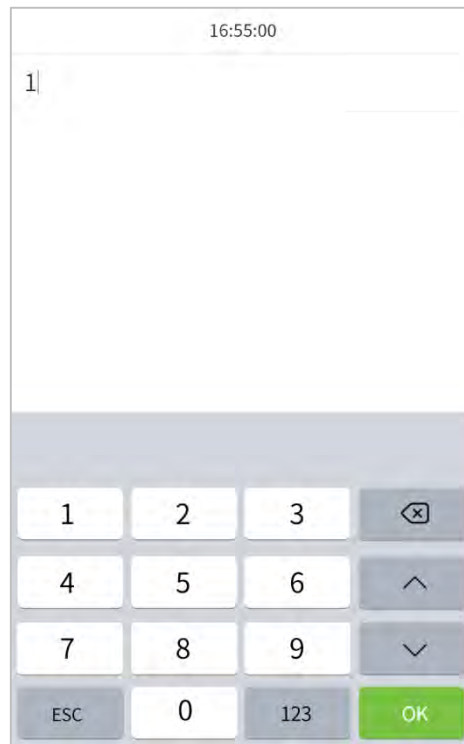

If an employee registers face and badge in addition to password, the following screen will appear. Select the  icon to enter password verification mode.



2. Input the password and click **OK**.

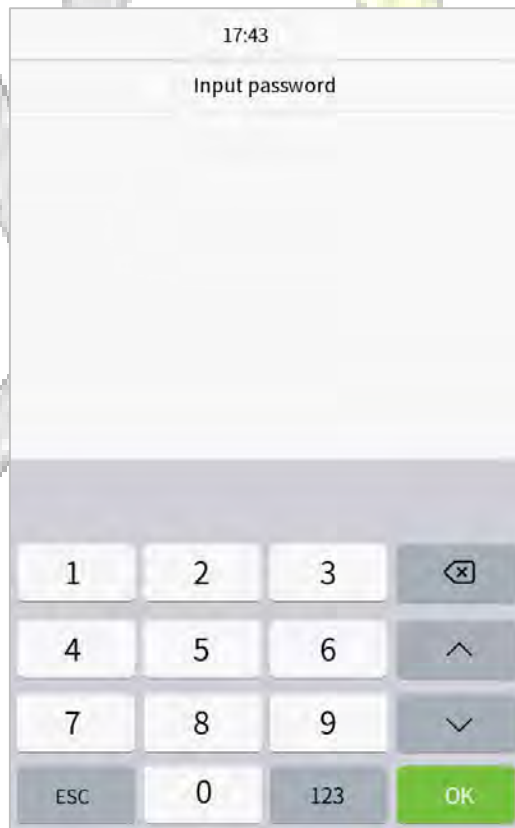



**Verification is successful.**

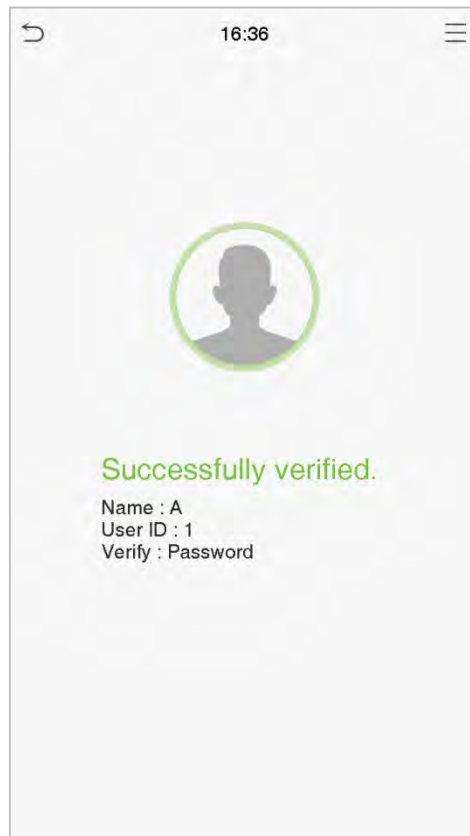

**Verification is failed.**

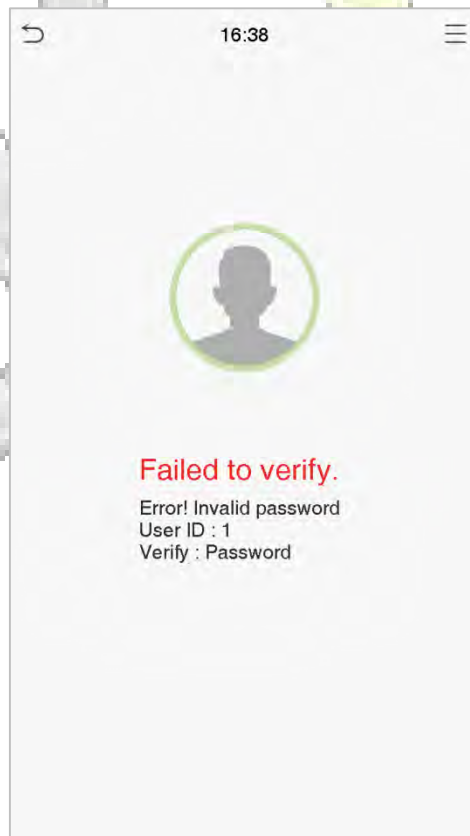

### 2.3.4 Combination

To increase security, this device offers the option of using multiple forms of verification methods.

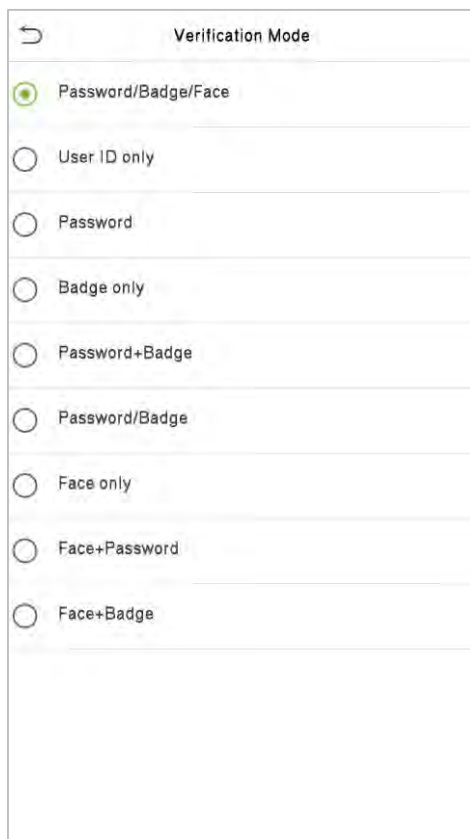

Verification Mode	
<input checked="" type="radio"/>	Password/Badge/Face
<input type="radio"/>	User ID only
<input type="radio"/>	Password
<input type="radio"/>	Badge only
<input type="radio"/>	Password+Badge
<input type="radio"/>	Password/Badge
<input type="radio"/>	Face only
<input type="radio"/>	Face+Password
<input type="radio"/>	Face+Badge

**Notes:**

- 1) "/" means "or", and "+" means "and".
- 2) You must register the required verification information before using the combination verification mode, otherwise the verification may fail. For example, if a user uses Face Registration but the verification mode is Face + Password, this user will never pass verification.

### 3 Main Menu

Press  on the initial interface to enter the main menu, as shown below:

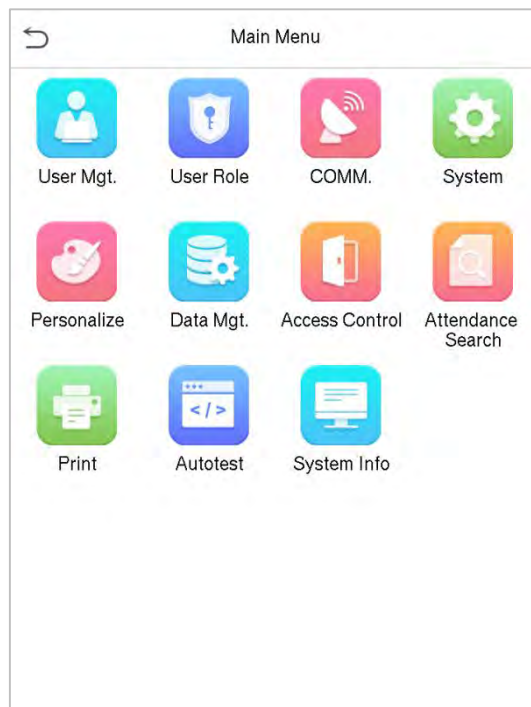

Items	Descriptions
<b>User Mgt.</b>	To add, edit, view, and delete basic information about a user.
<b>User Role</b>	To set the permission scope of the custom role and enroller, that is, the rights to operate the system.
<b>COMM.</b>	To set the relevant parameters of network, serial port, PC connection, WIFI, cloud server and Wiegand.
<b>System</b>	To set parameters related to the system, including date & time, access logs setting, face parameters, reset to factory.
<b>Personalize</b>	To customize settings of interface display, voice, bell, punch states, shortcut keys mappings.
<b>Data Mgt.</b>	To delete all relevant data in the device.
<b>Access Control</b>	To set the parameters of the lock and the relevant access control device.
<b>Attendance Search</b>	Query the specified event logs, check attendance photos and blacklist photos.
<b>Print</b>	To set printing information and functions (if printer is connected to the device).
<b>Autotest</b>	To automatically test whether each module functions properly, including the LCD, voice, camera and real-time clock.
<b>System Info</b>	To view data capacity, device and firmware information of the current device.

## 4 User Management

### 4.1 Adding Users

Click **User Mgt.** on the main menu.



Click **New User**.

- **Register a User ID and Name**

Enter the user ID and name.

 A screenshot of the "New User" registration form. The form has a back arrow at the top left and the title "New User". It contains several input fields:
 

User ID	3
Name	
User Role	Normal User
Face	0
Badge Number	
Password	
User Photo	0
Access Control Role	

**Notes:**

- 1) A user name may contain 17 characters.
- 2) The user ID may contain 1-9 digits by default.
- 3) During the initial registration, you can modify your ID, which cannot be modified after registration.
- 4) If a message "Duplicated ID" pops up, you must choose another ID.

- **Setting the User Role**

There are two types of user accounts: the **Normal user** and the **Super Admin**. If there is already a registered administrator, the normal users have no rights to manage the system and may only access authentication verifications. The administrator owns all management privileges. If a custom role is set, you can also select **User Defined Role** permissions for the user.

Click **User Role** to select Normal User or Super Admin.



**Note:** If the selected user role is the Super Admin, the user must pass the identity authentication to access the main menu. The authentication is based on the authentication method(s) that the super administrator has registered. Please refer to *2.3 Verification Modes*.

- **Register badge number**

Click **Badge number** to enter the card registration page, and place the card in the card reading area. The registration interface is as follows:

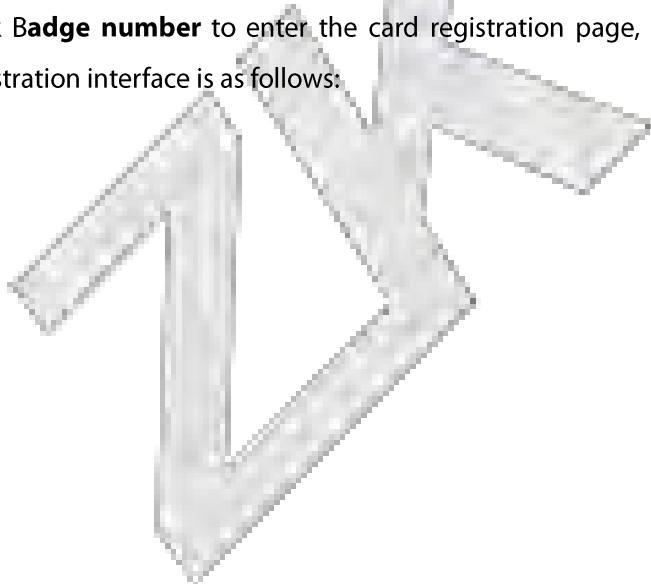



- **Register face**

Click **Face** to enter the face registration page. Please face the camera and stay still during face registration. The registration interface is as follows:



- **Register password**

Click **Password** to enter the password registration page. Enter a password and re-enter it. Click **OK**. If the two entered passwords are different, the prompt "Password not match" will appear.



**Note:** The password may contain one to eight digits by default.

- **Register user photo**

When a user registered with a photo passes the authentication, the registered photo will be displayed.

Click **User Photo**, click the camera icon to take a photo. The system will return to the New User interface after taking a photo.

**Note:** While registering a face, the system will automatically capture a picture as the user photo. If you do not want to register a user photo, the system will automatically set the picture captured as the default photo.

- **Access Control Role**

User access control sets the door unlocking rights of each person, including the group that the user belongs to, the verification mode and whether to apply group time period.

Click **Access Control Role** > **Access Group**, assign the registered users to different groups for better management. New users belong to Group 1 by default, and can be reassigned to other groups. The device supports up to 99 access control groups.

## 4.2 Search for Users

Click the search bar on the user list and enter the retrieval keyword (The keyword may be an ID, surname or full name.). The system will search for the users related to the information.

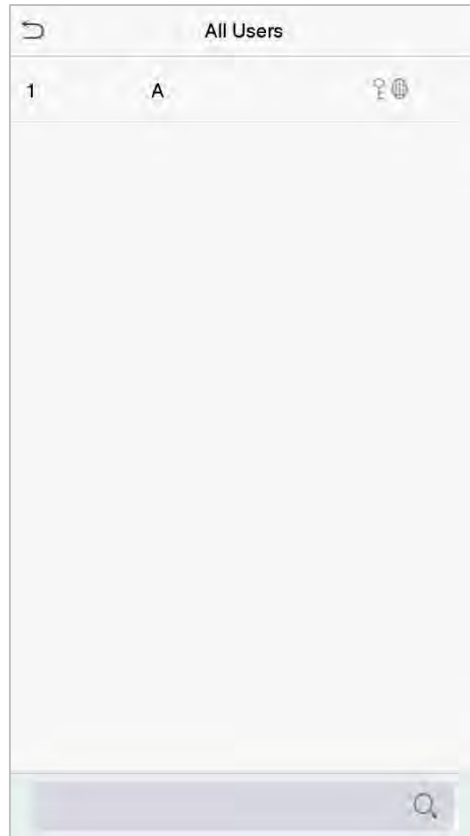

### 4.3 Edit Users

Choose a user from the list and click **Edit** to enter the edit user interface:

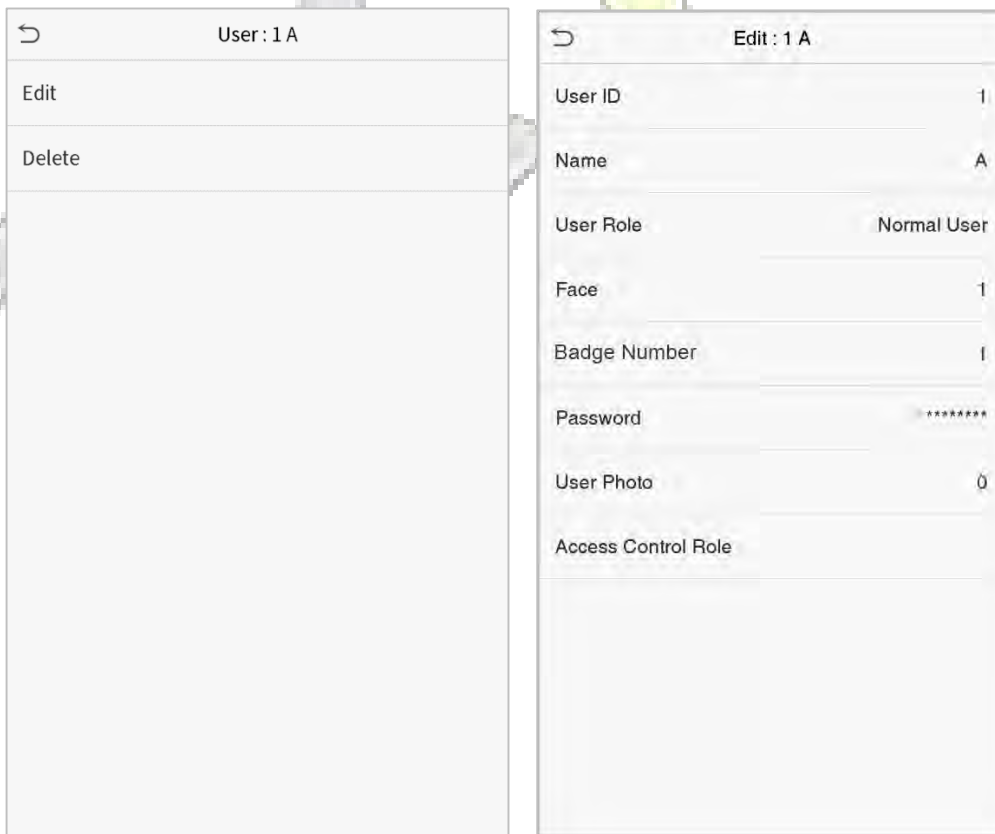



**Note:** The operation of editing a user is the same as that of adding a user, except that the user ID cannot be modified when editing a user. Operation method refers to "[4.1 Adding Users](#)".

## 4.4 Deleting Users

Choose a user from the list and click **Delete** to enter the delete user interface. Select the user information to be deleted and click **OK**.

**Note:** If you select **Delete User**, all information of the user will be deleted.

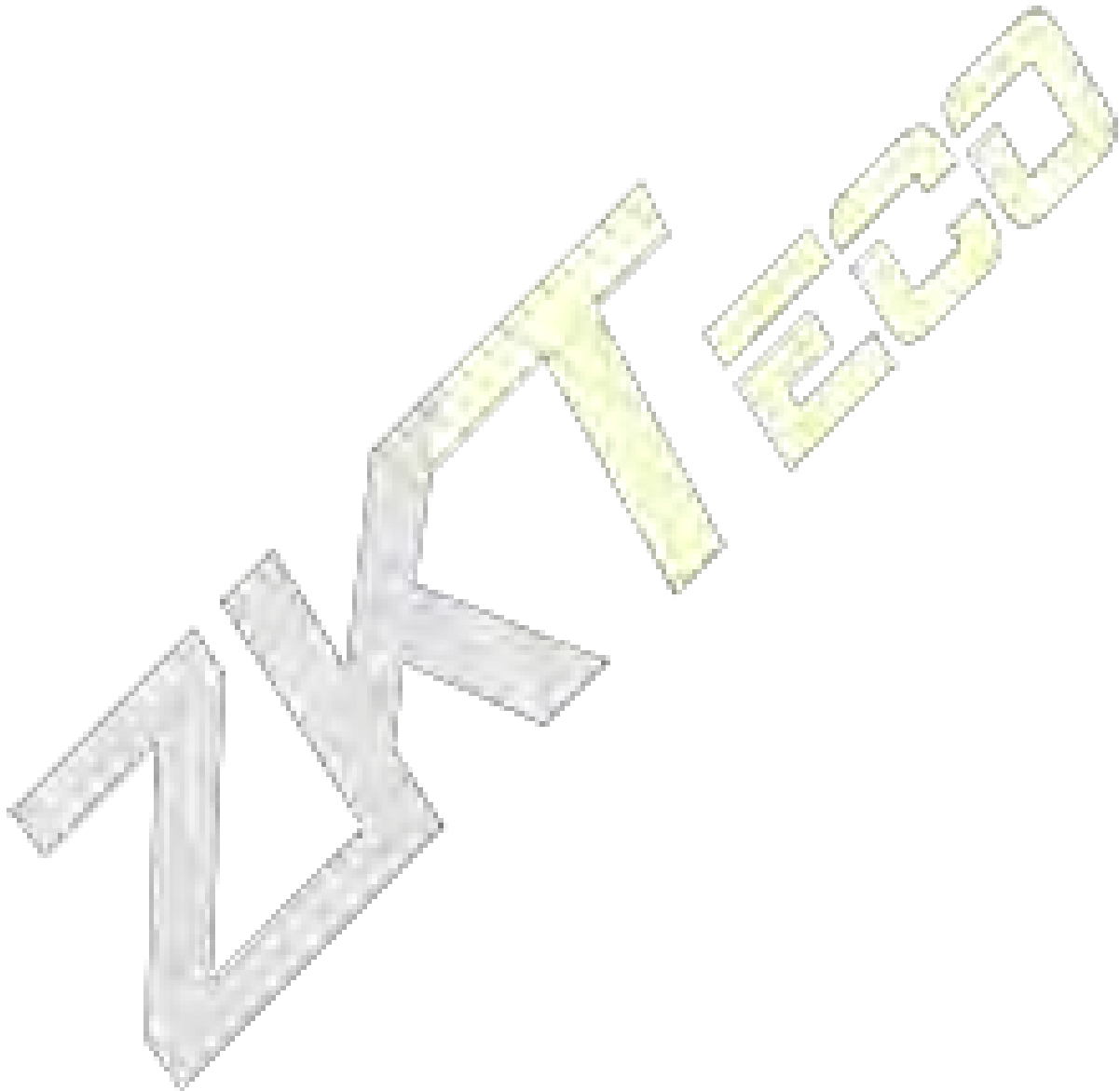

## 5 User Role

If you need to assign some specific permissions to certain users, you may edit the “User Defined Role” under the **User Role** menu.

You may set the permission scope of the custom role (up to 3 roles) and enroller, that is, the permission scope of the operation menu.

Click **User Role** on the main menu interface.

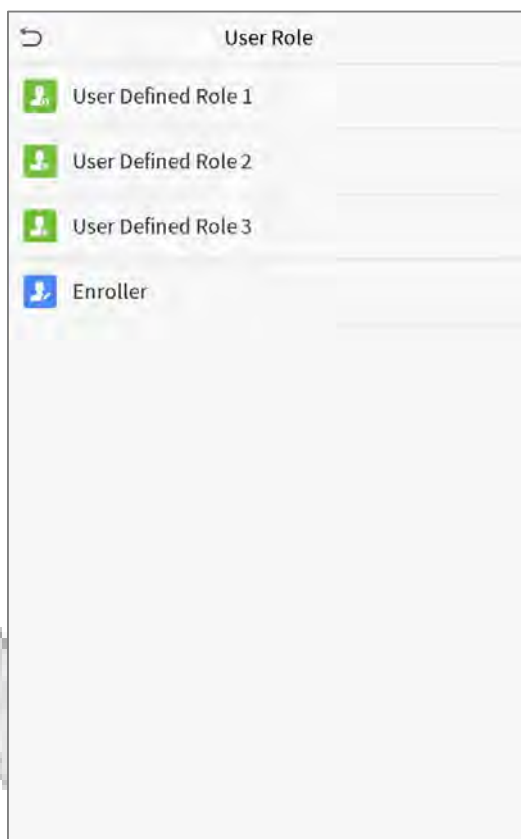

1. Click any item to set a defined role. Click the row of **Enable Defined Role** to enable this defined role. Click **Name** and enter the name of the role.

← User Defined Role 1

Enable Defined Role

Name User Defined Role 1

Define User Role

2. Click **Define User Role** to assign the privileges to the role. The privilege assignment is completed. Click Return.

← User Defined Role 1

<input type="checkbox"/> User Mgt.	<input checked="" type="checkbox"/> New User
<input checked="" type="checkbox"/> Comm.	<input checked="" type="checkbox"/> All Users
<input checked="" type="checkbox"/> System	<input checked="" type="checkbox"/> Display Style
<input type="checkbox"/> Personalize	
<input type="checkbox"/> Data Mgt.	
<input checked="" type="checkbox"/> Access Control	
<input type="checkbox"/> Attendance Search	
<input type="checkbox"/> Print	
<input type="checkbox"/> Autotest	
<input type="checkbox"/> System Info	

**Note:** During privilege assignment, the main menu is on the left and its sub-menus are on the right. You only need to select the features in sub-menus. If the device has a role enabled, you may assign the roles you set to users by clicking User Mgt. > New User > User Role.



If no super administrator is registered, the device will prompt "Please enroll super admin first!" after clicking the enable bar.

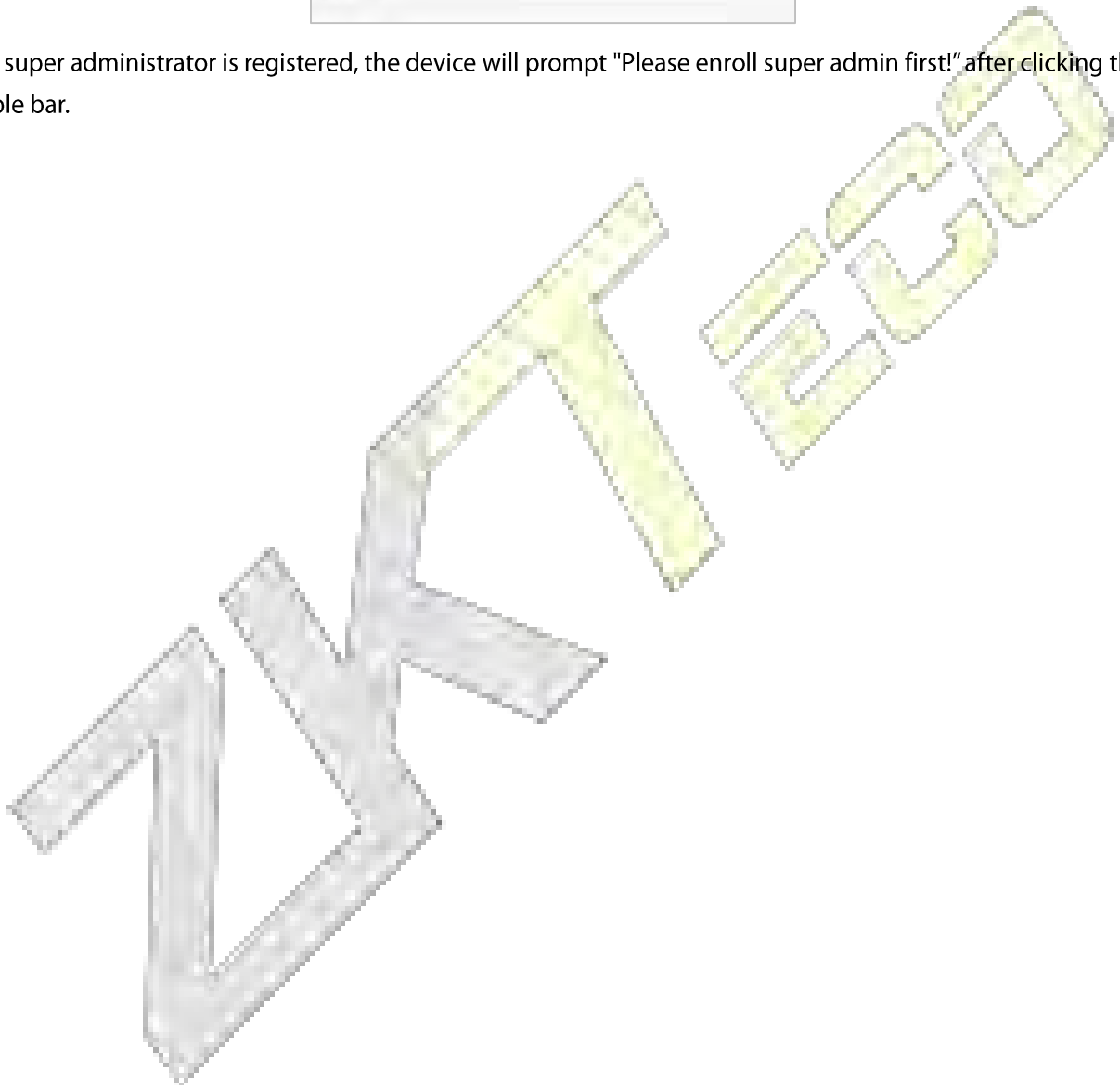

## 6 Communication Settings

Set parameters of the network, PC connection, WIFI, cloud server and Wiegand.

Tap **COMM.** on the main menu.

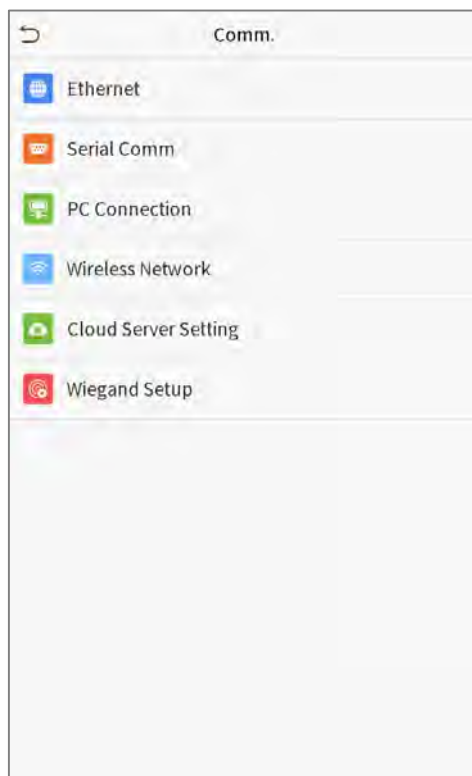

### 6.1 Network Settings

When the device needs to communicate with a PC over the Ethernet, you need to configure network settings and ensure that the device and the PC are connecting to the same network segment.

Click **Ethernet** on the Comm. Settings interface.

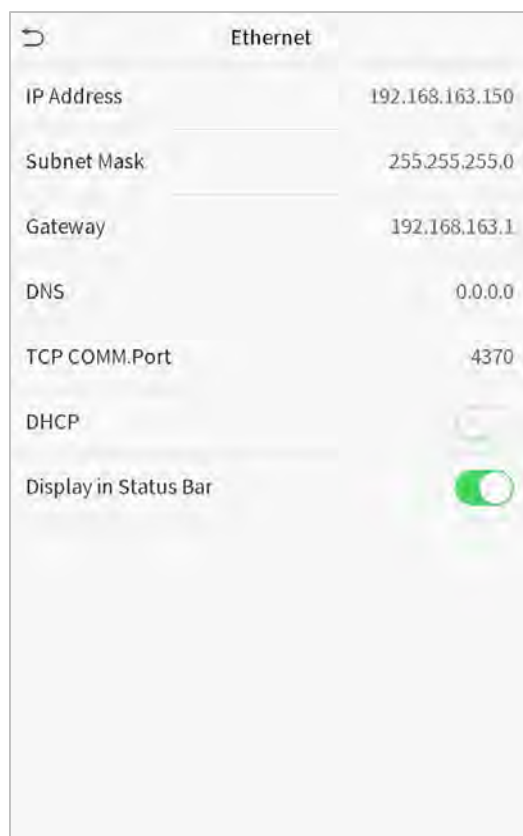

Item	Descriptions
<b>IP Address</b>	The factory default value is 192.168.1.201. Please adjust them according to the actual network situation.
<b>Subnet Mask</b>	The factory default value is 255.255.255.0. Please adjust them according to the actual network situation.
<b>Gateway</b>	The factory default address is 0.0.0.0. Please adjust them according to the actual network situation.
<b>DNS</b>	The factory default address is 0.0.0.0. Please adjust them according to the actual network situation.
<b>TCP COMM. Port</b>	The factory default value is 4370. Please adjust them according to the actual network situation.
<b>DHCP</b>	Dynamic Host Configuration Protocol, which is to dynamically allocate IP addresses for clients via server.
<b>Display in Status Bar</b>	To set whether to display the network icon on the status bar.

## 6.2 Serial Port Settings

To establish communication with the device through a serial port (RS232/RS485), you need to configure **Serial Comm.**

Click **Serial Comm.** on the Comm. Settings interface.

Serial Comm	
Serial port	RS232(PC)
Baudrate	115200

Item	Descriptions
<b>Serial port</b>	Select whether to use RS232 or RS485 for communication.
<b>Baudrate</b>	The rate of the communication with PC; there are four options of baud: 115200 (default), 57600, 38400 and 19200.

## 6.3 PC Connection

To improve the security of data, please set a Comm Key for communication between the device and the PC.

If a Comm Key is set, this connection password must be entered before the device can be connected to the PC software.

Click **PC Connection** on the Comm. Settings interface.

PC Connection	
Comm Key	0
Device ID	1

Item	Descriptions
<b>Comm Key</b>	Comm Key: The default password is 0, which can be changed. The Comm Key may contain 1-6 digits.
<b>Device ID</b>	Identity number of the device, which ranges between 1 and 254. If the communication method is RS232/RS485, you need to input this device ID in the software communication interface.

## 6.4 WIFI Setting

Click **Wireless Network** on the Comm. Settings interface.



When WIFI is enabled, tap the searched network. Enter the password, and tap Connect to WIFI (OK). The connection succeeds, with icon  displayed on the status bar.

### ➤ Adding WIFI Network

If the desired Wi-Fi network is not in on the list, you can add the Wi-Fi network manually.

Click  and Add WIFI Network. Enter the parameters of the Wi-Fi network. (The added network must exist.)





After adding, find the newly added Wi-Fi network in list and connect to it in the above way.

➤ **Advanced**

This is used to set Wi-Fi network parameters.



Item	Description
<b>DHCP</b>	Short for Dynamic Host Configuration Protocol, which involves allocating dynamic IP addresses to network clients.
<b>IP Address</b>	IP address of the Wi-Fi network.
<b>Subnet Mask</b>	Subnet mask of the Wi-Fi network.
<b>Gateway</b>	Gateway address of the Wi-Fi network.

## 6.5 Cloud Server Setting

This represents settings used for connecting with the ADMS server.

Click **Cloud Server Setting** on the Comm. Settings interface.

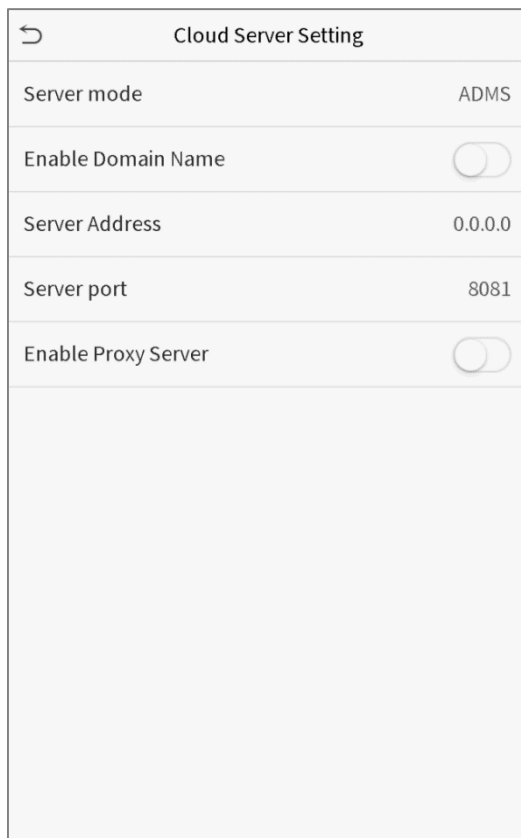

Cloud Server Setting	
Server mode	ADMS
Enable Domain Name	<input type="checkbox"/>
Server Address	0.0.0.0
Server port	8081
Enable Proxy Server	<input type="checkbox"/>

Item	Description
<b>Enable Domain Name</b>	When this function is enabled, the domain name mode "http://..." will be used, such as http://www.XYZ.com, while "XYZ" denotes the domain name when this mode is turned ON.
<b>Disable Domain Name</b>	IP address of the ADMS server.
	Port used by the ADMS server.
<b>Enable Proxy Server</b>	When you choose to enable the proxy, you need to set the IP address and port number of the proxy server.

## 6.6 Wiegand Setup

To set the Wiegand input and output parameters.

Click **Wiegand Setup** on the Comm. Settings interface.

Wiegand Setup	
Wiegand Input	
Wiegand Output	

### ➤ Wiegand input

Wiegand Options	
Wiegand Format	
Wiegand Bits	26
Pulse Width(us)	100
Pulse Interval(us)	1000
ID Type	Badge Number

Item	Descriptions
<b>Wiegand Format</b>	Values range from 26 bits, 34 bits, 36 bits, 37 bits, and 50 bits.
<b>Wiegand Bits</b>	Number of bits of Wiegand data.
<b>Pulse Width(us)</b>	The value of the pulse width sent by Wiegand is 100 microseconds by default, which can be adjusted within the range of 20 to 100 microseconds.
<b>Pulse Interval(us)</b>	The default value is 1000 microseconds, which can be adjusted within the range of 200 to 20000 microseconds.

---

<b>ID Type</b>	Select between User ID and badge number.
----------------	--

---

**Definitions of various common Wiegand formats:**

<b>Wiegand Format</b>	<b>Definitions</b>
Wiegand26	<p>ECCCCCCCCCCCCCCCCCCCCCO</p> <p>Consists of 26 bits of binary code. The 1<sup>st</sup> bit is the even parity bit of the 2<sup>nd</sup> to 13<sup>th</sup> bits, while the 26<sup>th</sup> bit is the odd parity bit of the 14<sup>th</sup> to 25<sup>th</sup> bits. The 2<sup>nd</sup> to 25<sup>th</sup> bits are the card numbers.</p>
Wiegand26a	<p>ESSSSSSSCCCCCCCCCCCCCCO</p> <p>Consists of 26 bits of binary code. The 1<sup>st</sup> bit is the even parity bit of the 2<sup>nd</sup> to 13<sup>th</sup> bits, while the 26<sup>th</sup> bit is the odd parity bit of the 14<sup>th</sup> to 25<sup>th</sup> bits. The 2<sup>nd</sup> to 9<sup>th</sup> bits are the site codes, while the 10<sup>th</sup> to 25<sup>th</sup> bits are the card numbers.</p>
Wiegand34	<p>ECCCCCCCCCCCCCCCCCCCCCCCCCO</p> <p>Consists of 34 bits of binary code. The 1<sup>st</sup> bit is the even parity bit of the 2<sup>nd</sup> to 17<sup>th</sup> bits, while the 34<sup>th</sup> bit is the odd parity bit of the 18<sup>th</sup> to 33<sup>rd</sup> bits. The 2<sup>nd</sup> to 25<sup>th</sup> bits are the card numbers.</p>
Wiegand34a	<p>ESSSSSSSCCCCCCCCCCCCCCCCCCO</p> <p>Consists of 34 bits of binary code. The 1<sup>st</sup> bit is the even parity bit of the 2<sup>nd</sup> to 17<sup>th</sup> bits, while the 34<sup>th</sup> bit is the odd parity bit of the 18<sup>th</sup> to 33<sup>rd</sup> bits. The 2<sup>nd</sup> to 9<sup>th</sup> bits are the site codes, while the 10<sup>th</sup> to 25<sup>th</sup> bits are the card numbers.</p>
Wiegand36	<p>OFFFFFFFFFCCCCCCCCCCCCMME</p> <p>Consists of 36 bits of binary code. The 1<sup>st</sup> bit is the odd parity bit of the 2<sup>nd</sup> to 18<sup>th</sup> bits, while the 36<sup>th</sup> bit is the even parity bit of the 19<sup>th</sup> to 35<sup>th</sup> bits. The 2<sup>nd</sup> to 17<sup>th</sup> bits are the device codes. The 18<sup>th</sup> to 33<sup>rd</sup> bits are the card numbers, and the 34<sup>th</sup> to 35<sup>th</sup> bits are the manufacturer codes.</p>
Wiegand36a	<p>EFFFFFFFFFCCCCCCCCCCCCCO</p> <p>Consists of 36 bits of binary code. The 1<sup>st</sup> bit is the even parity bit of the 2<sup>nd</sup> to 18<sup>th</sup> bits, while the 36<sup>th</sup> bit is the odd parity bit of the 19<sup>th</sup> to 35<sup>th</sup> bits. The 2<sup>nd</sup> to 19<sup>th</sup> bits are the device codes, and the 20<sup>th</sup> to 35<sup>th</sup> bits are the card numbers.</p>
Wiegand37	<p>OMMMMSSSSSSSSSCCCCCCCCCCCCCCE</p> <p>Consists of 37 bits of binary code. The 1<sup>st</sup> bit is the odd parity bit of the 2<sup>nd</sup> to 18<sup>th</sup> bits, while the 37<sup>th</sup> bit is the even parity bit of the 19<sup>th</sup> to 36<sup>th</sup> bits. The 2<sup>nd</sup> to 4<sup>th</sup> bits are the manufacturer codes. The 5<sup>th</sup> to 16<sup>th</sup> bits are the site codes, and the 21<sup>st</sup> to 36<sup>th</sup> bits are the card numbers.</p>
Wiegand37a	<p>EMMMFFFFFFFSSSSSCCCCCCCCCCCCCCO</p>

---



<b>bits</b>	digits in the Wiegand format
<b>Failed ID</b>	If the verification is failed, the system will send the failed ID to the device and replace the card number or personnel ID with the new ones.
<b>Site Code</b>	It is similar to the device ID. The difference is that a site code can be set manually, and is repeatable in a different device. The valid value ranges from 0 to 256 by default.
<b>Pulse Width(us)</b>	The time width represents the changes of the quantity of electric charge with high-frequency capacitance regularly within a specified time.
<b>Pulse Interval(us)</b>	The time interval between pulses.
<b>ID Type</b>	Select between User ID and badge number.



## 7 System Settings

Set related system parameters to optimize the performance of the device.

Click **System** on the main menu interface.

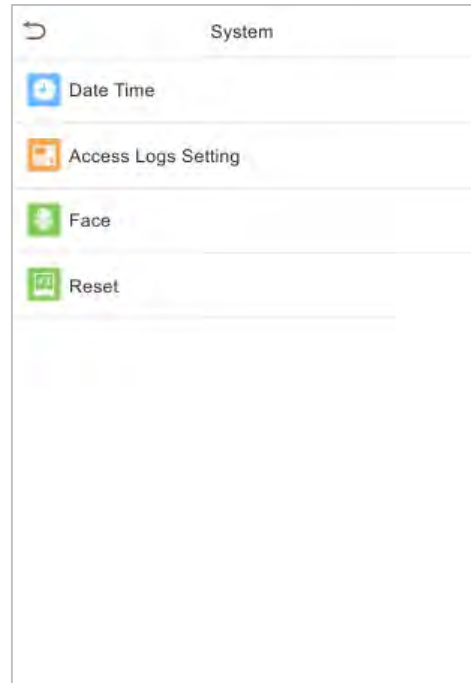

## 7.1 Date and Time

Click **Date Time** on the System interface.

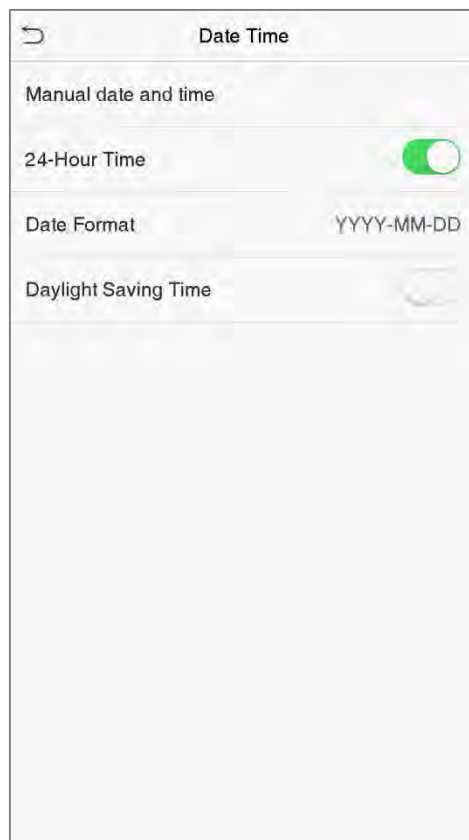

1. You can manually set date and time and click Confirm to save.
2. Click 24-Hour Time to enable or disable this format and select the date format.
3. Click Daylight Saving Time to enable or disable the function. If enabled, select a daylight saving mode and set the switch time.



Daylight Saving Setup	
Start Month	1
Start Week	1
Start Day	Sunday
Start Time	00:00
End Month	1
End Week	1
End Day	Sunday
End Time	00:00

Daylight Saving Setup	
Start Date	00-00
Start Time	00:00
End Date	00-00
End Time	00:00

Week mode

Date mode

When restoring the factory settings, the time (24-hour) and date format (YYYY-MM-DD) can be restored, but the device date and time cannot be restored.

**Note:** For example, the user sets the time of the device (18:35 on March 15, 2019) to 18:30 on January 1, 2020. After restoring the factory settings, the time of the equipment will remain 18:30 on January 1, 2020.

## 7.2 Access Logs Setting

Click **Access Logs Setting** on the System interface.

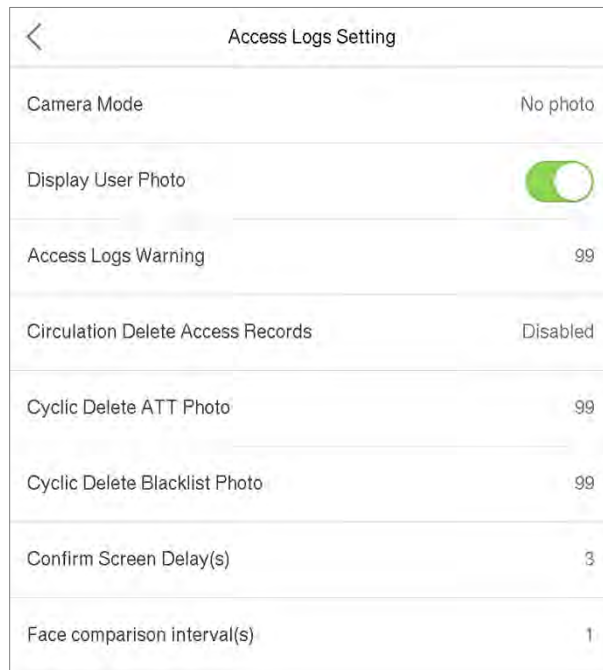

Item	Description
<b>Camera Mode</b>	Whether to capture and save the current snapshot image during verification. There are 5 modes: <b>No Photo:</b> No photo is taken during user verification. <b>Take photo, no save:</b> Photo is taken but is not saved during verification. <b>Take photo and save:</b> Photo is taken and saved during verification. <b>Save on successful verification:</b> Photo is taken and saved for each successful verification. <b>Save on failed verification:</b> Photo is taken and saved during each failed verification.
<b>Display User Photo</b>	Whether to display the user photo when the user passes verification.
<b>Access Logs Warning</b>	When the remaining record space reaches a set value, the device will automatically display a remaining record memory warning. Users may disable the function or set a valid value between 1 and 9999.
<b>Circulation Delete Access Records</b>	When access records have reached full capacity, the device will automatically delete a set value of old access records. Users may disable the function or set a valid value between 1 and 999.

<b>Cyclic Delete ATT Photo</b>	When attendance photos have reached full capacity, the device will automatically delete a set value of old attendance photos. Users may disable the function or set a valid value between 1 and 99.
<b>Cyclic Delete Blacklist Photo</b>	When blacklisted photos have reached full capacity, the device will automatically delete a set value of old blacklisted photos. Users may disable the function or set a valid value between 1 and 99.
<b>Confirm Screen Delay(s)</b>	The length of time that the message of successful verification displays. Valid value: 1~9 seconds.
<b>Face comparison interval (s)</b>	To set the facial template matching time interval as needed. Valid value: 0~9 seconds.

### 7.3 Face Parameters

Click **Face** on the System interface.

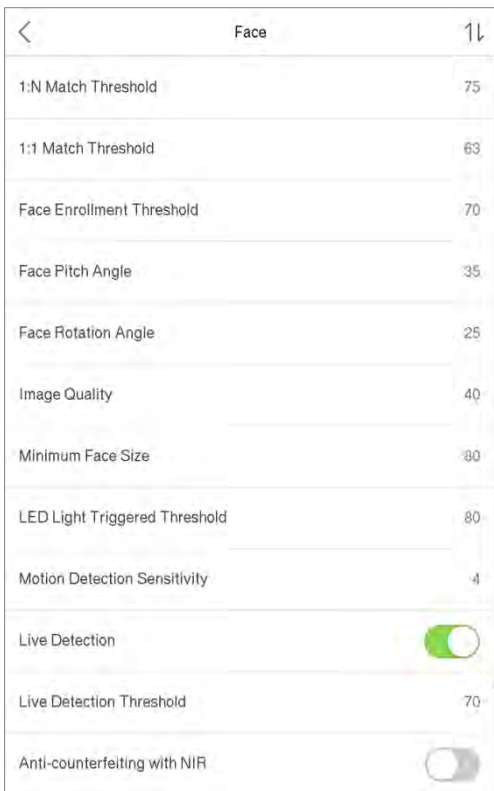

	FRR	FAR	Recommended matching thresholds	
			1:N	1:1
High	Low		85	80
Medium	Medium		82	75
Low	High		80	70

Item	Description
<b>1:N Match Threshold</b>	<p>Under 1:N verification mode, the verification will only be successful when the similarity between the acquired facial image and all registered facial templates is greater than the set value.</p> <p>The valid value ranges from 65 to 120. The higher the thresholds, the lower the misjudgment rate, the higher the rejection rate, and vice versa. The default value</p>

	of 75 is recommended.
<b>1:1 Match Threshold</b>	<p>Under 1:1 verification mode, the verification will only be successful when the similarity between the acquired facial image and the facial templates enrolled in the device is greater than the set value.</p> <p>The valid value ranges from 55 to 120. The higher the thresholds, the lower the misjudgment rate, the higher the rejection rate, and vice versa. The default value of 63 is recommended.</p>
<b>Face Enrollment Threshold</b>	<p>During face enrollment, 1:N comparison is used to determine whether the user has already registered before.</p> <p>When the similarity between the acquired facial image and all registered facial templates is greater than this threshold, it indicates that the face has already been registered.</p>
<b>Face Pitch Angle</b>	<p>The pitch angle tolerance of a face for facial registration and comparison.</p> <p>If a face's pitch angle exceeds this set value, it will be filtered by the algorithm, i.e. ignored by the terminal thus no registration and comparison interface will be triggered.</p>
<b>Face Rotation Angle</b>	<p>The rotation angle tolerance of a face for facial template registration and comparison.</p> <p>If a face's rotation angle exceeds this set value, it will be filtered by the algorithm, i.e. ignored by the terminal thus no registration and comparison interface will be triggered.</p>
<b>Image Quality</b>	Image quality for facial registration and comparison. The higher the value, the clearer the image requires.
<b>Minimum Face Size</b>	<p>Required for facial registration and comparison.</p> <p>If an object's size is smaller than this set value, the object will be filtered and not recognized as a face.</p> <p>This value can be understood as the face comparison distance. The farther the person is, the smaller the face is, and the smaller the face pixel will be obtained by the algorithm. Therefore, adjusting this parameter can adjust the furthest comparison distance of faces. When the value is 0, the face comparison distance is not limited.</p>
<b>LED Light Triggered Threshold</b>	This value controls the on and off of the LED light. The larger the value, the more frequently the LED light will be turned on.
<b>Motion Detection Sensitivity</b>	A measurement of the amount of change in a camera's field of view that qualifies as potential motion detection that wakes up the terminal from standby to the comparison interface. The larger the value, the more sensitive the system would be, i.e. if a larger value is set, the comparison interface is much easier and frequently triggered.

<b>Live Detection</b>	Detecting a spoof attempt by determining whether the source of a biometric sample is a live human being or a fake representation using visible light images.
<b>Live Detection Threshold</b>	Helping to judge whether the visible image comes from an alive body. The larger the value, the better the visible light anti-spoofing performance.
<b>Anti-counterfeiting with NIR</b>	Using near-infrared spectra imaging to identify and prevent fake photos and videos attack.
<b>WDR</b>	Wide Dynamic Range (WDR), which balances light and extends image visibility for surveillance videos under high contrast lighting scenes and improves object identification under bright and dark environment.
<b>Anti-flicker Mode</b>	Used when WDR is turned off. This helps reduce flicker when the device's screen flashes at the same frequency as the light.
<b>Notes</b>	Improper adjustment of the exposure and quality parameters may severely affect the performance of the device. Please adjust the exposure parameter only under the guidance of the after-sales service personnel of our company.

## 7.4 Factory Reset

Restore the device, such as communication settings and system settings, to factory settings (Do not clear registered user data).

Click **Reset** on the System interface.

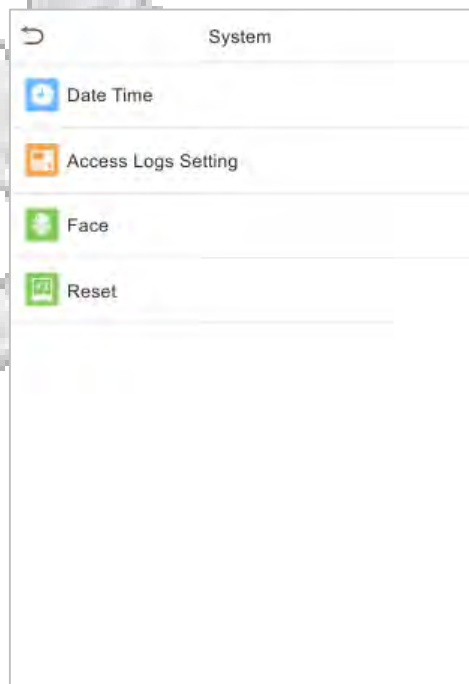

Click **OK** to reset.

## 8 Personalize Settings

You may customize interface settings, voice, bell.

Click **Personalize** on the main menu interface.

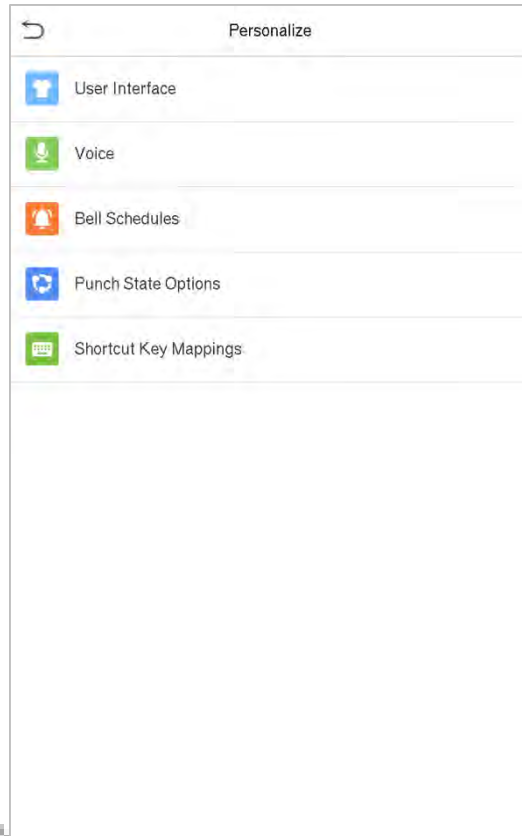

## 8.1 Interface Settings

You can customize the display style of the main interface.

Click **User Interface** on the Personalize interface.

User Interface	
Wallpaper	
Language	English
Menu Screen Timeout(s)	99999
Idle Time To Slide Show(s)	60
Slide Show Interval(s)	30
Idle Time To Sleep(m)	Disabled
Main Screen Style	Style 1

Item	Description
<b>Wallpaper</b>	To select the main screen wallpaper according to your personal preference.
<b>Language</b>	To select the language of the device.
<b>Menu Screen Timeout (s)</b>	When there is no operation, and the time exceeds the set value, the device will automatically go back to the initial interface. You can disable the function or set the value between 60 and 99999 seconds.
<b>Idle Time To Slide Show (s)</b>	When there is no operation, and the time exceeds the set value, a slide show will be played. It can be disabled, or you may set the value between 3 and 999 seconds.
<b>Slide Show Interval (s)</b>	This refers to the time interval switching different slide show pictures. The function can be disabled, or you may set the interval between 3 and 999 seconds.
<b>Idle Time To Sleep (m)</b>	If you have activated the sleep mode, when there is no operation, the device will enter standby mode. Press any key or finger to resume normal working mode. You can disable this function or set a value within 1-999 minutes.

**Main Screen Style** To select the main screen style according to your personal preference.

## 8.2 Voice Settings

Click **Voice** on the Personalize interface.

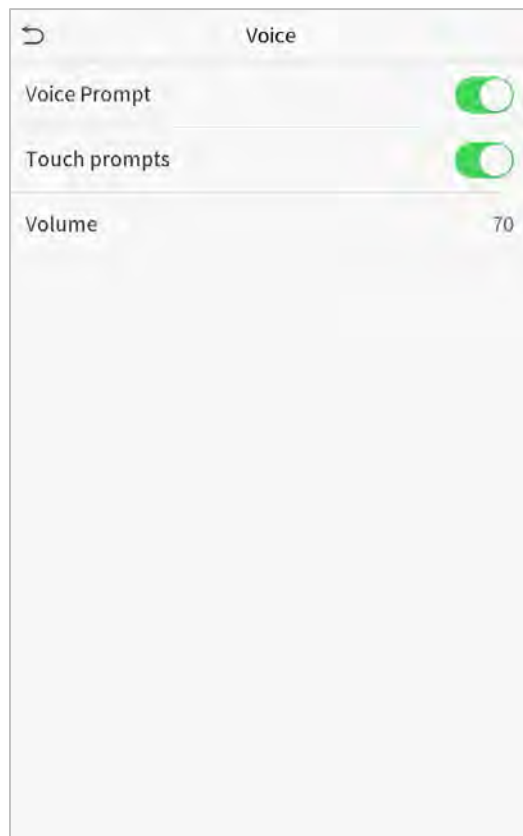

Item	Description
<b>Voice Prompt</b>	Select whether to enable voice prompts during operating.
<b>Touch Prompt</b>	Select whether to enable keypad sounds.
<b>Volume</b>	Adjust the volume of the device; valid value: 0-100.

## 8.3 Bell Schedules

Click **Bell Schedules** on the Personalize interface.



- **Add a bell**



1. Click **New Bell Schedule** to enter the adding interface:

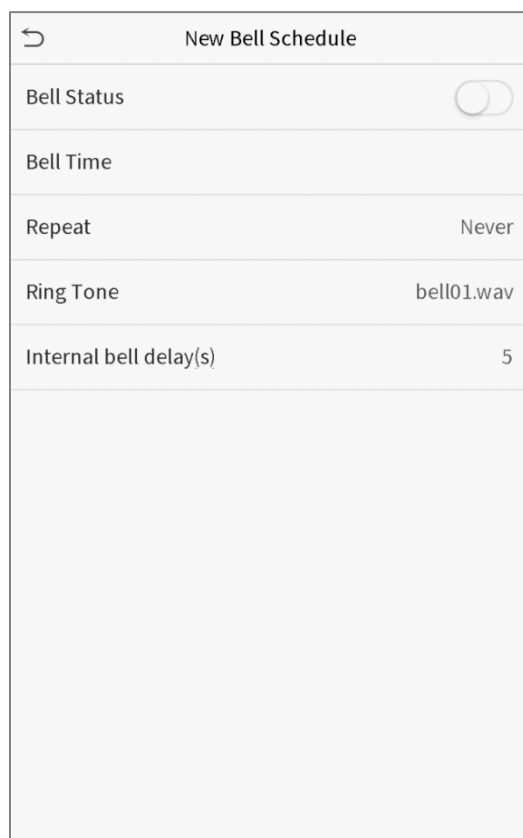

The screenshot shows a mobile application interface titled "New Bell Schedule". It features a list of settings:

- Bell Status:** A toggle switch that is currently turned off.
- Bell Time:** A field for setting the time of day.
- Repeat:** A dropdown menu currently set to "Never".
- Ring Tone:** A dropdown menu currently set to "bell01.wav".
- Internal bell delay(s):** A numeric input field currently set to "5".

Item	Description
<b>Bell Status</b>	Set whether to enable the bell status.
<b>Bell Time</b>	At this time of day, the device automatically rings the bell.
<b>Repeat</b>	Set the repetition cycle of the bell.
<b>Ring Tone</b>	Select a ring tone.
<b>Internal bell delay(s)</b>	Set the duration of the internal bell. Valid values range from 1 to 999 seconds.

2. Back to the Bell Schedules interface, click **All Bell Schedules** to view the newly added bell.

- **Edit a bell**

On the All Bell Schedules interface, tap the bell to be edited.

Click **Edit**, the editing method is the same as the operations of adding a bell.

- **Delete a bell**

On the All Bell Schedules interface, tap the bell to be deleted.

Tap **Delete** and select [**Yes**] to delete the bell.

## 8.4 Punch States Options

Click **Punch States Options** on the Personalize interface.

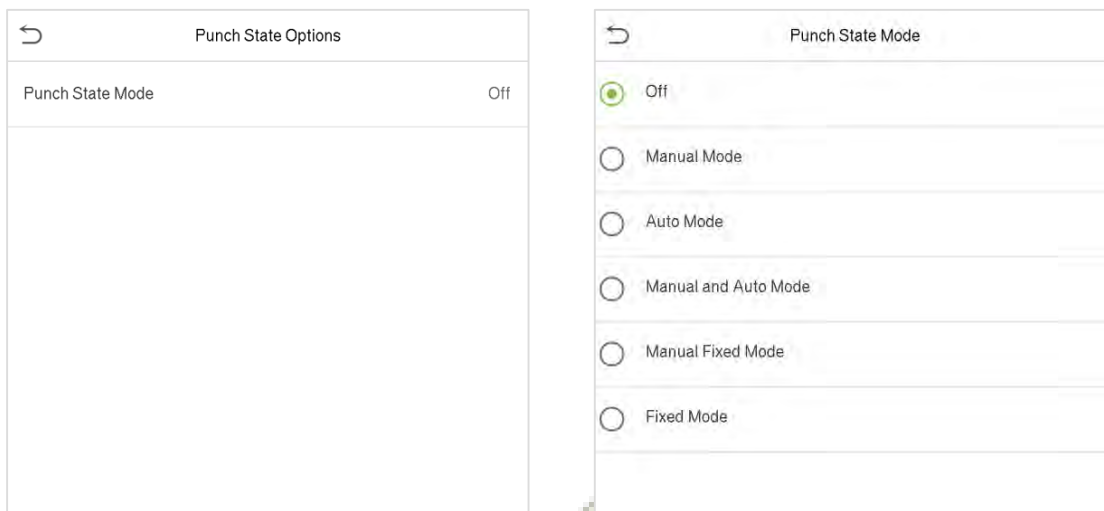

Item	Description
<b>Punch State Mode</b>	<p>Select a punch state mode, which can be:</p> <p><b>Off:</b> To disable the punch state key function. The punch state key set under <b>Shortcut Key Mappings</b> menu will become invalid.</p> <p><b>Manual Mode:</b> To switch the punch state key manually, and the punch state key will disappear after <b>Punch State Timeout</b>.</p> <p><b>Auto Mode:</b> After this mode is chosen, set <b>the</b> switching time of punch state key in <b>Shortcut Key Mappings</b>; when the switching time is reached, the set punch state key will be switched automatically.</p> <p><b>Manal and Auto Mode:</b> Under this mode, the main interface will display the auto-switching punch state key, meanwhile supports manually switching punch state key. After timeout, the manually switching punch state key will become auto-switching punch state key.</p> <p><b>Manual Fixed Mode:</b> After punch state key is manually switched, the punch state key will remain unchanged until being manually switched next time.</p> <p><b>Fixed Mode:</b> Only the fixed punch state key will be shown and it cannot be switched.</p>

## 8.5 Shortcut Keys Mappings

Users may define shortcuts as attendance status or functional keys. On the main interface, when the shortcut keys are pressed, the corresponding attendance status or function interface will quickly display.

Click **Shortcut Key Mappings** on the Personalize interface.

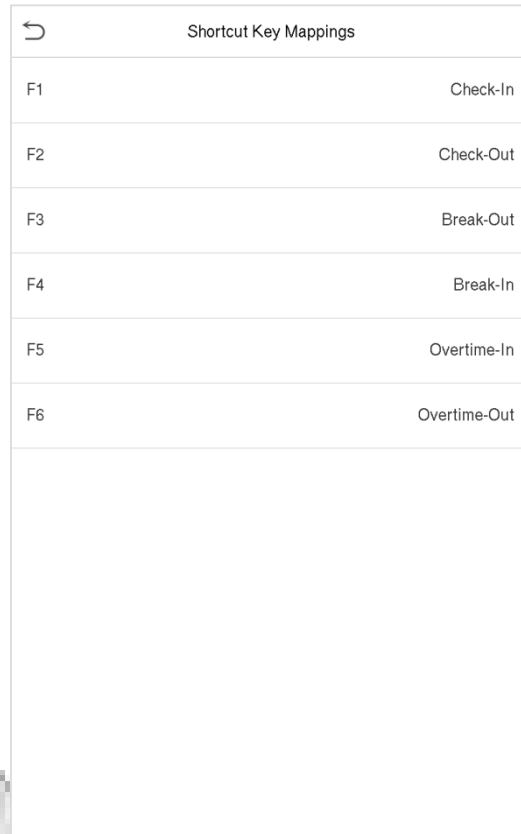

Shortcut Key Mappings	
F1	Check-In
F2	Check-Out
F3	Break-Out
F4	Break-In
F5	Overtime-In
F6	Overtime-Out

## 9 Data Management

To delete the relevant data in the device.

Click **Data Mgt.** on the main menu interface.

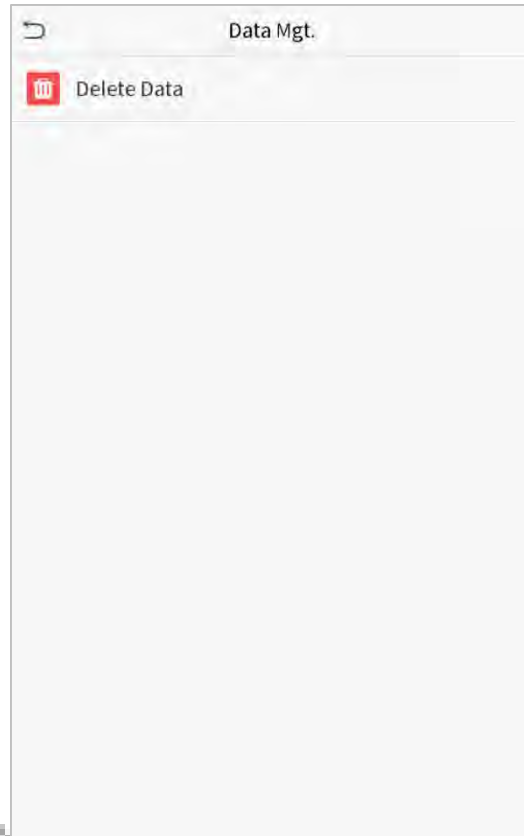

## 9.1 Delete Data

Click **Delete Data** on the Data Mgt. interface.

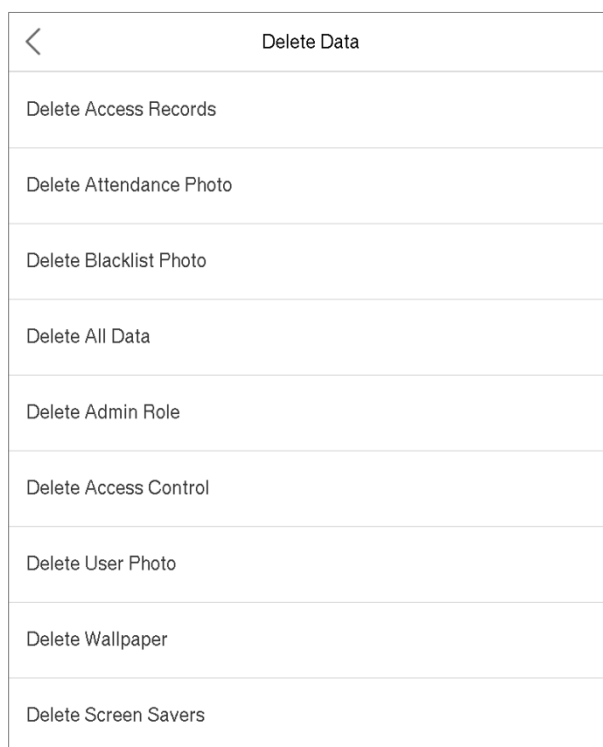

Item	Description
<b>Delete Access Records</b>	To delete access records conditionally.
<b>Delete Attendance Photo</b>	To delete attendance photos of designated personnel.
<b>Delete Blacklist Photo</b>	To delete the photos taken during failed verifications.
<b>Delete All Data</b>	To delete information and access records of all registered users.
<b>Delete Admin Role</b>	To remove administrator privileges.
<b>Delete Access Control</b>	To delete all access data.
<b>Delete User Photo</b>	To delete all user photos in the device.
<b>Delete Wallpaper</b>	To delete all wallpapers in the device.
<b>Delete Screen Savers</b>	To delete the screen savers in the device.

**Note:** When deleting the attendance data/access records, attendance photos or blacklisted photos, you may select Delete All or Delete by Time Range. Selecting Delete by Time Range, you need to set a specific time range to delete all data with the period.

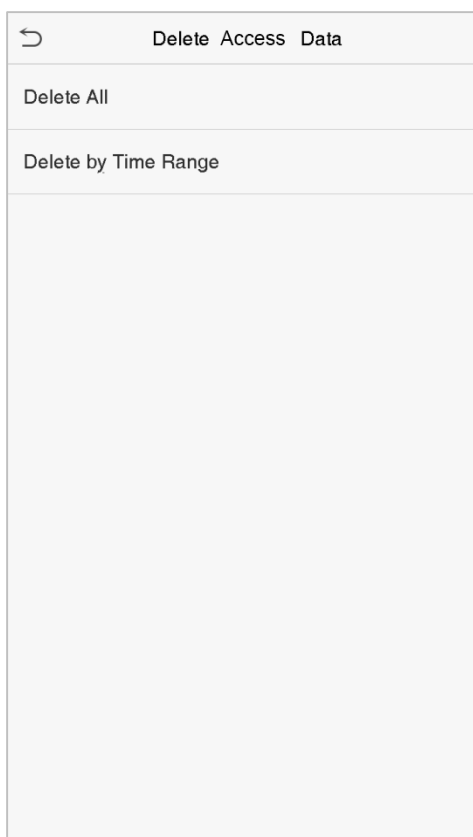

Select Delete by Time Range.

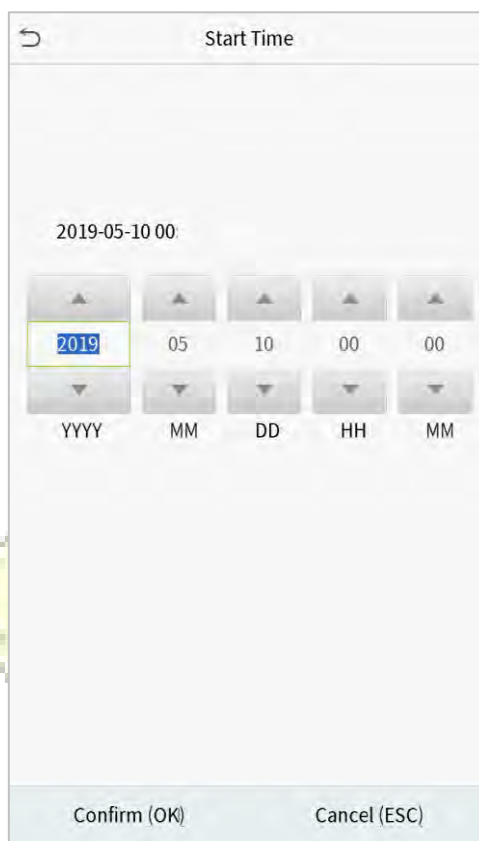

Set the time range and click OK.

## 10 Access Control

Access Control is used to set the schedule of door opening, locks control and other parameters settings related to access control.

Click **Access Control** on the main menu interface.

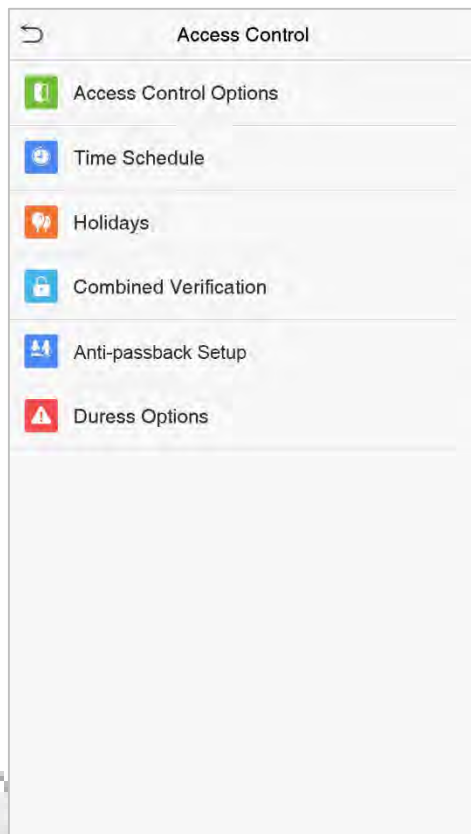

**To gain access, the registered user must meet the following conditions:**

1. The current door unlock time should be within any valid time zone of the user time period.
2. The user's group must be in the door unlock combination (when there are other groups in the same access combo, verification of members of those groups are also required to unlock the door).

In default settings, new users are allocated into the first group with the default group time zone and access combo as "1" and set in unlocking state.

## 10.1 Access Control Options

To set the parameters of the control lock of the terminal and related equipment.

Click **Access Control Options** on the Access Control interface.

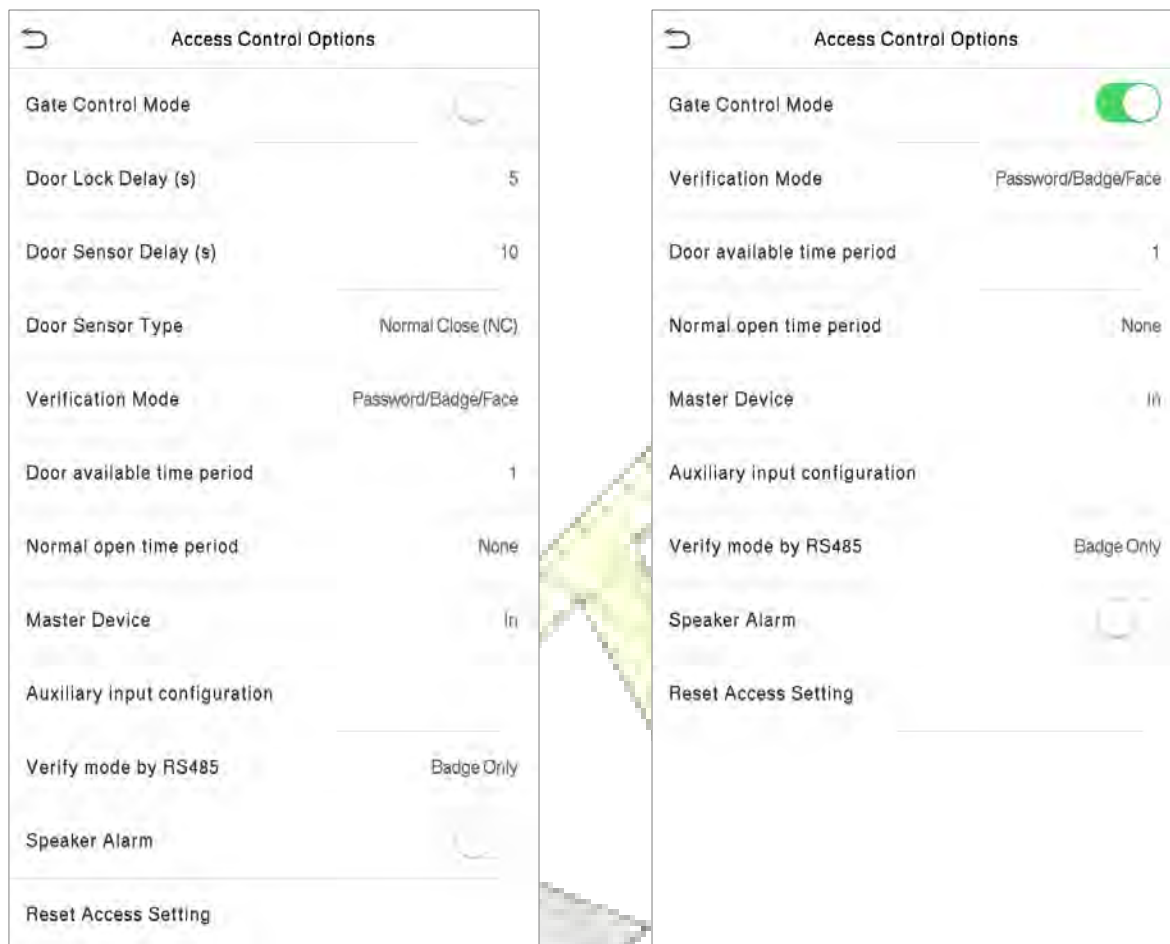

Item	Description
<b>Gate Control Mode</b>	Select whether to enable the Gate Control Mode. When it is enabled, the Door Lock Relay, Door Sensor Relay and Door Sensor Type will not be displayed.
<b>Door Lock Delay (s)</b>	The device controls the opening duration of the electric lock. Valid value: 1~10 seconds;0 second represents disabling the function.
<b>Door Sensor Delay (s)</b>	If the door is not closed and locked after opening for a certain duration (Door Sensor Delay), an alarm will be triggered. The valid value of Door Sensor Delay ranges from 1 to 255 seconds.
<b>Door Sensor Type</b>	There are three types: None, Normal Open, and Normal Closed. None means door sensor is not in use; Normal Open means the door is always opened when electricity is on; Normal Closed means the door is always closed when electricity is on.



<b>Verification Mode</b>	The supported verification mode includes password/face, User ID only, password, face only, and face + password.
<b>Door Available Time Period</b>	The time period when the user can open the door, it can be set to any of the 50 time rules.
<b>Normal Open Time Period</b>	Scheduled time period for "Normal Open" mode, so that the door is always unlocked during this period.
<b>Master Device</b>	When setting up the master and slave devices, the status of the master device can be set as out or in. <b>Out:</b> The record verified on the host is the exit record. <b>In:</b> The record verified on the host is the entry record.
<b>Auxiliary Input Configuration</b>	Set the door unlock time period and auxiliary output type of the auxiliary terminal device. Auxiliary output types include None, Trigger door open, Trigger Alarm, Trigger door open and Alarm.
<b>Verify Mode by RS485</b>	The verification mode used when the device is used as host or slave. The supported verification mode includes Badge only, Badge+Password.
<b>Speaker Alarm</b>	To transmit a sound alarm or disassembly alarm from the local. When the door is closed or the verification is successful, the system will cancel the alarm from the local.
<b>Reset Access Setting</b>	The restored access control parameters include door lock delay, door sensor delay, door sensor type, verification mode, door available time period, normal open time period, master device, and alarm. However, it does not include the deleted access control data in Data Management.

## 10.2 Time Schedule

The entire system can define up to 50 time periods. Each time period represents seven time zones, i.e. one week, and each time zone is a valid time period within 24 hours per day. User can only verify within the valid time period. Each time zone format of the time period: HH MM-HH MM, which is accurate to minutes according to the 24-hour clock.

Click **Time Schedule** on the Access Control interface.

1. Click the grey box to input a time zone to search. Enter the number of time zone (maximum: 50 zones).

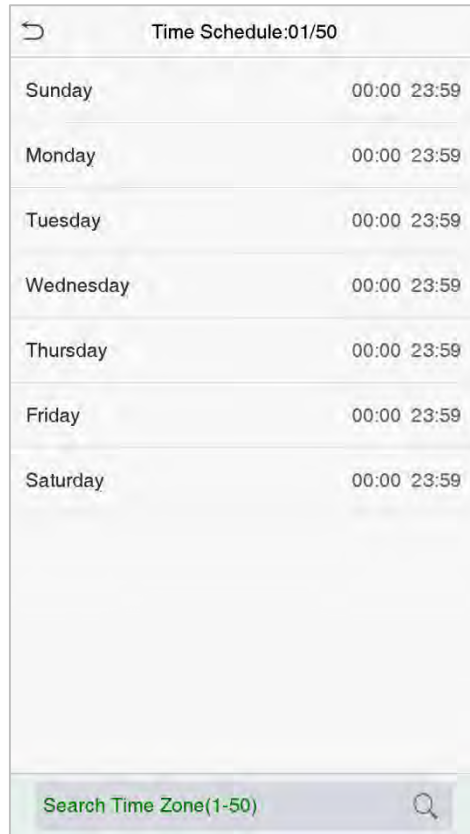

2. Click the date on which time zone settings is required. Enter the starting and ending time, and then press OK.

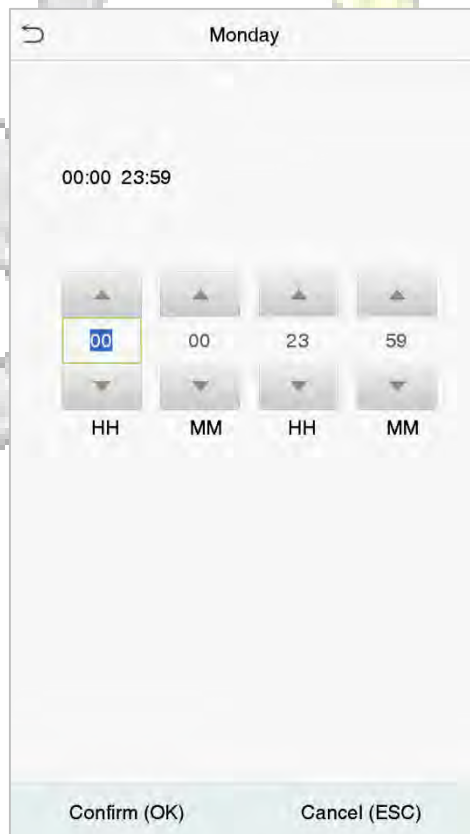

**Notes:**

1. When the ending time is earlier than the starting time, such as 23:57~23:56, it indicates that access is prohibited all day; when the ending time is later than the starting time, such as 00:00~23:59, it indicates that the interval is valid.
2. The effective time period to unlock the door: open all day (00:00~23:59) or when the ending time is later than the starting time, such as 08:00~23:59.
3. The default time zone 1 indicates that door is open all day long.

## 10.3 Holiday Settings

Whenever there is a holiday, you may need a special access time; but changing everyone's access time one by one is extremely cumbersome, so you can set a holiday access time which is applicable to all employees, and the user will be able to open the door during the holidays.

Click **Holidays** on the Access Control interface.

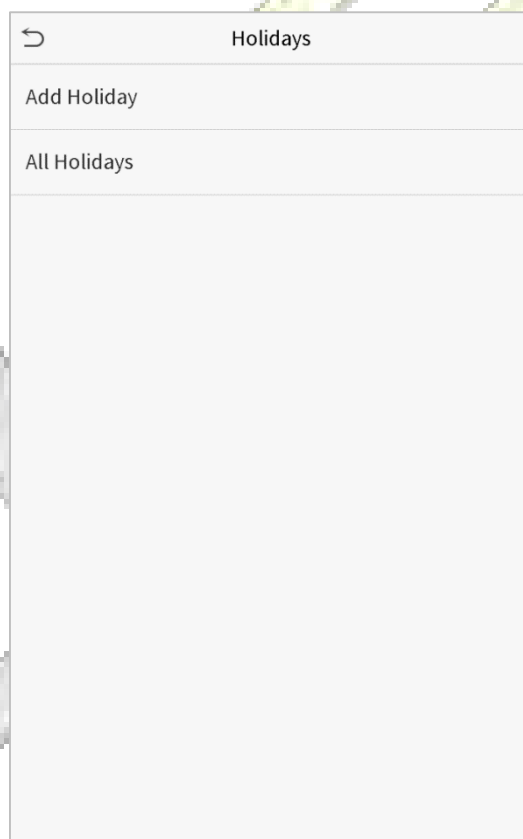

- **Add a New Holiday**

Click Add Holiday on the Holidays interface and set the holiday parameters.

Holidays	
No.	1
Start Date	Undefined
End Date	Undefined
Time Period	1

- **Edit a Holiday**

On the Holidays interface, select a holiday item to be modified. Click Edit to modify holiday parameters.

- **Delete a Holiday**

On the Holidays interface, select a holiday item to be deleted and click Delete. Click OK to confirm deletion. After deletion, this holiday is no longer displayed on All Holidays interface.

## 10.4 Combined Verification Settings

Access groups are arranged into different door-unlocking combinations to achieve multiple verifications and strengthen the security.

In a door-unlocking combination, the range of the combined number N is:  $0 \leq N \leq 5$ , and the number of members N may all belong to one access group or may belong to five different access groups.

Click **Combined Verification** on the Access Control interface.



Click the door-unlocking combination to be set. Click the up and down arrows to input the combination number, then press OK.

#### Examples:

The door-unlocking combination 1 is set as (01 03 05 06 08), indicating that the unlocking combination 1 consists of 5 people, and the 5 individuals are from 5 groups, namely, access control group 1 (AC group 1), AC group 3, AC group 5, AC group 6, and AC group 8, respectively.

The door-unlocking combination 2 is set as (02 02 04 04 07), indicating that the unlocking combination 2 consists of 5 people; the first two are from AC group 2, the next two are from AC group 4, and the last person is from AC group 7.

The door-unlocking combination 3 is set as (09 09 09 09 09), indicating that there are 5 people in this combination; all of which are from AC group 9.

The door-unlocking combination 4 is set as (03 05 08 00 00), indicating that the unlocking combination 4 consists of three people. The first person is from AC group 3, the second person is from AC group 5, and the third person is from AC group 8.

### Delete a door-unlocking combination

Set all group number as 0 if you want to delete door-unlocking combinations.

## 10.5 Anti-passback Setup

To avoid some persons following users and entering the door without verification, resulting in security problem, users can enable anti-passback function. The check-in record must match with the check-out record so as to open the door.

This function requires two devices to work together: one is installed inside the door (master device), the other one is installed outside the door (slave device). The two devices communicate via Wiegand signal. The Wiegand format and Output type (User ID / Badge Number) adopted by the master device and slave device must be consistent.

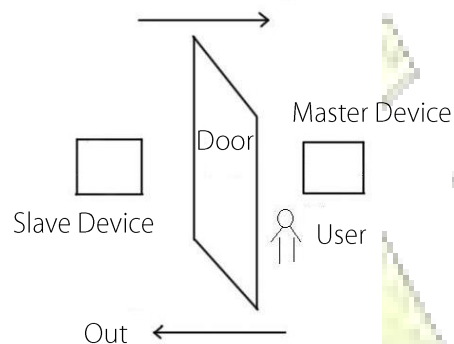

Click **Anti-passback Setup** on the Access Control interface.

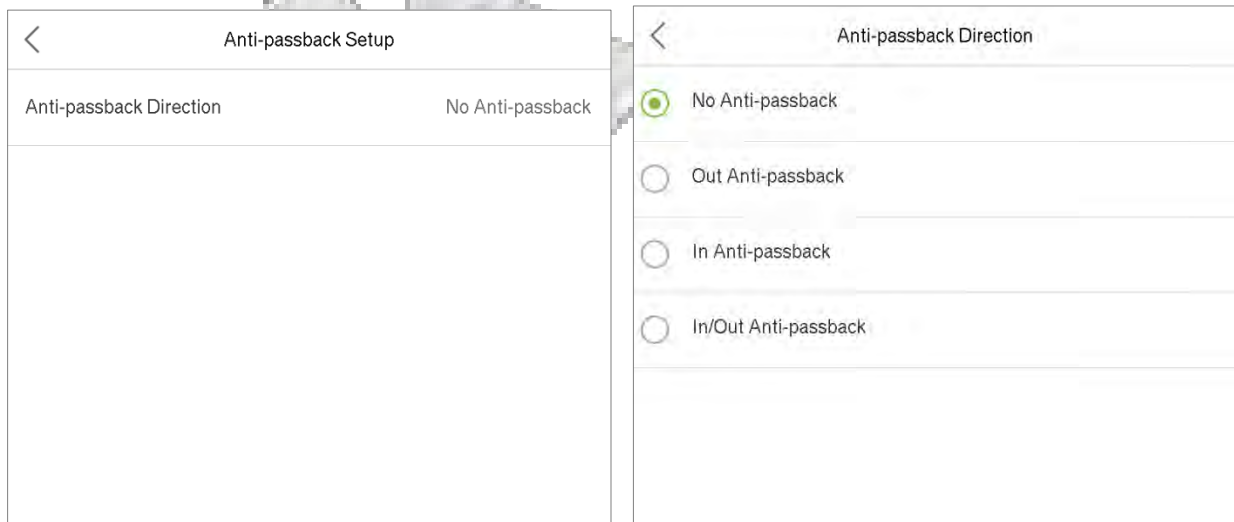

Item	Descriptions
<b>No Anti-passback</b>	Anti-Passback function is disabled, which means passing verification at either master device or slave device can unlock the door. Attendance state is not reserved.
<b>Out Anti-passback</b>	After a user checks out, only if the last record is a check-in record can the user check

	out again; otherwise, the alarm will be triggered. However, the user can check in freely.
<b>In Anti-passback</b>	After a user checks in, only if the last record is a check-out record can the user check in again; otherwise, the alarm will be triggered. However, the user can check out freely.
<b>In/Out Anti-passback</b>	After a user checks in/out, only if the last record is a check-out record can the user check in again, or a check-in record can the user check out again; otherwise, the alarm will be triggered.

## 10.6 Duress Options Settings

If a user activated the duress verification function with specific authentication method(s), when he/she is under coercion during authentication with such method, the device will unlock the door as usual, but at the same time a signal will be sent to trigger the alarm.

Click **Duress Options** on the Access Control interface.

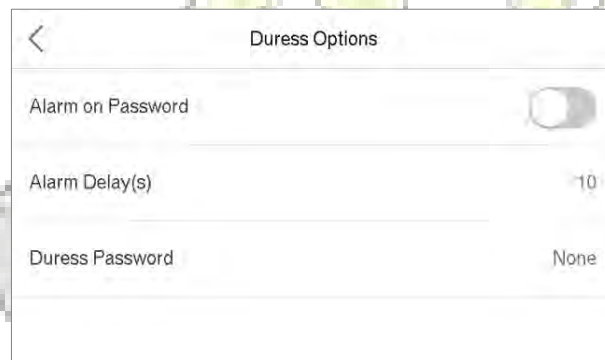

Item	Description
<b>Alarm on Password</b>	When a user uses the password verification method, an alarm signal will be generated, otherwise there will be no alarm signal.
<b>Alarm Delay (s)</b>	Alarm signal will not be transmitted until the alarm delay time is elapsed. The value ranges from 1 to 999 seconds.
<b>Duress Password</b>	Set the 6-digit duress password. When the user enters this duress password for verification, an alarm signal will be generated.

## 11 Attendance Search

When the identity of a user is verified, the access record will be saved in the device. This function enables users to check their access logs.

Click **Attendance Search** on the main menu interface.

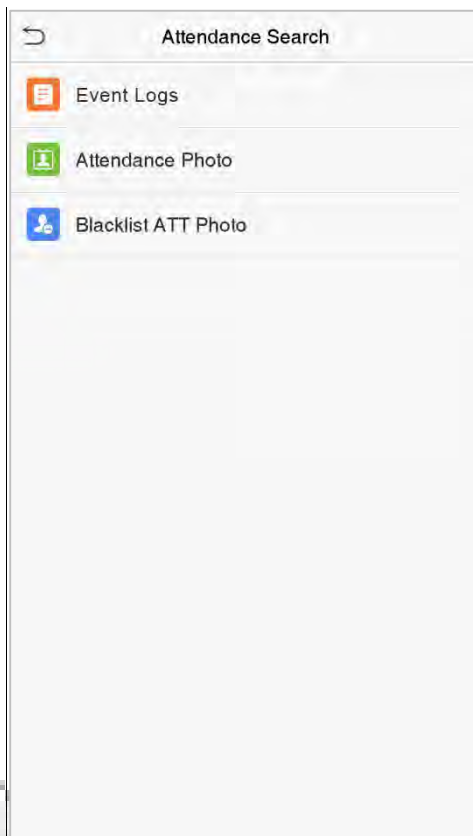

The process of searching for attendance and blacklist photos is similar to that of searching for event logs. The following is an example of searching for event logs.

On the Attendance Search interface, click **Event Logs**.



1. Enter the user ID to be searched and click OK. If you want to search for records of all users, click OK without entering any user ID.
2. Select the time range in which the records you want to search for.

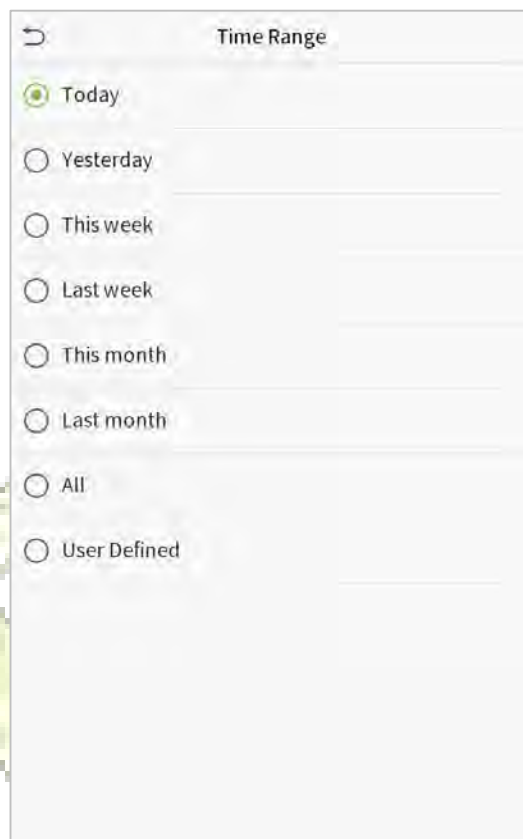

3. The record search succeeds. Click the record in green to view its details.

Date	User ID	Attendance
06-14		Number of Records:12
	1	16:40 16:40 16:40 16:40 16:40 16:40 16:40 16:36 16:30 16:12 16:10 16:10
06-12		Number of Records:20
	1	14:43 14:43 14:43 14:43 14:43 14:43 14:43 14:43 14:43 14:43 14:43 14:43 14:15 14:08 14:08 14:07 13:58 13:58 13:58 13:54
06-11		Number of Records:06
	1	19:39 18:36 18:36 18:36 18:36 17:14

4. The below figure shows the details of the selected record.

User ID	Name	Attendance	Mode	State
1	A	06-11 19:39	15	1
1	A	06-11 18:36	15	255
1	A	06-11 18:36	15	255
1	A	06-11 18:36	15	255
1	A	06-11 18:36	15	1
1	A	06-11 17:14	1	1

Verification Mode : Face Punch State : Check-Out

## 12 Print

Devices with printing function allow users to print attendance records when a printer is connected.

Click **Print** on the main menu interface.



Item	Description
<b>Data Field Setup</b>	Press ON/OFF to set which fields are available for printing.
<b>Printer Options</b>	Press ON/OFF to turn on / off the Paper Cut function.

**Note:** To use the Paper Cut function, you need to connect the device with a printer with paper cutting function, so that the printer will automatically cut papers according to the selected printing settings while printing.

## 13 Autotest

To automatically test whether all modules in the device function properly, which include the LCD, voice, camera and real-time clock (RTC).

Click **Autotest** on the main menu interface.

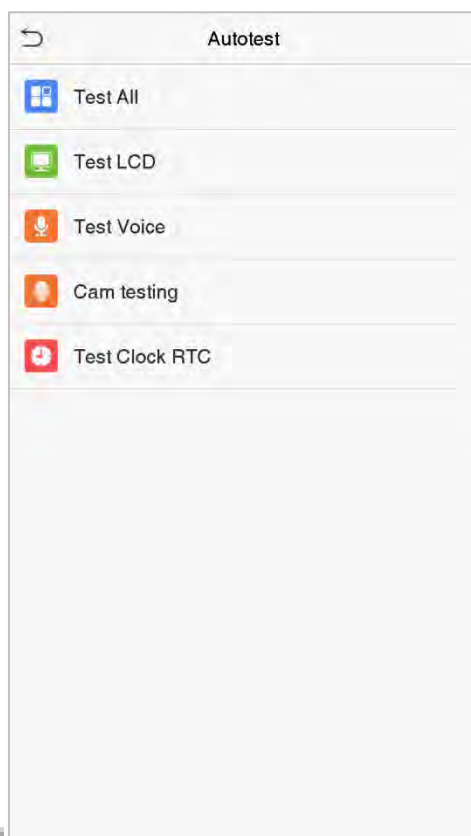

Item	Description
<b>Test All</b>	To automatically test whether the LCD, audio, camera and RTC are normal.
<b>Test LCD</b>	To automatically test the display effect of LCD screen by displaying full-color, pure white, and pure black to check whether the screen displays colors normally.
<b>Test Voice</b>	To automatically test whether the audio files stored in the device are complete and the voice quality is good.
<b>Camera testing</b>	To test if the camera functions properly by checking the pictures taken to see if they are clear enough.
<b>Test Clock RTC</b>	To test the RTC. The device tests whether the clock works normally and accurately with a stopwatch. Touch the screen to start counting and press it again to stop counting.

## 14 System Information

With the system information option, you can view the storage status, the version information of the device, and so on.

Click **System Info** on the main menu interface.

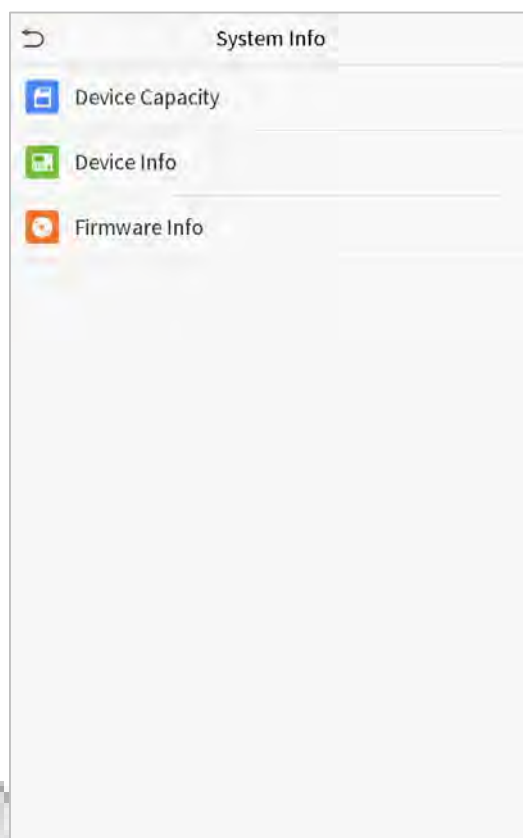

Item	Description
<b>Device Capacity</b>	Displays the current device's user storage, password, badge, and face storage, administrators, access records, attendance and blacklist photos, and user photos.
<b>Device Info</b>	Displays the device's name, serial number, MAC address, face algorithm version information, platform information, and manufacturer.
<b>Firmware Info</b>	Displays the firmware version and other version information of the device.

# Appendix 1

## Requirements of Live Collection and Registration of Visible

### Light Face Images

- 1) It is recommended to perform registration in an indoor environment with an appropriate light source without underexposure or overexposure.
- 2) Do not shoot towards outdoor light sources like door or window or other strong light sources.
- 3) Dark-color apparels which are different from the background color are recommended for registration.
- 4) Please show your face and forehead, and do not cover your face and eyebrows with your hair.
- 5) It is recommended to show a plain facial expression. Smile is acceptable, but do not close your eyes, or incline your head to any orientation. Two images are required for persons with eyeglasses, one image with eyeglasses and one other without.
- 6) Do not wear accessories like scarf or mask that may cover your mouth or chin.
- 7) Please face right towards the capturing device, and locate your face in the image capturing area as shown in Image 1.
- 8) Do not include more than one face in the capturing area.
- 9) 50cm - 80cm is recommended for capturing distance adjustable subject to body height.



Image1 Face Capture Area

## Requirements for Visible Light Digital Face Image Data

Digital photo should be straightly edged, colored, half-portrayed with only one person, and the person should be uncharted and not in uniform. Persons who wear eyeglasses should remain to put on eyeglasses for photo capturing.

- **Eye Distance**

200 pixels or above are recommended with no less than 115 pixels of distance.

- **Facial Expression**

Plain face or smile with eyes naturally open are recommended.

- **Gesture and Angel**

Horizontal rotating angle should not exceed  $\pm 10^\circ$ , elevation should not exceed  $\pm 10^\circ$ , and depression angle should not exceed  $\pm 10^\circ$ .

- **Accessories**

Masks and colored eyeglasses are not allowed. The frame of the eyeglasses should not shield eyes and should not reflect light. For persons with thick eyeglasses frame, it is recommended to capture two images, one with eyeglasses and the other one without.

- **Face**

Complete face with clear contour, real scale, evenly distributed light, and no shadow.

- **Image Format**

Should be in BMP, JPG or JPEG.

- **Data Requirement**

Should comply with the following requirements:

- 1) White background with dark-colored apparel.
- 2) 24bit true color mode.
- 3) JPG format compressed image with not more than 20kb size.
- 4) Definition rate between 358 x 441 to 1080 x 1920.
- 5) The vertical scale of head and body should be 2:1.
- 6) The photo should include the captured person's shoulders at the same horizontal level.
- 7) The captured person should be eyes-open and with clearly seen iris.
- 8) Plain face or smile is preferred, showing teeth is not preferred.
- 9) The captured person should be clearly seen, natural in color, and without image obvious twist, no shadow, light spot or reflection in face or background, and appropriate contrast and lightness level.

## Appendix 2

### Statement on the Right to Privacy

#### Dear Customers:

Thank you for choosing this hybrid biometric recognition product, which was designed and manufactured by ZKTeco. As a world-renowned provider of core biometric recognition technologies, we are constantly developing and researching new products, and strive to follow the privacy laws of each country in which our products are sold.

#### We Declare That:

1. All of our civilian fingerprint recognition devices capture only characteristics, not fingerprint images, and do not involve privacy protection.
2. None of the fingerprint characteristics that we capture can be used to reconstruct an image of the original fingerprint, and do not involve privacy protection.
3. As the provider of this device, we will assume no direct or indirect responsibility for any consequences that may result from your use of this device.
4. If you would like to dispute human rights or privacy issues concerning your use of our product, please directly contact your dealer.

Our other law-enforcement fingerprint devices or development tools can capture the original images of citizen's fingerprints. As to whether or not this constitutes an infringement of your rights, please contact your Government or the final supplier of the device. As the manufacturer of the device, we will assume no legal liability.

#### Note:

The Chinese law includes the following provisions on the personal freedom of its citizens:

1. There shall be no illegal arrest, detention, search, or infringement of persons;
2. Personal dignity is related to personal freedom and shall not be infringed upon;
3. A citizen's house may not be infringed upon;
4. A citizen's right to communication and the confidentiality of that communication is protected by the law.

As a final point, we would like to further emphasize that biometric recognition is an advanced technology that will be certainly used in E-commerce, banking, insurance, judicial, and other sectors in the future. Every year the world is subjected to major losses due to the insecure nature of passwords. The Biometric products serve to protect your identity in high-security environments.



## Eco-friendly Operation



The product's "eco-friendly operational period" refers to the time period during which this product will not discharge any toxic or hazardous substances when used in accordance with the prerequisites in this manual.

The eco-friendly operational period specified for this product does not include batteries or other components that are easily worn down and must be periodically replaced. The battery's eco-friendly operational period is 5 years.

### Hazardous or Toxic substances and their quantities

Component Name	Hazardous/Toxic Substance/Element					
	Lead (Pb)	Mercury (Hg)	Cadmium (Cd)	Hexavalent chromium (Cr6+)	Polybrominated Biphenyls (PBB)	Polybrominated Diphenyl Ethers (PBDE)
Chip Resistor	×	○	○	○	○	○
Chip Capacitor	×	○	○	○	○	○
Chip Inductor	×	○	○	○	○	○
Diode	×	○	○	○	○	○
ESD component	×	○	○	○	○	○
Buzzer	×	○	○	○	○	○
Adapter	×	○	○	○	○	○
Screws	○	○	○	×	○	○

○ indicates that the total amount of toxic content in all the homogeneous materials is below the limit as specified in SJ/T 11363—2006.

× indicates that the total amount of toxic content in all the homogeneous materials exceeds the limit as specified in SJ/T 11363—2006.

**Note:** 80% of this product's components are manufactured using non-toxic and eco-friendly materials. The components which contain toxins or harmful elements are included due to the current economic or technical limitations which prevent their replacement with non-toxic materials or elements.

## **FCC Warning**

Any Changes or modifications not expressly approved by the party responsible for compliance could void the user's authority to operate the equipment.

**Note:** This equipment has been tested and found to comply with the limits for a Class B digital device, pursuant to part 15 of the FCC Rules. These limits are designed to provide reasonable protection against harmful interference in a residential installation. This equipment generates uses and can radiate radio frequency energy and, if not installed and used in accordance with the instructions, may cause harmful interference to radio communications. However, there is no guarantee that interference will not occur in a particular installation. If this equipment does cause harmful interference to radio or television reception, which can be determined by turning the equipment off and on, the user is encouraged to try to correct the interference by one or more of the following measures:

- Reorient or relocate the receiving antenna.
- Increase the separation between the equipment and receiver.
- Connect the equipment into an outlet on a circuit different from that to which the receiver is connected.
- Consult the dealer or an experienced radio/TV technician for help.

This device complies with part 15 of the FCC Rules. Operation is subject to the following two conditions: (1) This device may not cause harmful interference, and (2) this device must accept any interference received, including interference that may cause undesired operation.

ZKTeco Industrial Park, No. 26, 188 Industrial Road,  
Tangxia Town, Dongguan, China.

Phone : +86 769 - 82109991

Fax : +86 755 - 89602394

[www.zkteco.com](http://www.zkteco.com)

