

User Manual

MKW Series

Date: June 2020

Doc Version: 1.0

English

Thank you for choosing our product. Please read the instructions carefully before operation. Follow these instructions to ensure that the product is functioning properly. The images shown in this manual are for illustrative purposes only.



For further details, please visit our Company's website
www.zkteco.com.

Copyright © 2020 ZKTECO CO., LTD. All rights reserved.

Without the prior written consent of ZKTeco, no portion of this manual can be copied or forwarded in any way or form. All parts of this manual belong to ZKTeco and its subsidiaries (hereinafter the "Company" or "ZKTeco").

Trademark

ZKTeco is a registered trademark of ZKTeco. Other trademarks involved in this manual are owned by their respective owners.

Disclaimer

This manual contains information on the operation and maintenance of the ZKTeco produce. The copyright in all the documents, drawings, etc. in relation to the ZKTeco supplied product vests in and is the property of ZKTeco. The contents hereof should not be used or shared by the receiver with any third party without express written permission of ZKTeco.

The contents of this manual must be read as a whole before starting the operation and maintenance of the supplied product. If any of the content(s) of the manual seems unclear or incomplete, please contact ZKTeco before starting the operation and maintenance of the said product.

It is an essential pre-requisite for the satisfactory operation and maintenance that the operating and maintenance personnel are fully familiar with the design and that the said personnel have received thorough training in operating and maintaining the device/unit/product. It is further essential for the safe operation of the device/unit/product that personnel has read, understood and followed the safety instructions contained in the manual.

In case of any conflict between terms and conditions of this manual and the contract specifications, drawings, instruction sheets or any other contract-related documents, the contract conditions/documents shall prevail. The contract specific conditions/documents shall apply in priority.

ZKTeco offers no warranty, guarantee or representation regarding the completeness of any information contained in this manual or any of the amendments made thereto. ZKTeco does not extend the warranty of any kind, including, without limitation, any warranty of design, merchantability or fitness for a particular purpose.

ZKTeco does not assume responsibility for any errors or omissions in the information or documents which are referenced by or linked to this manual. The entire risk as to the results and performance obtained from using the information is assumed by the user.

ZKTeco in no event shall be liable to the user or any third party for any incidental, consequential, indirect, special, or exemplary damages, including, without limitation, loss of business, loss of profits, business interruption, loss of business information or any pecuniary loss, arising out of, in connection with, or relating

to the use of the information contained in or referenced by this manual, even if ZKTeco has been advised of the possibility of such damages.

This manual and the information contained therein may include technical, other inaccuracies or typographical errors. ZKTeco periodically changes the information herein which will be incorporated into new additions/amendments to the manual. ZKTeco reserves the right to add, delete, amend or modify the information contained in the manual from time to time in the form of circulars, letters, notes, etc. for better operation and safety of the device/unit/product. The said additions or amendments are meant for improvement /better operations of the device/unit/product and such amendments shall not give any right to claim any compensation or damages under any circumstances.

ZKTeco shall in no way be responsible (i) in case the device/unit/product malfunctions due to any non-compliance of the instructions contained in this manual (ii) in case of operation of the device/unit/product beyond the rate limits (iii) in case of operation of the device and product in conditions different from the prescribed conditions of the manual.

The product will be updated from time to time without prior notice. The latest operation procedures and relevant documents are available on <http://www.zkteco.com>

If there is any issue related to the product, please contact us.

ZKTeco Headquarters

Address ZKTeco Industrial Park, No. 26, 188 Industrial Road,
Tangxia Town, Dongguan, China.

Phone +86 769 - 82109991

Fax +86 755 - 89602394

For business related queries, please write to us at: sales@zkteco.com.

To know more about our global branches, visit www.zkteco.com.

About the Company

ZKTeco is one of the world's largest manufacturer of RFID and Biometric (Fingerprint, Facial, Finger-vein) readers. Product offerings include Access Control readers and panels, Near & Far-range Facial Recognition Cameras, Elevator/floor access controllers, Turnstiles, License Plate Recognition (LPR) gate controllers and Consumer products including battery-operated fingerprint and face-reader Door Locks. Our security solutions are multi-lingual and localized in over 18 different languages. At the ZKTeco state-of-the-art 700,000 square foot ISO9001-certified manufacturing facility, we control manufacturing, product design, component assembly, and logistics/shipping, all under one roof.

The founders of ZKTeco have been determined for independent research and development of biometric verification procedures and the productization of biometric verification SDK, which was initially widely applied in PC security and identity authentication fields. With the continuous enhancement of the development and plenty of market applications, the team has gradually constructed an identity authentication ecosystem and smart security ecosystem, which are based on biometric verification techniques. With years of experience in the industrialization of biometric verifications, ZKTeco was officially established in 2007 and now has been one of the globally leading enterprises in the biometric verification industry owning various patents and being selected as the National High-tech Enterprise for 6 consecutive years. Its products are protected by intellectual property rights.

About the Manual

This manual introduces the operations of the MKW Series product.

All figures displayed are for illustration purposes only. Figures in this manual may not be exactly consistent with the actual products.

Document Conventions

Conventions used in this manual are listed below:

GUI Conventions

For Software	
Convention	Description
Bold font	Used to identify software interface names e.g. OK, Confirm, Cancel
>	Multi-level menus are separated by these brackets. For example, File > Create > Folder.
For Device	
Convention	Description
<>	Button or key names for devices. For example, press <OK>
[]	Window names, menu items, data table, and field names are inside square brackets. For example, pop up the [New User] window
/	Multi-level menus are separated by forwarding slashes. For example, [File/Create/Folder].

Symbols





Convention	Description
	This implies about the notice or pays attention to, in the manual
	The general information which helps in performing the operations faster
	The information which is significant
	Care taken to avoid danger or mistakes
	The statement or event that warns of something or that serves as a cautionary example.

Table of Contents

1	INSTALLATION PROCEDURE.....	6
2	WIRING INSTRUCTIONS.....	6
3	BASIC FUNCTIONALITIES	8
3.1	BUTTON FUNCTIONS	8
3.2	CARD TYPE DEFINITION.....	9
3.3	USER TYPE DEFINITION	9
3.4	DIP SWITCH DEFINITION	9
3.5	WIRING DEFINITION.....	9
3.6	STANDBY	10
4	OPERATIONAL SETTINGS.....	11
5	WORKING MODE CONVERSION.....	15
6	DATA TRANSFER.....	16
7	FAQ.....	16

1 Installation Procedure

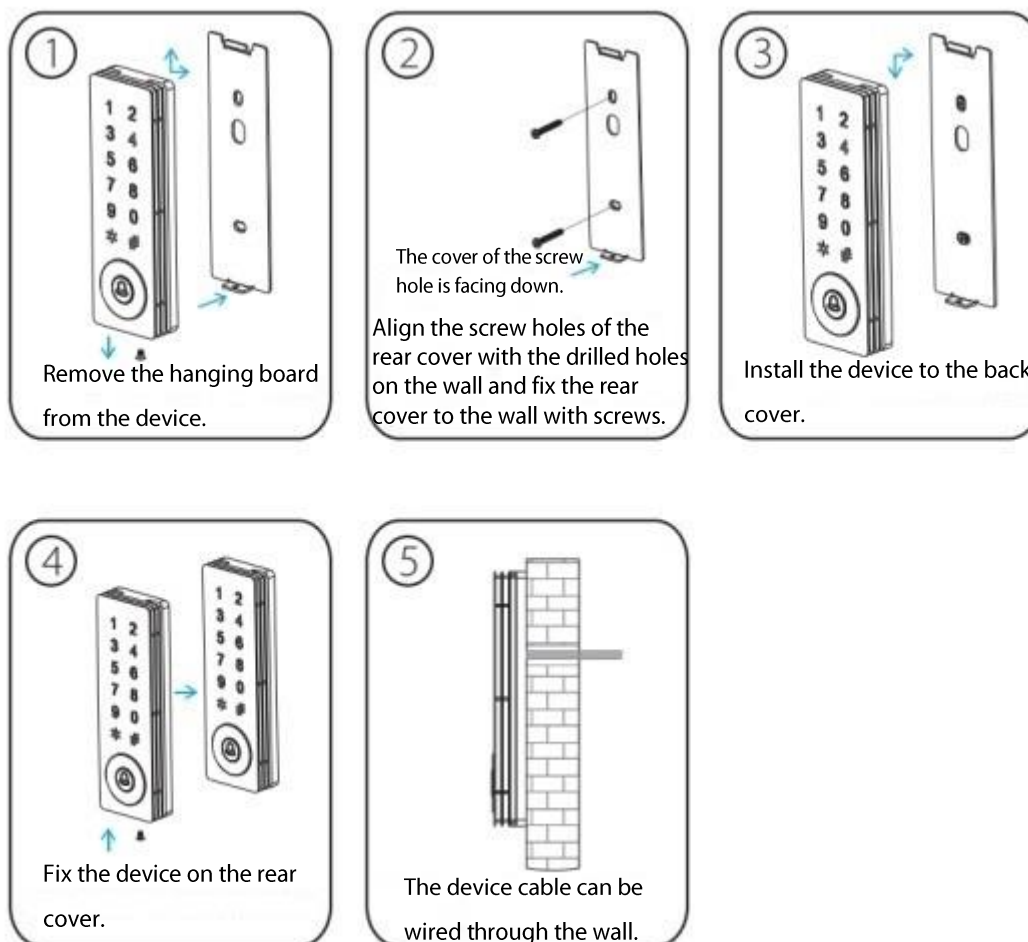

2 Wiring Instructions

⚠ Wiring should not be done when the power is on.

Note:

- 1) The system supports NO LOCK and NC LOCK. The NO LOCK (normally open by power on) is connected with NO terminal, and the NC LOCK is connected with the NC terminal.
- 2) To prevent the generation of self-inductance EMF which would affect the system, when the electrical lock is linked to the Access Control System; it is required to connect one FR107 diode (equipped in the package, do not reverse the polarities) in parallel to release the self-inductance EMF.

Under the following criteria, the device shares power with the lock:

- When $U_{LOCK}=12V, I > I_{Device} + I_{lock}$
- When the lock is near the device

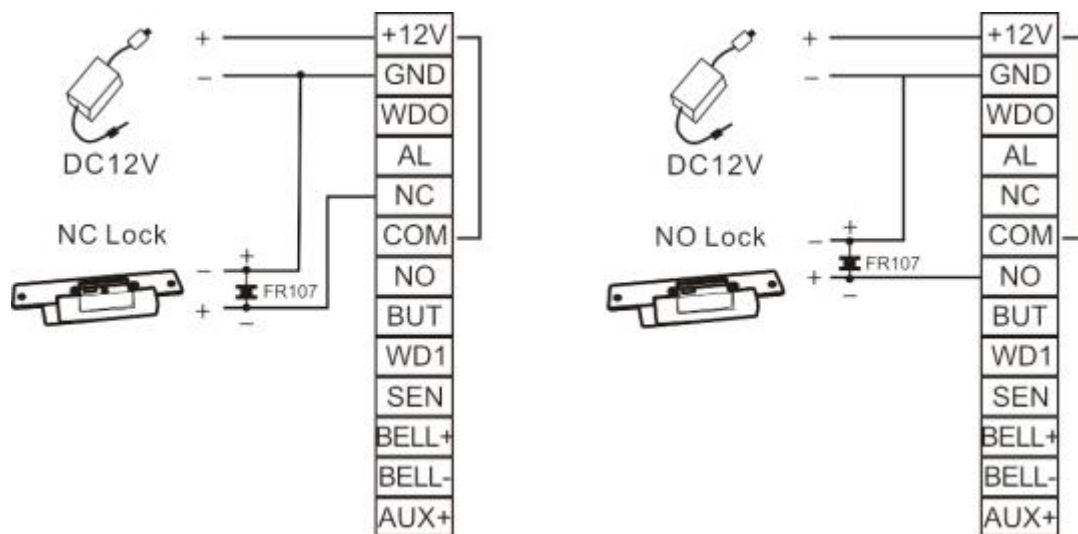

Figure 1-1

Under the following criteria, the device does not share the power with the lock:

- When $U_{LOCK}=12V, I < I_{Device} + I_{lock}$
- When $U_{LOCK} \neq 12V$
- When the lock is far from the device

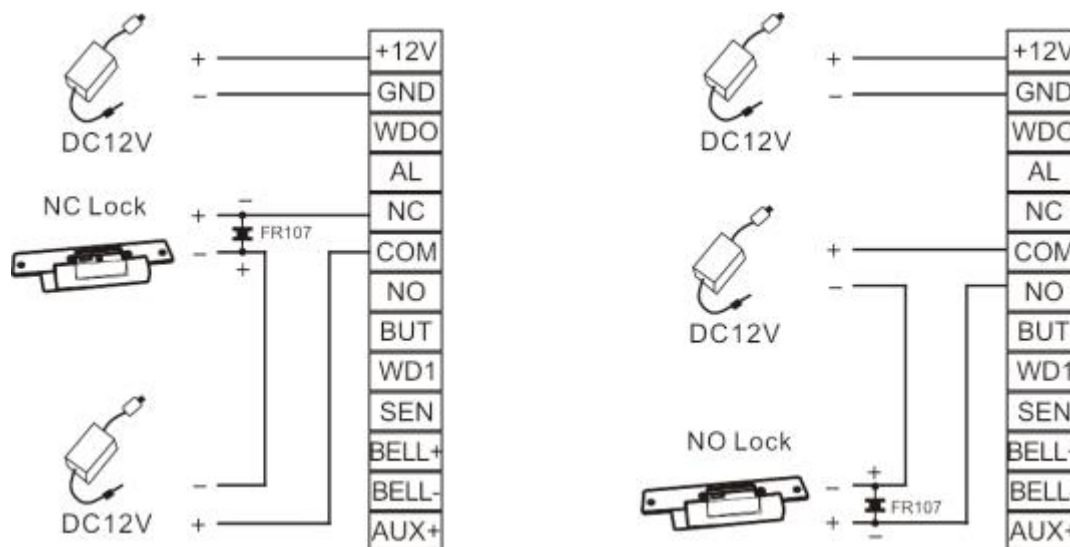

Figure 1-2

I - Device's current output

U_{LOCK} - Lock Voltage

I_{LOCK} - Lock Current

Power Connection

The Input power is DC12V, ≤200mA (≤150mA standby). The Positive Terminal must be connected with + 12V, and the negative terminal must be connected with GND (do not reverse the polarities).

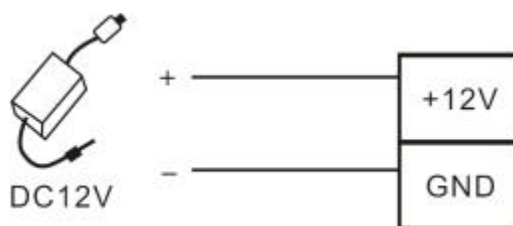

Connection with other Devices

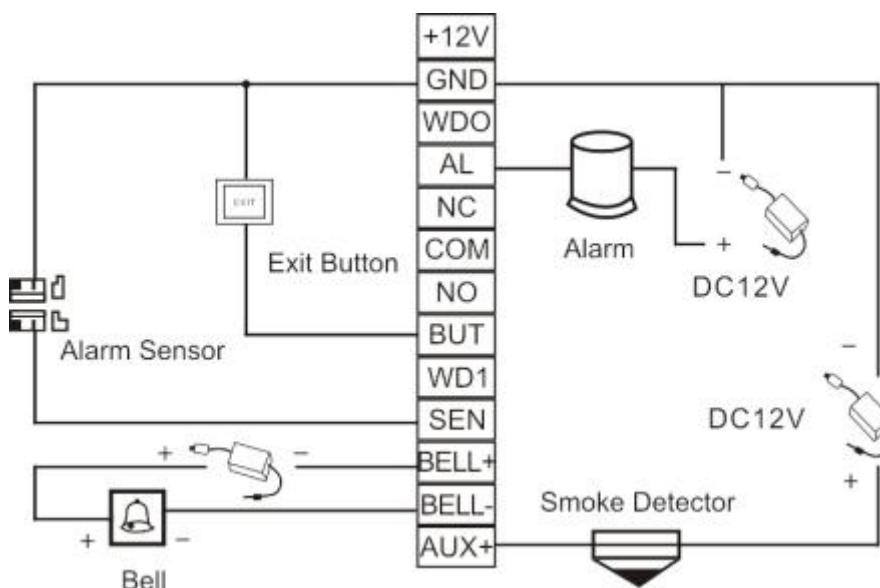

3 Basic Functionalities

To understand the functions and operations of the access control device more quickly, you need to understand the following basic concepts.

3.1 Button Functions

Button	Definition
0	Modify the Administrator password or set the Management Card
1	Add users with Card
2	Add users with Password
3	Add Card & Password users
4	Delete single users

5	Delete all users
6	Modify User password
7	Modify the door open delay time
8	Restore default settings
9	Set the Door open password, Add card, Delete card

3.2 Card Type Definition

Card Type	Definition
Manage Card	In standby mode, the shortcut operations are as follows: (1) Swipe the management card once to open the administrator mode. (2) Swipe the management card twice to enter the door magnetic normally open / normally closed switching mode. (3) Swipe the management card three times to enter the reader mode.
Add card	Used to add user cards.
Delete card	Used to delete user cards.

3.3 User Type Definition

User Type	Definition
Card type user	Can only be opened by swiping the card
Password type user	Can only be opened by password verification
Card & password type user	Can only be opened by swiping and entering the password

3.4 DIP Switch Definition

1. When the 1st and 2nd digits are turned ON, it enters the Wiegand input mode.
2. When the 3rd and 4th digits are turned ON, it enters the Wiegand output mode (Factory Default).
3. When the 5th and 6th digits are turned ON, it enters the data copy mode.
4. When the 1st, 2nd, 3rd, and 4th digits are turned ON, the device is powered on and enters the factory reset.

3.5 Wiring Definition

Controller Mode	
Red	DC 12V
Black	GND

Yellow	NC
Pink	COM
Blue	NO
Light Blue	SEN
Gray	BUT
Purple	BELL+
Brown	BELL-
Weigand/UART	
Green	When the 1st and 2nd digits of the DIP switch are turned ON. (Green: WD0-in, White: WD1-in)
White	When the 3rd and 4th digits of the DIP switch are turned ON. (Green: WD0-out, White: WD1-out)
	When the 5th and 6th digits of the DIP switch are turned ON. (Green: RXD, White: TXD)
Linkage Function	
Orange	AL(Alarm)
Light Green	AUX+
Reader Mode	
Red	DC 12V
Black	GND
Green	WD0
White	WD1
Gray	BEEP
Light Blue	LED
Purple	BELL+
Brown	BELL-

3.6 Standby

- In standby mode, the blue light flashes to indicate the controller mode.
- In standby mode, the blue light is always on, indicating that it is in reader mode.

4 Operational Settings

When the operation is successful, the green light will flash and when it fails, the blue light will flash.

Factory Reset

- 1) After getting the new access control device, restore the factory Settings to complete product initialization before other operations.
- 2) Pull the 1, 2, 3, and 4 digits of the DIP switch on the back of the access control device to the ON position at the same time. After the device is powered on, you can enter the factory reset operation.
- 3) After the factory reset is successful, pull the 3rd and 4th digits of the DIP switch to the ON position, in the Wiegand output mode (factory default state), and then power on the device again.

Note: Restoring the factory settings will delete all the user data, please be cautious.

Log out

Press * to exit the administrator status or no action will automatically exit the management state after 10 seconds.

Initial Password

No.	Category	Description
1	Administrator Password	The default password is 1234, and the password length is 1-8 digits.
2	Door password	The default password is 8888, the password length is 4-6 digits, and the general password can be set by the administrator for opening the door.
3	User password	User-defined opening password, there is no default password, and the password length 4-6 digits.
4	Data copy password	The default password is *1514885702#, which is used for data transfer between two devices. It cannot be changed.

Set Door Password

Press*# administrator password→9→input 4-6 door password #

Note: The default administrator password is 1234, and the default door password is 8888.

To delete the door password, press *# administrator password→9→0000#

Set Manage Card

Press *#→administrator password→0→Swipe card

Note: After you swipe the manage card, you can enter the administrator status.

Add Card and Delete Card

Press *# administrator password→9→swipe the first card as an add card.

swipe the second card as a delete card.

Set Quick Operation

In the standby mode, you can enter different functional modes by using the manage card, add card, and delete card.

- 1) Swipe the management card once, to enter the administrator mode.
- 2) Swipe the management card twice, to enter the door magnetic normally open / normally closed switching mode.
- 3) Swipe the management card three times, to enter the reader mode.
- 4) Swipe the add card directly to enter the batch add card type user mode.
- 5) Swipe the delete card directly to enter the batch delete card type user mode.

Add Card Type User

Press *# administrator password→1→ Swipe card

Note: Continuously swiping the card can add card type users in batches.

Add Password Type User

Press *# administrator password→2→enter the 4 to 6 digits user password #

Note:

- 1) The user password must be at least 4 to 6 digits.
- 2) After adding a password type user successfully, continue to enter the user password to continuously add a password type user.

Add Card & Password Type User

The device supports two ways to add card & password type user.

- 1) Press *# administrator password→3→user password#→swipe card
- 2) Press *# administrator password→3→swiping card→user password #

Note:

- a) After adding a card & password type user, continue to add a card & password type user in batches based on the above methods.
- b) You can open the door by entering the password and then swipe the card or swipe the card first and then enter the password.

Delete Single User

You can delete a single user in three ways:

- 1) Press *# administrator password→4→enter the user password #

Note: Enter the password continuously to delete the user.

- 2) Press *# administrator password→4→swipe card

Note: Swipe card continuously to delete the user

- 3) Press *# administrator password→4→enter decimal card number #

Note:

- Enter the decimal card number continuously to delete the user.
- Automatically deletes the card & password when deleting the card or password.

Delete All User

The device supports two ways to delete all the users:

- 1) Press *→#→administrator password→5→#
- 2) In standby mode, swipe the management card (to enter the management state), delete card, add card, delete card.

Modify Administrator Password

Press *#→administrator password→0→New password→#→New password→#

Note:

The administrator password is 1 to 8 digits in length. If you forget the administrator password, you can reset the administrator password by swiping the management card.

Modify User Password

Perform the following ways to modify the user password:

- 1) Password type user: Press *# administrator password→6→old password #4 to 6-digit New password #
- 2) Card & Password type user: Press *#administrator password→6→swiping card→4-6-digit New password #

Set Open Delay Time

Press*# administrator password→7→1→input open delay time#

Note: The door open delay time is 0 to 60 seconds, the default is 3 seconds, and the maximum is 60 seconds.

Set Button Backlight

Press *# administrator password → 7 → 5 → 0/1/2

(0: Normally closed, 1: Normally Bright, 2: Touch button press will light)

Set Indicator Light

Press *# administrator password → 7 → 6 → 0 or 1 (0: Close, 1: Open)

Set Door Sensor Alarm Delay

Press *# administrator password → 7 → 7 → input alarm delay time #

Note: The door sensor alarm delay is 0 to 255 seconds, the default is 15 seconds.

Set Door Sensor Mode

Press *# administrator password → 7 → 4 → 0/1 (0: Normally closed, 1: Normally open)

Set Alarm Main Switch

In standby mode, it is supported to enable or disable the door sensor alarm, tamper alarm, and wrong press alarm by shortcut operation mode.

- 1) Turn on the alarm: Directly swipe the add card three times to open the door sensor alarm, tamper alarm, and wrong press alarm.
- 2) Turn off the alarm: Directly swipe the delete card three times to close the door sensor alarm, tamper alarm, and wrong press alarm.

Set Door Sensor Alarm Switch

Press *# administrator password → 7 → 2 → 0 or 1 (0: Close, 1: Open)

Set Tamper Alarm Switch

Press *# administrator password → 7 → 3 → 0 or 1 (0: Close, 1: Open)

Set Wrong Press Alarm Switch

Press *# administrator password → 7 → 8 → 0/1 (0: Close, 1: Open)

Note:

- 1) The default state of the wrong press alarm switch is on. After entering the wrong administrator password continuously 5 times, only the button can be pressed in 10 seconds and if the card is not opened, the normal operation can be resumed after 10 seconds.
- 2) If the number of wrong clicks does not exceed five times, after 1 minute of no operation, the number of wrong clicks will be restored to 5 times.

Restore Default Settings

You can restore the default settings of the access control device by performing the following steps:

- 1) Press *# administrator password→8#→0#
- 2) In standby mode, the quick operation mode: Directly swipe the delete card, add card, delete card in sequence, and then complete the default parameter setting initialization.

Note: After initialization is successful, all the settings will be cleared but user data will be retained.

Default parameter setting

Door Password	The default password is 8888.
Door Sensor Mode	Normally open
Open Delay Time	0-60 seconds, default 3 seconds
Door Sensor Alarm Delay Time	0-255 seconds, default 15 seconds
Door Sensor Alarm	Open
Tamper Alarm	Open
Working Mode	Controller Mode
Key Backlight	Constantly bright

5 Working Mode Conversion

- In standby mode, the blue light flashes to indicate the controller mode.
 - In standby mode, the blue light glows constantly, indicating that it is working in reader mode.
1. Reader mode switch controller mode
 - a) Mechanical button type: Continuously press * for 5 seconds, then press #→administrator password→8→1→0
 - b) Touch button type: Press * for 5 times, then press #→administrator password→8→1→0
 2. Controller mode switch reader mode
 - a) Set the Wiegand mode of reader head. (Make sure that the 3rd and 4th digits of the DIP switch are turned ON position and the device is in Wiegand output mode.)

Standard Wiegand mode: Press *# administrator password→8→2→0

Custom Wiegand Mode 1 (Spain): Press *# administrator password→8→2→1

Custom Wiegand Mode 2 (Russia): Press *# administrator password→8→2→2

- b) Then set the Wiegand format.

Press *# administrator password→8→1→1 or 2 or 3 or 7 (1:WG26, 2:WG34, 3: WG42, 7:WG44)

6 Data Transfer

1. Copy data through the access control device:

- a) Pull the 5th and 6th positions of the DIP switches of the two access control devices to the ON position.
- b) The TXD of the main access control device is connected with the RXD of the auxiliary access control device, and the RXD of the main access control device is connected with the TXD of the auxiliary access control device, and the GND of the two access control devices are connected.
- c) Enter the data copy password *1514885702# on the main access control device. In the two access control devices, the blue and green indicator lights will flash at the same time, and wait until the sound drops to complete the data copying process.

Note: The main access control device is the data access control device, and the auxiliary access control device is an access control device that needs to write data.

2. Copy data through DEMO software:

- a) Pull the 5th and 6th positions of the DIP switches of the two access control devices to the ON position.
- b) The RXD of the access control device is connected with the TXD of the serial port tool, and the TXD of the access control device is connected with the RXD of the serial port tool. The GND of the access control device and serial port tool are connected.
- c) You can export the user data of the access control device to a local computer through DEMO software.
- d) You can Import the user data exported from the access control device into other access control devices through DEMO software. Or fill in the user data according to the template, and then import the user data through the DEMO software.

Note: Please contact the technical professional to get DEMO software.

7 FAQ

Issue	Solution
After swiping the card, the door is not opened	<ol style="list-style-type: none"> 1. Check if the card is registered. 2. Make sure the access control mode is correct.
The Card is not read	<ol style="list-style-type: none"> 1. Check if the card type is correct or the card is damaged. 2. Check if the external card reader is too close to the host.

FCC warning:

Any Changes or modifications not expressly approved by the party responsible for compliance could void the user's authority to operate the equipment.

Note: This equipment has been tested and found to comply with the limits for a Class B digital device, pursuant to part 15 of the FCC Rules. These limits are designed to provide reasonable protection against harmful interference in a residential installation. This equipment generates uses and can radiate radio frequency energy and, if not installed and used in accordance with the instructions, may cause harmful interference to radio communications. However, there is no guarantee that interference will not occur in a particular installation. If this equipment does cause harmful interference to radio or television reception, which can be determined by turning the equipment off and on, the user is encouraged to try to correct the interference by one or more of the following measures:

- Reorient or relocate the receiving antenna.
- Increase the separation between the equipment and receiver.
- Connect the equipment into an outlet on a circuit different from that to which the receiver is connected.
- Consult the dealer or an experienced radio/TV technician for help.

The device has been evaluated to meet general. This equipment should be installed and operated with minimum distance 20cm between the radiator and your body. This transmitter must not be co-located or operating in conjunction with any other antenna or transmitter.

This device complies with part 15 of the FCC Rules. Operation is subject to the following two conditions:

This device complies with part 15 of the FCC Rules. Operation is subject to the

- (1) This device may not cause harmful interference,
- (2) This device must accept any interference received, including interference that may cause undesired operation.

ZKTeco Industrial Park, No. 26, 188 Industrial Road,

Tangxia Town, Dongguan, China.

Phone : +86 769 - 82109991

Fax : +86 755 - 89602394

www.zkteco.com

