

**ELECTROMAGNETIC EMISSIONS COMPLIANCE REPORT
INTENTIONAL RADIATOR CERTIFICATION TO
FCC PART 15 SUBPART C REQUIREMENT**

OF

Smart Access Control Terminal

MODEL No.: ProRF, SCR100 Plus

FCC ID: 2AJ9T-PRORFI

Trademark: N/A

REPORT NO: ES181024030W

ISSUE DATE: November 16, 2018

Prepared for
ZKTECO CO., LTD.
**No.26, Pingshan 188 Industry zone, Tangxia Town, Dongguan City,
Guangdong Province, China**

Prepared by
EMTEK(SHENZHEN) CO., LTD.

**Bldg 69, Majialong Industry Zone, Nanshan District,
Shenzhen, Guangdong, China
TEL: 86-755-26954280
FAX: 86-755-26954282**

VERIFICATION OF COMPLIANCE

Applicant:	ZKTECO CO., LTD. No.26, Pingshan 188 Industry zone, Tangxia Town, Dongguan City, Guangdong Province, China
Manufacturer:	ZKTECO CO., LTD. No.26, Pingshan 188 Industry zone, Tangxia Town, Dongguan City, Guangdong Province, China
Product Name:	Smart Access Control Terminal
Model Number:	ProRF, SCR100 Plus
Trademark:	N/A

Measurement Procedure Used:

APPLICABLE STANDARDS	
STANDARD	TEST RESULT
FCC 47 CFR Part 2, Subpart J FCC 47 CFR Part 15, Subpart C	PASS

The above equipment was tested by EMTEK(SHENZHEN) CO., LTD.. The test data, data evaluation, test procedures, and equipment configurations shown in this report were made in accordance with the procedures given in ANSI C63.10 (2013) and the energy emitted by the sample EUT tested as described in this report is in compliance with conducted and radiated emission limits of FCC Rules Part 15.207&15.209.

The test results of this report relate only to the tested sample identified in this report.

Date of Test : October 24, 2018 to November 16, 2018

Prepared by : 
Sevin Li/Editor

Reviewer : 
Joe Xia/Supervisor

Approved & Authorized Signer : 
Lisa Wang/Manager



Table of Contents

1.	GENERAL INFORMATION	4
1.1	PRODUCT DESCRIPTION.....	4
1.2	RELATED SUBMITTAL(S) / GRANT (S)	4
1.3	TEST METHODOLOGY.....	4
1.4	SPECIAL ACCESSORIES.....	4
1.5	EQUIPMENT MODIFICATIONS.....	4
1.6	TEST FACILITY	5
2.	SYSTEM TEST CONFIGURATION.....	6
2.1	EUT CONFIGURATION.....	6
2.2	EUT EXERCISE.....	6
2.3	TEST PROCEDURE	6
2.4	LIMITATION	6
3.	SUMMARY OF TEST RESULTS.....	8
4.	CONDUCTED EMISSION TEST.....	9
4.1	APPLICABLE STANDARD	9
4.2	CONFORMANCE LIMIT.....	9
4.3	TEST CONFIGURATION	9
4.4	TEST PROCEDURE	9
4.5	MEASUREMENT EQUIPMENT USED:.....	9
4.6	TEST RESULT	9
5.	RADIATED EMISSION TEST	12
5.1	MEASUREMENT PROCEDURE.....	12
5.2	TEST SET-UP (BLOCK DIAGRAM OF CONFIGURATION).....	13
5.3	MEASUREMENT EQUIPMENT USED:.....	13
5.4	MEASUREMENT RESULT.....	13
6.	ANTENNA APPLICATION	24
	ANTENNA REQUIREMENT.....	24
	RESULT.....	24

1. GENERAL INFORMATION

1.1 Product Description

Characteristics	Description
EUT Description	Smart Access Control Terminal
Model Number	ProRF, SCR100 Plus Two models are identical in circuitry and electrical, mechanical and physical construction; the difference is model number for trading purpose; we test ProRF Model
Device style	RFID
Modulation	ASK
Operating Frequency Range	125kHz
Number of Channels	1
Antenna Type	Coil Antenna
Power supply	<input checked="" type="checkbox"/> DC supply: DC 12V
	<input type="checkbox"/> Adapter supply:

1.2 Related Submittal(s) / Grant (s)

This submittal(s) (test report) is intended for FCC ID: 2AJ9T-PRORFI filing to comply with Section 15.207&15.209 of the FCC Part 15 Subpart C Rules.

1.3 Test Methodology

Both conducted and radiated testing was performed according to the procedures in ANSI C63.10 (2013) and Radiated testing was performed at an antenna to EUT distance 3 meters.

1.4 Special Accessories

Item	Equipment	Mfr/Brand	Model/Type No.	Note
1	SWITCHING ADAPTOR	FUJIA	FJ-SW120300N	Input: AC 100-240V, 50/60Hz 1.5A Output: 12V, 3A

1.5 Equipment Modifications

Not available for this EUT intended for grant.

1.6 Test Facility

Site Description
EMC Lab.

- : Accredited by CNAS, 2016.10.24
The certificate is valid until 2022.10.28
The Laboratory has been assessed and proved to be in compliance with CNAS-CL01: 2006(identical to ISO/IEC17025: 2005)
The Certificate Registration Number is L2291
- : Accredited by TUV Rheinland Shenzhen, 2010.5.25
The Laboratory has been assessed according to the requirements ISO/IEC 17025.
- : Accredited by FCC, August 06, 2018
The certificate is valid until August 07, 2020
Designation Number: CN1204
Test Firm Registration Number: 882943
- : Accredited by Industry Canada, November 24, 2015
The Certificate Registration Number is 4480A-2

2. System Test Configuration

2.1 EUT Configuration

The EUT configuration for testing is installed on RF field strength measurement to meet the Commissions requirement and operating in a manner which intends to maximize its emission characteristics in a continuous normal application.

2.2 EUT Exercise

The Transmitter was operated in the normal operating mode. The TX frequency was fixed which was for the purpose of the measurements.

2.3 Test Procedure

2.3.1 Radiated Emissions

The EUT is placed on a turn table which is 0.8 m above ground plane. The turn table shall rotate 360 degrees to determine the position of maximum emission level. EUT is set 3m away from the receiving antenna which varied from 1m to 4m to find out the highest emission. And also, each emission was to be maximized by changing the polarization of receiving antenna both horizontal and vertical. In order to find out the max. emission, the relative positions of this hand-held transmitter(EUT) was rotated through three orthogonal axes according to the requirements in Section 13.1.4.1 of ANSI C63.10 (2013).

2.4 Limitation

(1) Radiated Emission

FCC Part 15, Subpart C Section 15.209 limit of radiated emission for frequency below 1000GHz. The emissions from an intentional radiator shall not exceed the field strength level specified in the following table:

FCC Part 15.209				
Frequency (MHz)	Field Strength Limitation		Field Strength Limitation Frequency tion at 3m Measurement Dist	
	(uV/m)	Dist	(uV/m)	(dBuV/m)
0.009 – 0.490	$2400 / F(\text{KHz})$	300m	$10000 * 2400/F(\text{KHz})$	$20\log 2400/F(\text{KHz}) + 80$
0.490 – 1.705	$24000 / F(\text{KHz})$	30m	$100 * 24000/F(\text{KHz})$	$20\log 24000/F(\text{KHz}) + 40$
1.705 – 30.00	30	30m	$100 * 30$	$20\log 30 + 40$
30.0 – 88.0	100	3m	100	$20\log 100$
88.0 – 216.0	150	3m	150	$20\log 150$
216.0 – 960.0	200	3m	200	$20\log 200$
Above 960.0	500	3m	500	$20\log 500$

15.205 Restricted bands of operation

MHz	MHz	MHz	GHz
0.090 - 0.110	16.42 - 16.423	399.9 - 410	4.5 - 5.15
¹ 0.495 - 0.505	16.69475 - 16.69525	608 - 614	5.35 - 5.46
2.1735 - 2.1905	16.80425 - 16.80475	960 - 1240	7.25 - 7.75
4.125 - 4.128	25.5 - 25.67	1300 - 1427	8.025 - 8.5
4.17725 - 4.17775	37.5 - 38.25	1435 - 1626.5	9.0 - 9.2
4.20725 - 4.20775	73 - 74.6	1645.5 - 1646.5	9.3 - 9.5
6.215 - 6.218	74.8 - 75.2	1660 - 1710	10.6 - 12.7
6.26775 - 6.26825	108 - 121.94	1718.8 - 1722.2	13.25 - 13.4
6.31175 - 6.31225	123 - 138	2200 - 2300	14.47 - 14.5
8.291 - 8.294	149.9 - 150.05	2310 - 2390	15.35 - 16.2
8.362 - 8.366	156.52475 - 156.52525	2483.5 - 2500	17.7 - 21.4
8.37625 - 8.38675	156.7 - 156.9	2690 - 2900	22.01 - 23.12
8.41425 - 8.41475	162.0125 - 167.17	3260 - 3267	23.6 - 24.0
12.29 - 12.293	167.72 - 173.2	3332 - 3339	31.2 - 31.8
12.51975 - 12.52025	240 - 285	3345.8 - 3358	36.43 - 36.5
12.57675 - 12.57725	322 - 335.4	3600 - 4400	(²)

- Remark:
1. Emission level in dBuV/m=20 log (uV/m)
 2. Measurement was performed at an antenna to the closed point of EUT distance of meters.
 3. Only spurious frequency is permitted to locate within the Restricted Bands specified in provision of § 15.205, and the emissions located in restricted bands also comply with 15.209 limit.

3. Summary of Test Results

FCC Rule	Description Of Test	Result
15.207	AC Power Conducted Emission	Pass
15.209	Radiated Emission	Pass
2.1049	20dB Bandwidth	Pass

4. CONDUCTED EMISSION TEST

4.1 Applicable Standard

According to FCC Part 15.207(a)

4.2 Conformance Limit

Frequency(MHz)	Conducted Emission Limit	
	Quasi-peak	Average
0.15-0.5	66-56	56-46
0.5-5.0	56	46
5.0-30.0	60	50

Note: 1. The lower limit shall apply at the transition frequencies

2. The limit decreases in line with the logarithm of the frequency in the range of 0.15 to 0.50MHz.

4.3 Test Configuration

Test according to clause 7.3 conducted emission test setup

4.4 Test Procedure

The EUT was placed on a table which is 0.8m above ground plane.

Maximum procedure was performed on the highest emissions to ensure EUT compliance.

Repeat above procedures until all frequency measured were complete.

4.5 Measurement Equipment Used:

EQUIPMENT TYPE	MFR	MODEL NUMBER	SERIAL NUMBER	LASTCAL.	DUE CAL.
Test Receiver	Rohde & Schwarz	ESCI	26115-010-0027	May 19, 2018	May 18, 2019
L.I.S.N.	Rohde & Schwarz	ENV216	101161	May 19, 2018	May 18, 2019
50Ω Coaxial Switch	Anritsu	MP59B	6100175589	May 20, 2018	May 19, 2019
Voltage Probe	Rohde & Schwarz	ESH2-Z3	100122	May 20, 2018	May 19, 2019
Pulse Limiter	Rohde & Schwarz	ESH3-Z2	100006	May 19, 2018	May 18, 2019
I.S.N	Teseq GmbH	ISN T800	30327	May 20, 2018	May 19, 2019

4.6 Test Result

Pass

AC 120V &240V voltage have been tested, and the worst result recorded was report as below:

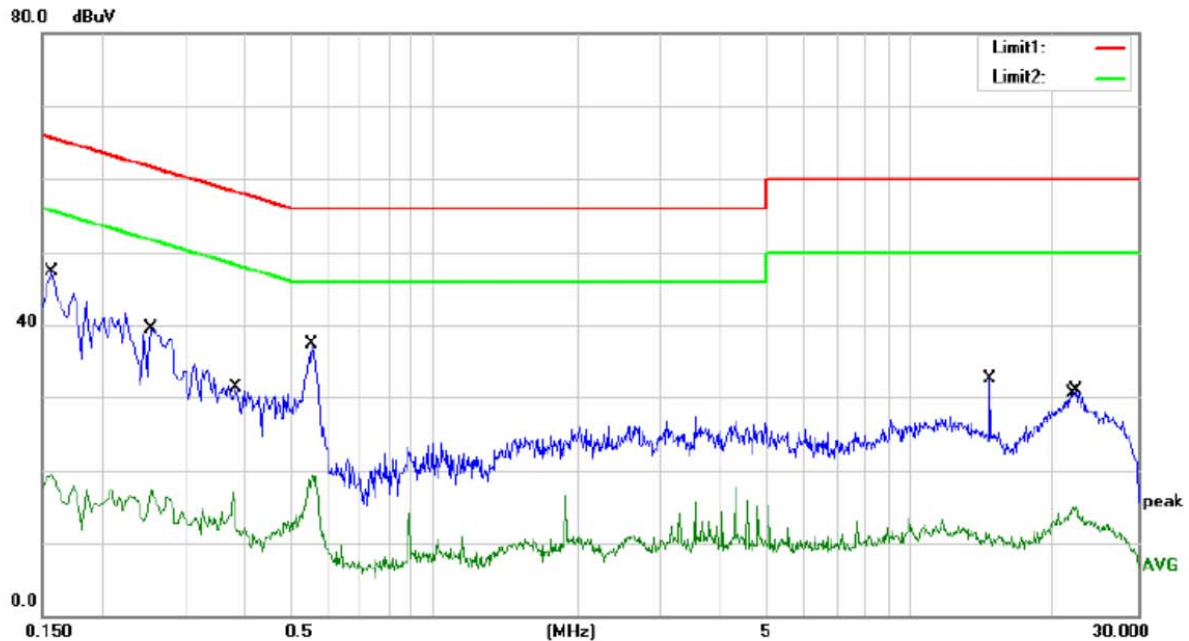

Site Conduction #1 Phase: **N** Temperature: 24.9
 Limit: (CE)FCC PART 15 class B_QP Power: AC 120V/60Hz Humidity: 54 %
 Mode: 125KHz TX
 Note:

No.	Mk.	Freq. MHz	Reading Level dBuV	Correct Factor dB	Measure- ment dBuV	Limit dBuV	Over dB	Detector	Comment
1	*	0.1580	37.66	9.56	47.22	65.57	-18.35	QP	
2		0.1580	9.67	9.56	19.23	55.57	-36.34	AVG	
3		0.2540	29.88	9.56	39.44	61.63	-22.19	QP	
4		0.2540	7.82	9.56	17.38	51.63	-34.25	AVG	
5		0.3780	23.17	9.57	32.74	58.32	-25.58	QP	
6		0.3780	7.33	9.57	16.90	48.32	-31.42	AVG	
7		0.5540	27.70	9.57	37.27	56.00	-18.73	QP	
8		0.5540	9.72	9.57	19.29	46.00	-26.71	AVG	
9		14.6820	22.57	9.89	32.46	60.00	-27.54	QP	
10		14.6820	1.91	9.89	11.80	50.00	-38.20	AVG	
11		21.7940	4.15	9.99	14.14	50.00	-35.86	AVG	
12		22.2180	20.83	10.00	30.83	60.00	-29.17	QP	

*:Maximum data x:Over limit !:over margin Comment: Factor build in receiver. Operator:kk

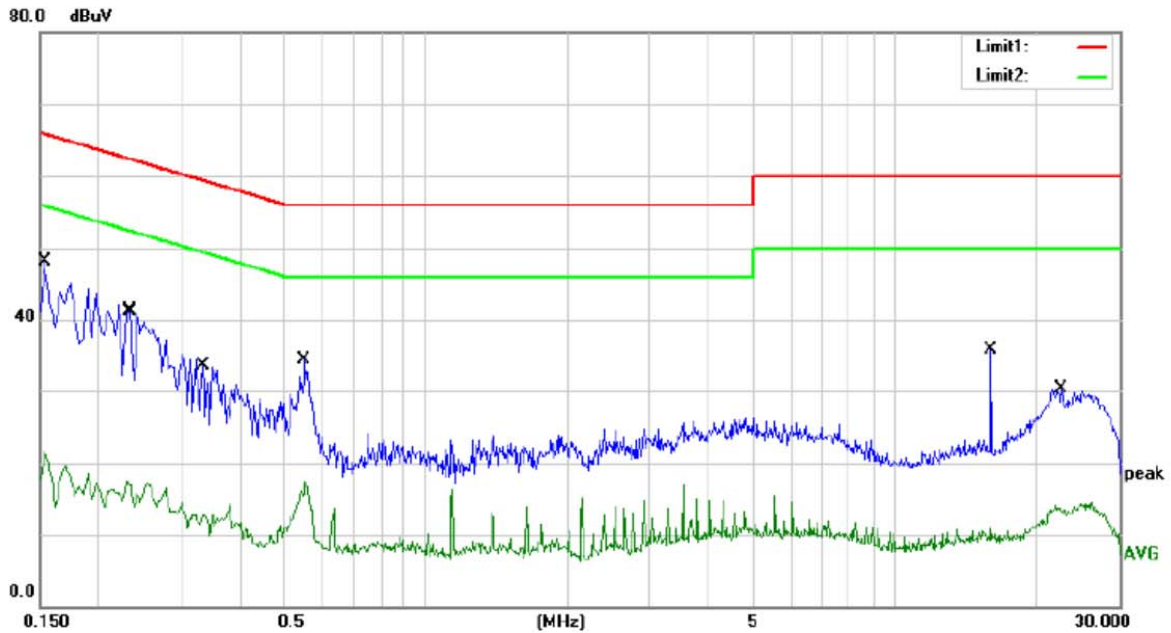

Site Conduction #1

Phase: **L1**

Temperature: 24.9

Limit: (CE)FCC PART 15 class B_QP

Power: AC 120V/60Hz

Humidity: 54 %

Mode: 125KHz TX

Note:

No.	Mk.	Freq. MHz	Reading Level dBuV	Correct Factor dB	Measure- ment dBuV	Limit dBuV	Over dB	Detector	Comment
1	*	0.1540	38.46	9.56	48.02	65.78	-17.76	QP	
2		0.1540	11.94	9.56	21.50	55.78	-34.28	AVG	
3		0.2300	7.92	9.56	17.48	52.45	-34.97	AVG	
4		0.2340	31.68	9.56	41.24	62.31	-21.07	QP	
5		0.3340	24.00	9.57	33.57	59.35	-25.78	QP	
6		0.3340	4.41	9.57	13.98	49.35	-35.37	AVG	
7		0.5500	24.67	9.57	34.24	56.00	-21.76	QP	
8		0.5500	7.73	9.57	17.30	46.00	-28.70	AVG	
9		15.9900	25.71	9.91	35.62	60.00	-24.38	QP	
10		15.9900	0.94	9.91	10.85	50.00	-39.15	AVG	
11		22.6100	20.38	10.00	30.38	60.00	-29.62	QP	
12		22.6100	4.30	10.00	14.30	50.00	-35.70	AVG	

*:Maximum data x:Over limit !:over margin Comment: Factor build in receiver. Operator:kk

5. Radiated Emission Test

5.1 Measurement Procedure

1. The EUT was placed on a turn table which is 0.8m above ground plane.
2. Maximum procedure was performed on the six highest emissions to ensure EUT compliance.
3. And also, each emission was to be maximized by changing the polarization of receiving antenna both horizontal and vertical.
4. Repeat above procedures until all frequency measured was complete.

When spectrum scanned from 9KHz to 150KHz setting resolution bandwidth 200Hz and video bandwidth 1kHz.

EMI Test Receiver	Setting
Attenuation	Auto
RB	200Hz
VB	1kHz
Detector	QP
Trace	Max hold

When spectrum scanned from 150KHz to 30MHz setting resolution bandwidth 9 kHz and video bandwidth 30kHz.

EMI Test Receiver	Setting
Attenuation	Auto
RB	9kHz
VB	30kHz
Detector	QP
Trace	Max hold

When spectrum scanned from 30 MHz to 1GHz setting resolution bandwidth 120 kHz and video bandwidth 300kHz.

EMI Test Receiver	Setting
Attenuation	Auto
RB	120kHz
VB	300kHz
Detector	QP
Trace	Max hold

5.2 Test SET-UP (Block Diagram of Configuration)

(A) Radiated Emission Test Set-Up, Frequency Below 30MHz

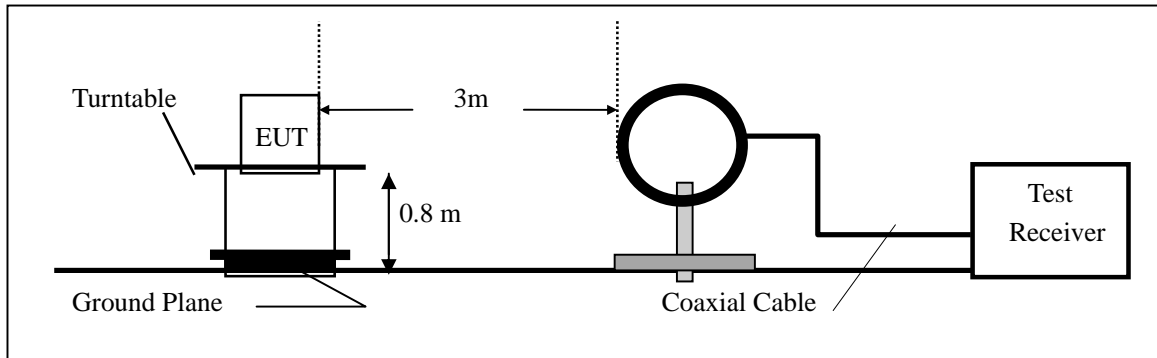

(B) Radiated Emission Test Set-Up, Frequency Below 1000MHz

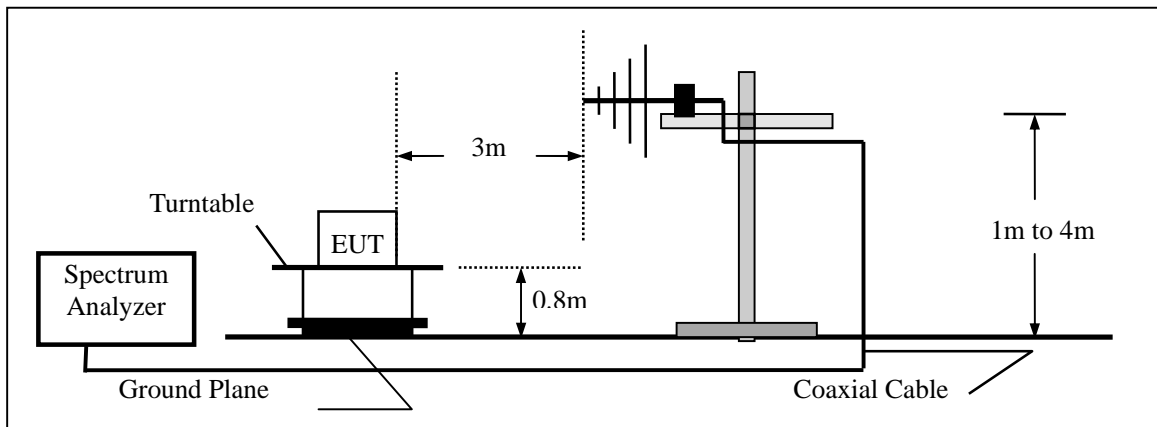

5.3 Measurement Equipment Used:

EQUIPMENT TYPE	MFR	MODEL NUMBER	SERIAL NUMBER	LAST CAL.	DUE CAL.
EMI Test Receiver	Rohde & Schwarz	ESU	1302.6005.26	May 20, 2018	May 19, 2019
Pre-Amplifier	HP	8447F	2944A07999	May 19, 2018	May 18, 2019
Bilog Antenna	Schwarzbeck	VULB9163	142	May 19, 2018	May 18, 2019
Loop Antenna	ARA	PLA-1030/B	1029	May 19, 2018	May 18, 2019
Horn Antenna	Schwarzbeck	BBHA 9170	BBHA9170399	May 20, 2018	May 19, 2019
Horn Antenna	Schwarzbeck	BBHA 9120	D143	May 19, 2018	May 18, 2019
Cable	Schwarzbeck	AK9513	ACRX1	May 20, 2018	May 19, 2019
Cable	Rosenberger	N/A	FP2RX2	May 20, 2018	May 19, 2019
Cable	Schwarzbeck	AK9513	CRPX1	May 20, 2018	May 19, 2019
Cable	Schwarzbeck	AK9513	CRRX2	May 20, 2018	May 19, 2019

5.4 Measurement Result

Pass, see the following page

For 9 kHz – 0.15MHz

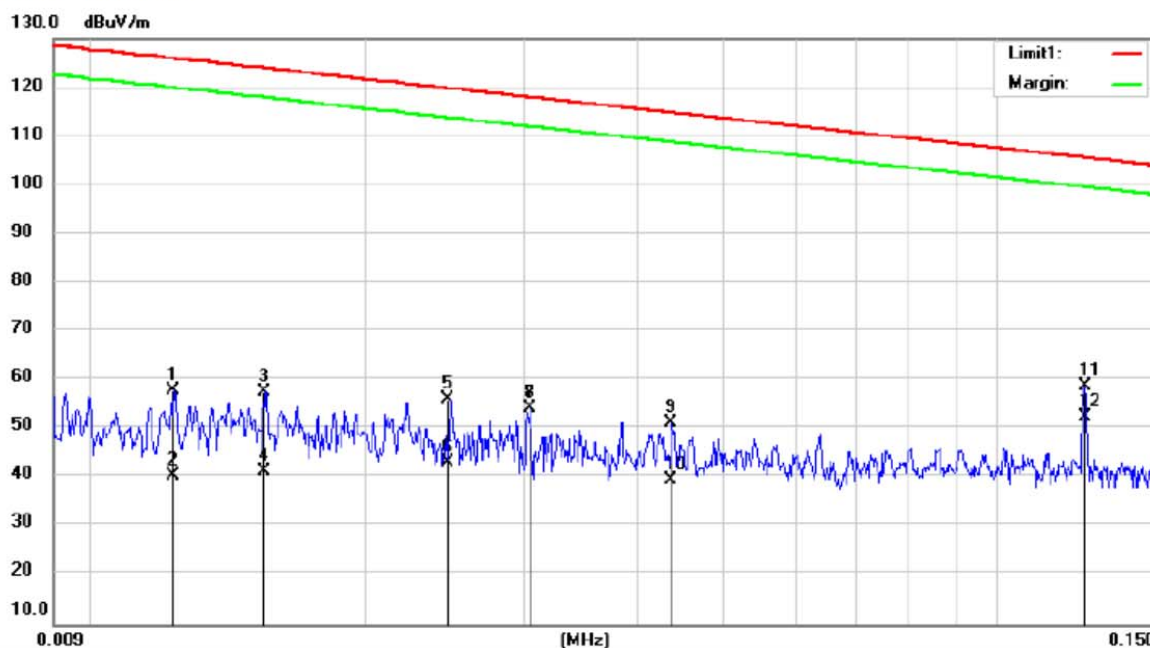

Site 3m Chamber #1 Polarization: X Temperature: 27 C
 Limit: (RE)FCC PART 15.209(9K-30M) Power: AC 120V/60Hz Humidity: 49 %
 Mode: 125KHz
 Note:

No.	Mk.	Freq. MHz	Reading Level dBuV	Correct Factor dB	Measure- ment dBuV/m	Limit dBuV/m	Over dB	Detector	Antenna Height cm	Table Degree	Comment
1		0.0122	36.79	20.91	57.70	125.86	-68.16	peak			
2		0.0122	19.41	20.91	40.32	125.86	-85.54	AVG			
3		0.0154	36.76	20.84	57.60	123.84	-66.24	peak			
4		0.0154	20.52	20.84	41.36	123.84	-82.48	AVG			
5		0.0246	35.19	20.84	56.03	119.77	-63.74	peak			
6		0.0246	22.36	20.84	43.20	119.77	-76.57	AVG			
7		0.0303	33.20	20.94	54.14	117.96	-63.82	peak			
8		0.0303	33.20	20.94	54.14	117.96	-63.82	AVG			
9		0.0434	30.02	21.17	51.19	114.84	-63.65	peak			
10		0.0434	18.39	21.17	39.56	114.84	-75.28	AVG			
11	*	0.1255	37.58	21.04	58.62	105.62	-47.00	peak			
12		0.1255	31.37	21.04	52.41	105.62	-53.21	AVG			

*:Maximum data x:Over limit !:over margin

Operator: ZL

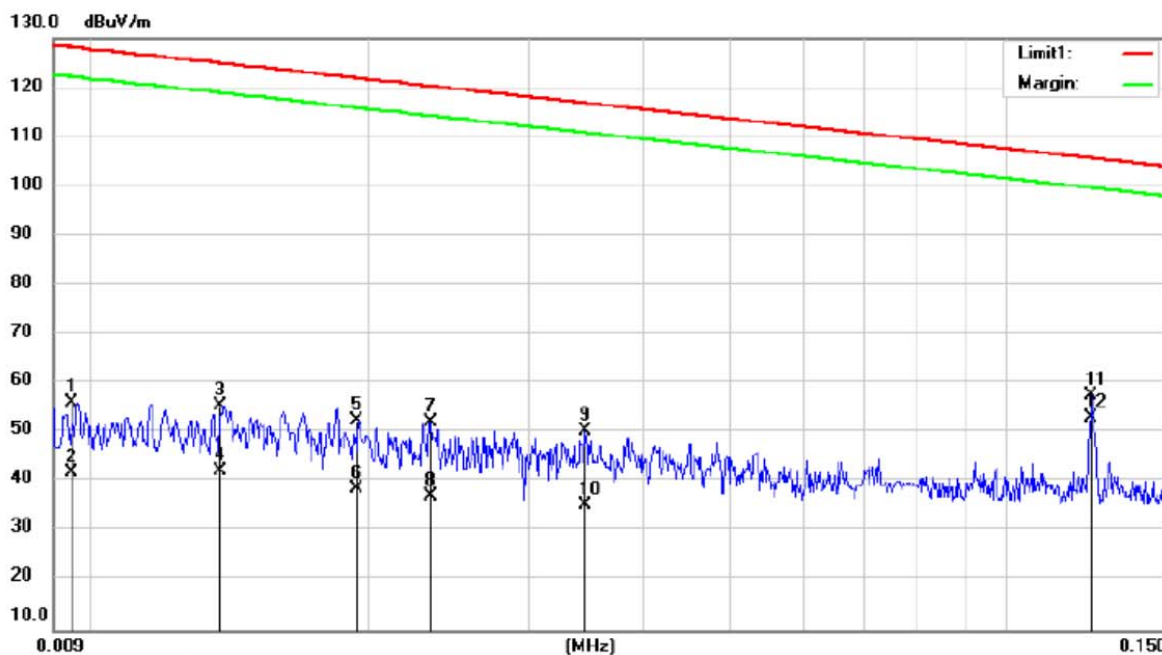

Site 3m Chamber #1 Polarization: Y Temperature: 27 C
 Limit: (RE)FCC PART 15.209(9K-30M) Power: AC 120V/60Hz Humidity: 49 %
 Mode: 125KHz
 Note:

No.	Mk.	Freq. MHz	Reading Level dBuV	Correct Factor dB	Measurement dBuV/m	Limit dBuV/m	Over dB	Detector	Antenna Height cm	Table Degree	Comment
1		0.0094	35.14	20.95	56.09	128.12	-72.03	peak			
2		0.0094	21.08	20.95	42.03	128.12	-86.09	AVG			
3		0.0137	34.50	20.88	55.38	124.85	-69.47	peak			
4		0.0137	21.36	20.88	42.24	124.85	-82.61	AVG			
5		0.0194	31.77	20.77	52.54	121.83	-69.29	peak			
6		0.0194	17.75	20.77	38.52	121.83	-83.31	AVG			
7		0.0233	31.28	20.81	52.09	120.24	-68.15	peak			
8		0.0233	16.27	20.81	37.08	120.24	-83.16	AVG			
9		0.0345	29.32	21.01	50.33	116.83	-66.50	peak			
10		0.0345	14.25	21.01	35.26	116.83	-81.57	AVG			
11	*	0.1242	36.62	21.04	57.66	105.71	-48.05	peak			
12		0.1242	32.00	21.04	53.04	105.71	-52.67	AVG			

*:Maximum data x:Over limit !:over margin

Operator: ZL

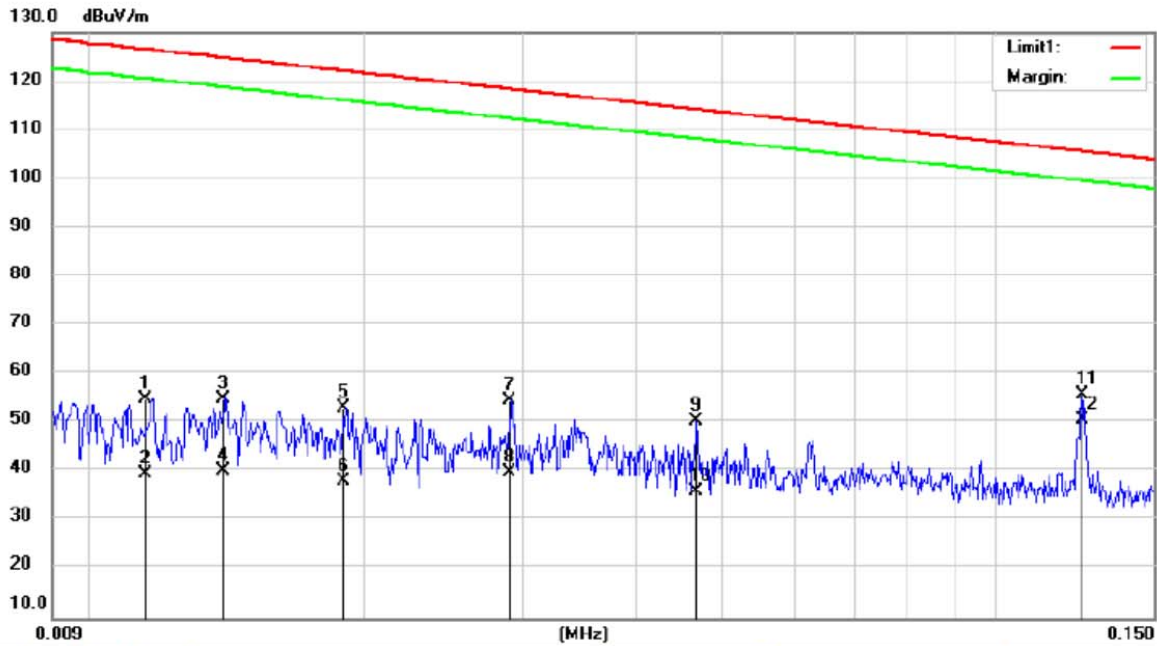

Site: 3m Chamber #1 Polarization: **Z** Temperature: 27 C
 Limit: (RE)FCC PART 15.209(9K-30M) Power: AC 120V/60Hz Humidity: 49 %
 Mode: 125KHz
 Note:

No.	Mk.	Freq. MHz	Reading Level dBuV	Correct Factor dB	Measure- ment dBuV/m	Limit dBuV/m	Over dB	Antenna Height cm	Table Degree	Comment
1		0.0114	34.00	20.92	54.92	126.45	-71.53			peak
2		0.0114	18.71	20.92	39.63	126.45	-86.82			AVG
3		0.0140	34.09	20.87	54.96	124.66	-69.70			peak
4		0.0140	19.38	20.87	40.25	124.66	-84.41			AVG
5		0.0190	32.17	20.78	52.95	122.01	-69.06			peak
6		0.0190	17.21	20.78	37.99	122.01	-84.02			AVG
7		0.0290	33.69	20.92	54.61	118.34	-63.73			peak
8		0.0290	18.95	20.92	39.87	118.34	-78.47			AVG
9		0.0466	29.01	21.22	50.23	114.22	-63.99			peak
10		0.0466	14.80	21.22	36.02	114.22	-78.20			AVG
11	*	0.1250	34.59	21.04	55.63	105.66	-50.03			peak
12		0.1250	29.72	21.04	50.76	105.66	-54.90			AVG

*:Maximum data x:Over limit !:over margin Operator: ZL

Note: the Fundamental Emission is less than the spurious emission Limit, the bandage test is not need.

For 0.15MHz – 30MHz

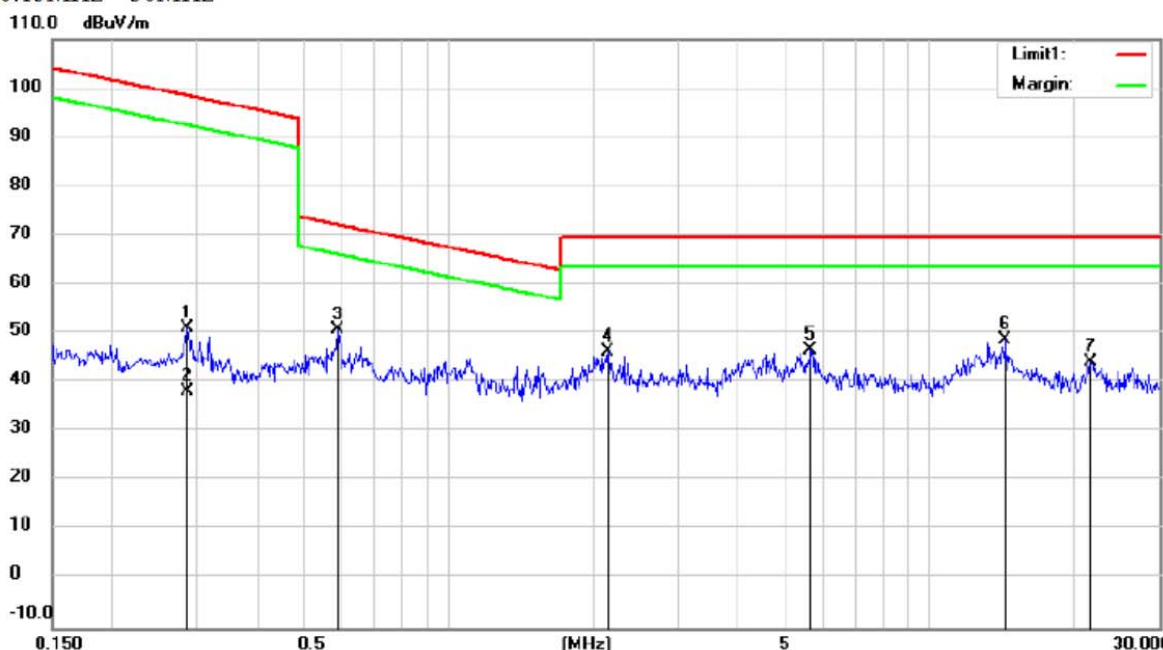

Site 3m Chamber #1 Polarization: X Temperature: 27 C
 Limit: (RE)FCC PART 15.209(9K-30M) Power: AC 120V/60Hz Humidity: 49 %
 Mode: 125KHz
 Note:

No.	Mk.	Freq.	Reading Level	Correct Factor	Measurement	Limit	Over	Antenna Height	Table Degree	
		MHz	dBuV	dB	dBuV/m	dBuV/m	dB	cm	degree	Comment
1		0.2862	29.84	21.27	51.11	98.47	-47.36			peak
2		0.2862	16.98	21.27	38.25	98.47	-60.22			AVG
3		0.5885	29.40	21.25	50.65	72.21	-21.56			QP
4		2.1440	25.37	20.90	46.27	69.50	-23.23			QP
5		5.6531	25.69	20.83	46.52	69.50	-22.98			QP
6	*	14.3640	28.30	20.31	48.61	69.50	-20.89			QP
7		21.6001	24.18	19.90	44.08	69.50	-25.42			QP

*:Maximum data x:Over limit !:over margin

Operator: ZL

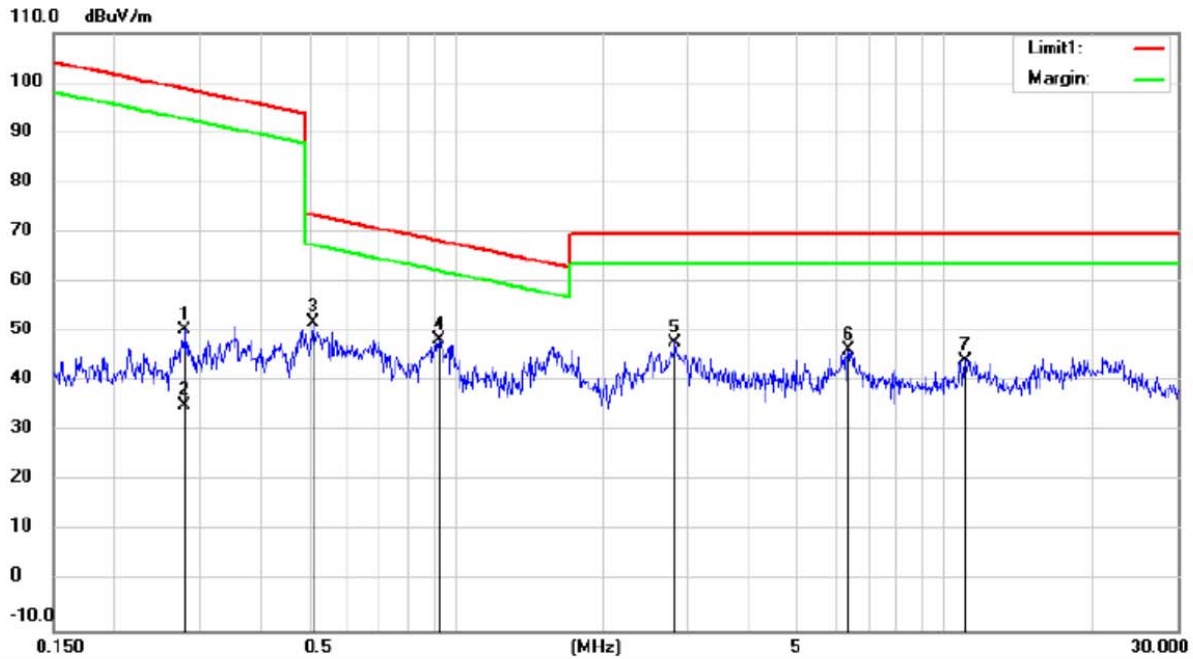

Site 3m Chamber #1 Polarization: Y Temperature: 27 C
 Limit: (RE)FCC PART 15.209(9K-30M) Power: AC 120V/60Hz Humidity: 49 %
 Mode: 125KHz
 Note:

No.	Mk.	Freq.	Reading Level	Correct Factor	Measurement	Limit	Over	Antenna Height	Table Degree	
		MHz	dBuV	dB	dBuV/m	dBuV/m	dB	cm	degree	Comment
1		0.2787	29.30	21.27	50.57	98.70	-48.13			peak
2		0.2787	13.99	21.27	35.26	98.70	-63.44			AVG
3		0.5100	30.58	21.28	51.86	73.45	-21.59			QP
4	*	0.9233	27.05	21.21	48.26	68.31	-20.05			QP
5		2.8090	27.09	20.72	47.81	69.50	-21.69			QP
6		6.3520	25.41	20.82	46.23	69.50	-23.27			QP
7		11.0211	23.50	20.68	44.18	69.50	-25.32			QP

*:Maximum data x:Over limit !:over margin

Operator: ZL

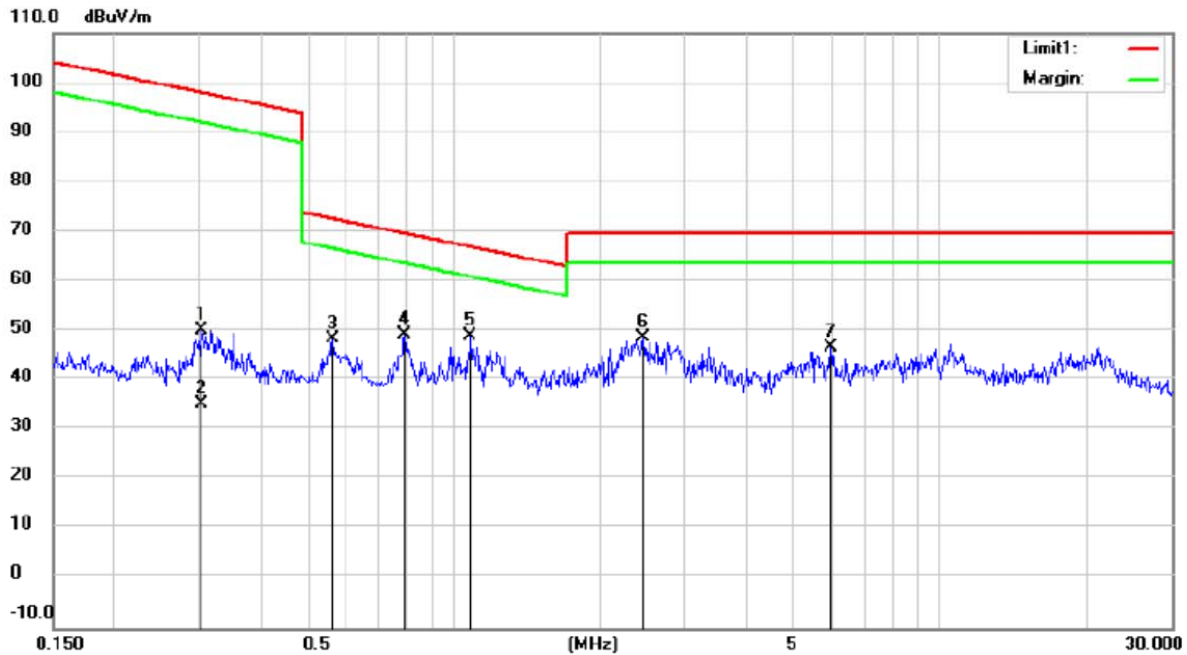

Site 3m Chamber #1 Polarization: **Z** Temperature: 27 C
 Limit: (RE)FCC PART 15.209(9K-30M) Power: AC 120V/60Hz Humidity: 49 %
 Mode: 125KHz
 Note:

No.	Mk.	Freq. MHz	Reading Level dBuV	Correct Factor dB	Measure- ment dBuV/m	Limit dBuV/m	Over dB	Detector	Antenna Height cm	Table Degree	Comment
1		0.3034	28.88	21.27	50.15	97.96	-47.81	peak			
2		0.3034	13.99	21.27	35.26	97.96	-62.70	AVG			
3		0.5640	27.18	21.25	48.43	72.58	-24.15	QP			
4		0.7914	28.14	21.20	49.34	69.65	-20.31	QP			
5	*	1.0823	27.76	21.19	48.95	66.94	-17.99	QP			
6		2.4474	27.87	20.82	48.69	69.50	-20.81	QP			
7		5.9607	25.61	20.82	46.43	69.50	-23.07	QP			

*:Maximum data x:Over limit !:over margin

Operator: ZL

For 30MHz – 1GHz

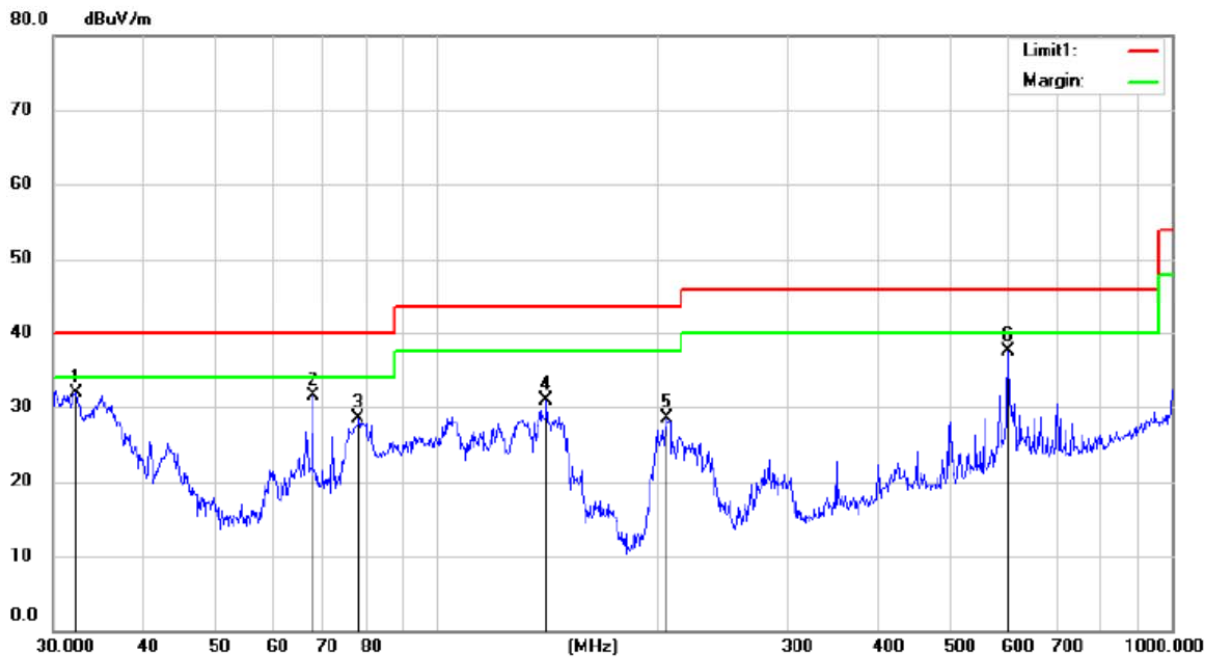

Site 3m Chamber #3

Polarization: *Vertical*

Temperature: 24C

Limit: (RE)FCC PART 15C

Power: AC 120V/60Hz

Humidity: 51%

Mode: TX 125kHz

Note:

No.	Mk.	Freq. MHz	Reading Level dBuV	Correct Factor dB	Measure- ment dBuV/m	Limit dBuV/m	Over dB	Detector	Antenna Height cm	Table Degree degree	Comment
1	*	32.2246	48.74	-16.81	31.93	40.00	-8.07	QP			
2		67.7938	48.78	-17.24	31.54	40.00	-8.46	QP			
3		78.2485	48.15	-19.68	28.47	40.00	-11.53	QP			
4		140.9338	50.09	-19.18	30.91	43.50	-12.59	QP			
5		206.1082	43.99	-15.55	28.44	43.50	-15.06	QP			
6		600.1624	43.17	-5.62	37.55	46.00	-8.45	QP			

*:Maximum data x:Over limit !:over margin

Operator: LQZ

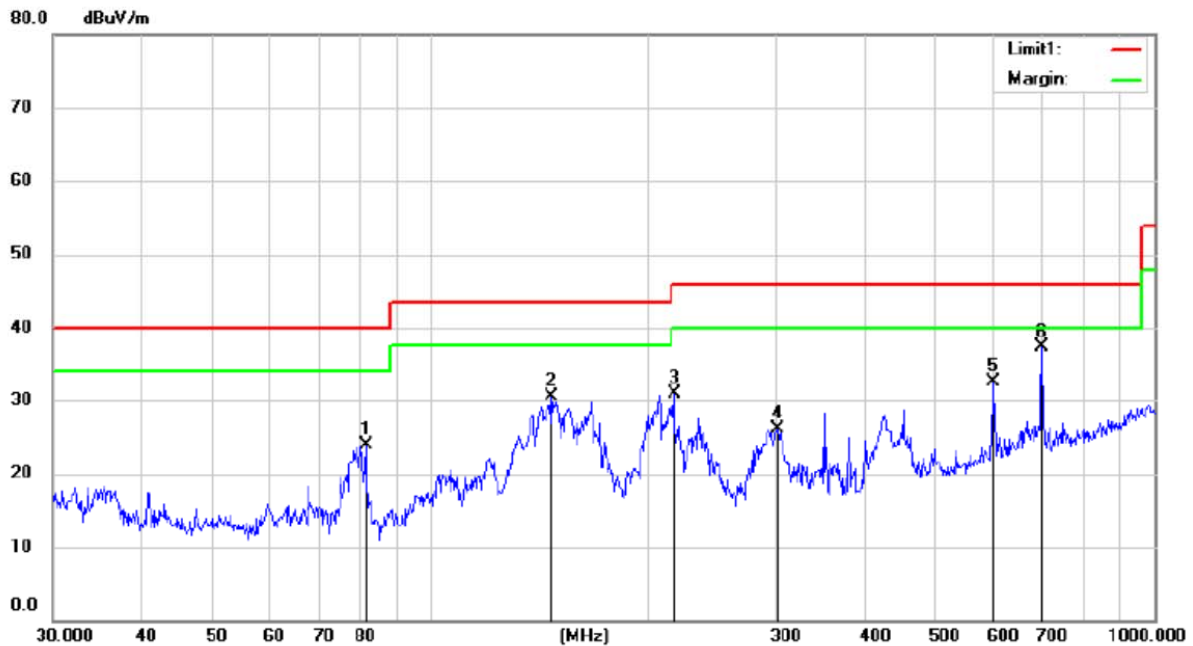

Site: 3m Chamber #3 Polarization: **Horizontal** Temperature: 24C
 Limit: (RE)FCC PART 15C Power: AC 120V/60Hz Humidity: 51%
 Mode: TX 125kHz
 Note:

No.	Mk.	Freq. MHz	Reading Level dBuV	Correct Factor dB	Measure- ment dBuV/m	Limit dBuV/m	Over dB	Detector	Antenna Height cm	Table Degree	Comment
1		81.3542	40.58	-16.65	23.93	40.00	-16.07	QP			
2		146.7332	49.73	-19.31	30.42	43.50	-13.08	QP			
3		217.0110	46.23	-15.32	30.91	46.00	-15.09	QP			
4		301.4223	38.78	-12.70	26.08	46.00	-19.92	QP			
5		600.1624	38.20	-5.62	32.58	46.00	-13.42	QP			
6	*	700.0406	41.62	-4.31	37.31	46.00	-8.69	QP			

*:Maximum data x:Over limit !:over margin

Operator: LQZ

6. 20DB BANDWIDTH

6.1 Applicable Standard

According to FCC Part 2.1049

6.2 Conformance Limit

No limit requirement.

6.3 Test Configuration

Test according to clause 6.1 radio frequency test setup 1

6.4 Test Procedure

The EUT was operating in transmit mode and controlled its channel. Printed out the test result from the spectrum by hard copy function.

The RF output of EUT was connected to the spectrum analyzer by RF cable and attenuator. The path loss was compensated to the results for each measurement.

Set to the maximum power setting and enable the EUT transmit continuously

Set RBW = 1% occupied bandwidth (3 kHz).

Set the video bandwidth (VBW) =3 times RBW (10 kHz).

Set Span= approximately 2 to 4 times the occupied bandwidth

Set Detector = Peak.

Set Trace mode = max hold.

Set Sweep = auto couple.

The EUT should be transmitting at its maximum data rate. Allow the trace to stabilize. Use the marker-to-peak function to set the marker to the peak of the emission. Use the marker-delta function to measure 20dB down one side of the emission. Reset the markerdelta function, and move the marker to the other side of the emission, until it is (as close as possible to) even with the reference marker level. The marker-delta reading at this point is the 20dB bandwidth of the emission.

If this value varies with different modes of operation (e.g., data rate, modulation format, etc.), repeat this test for each variation.

Measure and record the results in the test report.

6.5 Test Results

Temperature :	28°C	Test By:	Andy
Humidity :	65 %		

Modulation Mode	Channel Number	Channel Frequency (kHz)	20dB Bandwidth (kHz)	Limit (kHz)	Verdict
ASK	0	125	9.84	N/A	PASS
Note: N/A (Not Applicable)					

Test Model 125kHz 20dB Bandwidth ASK Modulation

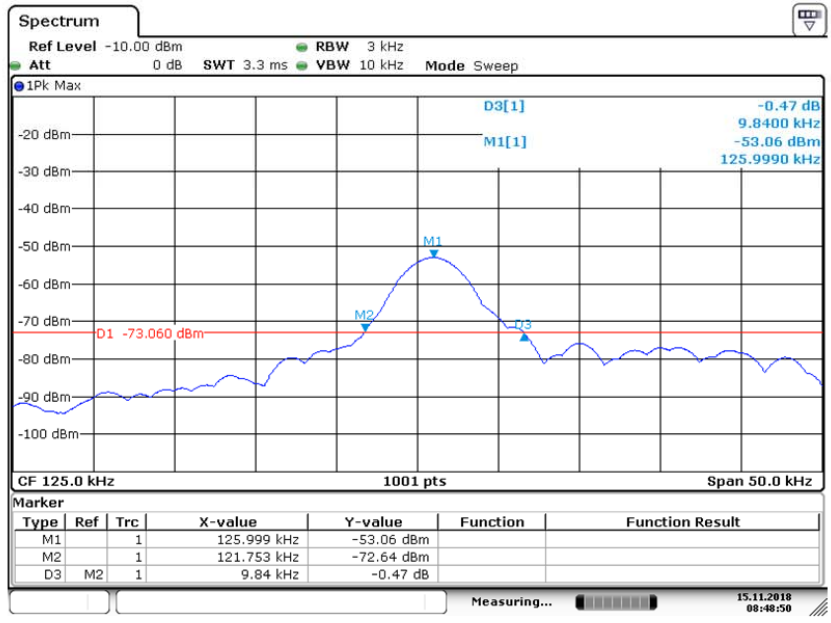

Date: 15.NOV.2018 08:48:50

7. Antenna Application

Antenna Requirement

Standard	Requirement
FCC CRF Part 15.203	An intentional radiator shall be designed to ensure that no antenna other than that furnished by the responsible party shall be used with the device. The use of a permanently attached antenna or of an antenna that uses a unique coupling to the intentional radiator shall be considered sufficient to comply with the provisions of this section. The manufacturer may design the unit so that a broken antenna can be replaced by the user, but the use of a standard antenna jack or electrical connector is prohibited. This requirement does not apply to carrier current devices or to devices operated under the provisions of §15.211, §15.213, §15.217, §15.219, or §15.221. Further, this requirement does not apply to intentional radiators that must be professionally installed, such as perimeter protection systems and some field disturbance sensors, or to other intentional radiators which, in accordance with §15.31(d), must be measured at the installation site. However, the installer shall be responsible for ensuring that the proper antenna is employed so that the limits in this part are not exceeded.

For intentional device, according to FCC 47 CFR Section 15.203, an intentional radiator shall be designed to ensure that no antenna other than that furnished by the responsible party shall be used with the device. if transmitting antennas of directional gain greater than 6dBi are used, the power shall be reduced by the amount in dB that the directional gain of the antenna exceeds 6dBi.

Result

PASS.

- Note:
- Antenna use a permanently attached antenna which is not replaceable.
 - Not using a standard antenna jack or electrical connector for antenna replacement
 - The antenna has to be professionally installed (please provide method of installation)

Which in accordance to section 15.203, please refer to the internal photos