

TEST REPORT

Product Name : RS485 Fingerprint Reader
Model Number : FR1500S、FR1500A、FR1500A-WP、
FR1500、FR1500-WP
FCC ID : 2AJ9T-FR1500SM

Prepared for : ZKTECO CO.,LTD.
Address : No.26,Pingshan 188 Industry zone,Tangxia
Town,Dongguan City,Guangdong Province,China 523728

Prepared by : EMTEK (SHENZHEN) CO., LTD.
Address : Building 69, Majialong Industry Zone, Nanshan District,
Shenzhen, Guangdong, China

Tel: (0755) 26954280
Fax: (0755) 26954282

Report Number : ES201023037W
Date(s) of Tests : Nov. 06, 2020 to Nov. 13, 2020
Date of issue : Nov. 15, 2020

Table of Contents

1	EUT TECHNICAL DESCRIPTION	4
2	SUMMARY OF TEST RESULT	5
3	TEST METHODOLOGY	6
3.1	GENERAL DESCRIPTION OF APPLIED STANDARDS	6
3.2	MEASUREMENT EQUIPMENT USED	6
3.3	DESCRIPTION OF TEST MODES	7
4	FACILITIES AND ACCREDITATIONS	8
4.1	FACILITIES	8
4.2	LABORATORY ACCREDITATIONS AND LISTINGS	8
5	TEST SYSTEM UNCERTAINTY	9
6	SETUP OF EQUIPMENT UNDER TEST	10
6.1	RADIO FREQUENCY TEST SETUP 1	10
6.2	RADIO FREQUENCY TEST SETUP 2	10
6.3	CONDUCTED EMISSION TEST SETUP	11
6.4	BLOCK DIAGRAM CONFIGURATION OF TEST SYSTEM	12
6.5	SUPPORT EQUIPMENT	12
7	TEST REQUIREMENTS	13
7.1	OCCUPIED BANDWIDTH	13
7.2	FREQUENCY STABILITY	15
7.3	RADIATED SPURIOUS EMISSION	17
7.4	CONDUCTED EMISSION TEST	30
8	ANTENNA APPLICATION	33
8.2	RESULT	33

TEST RESULT CERTIFICATION

Applicant : ZKTECO CO.,LTD.
 Address : No.26,Pingshan 188 Industry zone,Tangxia Town,Dongguan City,Guangdong Province,China 523728
 Manufacturer : ZKTECO CO.,LTD.
 Address : No.26,Pingshan 188 Industry zone,Tangxia Town,Dongguan City,Guangdong Province,China 523728
 EUT : RS485 Fingerprint Reader
 Model Name : FR1500S、FR1500A、FR1500A-WP、FR1500、FR1500-WP (All models covered in this report are the same with each other, except for different model No.,We choose FR1500S as the final test prototype)
 Trademark : N/A

Measurement Procedure Used:

APPLICABLE STANDARDS	
STANDARD	TEST RESULT
FCC 47 CFR Part 2, Subpart J FCC 47 CFR Part 15, Subpart C	PASS

The above equipment was tested by EMTEK(SHENZHEN) CO., LTD. The test data, data evaluation, test procedures, and equipment configurations shown in this report were made in accordance with the procedures given in ANSI C63.10 (2013) and the energy emitted by the sample EUT tested as described in this report is in compliance with the requirements of FCC Rules Part 2 and Part 15.225.

The test results of this report relate only to the tested sample identified in this report.

Date of Test : Nov. 06, 2020 to Nov. 13, 2020

Prepared by : 
Lance Li/Editor

Reviewer : 
Sewen Guo /Supervisor

Approve & Authorized Signer : 
Lisa Wang/Manager



1 EUT TECHNICAL DESCRIPTION

Characteristics	Description
Device Type:	RFID
Modulation:	ASK modulation
Test sample	1#
Operating Frequency Range(s):	13.553-13.567MHz
Channel Frequency:	13.56MHz
Number of Channels:	1 channel
Antenna Type :	PCB antenna
Antenna Gain :	0.5 dBi
Power Supply	DC12V from adapter
Test Voltage	AC 120V/60Hz
Adapter	Model :ADS-40SI-12-3 Input:AC100-240V,50/60Hz,1.0A Max Output:DC12V,3.0A
Temperature Range	-20°C ~ +50°C

Note: for more details, please refer to the User's manual of the EUT.

2 SUMMARY OF TEST RESULT

FCC Part Clause	Test Parameter	Verdict	Remark
2.1049	Occupied Bandwidth	PASS	
15.225(e)	Frequency stability	PASS	
15.225(d) 15.209	Radiated Spurious Emissions	PASS	
15.207	Conducted Emission	PASS	
NOTE1: N/A (Not Applicable)			

RELATED SUBMITTAL(S) / GRANT(S):

This submittal(s) (test report) is intended for FCC ID: 2AJ9T-FR1500SM filing to comply with Section 15.225 of the FCC Part 15, Subpart C Rules.



3 TEST METHODOLOGY

3.1 GENERAL DESCRIPTION OF APPLIED STANDARDS

According to its specifications, the EUT must comply with the requirements of the following standards:
FCC 47 CFR Part 2, Subpart J
FCC 47 CFR Part 15, Subpart C

3.2 MEASUREMENT EQUIPMENT USED

3.2.1 Conducted Emission Test Equipment

EQUIPMENT TYPE	MFR	MODEL NUMBER	SERIAL NUMBER	LAST CAL.	Due. CAL
Test Receiver	Rohde & Schwarz	ESCS30	828985/018	05/17/2020	05/16/2021
L.I.S.N.	Schwarzbeck	NNLK8129	8129203	05/17/2020	05/16/2021
50Ω Coaxial Switch	Anritsu	MP59B	M20531	N/A	N/A

3.2.2 Radiated Emission Test Equipment

EQUIPMENT TYPE	MFR	MODEL NUMBER	SERIAL NUMBER	LAST CAL.	Due. CAL
EMI Test Receiver	Rohde & Schwarz	ESU	1302.6005.26	05/17/2020	05/16/2021
Pre-Amplifier	HP	8447D	2944A07999	05/17/2020	05/16/2021
Bilog Antenna	Schwarzbeck	VULB9163	142	05/17/2020	05/16/2021
Loop Antenna	ARA	PLA-1030/B	1029	05/17/2020	05/16/2021
Cable	Schwarzbeck	AK9513	ACRX1	05/17/2020	05/16/2021
Cable	Rosenberger	N/A	FP2RX2	05/17/2020	05/16/2021
Cable	Schwarzbeck	AK9513	CRPX1	05/17/2020	05/16/2021
Cable	Schwarzbeck	AK9513	CRRX2	05/17/2020	05/16/2021

3.2.3 Radio Frequency Test Equipment

EQUIPMENT TYPE	MFR	MODEL NUMBER	SERIAL NUMBER	LAST CAL.	Due. CAL
Spectrum Analyzer	Agilent	E4407B	88156318	05/17/2020	05/16/2021
Signal Analyzer	Agilent	N9010A	My53470879	05/17/2020	05/16/2021
Power meter	Anritsu	ML2495A	0824006	05/17/2020	05/16/2021
Power sensor	Anritsu	MA2411B	0738172	05/17/2020	05/16/2021

Remark: Each piece of equipment is scheduled for calibration once a year.

3.3 DESCRIPTION OF TEST MODES

The EUT has been tested under its typical operating condition.

The EUT configuration for testing is installed on RF field strength measurement to meet the Commissions requirement and operating in a manner which intends to maximize its emission characteristics in a continuous normal application.

The Transmitter was operated in the normal operating mode. The TX frequency was fixed which was for the purpose of the measurements.

Pre-defined engineering program for regulatory testing used to control the EUT for staying in continuous transmitting mode is programmed.



4 FACILITIES AND ACCREDITATIONS

4.1 FACILITIES

All measurement facilities used to collect the measurement data are located at

Building 69, Majialong Industry Zone District, Nanshan District, Shenzhen, China

The sites are constructed in conformance with the requirements of ANSI C63.7, ANSI C63.10 and CISPR Publication 22.

4.2 LABORATORY ACCREDITATIONS AND LISTINGS

Site Description

EMC Lab. : Accredited by CNAS, 2018.11.30
The certificate is valid until 2022.10.28
The Laboratory has been assessed and proved to be in compliance with CNAS-CL01:2006 (identical to ISO/IEC 17025:2017)
The Certificate Registration Number is L2291

Accredited by FCC
Designation Number: CN1204
Test Firm Registration Number: 882943
Accredited by A2LA, August 25, 2020
The Certificate Registration Number is 4321.01

Accredited by Industry Canada, November 09, 2018
The Certificate Registration Number is CN0008

Name of Firm : EMTEK(SHENZHEN) CO., LTD.
Site Location : Building 69, Majialong Industry Zone,
Nanshan District, Shenzhen, Guangdong, China

5 TEST SYSTEM UNCERTAINTY

The following measurement uncertainty levels have been estimated for tests performed on the apparatus:

Parameter	Uncertainty
Radio Frequency	$\pm 1 \times 10^{-5}$
Conducted Emissions Test	$\pm 2.0 \text{ dB}$
Radiated Emission Test	$\pm 2.0 \text{ dB}$
Occupied Bandwidth Test	$\pm 1.0 \text{ dB}$
All emission, radiated	$\pm 3 \text{ dB}$
Temperature	$\pm 0.5^\circ \text{C}$
Humidity	$\pm 3\%$

Measurement Uncertainty for a level of Confidence of 95%



6 SETUP OF EQUIPMENT UNDER TEST

6.1 RADIO FREQUENCY TEST SETUP 1

The component's antenna ports(s) of the EUT are connected to the measurement instrument per an appropriate attenuator. The EUT is controlled by PC/software to emit the specified signals for the purpose of measurements.

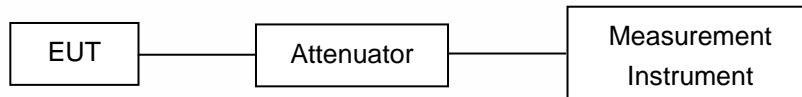

6.2 RADIO FREQUENCY TEST SETUP 2

The test site semi-anechoic chamber has met the requirement of NSA tolerance 4 dB according to the standards: ANSI C63.10. The test distance is 3m. The setup is according to the requirements in Section 13.1.4.1 of ANSI C63.10-2013 and CAN/CSA-CEI/IEC CISPR 22.

Below 30MHz:

The EUT is placed on a turntable 0.8 meters above the ground in the chamber, 3 meter away from the antenna (loop antenna). The Antenna should be positioned with its plane vertical at the specified distance from the EUT and rotated about its vertical axis for maximum response at each azimuth about the EUT. The center of the loop shall be 1 m above the ground. For certain applications, the loop antenna plane may also need to be positioned horizontally at the specified distance from the EUT.

Above 30MHz:

The EUT is placed on a turntable 0.8 meters above the ground in the chamber, 3 meter away from the antenna. The maximal emission value is acquired by adjusting the antenna height, polarisation and turntable azimuth. Normally, the height range of antenna is 1 m to 4 m, the azimuth range of turntable is 0° to 360°, and the receive antenna has two polarizations Vertical (V) and Horizontal (H).

(a) Radiated Emission Test Set-Up, Frequency Below 30MHz

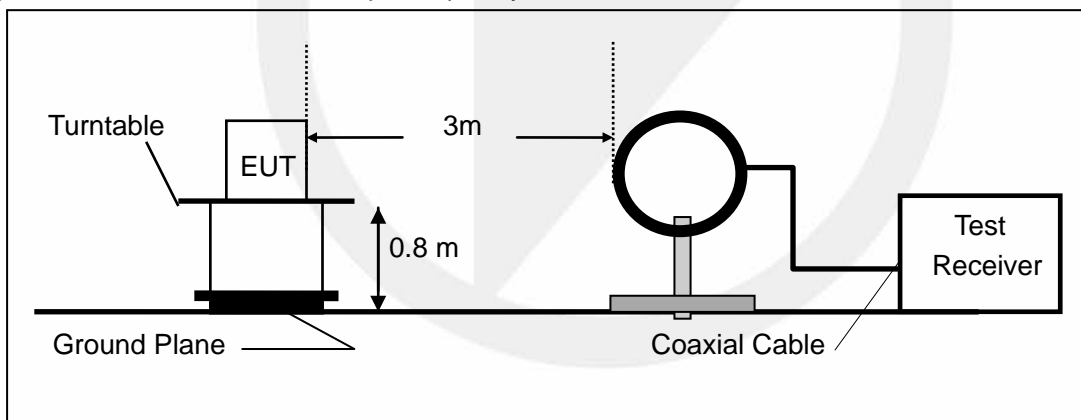

(b) Radiated Emission Test Set-Up, Frequency Below 1000MHz

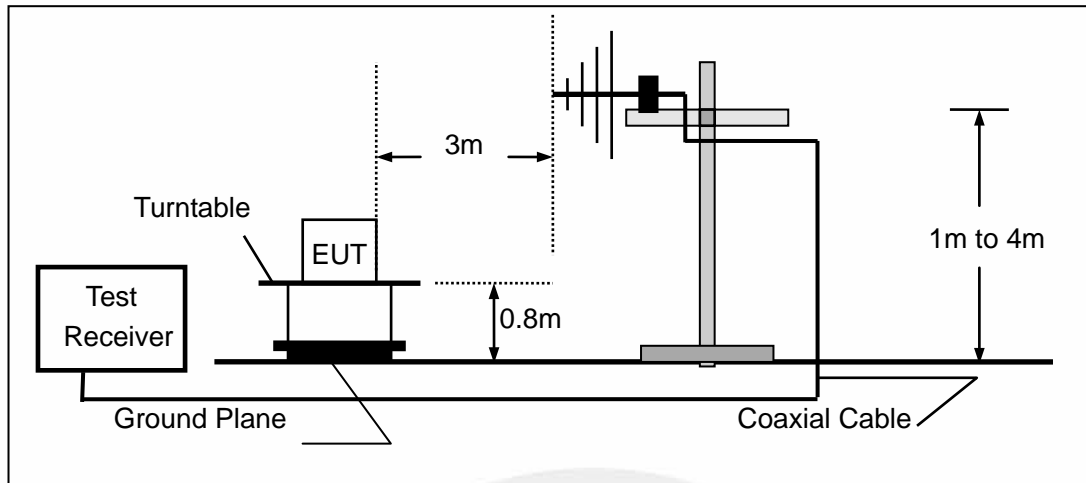

6.3 CONDUCTED EMISSION TEST SETUP

The mains cable of the EUT (maybe per AC/DC Adapter) must be connected to LISN. The LISN shall be placed 0.8 m from the boundary of EUT and bonded to a ground reference plane for LISN mounted on top of the ground reference plane. This distance is between the closest points of the LISN and the EUT. All other units of the EUT and associated equipment shall be at least 0.8m from the LISN. Ground connections, where required for safety purposes, shall be connected to the reference ground point of the LISN and, where not otherwise provided or specified by the manufacturer, shall be of same length as the mains cable and run parallel to the mains connection at a separation distance of not more than 0.1 m.

According to the requirements in ANSI C63.10-2013 Conducted emissions from the EUT measured in the frequency range between 0.15 MHz and 30 MHz using CISPR Quasi-Peak and average detector mode.

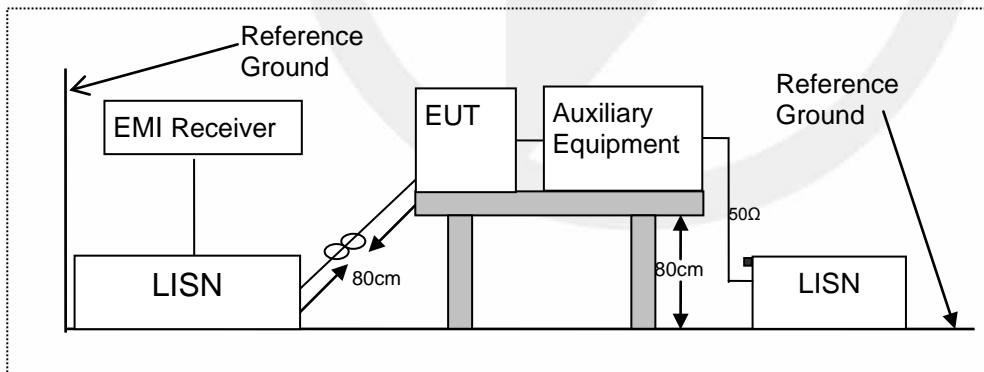

6.4 BLOCK DIAGRAM CONFIGURATION OF TEST SYSTEM

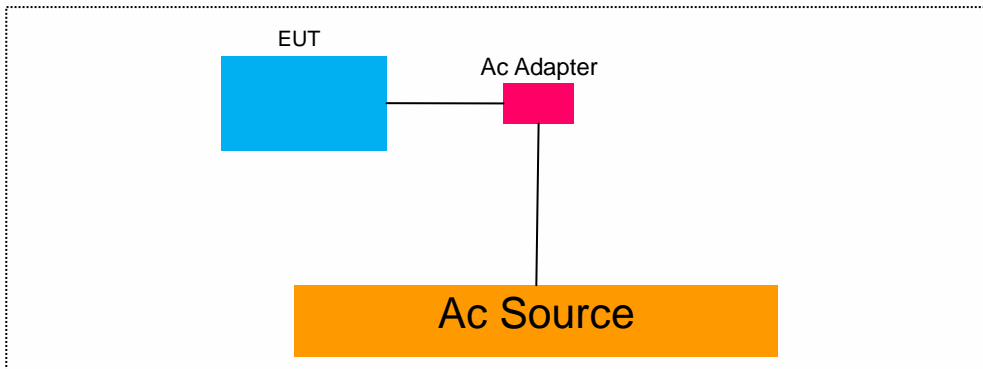

6.5 SUPPORT EQUIPMENT

EUT Cable List and Details			
Cable Description	Length (m)	Shielded/Unshielded	With / Without Ferrite
/	/	/	/
/	/	/	/

Auxiliary Cable List and Details			
Cable Description	Length (m)	Shielded/Unshielded	With / Without Ferrite
/	/	/	/

Auxiliary Equipment List and Details			
Description	Manufacturer	Model	Serial Number
/	/	/	/

Notes:

1. All the equipment/cables were placed in the worst-case configuration to maximize the emission during the test.
2. Grounding was established in accordance with the manufacturer's requirements and conditions for the intended use.
3. Unless otherwise denoted as EUT in 『Remark』 column , device(s) used in tested system is a support equipment

7 TEST REQUIREMENTS

7.1 OCCUPIED BANDWIDTH

7.1.1 Applicable Standard

According to FCC Part 2.1049

7.1.2 Conformance Limit

No limit requirement.

7.1.3 Test Configuration

Test according to clause 6.1 radio frequency test setup 1

7.1.4 Test Procedure

The EUT was operating in transmit mode and controlled its channel. Printed out the test result from the spectrum by hard copy function.

The RF output of EUT was connected to the spectrum analyzer by RF cable and attenuator. The path loss was compensated to the results for each measurement.

Set to the maximum power setting and enable the EUT transmit continuously

Set RBW = 1% occupied bandwidth(30Hz).

Set the video bandwidth (VBW) =3 times RBW .

Set Span= approximately 2 to 3 times the occupied bandwidth

Set Detector = Peak.

Set Trace mode = max hold.

Set Sweep = auto couple.

The EUT should be transmitting at its maximum data rate. Allow the trace to stabilize. Use the marker-to-peak function to set the marker to the peak of the emission. Use the marker-delta function to measure 99% down one side of the emission. Reset the markerdelta function, and move the marker to the other side of the emission, until it is (as close as possible to) even with the reference marker level. The marker-delta reading at this point is the 99% bandwidth of the emission.

If this value varies with different modes of operation (e.g., data rate, modulation format, etc.), repeat this test for each variation.

Measure and record the results in the test report.

7.1.5 Test Results

Temperature :	25°C	Test Date :	
Humidity :	65 %	Test By:	XW

Modulation Mode	Channel Number	Channel Frequency (MHz)	Measurement Bandwidth (kHz)	Limit (kHz)	Verdict
ASK	0	13.56	2.171	N/A	PASS
Note: N/A (Not Applicable)					

Test Model Occupied Bandwidth ASK Modulation
 Channel 0: 13.56MHz

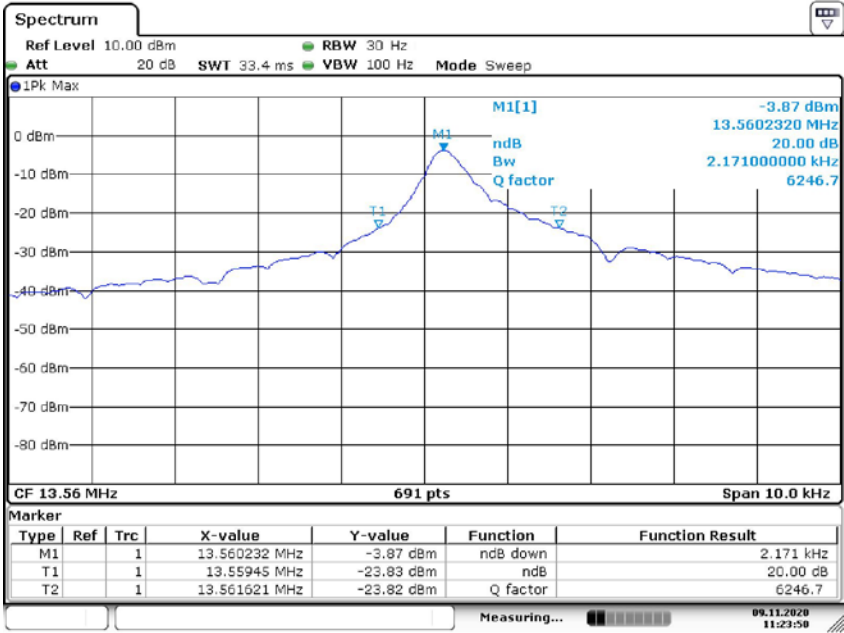

Date: 9.NOV.2020 11:23:50



7.2 FREQUENCY STABILITY

7.2.1 Applicable Standard

According to FCC Part 2.1055

7.2.2 Conformance Limit

According to part 15.225(e), The frequency tolerance of the carrier signal shall be maintained within $\pm 0.01\%$ of the operating frequency over a temperature variation of -20 degrees to $+50$ degrees C at normal supply voltage, and for a variation in the primary supply voltage from 85% to 115% of the rated supply voltage at a temperature of 20 degrees C. For battery operated equipment, the equipment tests shall be performed using a new battery.

7.2.3 Test Configuration

Test according to clause 6.1 radio frequency test setup

7.2.4 Test Procedures

Connect the EUT to frequency analyzer via the antenna connector.
EUT was placed at temperature chamber and connected to an external power supply.
Temperature and voltage condition shall be tested to confirm frequency stability.

(a) Frequency measurements shall be made at the extremes of the specified temperature range and at intervals of not more than 10° centigrade through the range. A period of time sufficient to stabilize all of the components of the oscillator circuit at each temperature level shall be allowed prior to frequency measurement. The short-term transient effects on the frequency of the transmitter due to keying (except for broadcast transmitters) and any heating element cycling normally occurring at each ambient temperature level also shall be shown. Only the portion or portions of the transmitter containing the frequency determining and stabilizing circuitry need be subjected to the temperature variation test.

(b) The frequency stability shall be measured with variation of primary supply voltage as follows:

(1) Vary primary supply voltage from 85 to 115 percent of the nominal value for other than hand carried battery equipment.

(2) For hand carried, battery powered equipment, reduce primary supply voltage to the battery operating end point, which shall be specified by the manufacturer.

7.2.5 Test Results

Operation Mode	Channel Number	Test Condition		Channel Frequency (MHz)	Freq.Dev. (Hz)	Deviation (ppm)	Limit (ppm)
		Voltage (V)	Temp (°C)				
ASK	CH0	Vnom	-20	13.560044	44	3.24	100
			-10	13.560095	95	7.01	100
			0	13.560117	117	8.63	100
			10	13.560109	109	8.04	100
			20	13.560064	64	4.72	100
			30	13.560083	83	6.12	100
			40	13.560105	105	7.74	100
			50	13.560112	112	8.26	100
		85% Vnom	20	13.560029	29	2.14	100
		115% Vnom	20	13.560077	77	5.68	100
VERDICT				PASS			

7.3 RADIATED SPURIOUS EMISSION

7.3.1 Applicable Standard

According to FCC Part 15.225 and 15.209

7.3.2 Conformance Limit

Field Strength of Fundamental Emissions and Spectrum Mask					
Emissions	($\mu\text{V/m}$)@30m	(dB $\mu\text{V/m}$)@30m	(dB $\mu\text{V/m}$)@10m	(dB $\mu\text{V/m}$)@3m	(dB $\mu\text{V/m}$)@1m
Fundamental	15848	84.0	103.1	124.0	143.1
Quasi peak measurement of the fundamental.					

Spectrum Mask					
Freq. of Emission (MHz)	($\mu\text{V/m}$)@30m	(dB $\mu\text{V/m}$)@30m	(dB $\mu\text{V/m}$)@10m	(dB $\mu\text{V/m}$)@3m	(dB $\mu\text{V/m}$)@1m
1.705~13.110	30	29.5	48.6	69.5	88.6
13.110~13.410	106	40.5	59.6	80.5	99.6
13.410~13.553	334	50.5	69.6	90.5	109.6
13.553~13.567	15848	84.0	103.1	124.0	143.1
13.567~13.710	334	50.5	69.6	90.5	109.6
13.710~14.010	106	40.5	59.6	80.5	99.6
14.010~30.000	30	29.5	48.6	69.5	88.6

According to FCC Part 15.205, Restricted bands

MHz	MHz	MHz	GHz
0.090-0.110	16.42-16.423	399.9-410	4.5-5.15
10.495-0.505	16.69475-16.69525	608-614	5.35-5.46
2.1735-2.1905	16.80425-16.80475	960-1240	7.25-7.75
4.125-4.128	25.5-25.67	1300-1427	8.025-8.5
4.17725-4.17775	37.5-38.25	1435-1626.5	9.0-9.2
4.20725-4.20775	73-74.6	1645.5-1646.5	9.3-9.5
6.215-6.218	74.8-75.2	1660-1710	10.6-12.7
6.26775-6.26825	123-138	2200-2300	14.47-14.5
8.291-8.294	149.9-150.05	2310-2390	15.35-16.2
8.362-8.366	156.52475-156.52525	2483.5-2500	17.7-21.4
8.37625-8.38675	156.7-156.9	2690-2900	22.01-23.12
8.41425-8.41475	162.0125-167.17	3260-3267	23.6-24.0
12.29-12.293	167.72-173.2	3332-3339	31.2-31.8
12.51975-12.52025	240-285	3345.8-3358	36.43-36.5
12.57675-12.57725	322-335.4	3600-4400	(2)
13.36-13.41			

According to FCC Part 15.205, the level of any transmitter spurious emission in Restricted bands shall not exceed the level of the emission specified in the following table

Restricted Frequency(MHz)	Field Strength ($\mu\text{V/m}$)	Field Strength (dB $\mu\text{V/m}$)	Measurement Distance
0.009-0.490	2400/F(KHz)	48.5 - 13.8	300
0.490-1.705	24000/F(KHz)	33.8 - 23.0	30
1.705-30	30	29.5	30
30-88	100	40.0	3
88-216	150	43.5	3
216-960	200	46.0	3
Above 960	500	54.0	3

7.3.3 Test Configuration

Test according to clause 6.2 radio frequency test setup 2

7.3.4 Test Procedure

This test is required for any spurious emission that falls in a Restricted Band, as defined in Section 15.205. It must be performed with the highest gain of each type of antenna proposed for use with the EUT. Use the following spectrum analyzer settings:

The EUT was placed on a turn table which is 0.8m above ground plane.

Maximum procedure was performed on the highest emissions to ensure EUT compliance.

Span = wide enough to fully capture the emission being measured

RBW = 100 kHz for $f < 1$ GHz(30MHz to 1GHz), 200Hz for $f < 150$ KHz(9KHz to 150KHz), 9KHz for $f < 30$ MHz(150KHz to 30KHz)

VBW \geq RBW

Sweep = auto

Detector function = peak

Trace = max hold

Follow the guidelines in ANSI C63.10-2013 with respect to maximizing the emission by rotating the EUT, measuring the emission while the EUT is situated in three orthogonal planes (if appropriate), adjusting the measurement antenna height and polarization, etc. A pre-amp and a high pass filter are required for this test, in order to provide the measuring system with sufficient sensitivity. Allow the trace to stabilize. The peak reading of the emission, after being corrected by the antenna factor, cable loss, pre-amp gain, etc., is the peak field strength, which must comply with the limit specified in Section 15.35(b). Submit this data.

Now set the VBW to 10 Hz, while maintaining all of the other instrument settings. This peak level, once corrected, must comply with the limit specified in Section 15.209. If the dwell time per channel of the hopping signal is less than 100 ms, then the reading obtained with the 10 Hz VBW may be further adjusted by a "duty cycle correction factor", derived from $20\log(\text{dwell time}/100 \text{ ms})$, in an effort to demonstrate compliance with the 15.209 limit. Submit this data.

Repeat above procedures until all frequency measured was complete.

7.3.5 Test Results

Field Strength of Fundamental Emissions and Spectrum Mask

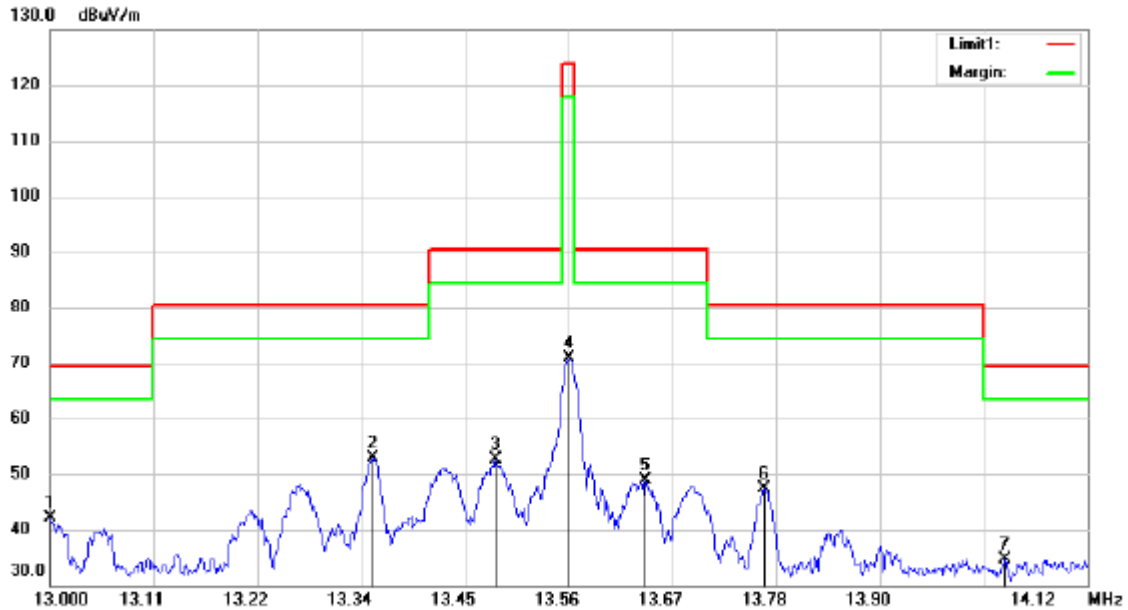

Site 3m Chamber #1

Polarization: X

Temperature: 29.5 C

Limit: (RE)FCC PART 15.225(Mask)

Power: AC 120V/60Hz

Humidity: 48 %

Mode:13.56MHZ

Note:

No.	Mk.	Freq. MHz	Reading Level dBuV	Correct Factor dB	Measure- ment dBuV/m	Limit dBuV/m	Over dB	Detector	Antenna Height cm	Table Degree degree	Comment
1	*	13.0000	21.85	20.22	42.07	69.50	-27.43	peak			
2		13.3483	32.59	20.21	52.80	80.50	-27.70	peak			
3		13.4816	32.32	20.21	52.53	90.50	-37.97	peak			
4		13.5611	50.64	20.21	70.85	124.00	-53.15	peak			
5		13.6428	28.70	20.21	48.91	90.50	-41.59	peak			
6		13.7705	27.09	20.20	47.29	80.50	-33.21	peak			
7		14.0315	14.31	20.20	34.51	69.50	-34.99	peak			

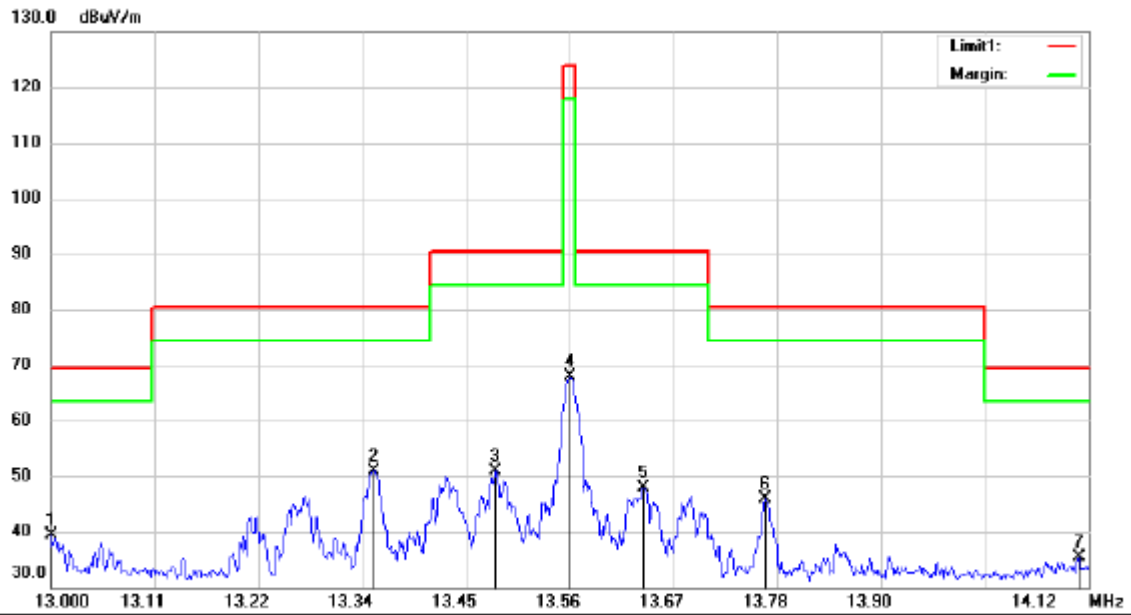

Site: 3m Chamber #1 Polarization: Temperature: 29.5 C
 Limit: (RE) FCC PART 15.225(Mask) Power: AC 120V/60Hz Humidity: 48 %
 Mode: 13.56MHZ
 Note:

No.	Mk.	Freq.	Reading Level	Correct Factor	Measurement	Limit	Over	Antenna Height	Table Degree	
		MHz	dBuV	dB	dBuV/m	dBuV/m	dB	cm	degree	Comment
1		13.0000	19.18	20.22	39.40	69.50	-30.10			peak
2	*	13.3483	30.77	20.21	50.98	80.50	-29.52			peak
3		13.4804	30.61	20.21	50.82	90.50	-39.68			peak
4		13.5600	47.62	20.21	67.83	124.00	-56.17			peak
5		13.6395	27.73	20.21	47.94	90.50	-42.56			peak
6		13.7716	25.65	20.20	45.85	80.50	-34.65			peak
7		14.1100	15.13	20.20	35.33	69.50	-34.17			peak

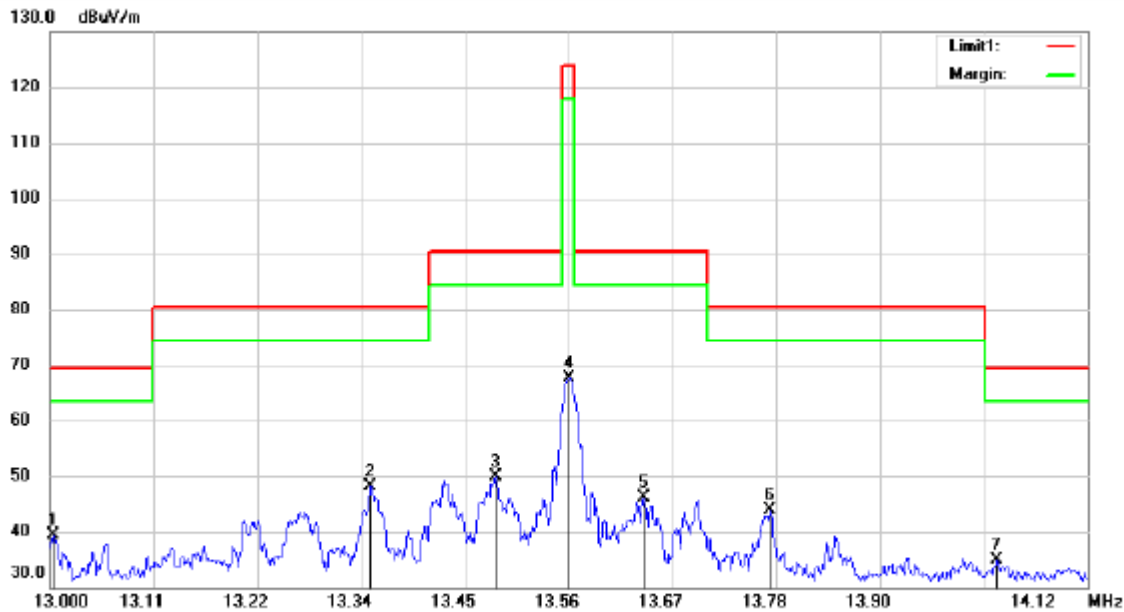

Site: 3m Chamber #1 Polarization: Z Temperature: 29.5 C
 Limit: (RE) FCC PART 15.225(Mask) Power: AC 120V/60Hz Humidity: 48 %
 Mode: 13.56MHZ
 Note:

No.	Mk.	Freq.	Reading Level	Correct Factor	Measurement	Limit	Over	Antenna Height	Table Degree	Comment
		MHz	dBuV	dB	dBuV/m	dBuV/m	dB	cm	degree	
1	*	13.0034	19.05	20.22	39.27	69.50	-30.23	peak		
2		13.3461	28.03	20.21	48.24	80.50	-32.26	peak		
3		13.4816	29.57	20.21	49.78	90.50	-40.72	peak		
4		13.5600	47.54	20.21	67.75	124.00	-56.25	peak		
5		13.6406	25.94	20.21	46.15	90.50	-44.35	peak		
6		13.7773	23.65	20.20	43.85	80.50	-36.65	peak		
7		14.0226	14.70	20.20	34.90	69.50	-34.60	peak		

■ Spurious Emission below 150kHz (9KHz to 150kHz)

All mode have been tested, and the worst result was report as below:

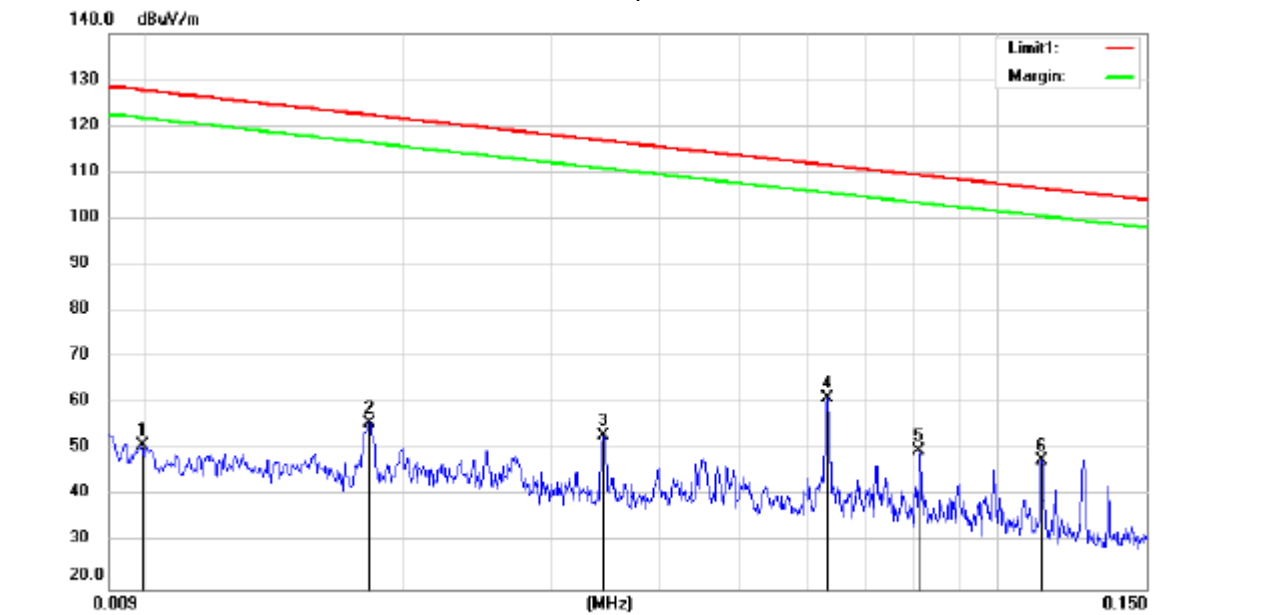

Site: 3m Chamber #1 Polarization: X Temperature: 29.5 C
 Limit: (RE)FCC PART 15.209(9K-30M) Power: AC 120V/60Hz Humidity: 48 %
 Mode: 13.56MHZ
 Note:

No.	Mk.	Freq.	Reading Level	Correct Factor	Measurement	Limit	Over	Antenna Height	Table Degree	
		MHz	dBuV	dB	dBuV/m	dBuV/m	dB	cm	degree	Comment
1		0.0098	30.33	20.61	50.94	127.76	-76.82			peak
2		0.0182	35.24	20.59	55.83	122.39	-66.56			peak
3		0.0343	32.46	20.63	53.09	116.89	-63.80			peak
4	*	0.0631	40.62	20.72	61.34	111.59	-50.25			peak
5		0.0810	29.19	20.69	49.88	109.43	-59.55			peak
6		0.1130	26.92	20.72	47.64	106.54	-58.90			peak

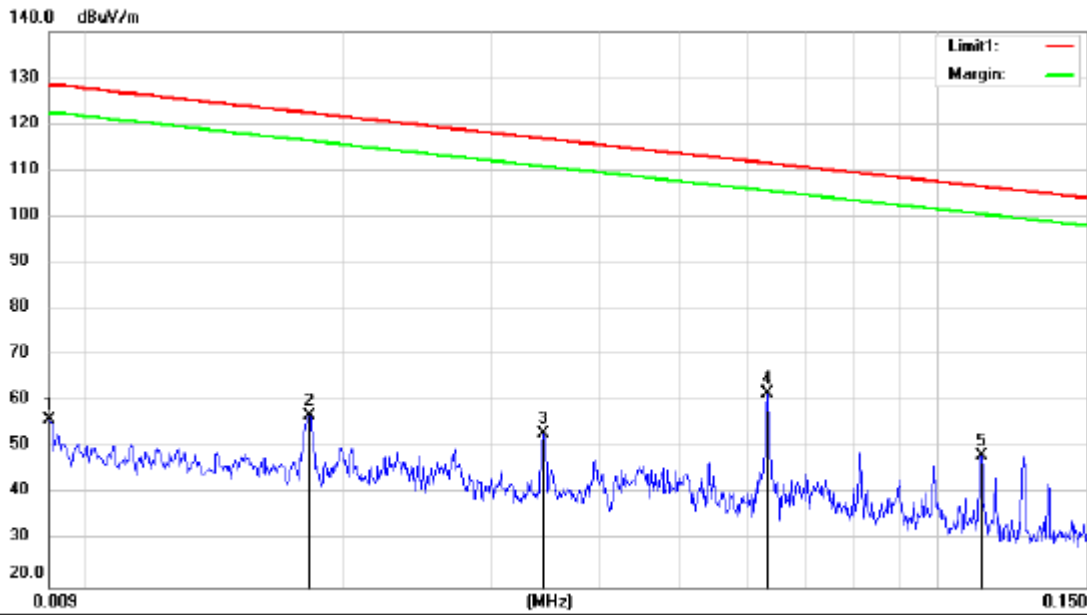

Site: 3m Chamber #1 Polarization: **Y** Temperature: 29.5 C
 Limit: (RE)FCC PART 15.209(9K-30M) Power: AC 120V/60Hz Humidity: 48 %
 Mode: 13.56MHz
 Note:

No.	Mk.	Freq.	Reading Level	Correct Factor	Measurement	Limit	Over	Antenna Height	Table Degree	Comment
		MHz	dBuV	dB	dBuV/m	dBuV/m	dB	cm	degree	
1		0.0090	35.36	20.69	56.05	128.50	-72.45			peak
2		0.0182	36.45	20.59	57.04	122.39	-65.35			peak
3		0.0343	32.55	20.63	53.18	116.89	-63.71			peak
4	*	0.0631	41.26	20.72	61.98	111.59	-49.61			peak
5		0.1130	27.52	20.72	48.24	106.54	-58.30			peak

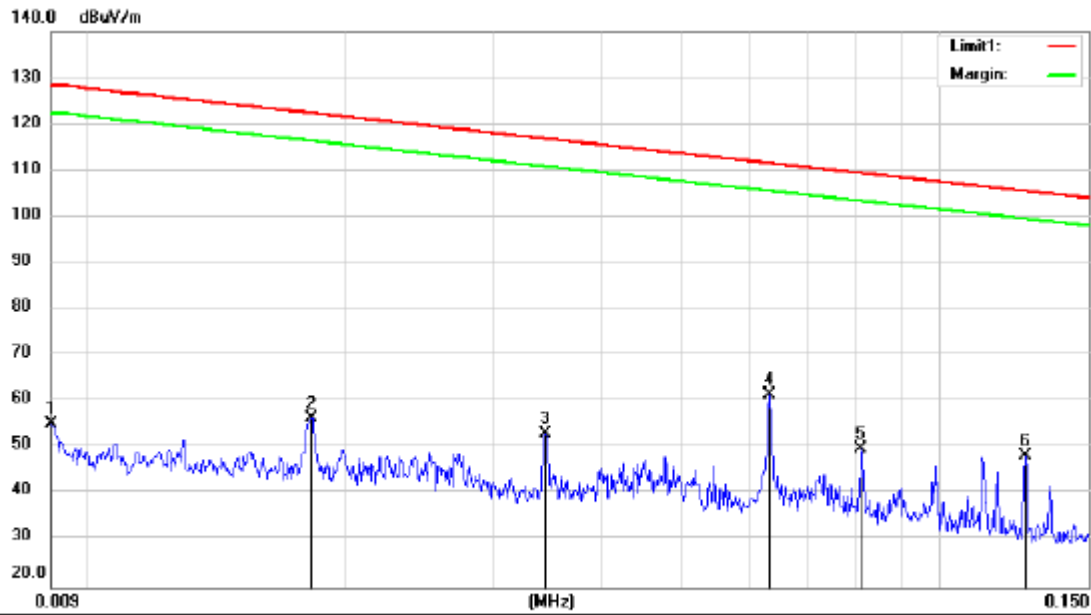

Site 3m Chamber #1

Polarization: Z

Temperature: 29.5 C

Limit: (RE)FCC PART 15.209(9K-30M)

Power: AC 120V/60Hz

Humidity: 48 %

Mode: 13.56MHz

Note:

No.	Mk.	Freq. MHz	Reading Level dBuV	Correct Factor dB	Measure- ment dBuV/m	Limit dBuV/m	Over dB	Detector	Antenna Height cm	Table Degree degree	Comment
1		0.0090	34.54	20.69	55.23	128.50	-73.27	peak			
2		0.0182	35.97	20.59	56.56	122.39	-65.83	peak			
3		0.0343	32.55	20.63	53.18	116.89	-63.71	peak			
4	*	0.0632	40.86	20.72	61.58	111.58	-50.00	peak			
5		0.0810	29.12	20.69	49.81	109.43	-59.62	peak			
6		0.1263	27.87	20.38	48.25	105.57	-57.32	peak			

■ Spurious Emission below 30MHz (150KHz to 30MHz)
 All mode have been tested, and the worst result was report as below:

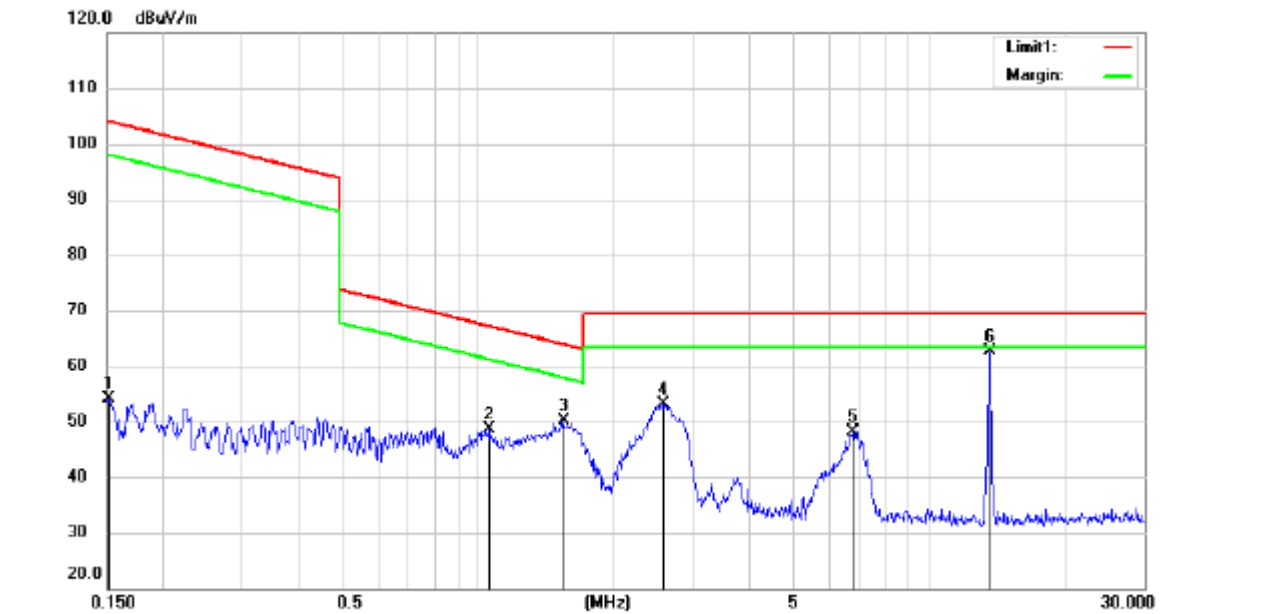

Site 3m Chamber #1 Polarization: X Temperature: 29.5 C
 Limit: (RE)FCC PART 15.209(9K-30M) Power: AC 120V/60Hz Humidity: 48 %
 Mode:13.56MHZ
 Note:

No.	Mk.	Freq.	Reading Level	Correct Factor	Measurement	Limit	Over	Antenna Height	Table Degree	Comment
		MHz	dBuV	dB	dBuV/m	dBuV/m	dB	cm	degree	
1		0.1516	33.87	20.29	54.16	103.98	-49.82			peak
2		1.0541	27.47	21.09	48.56	67.17	-18.61			peak
3		1.5436	29.07	20.97	50.04	63.86	-13.82			peak
4		2.5807	32.46	20.72	53.18	69.50	-16.32			peak
5		6.7691	27.59	20.58	48.17	69.50	-21.33			peak
6	*	13.6228	42.35	20.21	62.56	69.50	-6.94			peak

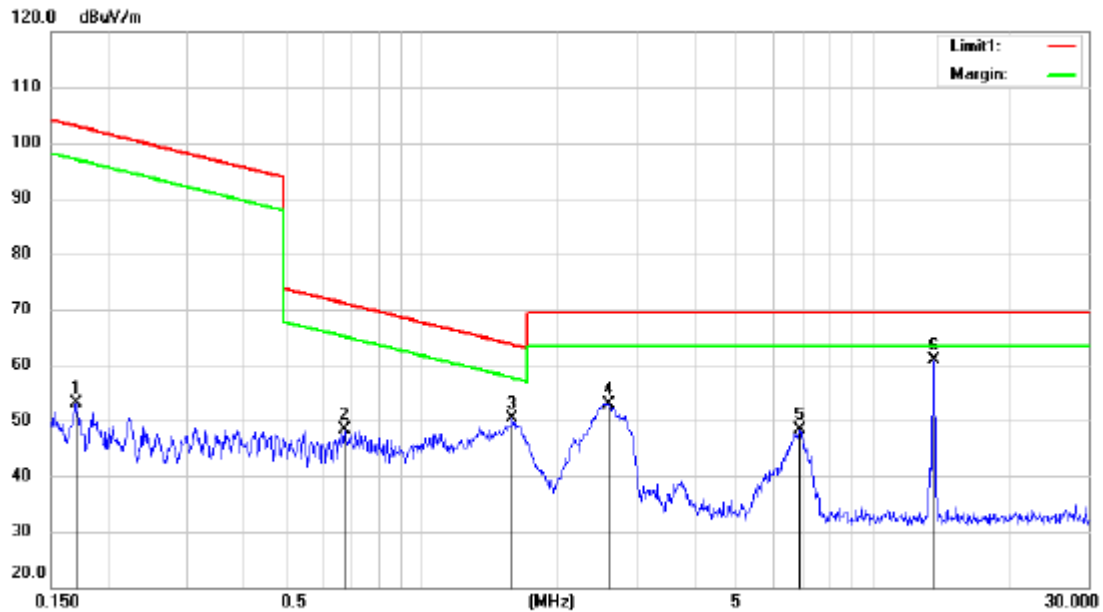

Site 3m Chamber #1

Polarization: **Y**

Temperature: 29.5 C

Limit: (RE)FCC PART 15.209(9K-30M)

Power: AC 120V/60Hz

Humidity: 48 %

Mode:13.56MHZ

Note:

No.	Mk.	Freq. MHz	Reading Level dBuV	Correct Factor dB	Measure- ment dBuV/m	Limit dBuV/m	Over dB	Detector	Antenna Height cm	Table Degree	Comment
1		0.1703	32.74	20.33	53.07	102.97	-49.90	peak			
2		0.6716	27.46	21.03	48.49	71.07	-22.58	peak			
3		1.5851	29.44	20.96	50.40	63.63	-13.23	peak			
4		2.5945	32.19	20.72	52.91	69.50	-16.59	peak			
5		6.8776	27.76	20.58	48.34	69.50	-21.16	peak			
6	*	13.6228	40.73	20.21	60.94	69.50	-8.56	peak			



Site 3m Chamber #1

Polarization: Z

Temperature: 29.5 C

Limit: (RE)FCC PART 15.209(9K-30M)

Power: AC 120V/60Hz

Humidity: 48 %

Mode:13.56MHZ

Note:

No.	Mk.	Freq. MHz	Reading Level dBuV	Correct Factor dB	Measure- ment dBuV/m	Limit dBuV/m	Over dB	Detector	Antenna Height cm	Table Degree	Comment
1		0.1914	31.98	20.37	52.35	101.96	-49.61	peak			
2		1.6020	28.80	20.96	49.76	63.54	-13.78	peak			
3		2.5000	32.36	20.74	53.10	69.50	-16.40	peak			
4		6.7691	27.20	20.58	47.78	69.50	-21.72	peak			
5	*	13.6227	40.22	20.21	60.43	69.50	-9.07	peak			

■ Spurious Emission Above 30MHz (30MHz to 1GHz)

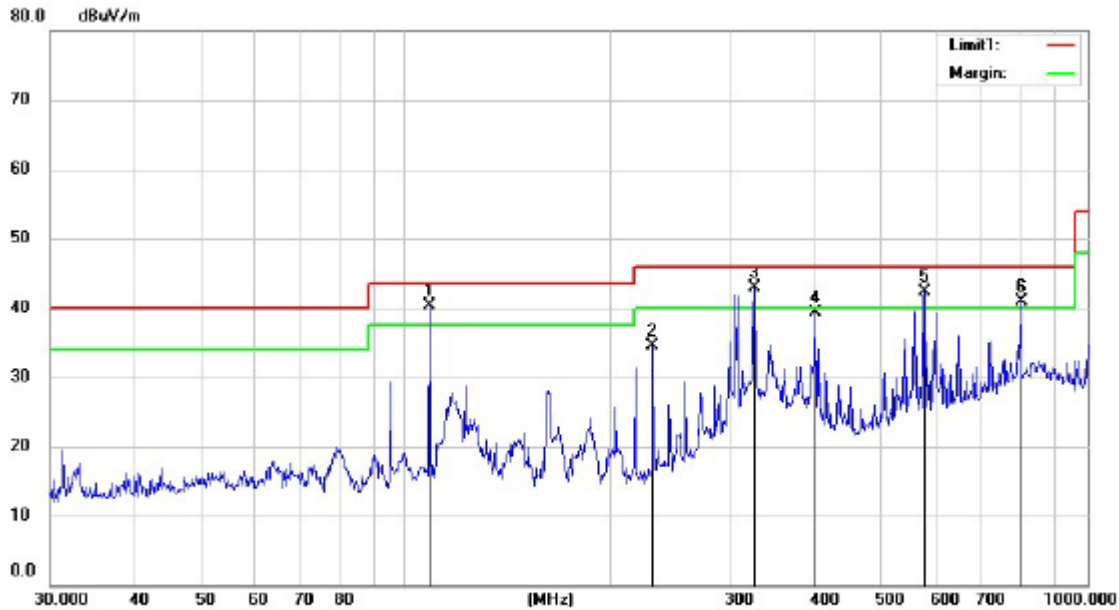

Site 3m Chamber #1

Polarization: *Horizontal*

Temperature: 29.5 C

Limit: (RE)FCC PART 15 CLASS B

Power: AC 120V/60Hz

Humidity: 48 %

Mode: 13.56MHZ

Note:

No.	Mk.	Freq.	Reading Level	Correct Factor	Measurement	Limit	Over	Antenna Height	Table Degree	
		MHz	dBuV	dB	dBuV/m	dBuV/m	dB	cm	degree	Comment
1	!	108.5042	54.82	-14.56	40.26	43.50	-3.24	QP		
2		230.5023	47.16	-12.58	34.58	46.00	-11.42	QP		
3	*	325.1680	51.30	-8.49	42.81	46.00	-3.19	QP		
4		400.0810	45.72	-6.35	39.37	46.00	-6.63	QP		
5	!	578.1630	45.77	-3.47	42.30	46.00	-3.70	QP		
6	!	800.0310	38.86	1.97	40.83	46.00	-5.17	QP		

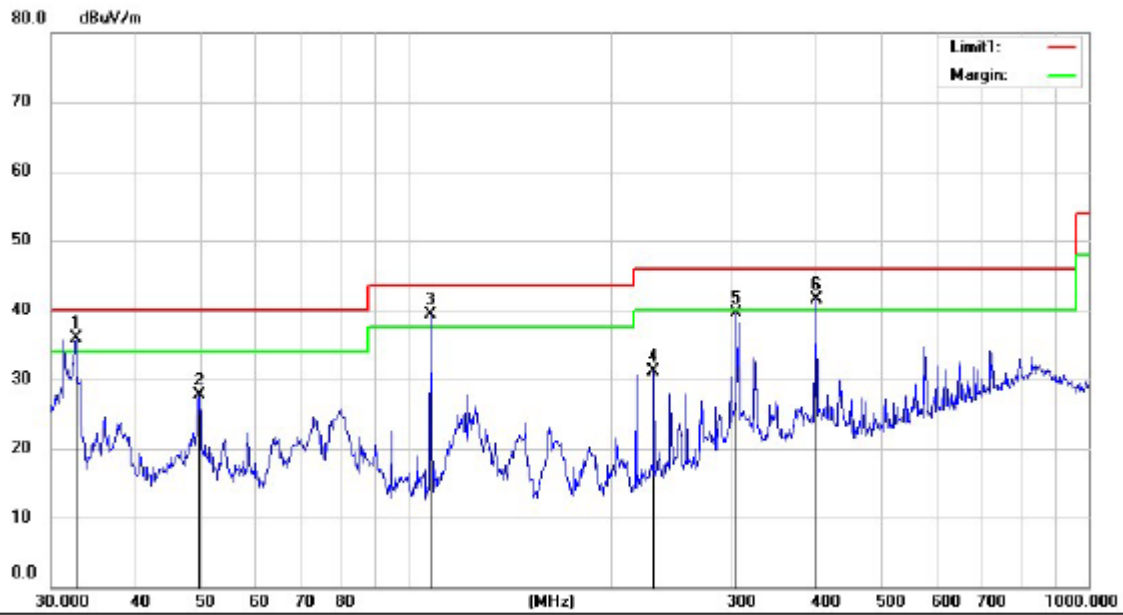

Site: 3m Chamber #1

Polarization: **Vertical**

Temperature: 29.5 C

Limit: (RE)F CC PART 15 CLASS B

Power: AC 120V/60Hz

Humidity: 48 %

Mode: 13.56MHZ

Note:

No.	Mk.	Freq.	Reading Level	Correct Factor	Measurement	Limit	Over	Antenna Height	Table Degree	
		MHz	dBuV	dB	dBuV/m	dBuV/m	dB	cm	degree	Comment
1	*	32.6483	50.24	-14.36	35.88	40.00	-4.12	QP		
2		49.5762	39.85	-12.11	27.74	40.00	-12.26	QP		
3	!	108.5042	53.92	-14.56	39.36	43.50	-4.14	QP		
4		230.5023	43.62	-12.58	31.04	46.00	-14.96	QP		
5		304.8771	48.66	-9.08	39.58	46.00	-6.42	QP		
6	!	400.0810	47.76	-6.35	41.41	46.00	-4.59	QP		

7.4 CONDUCTED EMISSION TEST

7.4.1 Applicable Standard

According to FCC Part 15.207(a)

7.4.2 Conformance Limit

Conducted Emission Limit		
Frequency(MHz)	Quasi-peak	Average
0.15-0.5	66-56	56-46
0.5-5.0	56	46
5.0-30.0	60	50

Note: 1. The lower limit shall apply at the transition frequencies
2. The limit decreases in line with the logarithm of the frequency in the range of 0.15 to 0.50MHz.

7.4.3 Test Configuration

Test according to clause 7.3 conducted emission test setup

7.4.4 Test Procedure

The EUT was placed on a table which is 0.8m above ground plane.
Maximum procedure was performed on the highest emissions to ensure EUT compliance.
Repeat above procedures until all frequency measured were complete.

7.4.5 Test Results

Pass

The 120V &240V voltage have been tested, and the worst result recorded was report as below:

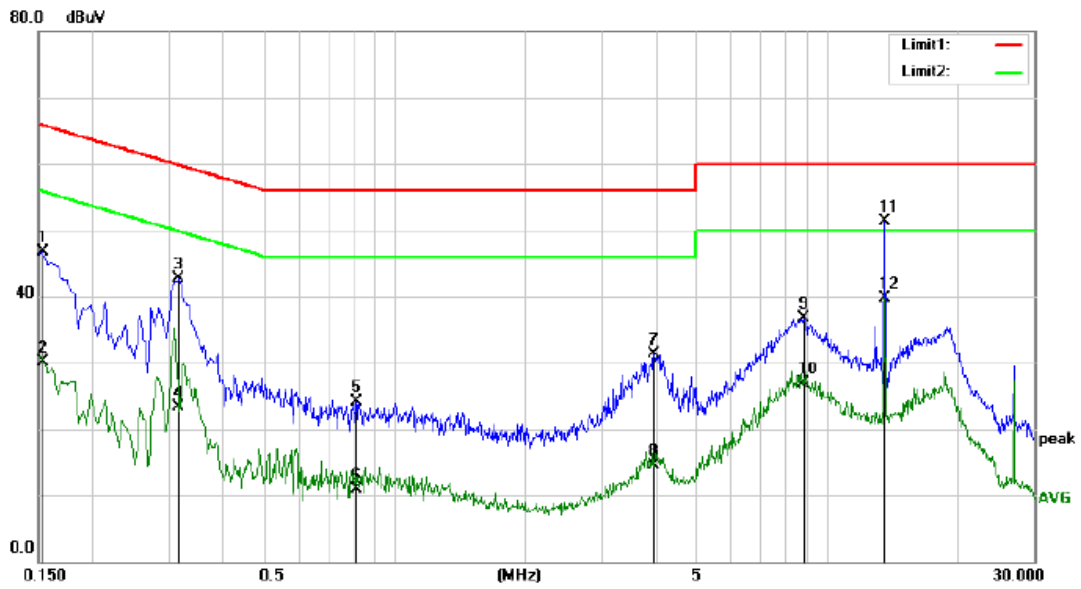

Site Conduction #2 Phase: **L1** Temperature: 25.0
 Limit: (CE)FCC PART 15 class B_QP Power: AC 120V/60Hz Humidity: 49 %
 Mode: NFC
 Note:

No.	Mk.	Freq. MHz	Reading Level dBuV	Correct Factor dB	Measure- ment dBuV	Limit dBuV	Over dB	Detector	Comment
1		0.1540	36.21	10.48	46.69	65.78	-19.09	QP	
2		0.1540	19.67	10.48	30.15	55.78	-25.63	AVG	
3		0.3180	32.32	10.39	42.71	59.76	-17.05	QP	
4		0.3180	12.82	10.39	23.21	49.76	-26.55	AVG	
5		0.8140	13.75	10.37	24.12	56.00	-31.88	QP	
6		0.8140	0.59	10.37	10.96	46.00	-35.04	AVG	
7		3.9740	20.79	10.44	31.23	56.00	-24.77	QP	
8		3.9740	4.03	10.44	14.47	46.00	-31.53	AVG	
9		8.8260	25.99	10.72	36.71	60.00	-23.29	QP	
10		8.8260	16.21	10.72	26.93	50.00	-23.07	AVG	
11	*	13.5620	40.57	10.73	51.30	60.00	-8.70	QP	
12		13.5620	28.88	10.73	39.61	50.00	-10.39	AVG	

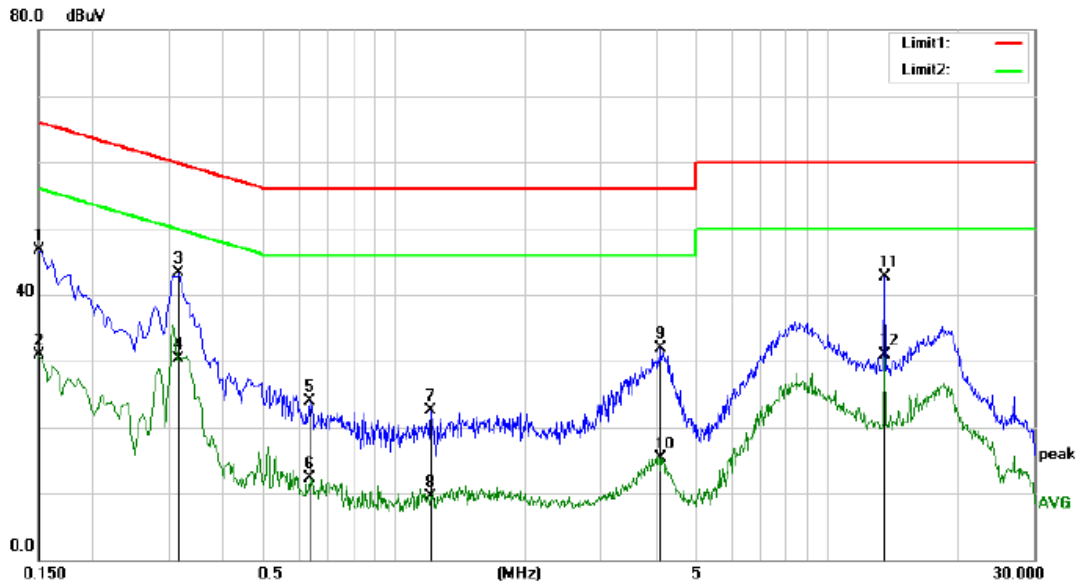

Site Conduction #2 Phase: **N** Temperature: 25.0
 Limit: (CE)FCC PART 15 class B_QP Power: AC 120V/60Hz Humidity: 49 %
 Mode: NFC
 Note:

No.	Mk.	Freq.	Reading Level	Correct Factor	Measurement	Limit	Over	Detector	Comment
		MHz	dBuV	dB	dBuV	dBuV	dB		
1		0.1500	36.18	10.48	46.66	66.00	-19.34	QP	
2		0.1500	20.33	10.48	30.81	56.00	-25.19	AVG	
3	*	0.3180	32.83	10.39	43.22	59.76	-16.54	QP	
4		0.3180	19.88	10.39	30.27	49.76	-19.49	AVG	
5		0.6380	13.61	10.35	23.96	56.00	-32.04	QP	
6		0.6380	1.98	10.35	12.33	46.00	-33.67	AVG	
7		1.2140	12.09	10.40	22.49	56.00	-33.51	QP	
8		1.2140	-0.98	10.40	9.42	46.00	-36.58	AVG	
9		4.1100	21.50	10.45	31.95	56.00	-24.05	QP	
10		4.1100	4.93	10.45	15.38	46.00	-30.62	AVG	
11		13.5620	32.06	10.73	42.79	60.00	-17.21	QP	
12		13.5620	20.21	10.73	30.94	50.00	-19.06	AVG	

8 ANTENNA APPLICATION

8.1.1 Antenna Requirement

Standard	Requirement
FCC CRF Part 15.203	An intentional radiator shall be designed to ensure that no antenna other than that furnished by the responsible party shall be used with the device. The use of a permanently attached antenna or of an antenna that uses a unique coupling to the intentional radiator shall be considered sufficient to comply with the provisions of this section. The manufacturer may design the unit so that a broken antenna can be replaced by the user, but the use of a standard antenna jack or electrical connector is prohibited. This requirement does not apply to carrier current devices or to devices operated under the provisions of §15.211, §15.213, §15.217, §15.219, or §15.221. Further, this requirement does not apply to intentional radiators that must be professionally installed, such as perimeter protection systems and some field disturbance sensors, or to other intentional radiators which, in accordance with §15.31(d), must be measured at the installation site. However, the installer shall be responsible for ensuring that the proper antenna is employed so that the limits in this part are not exceeded.

For intentional device, according to FCC 47 CFR Section 15.203, an intentional radiator shall be designed to ensure that no antenna other than that furnished by the responsible party shall be used with the device. if transmitting antennas of directional gain greater than 6dBi are used, the power shall be reduced by the amount in dB that the directional gain of the antenna exceeds 6dBi.

8.2 RESULT

The EUT'S antenna is PCB antenna, The antenna's gain is 0.5 dBi and meets the requirement. and the antenna can't be replaced by the user, which in accordance to section 15.203.