

# Installation Guide

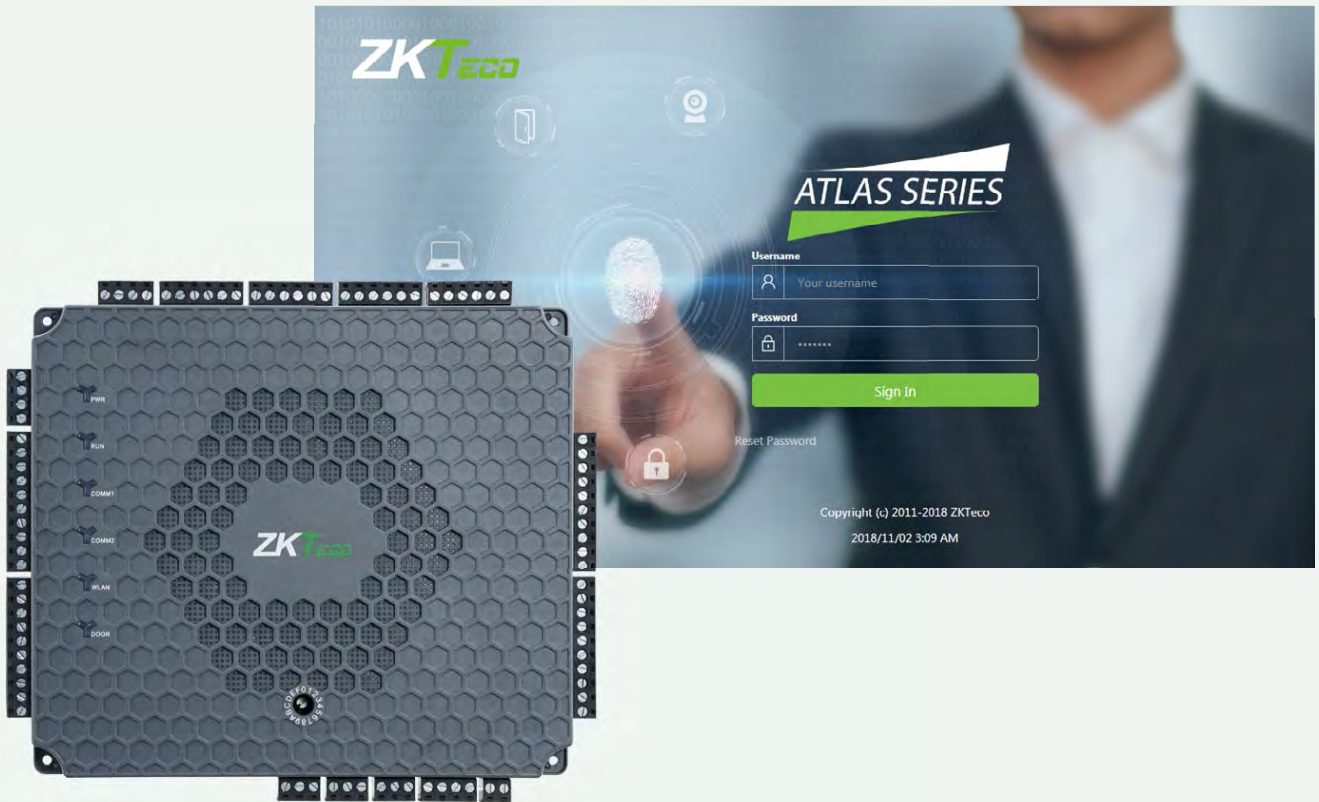

## Atlas x60 Series

Access Control Panels

**ZKTeco**

ZKTecousa.com

# What's in the Box

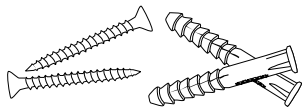
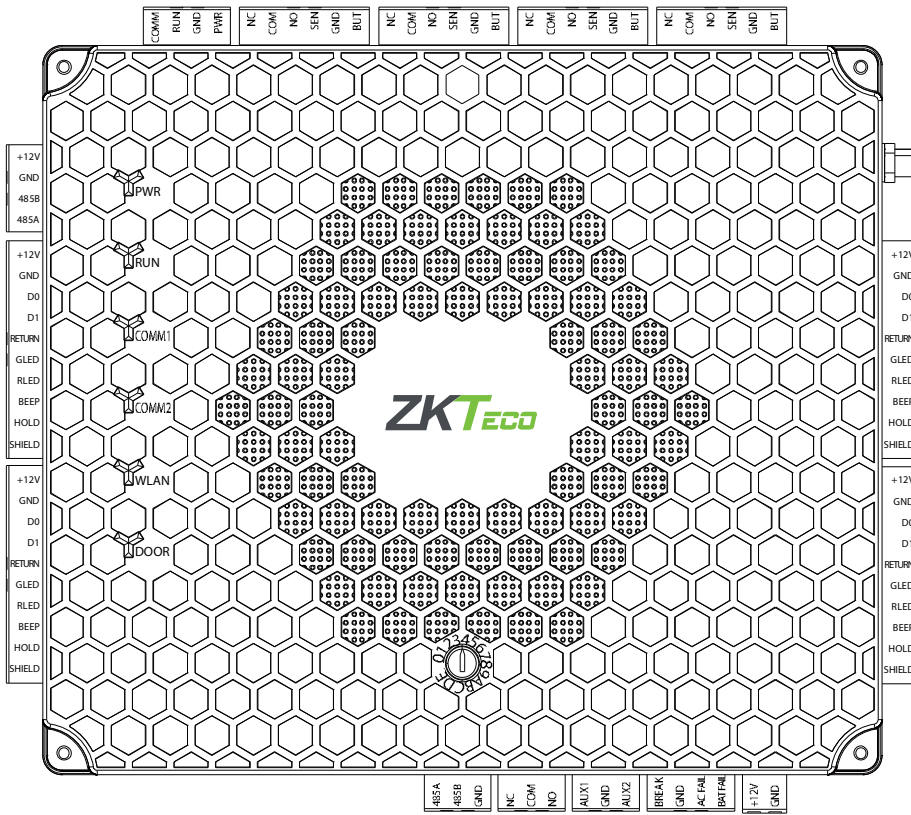

4 Screws & Anchors

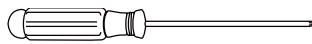

1 Screwdriver

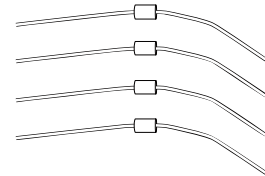

4 Diodes

# CONTENTS

What's in the Box.....	2
Optional Accessories.....	4
Safety Precautions.....	5
Product PIN Diagram.....	6
LED Indicators.....	7
Product Dimension.....	8
Installation of Panel & Cabinet.....	9
Wiring Legend.....	10
Power Wiring Diagram .....	11
Wiegand Connection.....	12
OSDP Connection.....	13
FR1500A Connection.....	14
DIP Switch Setting for FR1500A Device ID.....	15
REX Connections.....	16
Lock Connection.....	17
AUX. I/O Connection.....	18
Ethernet Connection .....	19
Typical Installation.....	20
Troubleshooting.....	21
Reader 485 Setting Table.....	22
Electrical Specifications .....	24
Introduction .....	27
Understanding the Atlas Series Network .....	28
Initial Controller Setup .....	29
Connect the Controller to the Network .....	35
Complete the Configuration .....	36
Add a User and Test Access .....	40
Add Secondary Controllers .....	43
Mobile App.....	44
Special Considerations for Complex Networks .....	48
Where to Go Next .....	48



Web Management Application  
Programming Guide starts at  
page 26

# Optional Accessories



Wiegand Card Reader



Prox Card



Door Sensor



Exit Button



SLK20R Enrollment reader



CR10E Card Enrollment Reader



FR1500A FP & Prox Reader



Atlas x60 Metal Cabinet

# Safety Precautions

The following precautions are to keep user's safe and prevent any damage. Please read carefully before installation.



**Do not** expose to direct sunlight, water, dust and soot.



**Do not** place any magnetic objects near the product. Magnetic objects such as magnets, CRT, TV, monitors or speakers may damage the device



**Do not** place the device next to heating equipment.



**Prevent** water, drinks or chemicals leaking into the device.



This product is not intended for use by children unless they are supervised.



**Do not** drop or damage the device.



**Do not** disassemble, repair or modify the device.



**Do not** use the device for any purpose other than those specified.



**Remove** dust or dirt regularly. While cleaning, wipe dust off with a smooth cloth or towel instead of water.

**Contact** your supplier in case of any problem!

# Product PIN Diagram

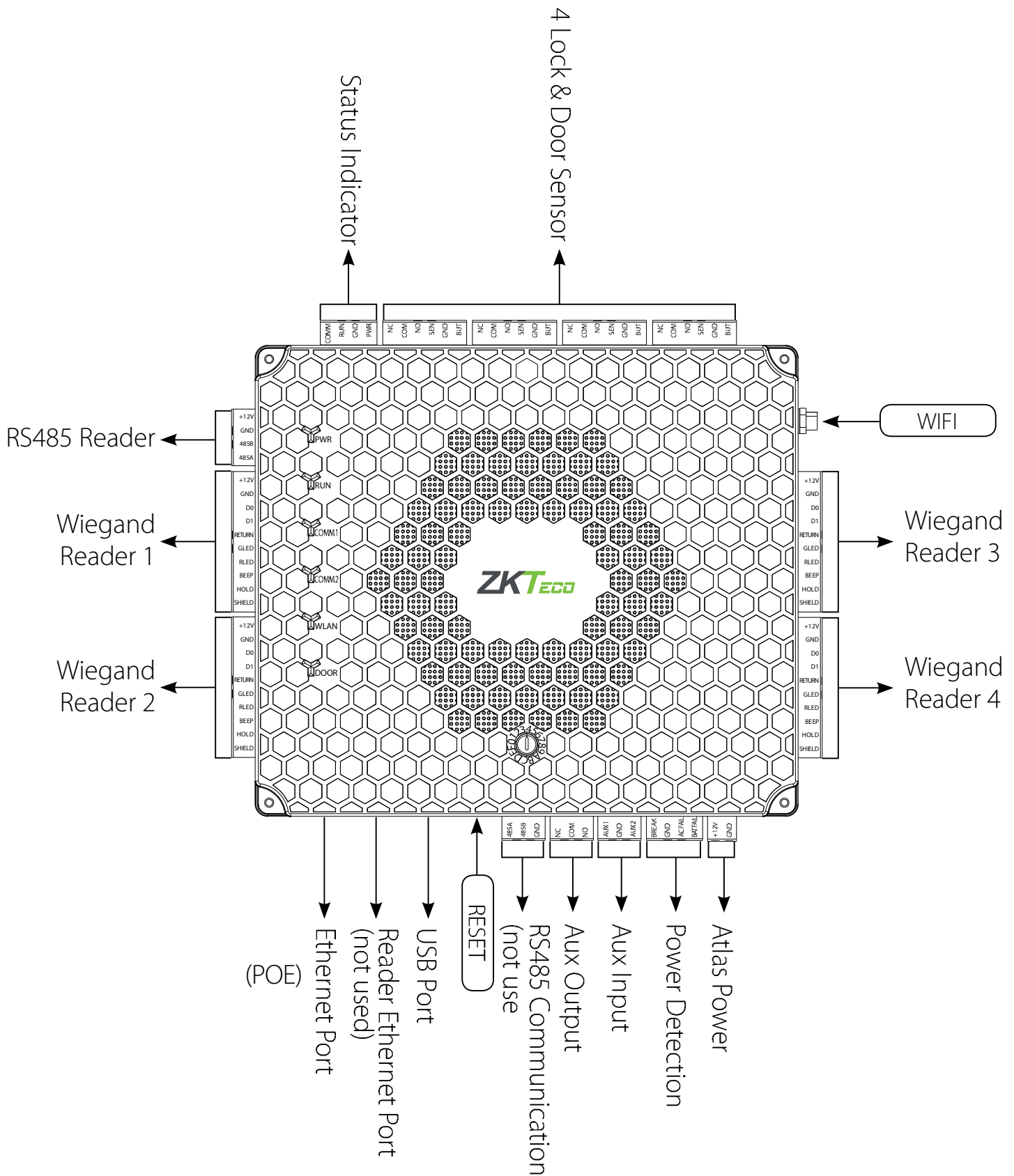

Figure 1

The function of reset button (once reset button is pressed, LED will blink fast):

1. Press reset button for about 2-5 seconds, zk firmware will check if there is a USB disk which stores an upgrade package inserted into controller, if yes, then controller will do firmware upgrade automatically.
2. Press reset button for about 5-10 seconds, zk firmware will temporarily set IP to default 169.254.202.242.

# LED Indicators

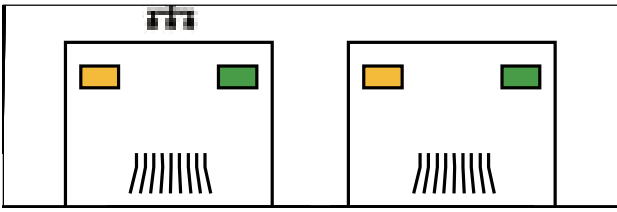

Figure 2

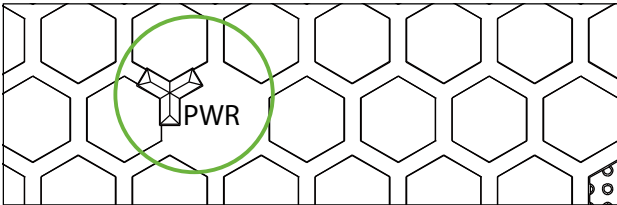

Figure 3

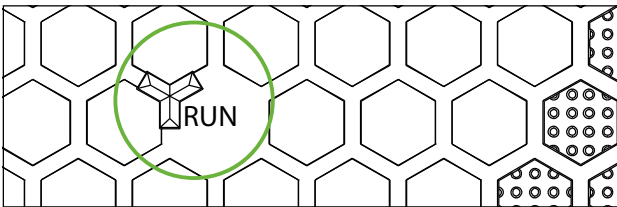

Figure 4

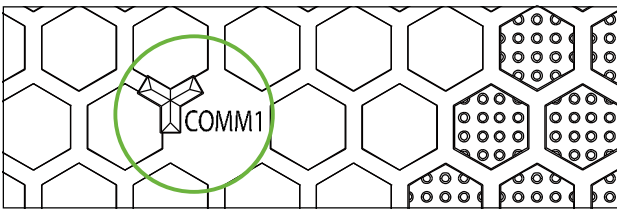

Figure 5

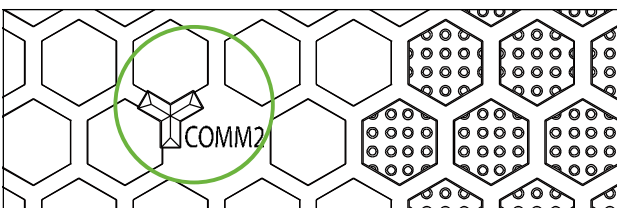

Figure 6

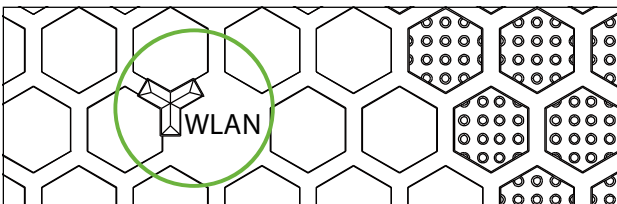

Figure 7

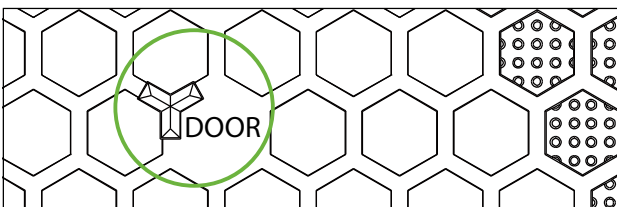

Figure 8

**LINK Solid Green LED** indicates TCP/IP communication is normal

**Flashing (ACT) Yellow LED** indicates data communication is in progress

**Solid (POWER) Red LED** indicates the panel is powered on.

**Flashing (RUN) Green LED** indicates that panel is in normal working state.

**COMM1 Flashing Yellow** indicates the system is communicating with upper-level devices (for example, the PC).

**COMM2 Flashing Yellow** indicates the system is communicating with lower-level devices (for example, readers).

**Flashing (WLAN) Green LED** indicates the system is communicating in wireless (Wi-Fi) mode.

**Flashing (DOOR) Green LED** indicates a door opening signal (a door is opened).

# Product Dimension

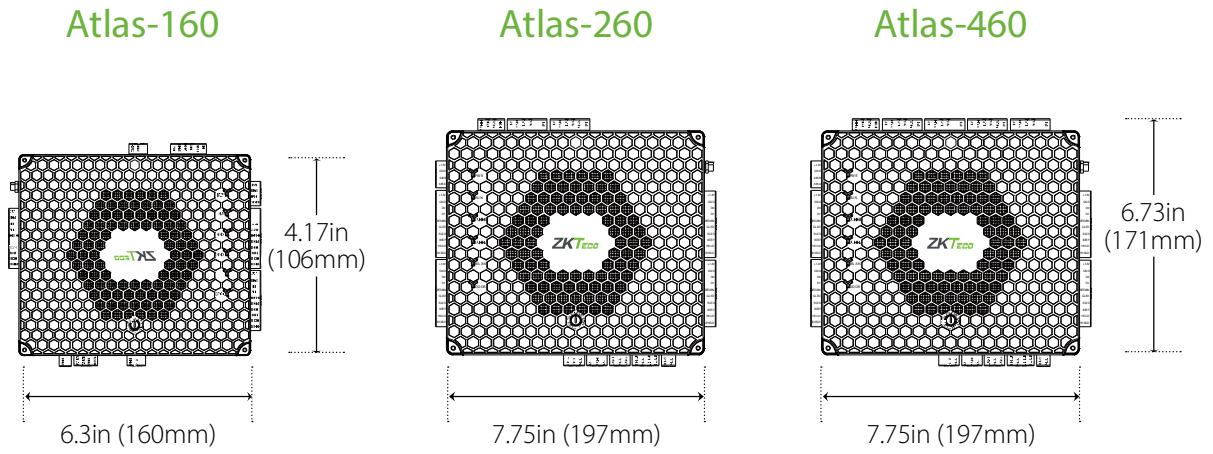

Figure 9

## Atlas x60 Metal Cabinet

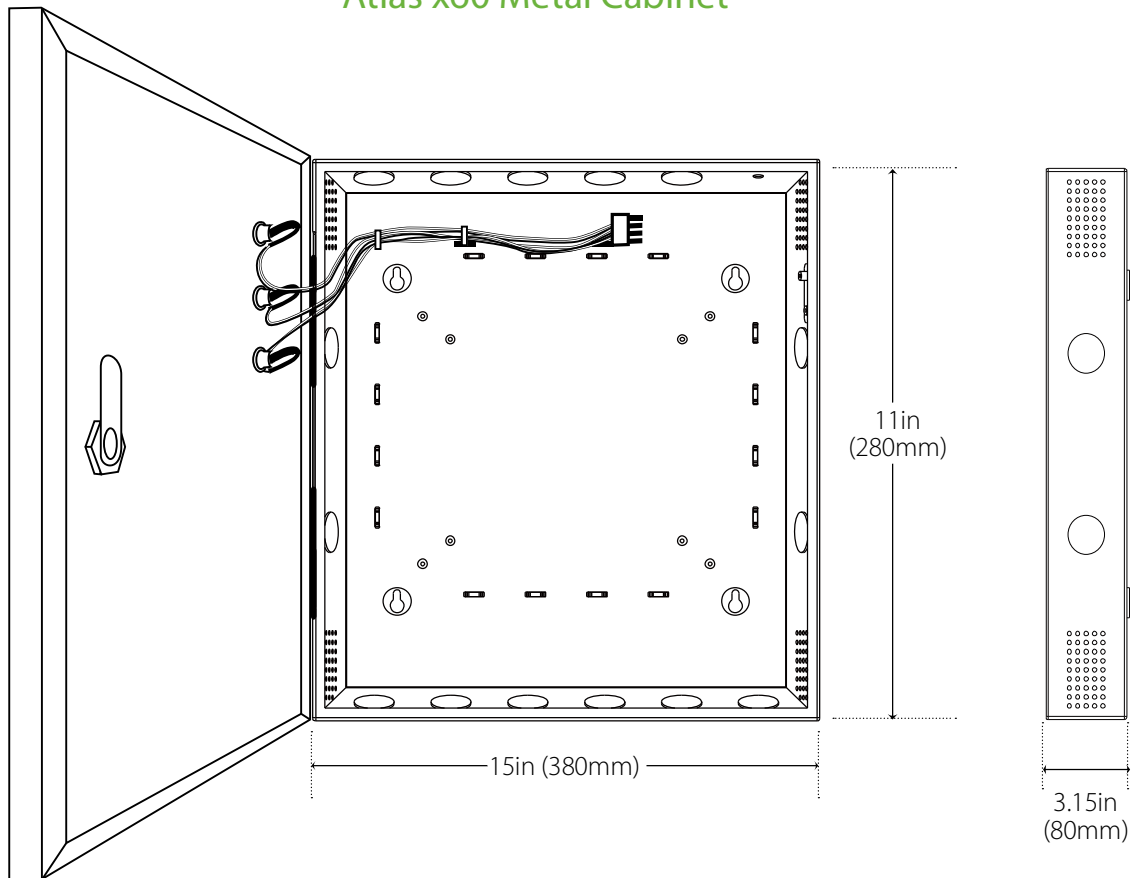

Figure 10



# Installation of Panel & Cabinet

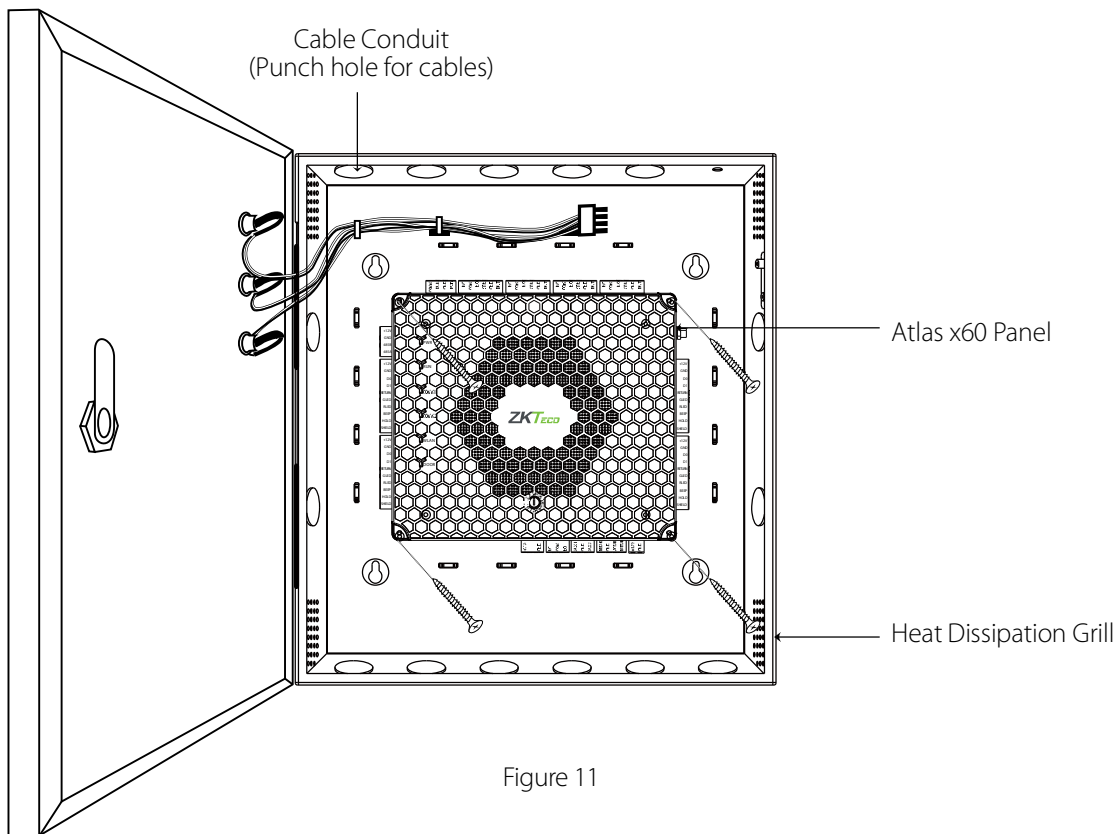

Figure 11

## Step 1

Pass the cable through holes

## Step 2

Mount the Metal Cabinet

## Step 3

Fasten the Panel with four screws.

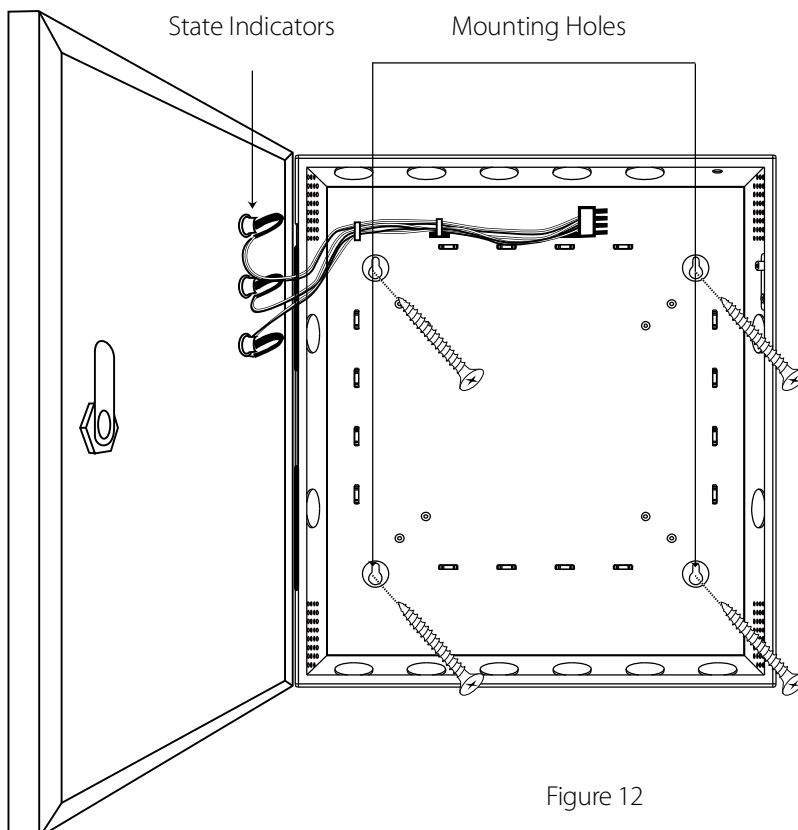
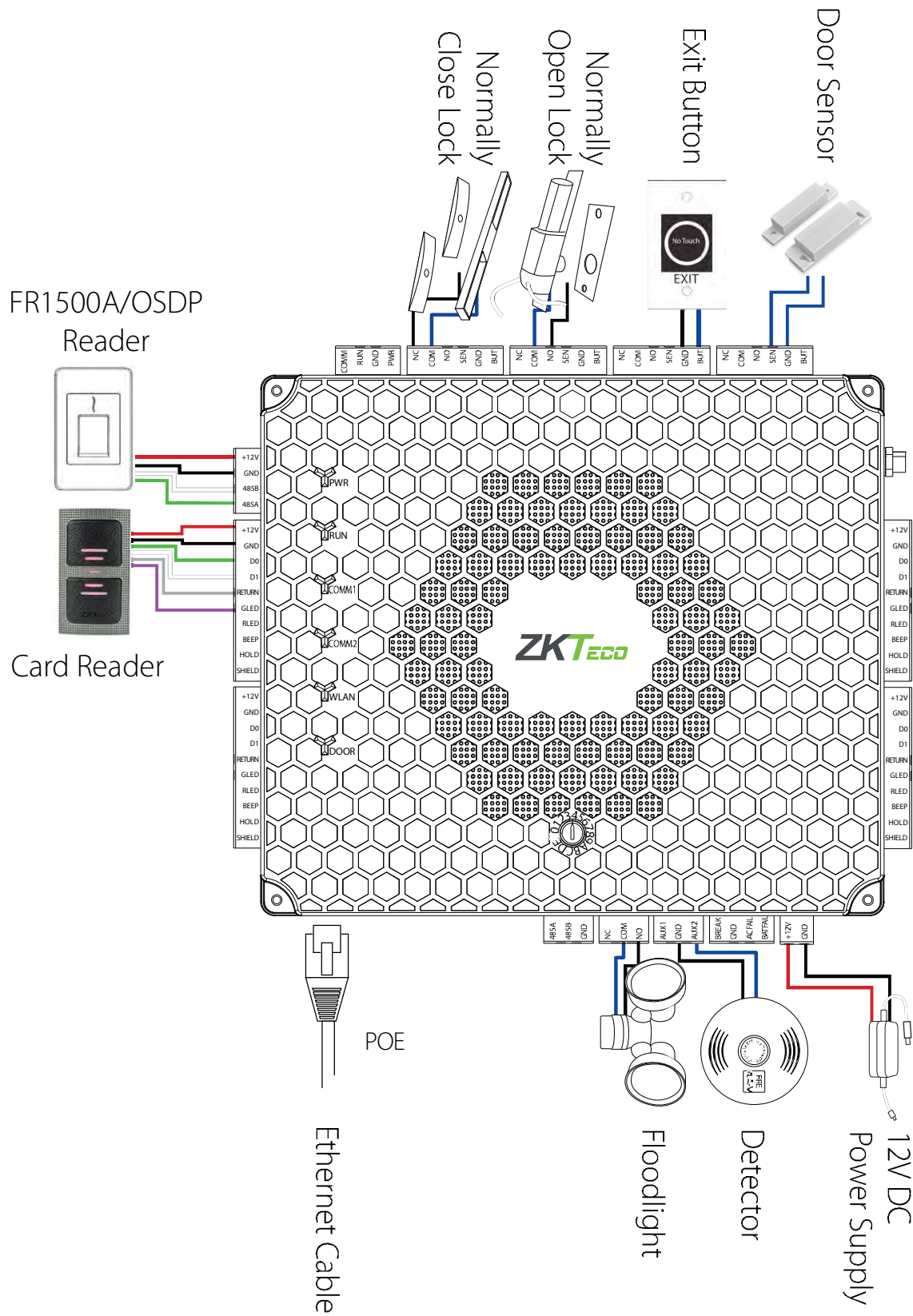

Figure 12

We recommend drilling the mounting plate screws into solid wood (i.e. stud/beam). If a stud/beam cannot be found, then use the supplied drywall plastic mollies (anchors).

# Wiring Legend



The auxiliary input may be connected to infrared motion sensors, fire alarms, or smoke detectors. The auxiliary output may be connected to alarms, cameras or door bells, etc.

Figure 13

# Power Wiring Diagram

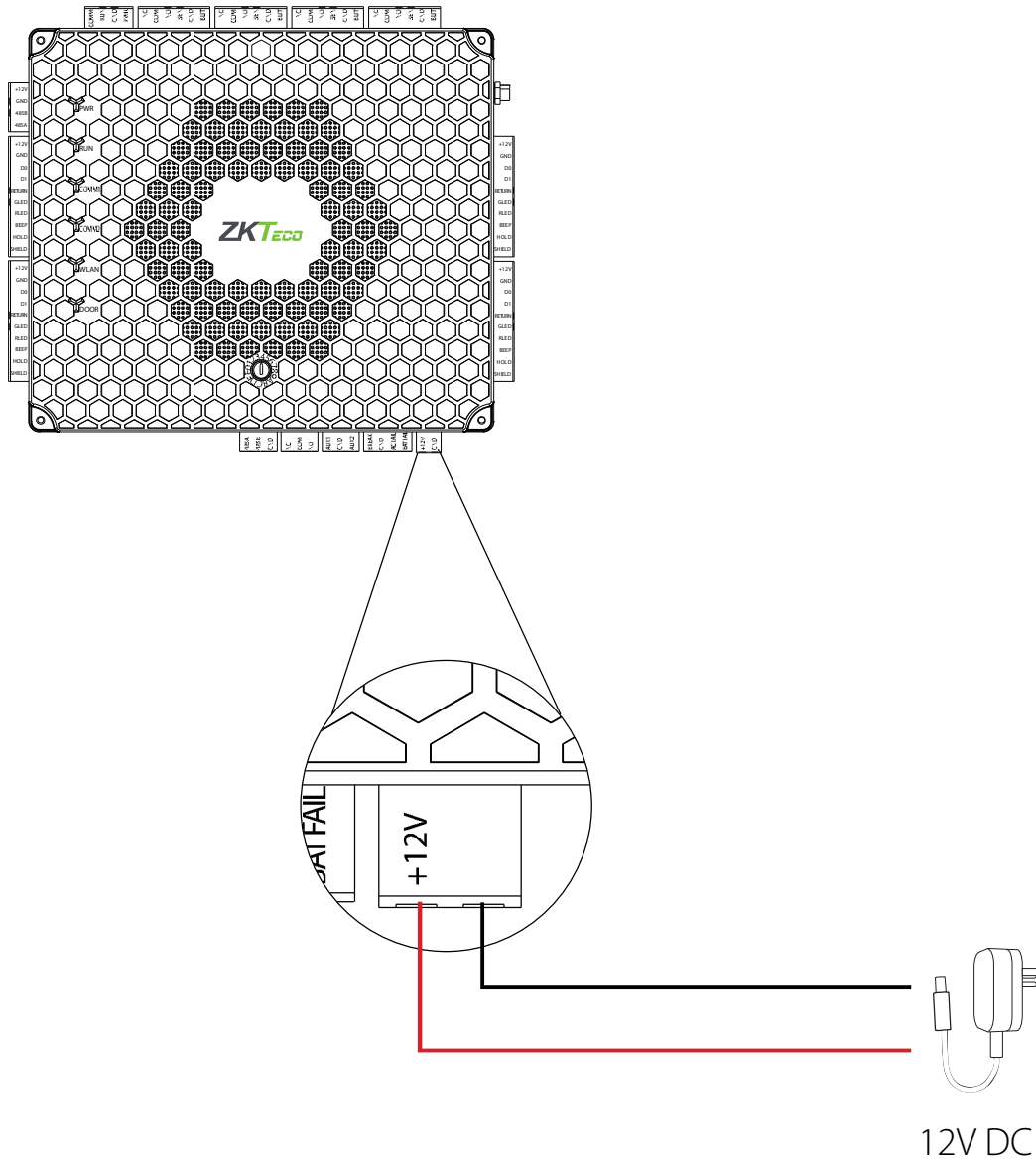

Figure 14

# Wiegand Connection

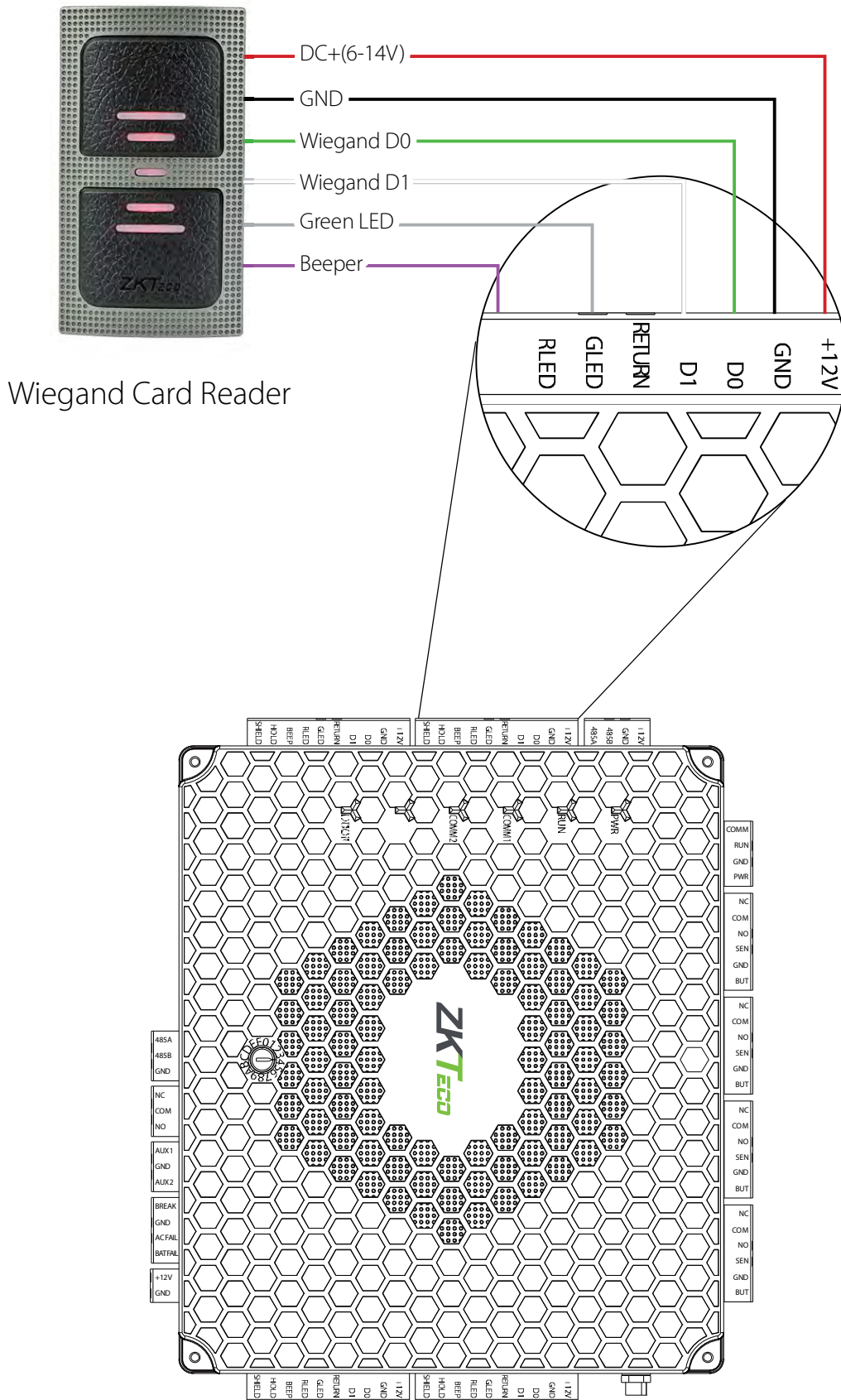

Figure 15

# OSDP Connection

NOTE: OSDP and ZKTeco RS485 (FR1500A readers) cannot both be connected to one control panel.

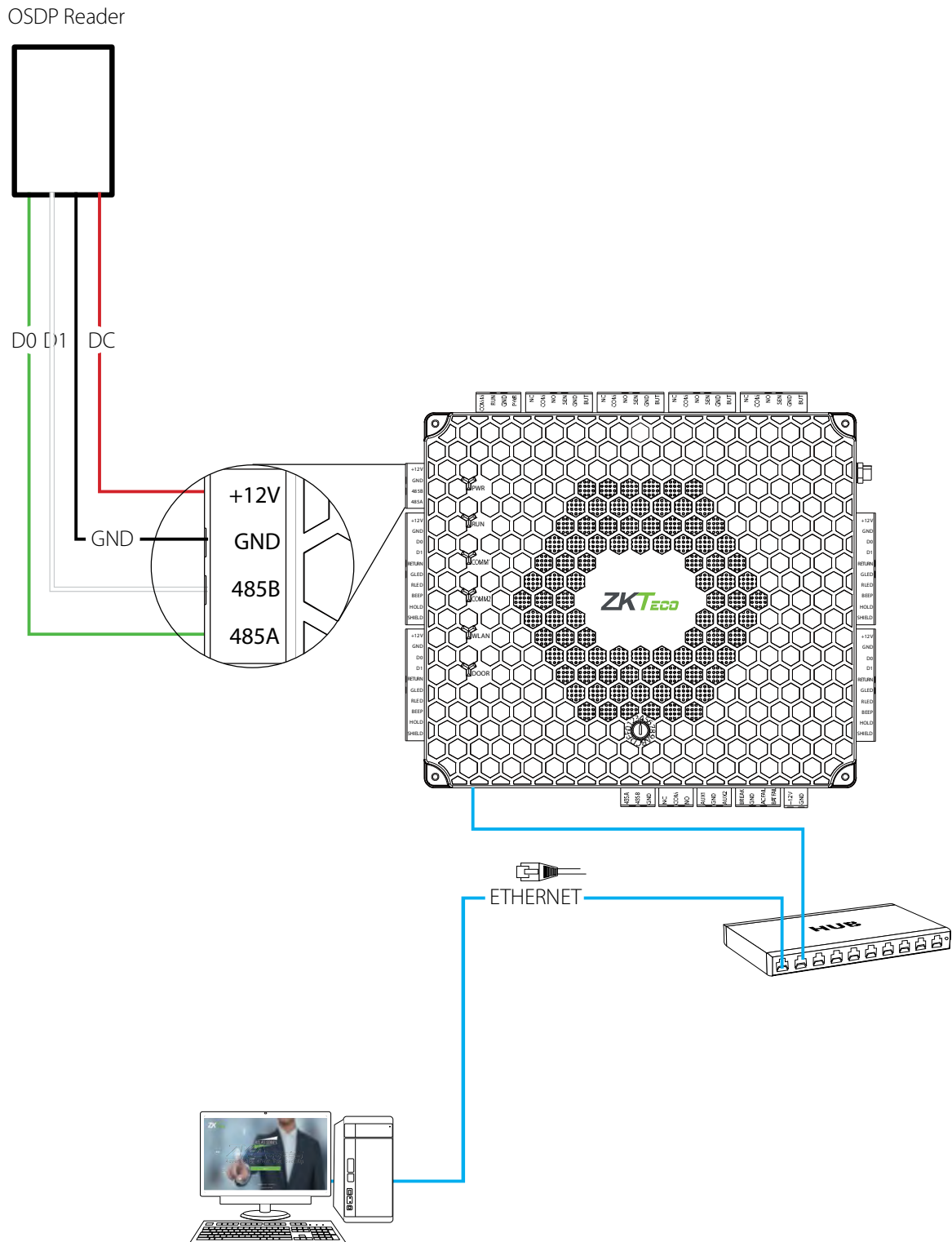

Figure 16

# FR1500A Connection

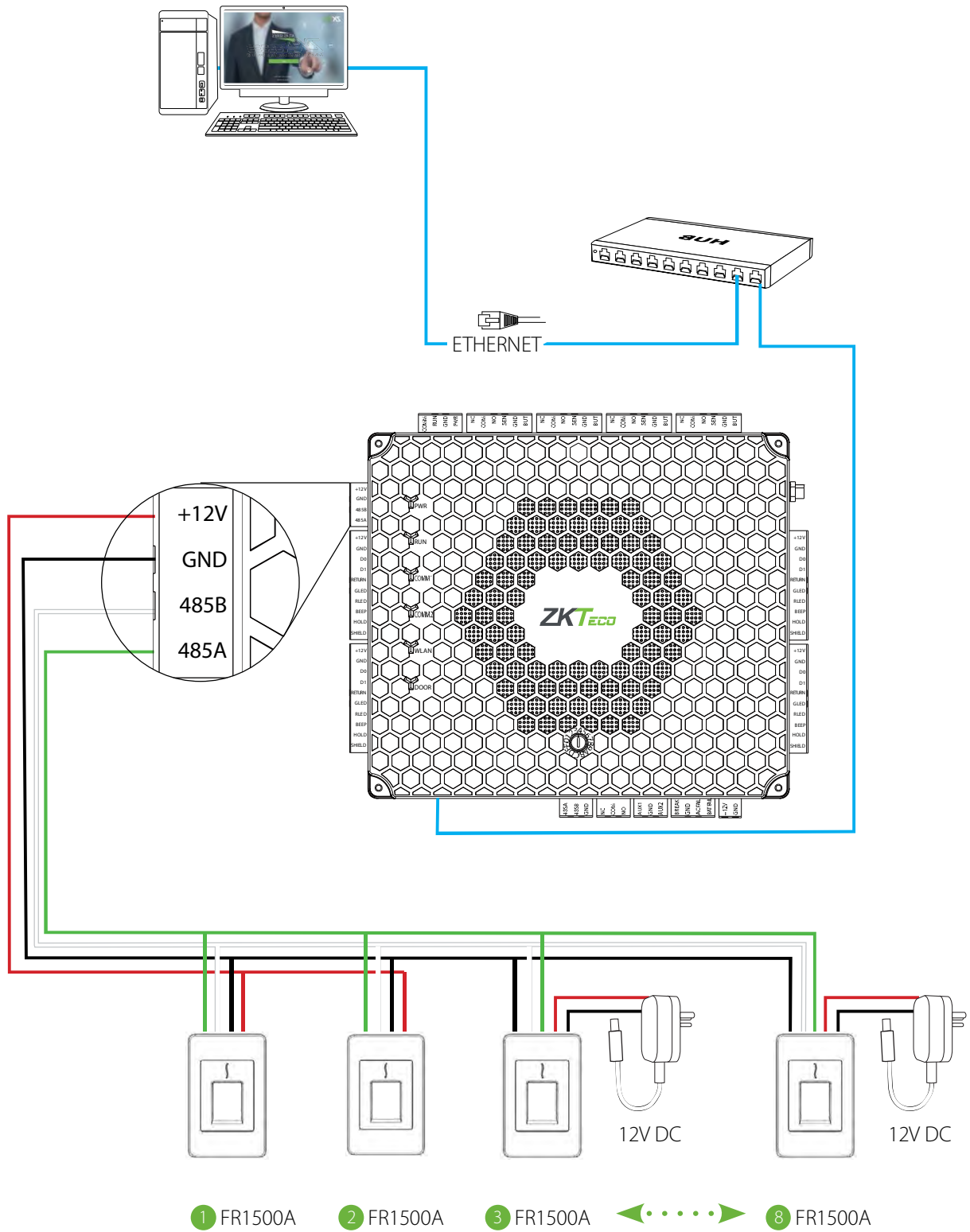

Figure 17

# DIP Switch Setting for FR1500A Device ID

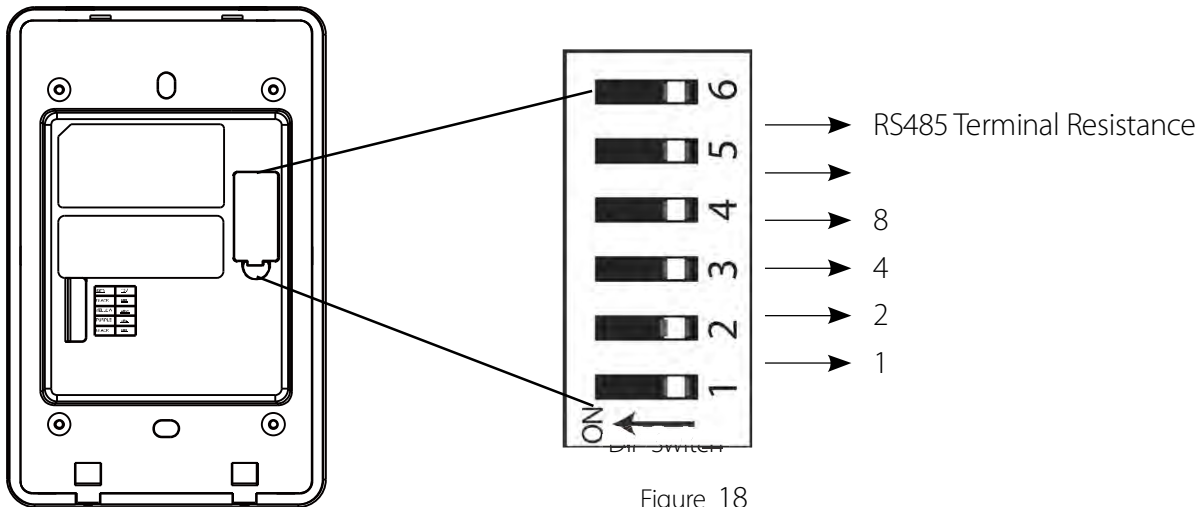

Figure 18

Address	Switch Settings	Address	Switch Settings
1		5	
2		6	
3		7	
4		8	

## Important Notes

- There are six DIP switches on the back of FR1500A, Switches 1-4 is for RS485 address, switch 5 is reserved, switch 6 is for reducing noise on long RS485 cable.
- Set the odd number for IN reader, and the even number for OUT reader (for eg. For two readers for one door- the RS485 address 1 is for IN reader, RS485 address 2 is for OUT reader)
- If FR1500A is powered from Atlas-460 panel, the length of wire should be less than 100 meters or 330 ft.
- The External RS485 interface can supply maximum 500mA current, The FR1500A's startup current is 240mA. So Atlas-460 only can only power two FR1500As.
- If the cable length is more than 200 meters or 600 ft, the number 6 switch should be ON as below



← Distance: More than 200 meters →



# REX Connections

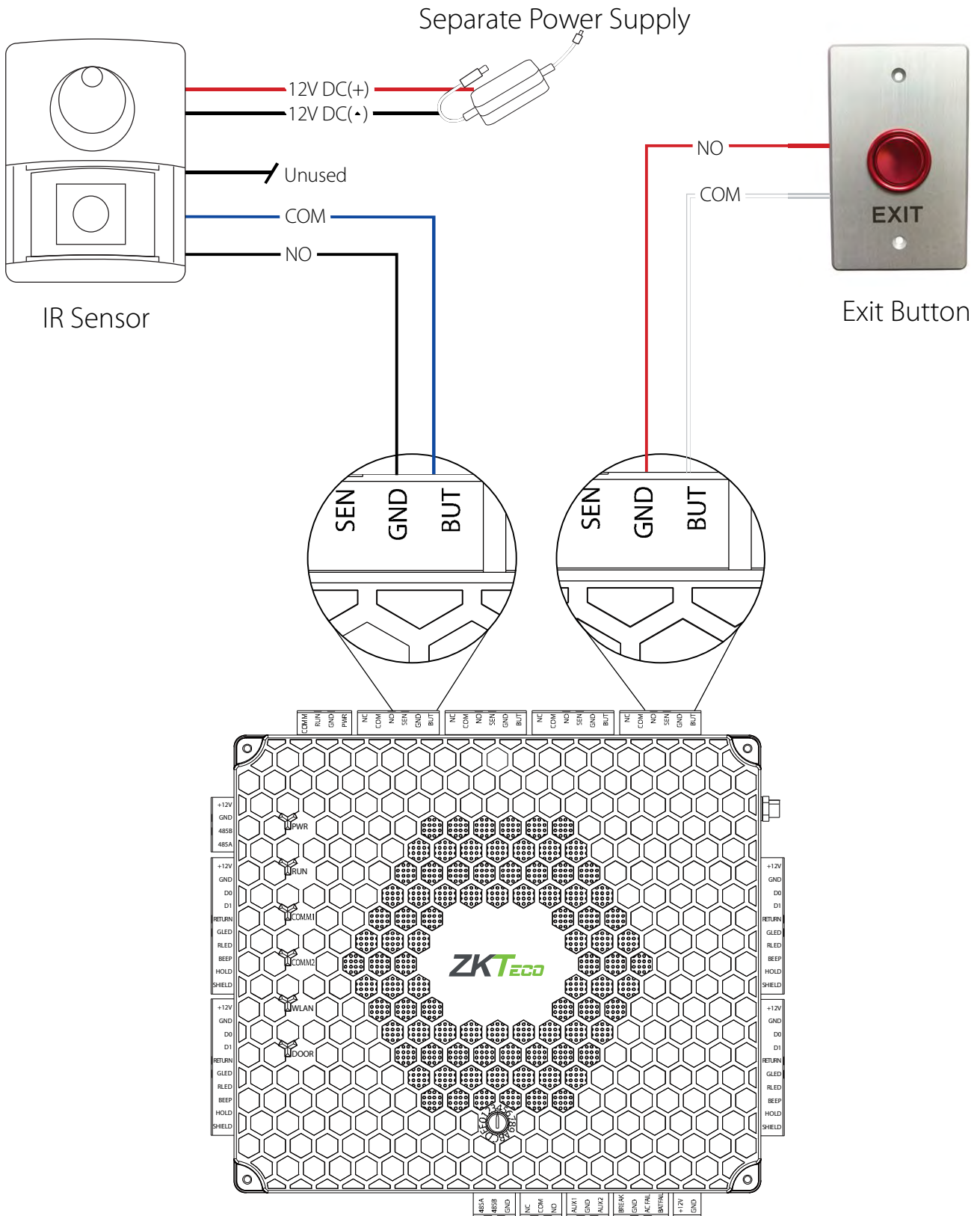

Figure 19



# Lock Connection

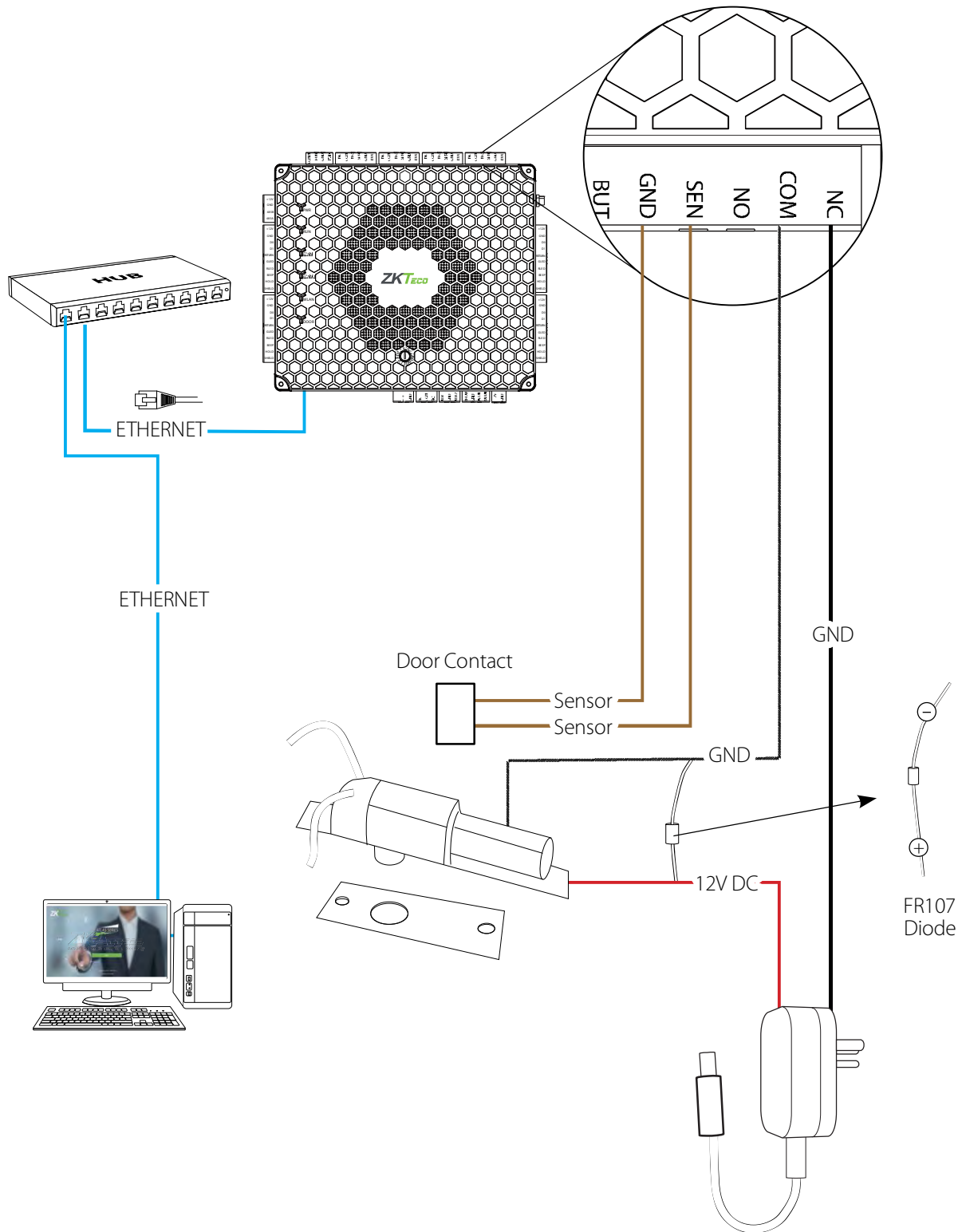

Figure 20

# AUX. I/O Connection

## AUX. Input Connection

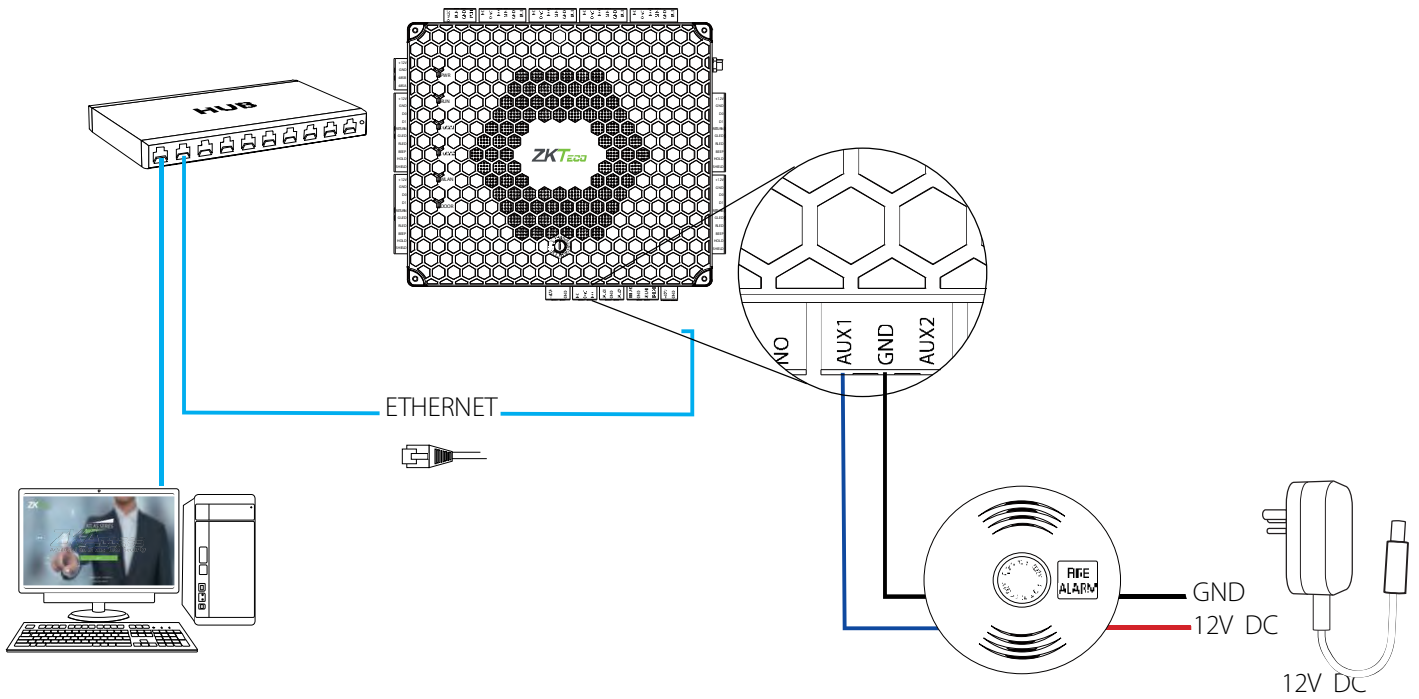

Figure 21

## AUX. Output Connection

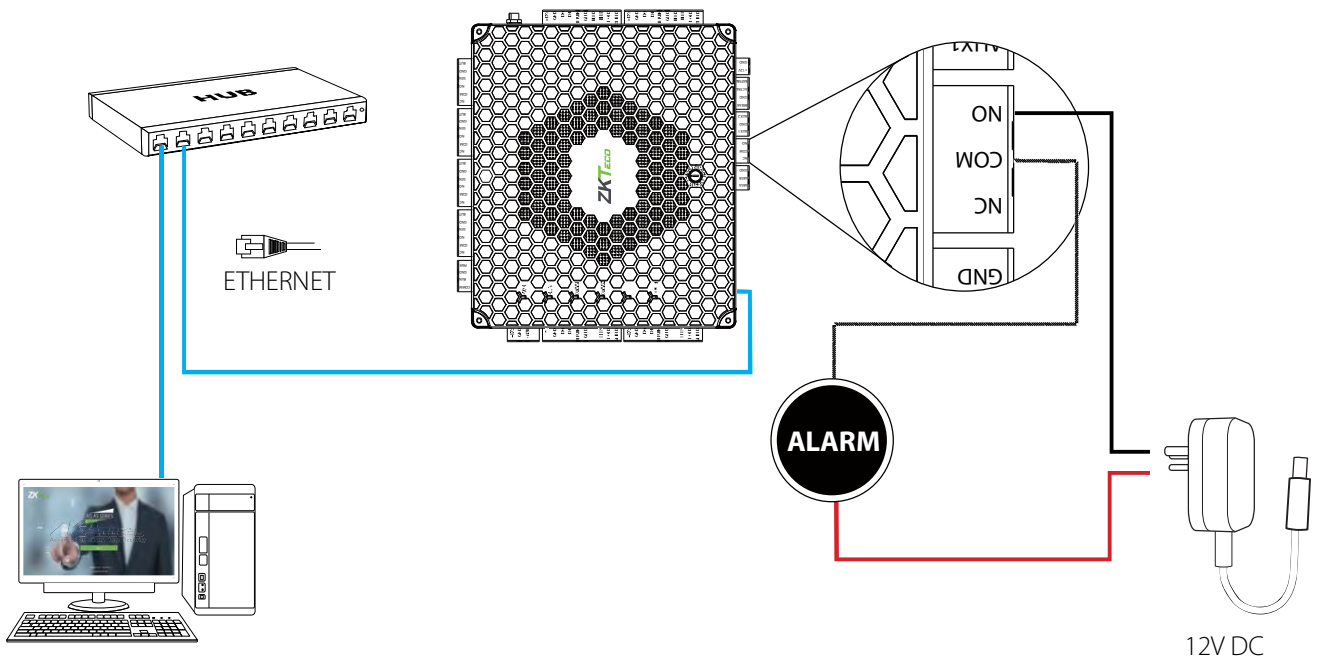

Figure 22

# Ethernet Connection

## LAN Connection

### Important Notes:

1. Both 10Base-T and 100Base-T are supported
2. This cable distance must be less than 330 ft. (100m)
3. For cable length of more than 330 ft. (100m). Use HUB to amplify the signal.

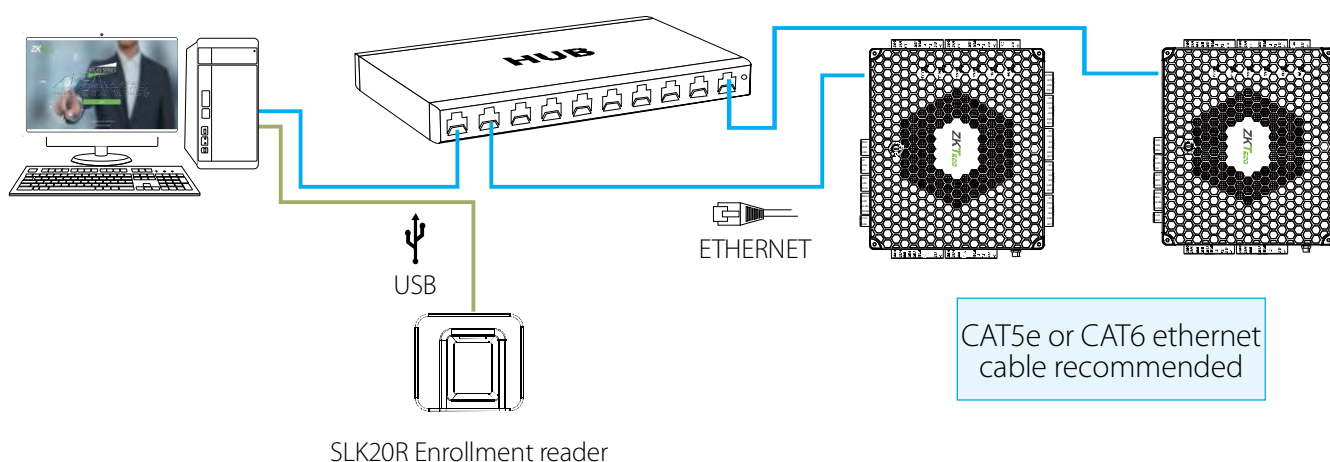

Figure 23

## Direct Connection

To connect Atlas-460 with a PC directly, connect both devices with a straight network cable. As the Atlas-460 supports auto MDI/MDIX, it is not necessary to use a crossover type cable.

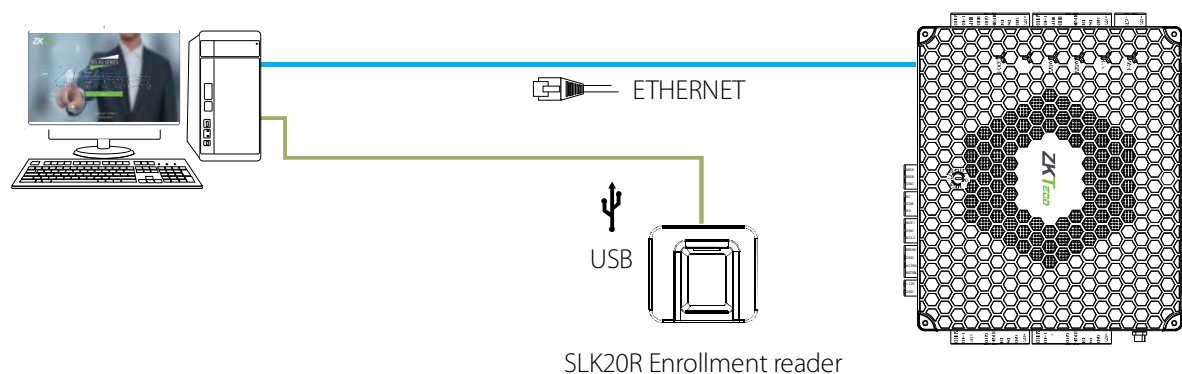

Figure 24

# Installation Diagram

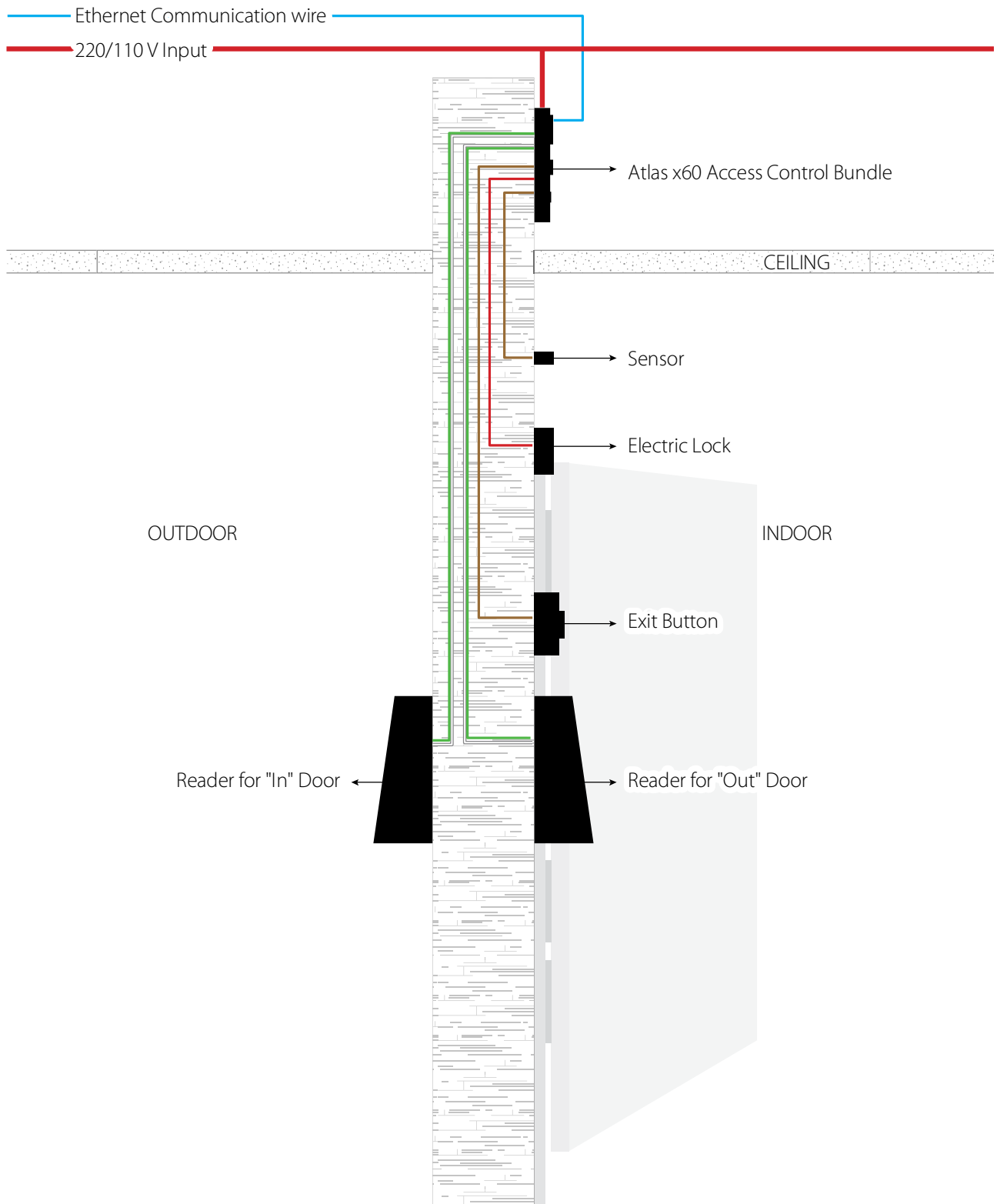

Figure 25

# Troubleshooting

## 1. How do I connect two-way doors?

- › Connect "Out" door readers as needed, in pairs with "In" door readers according to the following table.

Model	"In" Reader	Pairs with "Out" Reader
1-door	1	2
2-door	1	3
	2	4
4-door	1	5 (RS485 connection)
	2	6 (RS485 connection)
	3	7 (RS485 connection)
	4	8 (RS485 connection)

- › Connect door locks and sensors to the port for their "In" door.

›

and additional options.

## 2. What does it mean when I get "Access Denied (Unknown Format)?"

- › Your D0 and D1 wiring might be reversed.
- › The type of card you swiped might not be recognized. See "Add a User and Test Access" in the "Programming Guide."

## 3. How do I connect a third party reader or a stand-alone reader to an Atlas x60 panel?

- › Connect the wiegand output to the WD0 and WD1 of the stand-alone readers on the panel's reader port.

Note: The board can only supply 12 V DC, 300mA power so an external power supply may be required.

## 4. What kind of wire is recommended for the panel?

- › 16 or 18 AWG twisted shielded wire is recommended.

## 5. What is the default IP of the panel?

- › 169.254.202.242 - This is a "link local" IP address. See "Initial Controller Setup" in the "Programming Guide" for link local usage.

## 6. How long is the device under warranty?

- › 2 Years from original purchase date, replacement/repair of hardware under ZK standard warranty requires an evaluation of the failed system by a ZK Technical Support specialist, and the issuance of a Technical Support RMA number.

# Reader 485 Setting Table

	Switch Setting					
	1	2	3	4	5	6
Address No.	1	2	4	8	16	32
01	ON	OFF	OFF	OFF	OFF	OFF
02	OFF	ON	OFF	OFF	OFF	OFF
03	ON	ON	OFF	OFF	OFF	OFF
04	OFF	OFF	ON	OFF	OFF	OFF
05	ON	OFF	ON	OFF	OFF	OFF
06	OFF	ON	ON	OFF	OFF	OFF
07	ON	ON	ON	OFF	OFF	OFF
08	OFF	OFF	OFF	ON	OFF	OFF
09	ON	OFF	OFF	ON	OFF	OFF
10	OFF	ON	OFF	ON	OFF	OFF
11	ON	ON	OFF	ON	OFF	OFF
12	OFF	OFF	ON	ON	OFF	OFF
13	ON	OFF	ON	ON	OFF	OFF
14	OFF	ON	ON	ON	OFF	OFF
15	ON	ON	ON	ON	OFF	OFF
16	OFF	OFF	OFF	OFF	ON	OFF
17	ON	OFF	OFF	OFF	ON	OFF
18	OFF	ON	OFF	OFF	ON	OFF
19	ON	ON	OFF	OFF	ON	OFF
20	OFF	OFF	ON	OFF	ON	OFF
21	ON	OFF	ON	OFF	ON	OFF
22	OFF	ON	ON	OFF	ON	OFF
23	ON	ON	ON	OFF	ON	OFF
24	OFF	OFF	OFF	ON	ON	OFF
25	ON	OFF	OFF	ON	ON	OFF
26	OFF	ON	OFF	ON	ON	OFF
27	ON	ON	OFF	ON	ON	OFF
28	OFF	OFF	ON	ON	ON	OFF
29	ON	OFF	ON	ON	ON	OFF
30	OFF	ON	ON	ON	ON	OFF
31	ON	ON	ON	ON	ON	OFF
32	OFF	OFF	OFF	OFF	OFF	ON

	Switch Setting					
	1	2	3	4	5	6
Address No.	1	2	4	8	16	32
33	ON	OFF	OFF	OFF	OFF	ON
34	OFF	ON	OFF	OFF	OFF	ON
35	ON	ON	OFF	OFF	OFF	ON
36	OFF	OFF	ON	OFF	OFF	ON
37	ON	OFF	ON	OFF	OFF	ON
38	OFF	ON	ON	OFF	OFF	ON
39	ON	ON	ON	OFF	OFF	ON
40	OFF	OFF	OFF	ON	OFF	ON
41	ON	OFF	OFF	ON	OFF	ON
42	OFF	ON	OFF	ON	OFF	ON
43	ON	ON	OFF	ON	OFF	ON
44	OFF	OFF	ON	ON	OFF	ON
45	ON	OFF	ON	ON	OFF	ON
46	OFF	ON	ON	ON	OFF	ON
47	ON	ON	ON	ON	OFF	ON
48	OFF	OFF	OFF	OFF	ON	ON
49	ON	OFF	OFF	OFF	ON	ON
50	OFF	ON	OFF	OFF	ON	ON
51	ON	ON	OFF	OFF	ON	ON
52	OFF	OFF	ON	OFF	ON	ON
53	ON	OFF	ON	OFF	ON	ON
54	OFF	ON	ON	OFF	ON	ON
55	ON	ON	ON	OFF	ON	ON
56	OFF	OFF	OFF	ON	ON	ON
57	ON	OFF	OFF	ON	ON	ON
58	OFF	ON	OFF	ON	ON	ON
59	ON	ON	OFF	ON	ON	ON
60	OFF	OFF	ON	ON	ON	ON
61	ON	OFF	ON	ON	ON	ON
62	OFF	ON	ON	ON	ON	ON
63	ON	ON	ON	ON	ON	ON

# Electrical Specifications

	Minimum	Typical	Maximum	Notes
<b>WORKING POWER SUPPLY</b>				
Voltage (V) DC	9.6	12	14.4	Use regulated DC power adaptor only
Current (A)			2	
<b>ELECTRONIC LOCK RELAY OUTPUT</b>				
Switching voltage (V)		12V	30V	Use regulated DC power adaptor only
Switching Current (A)		2	3	
Auxiliary relay output				
Switching voltage (V)		12V	30V	Use regulated DC power adaptor only
Switching Current (A)		1.25	1.5	
<b>SWITCH AUX. INPUT</b>				
V <sub>IH</sub> (V)		TBD	30V	
V <sub>IL</sub> (V)		TBD		
Pull-		4.7k		The input ports are pulled up with 4.7k resistors
<b>WIEGAND INPUT</b>				
Voltage (V)	10.8	12	13.5	
Current (mA)			500	
<b>ZK ELECTRIC LOCK</b>				
Voltage (V) DC	10.8	12	13.2	
Current (mA)			500	



# Specifications

Communication	TCP/IP, OSDP
Baud Rate for RS485	9600-15200
Power Supply	12V DC, 3A
Users Capacity	5,000
Event Database Capacity	10,000 transactions, plus unlimited archive downloads
LED Indicator	Indicator for communication, power, status and prox card
Environment	32-113 °F (0-45°C)
Operating Humidity	20% to 80%
Number of doors controlled	Four Door (four door one way and two door two way)
Number of readers supported	4 Wiegand or 8 RS-485 or 8 OSDP
Types of readers supported	125kHz and 13.56MHz Wiegand readers, OSDP (RS-485), others upon request
Number of Inputs	10 (4 Exit Device, 4 Door Status, 2 AUX)
Number of Outputs	5 (4- Form C relay for lock and 1- Form C relay for AUX output)
Weight	Atlas-160: 9lbs (3.8kg); Atlas-260/460: 10lbs (4.2kg)
Enclosure	Metal Cabinet
Mounting	Wall Mount
Dimensions (Bundle Only)	14in. X 2.5in. X 12in. 380mm(L) X 80mm(W) X 280mm(H)
Dimensions (Board Only)	Atlas-160: 6.3in. X 4.17in. (160mm X 140mm) Atlas-260/460: 7.75in. X 6.73in. (197mm X 171mm)
CPU	32 bit 1.2GHz
RAM	256MB
Flash	1GB



# Atlas Series Web Management Application



## Programming Guide

Introduction.....	27
Understanding the Atlas Series Network.....	28
Initial Controller Setup.....	29
Connect the Controller to the Network.....	35
Complete the Configuration.....	36
Add a User and Test Access.....	40
Add Secondary Controllers.....	43
Mobile App.....	44
Special Considerations for Complex Networks.....	48
Where to Go Next.....	48

# Introduction

## Requirements

1. Obtain an available static IP address and configuration from the network administrator.
2. (Optional) Obtain a signed HTTPS certificate. This provides some additional security and avoids web browser warning messages. Supported certificate formats are PEM or PFX. See “Complete the Configuration,” below.
3. Find out whether using network time protocol (NTP) to automatically update the controller clock over the Internet is possible and acceptable, as well as whether non-standard time servers are used (such as corporate time servers). With a typical small network, it is safe to assume NTP will work with default Atlas Series settings.

## Procedure

1. Understand how an Atlas Series system networks together by reading the brief section, “Understanding the Atlas Series Network”.
2. Connect a computer directly to a controller and run the initial configuration program. This step must be completed before the controller will operate on the network.
3. Connect the controller to the local network.
4. Log in to the controller with a web browser and complete essential configuration.
5. Add a user and test door access.
6. Add any secondary controllers you are installing.

## Help

This guide refers you to online help topics for more detailed information. The help is available once you have connected the first controller and logged in to the Web Management Application. Open it by selecting “Help” from the menu in the upper right corner.

## Expected Browser Warnings

Your browser will display an insecure site warning each time you log in to the Web Management Application. The exact text of the warning, and the way to resolve it, varies among browser applications. You can prevent this warning by

# Understanding the Atlas Series Network

All Atlas Series systems have a single “primary” controller. Many “secondary” controllers may be added to support additional doors. All secondary controllers maintain a connection to the primary, and the primary provides all data and configuration the secondaries need to operate.

The primary controller provides a Web Management Application you can log into from a web browser. This application on the primary controller is where you will manage all configuration for the entire system.

**Important:** The primary controller must support biometrics if any biometric controller will be used in the system.

## Network Considerations

Ideally, all controllers should be networked on the same subnet. If you have a

more complex networks, be sure to review the “Special Considerations” discussed at the end of this document before proceeding.

# Initial Controller Setup

## Connecting

1. Connect the controller to DC power.
2. Connect an ethernet cable directly from your computer to the controller.
3. If your computer is set to use a static IP address, you will need to temporarily change it to one in the range 169.254.202.xxx, or to DHCP. If you normally use DHCP, skip this step. If you do not know, try assuming you use DHCP, which is common.
4. Open a web browser and enter the default controller address: **169.254.202.242**. You should get an insecure site warning from the browser (see above). After resolving the warning, you will be directed to the Web Management Application login screen. Note that it might take a minute for the connection to become available.

**Trouble Connecting:** If at any point you find you cannot connect to the controller at the default IP address, or the address you configure, below, you can try a hard network reset. Find the small opening on the controller labeled "Reset." Insert a paperclip to depress the button for 5-10 seconds. The controller address will revert to the default, 169.254.202.242, until rebooted, reset, or the configuration is modified.

## Running the Setup Wizard

Log in using the default administrator account:

- User name: admin
- Password: admin

You will be directed to the Setup Wizard, where you will enter information required for the controller to operate.

# Initial Controller Setup

## Page 1: Language



Choose a language. Your choice will be used for this wizard. It will also become the default language of the Web Management Application. This can be changed later in the hardware configuration of the primary controller.

Note: For secondary controllers, Language does not affect the Web Management Application. It does set the language of the simplified management application on this controller, and can be changed later in the configuration of this controller.

## Page 2: Function

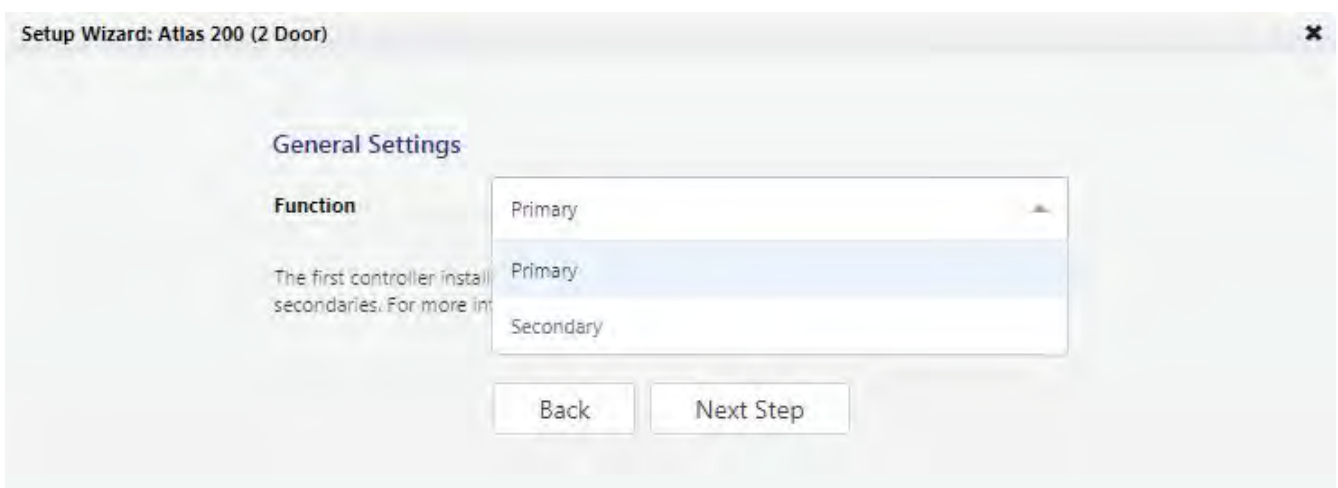

Choose whether this controller will be a "Primary" or a "Secondary". Make sure the first controller installed should be a primary, and all others should be secondaries.

# Initial Controller Setup

## Page 3: Primary Controller Name (primaries only)

Setup Wizard: Atlas 200 (2 Door)

**Primary Controller Settings**

**Primary Controller Name**

This changes only how your controller appears in lists and reports.

The name of the controller will be used for display in the Web Management Application and in reports.

Note: secondary controllers are named when they are connected to the system in the Web Management Application.

## Page 4: Configuration (primaries only)

Setup Wizard: Atlas 200 (2 Door)

**Primary Controller Settings**

**Configuration**

Select from one of the configurations. This configuration cannot be changed after installation.

- In Only
- Door 1 In/Out; Door 2 In Only
- Door 1 In Only; Door 2 In/Out
- Both Doors In/Out

This determines what your controller will be used for: controlling door entry, perhaps door exit, or as special purpose readers.

system.

# Initial Controller Setup

Configuration options available depend on the controller model. Each option will involve one or more of the following possibilities. Each possibility determines the function of the card, PIN, or biometric readers connected to the controller. The configuration can be modified during “Complete the Configuration,” below.

**In Only** - This the most common configuration, where a reader is used to gain entry, but no credentials are required to exit (although an exit button may be configured for opening the door from the inside).

other purpose, though you may choose not to use it.

**In/Out** - The physical door will have a reader both inside and outside. Authorization is required to pass either direction.

+ **Muster Point** - The second reader will serve as a muster point, where users can register that they have reached a safe location.

+ **Card Enrollment Point** - The second reader will be used to easily enter card numbers when adding users.

## Page 5: Time Zone (primaries only)





# Initial Controller Setup

Select your time zone. In most cases you will never need to set the actual time; the controller will get the time from the internet using a technology called NTP.

Note: Secondary controllers get their time and time zone from the primary controller.

## Page 6: Password (primaries only)

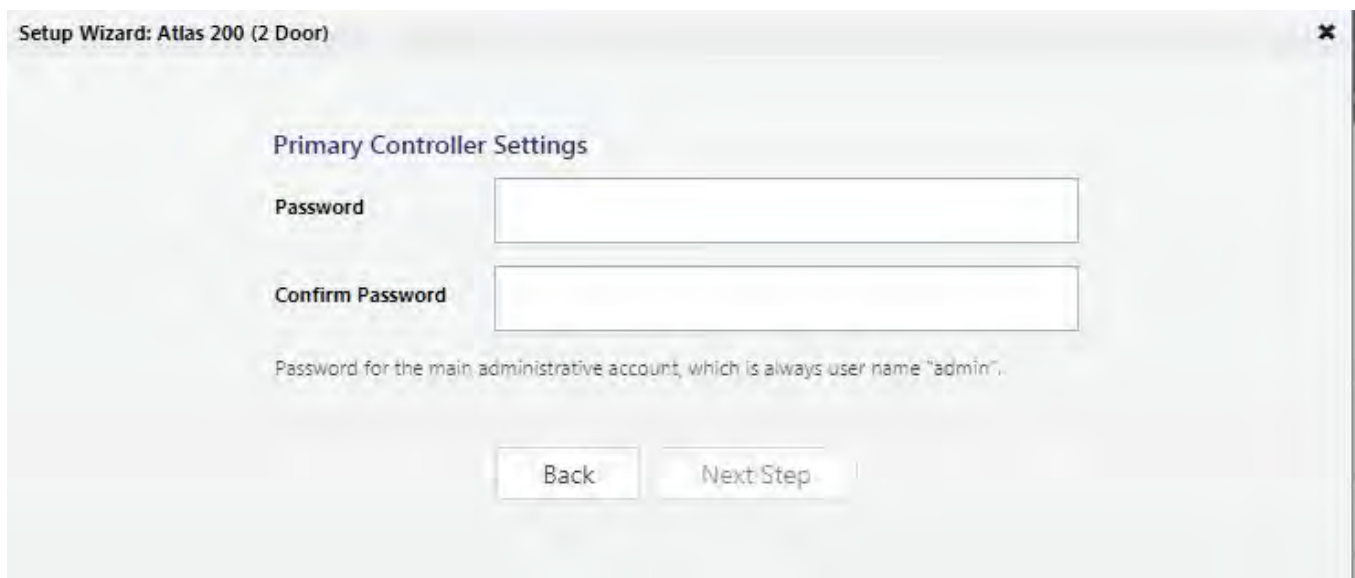

Setup Wizard: Atlas 200 (2 Door)

**Primary Controller Settings**

**Password**

**Confirm Password**

Password for the main administrative account, which is always user name "admin".

Enter a strong password for the primary administrator account. The user name for this account is "admin" and cannot be changed.

# Initial Controller Setup

## Page 7: Network Interface Settings

The screenshot shows a web-based configuration window titled "Setup Wizard: Atlas 200 (2 Door)". The main heading is "Network Interface Settings". The form contains the following fields and options:

- Name:** Ethernet
- Configure IPv4:** A dropdown menu with "Manually" selected. A tooltip is visible: "Primary controllers must have a static IP address. For secondary controllers, we recommend using DHCP." Other options in the menu are "Manually" and "Using DHCP".
- IP Address:** 192.168.0.102
- Subnet Mask:** 255.255.255.0
- Gateway:** 192.168.0.1
- DNS Servers:** Two empty text input fields.
- Search Domains:** Two empty text input fields.

At the bottom of the form are two buttons: "Back" and "Next Step".

The important choice here is "Configure IPv4."

A primary controller must have a static IP address. This is because secondary controllers need to know how to find the primary on the network. Additionally, the users need a consistent address to log in to the Web Management Application.

To assign a static IP address, choose "Manually" and enter the IP address and con-

"Using DHCP" is probably the right choice for secondary controllers, unless you have a complicated network discussed below under "Special Considerations for Complex Networks."

**Wireless Networking:** If your controller model supports WiFi, you still need to set up a wired connection, here. You can add your wireless connection once you are logged in to the Web Management Application. See the online help topic, "Administration: Network".

### Page 8: Review

All your entries are displayed for review. Click either "Back" or "Complete Setup." After completing setup, you may disconnect the direct ethernet cable.

## Connect the Controller to the Network

When you "Complete Setup," the controller will reboot itself automatically. If it is already installed, then simply reconnect it's ethernet port to the local area network.

Otherwise, disconnect the controller and complete the physical installation. Connect it to the local area network via ethernet.

# Complete the Configuration

Open a web browser and enter the IP address you specified in Network Interface Settings during initial setup. This will direct you to the login screen of the Web Management Application. Enter "admin" as the user, and use the password you set during initial configuration. The application Dashboard will appear. Expect to see green status, indicating everything has completed correctly to this point.

## Review Time Settings (optional)

By default, the primary controller will use network time protocol (NTP) to automatically update the controller clock over the internet. This might not work due to local policies or because your controller does not have internet access.

If you need to change this configuration go to "Admin → Date and Time."

- To disable NTP, uncheck "Update Date and Time Automatically." When this box is not checked, you can manually set the time by checking "Set Server Time to Current Browser Time" and clicking **Save**.
- If you wish to use NTP, but with customized NTP servers, there is space to enter those server addresses. The default servers are: "0.pool.ntp.org," "1.pool.ntp.org," "1.pool.ntp.org," and "3.pool.ntp.org."
- You can also turn off the use of Daylight Savings Time.

## Registration (optional)

Registration is required if you ever need to reset your system password, and optionally allows ZKTeco to contact you about software updates and other information. Follow these steps to register for the first time or to update your registration information.

1. Registration can be started in two ways:
  - When you log in the first time, click **Register Now** in the "Register Your Product" pop-up window, or
  - Select "Menu About," and click the **Register** button. (If you have previously registered, the link is "Update Registration.")
2. Click **New Registration** button in the next pop-up window. (If you have previously registered, the button is "View/Update Registration.")

# Complete the Configuration

3. Fill in the registration information. Asterisks indicate required information. The email address you enter must be able to receive your registration information.
4. Submit your registration automatically or by email.
  - a. For automatic registration, click **Submit Online** button. You will see a progress window followed by a success message.
  - b. For email registration:
    - i. Click **Offline Registration** button. Read the instructions in the following window.
    - ii. Click **Download registration file** link, and save the registration data file to your computer.
    - iii. Create and send an email message by clicking the email link or entering it in your email program. Your email must contain the registration data file as an attachment, with its original name. The subject and text of the email do not matter.

You will receive a registration confirmation file by reply email. When you do,

1. Open the email and save the attachment to your computer.
2. Click **Upload Confirmation** button. (If you have already exited from registration, then return to this option by selecting "Menu → About" and clicking the **Register** button.)
- 3.

You should see a "Registration successful" message window.

# Complete the Configuration

## Fine Tune Hardware Configuration

Configuration is discussed in detail in the online help topic, "Configuration: Hardware." Topics mentioned below are found within that section.

Go to "Config → Hardware." The list on the left shows all controllers. (At this point, you should see one, the primary.) Each controller has an "I/O" sub-controller listed beneath it. The controller item manages general controller configuration, while the sub-controller manages detailed configuration of the readers, inputs, and outputs.

Click the controller and review the configuration. Note under "Managed Doors" that doors were automatically created to match the controller configuration you chose earlier. Every reader is represented as a door, whether its function is in, out, card enrollment point, or muster point. You might need to:

- Add more readers using the "Modify" button on the menu bar. Details about this operation are in the topic, "Modifying Controller Configuration". The Modify options are:
  - "Change to In/Out"
  - "Add Muster Point"
  - "Add Card Enrollment Point"
  - "Remove Secondary, Muster, or Card Enrollment Point"
- Change the default connection type for readers (Wiegand, OSDP, or ZKTeco RS-485). These settings are on the sub-controller, and are detailed in the topic, "Hardware Properties". The defaults vary by model and are listed in the topic, "Models and Configurations". Note that OSDP and ZKTeco RS-485 cannot be combined on the single RS-485 port.
- Change the connection properties of inputs and outputs and configure optional functionality of auxiliary inputs and outputs. These settings are on the sub-controller, and are detailed in the topic, "Hardware Properties".

## Configure Doors

Go to "Config → Doors". Every reader is represented as a door, whether its function is in, out, card enrollment point, or muster point.

For In and Out doors, change the "Default Mode" to set the door's normal locking state.

For In doors, review the lock timings and behaviors under "Operation".

# Complete the Configuration

Card enrollment and muster doors usually need little configuration.

See the online help topic, "Configuration: Doors", for more advanced configuration, such as

- changing door mode on a schedule,
- anti-passback, and
- applying the same settings to multiple doors

## Install a Fingerprint Enrollment Reader (optional)

If you are using biometric readers, a ZKTeco USB fingerprint enrollment reader must be installed at any computer where fingerprints will be enrolled.

1. Plug the device into any USB port.
2. Install the Fingerprint Driver software (available on the Downloads page at ZKTecoUSA.com)

## Install a Signed Certificate (optional)

To provide extra security for the controller, and to avoid browser warnings when logging in, you might wish to install a signed HTTPS security certificate. For more information on what this means, and to get such a certificate, talk to your IT department.

Even if you do not install a signed certificate, all communications will still be encrypted.

To install a certificate:

1. Obtain a certificate file in .PEM or .PFX format and copy it to your computer.
2. Select "Admin → Web Server Settings."
3. Click **Upload Certificate**.
- 4.

# Add a User and Test Access

1. Go to "Access → Users."
2. Click **Create** on the menu bar.
3. Enter the following minimum required information:
  - First Name
  - Last Name
  - (To test cards) Scroll down to "Cards," click the **Add** button, then enter the number of a card.
  - (To test biometrics) Scroll down to "Number of Enrolled Fingerprints," click "Enroll Fingerprints," and follow the on-screen instructions. You must have installed a USB fingerprint enrollment reader during "Com-

The screenshot shows the user creation interface. The 'Cards' section contains a table with columns 'Card Number' and 'Enabled'. To the right of the table are '+ Add' and 'Remove' buttons. Below this is the 'Number of Enrolled Fingerprints' section, which shows '0' and buttons for 'Enroll Fingerprints' (highlighted with a blue box) and 'Delete All Fingerprints'. Below that is the 'PIN' section with a text input field, an eye icon, and 'Create New' and 'Clear' buttons. The 'Duress PIN Type' is set to 'None' in a dropdown menu. There is also a checkbox for 'Use Extended Door Times' which is unchecked.

The 'Enroll Fingerprints' dialog box is shown below, with the instruction 'Please press the selected finger 3 times.' and three progress bars. It features two hand icons: the left hand is a simple outline, and the right hand has the index finger highlighted in yellow. A 'Close' button is located in the bottom right corner of the dialog.



# Add a User and Test Access

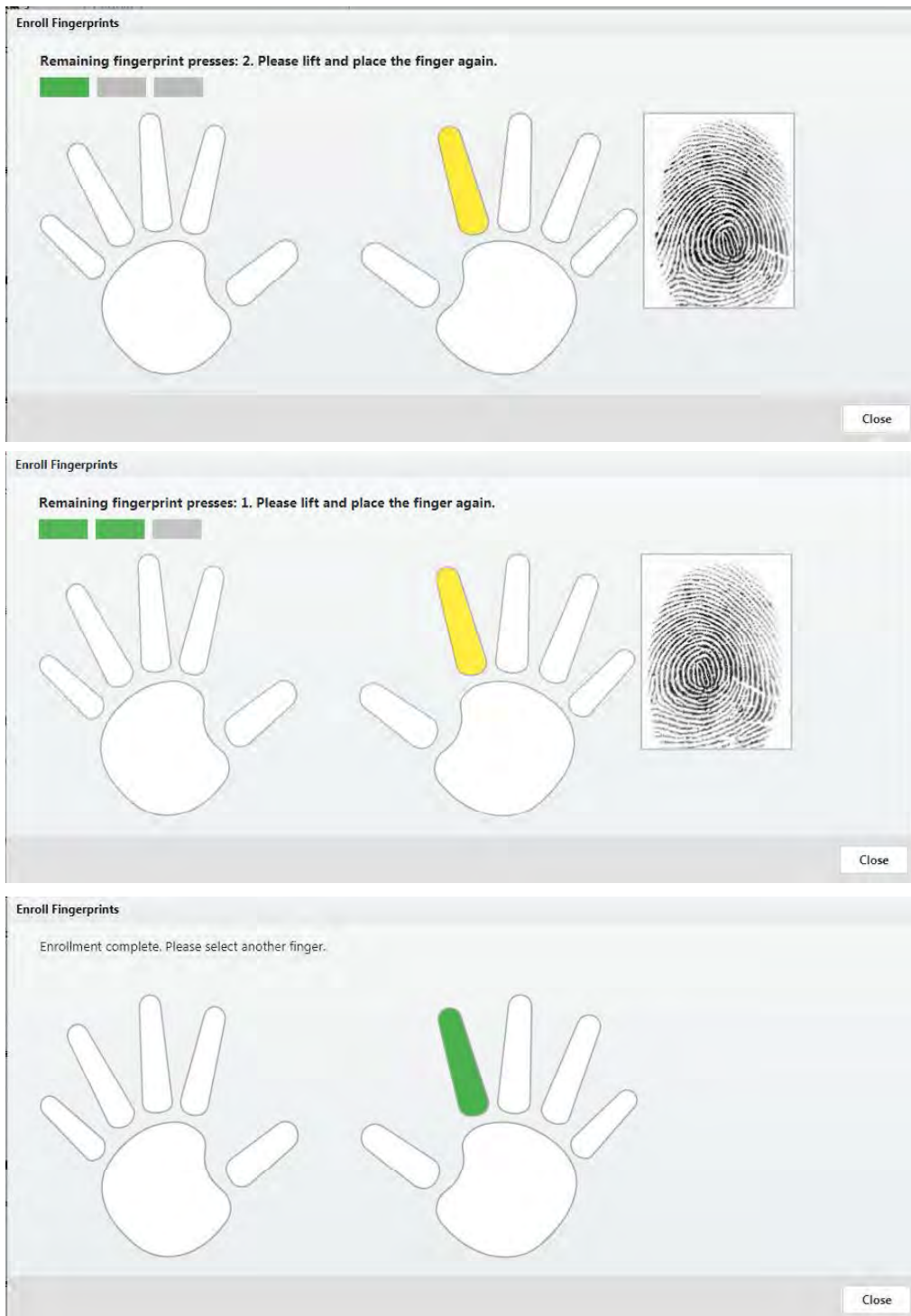

- (To test PINs) Scroll down to "PIN" and either enter a 4 digit number or use the "Create New" button to generate a random value.
- 4. Scroll down to "Door Access." Click the **Add** button and select 1 or more doors on the following screen.
- 5. Click **Save** on the menu bar.

The card, PIN, and fingerprint you entered should now work to grant access at the specified doors, assuming you chose a compatible "Default Mode" during

# Add a User and Test Access

To test access, you will (1) create an access level, (2) create a user, (3) give the user card, PIN, and/or biometric credentials, and (4) assign the access level to the user.

First:

1. Go to “Access → Access Levels.”
2. Click “Create” on the menu bar.
3. Enter a “Name” for the access level.
4. Click the “Add” button.
5. In the pop-up window, select one or more doors that this access level will provide access to, and click “OK.”
6. On the “Access Levels” screen, notice that each door has been added to the list with a schedule during which access will be granted. The default schedule, “24/7,” provides access at all times. Schedules are explained further in the online help.
7. Click “Save” on the menu bar.

Then:

1. Go to “Access → Users.”
2. Scroll down to “Access Levels.” Click the **Add** button and select the access level you created, above.
3. Click **Save** on the menu bar.

The card, PIN, and fingerprint you entered should now work to grant access to the specified doors during the specified schedules, assuming you chose a compatible “Default Mode” during “Configure Doors.”

Card formats that work out of the box are Wiegand (26, 34, 37, or 50 bits) and Corporate 1000 (35 bit). For other formats, see the online help topic, “Configuration: Card Formats.”

More sophisticated ways to grant access to users are discussed in the online help under the main topic, “Access Control.”

Card numbers can be more easily entered by using enrollment points. See the online help topic, “Features and Tasks: Card Enrollment Points.”

The number of digits for PINs can be changed in “Admin System Settings.”

# Add Secondary Controllers

## Step 1: Initial Setup

Follow the instructions under “Initial Controller Setup,” above, for each controller. This will configure the controller for connection to the network.

## Step 2: Add the Controller in the Web Management Application

Secondary controllers can be automatically found and added by the Web Management Application. This is called “Discovery.”

There are two important qualifications about Discovery.

- When using Discovery, you should connect and discover controllers one at a time. This is the only way you can differentiate them.
- Discovery only works if all controllers are networked on the same subnet. If you have a simple network, this will almost always be true. In a larger corporate environment, you might need to add secondary controllers manually. See “Special Considerations...,” below.

To discover secondary controllers:

1. Log in to the Web Management Application (on the primary controller).
2. Go to “Config → Hardware.”
3. Click **Discover Controllers** on the menu bar.
4. In a few moments, a form will display all controllers discovered.
5. Click the link to add a controller. The create controller screen will appear.
  - a.
  - b. Enter a “Name,” and select “Custom Door Names” so you can name the doors.
  - c. Leave all other settings as they are. These are the settings that were discovered.
  - d. Click **Save** on the menu bar.

# Mobile App

ZKTeco provides its “Atlas” mobile app in Apple’s “App Store” and in “Google Play.” You must authorize each mobile device before it can access your system.

In the Web Management Application:

1. Go to “Admin → Authorized Mobile Devices.”

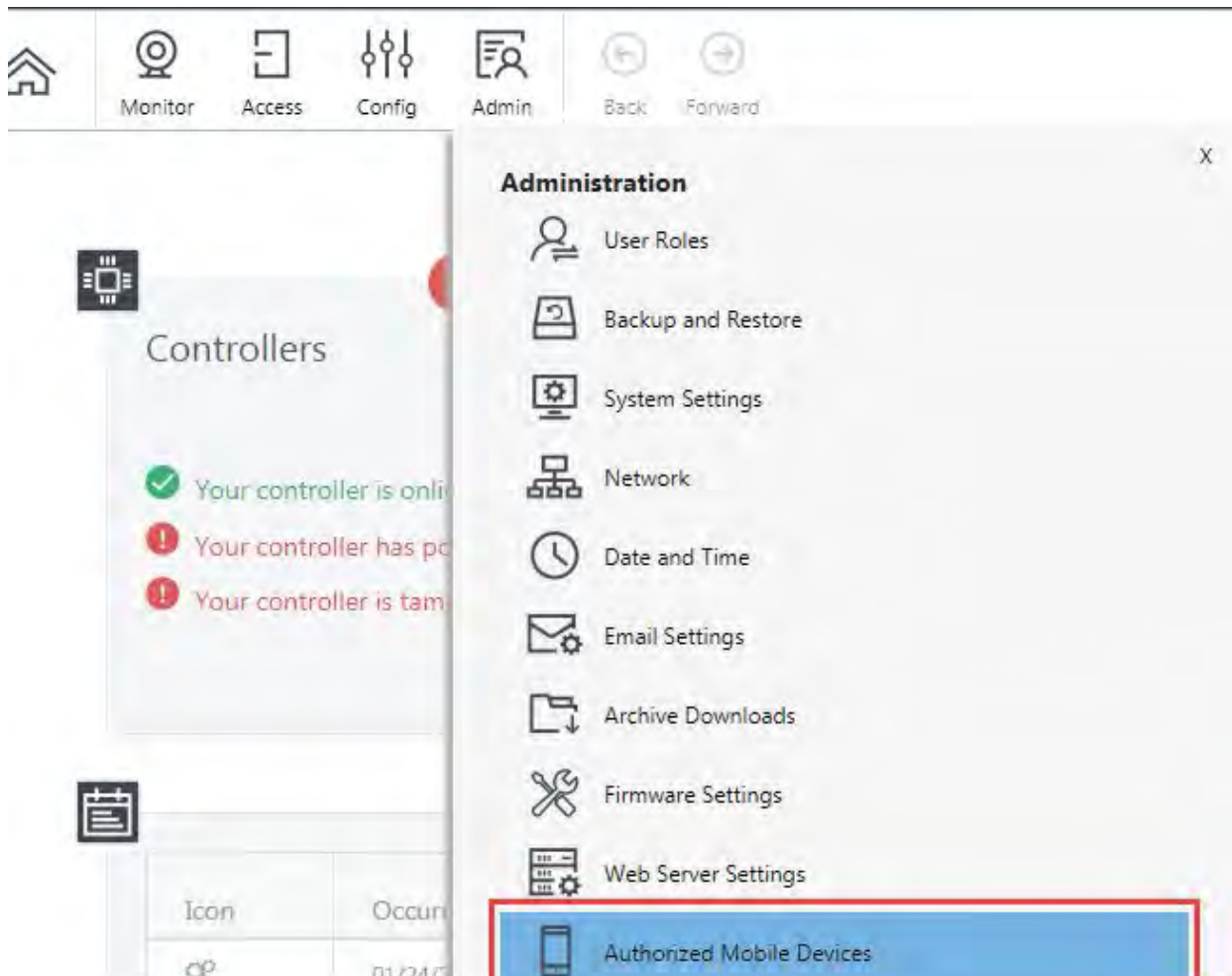

2. **Create** and **Save** an authorization.

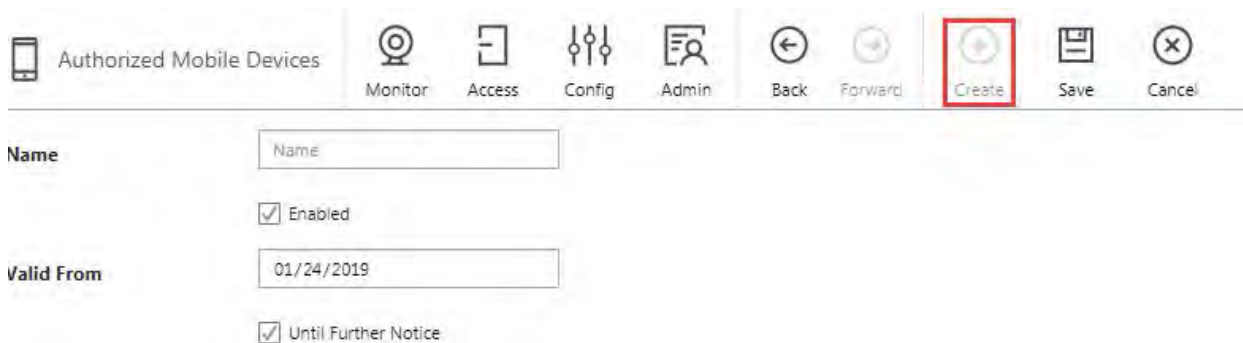

# Mobile App

3. A QR code image will be displayed in the “Authorization Code” field.
  - Leave this open for scanning, below, or
  - right click the image to save it. You can then email the image to the mobile device user.

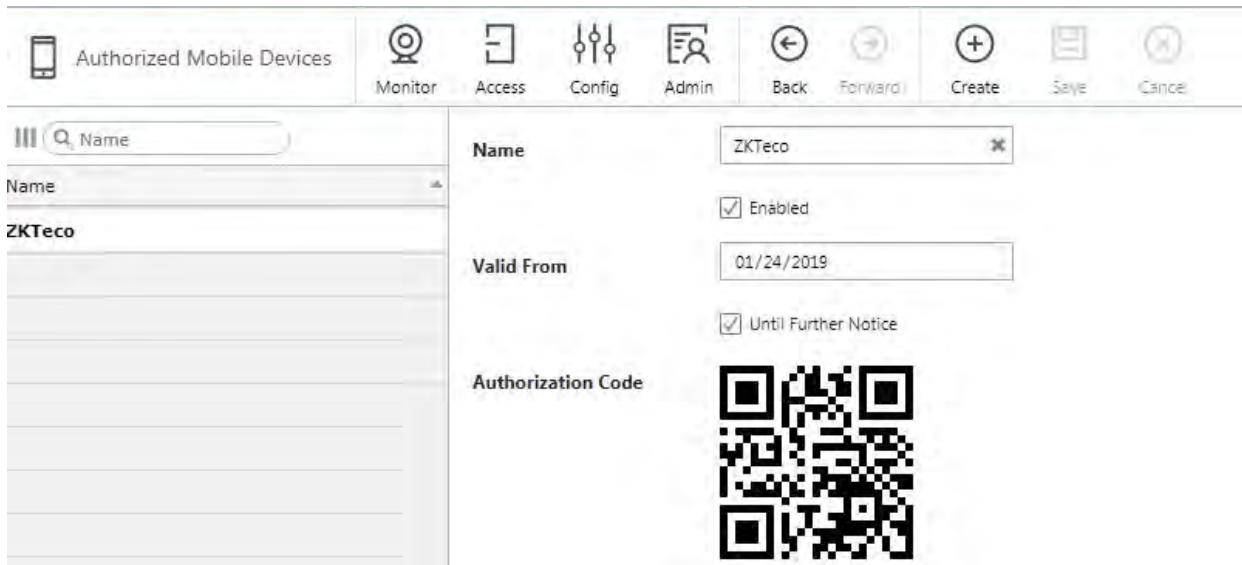

On the mobile device:

1. Install and run the “Atlas” mobile app.
2. Press **Scan QR Code**.

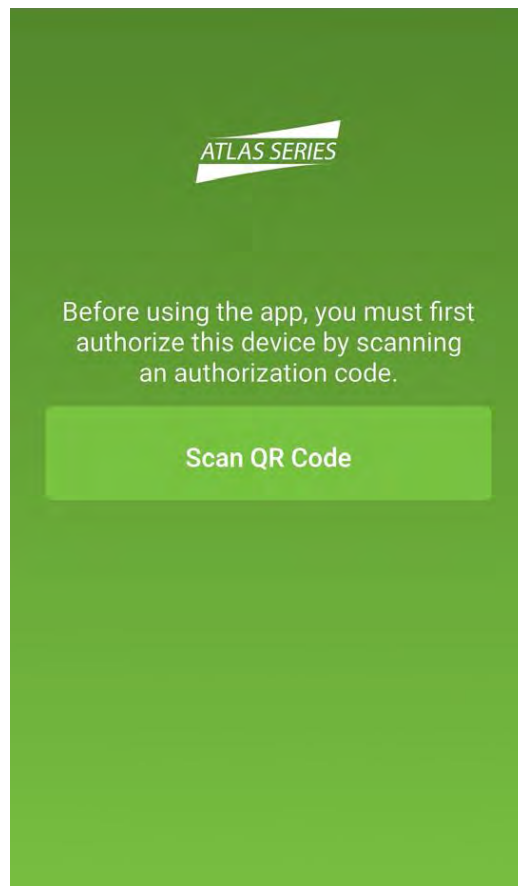

# Mobile App

3. You might have to confirm that Atlas may use the camera.

4.

of the authorization QR code. A picture will be taken automatically when a QR code is within the box, showing the message, "Authorization code successfully located."

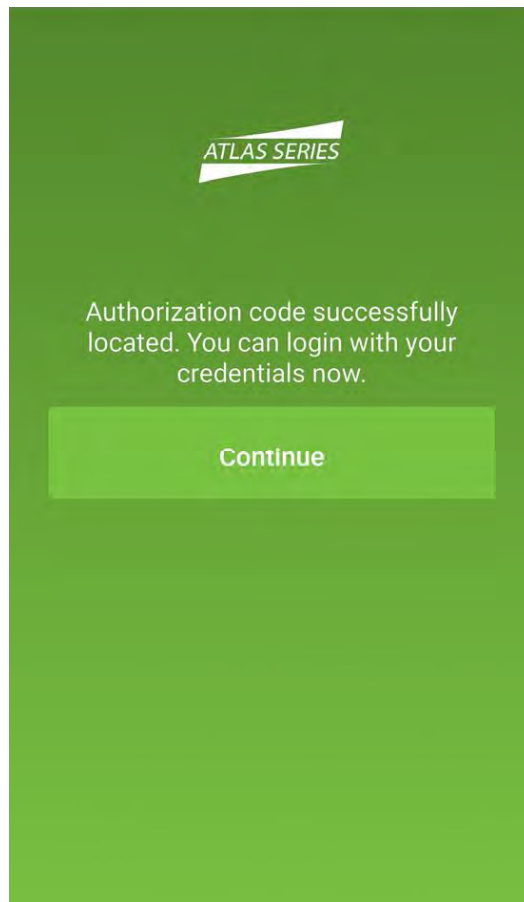

# Mobile App

5. The “Sign In” screen is next. Enter the “Server Address” of the primary Atlas Series controller. Enter your Atlas Series “Username” and “Password.” Press **Sign In**.

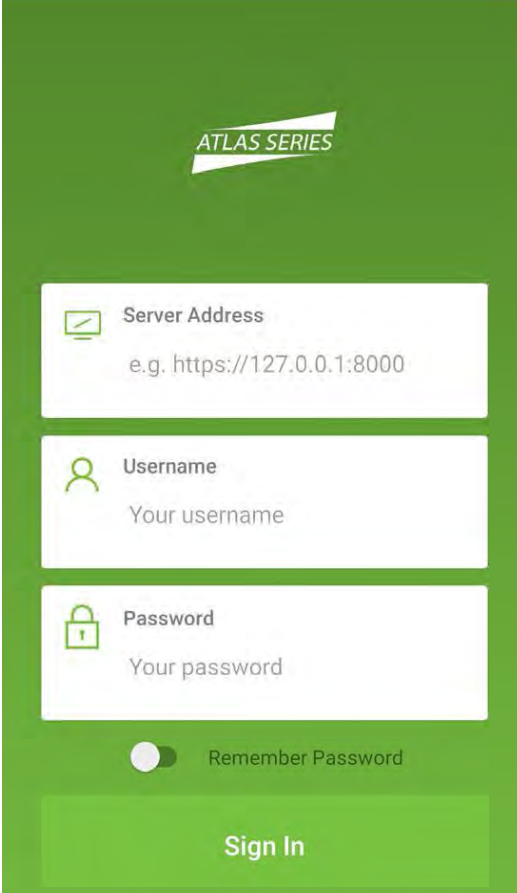

6. Once signed in you will see a list of everything you can do, including viewing alarms or status and initiating emergency lockdown.

**Important:** The mobile device must be connected by WiFi to the same local network as the Atlas Series controllers. To connect from a distance, your network administrator must in some way open access from the Internet (such as by using a NAT) and provide the necessary “Server Address.”

Each authorization code can authorize only one mobile device. You may delete and add authorizations as needed to support several devices. The number of devices you can authorize is limited by your license.

## Special Considerations for Complex Networks

If all Atlas Series controllers cannot be located on one network subnet, or if Discovery is blocked by network restrictions, observe the following.

- There is no difference in the way you set up the primary controller.
- During “Initial Controller Setup” of secondary controllers on other subnets, do not select DHCP as normally recommended. Assign these controllers static IP addresses.
- Manually add these secondary controllers in the Web Management Application. Log in and read “Manually Adding Secondary Controllers” in the help topic, “Configuration: Hardware: Adding Controllers.”

## Where to Go Next

A complete user manual is available through the Management Application by selecting “Help” from the menu in the upper right corner.

The help’s “Introduction” page will guide you to more information on operating door access, using emergency features, and more.



# FCC

This device complies with part 15 of the FCC Rules. Operation is subject to the following two conditions: (1) This device may not cause harmful interference, and (2) this device must accept any interference received, including interference that may cause undesired operation.

Any Changes or modifications not expressly approved by the party responsible for compliance could void the user's authority to operate the equipment.

Note: This equipment has been tested and found to comply with the limits for a Class B digital device, pursuant to part 15 of the FCC Rules. These limits are designed to provide reasonable protection against harmful interference in a residential installation. This equipment generates uses and can radiate radio frequency energy and, if not installed and used in accordance with the instructions, may cause harmful interference to radio communications. However, there is no guarantee that interference will not occur in a particular installation. If this equipment does cause harmful interference to radio or television reception, which can be determined by turning the equipment off and on, the user is encouraged to try to correct the interference by one or more of the following measures:

- Reorient or relocate the receiving antenna.
- Increase the separation between the equipment and receiver.

the receiver is connected.

- Consult the dealer or an experienced radio/TV technician for help.

This equipment complies with FCC radiation exposure limits set forth for an uncontrolled environment. This equipment should be installed and operated with minimum distance 20cm between the radiator & your body.



ZKTecousa - a division of ZKTeco  
6 Kingsbridge Rd Unit 8  
Fairfield NJ 07004 USA  
Tel: 862-505-2101  
[www.zktecousa.com](http://www.zktecousa.com)

Date: Jan. 2019