

FCC 47 CFR PART 15 SUBPART C

CERTIFICATION TEST REPORT

For

Fingerprint Lock

MODEL No.: AL20B, AL20DB

FCC ID: 2AJ9T-AL20B

Trade Mark: N/A

REPORT NO: ES180628001W

ISSUE DATE: July 16, 2018

Prepared for

ZKTECO CO.,LTD.

No.26,Pingshan 188 Industry zone,Tangxia Town,Dongguan City,Guangdong
Province,China 523728

Prepared by

EMTEK(SHENZHEN) CO., LTD.

Bldg 69, Majialong Industry Zone, Nanshan District, Shenzhen,
Guangdong, China

TEL: 86-755-26954280

FAX: 86-755-26954282

Table of Contents

1	TEST RESULT CERTIFICATION	3
2	EUT TECHNICAL DESCRIPTION	4
3	SUMMARY OF TEST RESULT	5
4	TEST METHODOLOGY	6
4.1	GENERAL DESCRIPTION OF APPLIED STANDARDS	6
4.2	MEASUREMENT EQUIPMENT USED	6
4.3	DESCRIPTION OF TEST MODES.....	6
5	FACILITIES AND ACCREDITATIONS	8
5.1	FACILITIES	8
5.2	LABORATORY ACCREDITATIONS AND LISTINGS	8
6	TEST SYSTEM UNCERTAINTY	9
7	SETUP OF EQUIPMENT UNDER TEST	10
7.1	RADIO FREQUENCY TEST SETUP 1.....	10
7.2	RADIO FREQUENCY TEST SETUP 2.....	10
7.3	SUPPORT EQUIPMENT	11
8	TEST REQUIREMENTS	12
8.1	DTS 6DB BANDWIDTH	12
8.2	MAXIMUM PEAK CONDUCTED OUTPUT POWER	15
8.3	MAXIMUM POWER SPECTRAL DENSITY	16
8.4	UNWANTED EMISSIONS IN NON-RESTRICTED FREQUENCY BANDS	19
8.5	RADIATED SPURIOUS EMISSION	24
8.6	ANTENNA APPLICATION	36

1 TEST RESULT CERTIFICATION

Applicant:	ZKTECO CO.,LTD. No.26,Pingshan 188 Industry zone,Tangxia Town,Dongguan City,Guangdong Province,China 523728
Manufacturer:	ZKTECO CO.,LTD. No.26,Pingshan 188 Industry zone,Tangxia Town,Dongguan City,Guangdong Province,China 523728
EUT Description:	Fingerprint Lock
Model Number:	AL20B, AL20DB (Note: These models are identical in circuitry and electrical, mechanical and physical construction; the only differences are the model number. for trading purpose. We prepare AL20B for test.)
Trade Mark:	N/A
File Number:	ES180628001W
Date of Test:	June 28, 2018 to July 16, 2018

Measurement Procedure Used:

APPLICABLE STANDARDS	
STANDARD	TEST RESULT
FCC 47 CFR Part 2, Subpart J FCC 47 CFR Part 15, Subpart C	PASS

The above equipment was tested by EMTEK(SHENZHEN) CO., LTD. The test data, data evaluation, test procedures, and equipment configurations shown in this report were made in accordance with the procedures given in ANSI C63.10 (2013) and the energy emitted by the sample EUT tested as described in this report is in compliance with the requirements of FCC Rules Part 2 and Part 15.247

The test results of this report relate only to the tested sample identified in this report

Date of Test : June 28, 2018 to July 16, 2018

Prepared by : *Yaping Shen*
Yaping Shen /Editor

Reviewer : *Joe Xia*
Joe Xia/Editor

Approve & Authorized Signer : *[Signature]*
Lisa Wang/Manager



2 EUT TECHNICAL DESCRIPTION

Characteristics	Description
Product:	Fingerprint Lock
Model Number:	AL20B, AL20DB
Data Rate:	<input checked="" type="checkbox"/> BT-LE 1Mbps for GFSK modulation
Modulation:	<input checked="" type="checkbox"/> BT-LE GFSK
Operating Frequency Range(s):	<input checked="" type="checkbox"/> BT-LE 2402-2480MHz
Number of Channels:	<input checked="" type="checkbox"/> BT-LE 40 channels
Transmit Power Max:	<input checked="" type="checkbox"/> BT-LE 4.06 dBm
Antenna Type:	PCB antenna
Gain:	0 dBi
Power supply:	<input checked="" type="checkbox"/> DC supply: DC 6V by 1.5*4AA battery
	<input type="checkbox"/> Adaptor supply:
Temperature Range	-20°C ~ +55°C

Note: for more details, please refer to the User's manual of the EUT.

3 SUMMARY OF TEST RESULT

FCC Part Clause	Test Parameter	Verdict	Remark
15.247(a)(2)	DTS (6dB) Bandwidth	PASS	
15.247(b)(3)	Maximum Peak Conducted Output Power	PASS	
15.247(e)	Maximum Power Spectral Density Level	PASS	
15.247(d)	Unwanted Emission Into Non-Restricted Frequency Bands	PASS	
15.247(d) 15.209	Unwanted Emission Into Restricted Frequency Bands (conducted)	PASS	
15.247(d) 15.209	Radiated Spurious Emission	PASS	
15.207	Conducted Emission Test	N/A	
15.247(b)	Antenna Application	PASS	
	NOTE1: N/A (Not Applicable) NOTE2: According to FCC OET KDB 558074, the report use radiated measurements in the restricted frequency bands. In addition, the radiated test is also performed to ensure the emissions emanating from the device cabinet also comply with the applicable limits.		

RELATED SUBMITTAL(S) / GRANT(S):

This submittal(s) (test report) is intended for FCC ID: 2AJ9T-AL20B filing to comply with Section 15.247 of the FCC Part 15, Subpart C Rules.

4 TEST METHODOLOGY

4.1 GENERAL DESCRIPTION OF APPLIED STANDARDS

According to its specifications, the EUT must comply with the requirements of the following standards:
 FCC 47 CFR Part 2, Subpart J
 FCC 47 CFR Part 15, Subpart C
 FCC KDB 558074 D01 DTS Meas Guidance v04

4.2 MEASUREMENT EQUIPMENT USED

4.2.1 Radiated Emission Test Equipment

EQUIPMENT TYPE	MFR	MODEL NUMBER	SERIAL NUMBER	LAST CAL.	DUE CAL.
EMI Test Receiver	Rohde & Schwarz	ESU	1302.6005.26	May 20, 2018	May 20, 2019
Pre-Amplifier	HP	8447F	2944A07999	May 20, 2018	May 20, 2019
Bilog Antenna	Schwarzbeck	VULB9163	142	May 20, 2018	May 20, 2019
Cable	Schwarzbeck	AK9513	ACRX1	May 20, 2018	May 20, 2019
Cable	Rosenberger	N/A	FP2RX2	May 20, 2018	May 20, 2019
Cable	Schwarzbeck	AK9513	CRPX1	May 20, 2018	May 20, 2019
EMI Test Receiver	Rohde & Schwarz	ESU	1302.6005.26	May 20, 2018	May 20, 2019
Pre-Amplifier	A.H.	PAM-0126	1415261	May 20, 2018	May 20, 2019
Horn Antenna	Schwarzbeck	BBHA 9120	707	May 20, 2018	May 20, 2019
Loop Antenna	Laplace Instrument Ltd	RF300	8006	May 20, 2018	May 20, 2019
Cable	H+B	0.5M SF104-26.5	289147/4	May 20, 2018	May 20, 2019
Cable	H+B	3M SF104-26.5	295838/4	May 20, 2018	May 20, 2019
Cable	H+B	6M SF104-26.5	295840/4	May 20, 2018	May 20, 2019

4.2.2 Radio Frequency Test Equipment

EQUIPMENT TYPE	MFR	MODEL NUMBER	SERIAL NUMBER	LAST CAL.	DUE CAL.
Spectrum Analyzer	Agilent	E4407B	88156318	May 20, 2018	May 20, 2019
Signal Analyzer	Agilent	N9010A	My53470879	May 20, 2018	May 20, 2019
Power meter	Anritsu	ML2495A	0824006	May 20, 2018	May 20, 2019
Power sensor	Anritsu	MA2411B	0738172	May 20, 2018	May 20, 2019
Spectrum Analyzer	Rohde & Schwarz	FSV40	100967	May 20, 2018	May 20, 2019

Remark: Each piece of equipment is scheduled for calibration once a year.

4.3 DESCRIPTION OF TEST MODES

The EUT has been tested under its typical operating condition.

The EUT configuration for testing is installed on RF field strength measurement to meet the Commissions requirement and operating in a manner which intends to maximize its emission characteristics in a continuous normal application.

The Transmitter was operated in the normal operating mode. The TX frequency was fixed which was for the purpose of the measurements.

Test of channel included the lowest and middle and highest frequency to perform the test, then record on this report.

Those data rates (Bluetooth v4.0 with BLE mode :1Mbps) were used for all test.

Pre-defined engineering program for regulatory testing used to control the EUT for staying in continuous transmitting and receiving mode is programmed.

Frequency and Channel list for Bluetooth v4.0 with BLE mode:

Channel	Frequency (MHz)	Channel	Frequency (MHz)	Channel	Frequency (MHz)
0	2402	19	2440
1	2404	20	2442	37	2476
2	2406	21	2444	38	2478
...	39	2480
Note: $f_c = 2402\text{MHz} + k \times 1\text{MHz}$ $k=1$ to 39					

Test Frequency and channel for Bluetooth v4.0 with BLE mode:

Lowest Frequency		Middle Frequency		Highest Frequency	
Channel	Frequency (MHz)	Channel	Frequency (MHz)	Channel	Frequency (MHz)
0	2402	19	2440	39	2480

5 FACILITIES AND ACCREDITATIONS

5.1 FACILITIES

All measurement facilities used to collect the measurement data are located at

Bldg 69, Majialong Industry Zone District, Nanshan District, Shenzhen, China

The sites are constructed in conformance with the requirements of ANSI C63.7, ANSI C63.10 and CISPR Publication 22.

5.2 LABORATORY ACCREDITATIONS AND LISTINGS

Site Description

EMC Lab.

: Accredited by CNAS, 2016.10.24

The certificate is valid until 2022.10.28

The Laboratory has been assessed and proved to be in compliance with CNAS-CL01:2006 (identical to ISO/IEC 17025:2005)

The Certificate Registration Number is L2291.

Accredited by TUV Rheinland Shenzhen 2016.5.19

The Laboratory has been assessed according to the requirements ISO/IEC 17025.

Accredited by FCC, Valid until 2018/08/31

A2LA Designation Number is CN1204

Test Firm Registration Number: 882943

Accredited by Industry Canada, November 24, 2015

The Certificate Registration Number is 4480A.

Name of Firm

: EMTEK(SHENZHEN) CO., LTD.

Site Location

: Bldg 69, Majialong Industry Zone,
Nanshan District, Shenzhen, Guangdong, China

6 TEST SYSTEM UNCERTAINTY

The following measurement uncertainty levels have been estimated for tests performed on the apparatus:

Parameter	Uncertainty
Radio Frequency	$\pm 1 \times 10^{-5}$
Maximum Peak Output Power Test	$\pm 1.0\text{dB}$
Conducted Emissions Test	$\pm 2.0\text{dB}$
Radiated Emission Test	$\pm 2.0\text{dB}$
Power Density	$\pm 2.0\text{dB}$
Occupied Bandwidth Test	$\pm 1.0\text{dB}$
Band Edge Test	$\pm 3\text{dB}$
All emission, radiated	$\pm 3\text{dB}$
Antenna Port Emission	$\pm 3\text{dB}$
Temperature	$\pm 0.5^\circ\text{C}$
Humidity	$\pm 3\%$

Measurement Uncertainty for a level of Confidence of 95%

7 SETUP OF EQUIPMENT UNDER TEST

7.1 RADIO FREQUENCY TEST SETUP 1

The Bluetooth 4.0 DTS component's antenna port(s) of the EUT are connected to the measurement instrument per an appropriate attenuator. The EUT is controlled by PC/software to emit the specified signals for the purpose of measurements.

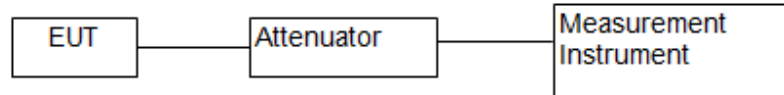

7.2 RADIO FREQUENCY TEST SETUP 2

The test site semi-anechoic chamber has met the requirement of NSA tolerance 4 dB according to the standards: ANSI C63.10. The test distance is 3m. The setup is according to the requirements in Section 13.1.4.1 of ANSI C63.10-2013 and CAN/CSA-CEI/IEC CISPR 22.

Below 30MHz:

The EUT is placed on a turntable 0.8 meters above the ground in the chamber, 3 meter away from the antenna (loop antenna). The Antenna should be positioned with its plane vertical at the specified distance from the EUT and rotated about its vertical axis for maximum response at each azimuth about the EUT. The center of the loop shall be 1 m above the ground. For certain applications, the loop antenna plane may also need to be positioned horizontally at the specified distance from the EUT.

30MHz-1GHz:

The EUT is placed on a turntable 0.8 meters above the ground in the chamber, 3 meter away from the antenna. The maximal emission value is acquired by adjusting the antenna height, polarisation and turntable azimuth. Normally, the height range of antenna is 1 m to 4 m, the azimuth range of turntable is 0° to 360°, and the receive antenna has two polarizations Vertical (V) and Horizontal (H).

Above 1GHz:

The EUT is placed on a turntable 1.5 meters above the ground in the chamber, 3 meter away from the antenna. The maximal emission value is acquired by adjusting the antenna height, polarisation and turntable azimuth. Normally, the height range of antenna is 1 m to 4 m, the azimuth range of turntable is 0° to 360°, and the receive antenna has two polarizations Vertical (V) and Horizontal (H).

(a) Radiated Emission Test Set-Up, Frequency Below 30MHz

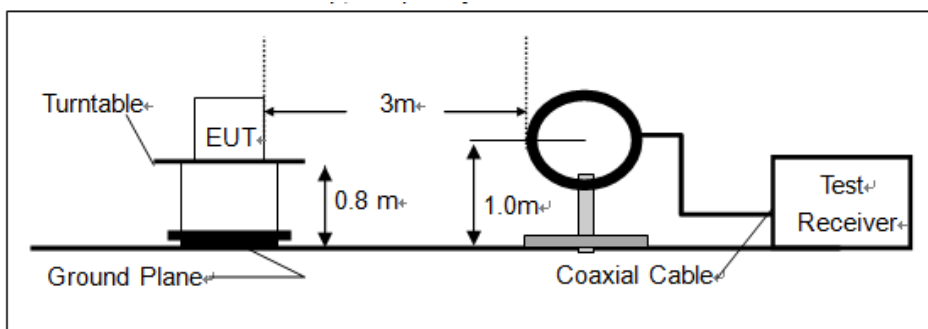

(b) Radiated Emission Test Set-Up, Frequency Below 1000MHz

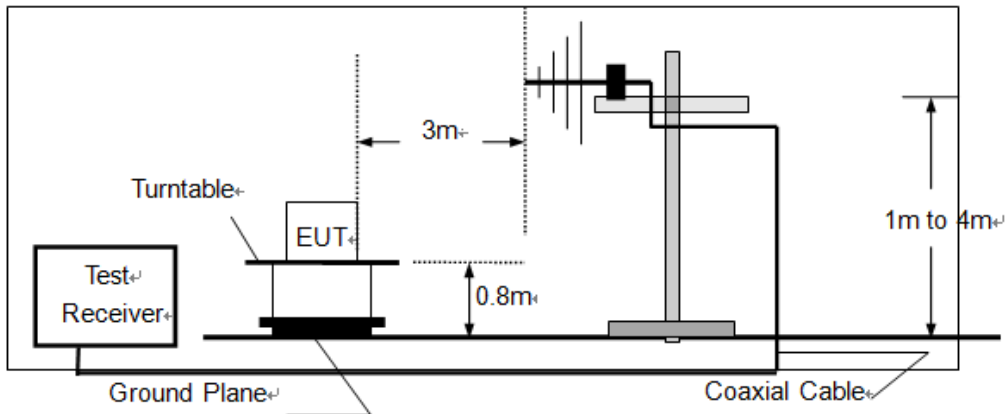

(c) Radiated Emission Test Set-Up, Frequency above 1000MHz

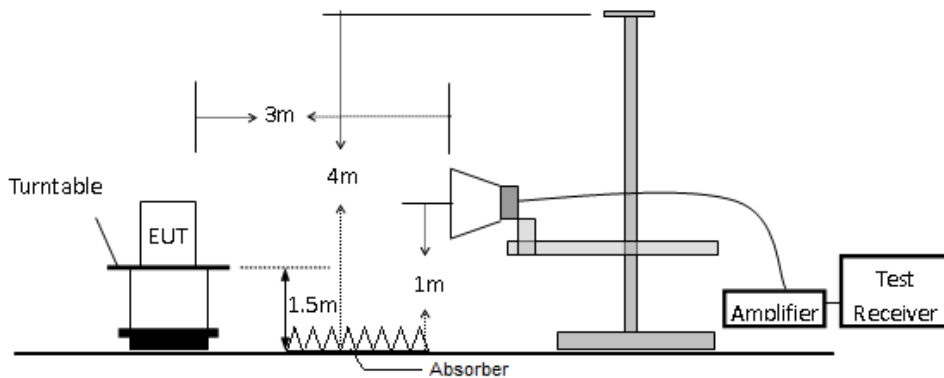

7.3 SUPPORT EQUIPMENT

Item	Equipment	Mfr/Brand	Model/Type No.	Series No.	Note
1	iPhone5C	Apple	A1526	N/A	N/A

Notes:

1. All the equipment/cables were placed in the worst-case configuration to maximize the emission during the test.
2. Grounding was established in accordance with the manufacturer's requirements and conditions for the intended use.

8 TEST REQUIREMENTS

8.1 DTS 6DB BANDWIDTH

8.1.1 Applicable Standard

According to FCC Part 15.247(a)(2) and KDB 558074 DTS 01 Meas. Guidance v04

8.1.2 Conformance Limit

The minimum -6 dB bandwidth shall be at least 500 kHz.

8.1.3 Test Configuration

Test according to clause 7.1 radio frequency test setup 1

8.1.4 Test Procedure

The EUT was operating in Bluetooth 4.0 DTS mode and controlled its channel. Printed out the test result from the spectrum by hard copy function.

The RF output of EUT was connected to the spectrum analyzer by RF cable and attenuator. The path loss was compensated to the results for each measurement.

Set to the maximum power setting and enable the EUT transmit continuously

Set RBW = 100 kHz.

Set the video bandwidth (VBW) = 300 kHz.

Set Span = 2 times OBW

Set Detector = Peak.

Set Trace mode = max hold.

Set Sweep = auto couple.

Allow the trace to stabilize.

Measure the maximum width of the emission that is constrained by the frequencies associated with the two outermost amplitude points (upper and lower frequencies) that are attenuated by 6 dB relative to the maximum level measured in the fundamental emission.

Measure and record the results in the test report.

Test Results

Temperature : 28°C Test Date : July 03, 2018
 Humidity : 55 % Test By: KK

Operation Mode	Channel Number	Channel Frequency (MHz)	Measurement Bandwidth (kHz)	Limit (kHz)	Verdict
Bluetooth 4.0 DTS	0	2402	668.3	>500	PASS
	19	2440	662.3	>500	PASS
	39	2480	659.3	>500	PASS

Test Model DTS (6dB) Bandwidth
Bluetooth v4.0 with BLE mode
Channel 0: 2402MHz

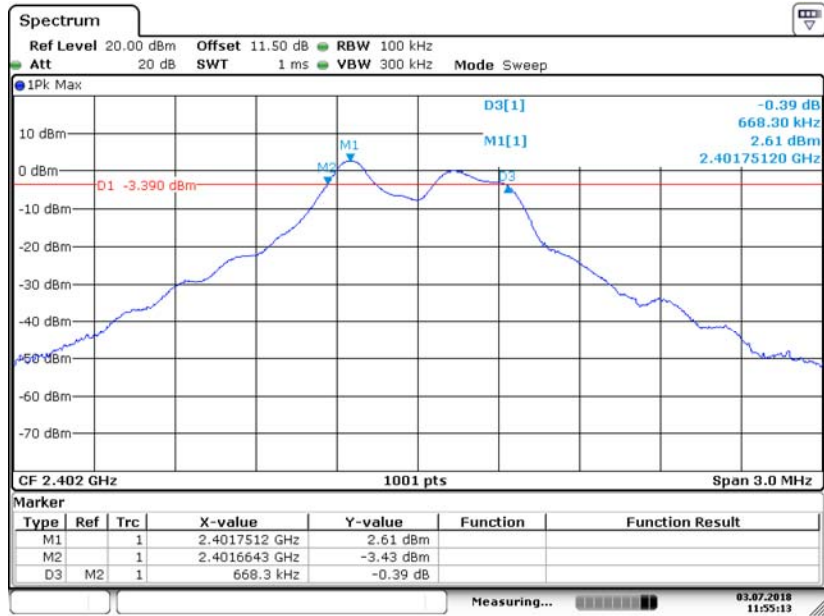

Date: 3.JUL.2018 11:55:13

Test Model DTS (6dB) Bandwidth
Bluetooth v4.0 with BLE mode
Channel 19: 2440MHz

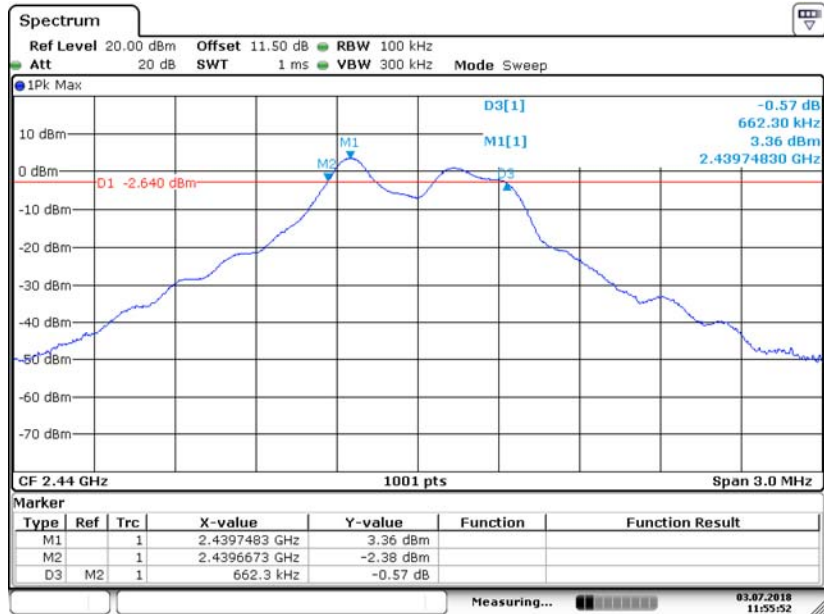

Date: 3.JUL.2018 11:55:52

Test Model DTS (6dB) Bandwidth
Bluetooth v4.0 with BLE mode
Channel 39: 2480MHz

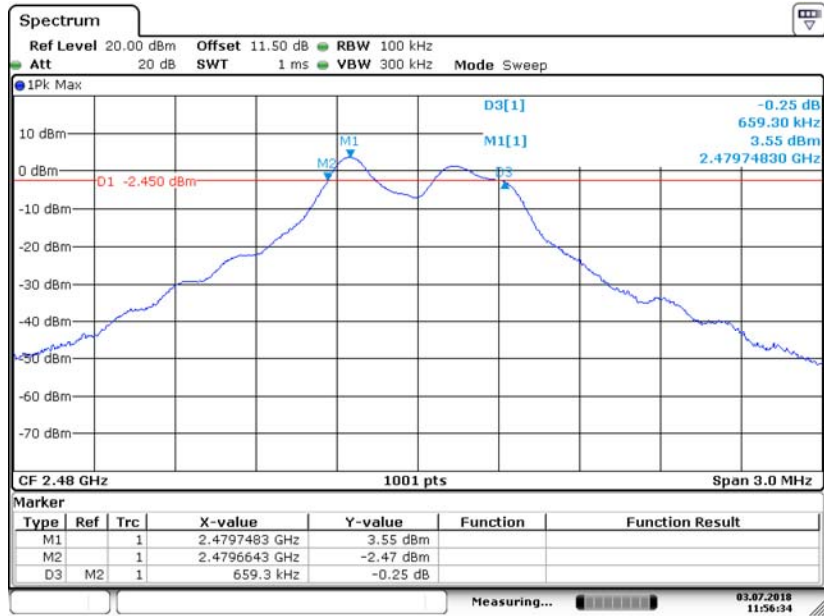

Date: 3.JUL.2018 11:56:34

8.2 MAXIMUM PEAK CONDUCTED OUTPUT POWER

8.2.1 Applicable Standard

According to FCC Part 15.247(b)(3) and KDB 558074 DTS 01 Meas. Guidance v04

8.2.2 Conformance Limit

The maximum peak conducted output power of the intentional radiator for systems using digital modulation in the 2400 - 2483.5 MHz bands shall not exceed: 1 Watt (30dBm).

8.2.3 Test Configuration

Test according to clause 7.1 radio frequency test setup 1

8.2.4 Test Procedure

- According to FCC Part 15.247(b)(3)
 The maximum peak conducted output power may be measured using a broadband peak RF power meter. The power meter shall have a video bandwidth that is greater than or equal to the DTS bandwidth and shall utilize a fast-responding diode detector.
 The RF output of EUT was connected to the power meter by RF cable and attenuator. The path loss was compensated to the results for each measurement.
 Set to the maximum output power setting and enable the EUT transmit continuously.
 Measure the conducted output power with cable loss and record the results in the test report.
 Measure and record the results in the report.
 Conducted output power limit specified in paragraph (b) of this section is based on the use of antennas with directional gains that do not exceed 6 dBi. If transmitting antennas of directional gain greater than 6 dBi are used, the conducted output power from the intentional radiator shall be reduced below the stated values in paragraphs (b)(3) of this section, as appropriate, by the amount in dB that the directional gain of the antenna exceeds 6 dBi.
 Note: If antenna Gain exceeds 6 dBi, then Output power Limit=30-(Gain - 6)
 exceeds 6 dBi.

Test Results

Temperature : 28°C Test Date : July 03, 2018
 Humidity : 55 % Test By: KK

Operation Mode	Channel Number	Channel Frequency (MHz)	Measurement Level (dBm)	Limit (dBm)	Verdict
Bluetooth 4.0DTS	0	2402	3.22	30	PASS
	19	2440	3.94	30	PASS
	39	2480	4.06	30	PASS

8.3 MAXIMUM POWER SPECTRAL DENSITY

8.3.1 Applicable Standard

According to FCC Part 15.247(e) and KDB 558074 DTS 01 Meas. Guidance v04

8.3.2 Conformance Limit

The transmitter power spectral density conducted from the transmitter to the antenna shall not be greater than 8 dBm in any 3 kHz band during any time interval of continuous transmission.

8.3.3 Test Configuration

Test according to clause 7.1 radio frequency test setup 1

8.3.4 Test Procedure

This procedure shall be used if maximum peak conducted output power was used to demonstrate compliance

The transmitter output (antenna port) was connected to the spectrum analyzer

Set analyzer center frequency to DTS channel center frequency.

Set the span to 1.5 times the DTS bandwidth.

Set the RBW to: 3 kHz

Set the VBW to: 10 kHz.

Set Detector = peak.

Set Sweep time = auto couple.

Set Trace mode = max hold.

Allow trace to fully stabilize.

Use the peak marker function to determine the maximum amplitude level within the RBW.

8.3.5 Test Results

Temperature : 28°C Test Date : July 03, 2018
Humidity : 55 % Test By: KK

Operation Mode	Channel Number	Channel Frequency (MHz)	Measurement Level (dBm/3kHz)	Limit (dBm/3kHz)	Verdict
Bluetooth 4.0 DTS	0	2402	-0.13	<8	PASS
	19	2440	0.53	<8	PASS
	39	2480	0.59	<8	PASS

Note: N/A

Test Model Power Spectral Density
Bluetooth v4.0 with BLE mode
Channel 0: 2402MHz

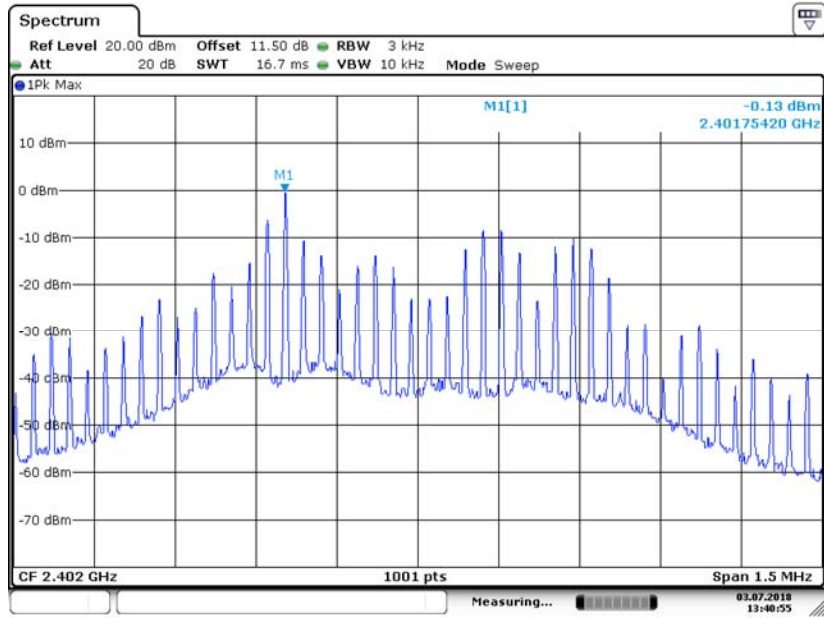

Date: 3.JUL.2018 13:40:54

Test Model Power Spectral Density
Bluetooth v4.0 with BLE mode
Channel 19: 2440MHz

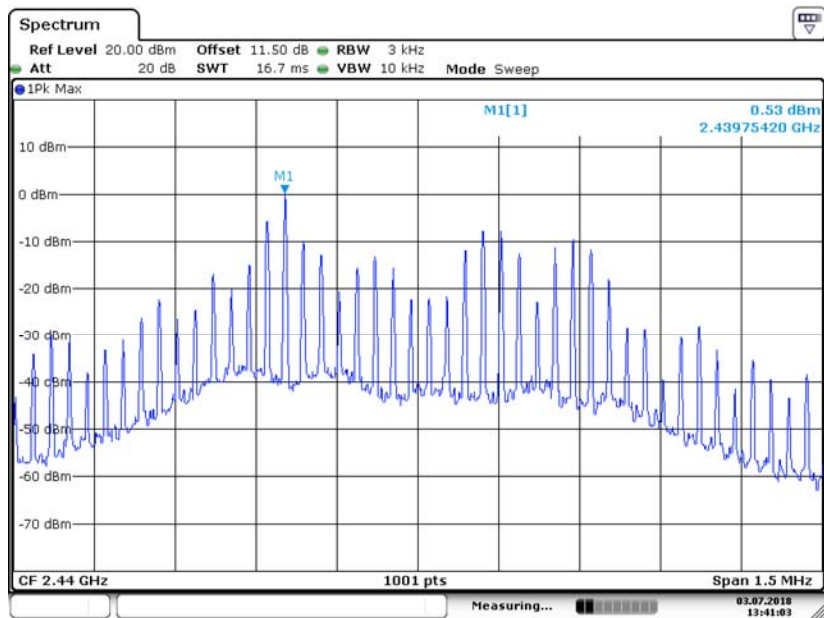

Date: 3.JUL.2018 13:41:02

Test Model Power Spectral Density
Bluetooth v4.0 with BLE mode
Channel 39: 2480MHz

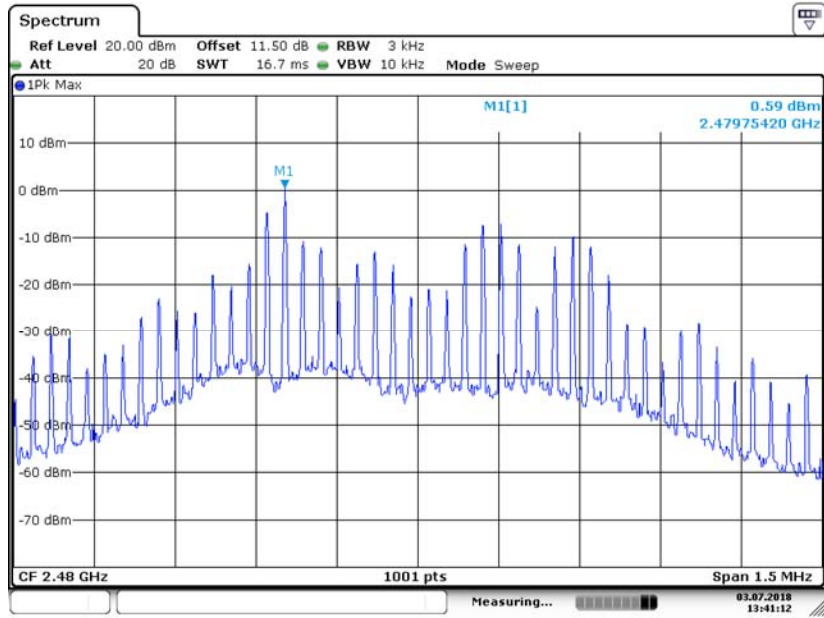

Date: 3.JUL.2018 13:41:12

8.4 UNWANTED EMISSIONS IN NON-RESTRICTED FREQUENCY BANDS

8.4.1 Applicable Standard

According to FCC Part 15.247(d) and KDB 558074 DTS 01 Meas. Guidance v04

8.4.2 Conformance Limit

According to FCC Part 15.247(d):

In any 100 kHz bandwidth outside the frequency band in which the spread spectrum or digitally modulated intentional radiator is operating, the radio frequency power that is produced by the intentional radiator shall be at least 20 dB below that in the 100 kHz bandwidth within the band that contains the highest level of the desired power, based on either an RF conducted or a radiated measurement, provided the transmitter demonstrates compliance with the peak conducted power limits. If the transmitter complies with the conducted power limits based on the use of RMS averaging over a time interval, as permitted under paragraph (b)(3) of this section, the attenuation required under this paragraph shall be 30 dB instead of 20 dB.

8.4.3 Test Configuration

Test according to clause 7.1 radio frequency test setup 1

8.4.4 Test Procedure

The transmitter output (antenna port) was connected to the spectrum analyzer

■ Reference level measurement

Establish a reference level by using the following procedure:

Set instrument center frequency to DTS channel center frequency.

Set the span to = 1.5 times the DTS bandwidth.

Set the RBW = 100 kHz.

Set the VBW $\geq 3 \times$ RBW.

Set Detector = peak.

Set Sweep time = auto couple.

Set Trace mode = max hold.

Allow trace to fully stabilize.

Use the peak marker function to determine the maximum PSD level.

Note that the channel found to contain the maximum PSD level can be used to establish the reference level.

■ Emission level measurement

Set the center frequency and span to encompass frequency range to be measured.

Set the RBW = 100 kHz.

Set the VBW = 300 kHz.

Set Detector = peak

Sweep time = auto couple.

Trace mode = max hold.

Allow trace to fully stabilize.

Use the peak marker function to determine the maximum amplitude level.

Ensure that the amplitude of all unwanted emissions outside of the authorized frequency band (excluding restricted frequency bands) are attenuated by at least the minimum requirements. Report the three highest emissions relative to the limit.

8.4.5 Test Results

Test Model PSD(Power Spectral Density) RBW=100kHz
Bluetooth v4.0 with BLE mode
Channel 0: 2402MHz



Date: 3.JUL.2018 13:41:44

Test Model Unwanted Emissions in non-restricted frequency bands
Bluetooth v4.0 with BLE mode
Channel 0: 2402MHz

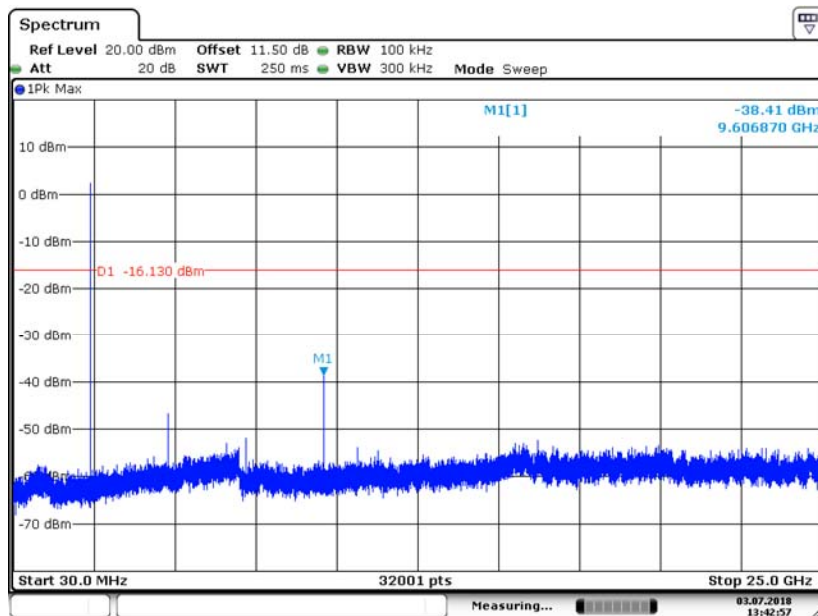

Date: 3.JUL.2018 13:42:57

Test Model Band edge
Bluetooth v4.0 with BLE mode
Channel 0: 2402MHz

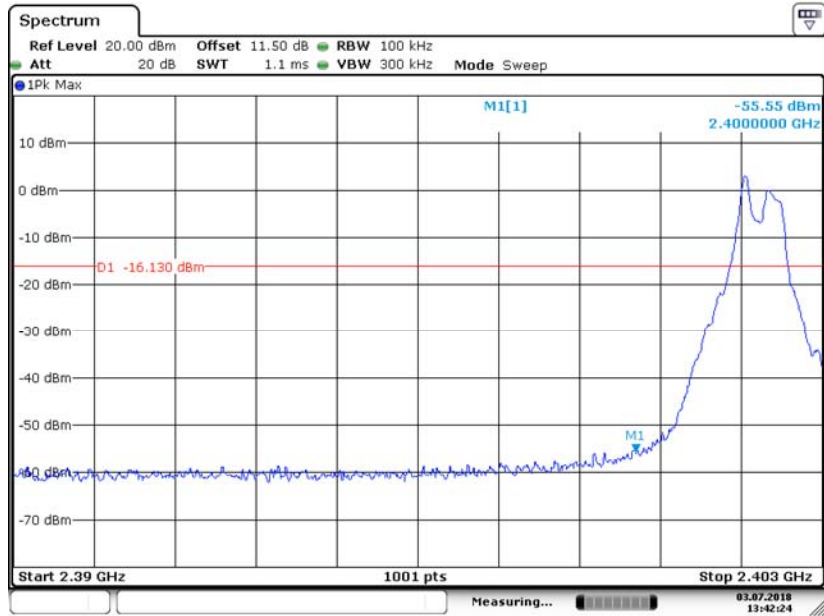

Test Model PSD(Power Spectral Density) RBW=100kHz
Bluetooth v4.0 with BLE mode
Channel 19: 2440MHz

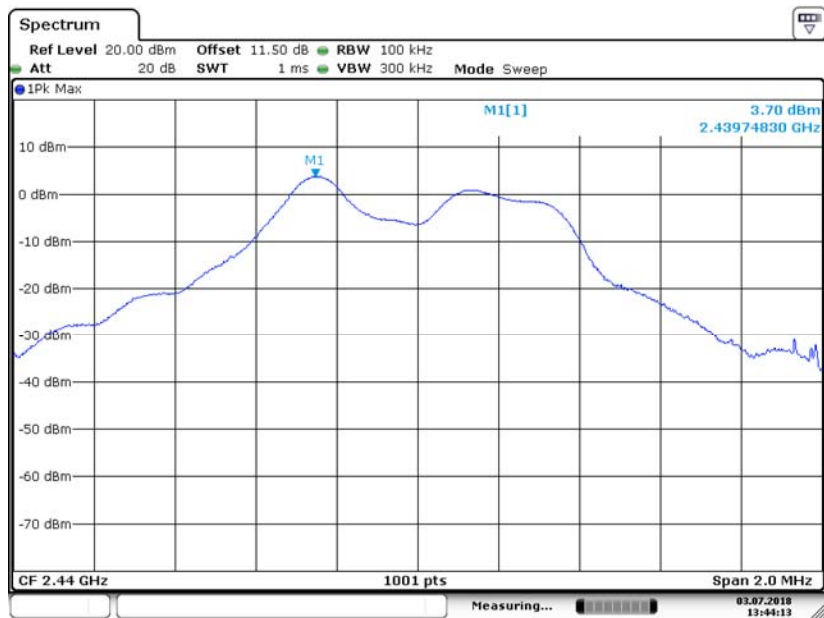

Test Model Unwanted Emissions In Non-Restricted Frequency Bands
Bluetooth v4.0 with BLE mode
Channel 19: 2440MHz

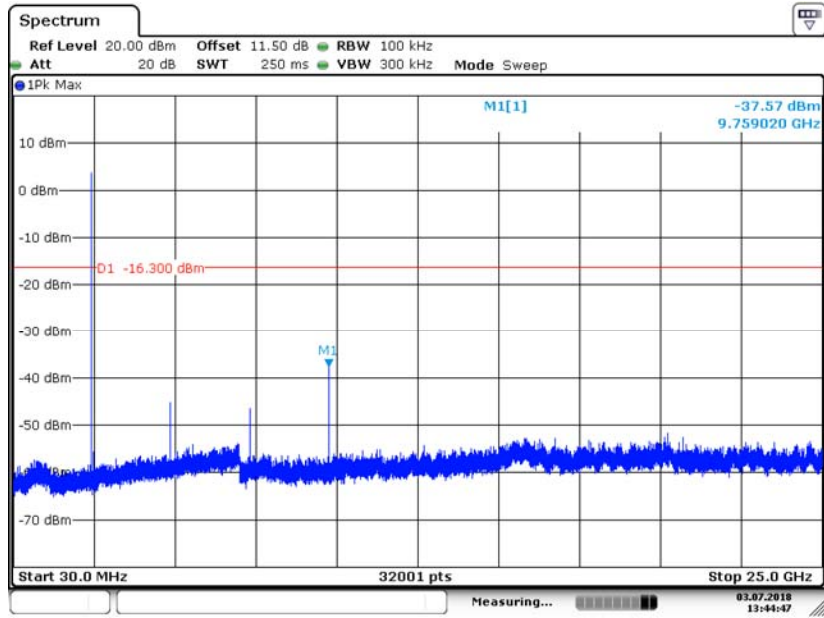

Date: 3.JUL.2018 13:44:46

Test Model PSD(Power Spectral Density) RBW=100kHz
Bluetooth v4.0 with BLE mode
Channel 19: 2480MHz

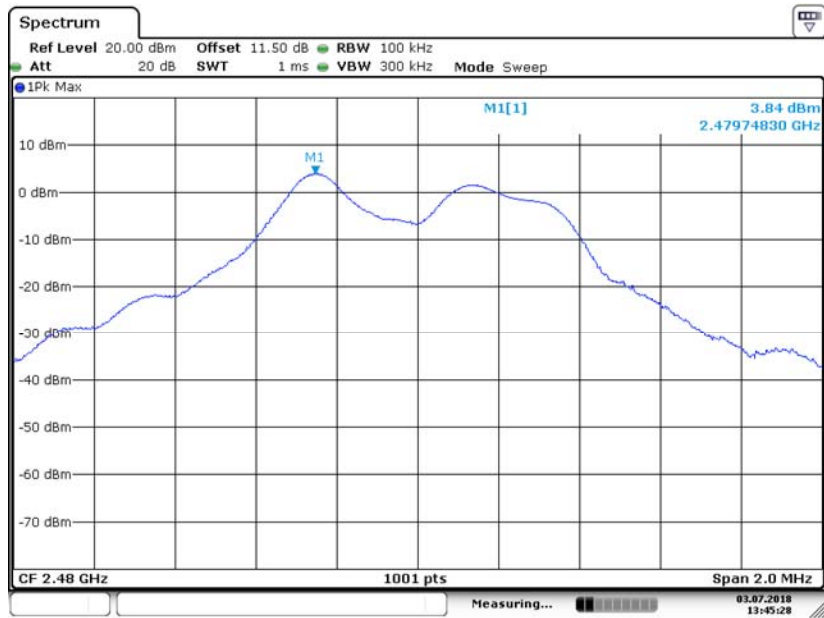

Date: 3.JUL.2018 13:45:28

Test Model Unwanted Emissions In Non-Restricted Frequency Bands
Bluetooth v4.0 with BLE mode
Channel 39: 2480MHz

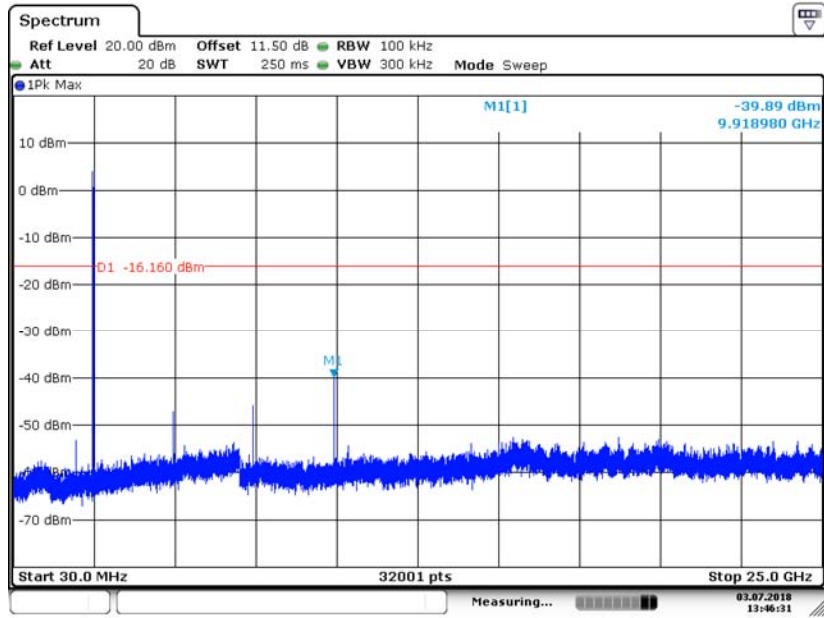

Test Model Band edge
Bluetooth v4.0 with BLE mode
Channel 39: 2480MHz

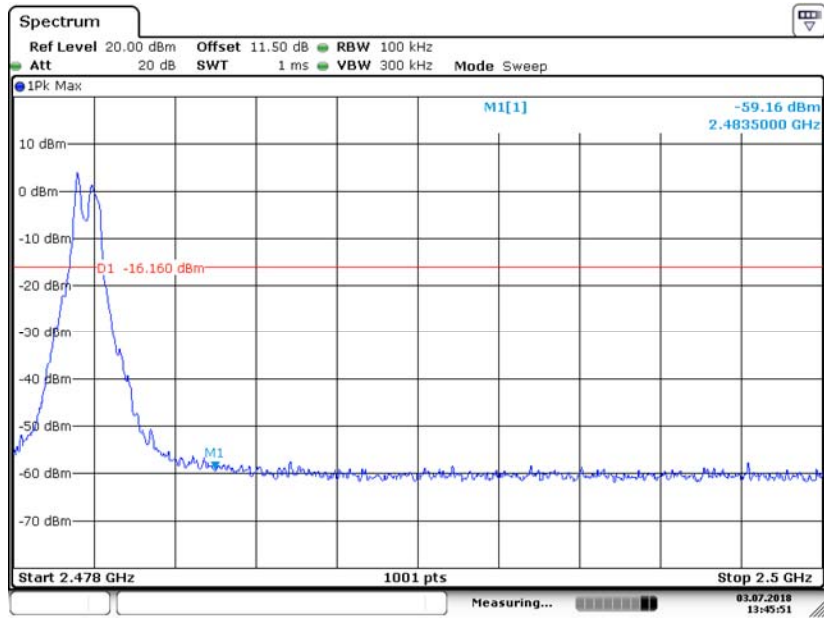

8.5 RADIATED SPURIOUS EMISSION

8.5.1 Applicable Standard

According to FCC Part 15.247(d) and 15.209 and KDB 558074 DTS 01 Meas. Guidance v04

8.5.2 Conformance Limit

According to FCC Part 15.247(d): radiated emissions which fall in the restricted bands, as defined in §15.205(a), must also comply with the radiated emission limits specified in §15.209(a) (see §15.205(c)).
According to FCC Part 15.205, Restricted bands

MHz	MHz	MHz	GHz
0.090-0.110	16.42-16.423	399.9-410	4.5-5.15
10.495-0.505	16.69475-16.69525	608-614	5.35-5.46
2.1735-2.1905	16.80425-16.80475	960-1240	7.25-7.75
4.125-4.128	25.5-25.67	1300-1427	8.025-8.5
4.17725-4.17775	37.5-38.25	1435-1626.5	9.0-9.2
4.20725-4.20775	73-74.6	1645.5-1646.5	9.3-9.5
6.215-6.218	74.8-75.2	1660-1710	10.6-12.7
6.26775-6.26825	123-138	2200-2300	14.47-14.5
8.291-8.294	149.9-150.05	2310-2390	15.35-16.2
8.362-8.366	156.52475-156.52525	2483.5-2500	17.7-21.4
8.37625-8.38675	156.7-156.9	2690-2900	22.01-23.12
8.41425-8.41475	162.0125-167.17	3260-3267	23.6-24.0
12.29-12.293	167.72-173.2	3332-3339	31.2-31.8
12.51975-12.52025	240-285	3345.8-3358	36.43-36.5
12.57675-12.57725	322-335.4	3600-4400	(2)
13.36-13.41			

According to FCC Part 15.205, the level of any transmitter spurious emission in Restricted bands shall not exceed the level of the emission specified in the following table

Restricted Frequency(MHz)	Field Strength (μV/m)	Field Strength (dBμV/m)	Measurement Distance
0.009-0.490	2400/F(KHz)	20 log (uV/m)	300
0.490-1.705	2400/F(KHz)	20 log (uV/m)	30
1.705-30	30	29.5	30
30-88	100	40	3
88-216	150	43.5	3
216-960	200	46	3
Above 960	500	54	3

8.5.3 Test Configuration

Test according to clause 7.2 radio frequency test setup 2

8.5.4 Test Procedure

This test is required for any spurious emission that falls in a Restricted Band, as defined in Section 15.205. It must be performed with the highest gain of each type of antenna proposed for use with the EUT. Use the following spectrum analyzer settings:

The EUT was placed on a turn table which is 0.8m above ground plane.

Maximum procedure was performed on the highest emissions to ensure EUT compliance.

Span = wide enough to fully capture the emission being measured

RBW = 1 MHz for $f \geq 1$ GHz (1GHz to 25GHz), 100 kHz for $f < 1$ GHz (30MHz to 1GHz)

VBW \geq RBW

Sweep = auto

Detector function = peak

Trace = max hold

Follow the guidelines in ANSI C63.10-2013 with respect to maximizing the emission by rotating the EUT, measuring the emission while the EUT is situated in three orthogonal planes (if appropriate), adjusting the measurement antenna height and polarization, etc. A pre-amp and a high pass filter are required for this test, in order to provide the measuring system with sufficient sensitivity. Allow the trace to stabilize. The peak reading of the emission, after being corrected by the antenna factor, cable loss, pre-amp gain, etc., is the peak field strength, which must comply with the limit specified in Section 15.35(b). Submit this data. Now set the VBW to 10 Hz, while maintaining all of the other instrument settings. This peak level, once corrected, must comply with the limit specified in Section 15.209. If the dwell time per channel of the hopping signal is less than 100 ms, then the reading obtained with the 10 Hz VBW may be further adjusted by a “duty cycle correction factor”, derived from $20\log(\text{dwell time}/100 \text{ ms})$, in an effort to demonstrate compliance with the 15.209 limit. Submit this data.

Repeat above procedures until all frequency measured was complete.

8.5.5 Test Results

■ Spurious Emission below 30MHz (9KHz to 30MHz)

Temperature:	24°C	Test Date:	July 03, 2018
Humidity:	53 %	Test By:	KK
Test mode:	TX Mode		

Freq. (MHz)	Ant.Pol. H/V	Emission Level(dBuV/m)		Limit 3m(dBuV/m)		Over(dB)	
		PK	AV	PK	AV	PK	AV
--	--	--	--	--	--	--	--

Note: the amplitude of spurious emission that is attenuated by more than 20dB below the permissible limit has no need to be reported.

Distance extrapolation factor = $40\log(\text{Specific distance}/ \text{test distance})(\text{dB})$;

Limit line = Specific limits(dBuV) + distance extrapolation factor

■ Spurious Emission Above 1GHz (1GHz to 25GHz)

Temperature :	28°C	Test Date :	July 03, 2018
Humidity :	55 %	Test By:	KK
Test mode:	Bluetooth 4.0 DTS	Frequency:	Channel 0: 2402MHz

Freq. (MHz)	Ant.Pol. H/V	Emission Level(dBuV/m)		Limit 3m(dBuV/m)		Over(dB)	
		PK	AV	PK	AV	PK	AV
1762.112	V	43.72	30.14	74.00	54.00	-30.28	-23.86
5209.075	V	47.84	32.11	74.00	54.00	-26.16	-21.89
7829.860	V	49.16	31.56	74.00	54.00	-24.84	-22.44
2332.356	H	44.27	30.21	74.00	54.00	-29.73	-23.79
4230.395	H	46.97	31.44	74.00	54.00	-27.03	-22.56
5239.274	H	47.52	32.10	74.00	54.00	-26.48	-21.90

Temperature : 28°C Test Date : July 03, 2018
 Humidity : 55 % Test By: KK
 Test mode: Bluetooth 4.0 DTS Frequency: Channel 19: 2440MHz

Freq. (MHz)	Ant.Pol. H/V	Emission Level(dBuV/m)		Limit 3m(dBuV/m)		Over(dB)	
		PK	AV	PK	AV	PK	AV
1762.112	V	46.47	31.44	74.00	54.00	-27.53	-22.56
3386.297	V	43.07	32.55	74.00	54.00	-30.93	-21.45
5713.856	V	47.21	33.10	74.00	54.00	-26.79	-20.90
1746.898	H	44.32	31.22	74.00	54.00	-29.68	-22.78
2485.483	H	43.52	32.10	74.00	54.00	-30.48	-21.90
4291.976	H	45.54	30.56	74.00	54.00	-28.46	-23.44

Temperature : 28°C Test Date : July 03, 2018
 Humidity : 55 % Test By: KK
 Test mode: Bluetooth 4.0 DTS Frequency: Channel 39: 2480MHz

Freq. (MHz)	Ant.Pol. H/V	Emission Level(dBuV/m)		Limit 3m(dBuV/m)		Over(dB)	
		PK	AV	PK	AV	PK	AV
1402.384	V	41.24	31.55	74.00	54.00	-32.76	-22.45
1803.332	V	41.23	32.14	74.00	54.00	-32.77	-21.86
3455.508	V	43.95	33.31	74.00	54.00	-30.05	-20.69
1422.798	H	41.96	31.22	74.00	54.00	-32.04	-22.78
3034.063	H	43.26	32.10	74.00	54.00	-30.74	-21.90
5179.049	H	47.61	32.33	74.00	54.00	-26.39	-21.67

- Note:**
- (1) All Readings are Peak Value (VBW=3MHz) and Peak Value (VBW=10Hz).
 - (2) Emission Level= Reading Level+Correct Factor +Cable Loss.
 - (3) Correct Factor= Ant_F + Cab_L - Preamp
 - (4) Data of measurement within this frequency range shown “ -- ” in the table above means the reading of emissions are attenuated more than 20dB below the permissible limits or the field strength is too small to be measured.

■ Spurious Emission in Restricted Band 2310-2390MHz and 2483.5-2500MHz

Temperature : 28°C Test Date : July 03, 2018
 Humidity : 55 % Test By: KK
 Test mode: Bluetooth 4.0 DTS Frequency: Channel 0: 2402MHz

Frequency (MHz)	Polarity	PK(dBuV/m) (VBW=3MHz)	Limit 3m (dBuV/m)	Margin (dB)	AV(dBuV/m) (VBW=10Hz)	Limit 3m (dBuV/m)	Margin (dB)
2334.48	H	41.31	74.00	-32.69	33.21	54.00	-20.79
2320.08	V	41.49	74.00	-32.51	31.40	54.00	-22.60

Temperature : 28°C Test Date : July 03, 2018
 Humidity : 55 % Test By: KK
 Test mode: Bluetooth 4.0 DTS Frequency: Channel 39: 2480MHz

Frequency (MHz)	Polarity	PK(dBuV/m) (VBW=3MHz)	Limit 3m (dBuV/m)	Margin (dB)	AV(dBuV/m) (VBW=10Hz)	Limit 3m (dBuV/m)	Margin (dB)
2484.358	H	46.96	74.00	-27.04	32.14	54.00	-21.86
2486.437	V	42.49	74.00	-31.51	31.56	54.00	-22.44

- Note:** (1) All Readings are Peak Value (VBW=3MHz) and Peak Value (VBW=10Hz).
 (2) Emission Level= Reading Level+Correct Factor +Cable Loss.
 (3) Correct Factor= Ant_F + Cab_L - Preamp
 (4)Data of measurement within this frequency range shown “ -- ” in the table above means the reading of emissions are attenuated more than 20dB below the permissible limits or the field strength is too small to be measured.

Test Model	Spurious Emission in Restricted Band 2310-2390MHz	
	Bluetooth 4.0 DTS	
	Channel 0: 2402MHz	H

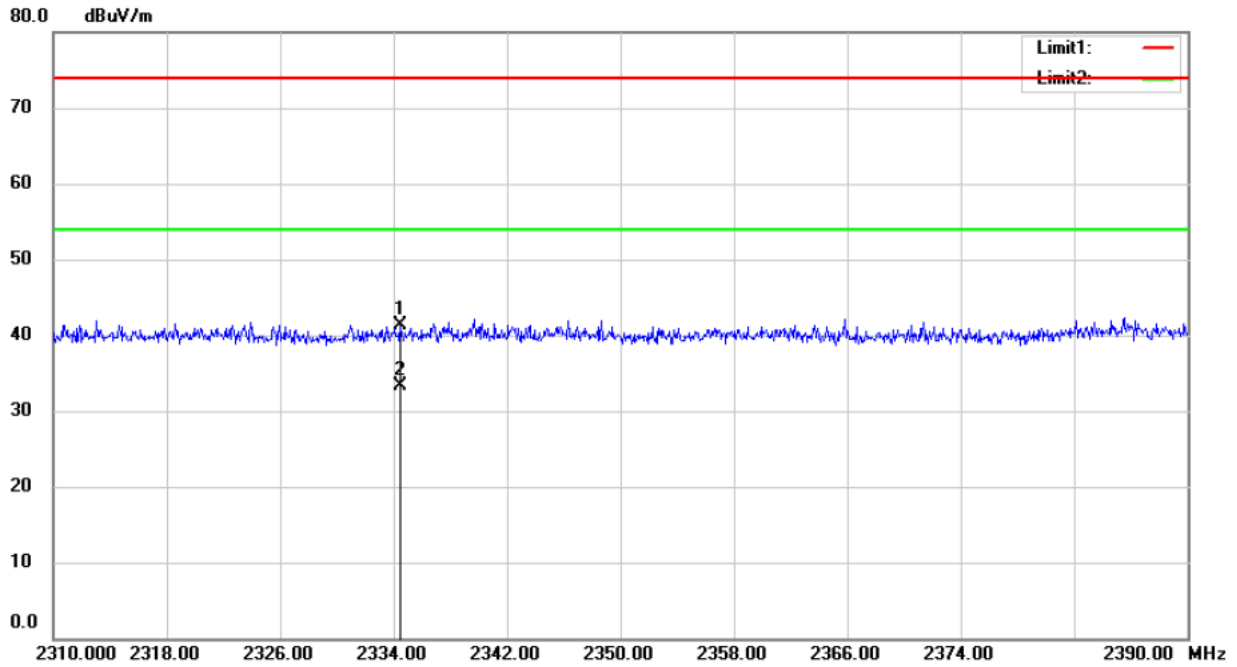

Test Model	Spurious Emission in Restricted Band 2483.5-2500MHz	
	Bluetooth 4.0 DTS	
	Channel 0: 2402MHz	V

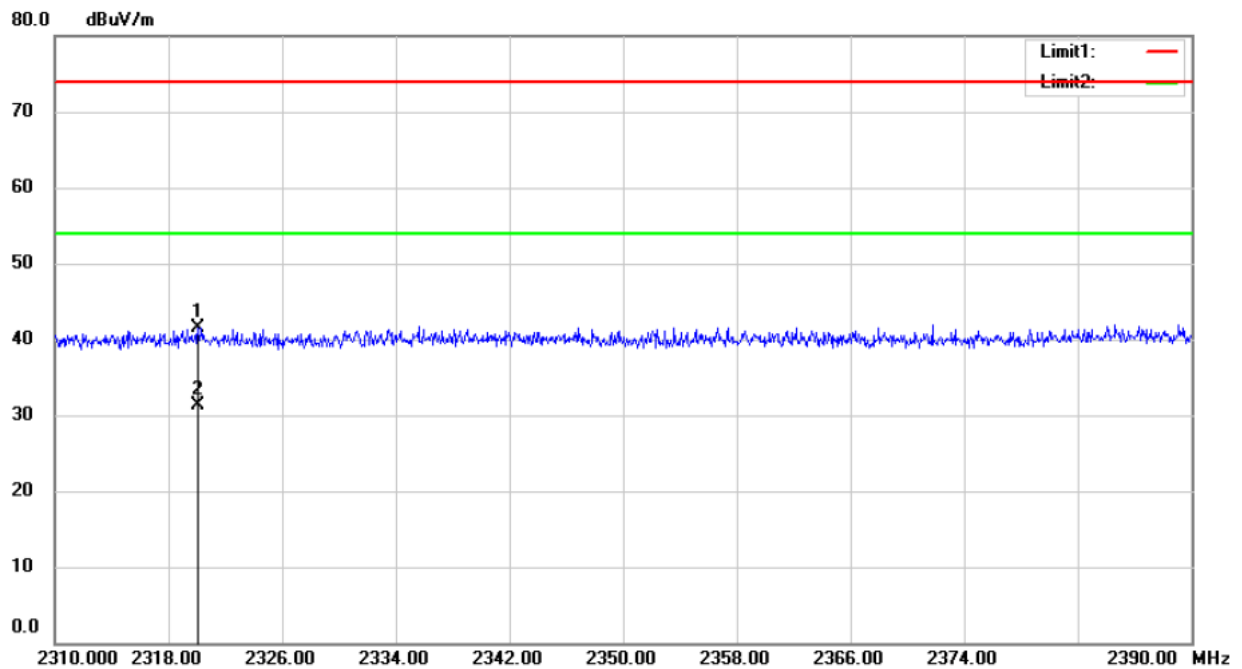

Test Model	Spurious Emission in Restricted Band 2483.5-2500MHz Bluetooth 4.0 DTS		
	Channel 39: 2480MHz		H

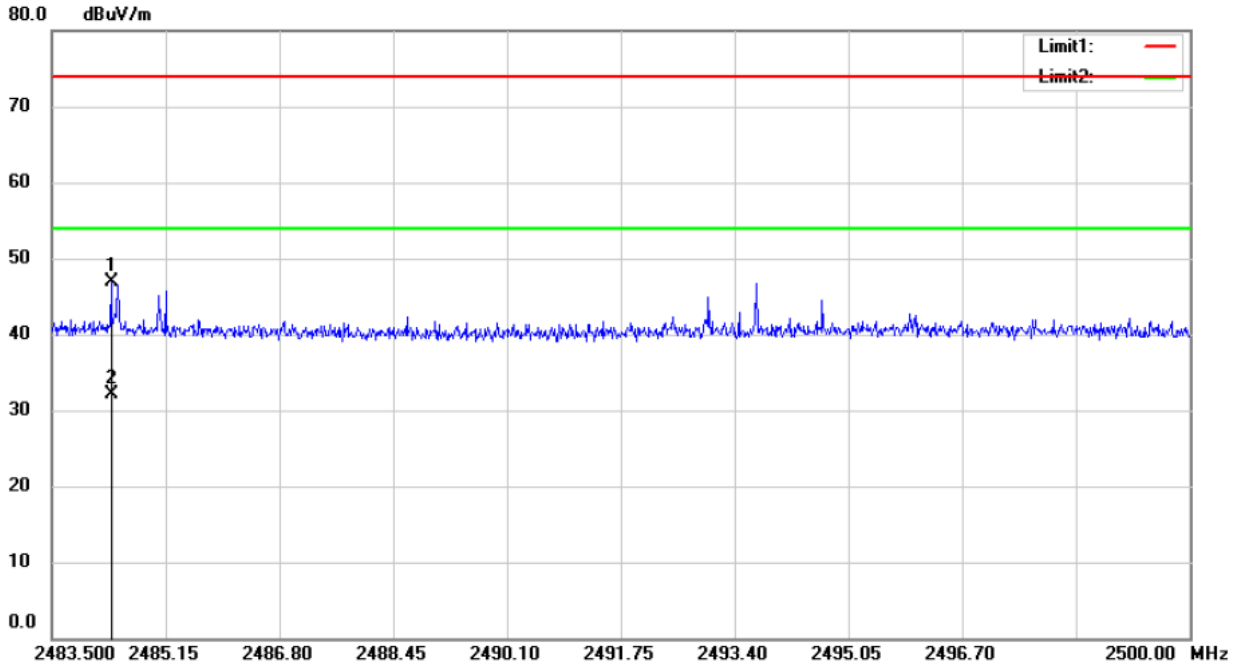

Test Model	Spurious Emission in Restricted Band 2483.5-2500MHz Bluetooth 4.0 DTS		
	Channel 39: 2480MHz		V

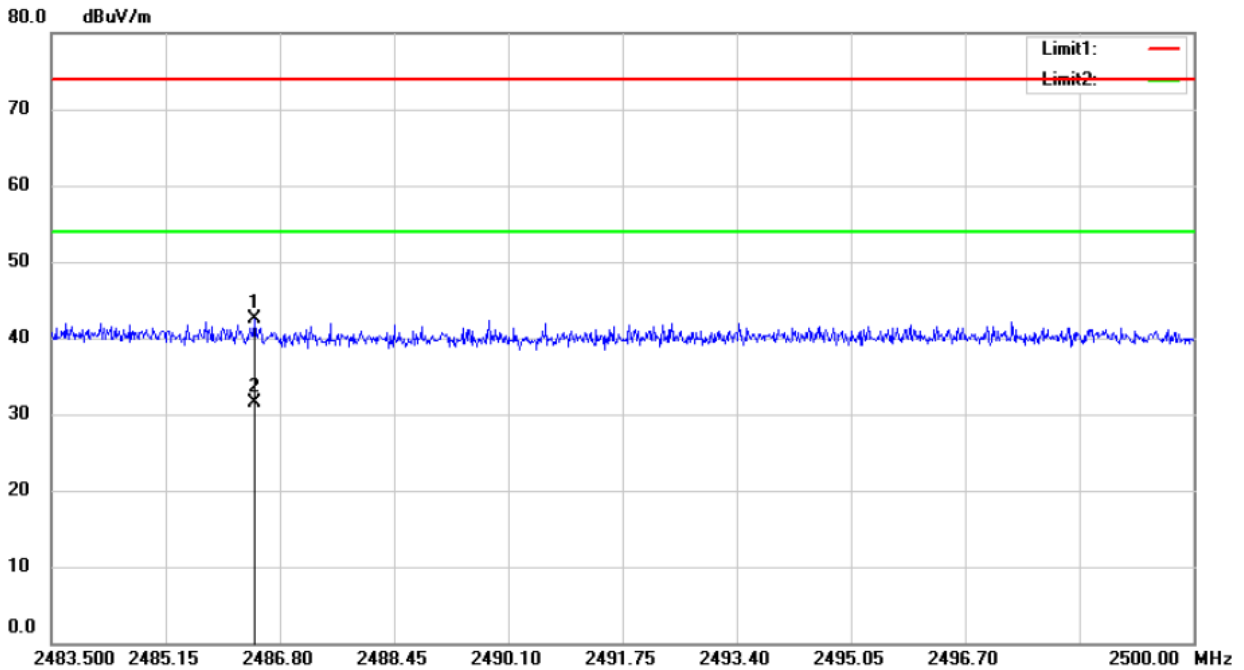

■ Spurious Emission below 1GHz (30MHz to 1GHz)

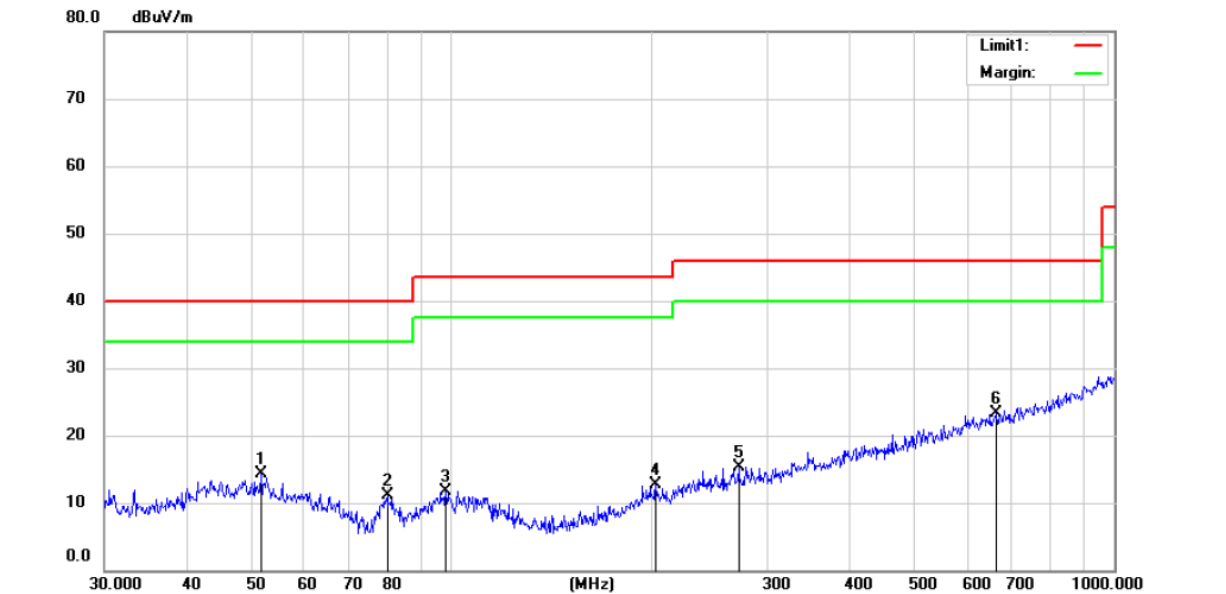

Site 3m Chamber #3 Polarization: *Horizontal* Temperature: 23 C
 Limit: (RE)FCC PART 15C Power: DC 6V Humidity: 51 %
 Mode:TX 2402
 Note:

No.	Mk.	Freq.	Reading Level	Correct Factor	Measurement	Limit	Over	Antenna Height	Table Degree	
		MHz	dBuV	dB	dBuV/m	dBuV/m	dB	cm	degree	Comment
1		51.6613	28.74	-14.35	14.39	40.00	-25.61	QP		
2		80.0805	27.25	-16.22	11.03	40.00	-28.97	QP		
3		98.1418	28.13	-16.50	11.63	43.50	-31.87	QP		
4		203.5226	28.43	-15.66	12.77	43.50	-30.73	QP		
5		271.3245	28.85	-13.64	15.21	46.00	-30.79	QP		
6	*	663.4728	28.06	-4.82	23.24	46.00	-22.76	QP		

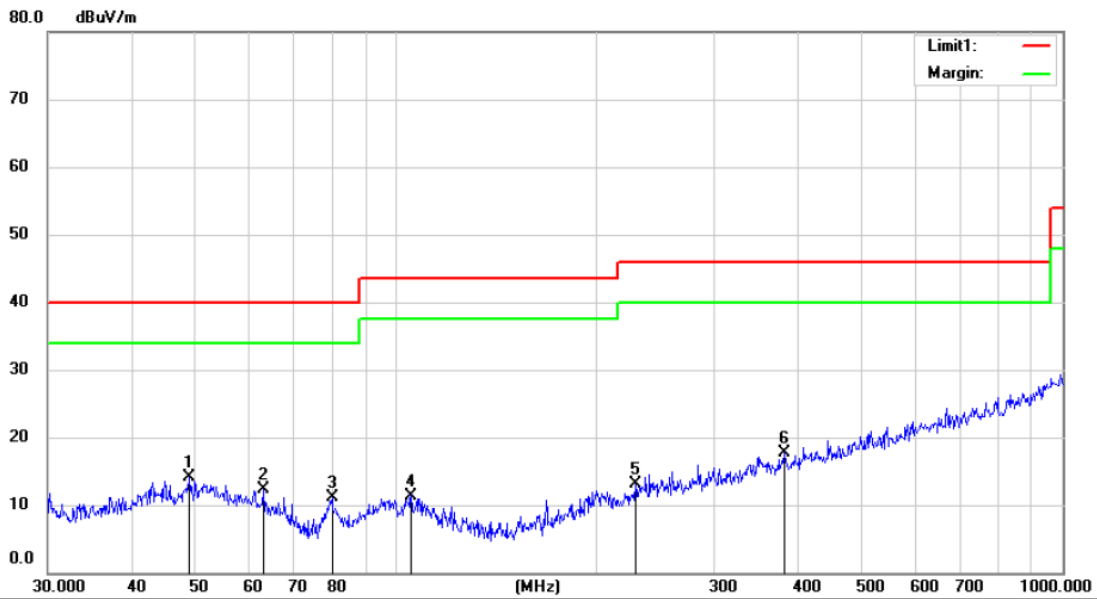

Site 3m Chamber #3 Polarization: *Vertical* Temperature: 23 C
 Limit: (RE)FCC PART 15C Power: DC 6V Humidity: 51 %
 Mode:TX 2402
 Note:

No.	Mk.	Freq.	Reading Level	Correct Factor	Measurement	Limit	Over	Antenna Height	Table Degree	
		MHz	dBuV	dB	dBuV/m	dBuV/m	dB	cm	degree	Comment
1	*	48.8428	28.31	-14.21	14.10	40.00	-25.90			QP
2		63.3132	28.70	-16.31	12.39	40.00	-27.61			QP
3		80.0805	31.34	-20.15	11.19	40.00	-28.81			QP
4		105.2717	27.24	-15.84	11.40	43.50	-32.10			QP
5		228.4904	27.90	-14.83	13.07	46.00	-32.93			QP
6		382.5878	28.01	-10.30	17.71	46.00	-28.29			QP

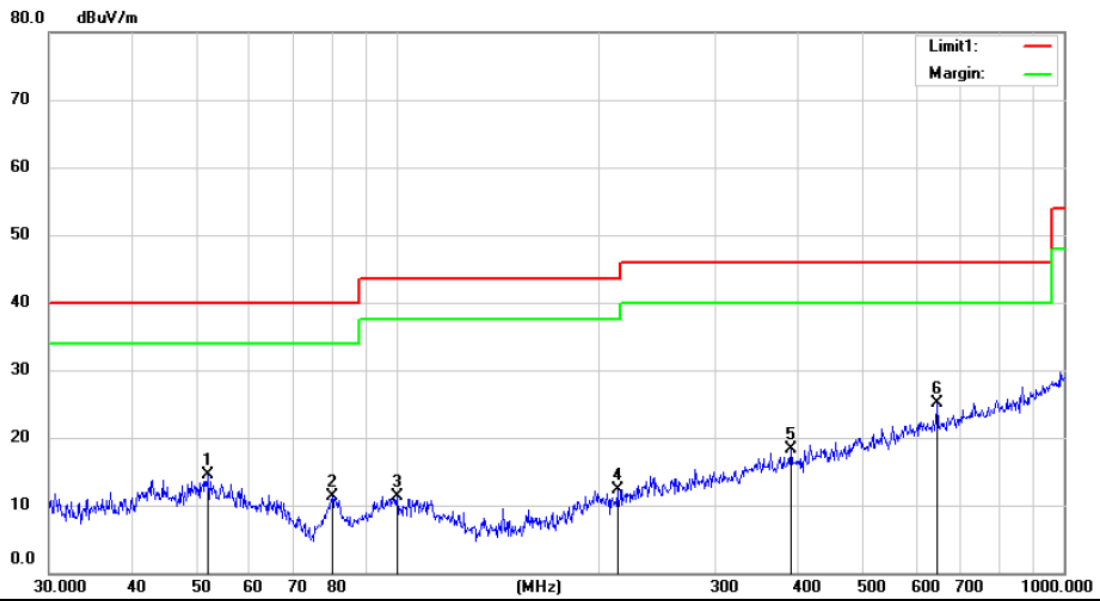

Site 3m Chamber #3 Polarization: **Vertical** Temperature: 23 C
 Limit: (RE)FCC PART 15C Power: DC 6V Humidity: 51 %
 Mode:TX 2440
 Note:

No.	Mk.	Freq.	Reading Level	Correct Factor	Measurement	Limit	Over	Antenna Height	Table Degree	
		MHz	dBuV	dB	dBuV/m	dBuV/m	dB	cm	degree	Comment
1		52.0251	28.84	-14.32	14.52	40.00	-25.48	QP		
2		79.8002	31.37	-20.16	11.21	40.00	-28.79	QP		
3		99.8777	27.57	-16.28	11.29	43.50	-32.21	QP		
4		213.7634	28.11	-15.82	12.29	43.50	-31.21	QP		
5		389.3548	28.60	-10.27	18.33	46.00	-27.67	QP		
6	*	645.1194	30.11	-5.08	25.03	46.00	-20.97	QP		

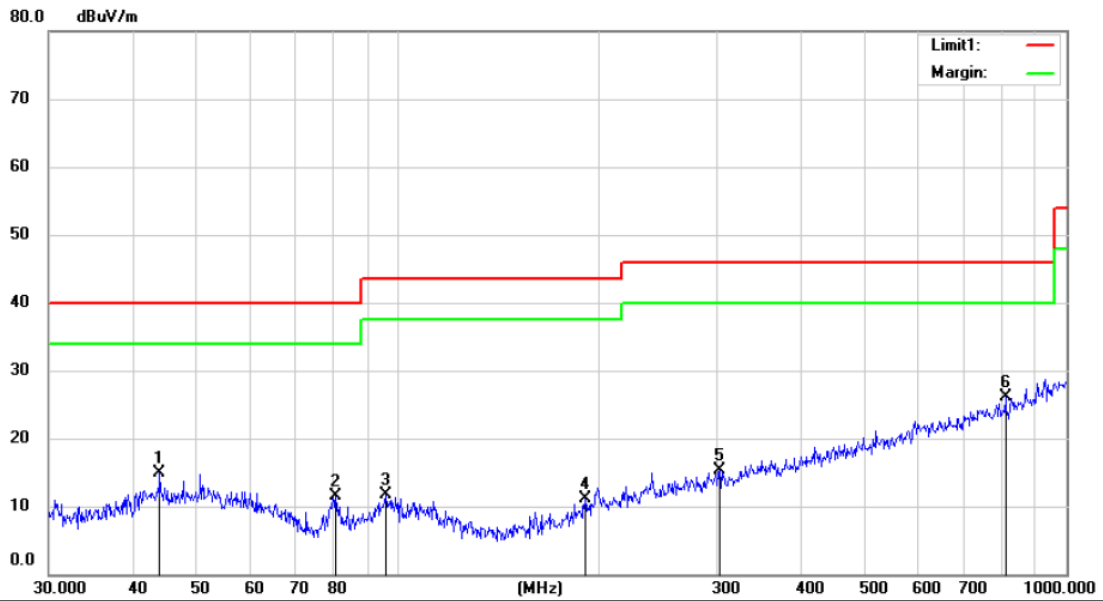

Site 3m Chamber #3 Polarization: *Horizontal* Temperature: 23 C
 Limit: (RE)FCC PART 15C Power: DC 6V Humidity: 51 %
 Mode:TX 2440
 Note:

No.	Mk.	Freq.	Reading Level	Correct Factor	Measurement	Limit	Over	Antenna Height	Table Degree	
		MHz	dBuV	dB	dBuV/m	dBuV/m	dB	cm	degree	Comment
1		43.9658	29.41	-14.44	14.97	40.00	-25.03	QP		
2		80.6441	28.17	-16.60	11.57	40.00	-28.43	QP		
3		95.7622	28.55	-16.82	11.73	43.50	-31.77	QP		
4		190.4050	27.63	-16.55	11.08	43.50	-32.42	QP		
5		302.4811	28.06	-12.84	15.22	46.00	-30.78	QP		
6	*	810.2653	28.67	-2.56	26.11	46.00	-19.89	QP		

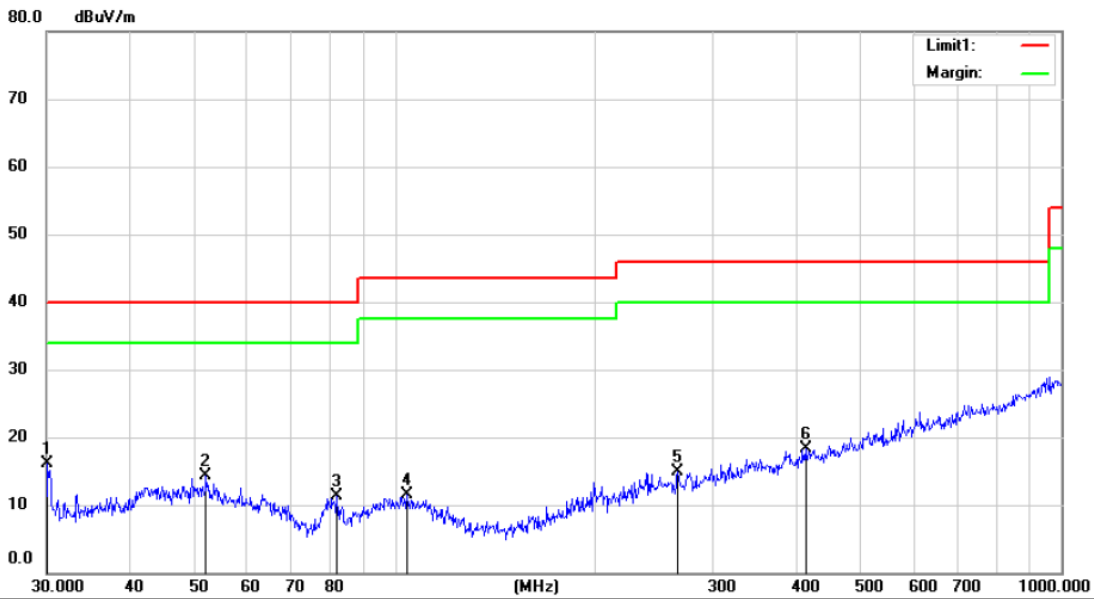

Site 3m Chamber #3 Polarization: *Horizontal* Temperature: 23 C
 Limit: (RE)FCC PART 15C Power: DC 6V Humidity: 51 %
 Mode:TX 2480
 Note:

No.	Mk.	Freq.	Reading Level	Correct Factor	Measurement	Limit	Over	Antenna Height	Table Degree	
		MHz	dBuV	dB	dBuV/m	dBuV/m	dB	cm	degree	Comment
1	*	30.1053	32.99	-16.94	16.05	40.00	-23.95	QP		
2		52.0251	28.61	-14.32	14.29	40.00	-25.71	QP		
3		81.7832	28.78	-17.40	11.38	40.00	-28.62	QP		
4		104.1701	27.34	-15.91	11.43	43.50	-32.07	QP		
5		265.6757	28.57	-13.66	14.91	46.00	-31.09	QP		
6		413.2706	27.73	-9.52	18.21	46.00	-27.79	QP		

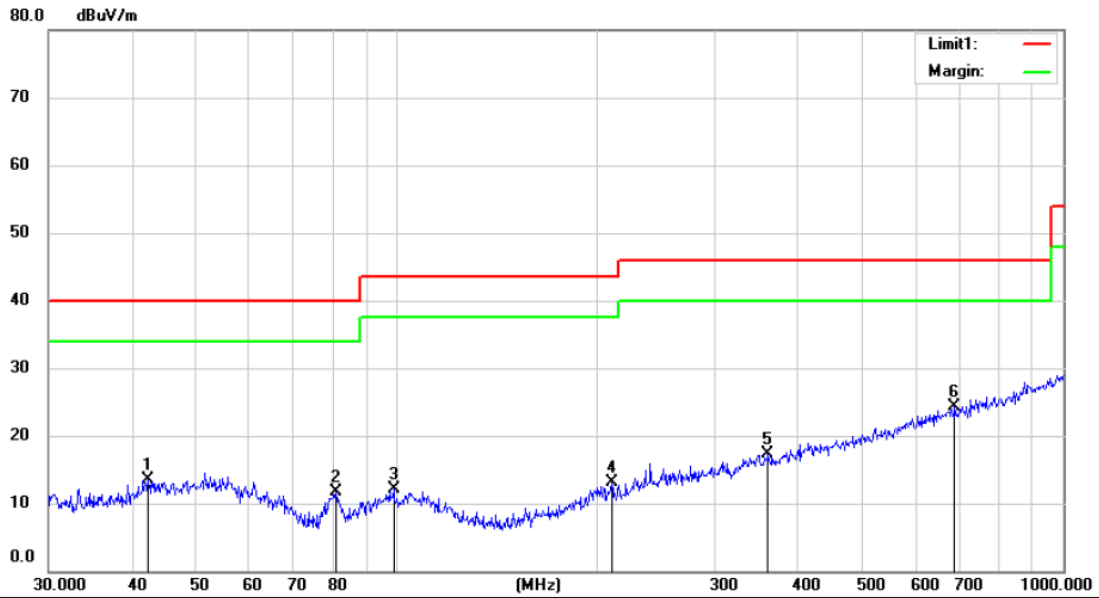

Site 3m Chamber #3 Polarization: *Vertical* Temperature: 23 C
 Limit: (RE)FCC PART 15C Power: DC 6V Humidity: 51 %
 Mode:TX 2480
 Note:

No.	Mk.	Freq.	Reading Level	Correct Factor	Measurement	Limit	Over	Antenna Height	Table Degree	
		MHz	dBuV	dB	dBuV/m	dBuV/m	dB	cm	degree	Comment
1		42.3022	27.90	-14.43	13.47	40.00	-26.53	QP		
2		80.9274	31.70	-20.06	11.64	40.00	-28.36	QP		
3		98.8324	28.48	-16.42	12.06	43.50	-31.44	QP		
4		210.0481	29.11	-15.98	13.13	43.50	-30.37	QP		
5		360.4476	28.26	-11.02	17.24	46.00	-28.76	QP		
6	*	687.1506	28.75	-4.42	24.33	46.00	-21.67	QP		

8.6 ANTENNA APPLICATION

8.6.1 Antenna Requirement

Standard	Requirement
FCC CRF Part 15.203	An intentional radiator shall be designed to ensure that no antenna other than that furnished by the responsible party shall be used with the device. The use of a permanently attached antenna or of an antenna that uses a unique coupling to the intentional radiator shall be considered sufficient to comply with the provisions of this section. The manufacturer may design the unit so that a broken antenna can be replaced by the user, but the use of a standard antenna jack or electrical connector is prohibited. This requirement does not apply to carrier current devices or to devices operated under the provisions of §15.211, §15.213, §15.217, §15.219, or §15.221. Further, this requirement does not apply to intentional radiators that must be professionally installed, such as perimeter protection systems and some field disturbance sensors, or to other intentional radiators which, in accordance with §15.31(d), must be measured at the installation site. However, the installer shall be responsible for ensuring that the proper antenna is employed so that the limits in this part are not exceeded.

For intentional device, according to FCC 47 CFR Section 15.203, an intentional radiator shall be designed to ensure that no antenna other than that furnished by the responsible party shall be used with the device. And according to FCC 47 CFR Section 15.247 (b), if transmitting antennas of directional gain greater than 6dBi are used, the power shall be reduced by the amount in dB that the directional gain of the antenna exceeds 6dBi.

8.6.2 Result

PASS.

The EUT has 1 antenna: a PCB antenna for BT, the gain is 0 dBi;

- Note:
- Antenna use a permanently attached antenna which is not replaceable.
 - Not using a standard antenna jack or electrical connector for antenna replacement
 - The antenna has to be professionally installed (please provide method of installation)

which in accordance to section 15.203, please refer to the internal photos.