

User Manual

KF1200

Date: May 2022

Doc Version: 1.0

English

Thank you for choosing our product. Please read the instructions carefully before operation. Follow these instructions to ensure that the product is functioning properly. The images shown in this manual are for illustrative purposes only.



For further details, please visit our Company's website www.zkteco.com.

Copyright © 2022 ZKTECO CO., LTD. All rights reserved.

Without the prior written consent of ZKTeco, no portion of this manual can be copied or forwarded in any way or form. All parts of this manual belong to ZKTeco and its subsidiaries (hereinafter the "Company" or "ZKTeco").

Trademark

ZKTeco is a registered trademark of ZKTeco. Other trademarks involved in this manual are owned by their respective owners.

Disclaimer

This manual contains information on the operation and maintenance of the ZKTeco equipment. The copyright in all the documents, drawings, etc. in relation to the ZKTeco supplied equipment vests in and is the property of ZKTeco. The contents hereof should not be used or shared by the receiver with any third party without express written permission of ZKTeco.

The contents of this manual must be read as a whole before starting the operation and maintenance of the supplied equipment. If any of the content(s) of the manual seems unclear or incomplete, please contact ZKTeco before starting the operation and maintenance of the said equipment.

It is an essential pre-requisite for the satisfactory operation and maintenance that the operating and maintenance personnel are fully familiar with the design and that the said personnel have received thorough training in operating and maintaining the machine/unit/equipment. It is further essential for the safe operation of the machine/unit/equipment that personnel have read, understood and followed the safety instructions contained in the manual.

In case of any conflict between terms and conditions of this manual and the contract specifications, drawings, instruction sheets or any other contract-related documents, the contract conditions/documents shall prevail. The contract specific conditions/documents shall apply in priority.

ZKTeco offers no warranty, guarantee or representation regarding the completeness of any information contained in this manual or any of the amendments made thereto. ZKTeco does not extend the warranty of any kind, including, without limitation, any warranty of design, merchantability or fitness for a particular purpose.

ZKTeco does not assume responsibility for any errors or omissions in the information or documents which are referenced by or linked to this manual. The entire risk as to the results and performance obtained from using the information is assumed by the user.

ZKTeco in no event shall be liable to the user or any third party for any incidental, consequential, indirect, special, or exemplary damages, including, without limitation, loss of business, loss of profits, business interruption, loss of business information or any pecuniary loss, arising out of, in connection with, or relating to the use of the information contained in or referenced by this manual, even if ZKTeco has been advised of the possibility of such damages.

This manual and the information contained therein may include technical, other inaccuracies or typographical errors. ZKTeco periodically changes the information herein which will be incorporated into new additions/amendments to the manual. ZKTeco reserves the right to add, delete, amend or modify the information contained in the manual from time to time in the form of circulars, letters, notes, etc. for better operation and safety of the machine/unit/equipment. The said additions or amendments are meant for improvement/better operations of the machine/unit/equipment and such

amendments shall not give any right to claim any compensation or damages under any circumstances.

ZKTeco shall in no way be responsible (i) in case the machine/unit/equipment malfunctions due to any non-compliance of the instructions contained in this manual (ii) in case of operation of the machine/unit/equipment beyond the rate limits (iii) in case of operation of the machine and equipment in conditions different from the prescribed conditions of the manual.

The product will be updated from time to time without prior notice. The latest operation procedures and relevant documents are available on <http://www.zkteco.com>.

If there is any issue related to the product, please contact us.

ZKTeco Headquarters

Address No. 32, Industrial Road, Tangxia Town, Dongguan, China.

Phone +86 769 - 82109991

Fax +86 755 - 89602394

For business related queries, please write to us at: sales@zkteco.com.

To know more about our global branches, visit www.zkteco.com.

About the Company

ZKTeco is one of the world's largest manufacturer of RFID and Biometric (Fingerprint, Facial, Finger-vein) readers. Product offerings include Access Control readers and panels, Near & Far-range Facial Recognition Cameras, Elevator/floor access controllers, Turnstiles, License Plate Recognition (LPR) gate controllers and Consumer products including battery-operated fingerprint and face-reader Door Locks. Our security solutions are multi-lingual and localized in over 18 different languages. At the ZKTeco state-of-the-art 700,000 square foot ISO9001-certified manufacturing facility, we control manufacturing, product design, component assembly, and logistics/shipping, all under one roof.

The founders of ZKTeco have been determined for independent research and development of biometric verification procedures and the productization of biometric verification SDK, which was initially widely applied in PC security and identity authentication fields. With the continuous enhancement of the development and plenty of market applications, the team has gradually constructed an identity authentication ecosystem and smart security ecosystem, which are based on biometric verification techniques. With years of experience in the industrialization of biometric verifications, ZKTeco was officially established in 2007 and now has been one of the globally leading enterprises in the biometric verification industry owning various patents and being selected as the National High-tech Enterprise for 6 consecutive years. Its products are protected by intellectual property rights.

About the Manual

This manual introduces the operations of **KF1200**.

All figures displayed are for illustration purposes only. Figures in this manual may not be exactly consistent with the actual products.

Features and parameters with ★ are not available in all devices.

Document Conventions

Conventions used in this manual are listed below:

GUI Conventions

For Device	
Convention	Description
< >	Button or key names for devices. For example, press <OK>.
[]	Window names, menu items, data table, and field names are inside square brackets. For example, pop up the [New User] window.
/	Multi-level menus are separated by forwarding slashes. For example, [File/Create/Folder].

Symbols





Convention	Description
	This represents a note that needs to pay more attention to.
	The general information which helps in performing the operations faster.
	The information which is significant.
	Care taken to avoid danger or mistakes.
	The statement or event that warns of something or that serves as a cautionary example.

Table of Contents

- 1 OVERVIEW 8**
 - 1.1 INTRODUCTION8
 - 1.2 FEATURES 8
 - 1.3 APPEARANCE 9
- 2 TERMINAL AND WIRING DESCRIPTION 11**
 - 2.1 TERMINAL DESCRIPTION 11
 - 2.2 WIRING DESCRIPTION 12
 - 2.2.1 POWER WIRING 12
 - 2.2.2 INBIO WIRING 13
 - 2.2.3 DM10 WIRING 14
- 3 INSTALLATION SET-UP 15**
 - 3.1 SAFETY PRECAUTIONS 15
 - 3.2 INSTALLATION SITE 15
 - 3.3 INSTALLATION STEPS 15
- 4 CONFIGURATION VIA WEBSERVER 17**
 - 4.1 LOGIN TO THE WEBSERVER 17
 - 4.2 SYSTEM INFORMATION 18
 - 4.2.1 DEVICE INFORMATION 18
 - 4.2.2 DEVICE CAPACITY 19
 - 4.2.3 FIRMWARE INFORMATION 19
 - 4.3 USER MANAGEMENT 20
 - 4.3.1 ADD USER 20
 - 4.3.2 SEARCH FOR USERS 21
 - 4.3.3 EDIT USER 21
 - 4.3.4 DELETING USERS 21

- 4.4 ADVANCED SETTINGS 22
 - 4.4.1 COMMUNICATION SETTINGS 22
 - 4.4.2 CLOUD SERVER SETTING 23
 - 4.4.3 WIRELESS NETWORK★ 24
 - 4.4.4 DATA/TIME SETTINGS 25
 - 4.4.5 SYSTEM SETTINGS 26
 - 4.4.6 SERIAL COMM. SETTINGS 26
 - 4.4.7 FACE PARAMETERS 28
 - 4.4.8 AUTOTEST 31
 - 4.4.9 WIEGAND SETUP 31
- 4.5 DEVICE MANAGEMENT 35
 - 4.5.1 DEVICE MANAGEMENT 35
 - 4.5.2 UPDATE FIRMWARE 36
 - 4.5.3 CHANGE PASSWORD 37
 - 4.5.4 OPERATION LOG 38
 - 4.5.5 DOWNLOAD FIRMWARE LOGS 38

5 CONNECT TO ZKBIOACCESS IVS SOFTWARE 39

- 5.1 SET THE COMMUNICATION ADDRESS 39
- 5.2 ADD DEVICE ON THE SOFTWARE 40
- 5.3 ADD PERSONNEL ON THE SOFTWARE 41

1 Overview

1.1 Introduction

KF1200 series is the innovative visible light facial recognition reader dedicated to InBio series biometric controller to adopt facial recognition technology, offering one of the fastest, most stable, most accurate facial recognition experiences in the industry.

As a new-era biometric reader, KF1200 series is equipped with a 100Mbps high-speed TCP/IP port for face templates and data synchronization. Wiegand and RS485 ports are also available to communicate with InBio Controllers for authentication use. The whole system is compiled with the ZKTeco Cyber Security Base Line (ZKCSBL) to ensure that users' data is under the finest protection that ZKTeco can offer.

1.2 Features

- Equipped with ZKTeco visible light facial recognition, offering one of the best facial recognition technologies in the industry.
- Supports up to 1,500 facial/30,000 cards/100,000 records.
- Supports multiple communication ports, TCP/IP, Wiegand output, RS485.
- User-friendly on-board web server for quick system configuration.
- Fully compatible with inBio Series controller and ZKBioAccess security platform.
- Fully complied with ZKCSBL (ZKTeco Cyber Security Base Line). Standard to provide advance protection.

1.3 Appearance

KF1200

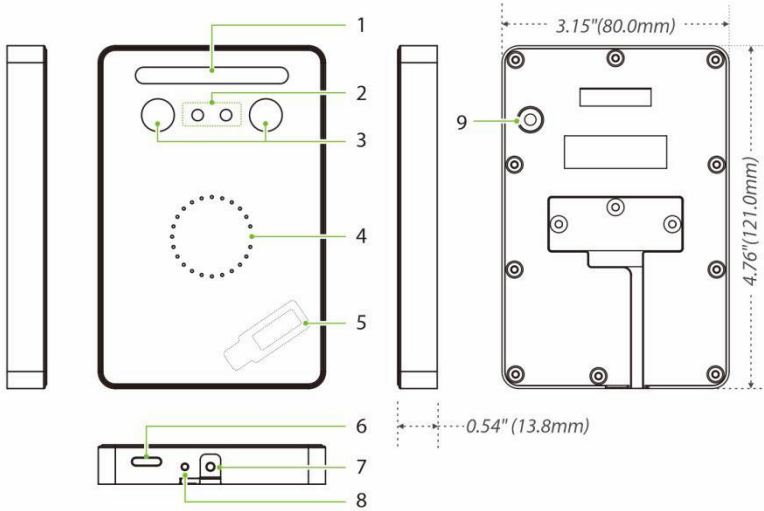

Back Plate

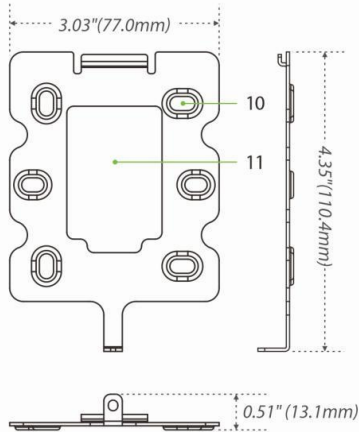

No.	Description
1	Flash
2	Camera
3	Near-Infrared Flash
4	LED Indicator
5	Receive Antenna / Card Reading Area
6	Speaker
7	Tamper Switch
8	Restart Button
9	Reset Button
10	Mounting Hole
11	Wiring Hole

Remark:

- *If you forget the WebServer password, you can restore the factory settings by pressing and holding the **Reset Button** for **5** seconds, and then logging in again with the initial password. This function does not have any clear registered user data.*

2 Terminal and Wiring Description

2.1 Terminal Description

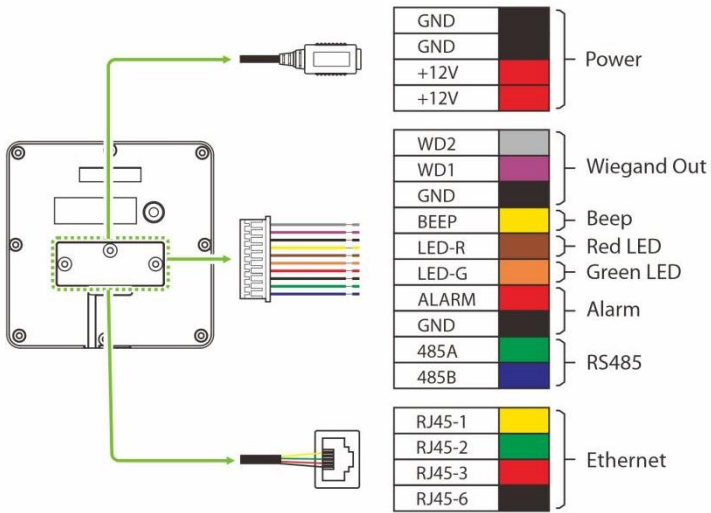

Figure 1-2 Terminal Description

Table 1-2 Description of Terminal and Interfaces

Name	Interface	Description
Power	GND	12V DC Input Note: <i>Minimum AC adapter:12V, 1.5A,</i> <i>Recommended AC adapter:12V, 3A.</i>
	GND	
	+12V	
	+12V	
Wiegand Out	WD2	Wiegand Output2
	WD1	Wiegand Output1
	GND	Grounding

Name	Interface	Description
Beep	BEEP	Beep Input
Red LED	LED-R	Red LED Input
Alarm	ALARM	Alarm Input
	GND	Grounding
RS485	485A	RS-485 Communication Interface For connecting to DM10/OSDP Output. Note: <i>User need to enable the DM10/OSDP Output function on the WebServer to access it.</i>
	485B	
Ethernet	LAN	Network Interface

2.2 Wiring Description

2.2.1 Power Wiring

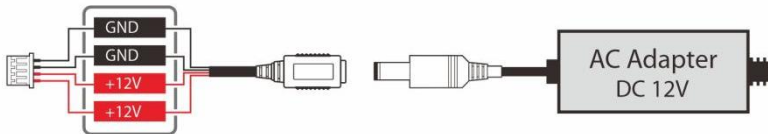

Figure 1-3 Power Wiring

Notes:

- *Minimum AC adapter:12V,1.5A, Recommended AC adapter:12V, 3A.*
- *To share the power with other devices, use an AC adapter with higher current ratings.*
- *Users need to configure their own suitable power adapter according to the product power specifications.*

2.2.2 InBio Wiring

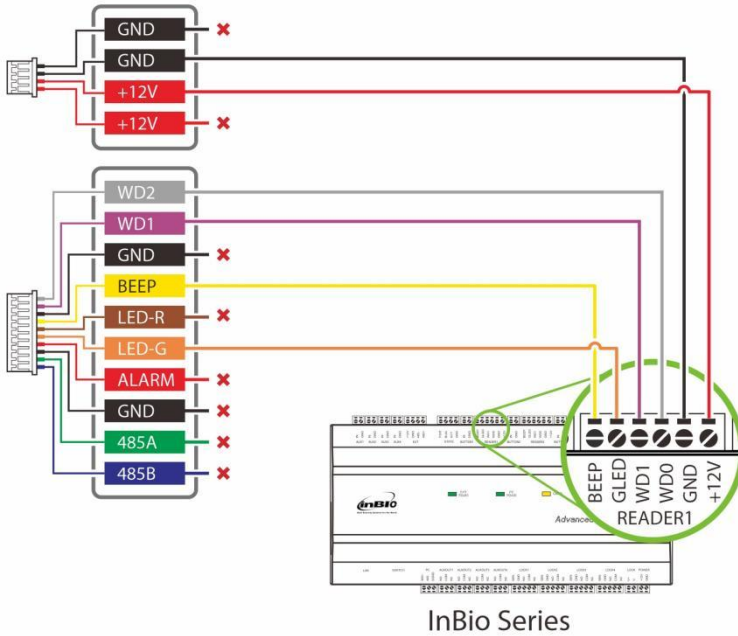

Figure 1-3 InBio Wiring

Notes:

- The KF1200 series is connected to the background management system by connecting with the InBio series controller. After the controller sends the data to the KF1200 series device, the user can perform face verification on the device. It is also possible to connect the reader with the input device and output device through the controller to form a complete control system to achieve high security level access control and intelligent management of entrances and exits.
- For more details, please refer to the InBio User Manual and ZKBioAccess IVS User Manual.

2.2.3 DM10 Wiring

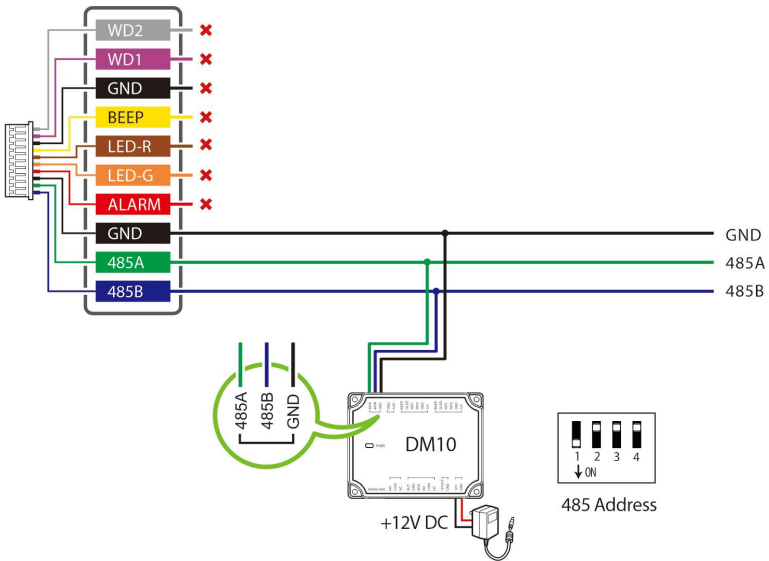

Figure 1-4 DM10 Wiring

Notes:

- The DM10 can only be used in software if it is connected to the KF1200 series via RS485.
- You need to manually enable the DM10 function on the Webserver to access it. It can be turned on via the following path: **[Advanced Settings] > [Serial Comm] > [Serial Port] > [DM10]**.
- Set the 485 address of DM10 to 1.
- A KF1200 series only supports connecting one DM10.
- Each device requires a separate power supply.
- The DM10 can be extended to connect the smoke detector, Wiegand Reader, Door Sensor, Exit Button and Alarm.

3 Installation Set-up

3.1 Safety Precautions

- Make sure the device in the package is in good condition and all the assembly parts are included.
- Make sure that the operating voltage is the same one labelled on the attendance device.
- Make sure all the related equipment is power-off during the installation.
- Keep the device away from water or dampness. Prevent water or moisture from entering the chassis of the attendance device.
- Do not place the device on an unstable case or desk. The device might be damaged severely in case of a fall.
- Do not open the chassis when the attendance device is operating or when electrical hazards are present to avoid electrical shocks.

3.2 Installation Site

The device must be installed indoors adequate clearance is reserved at the air inlet/exhaust vents for heat dissipation.

3.3 Installation Steps

Make sure that the device is installed as per the installation instructions. Otherwise, you will bear any consequence resulting from your actions.

Step 1: Attach the mounting template sticker to the wall, and drill holes according to the mounting paper.

Step 2: Fix the back plate on the wall using wall mounting screws.

Step 3: After passing the wires through the wiring hole and connecting them to the device, and then attach the device to the back plate from top to bottom.

Step 4: Fasten the device to the back plate with a security screw.

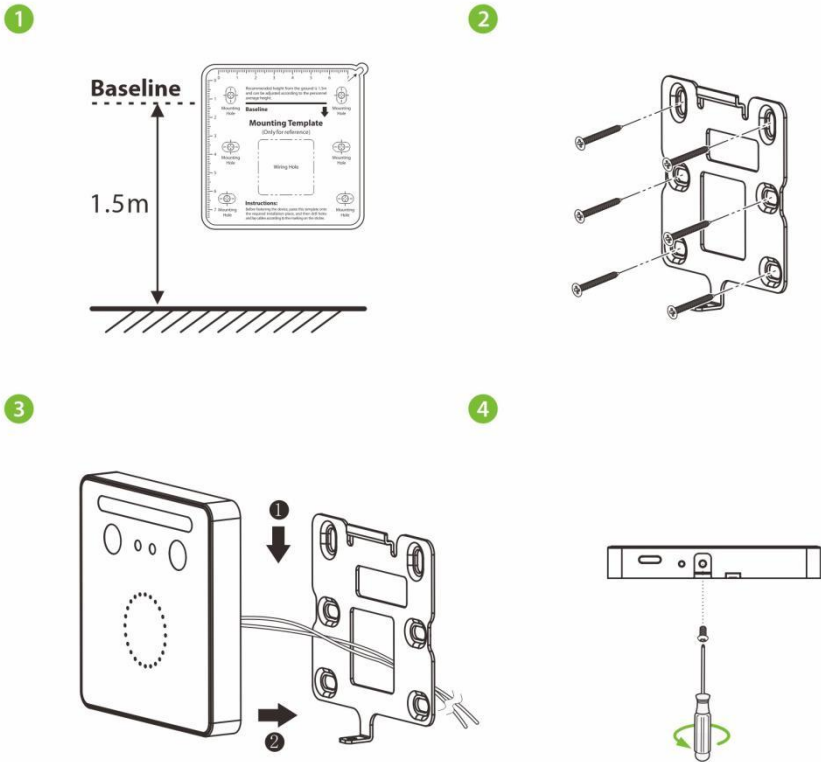

Figure1-5 KF1200 Series Installation

4 Configuration via WebServer

4.1 Login to the WebServer

After the device is powered on, connect the device using a network cable. Then open the recommended browser and input the IP address and server port in the address bar. The IP address is set as: <https://device IP address: Port> (for example: <https://192.168.1.201:1443>).

- **Device IP address: 192.168.1.201** is the default. You can modify the address on the WebServer through the following path: **[Advanced Settings] > [COMM.] > [IP Address]**.
- **Port: 1443** is the default.

Login to the WebServer

After opening the webserver login page. You may input the username which is **[Admin]** by default. And the default password for the new user is **[admin@123]**.

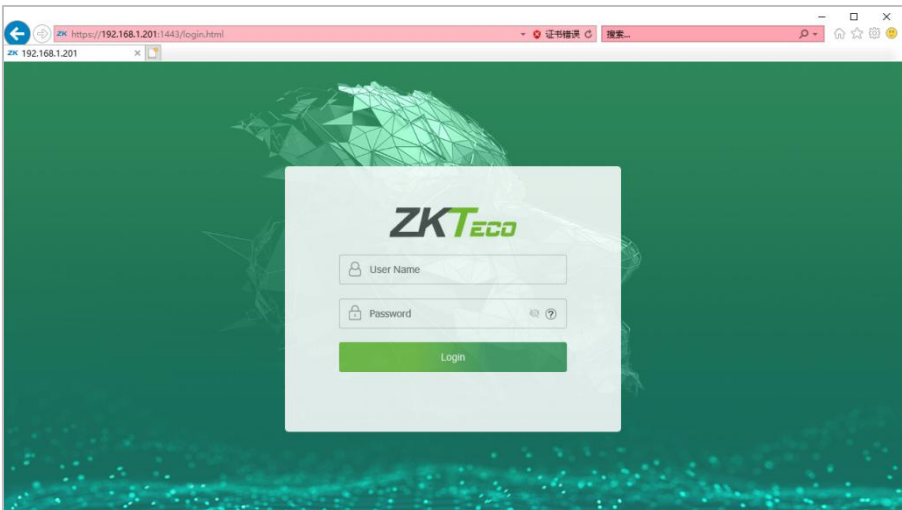

Change the Password

After the first login, please change the password; otherwise, the webserver function will be locked.

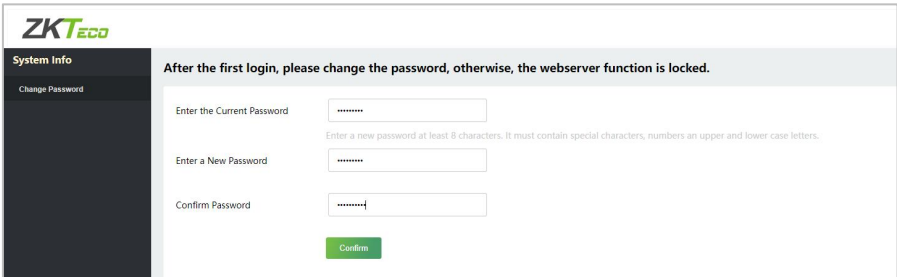

4.2 System Information

The System Information includes the device, device capacity and firmware information.

4.2.1 Device Information

The Device Information displays the Device Name, Serial Number, MCU Version, MAC Address, Face Algorithm, Platform Information, Manufacturer, and Manufacture Date.

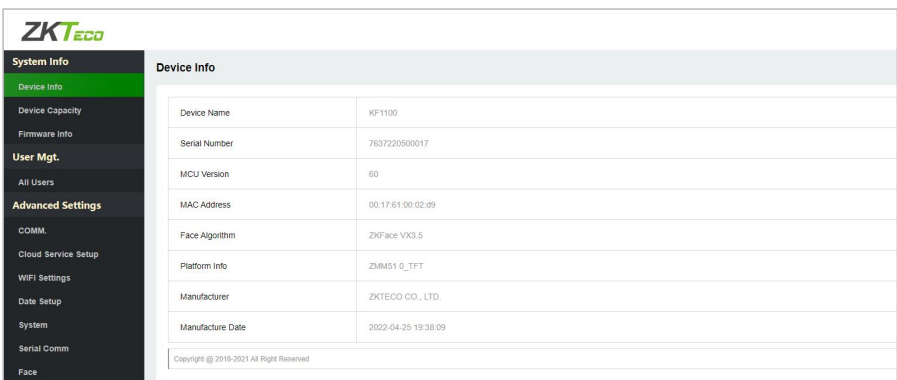

Device Info	
Device Name	KF1100
Serial Number	7637220500017
MCU Version	60
MAC Address	00:17:61:00:02:d9
Face Algorithm	ZKFace V3.5
Platform Info	ZIM651_0_TFT
Manufacturer	ZKTECO CO., LTD.
Manufacture Date	2022-04-25 19:38:09

Copyright © 2016-2021 All Right Reserved

4.2.2 Device Capacity

The Device Capacity displays the User Capacity, Admin User, Password, the used/max capacity of Face, the used/max capacity of Card, and the used/max capacity of T&A Record.

System Info Device Info Device Capacity Firmware Info User Mgt. All Users Advanced Settings COMM. Cloud Service Setup WIFI Settings	Device Capacity	
	User (used/max)	1/30000
	Admin User	0
	Password	0
	Face (used/max)	1/1500
	Card (used/max)	1/30000
	T&A Record (used/max)	23/100000

4.2.3 Firmware Information

Displays the firmware version and other version information of the device.

System Info Device Info Device Capacity Firmware Info User Mgt. All Users Advanced Settings COMM. Cloud Service Setup WIFI Settings Date Setup System Serial Comm Face Autotest	Firmware Info	
	Firmware Version	ZMM510-NFNSA-Ver1.1.1
	Bio Service	Ver 2.1.12-20220411
	Push Service	Ver 2.0.33S-20211012
	System Version	zmm500 v3.7.5 commit:669e1020c Mar 10 2022 10:49:05 CST
	Standalone Service	Ver 2.1.6-20211012
	Dev Service	Ver 2.0.1-20220411
	Web Service	Ver 2.0.1.001-20220509
	Licdm Service	Ver 1.13-20220301
	Mginit Service	Ver 1.13-20220301
	Libopts Service	Ver 1.06-20210201

4.3 User Management

You can manage the basic information of the registered users, including User ID, Name, Rights, Card Number, and Verification Mode in the User Management.

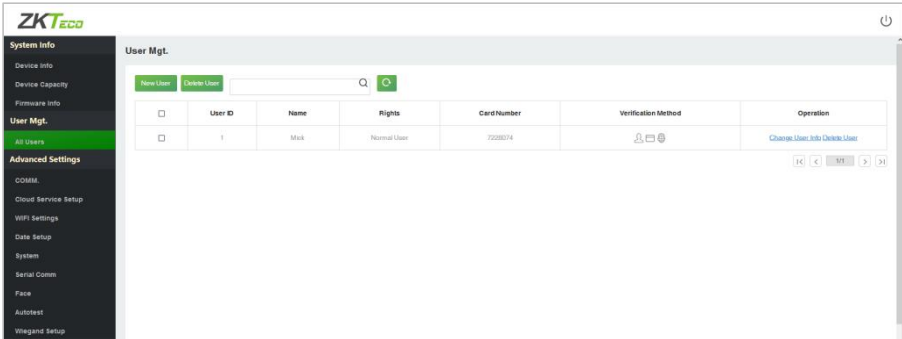

4.3.1 Add User

1. Click [User Mgt.] > [All Users] > [New User] to register a new user.

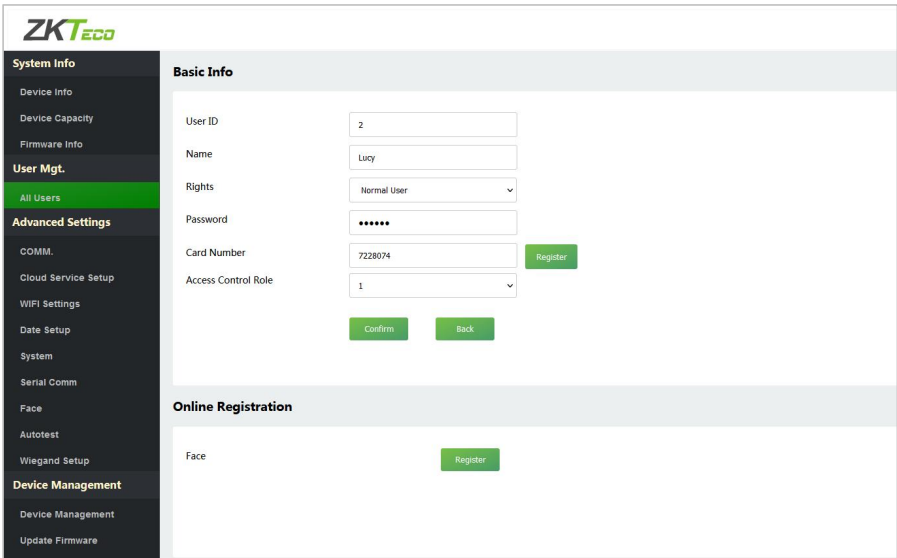

2. Enter the User ID, Name, Password, Card, setting user role and access control role.
3. Click [**Register**] on the card number bar and then place the card in the card induction area to register. After successful registration, the card number will be displayed on the input field.
4. After entering the basic information, click [**Confirm**] to save and then the interface will pop up a "**Enrolled Successfully!**" prompt.
5. Select **Face** on the **Online Registration** window and click [**Register**] to enter the face registration mode. Then users need to face the camera and adjust the position of the face according to the prompt of the LED indicator of the device, so that all the important features of the face can be captured by the camera. Then stay still for a while during face registration until registration is successful and the LED indicator turns green.

4.3.2 Search for Users

Select the **All Users** option in the **User Mgt.** Then enter the retrieval keyword in the search bar of the user list (keyword may be an ID, surname, or full name). The system will search for the users related to the entered information.

4.3.3 Edit User

Choose a user from the list and select **Change User Info** to enter the edit user interface.

Note:

- *The operation of editing a user is the same as that of adding a user, except that the user ID cannot be modified when editing a user's detail.*

4.3.4 Deleting Users

Choose a user from the list and select **Delete User**, all information of the user will be deleted.

4.4 Advanced Settings

On the advanced setting interface to set the relevant parameters as required. It includes options like Communication Settings, Cloud Server Setup, Wireless Network, Data Setup, System Settings, Serial Comm, Face Setting, Autotest, and Wiegand Setup.

4.4.1 Communication Settings

When the device needs to communicate with a PC over the Ethernet, you need to configure network settings and ensure that the device and the PC are connecting to the same network segment.

The screenshot shows the ZKTeco web interface for IP Setup. On the left is a dark sidebar with the ZKTeco logo at the top. Below the logo are menu items: System Info, Device Info, Device Capacity, Firmware Info, User Mgt., All Users, and Advanced Settings. The 'Advanced Settings' section is expanded, showing sub-items: COMM. (highlighted in green), Cloud Service Setup, WIFI Settings, Date Setup, System, and Serial Comm. The main content area is titled 'IP Setup' and contains a toggle for 'Automatic Acquisition' (currently off), and four input fields: 'IP Address' (192.168.1.201), 'Subnet Mask' (255.255.255.0), 'Gateway' (192.168.1.1), and 'DNS' (114.114.114.114). A green 'Confirm' button is located at the bottom center of the form.

- **IP Address:** The default value is 192.168.1.201, it can be modified according to the available network parameters.
- **Subnet Mask:** The default value is 255.255.255.0, it can be modified according to the available network parameters.
- **Gateway:** The default value is 0.0.0.0, it can be modified according to

the available network parameters.

- **DNS:** The default value is 0.0.0.0. Please set them according to the actual network situation.

4.4.2 Cloud Server Setting

The Cloud Server setting option helps to set different configurations used for connecting with the ADMS server.

The screenshot displays the ZKTeco Cloud Server Settings page. On the left is a dark sidebar menu with the following items: System Info, Device Info, Device Capacity, Firmware Info, User Mgt., All Users, Advanced Settings, COMM., Cloud Service Setup (highlighted in green), WIFI Settings, Date Setup, and System. The main content area is titled 'Cloud Server Settings' and includes the following fields and controls:

- Enable Domain Name:** A toggle switch currently set to 'OFF'.
- Cloud Server Address:** A text input field containing '192.168.163.61'.
- Cloud Service Port:** A text input field containing '8088'.
- HTTPS:** A toggle switch currently set to 'ON'.
- Proxy Server Setup:** A toggle switch currently set to 'OFF'.
- Confirm:** A green button at the bottom of the settings area.

- **Enable Domain Name:** When this function is enabled, the domain name mode "http://..." is used, such as <http://www.XYZ.com> (XYZ denotes the domain name). When this mode is turned OFF, you need to enter the IP address and port to connect to the WebServer.
- **Cloud Server Address:** IP address of the ADMS server is required.
- **Cloud Server Port:** Port used by the ADMS server is required.
- **HTTPS:** It is an HTTP channel with security as its goal. Based on HTTP, transmission encryption and identity authentication ensure the security

of the data transmission process.

- **Proxy Server Setup:** When a proxy is enabled, you need to set the IP address and port number of the proxy server.

4.4.3 Wireless Network★

The device supports the Wi-Fi module, which is built-in within the hardware, to enable data transmission via Wi-Fi and establish a wireless network environment. By default, the Wi-Fi is turned off. The user needs to enable and set the related parameters on the WebServer.

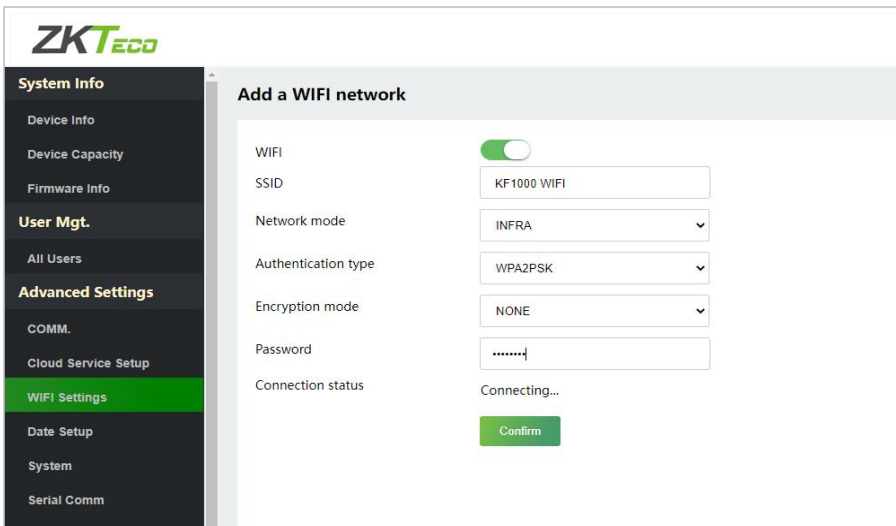

- Click the button to enable Wi-Fi function.
- When Wi-Fi is enabled, you need to enter the SSID and Password in the text box and then click [**Confirm**].
- After successful verification, the connection status will display "**Connected**".

4.4.4 Data/Time Settings

The screenshot shows the ZKTeco web interface with a sidebar menu on the left containing categories like System Info, User Mgt., Advanced Settings, and Device Management. The main content area is titled "Date Setup" and contains two configuration sections.

Date Setup Section:

- Configuration Mode:** Radio buttons for "Auto" (selected) and "Manual". A note below states: "Manual" means to input time manually, "Auto" means the time that will be retrieved automatically.
- Server Date and Time:** Input fields for 2022-05-14 and 09:44:09.
- Device Date and Time:** Input fields for 2022-05-14, 09:44:09, and a format (YYYY-MM-DD - HH:MM:SS).
- Confirm:** A green button to save the settings.

Daylight Saving Mode Section:

- Daylight Saving Mode:** A dropdown menu currently set to "Close".
- By Date/Time Mode:**
 - Daylight Saving Mode I:** Selected mode.
 - Daylight Saving Time:** Input fields for 00:00 (MM-DD) and 00:00 (HH:MM).
 - End of Day Lightsaving:** Input fields for 00:00 (MM-DD) and 00:00 (HH:MM).
- By Week/Day Mode:**
 - Daylight Saving Mode II:** Selected mode.
 - Start Time:** Input fields for Month (1), Number of Week (1), Week (0), (0-6), and Time (00:00) (HH:MM).
 - End Time:** Input fields for Month (1), Number of Week (1), Week (0), (0-6), and Time (00:00) (HH:MM).
- Confirm:** A green button to save the settings.

- **Configuration Mode:** To configure data and time, including automatic input and manual input. When Manual is selected, the date and time of the device can be entered manually.
- **Daylight Saving Mode:** Enable or disable the Daylight Saving Time Mode, by date/time mode and by week/day mode for selection.

Notes:

- *DST, which is also called **Daylight Saving Time**, is a system adjusting local time to save energy. The time adopted during the set dates is called "DST". Usually, the time will be one hour forward in summer. This enables users to sleep or get up earlier, and also reduce device's lighting to save power. In autumn, the time will resume the standard time. Regulations are different in*

different countries. At present, nearly 110 countries adopt DST.

- *To meet the demand of DST, a special option can be customized. Make the time one hour forward at XX (hour) XX (day) XX (month), and make the time one hour backward at XX (hour) XX (day) XX (month)*
- **How to set the Daylight Saving Time?**

For example, adjust the clock forward one hour at 08: 00 on April 1 and backward one hour at 08: 00 on October 1 (the system turns back to the original time).

4.4.5 System Settings

The screenshot shows the ZKTeco System Settings interface. On the left is a dark sidebar with a navigation menu. The 'System' option is highlighted in green. The main content area is titled 'System' and contains two settings: 'Volume' with a text input field containing '100', and 'Language' with a dropdown menu showing 'English'. A green 'Confirm' button is located below the settings.

- **Volume:** Adjust the volume of device. The valid value ranges from 0 to 100.
- **Language:** To select the language of the device.

4.4.6 Serial Comm. Settings

Serial Comm function facilitates to establish communication with the device through a serial port (RS485).

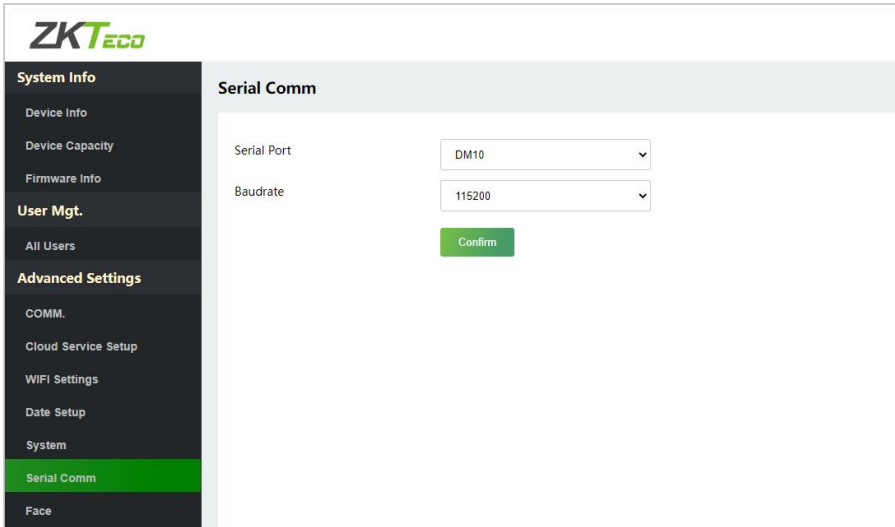

- **Serial Port:** Choose whether to communicate with the device through the serial port. There are 3 modes: No Using, OSDP Output and DM10.
 - **No Using:** Do not communicate with the device through the serial port.
 - **OSDP Output:** Communicates with the OSDP Output through RS485 serial port.
 - **DM10:** Communicates with the DM10 through RS485 serial port.
- **Baudrate:** The rate of the communication with PC; there are 5 options of baud rate: 115200 (default), 57600, 38400, 19200 and 9600. The higher is the baud rate, the faster is the communication speed, but also the less reliable. In general, a higher baud rate can be used when the communication distance is short; when the communication distance is long, choosing a lower baud rate would be more reliable.

4.4.7 Face Parameters

Parameter	Value
1:N Threshold Value	47
1:1 Threshold Value	63
Face Enrollment Threshold	70
Face Pitch Angle	30
Face Rotation Angle	25
Image Quality	70
Minimum Face Size	80
LED Light Trigger Value	80
Motion Detection Sensitivity	4
Anti-flicker Mode	50Hz
Live Detection	Off
Anti-spoofing Using NIR	On
Binocular Live Detection Threshold	Please input (0-100)
WDR	Off

- 1:N Threshold:** Under 1:N verification mode, the verification will only be successful when the similarity between the acquired facial image and all registered facial templates is greater than the set value.

The valid value ranges from 0 to 100. The higher the thresholds, the lower the misjudgment rate and higher the rejection rate, and vice versa. The default value of 47 is recommended.

- 1:1 Threshold Value:** Under 1:1 verification mode, the verification will only be successful when the similarity between the acquired facial image and the facial templates enrolled in the device is greater than the set value.

The valid value ranges from 0 to 100. The higher the thresholds, the lower the misjudgment rate and higher the rejection rate, and vice versa. The default value of 63 is recommended.

- Face Enrollment Threshold:** During face enrollment, 1:N comparison is

used to determine whether the user has already registered before. When the similarity between the acquired facial image and all registered facial templates is greater than the set threshold, it indicates that the face has already been registered.

- **Face Pitch Angle:** It is the pitch angle tolerance of a face for facial template registration and comparison. If a face's pitch angle exceeds the set value, it will be filtered by the algorithm, i.e., ignored by the terminal thus no registration and comparison interface will be triggered.
- **Face Rotation Angle:** It is the rotation angle tolerance of a face for facial template registration and comparison. If a face's rotation angle exceeds the set value, it will be filtered by the algorithm, i.e., ignored by the terminal thus no registration and comparison interface will be triggered.
- **Image Quality:** It is the image quality for facial registration and comparison. The higher the value, the clearer image is required.
- **Minimum Face Size:** It sets the minimum face size required for facial registration and comparison.

If the minimum size of the captured image is smaller than the set value, then it will be filtered off and not recognized as a face.

This value can also be interpreted as the face comparison distance. The farther the individual is, the smaller the face, and the smaller number of pixels of the face obtained by the algorithm. Therefore, adjusting this parameter can adjust the farthest comparison distance of faces. When the value is 0, the face comparison distance is not limited.

- **LED Light Trigger Threshold:** This value controls the turning on and off of the LED light. The larger the value, the LED light will turn on or off more frequently.

- **Motion Detection Sensitivity:** It sets the value for the amount of change in a camera's field of view known as potential motion detection that wakes up the terminal from standby to the comparison interface.
The larger the value, the more sensitive the system would be, i.e., if a larger value is set, the comparison interface activates with much ease, and the motion detection is frequently triggered.
- **Anti-flicker Mode:** It is used when WDR is turned off. It helps to reduce flicker when the device's screen flashes at the same frequency as the light.
- **Live Detection:** It detects the spoof attempt using visible light images to determine if the provided biometric source sample is of a real person (a live human being) or a false representation.
- **Live Detection Threshold:** It facilitates judging whether the captured visible image is a real person (a live human being). The larger the value, the better the anti-spoofing performance using visible light.
- **Anti-spoofing Using NIR:** Using near-infrared spectra imaging to identify and prevent fake photos and videos attack.
- **Binocular Live Detection Threshold:** It is convenient to judge whether the near-infrared spectral imaging is fake photo and video. The larger the value, the better the anti-spoofing performance of near-infrared spectral imaging.
- **WDR:** Wide Dynamic Range (WDR), which balances light and extends image visibility for surveillance videos under high contrast lighting scenes and improves object identification under bright and dark environment.

4.4.8 Autotest

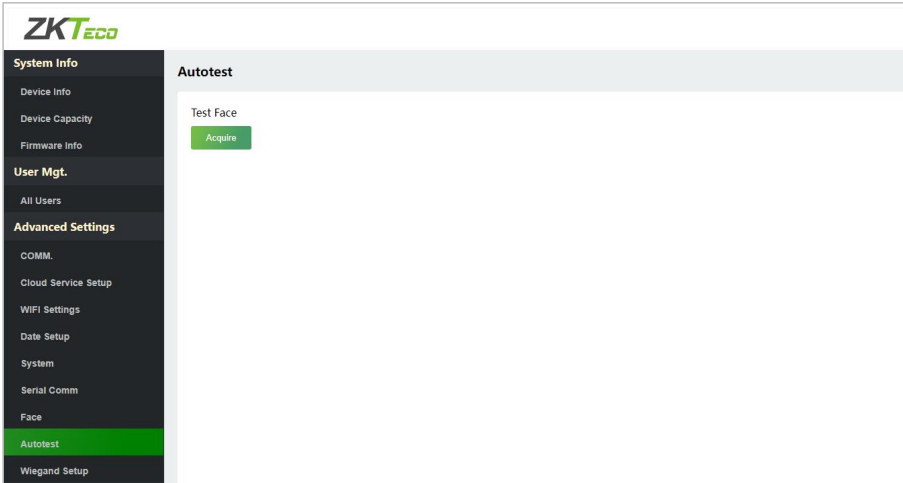

- **Test Face:** To test if the camera functions properly by checking the pictures taken to see if they are clear enough.

4.4.9 Wiegand Setup

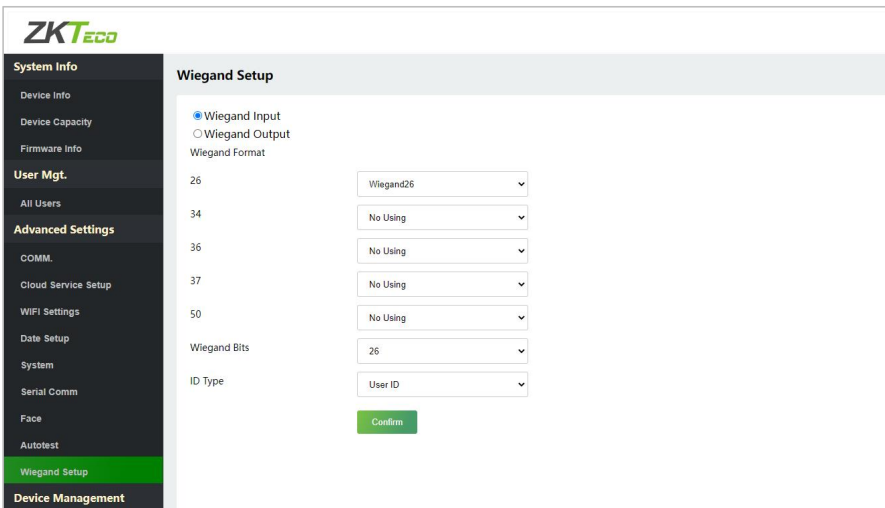

It is used to set the Wiegand input and output parameters.

- **Wiegand Format:** Its value can be 26 bits, 34 bits, 36 bits, 37 bits, and 50 bits.
- **Wiegand Bits:** The number of bits of the Wiegand data.
- **ID Type:** Select between the User ID and card number.
- **Various Common Wiegand Format Description:**

Wiegand Format	Description
<p>Wiegand26</p>	<p>ECCCCCCCCCCCCCCCCCCCCCCCCCO</p> <p>It consists of 26 bits of binary code. The 1st bit is the even parity bit of the 2nd to 13th bits, while the 26th bit is the odd parity bit of the 14th to 25th bits. The 2nd to 25th bits are the card numbers.</p>
<p>Wiegand26a</p>	<p>ESSSSSSSCCCCCCCCCCCCCCO</p> <p>It consists of 26 bits of binary code. The 1st bit is the even parity bit of the 2nd to 13th bits, while the 26th bit is the odd parity bit of the 14th to 25th bits. The 2nd to 9th bits are the site codes, while the 10th to 25th bits are the card numbers.</p>
<p>Wiegand34</p>	<p>ECCCCCCCCCCCCCCCCCCCCCCCCCO</p> <p>It consists of 34 bits of binary code. The 1st bit is the even parity bit of the 2nd to 17th bits, while the 34th bit is the odd parity bit of the 18th to 33rd bits. The 2nd to 25th bits are the card numbers.</p>

<p>Wiegand34a</p>	<p>ESSSSSSSSCCCCCCCCCCCCCCCCCCCCCCCCCO</p> <p>It consists of 34 bits of binary code. The 1st bit is the even parity bit of the 2nd to 17th bits, while the 34th bit is the odd parity bit of the 18th to 33rd bits. The 2nd to 9th bits are the site codes, while the 10th to 25th bits are the card numbers.</p>
<p>Wiegand36</p>	<p>OFFFFFFFFFCCCCCCCCCCCCCCCCMME</p> <p>It consists of 36 bits of binary code. The 1st bit is the odd parity bit of the 2nd to 18th bits, while the 36th bit is the even parity bit of the 19th to 35th bits. The 2nd to 17th bits are the device codes. The 18th to 33rd bits are the card numbers, and the 34th to 35th bits are the manufacturer codes.</p>
<p>Wiegand36a</p>	<p>EEEEEEEEEEEEEEEECCCCCCCCCCCCCO</p> <p>It consists of 36 bits of binary code. The 1st bit is the even parity bit of the 2nd to 18th bits, while the 36th bit is the odd parity bit of the 19th to 35th bits. The 2nd to 19th bits are the device codes, and the 20th to 35th bits are the card numbers.</p>
<p>Wiegand37</p>	<p>OMMMMSSSSSSSSSSSSCCCCCCCCCCCCCCE</p> <p>It consists of 37 bits of binary code. The 1st bit is the odd parity bit of the 2nd to 18th bits, while the 37th bit is the even parity bit of the 19th to 36th bits. The 2nd to 4th bits are the manufacturer codes. The 5th to 16th bits are the site codes, and the 21st to 36th bits are the card numbers.</p>

4.5 Device Management

It helps to set related system parameters to optimize the performance and usability of the device.

4.5.1 Device Management

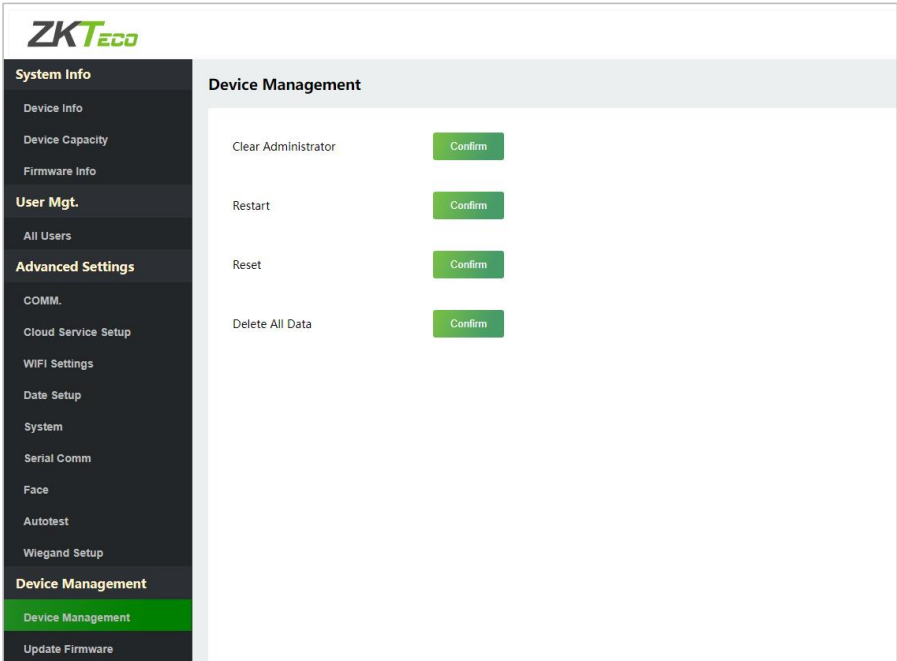

- **Clear Administrator:** To delete all the administrator.
- **Restart:** To restart the device.
- **Reset:** The Factory Reset function restores the device settings such as communication settings and system settings, to the default factory settings (this function does not clear registered user data).
- **Delete All Data:** To delete information and access records of all registered users.

4.5.2 Update Firmware

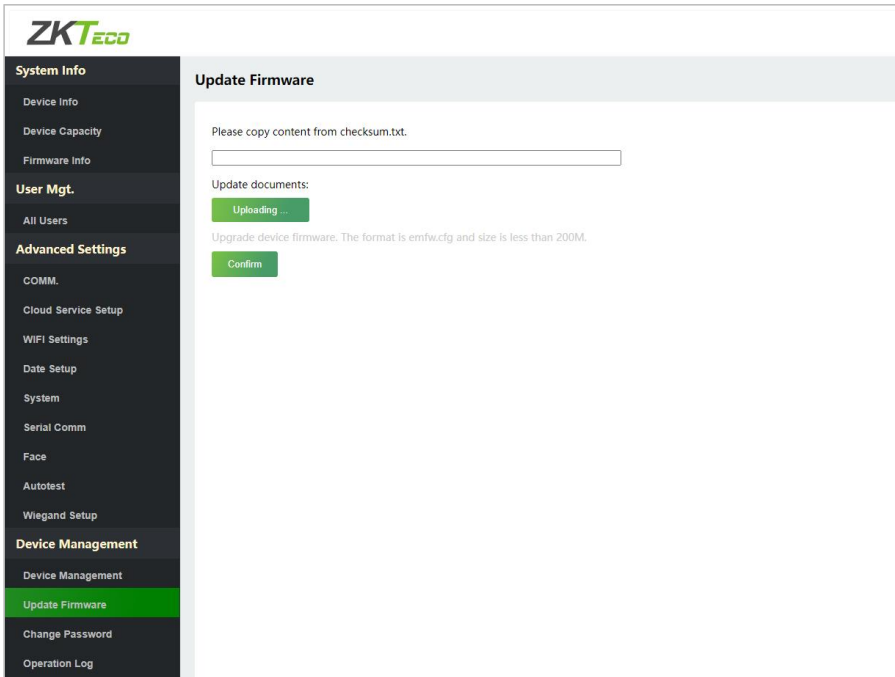

- Click [**Uploading...**] to upload the upgrade file in emfw.cfg format. And then click [**Confirm**] to upgrade firmware.

Note:

- *Make sure the size of the upgrade file is less than 200M.*
- *If an upgrade file is needed, please contact our technical support. Deny firmware upgrade under normal circumstances.*
- *Do not power off during the upgrade process.*

4.5.3 Change Password

The screenshot displays the ZKTeco web management interface. On the left is a dark sidebar with a menu. The main content area is divided into two sections: 'Change Password' and 'Reset Password'.
 In the 'Change Password' section, there are three text input fields labeled 'Enter the Current Password', 'Enter a New Password', and 'Confirm Password'. Below these fields is a green 'Confirm' button. A note below the 'Enter a New Password' field states: 'Enter a new password at least 8 characters. It must contain special characters, numbers an upper and lower case letters.'
 In the 'Reset Password' section, there is one text input field labeled 'Enter the Current Password' and a green 'Reset Password' button below it.

- When the user needs to change the password, he can set it on the Change Password window.
- The user can enter the current password in the Reset Password window and click [**Reset Password**] to restore the device to the factory password.

Note:

- *The password must be no less than 8 characters, and must contain special characters, numbers an upper and lower case letters.*

4.5.4 Operation Log

Operation Log

Start Time: End Time: [Download](#)

Operator	Operation	Time	Object	Original Value	New Value	Result
192.168.1.220	WEB Operation	2022-05-14T14:22:24	download operation log	0	0	0
192.168.1.220	WEB Operation	2022-05-14T13:38:54	Login	0	0	0
192.168.1.220	Reset	2022-05-14T11:52:26	0	0	0	0
192.168.1.220	Face Parameters	2022-05-14T10:49:45	-FaceMThr	1000	0	-1
192.168.1.220	Change Time (WEB)	2022-05-14T09:31:26	NTPService	0	1	0
192.168.1.220	WEB Operation	2022-05-14T09:23:41	Login	0	0	0
0	Power On	2022-05-14T09:04:06	0	0	0	0
192.168.1.220	Change Parameters	2022-05-13T18:39:32	WifiMac2DDE		1	0
192.168.1.220	Change Parameters	2022-05-13T19:39:32	WifiMacAuth	0	WiFiAPPSK	0
192.168.1.220	Change Parameters	2022-05-13T19:39:32	WifiMacEnc	2	NONE	0
192.168.1.220	Change Parameters	2022-05-13T19:39:32	WifiMacKey		admin1234	0
192.168.1.220	Comm Settings (WEB)	2022-05-13T19:11:03	DNS	0.0.0.0	114.114.114.114	0
192.168.1.220	Comm Settings (WEB)	2022-05-13T19:11:03	GATEWAYAddress	0.0.0.0	192.168.1.1	0
192.168.1.220	Register User	2022-05-13T18:43:46	1	0	0	0
192.168.1.220	Delete User	2022-05-13T18:42:37	1	0	0	0

- After entering the start time and end time, the user can view the Operation Logs on the page and click **[Download]** to download the operation logs.

4.5.5 Download Firmware Logs

Download Firmware Logs

Please select or enter the log file name: [Confirm](#)

- Users can download firmware logs here, including main.log, biometric.log and devs.log.

5 Connect to ZKBioAccess IVS Software

5.1 Set the Communication Address

Click [**Advanced Settings**] > [**COMM.**] > [**IP Address**] to set the IP address and then click [**Advanced Settings**] > [**Cloud Service Setup**] to set cloud service address on the WebServer. As shown in the figure below.

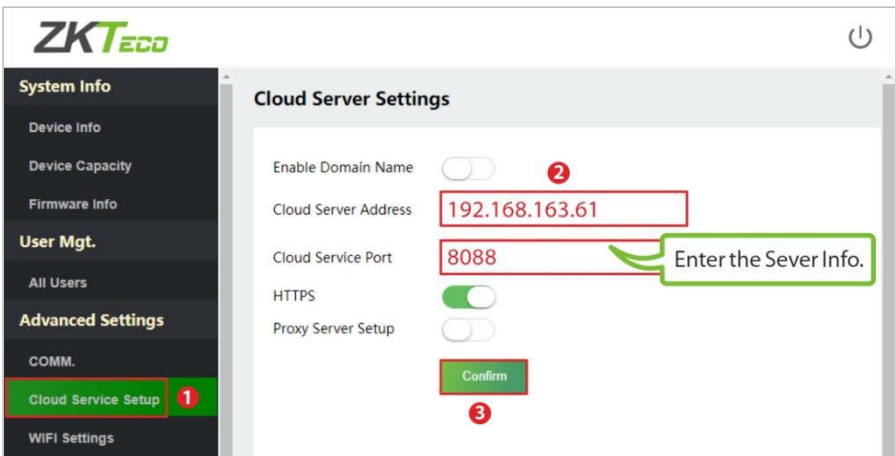
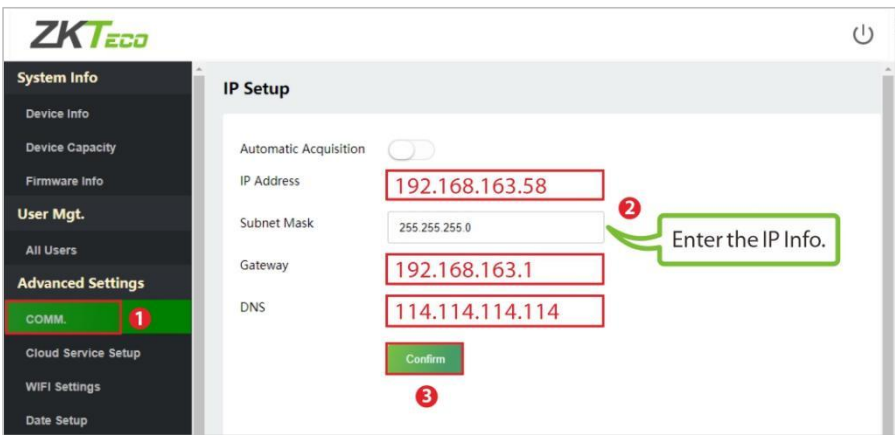

- **Cloud Server Address:** This is the IP address after the software installation.
- **Cloud Service Port:** Default is **8088**.

5.2 Add Device on the Software

Add the device by searching. The process is as follows:

1. Click **[Access] > [Device] > [Device] > [Search]** to search the device on the software. When an appropriate server address and port is set on the device, the searched devices are then displayed automatically.

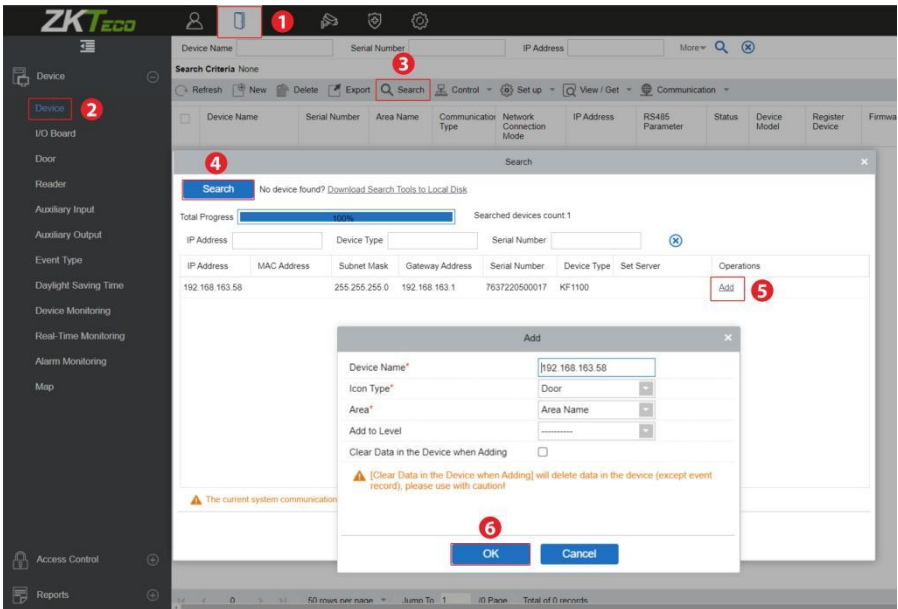

2. Click **[Add]** in an operation column, a new window will pop-up. Select Icon Type and Area from each drop-down and then click **[OK]** to add the device.

5.3 Add Personnel on the Software

1. Click **[Personnel]** > **[Person]** > **[New]** and fill in all the required fields to register new users in the software.

The screenshot shows a 'New' personnel registration window. The 'Card Number' field is highlighted with a red box and contains the value '7228074'. The form includes fields for Personnel ID, First Name, Gender, Certificate Type, Birthday, Device Verification Password, Biometrics Type, Department, Last Name, Mobile Phone, Certificate Number, Email, and a photo capture area. Below the main form is a 'Personnel Detail' section with tabs for Access Control, Time Attendance, and Personnel Detail. The Personnel Detail section includes fields for Superuser, Device Operation Role, Disabled, and Set Valid Time.

Note:

- The card number must be entered for use with the inBio series controllers.
2. Click **[Access]** > **[Device]** > **[Device]** > **[Control]** > **[Synchronize All Data to Devices]** to synchronize all the data to the device including the new users.

For more details, please refer to the ZKBioAccess IVS User Manual.

FCC Warning:

Any Changes or modifications not expressly approved by the party responsible for compliance could void the user's authority to operate the equipment.

Note: This equipment has been tested and found to comply with the limits for a Class B digital device, pursuant to part 15 of the FCC Rules. These limits are designed to provide reasonable protection against harmful interference in a residential installation. This equipment generates uses and can radiate radio frequency energy and, if not installed and used in accordance with the instructions, may cause harmful interference to radio communications. However, there is no guarantee that interference will not occur in a particular installation. If this equipment does cause harmful interference to radio or television reception, which can be determined by turning the equipment off and on, the user is encouraged to try to correct the interference by one or more of the following measures:

- Reorient or relocate the receiving antenna.
- Increase the separation between the equipment and receiver.
- Connect the equipment into an outlet on a circuit different from that to which the receiver is connected.
- Consult the dealer or an experienced radio/TV technician for help.

This device complies with part 15 of the FCC Rules. Operation is subject to the following two conditions: (1) This device may not cause harmful interference, and (2) this device must accept any interference received, including interference that may cause undesired operation.

This equipment complies with FCC radiation exposure limits set forth for an uncontrolled environment. This equipment should be installed and operated with minimum distance 20cm between the radiator & your body.

ZKTECO CO., LTD.

No.32,Pingshan Industrial Avenue,Tangxia Town,
Dongguan City,Guangdong Province,China

Phone : +86 769 - 82109991

Fax : +86 755 - 89602394

www.zkteco.com

