

TEST REPORT

Product Name : Smart Access Control Terminal
Model Number : Notus
FCC ID : 2AJ9T-20701

Prepared for : ZKTECO CO., LTD.
Address : No.32,Pingshan Industrial Avenue,Tangxia
Town,Dongguan City,Guangdong Province,China 523728

Prepared by : EMTEK (SHENZHEN) CO., LTD.
Address : Building 69, Majialong Industry Zone, Nanshan District,
Shenzhen, Guangdong, China

Tel: (0755) 26954280
Fax: (0755) 26954282

Report Number : ES210310047W02
Date(s) of Tests : March 11, 2021 to April 16, 2021
Date of issue : April 23, 2021

Table of Contents

1	EUT TECHNICAL DESCRIPTION.....	4
2	SUMMARY OF TEST RESULT.....	5
3	TEST METHODOLOGY.....	6
3.1	GENERAL DESCRIPTION OF APPLIED STANDARDS.....	6
3.2	MEASUREMENT EQUIPMENT USED.....	6
3.3	DESCRIPTION OF TEST MODES.....	7
4	FACILITIES AND ACCREDITATIONS.....	8
4.1	FACILITIES.....	8
4.2	LABORATORY ACCREDITATIONS AND LISTINGS.....	8
5	TEST SYSTEM UNCERTAINTY.....	9
6	SETUP OF EQUIPMENT UNDER TEST.....	10
6.1	RADIO FREQUENCY TEST SETUP 1.....	10
6.2	RADIO FREQUENCY TEST SETUP 2.....	10
6.3	CONDUCTED EMISSION TEST SETUP.....	11
6.4	BLOCK DIAGRAM CONFIGURATION OF TEST SYSTEM.....	12
6.5	SUPPORT EQUIPMENT.....	12
7	TEST REQUIREMENTS.....	13
7.1	OCCUPIED BANDWIDTH.....	13
7.2	RADIATED SPURIOUS EMISSION.....	15
7.3	CONDUCTED EMISSION TEST.....	25
8	ANTENNA APPLICATION.....	28

TEST RESULT CERTIFICATION

Applicant : ZKTECO CO., LTD..
 Address : No.32,Pingshan Industrial Avenue,Tangxia Town,Dongguan City,Guangdong Province,China 523728
 Manufacturer : ZKTECO CO., LTD..
 Address : No.32,Pingshan Industrial Avenue,Tangxia Town,Dongguan City,Guangdong Province,China 523728
 EUT : Smart Access Control Terminal
 Model Name : Notus
 Trademark : N/A

Measurement Procedure Used:

APPLICABLE STANDARDS	
STANDARD	TEST RESULT
FCC 47 CFR Part 2, Subpart J FCC 47 CFR Part 15, Subpart C	PASS

The above equipment was tested by EMTEK(SHENZHEN) CO., LTD. The test data, data evaluation, test procedures, and equipment configurations shown in this report were made in accordance with the procedures given in ANSI C63.10 (2013) and the energy emitted by the sample EUT tested as described in this report is in compliance with the requirements of FCC Rules Part 15.207&15.209.

The test results of this report relate only to the tested sample identified in this report.

Date of Test : March 11, 2021 to April 16, 2021

Prepared by : Mill Chen
 Mill Chen /Editor

Reviewer : Sewen Guo
 Sewen Guo /Supervisor

Approve & Authorized Signer : Lisa Wang
 Lisa Wang/Manager



1 EUT TECHNICAL DESCRIPTION

Product:	Smart Access Control Terminal
Model Number:	Notus
Power Supply	DC12V from adapter
Test sample	1#
Test Voltage	AC 120V/60Hz
Adapter	Model :ADS-40SI-12-3 Input:AC100-240V,50/60Hz,1.0A Max Output:DC12V,3.0A
Frequency Range:	125KHz
Antenna Type:	Induction coil antenna
Antenna Gain:	0.5 dBi
Temperature Range:	-20°C ~ +50°C
Date of Received	March 11, 2021

Note: for more details, please refer to the User's manual of the EUT.

2 SUMMARY OF TEST RESULT

FCC Part Clause	Test Parameter	Verdict	Remark
2.1049	Occupied Bandwidth	PASS	
15.209	Radiated Spurious Emissions	PASS	
15.207	Conducted Emission	PASS	
NOTE1: N/A (Not Applicable)			

RELATED SUBMITTAL(S) / GRANT(S):

This submittal(s) (test report) is intended for FCC ID: 2AJ9T-20701 filing to comply with Section 15.225 of the FCC Part 15, Subpart C Rules.



3 TEST METHODOLOGY

3.1 GENERAL DESCRIPTION OF APPLIED STANDARDS

According to its specifications, the EUT must comply with the requirements of the following standards:
 FCC 47 CFR Part 2, Subpart J
 FCC 47 CFR Part 15, Subpart C

3.2 MEASUREMENT EQUIPMENT USED

3.2.1 Conducted Emission Test Equipment

EQUIPMENT TYPE	MFR	MODEL NUMBER	SERIAL NUMBER	LASTCAL.	DUE CAL.
Test Receiver	Rohde & Schwarz	ESCS30	828985/018	05/16/2020	05/15/2021
L.I.S.N.	Schwarzbeck	NNLK8129	8129203	05/16/2020	05/15/2021
50Ω Coaxial Switch	Anritsu	MP59B	M20531	05/16/2020	05/15/2021
Pulse Limiter	Rohde & Schwarz	ESH3-Z2	100006	05/16/2020	05/15/2021
Voltage Probe	Rohde & Schwarz	TK9416	N/A	05/16/2020	05/15/2021
I.S.N	Rohde & Schwarz	ENY22	1109.9508.02	05/16/2020	05/15/2021

3.2.2 Radiated Emission Test Equipment

EQUIPMENT TYPE	MFR	MODEL NUMBER	SERIAL NUMBER	LAST CAL.	DUE CAL.
EMI Test Receiver	Rohde & Schwarz	ESU	1302.6005.26	05/16/2020	05/15/2021
Pre-Amplifier	HP	8447D	2944A07999	05/16/2020	05/15/2021
Bilog Antenna	Schwarzbeck	VULB9163	142	05/16/2020	05/15/2021
Loop Antenna	ARA	PLA-1030/B	1029	05/16/2020	05/15/2021
Horn Antenna	Schwarzbeck	BBHA 9170	BBHA9170399	05/16/2020	05/15/2021
Horn Antenna	Schwarzbeck	BBHA 9120	D143	05/16/2020	05/15/2021
Cable	Schwarzbeck	AK9513	ACRX1	05/16/2020	05/15/2021
Cable	Rosenberger	N/A	FP2RX2	05/16/2020	05/15/2021
Cable	Schwarzbeck	AK9513	CRPX1	05/16/2020	05/15/2021
Cable	Schwarzbeck	AK9513	CRRX2	05/16/2020	05/15/2021

3.2.3 Radio Frequency Test Equipment

EQUIPMENT TYPE	MFR	MODEL NUMBER	SERIAL NUMBER	LASTCAL.	DUE CAL.
Spectrum Analyzer	Agilent	E4407B	88156318	05/16/2020	05/15/2021
Signal Analyzer	Agilent	N9010A	My53470879	05/16/2020	05/15/2021
Power meter	Anritsu	ML2495A	0824006	05/16/2020	05/15/2021
Power sensor	Anritsu	MA2411B	0738172	05/16/2020	05/15/2021

Remark: Each piece of equipment is scheduled for calibration once a year.

3.3 DESCRIPTION OF TEST MODES

The EUT has been tested under its typical operating condition.

The EUT configuration for testing is installed on RF field strength measurement to meet the Commissions requirement and operating in a manner which intends to maximize its emission characteristics in a continuous normal application.

The Transmitter was operated in the normal operating mode. The TX frequency was fixed which was for the purpose of the measurements.

Pre-defined engineering program for regulatory testing used to control the EUT for staying in continuous transmitting mode is programmed.



4 FACILITIES AND ACCREDITATIONS

4.1 FACILITIES

All measurement facilities used to collect the measurement data are located at

Building 69, Majialong Industry Zone District, Nanshan District, Shenzhen, China

The sites are constructed in conformance with the requirements of ANSI C63.7, ANSI C63.10 and CISPR Publication 22.

4.2 LABORATORY ACCREDITATIONS AND LISTINGS

Site Description

EMC Lab.

: **Accredited by CNAS**

The Certificate Registration Number is L2291.

The Laboratory has been assessed and proved to be in compliance with CNAS-CL01 (identical to ISO/IEC 17025:2017)

Accredited by FCC

Designation Number: CN1204

Test Firm Registration Number: 882943

Accredited by A2LA

The Certificate Number is 4321.01.

Accredited by Industry Canada

The Conformity Assessment Body Identifier is CN0008

Name of Firm

: EMTEK (SHENZHEN) CO., LTD.

Site Location

: Building 69, Majialong Industry Zone, Nanshan District, Shenzhen, Guangdong, China

5 TEST SYSTEM UNCERTAINTY

The following measurement uncertainty levels have been estimated for tests performed on the apparatus:

Parameter	Uncertainty
Radio Frequency	$\pm 1 \times 10^{-5}$
Conducted Emissions Test	$\pm 2.0 \text{dB}$
Radiated Emission Test	$\pm 2.0 \text{dB}$
Occupied Bandwidth Test	$\pm 1.0 \text{dB}$
All emission, radiated	$\pm 3 \text{dB}$
Temperature	$\pm 0.5^\circ \text{C}$
Humidity	$\pm 3\%$

Measurement Uncertainty for a level of Confidence of 95%



6 SETUP OF EQUIPMENT UNDER TEST

6.1 RADIO FREQUENCY TEST SETUP 1

The component's antenna ports(s) of the EUT are connected to the measurement instrument per an appropriate attenuator. The EUT is controlled by PC/software to emit the specified signals for the purpose of measurements.

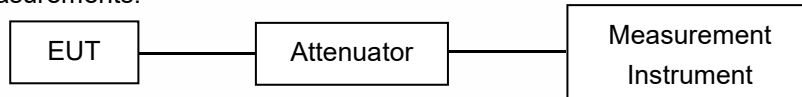

6.2 RADIO FREQUENCY TEST SETUP 2

The test site semi-anechoic chamber has met the requirement of NSA tolerance 4 dB according to the standards: ANSI C63.10. The test distance is 3m. The setup is according to the requirements in Section 13.1.4.1 of ANSI C63.10-2013 and CAN/CSA-CEI/IEC CISPR 22.

Below 30MHz:

The EUT is placed on a turntable 0.8 meters above the ground in the chamber, 3 meter away from the antenna (loop antenna). The Antenna should be positioned with its plane vertical at the specified distance from the EUT and rotated about its vertical axis for maximum response at each azimuth about the EUT. The center of the loop shall be 1 m above the ground. For certain applications, the loop antenna plane may also need to be positioned horizontally at the specified distance from the EUT.

Above 30MHz:

The EUT is placed on a turntable 0.8 meters above the ground in the chamber, 3 meter away from the antenna. The maximal emission value is acquired by adjusting the antenna height, polarisation and turntable azimuth. Normally, the height range of antenna is 1 m to 4 m, the azimuth range of turntable is 0° to 360°, and the receive antenna has two polarizations Vertical (V) and Horizontal (H).

(a) Radiated Emission Test Set-Up, Frequency Below 30MHz

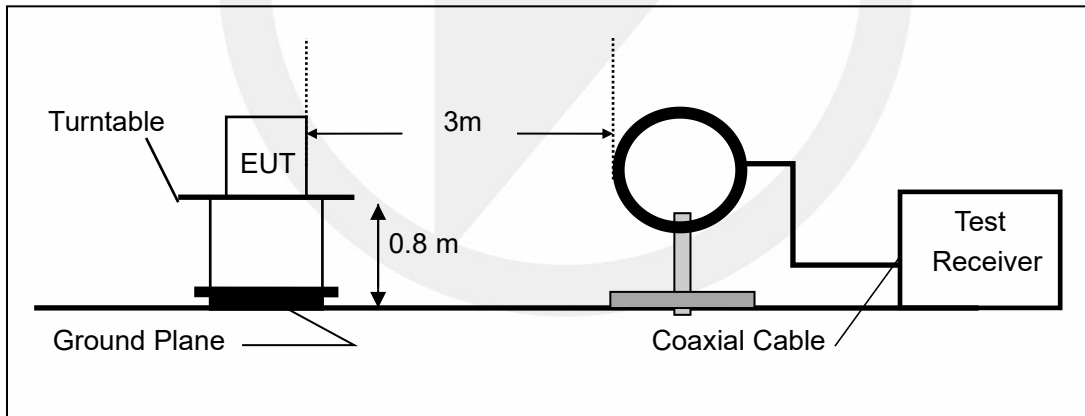

(b) Radiated Emission Test Set-Up, Frequency Below 1000MHz

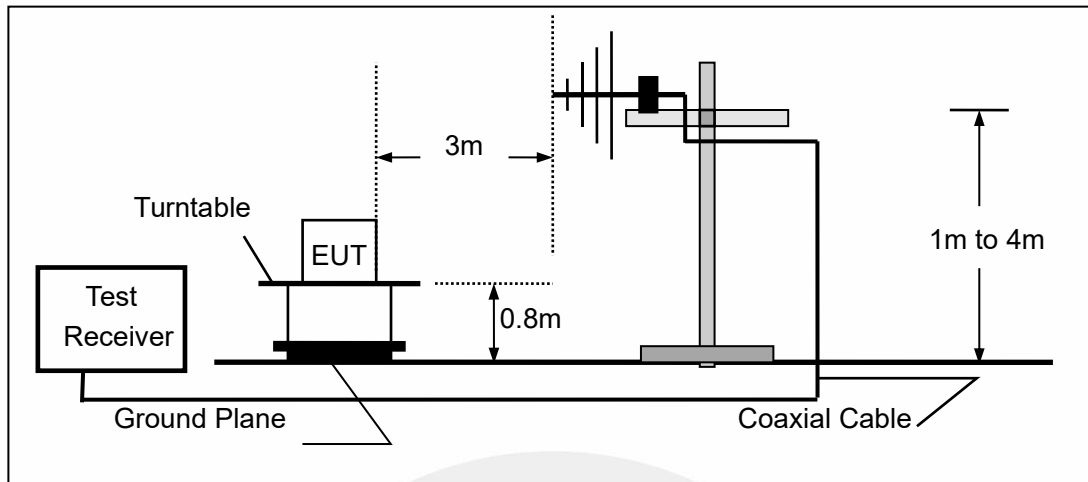

6.3 CONDUCTED EMISSION TEST SETUP

The mains cable of the EUT (maybe per AC/DC Adapter) must be connected to LISN. The LISN shall be placed 0.8 m from the boundary of EUT and bonded to a ground reference plane for LISN mounted on top of the ground reference plane. This distance is between the closest points of the LISN and the EUT. All other units of the EUT and associated equipment shall be at least 0.8m from the LISN.

Ground connections, where required for safety purposes, shall be connected to the reference ground point of the LISN and, where not otherwise provided or specified by the manufacturer, shall be of same length as the mains cable and run parallel to the mains connection at a separation distance of not more than 0.1 m.

According to the requirements in ANSI C63.10-2013 Conducted emissions from the EUT measured in the frequency range between 0.15 MHz and 30 MHz using CISPR Quasi-Peak and average detector mode.

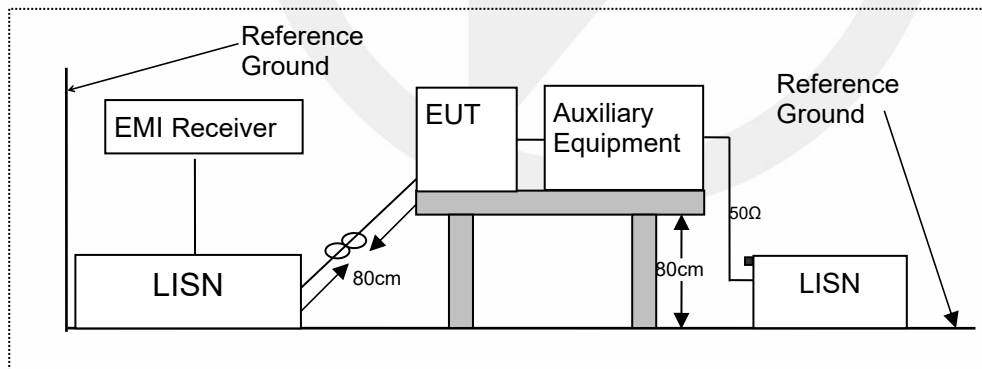

6.4 BLOCK DIAGRAM CONFIGURATION OF TEST SYSTEM

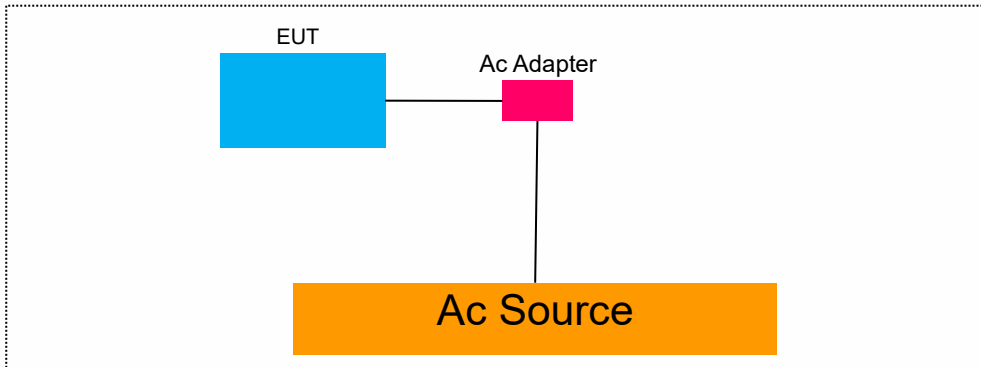

6.5 SUPPORT EQUIPMENT

EUT Cable List and Details			
Cable Description	Length (m)	Shielded/Unshielded	With / Without Ferrite
/	/	/	/

Auxiliary Cable List and Details			
Cable Description	Length (m)	Shielded/Unshielded	With / Without Ferrite
/	/	/	/

Auxiliary Equipment List and Details			
Description	Manufacturer	Model	Serial Number
/	/	/	/

Notes:

1. All the equipment/cables were placed in the worst-case configuration to maximize the emission during the test.
2. Grounding was established in accordance with the manufacturer's requirements and conditions for the intended use.
3. Unless otherwise denoted as EUT in [Remark] column, device(s) used in tested system is a support equipment

7 TEST REQUIREMENTS

7.1 OCCUPIED BANDWIDTH

7.1.1 Applicable Standard

According to FCC Part 2.1049

7.1.2 Conformance Limit

No limit requirement.

7.1.3 Test Configuration

Test according to clause 6.1 radio frequency test setup 1

7.1.4 Test Procedure

The EUT was operating in transmit mode and controlled its channel. Printed out the test result from the spectrum by hard copy function.

The RF output of EUT was connected to the spectrum analyzer by RF cable and attenuator. The path loss was compensated to the results for each measurement.

Set to the maximum power setting and enable the EUT transmit continuously

Set RBW = 1% occupied bandwidth (10Hz).

Set the video bandwidth (VBW) =3 times RBW .

Set Span= approximately 2 to 3 times the occupied bandwidth

Set Detector = Peak.

Set Trace mode = max hold.

Set Sweep = auto couple.

The EUT should be transmitting at its maximum data rate. Allow the trace to stabilize. Use the marker-to-peak function to set the marker to the peak of the emission. Use the marker-delta function to measure 99% down one side of the emission. Reset the markerdelta function, and move the marker to the other side of the emission, until it is (as close as possible to) even with the reference marker level. The marker-delta reading at this point is the 99% bandwidth of the emission.

If this value varies with different modes of operation (e.g., data rate, modulation format, etc.), repeat this test for each variation.

Measure and record the results in the test report.

7.1.5 Test Results

Temperature :	25°C	Test Date :	
Humidity :	65 %	Test By:	XW

Modulation Mode	Channel Number	Channel Frequency (KHz)	-20dB Measurement Bandwidth (kHz)	Limit (kHz)	Verdict
ASK	0	125	0.786	N/A	PASS
Note: N/A (Not Applicable)					

Test Model

Occupied Bandwidth
Channel 0: 125KHz

ASK Modulation

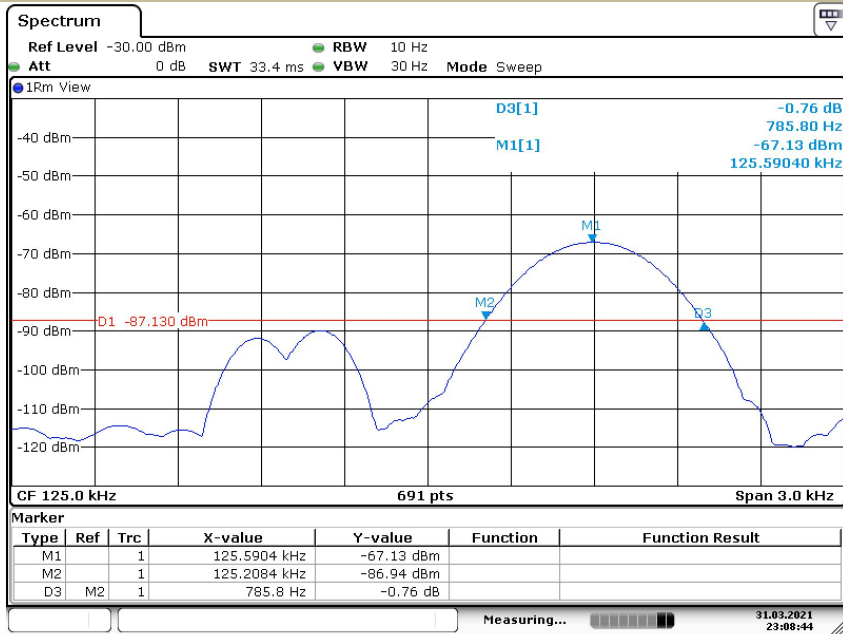

Date: 31.MAR.2021 23:08:44



7.2 RADIATED SPURIOUS EMISSION

7.2.1 Applicable Standard

According to FCC Part 15.209

7.2.2 Conformance Limit

FCC Part 15.209				
Frequency (MHz)	Field Strength Limitation		Field Strength Limitation Frequency tion at 3m Measurement Dist	
	(uV/m)	Dist	(uV/m)	(dBuV/m)
0.009 – 0.490	2400 / F(KHz)	300m	10000 * 2400/F(KHz)	20log 2400/F(KHz) + 80
0.490 – 1.705	24000 / F(KHz)	30m	100 * 24000/F(KHz)	20log 24000/F(KHz) + 40
1.705 – 30.00	30	30m	100* 30	20log 30 + 40
30.0 – 88.0	100	3m	100	20log 100
88.0 – 216.0	150	3m	150	20log 150
216.0 – 960.0	200	3m	200	20log 200
Above 960.0	500	3m	500	20log 500

According to FCC Part15.205, Restricted bands

MHz	MHz	MHz	GHz
0.090-0.110	16.42-16.423	399.9-410	4.5-5.15
10.495-0.505	16.69475-16.69525	608-614	5.35-5.46
2.1735-2.1905	16.80425-16.80475	960-1240	7.25-7.75
4.125-4.128	25.5-25.67	1300-1427	8.025-8.5
4.17725-4.17775	37.5-38.25	1435-1626.5	9.0-9.2
4.20725-4.20775	73-74.6	1645.5-1646.5	9.3-9.5
6.215-6.218	74.8-75.2	1660-1710	10.6-12.7
6.26775-6.26825	123-138	2200-2300	14.47-14.5
8.291-8.294	149.9-150.05	2310-2390	15.35-16.2
8.362-8.366	156.52475-156.52525	2483.5-2500	17.7-21.4
8.37625-8.38675	156.7-156.9	2690-2900	22.01-23.12
8.41425-8.41475	162.0125-167.17	3260-3267	23.6-24.0
12.29-12.293	167.72-173.2	3332-3339	31.2-31.8
12.51975-12.52025	240-285	3345.8-3358	36.43-36.5
12.57675-12.57725	322-335.4	3600-4400	(2)
13.36-13.41			

- Remark:
1. Emission level in dBuV/m=20 log (uV/m)
 2. Measurement was performed at an antenna to the closed point of EUT distance of meters.
 3. Only spurious frequency is permitted to locate within the Restricted Bands specified in provision of § 15.205, and the emissions located in restricted bands also comply with 15.209 limit.

7.2.3 Test Configuration

Test according to clause 6.2 radio frequency test setup 2

7.2.4 Test Procedure

This test is required for any spurious emission that falls in a Restricted Band, as defined in Section 15.205. It must be performed with the highest gain of each type of antenna proposed for use with the EUT. Use the following spectrum analyzer settings:

The EUT was placed on a turn table which is 0.8m above ground plane.

Maximum procedure was performed on the highest emissions to ensure EUT compliance.

Span = wide enough to fully capture the emission being measured

RBW = 100 kHz for $f < 1$ GHz(30MHz to 1GHz), 200Hz for $f < 150$ KHz(9KHz to 150KHz), 9KHz for $f < 30$ MHz(150KHz to 30KHz)

VBW \geq RBW

Sweep = auto

Detector function = peak

Trace = max hold

Follow the guidelines in ANSI C63.10-2013 with respect to maximizing the emission by rotating the EUT, measuring the emission while the EUT is situated in three orthogonal planes (if appropriate), adjusting the measurement antenna height and polarization, etc. A pre-amp and a high pass filter are required for this test, in order to provide the measuring system with sufficient sensitivity. Allow the trace to stabilize. The peak reading of the emission, after being corrected by the antenna factor, cable loss, pre-amp gain, etc., is the peak field strength, which must comply with the limit specified in Section 15.35(b). Submit this data.

Now set the VBW to 10 Hz, while maintaining all of the other instrument settings. This peak level, once corrected, must comply with the limit specified in Section 15.209. If the dwell time per channel of the hopping signal is less than 100 ms, then the reading obtained with the 10 Hz VBW may be further adjusted by a "duty cycle correction factor", derived from $20\log(\text{dwell time}/100 \text{ ms})$, in an effort to demonstrate compliance with the 15.209 limit. Submit this data.

Repeat above procedures until all frequency measured was complete.

7.2.5 Test Results

■ Spurious Emission below 150kHz (9kHz to 150kHz)

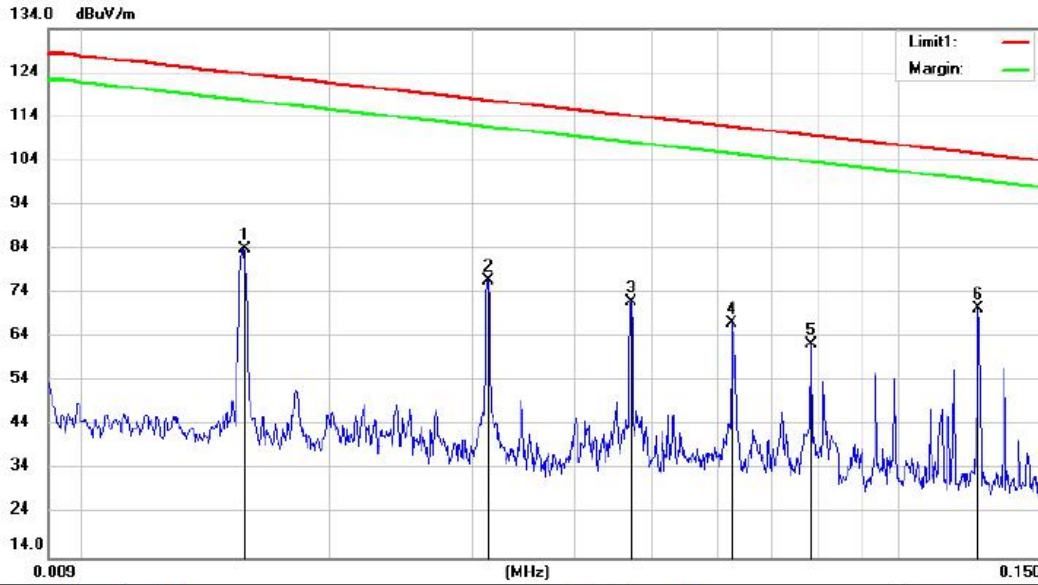

Site: 3m Chamber #1 Polarization: X Temperature: 29.5 C
 Limit: (RE)FCC PART 15.209(9K-30M) Power: AC 120V/60Hz Humidity: 48 %
 Mode: 125kHz
 Note:

No.	Mk.	Freq. MHz	Reading Level dBuV	Correct Factor dB	Measure- ment dBuV/m	Limit dBuV/m	Over dB	Detector	Antenna Height cm	Table Degree	Comment
1		0.0156	63.34	20.59	83.93	123.72	-39.79	QP			
2		0.0312	56.31	20.60	76.91	117.71	-40.80	QP			
3		0.0470	51.26	20.76	72.02	114.15	-42.13	QP			
4		0.0625	46.57	20.73	67.30	111.68	-44.38	QP			
5		0.0781	41.82	20.69	62.51	109.74	-47.23	QP			
6	*	0.1256	50.17	20.40	70.57	105.62	-35.05	QP			

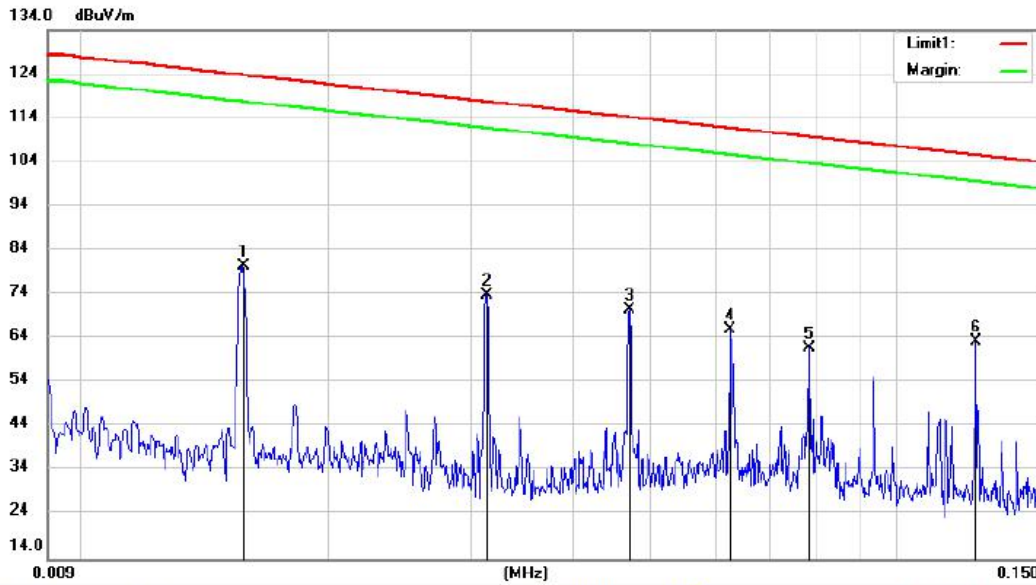

Site: 3m Chamber #1 Polarization: **Y** Temperature: 29.5 C
 Limit: (RE)FCC PART 15.209(9K-30M) Power: AC 120V/60Hz Humidity: 48 %
 Mode: 125kHz
 Note:

No.	Mk.	Freq. MHz	Reading Level dBuV	Correct Factor dB	Measure- ment dBuV/m	Limit dBuV/m	Over dB	Antenna Height cm	Table Degree	Comment
1		0.0156	59.89	20.59	80.48	123.72	-43.24	QP		
2		0.0312	53.31	20.60	73.91	117.71	-43.80	QP		
3		0.0470	49.85	20.76	70.61	114.15	-43.54	QP		
4		0.0625	45.44	20.73	66.17	111.68	-45.51	QP		
5		0.0781	41.29	20.69	61.98	109.74	-47.76	QP		
6	*	0.1256	42.89	20.40	63.29	105.62	-42.33	QP		

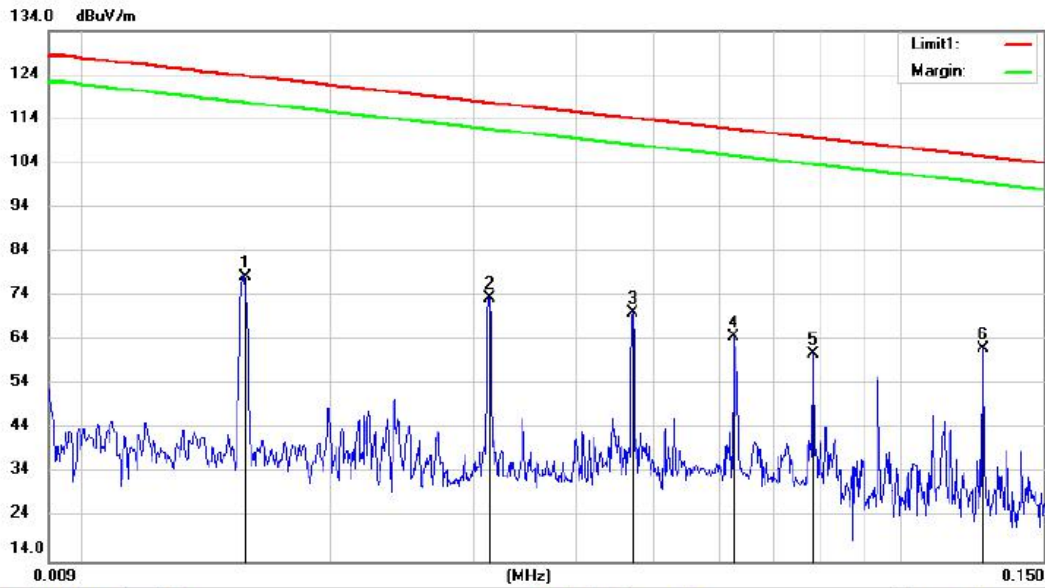

Site: 3m Chamber #1 Polarization: **Z** Temperature: 29.5 C
 Limit: (RE)FCC PART 15.209(9K-30M) Power: AC 120V/60Hz Humidity: 48 %
 Mode: 125kHz
 Note:

No.	Mk.	Freq. MHz	Reading Level dBuV	Correct Factor dB	Measure- ment dBuV/m	Limit dBuV/m	Over dB	Antenna Height cm	Table Degree	Comment
1		0.0156	57.80	20.59	78.39	123.72	-45.33	QP		
2		0.0312	52.82	20.60	73.42	117.71	-44.29	QP		
3		0.0470	49.35	20.76	70.11	114.15	-44.04	QP		
4		0.0625	43.97	20.73	64.70	111.68	-46.98	QP		
5		0.0781	40.34	20.69	61.03	109.74	-48.71	QP		
6	*	0.1263	41.72	20.38	62.10	105.57	-43.47	QP		

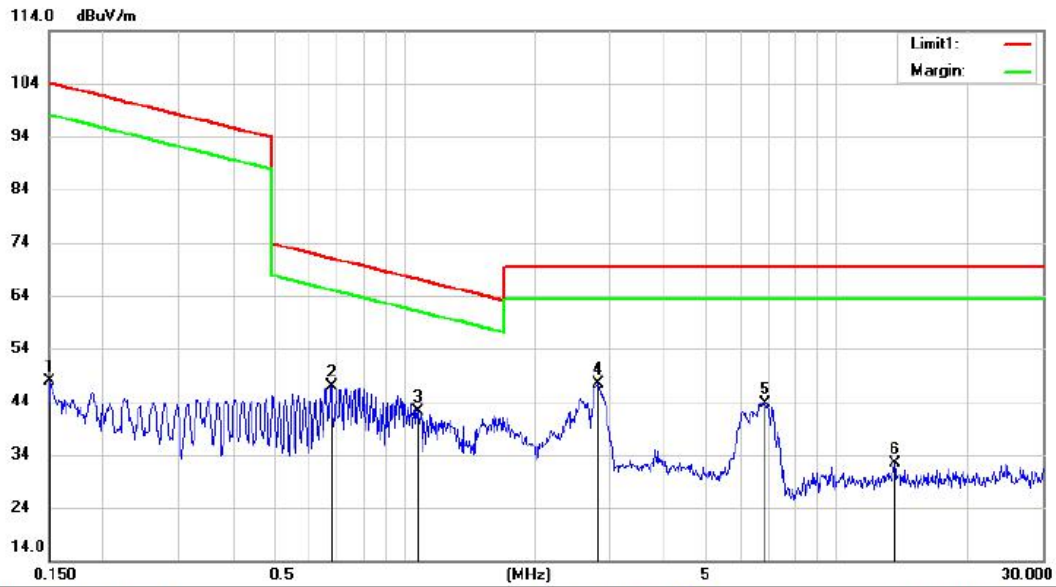

Site: 3m Chamber #1
 Limit: (RE)FCC PART 15.209(9K-30M)
 Mode: 125kHz
 Note:

Polarization: X
 Power: AC 120V/60Hz

Temperature: 29.5 C
 Humidity: 48 %

No.	Mk.	Freq. MHz	Reading Level dBuV	Correct Factor dB	Measure- ment dBuV/m	Limit dBuV/m	Over dB	Detector	Antenna Height cm	Table Degree	Comment
1		0.1507	27.54	20.29	47.83	104.04	-56.21	QP			
2		0.6753	25.83	21.04	46.87	71.02	-24.15	QP			
3		1.0710	21.15	21.08	42.23	67.03	-24.80	QP			
4	*	2.8090	26.65	20.68	47.33	69.50	-22.17	QP			
5		6.8050	23.15	20.58	43.73	69.50	-25.77	QP			
6		13.6228	12.21	20.21	32.42	69.50	-37.08	QP			

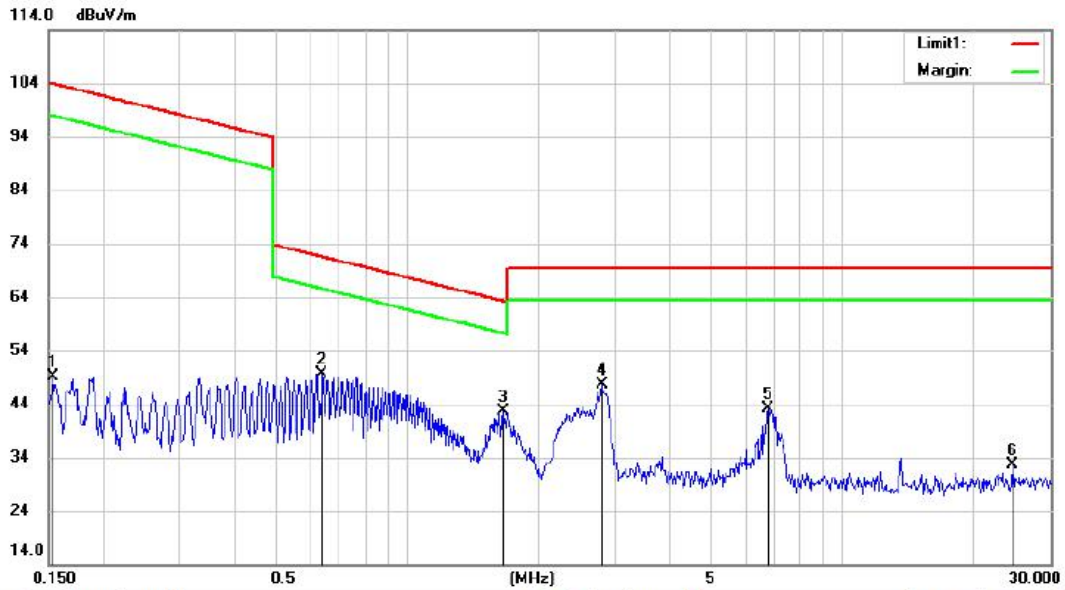

Site 3m Chamber #1 Polarization: **Y** Temperature: 29.5 C
 Limit: (RE)FCC PART 15.209(9K-30M) Power: AC 120V/60Hz Humidity: 48 %
 Mode: 125kHz
 Note:

No.	Mk.	Freq. MHz	Reading Level dBuV	Correct Factor dB	Measure- ment dBuV/m	Limit dBuV/m	Over dB	Antenna Height cm	Table Degree degree	Comment
1		0.1532	28.86	20.30	49.16	103.89	-54.73	QP		
2		0.6371	28.68	21.03	49.71	71.53	-21.82	QP		
3	*	1.6624	21.60	20.94	42.54	63.22	-20.68	QP		
4		2.7942	26.86	20.68	47.54	69.50	-21.96	QP		
5		6.7333	22.44	20.58	43.02	69.50	-26.48	QP		
6		24.5291	12.07	20.44	32.51	69.50	-36.99	QP		

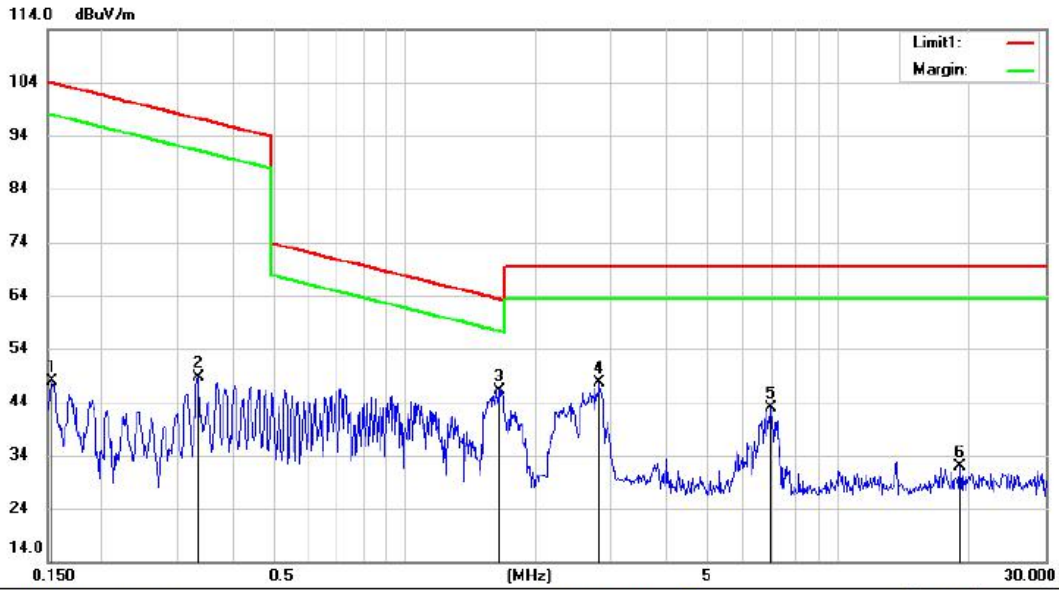

Site: 3m Chamber #1
 Limit: (RE)FCC PART 15.209(9K-30M)
 Mode: 125kHz
 Note:

Polarization: Z
 Power: AC 120V/60Hz
 Temperature: 29.5 C
 Humidity: 48 %

No.	Mk.	Freq. MHz	Reading Level dBuV	Correct Factor dB	Measure- ment dBuV/m	Limit dBuV/m	Over dB	Detector	Antenna Height cm	Table Degree	Comment
1		0.1532	27.66	20.30	47.96	103.89	-55.93	QP			
2		0.3338	27.86	20.66	48.52	97.13	-48.61	QP			
3	*	1.6450	25.29	20.95	46.24	63.31	-17.07	QP			
4		2.8090	27.07	20.68	47.75	69.50	-21.75	QP			
5		6.9508	22.28	20.58	42.86	69.50	-26.64	QP			
6		19.0210	11.61	20.32	31.93	69.50	-37.57	QP			

■ Spurious Emission Above 30MHz (30MHz to 1GHz)

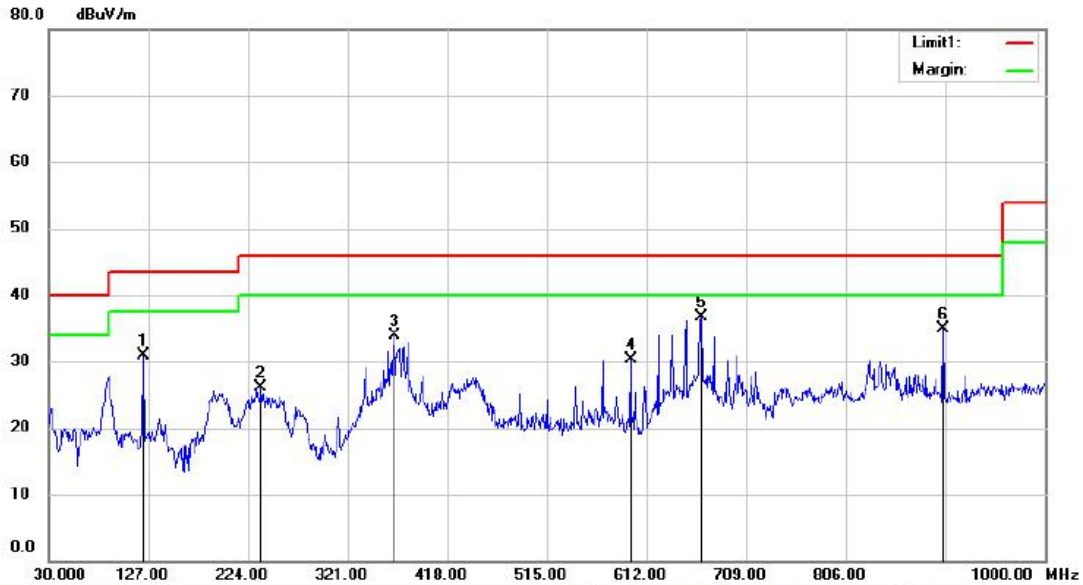

Site: 3m Chamber #1 Polarization: **Vertical** Temperature: 21.6 C
 Limit: (RE)FCC PART 15 CLASS B Power: AC 120V/60Hz Humidity: 45 %
 Mode: 125KHZ
 Note:

No.	Mk.	Freq. MHz	Reading Level dBuV	Correct Factor dB	Measure- ment dBuV/m	Limit dBuV/m	Over dB	Antenna Height cm	Table Degree degree	Comment
1		122.1500	48.41	-17.51	30.90	43.50	-12.60	QP		
2		236.6100	41.97	-15.86	26.11	46.00	-19.89	QP		
3		366.5900	44.45	-10.54	33.91	46.00	-12.09	QP		
4		596.4800	35.62	-5.25	30.37	46.00	-15.63	QP		
5	*	665.3500	40.28	-3.48	36.80	46.00	-9.20	QP		
6		901.0600	35.45	-0.57	34.88	46.00	-11.12	QP		

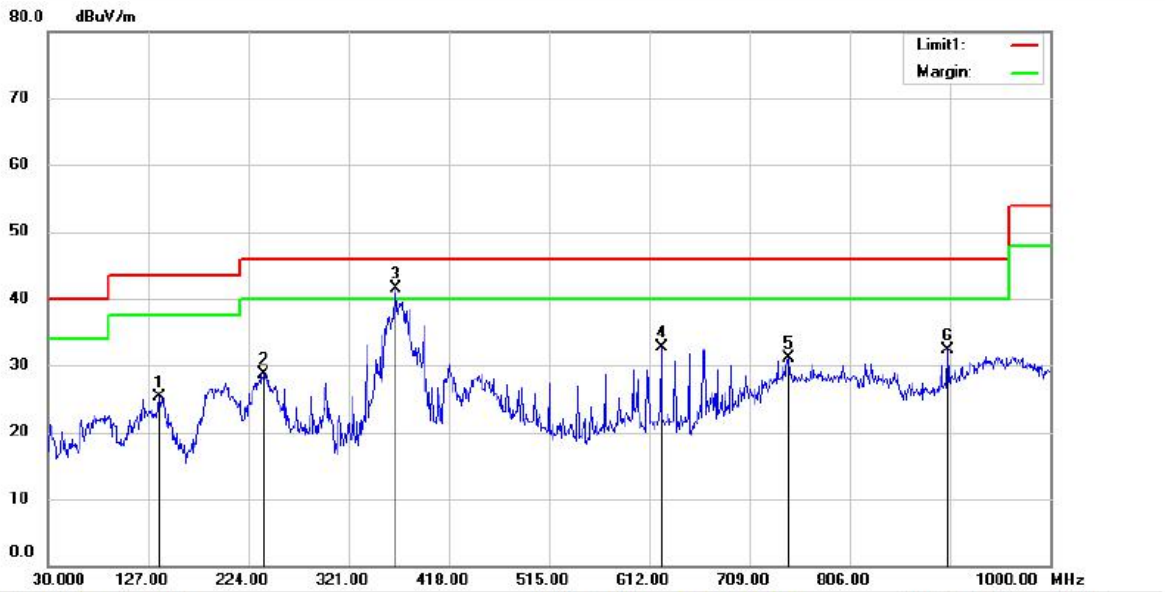

Site 3m Chamber #1 Polarization: **Horizontal** Temperature: 21.6 C

Limit: (RE)FCC PART 15 CLASS B
Mode: 125KHZ

Power: AC 120V/60Hz

Humidity: 45 %

Note:

No.	Mk.	Freq. MHz	Reading Level dBuV	Correct Factor dB	Measure- ment dBuV/m	Limit dBuV/m	Over dB	Antenna Height cm	Table Degree	Comment
1		137.6700	42.98	-17.58	25.40	43.50	-18.10	QP		
2		238.5500	44.48	-15.79	28.69	46.00	-17.31	QP		
3	*	366.5900	52.06	-10.54	41.52	46.00	-4.48	QP		
4		623.6400	37.23	-4.60	32.63	46.00	-13.37	QP		
5		746.8300	32.82	-1.64	31.18	46.00	-14.82	QP		
6		901.0600	32.89	-0.57	32.32	46.00	-13.68	QP		

7.3 CONDUCTED EMISSION TEST

7.3.1 Applicable Standard

According to FCC Part 15.207(a)

7.3.2 Conformance Limit

Conducted Emission Limit		
Frequency(MHz)	Quasi-peak	Average
0.15-0.5	66-56	56-46
0.5-5.0	56	46
5.0-30.0	60	50

Note: 1. The lower limit shall apply at the transition frequencies
 2. The limit decreases in line with the logarithm of the frequency in the range of 0.15 to 0.50MHz.

7.3.3 Test Configuration

Test according to clause 7.3 conducted emission test setup

7.3.4 Test Procedure

The EUT was placed on a table which is 0.8m above ground plane.
 Maximum procedure was performed on the highest emissions to ensure EUT compliance.
 Repeat above procedures until all frequency measured were complete.

7.3.5 Test Results

Pass

The 120V &240V voltage have been tested, and the worst result recorded was report as below:

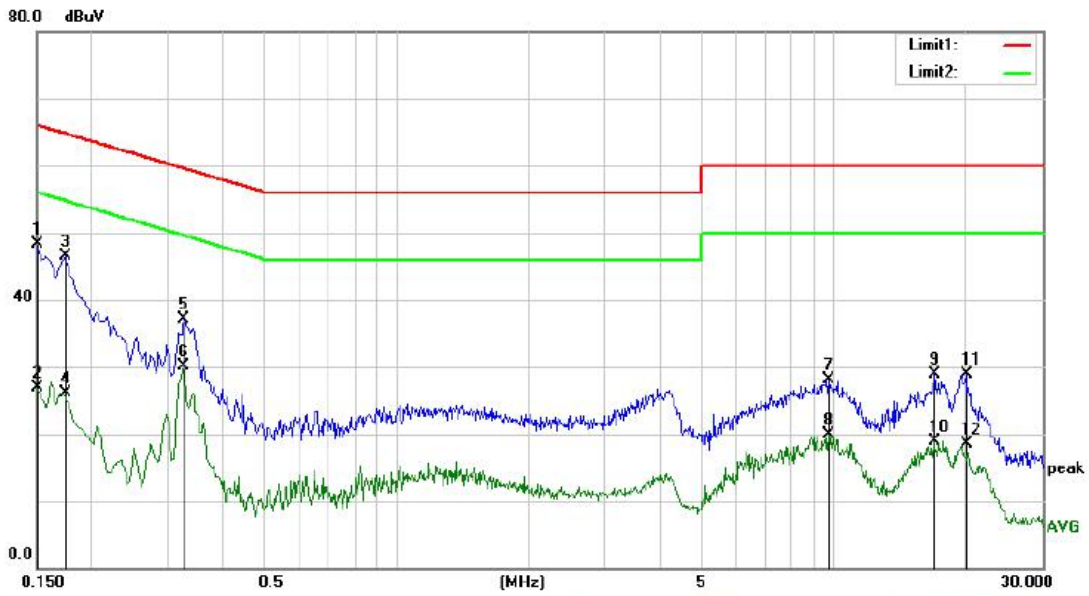

Site Conduction #1 Phase: **L1** Temperature: 24.7
 Limit: (CE)FCC PART 15 class B_QP Power: AC 120V/60Hz Humidity: 38 %
 Mode: RFID
 Note:

No.	Mk.	Freq. MHz	Reading Level dBuV	Correct Factor dB	Measure- ment dBuV	Limit dBuV	Over dB	Detector	Comment
1	*	0.1500	38.72	9.58	48.30	66.00	-17.70	QP	
2		0.1500	17.39	9.58	26.97	56.00	-29.03	AVG	
3		0.1740	36.97	9.50	46.47	64.77	-18.30	QP	
4		0.1740	16.65	9.50	26.15	54.77	-28.62	AVG	
5		0.3260	27.75	9.30	37.05	59.55	-22.50	QP	
6		0.3260	20.77	9.30	30.07	49.55	-19.48	AVG	
7		9.7140	17.99	10.14	28.13	60.00	-31.87	QP	
8		9.7140	9.79	10.14	19.93	50.00	-30.07	AVG	
9		17.0780	18.83	10.17	29.00	60.00	-31.00	QP	
10		17.0780	8.69	10.17	18.86	50.00	-31.14	AVG	
11		20.0660	18.71	10.17	28.88	60.00	-31.12	QP	
12		20.0660	8.32	10.17	18.49	50.00	-31.51	AVG	

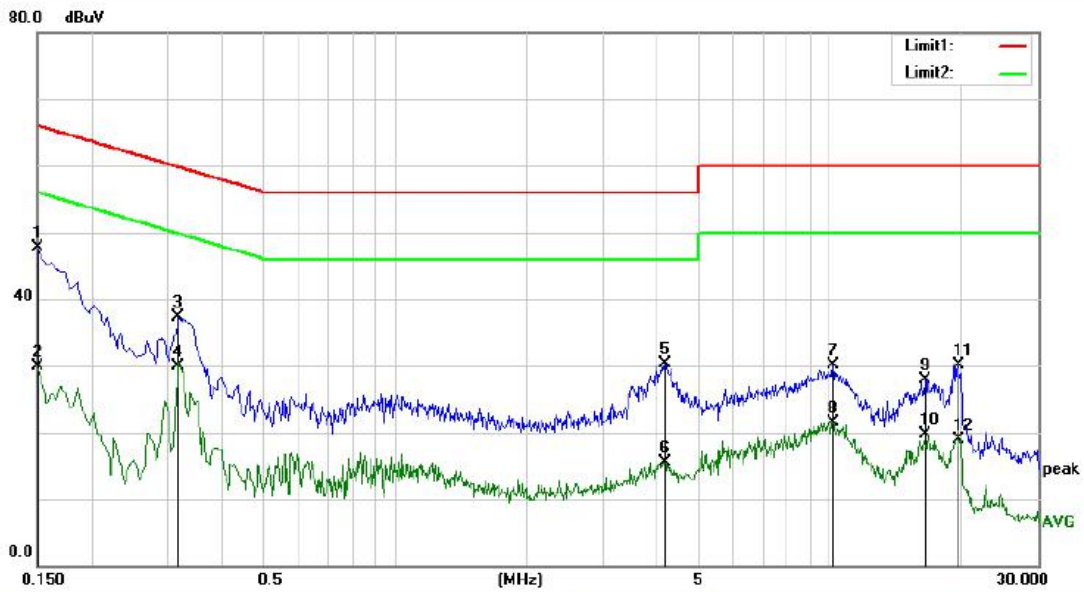

Site: Conduction #1
 Limit: (CE)FCC PART 15 class B_QP
 Mode: RFID
 Note:

Phase: N
 Power: AC 120V/60Hz
 Temperature: 24.7
 Humidity: 38 %

No.	Mk.	Freq. MHz	Reading Level dBuV	Correct Factor dB	Measure- ment dBuV	Limit dBuV	Over dB	Detector	Comment
1	*	0.1500	38.10	9.58	47.68	66.00	-18.32	QP	
2		0.1500	20.28	9.58	29.86	56.00	-26.14	AVG	
3		0.3180	27.98	9.30	37.28	59.76	-22.48	QP	
4		0.3180	20.55	9.30	29.85	49.76	-19.91	AVG	
5		4.1700	20.43	9.92	30.35	56.00	-25.65	QP	
6		4.1700	5.60	9.92	15.52	46.00	-30.48	AVG	
7		10.1620	19.86	10.15	30.01	60.00	-29.99	QP	
8		10.1620	11.36	10.15	21.51	50.00	-28.49	AVG	
9		16.5380	17.77	10.17	27.94	60.00	-32.06	QP	
10		16.5380	9.58	10.17	19.75	50.00	-30.25	AVG	
11		19.6420	19.88	10.17	30.05	60.00	-29.95	QP	
12		19.6420	8.79	10.17	18.96	50.00	-31.04	AVG	

8 ANTENNA APPLICATION

8.1.1 Antenna Requirement

Standard	Requirement
FCC CRF Part 15.203	<p>An intentional radiator shall be designed to ensure that no antenna other than that furnished by the responsible party shall be used with the device. The use of a permanently attached antenna or of an antenna that uses a unique coupling to the intentional radiator shall be considered sufficient to comply with the provisions of this section. The manufacturer may design the unit so that a broken antenna can be replaced by the user, but the use of a standard antenna jack or electrical connector is prohibited. This requirement does not apply to carrier current devices or to devices operated under the provisions of §15.211, §15.213, §15.217, §15.219, or §15.221. Further, this requirement does not apply to intentional radiators that must be professionally installed, such as perimeter protection systems and some field disturbance sensors, or to other intentional radiators which, in accordance with §15.31(d), must be measured at the installation site. However, the installer shall be responsible for ensuring that the proper antenna is employed so that the limits in this part are not exceeded.</p>

For intentional device, according to FCC 47 CFR Section 15.203, an intentional radiator shall be designed to ensure that no antenna other than that furnished by the responsible party shall be used with the device. if transmitting antennas of directional gain greater than 6dBi are used, the power shall be reduced by the amount in dB that the directional gain of the antenna exceeds 6dBi.

8.1.2 Result

The EUT'S antenna is coil antenna, The antenna's gain is 0.5dBi and meets the requirement. and the antenna can't be replaced by the user, which in accordance to section 15.203.