

FCC - TEST REPORT

Report Number : **60.792.21.002.01R01** Date of Issue : July 26, 2021

Model : **HG07822A-US, HG07822B-US**

Product Type : **Bluetooth Speaker**

Applicant : Lidl US, LLC

Address : 3500 South Clark Street, Arlington, VA 22202, US

Production Facility : Goldfield Technology Co., Ltd

Address : No. 28 Lingxia Road, Qiaotou Town, Dongguan City, China

Test Result : **Positive** **Negative**

Total pages including Appendices : 61

TÜV SÜD Certification and Testing (China) Co., Ltd. Shenzhen Branch is a subcontractor to TÜV SÜD Product Service GmbH according to the principles outlined in ISO 17025.

TÜV SÜD Certification and Testing (China) Co., Ltd. Shenzhen Branch reports apply only to the specific samples tested under stated test conditions. Construction of the actual test samples has been documented. It is the manufacturer's responsibility to assure that additional production units of this model are manufactured with identical electrical and mechanical components. The manufacturer/importer is responsible to the Competent Authorities in Europe for any modifications made to the production units which result in non-compliance to the relevant regulations. TÜV SÜD Certification and Testing (China) Co., Ltd. Shenzhen Branch shall have no liability for any deductions, inferences or generalizations drawn by the client or others from TÜV SÜD Certification and Testing (China) Co., Ltd. Shenzhen Branch issued reports.

This report is the confidential property of the client. As a mutual protection to our clients, the public and ourselves, extracts from the test report shall not be reproduced except in full without our written approval

1 Table of Contents

1 Table of Contents	2
2 Description of Equipment Under Test.....	3
3 Summary of Test Standards.....	4
4 Details about the Test Laboratory	5
4.1 Test Equipment Site List	6
4.2 Measurement System Uncertainty	7
5 Summary of Test Results	8
6 General Remarks	9
7 Test Setups	10
7.1 Radiated test setups Below 1GHz	10
7.2 Radiated test setups Above 1GHz.....	10
7.3 AC Power Line Conducted Emission test setups.....	11
7.4 Conducted RF test setups.....	11
8 Emission Test Results	12
8.1 Spurious Radiated Emission	12
8.2 Conducted Emission at AC Power line	16
8.3 20dB & 99% Bandwidth	18
8.4 Peak Output Power	24
8.5 Spurious Emissions at Antenna Terminals	30
8.6 100kHz Bandwidth of band edges	36
8.7 Minimum. Number of Hopping Frequencies.....	40
8.8 Minimum Hopping Channel Carrier Frequency Separation	42
8.9 Average Channel Occupancy Time	43
8.10 Antenna Requirement	49
9 Test setup procedure.....	50
10 Appendix A - General Product Information.....	60
11 Appendix B - Declaration of Model Difference.....	61

2 Description of Equipment Under Test

Description of the Equipment Under Test

Product:	Bluetooth speaker
Model no.:	HG07822A-US, HG07822B-US
FCC ID:	2AJ90-HG7822
Rating:	3.7V DC (From internal rechargeable battery) 5.0V DC (From USB charging port)
Frequency:	2402MHz-2480MHz (Tx and Rx)
Antenna gain:	-0.58 dBi
Number of operated channel:	79
Modulation:	GFSK, $\pi/4$ DQPSK

Auxiliary Equipment and Software Used during Test:

DESCRIPTION	MANUFACTURER	MODEL NO.	S/N
Computer	Lenovo	X220	0A72168
AC/DC adapter	Apple	A1537	/

Auxiliary Software Used during Test:

DESCRIPTION	SOFTWARE NAME	VERSION	REMARK
RF Test Mode Software	FCC Assist	1.4	Provided by applicant

3 Summary of Test Standards

Test Standards

FCC Part 15 Subpart C 10-1-20 Edition Federal Communications Commission, PART 15 — Radio Frequency Devices, Subpart C —Intentional Radiators
--

All the test methods were according to ANSI C63.10 (2013).

4 Details about the Test Laboratory

Site 1

Company name: TÜV SÜD Certification and Testing (China) Co., Ltd. Shenzhen Branch
 Building 12&13 Zhiheng Wisdomland Business Park,
 Nantou Checkpoint Road 2,
 Shenzhen 518052, P.R.China
 FCC Registration Number: 514049
 ISED test site number: 10320A

Emission Tests	
Test Item	Test Site
FCC Part 15 Subpart C	
FCC Title 47 Part 15.205, 15.209 & 15.247(d) Spurious Radiated Emission	Site 1
FCC Title 47 Part 15.207(a) AC Line Conducted Emission	Site 1
FCC Title 47 Part 15.247(a)(1) 20dB & 99% Bandwidth	Site 1
FCC Title 47 Part 15.247(b) Peak Output Power	Site 1
FCC Title 47 Part 2.1051 & 15.247(d) Spurious Emissions at Antenna Terminals	Site 1
FCC Title 47 Part 15.247(d) 100kHz Bandwidth of band edges	Site 1
FCC Title 47 Part 15.247(a)(1) Minimum Number of Hopping Frequencies	Site 1
FCC Title 47 Part 15.247(a)(1) Minimum Hopping Channel Carrier Frequency Separation	Site 1
FCC Title 47 Part 15.247(a)(1) Average Time of Occupancy	Site 1
FCC Title 47 Part 15.203 & 15.247(b) Antenna Requirement	Site 1

4.1 Test Equipment Site List

Radiated emission Test – Site 1

DESCRIPTION	MANUFACTURER	MODEL NO.	SERIAL NO.	CAL. DUE DATE
EMI Test Receiver	Rohde & Schwarz	ESR 26	101269	2021-6-29
Signal Analyzer	Rohde & Schwarz	FSV40	101031	2021-6-22
Loop Antenna	Rohde & Schwarz	HFH2-Z2	100398	2021-7-7
Trilog Super Broadband Test Antenna	Schwarzbeck	VULB 9163	707	2021-8-4
Horn Antenna	Rohde & Schwarz	HF907	102294	2021-7-5
Wideband Horn Antenna	Q-PAR	QWH-SL-18-40-K-SG	12827	2021-6-21
Pre-amplifier	Rohde & Schwarz	SCU 18	102230	2021-6-21
Pre-amplifier	Rohde & Schwarz	SCU 40A	100432	2021-7-30
Attenuator	Agilent	8491A	MY39264334	2021-6-21
3m Semi-anechoic chamber	TDK	9X6X6	----	2022-10-28
Test software	Rohde & Schwarz	EMC32	Version 9.15.00	N/A

Conducted Emission Test – Site 1

DESCRIPTION	MANUFACTURER	MODEL NO.	SERIAL NO.	CAL. DUE DATE
EMI Test Receiver	Rohde & Schwarz	ESR 3	101782	2021-6-29
LISN	Rohde & Schwarz	ENV4200	100249	2021-6-12
LISN	Rohde & Schwarz	ENV432	101318	2021-6-12
LISN	Rohde & Schwarz	ENV216	100326	2021-6-12
LISN	Rohde & Schwarz	ENV216	102472	2021-6-12
ISN	Rohde & Schwarz	ENY81	100177	2021-6-12
ISN	Rohde & Schwarz	ENY81-CA6	101664	2021-6-12
High Voltage Probe	Schwarzbeck	TK9420(VT9420)	9420-584	2021-6-23
RF Current Probe	Rohde & Schwarz	EZ-17	100816	2021-6-28
Attenuator	Shanghai Huaxiang	TS2-26-3	080928189	2021-6-21
Test software	Rohde & Schwarz	EMC32	Version9.15.00	N/A
Shielding Room	TDK	CSR #1	----	2020-11-07

20dB & 99% Bandwidth, Peak Output Power, Spurious Emissions at Antenna Terminals, 100kHz Bandwidth of band edges, hopping items – Site 1

DESCRIPTION	MANUFACTURER	MODEL NO.	SERIAL NO.	CAL. DUE DATE
Signal Analyzer	Rohde & Schwarz	FSV40	101030	2021-6-21
RF Switch Module	Rohde & Schwarz	OSP120/OSP-B157	101226/100851	2021-6-21

4.2 Measurement System Uncertainty

Measurement System Uncertainty Emissions

System Measurement Uncertainty	
Items	Extended Uncertainty
Uncertainty for Radiated Emission in 3m chamber 9kHz-30MHz	4.76dB
Uncertainty for Radiated Emission in 3m chamber 30MHz-1000MHz	Horizontal: 5.12dB; Vertical: 5.10dB;
Uncertainty for Radiated Emission in 3m chamber 1000MHz-25000MHz	Horizontal: 5.01dB; Vertical: 5.00dB;
Uncertainty for Conducted Emission at AC Power Line 150kHz-30MHz	3.21dB
Uncertainty for conducted power test	1.16dB
Uncertainty for frequency test	0.6×10^{-7}

5 Summary of Test Results

Emission Tests				
FCC Part 15 Subpart C				
Test Condition	Pages	Test Result		
		Pass	Fail	N/A
FCC Title 47 Part 15.205, 15.209 & 15.247(d) Spurious Radiated Emission	12-15	<input checked="" type="checkbox"/>	<input type="checkbox"/>	<input type="checkbox"/>
FCC Title 47 Part 15.207(a) AC Line Conducted Emission	16-17	<input checked="" type="checkbox"/>	<input type="checkbox"/>	<input type="checkbox"/>
FCC Title 47 Part 15.247(a)(2) 20dB & 99% Bandwidth	18-23	<input checked="" type="checkbox"/>	<input type="checkbox"/>	<input type="checkbox"/>
FCC Title 47 Part 15.247(b) Peak Output Power	24-29	<input checked="" type="checkbox"/>	<input type="checkbox"/>	<input type="checkbox"/>
FCC Title 47 Part 2.1051 & 15.247(d) Spurious Emissions at Antenna Terminals	30-35	<input checked="" type="checkbox"/>	<input type="checkbox"/>	<input type="checkbox"/>
FCC Title 47 Part 15.247(d) 100kHz Bandwidth of band edges	36-39	<input checked="" type="checkbox"/>	<input type="checkbox"/>	<input type="checkbox"/>
FCC Title 47 Part 15.247(a)(1) Min. No. of Hopping Frequencies	40-41	<input checked="" type="checkbox"/>	<input type="checkbox"/>	<input type="checkbox"/>
FCC Title 47 Part 15.247(a)(1) Min. of Hopping Channel Carrier Frequency Separation	42	<input checked="" type="checkbox"/>	<input type="checkbox"/>	<input type="checkbox"/>
FCC Title 47 Part 15.247(a)(1) Average Time of Occupancy	43-48	<input checked="" type="checkbox"/>	<input type="checkbox"/>	<input type="checkbox"/>
FCC Title 47 Part 15.203 & 15.247(b) Antenna Requirement	49	<input checked="" type="checkbox"/>	<input type="checkbox"/>	<input type="checkbox"/>

6 General Remarks

Remarks

Applicant informs that the **HG07822B-US** have the same technical construction including circuit diagram, PCB Layout, components and component layout, all electrical construction and mechanical construction with **Bluetooth speaker, HG07822A-US**. The difference lies only on the different color of the different models. (Applicant's conformation letter shown at appendix B)

EMC tests were performed on model: **HG07822A-US**. All data packet type mode have been tested, only the worst case is shown on the report.

This submittal(s) (test report) is intended for **FCC ID: 2AJ90-HG7822**, complies with Section 15.203, 15.205, 15.207, 15.209, 15.247 of the FCC Part 15, Subpart C rules for the DSS grant.

The TX and RX range is 2402MHz-2480MHz.

SUMMARY:

- All tests according to the regulations cited on page 8 were

- Performed

- **Not** Performed

- The Equipment Under Test

- **Fulfills** the general approval requirements.

- **Does not** fulfill the general approval requirements.

Sample Received Date: May 17, 2021

Testing Start Date: May 20, 2021

Testing End Date: June 10, 2021

- TÜV SÜD Certification and Testing (China) Co., Ltd. Shenzhen Branch -

Reviewed by:

Prepared by:

Tested by:



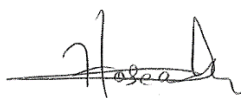



Eric LI
EMC Project Manager

Hosea CHAN
EMC Project Engineer

Louise Liu
EMC Test Engineer

7 Test Setups

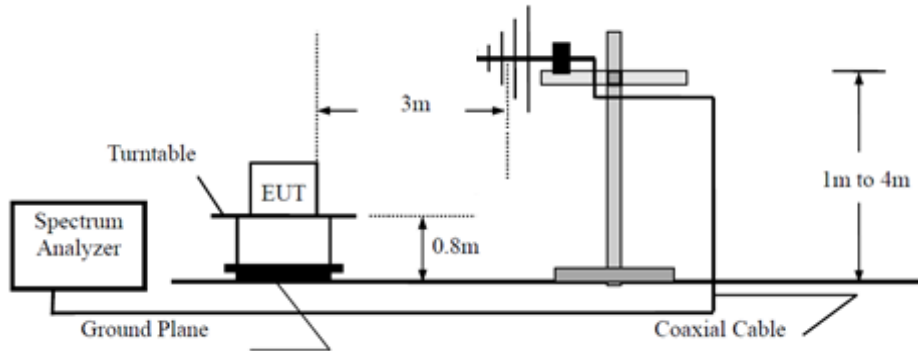
7.1 Radiated test setups Below 1GHz



7.2 Radiated test setups Above 1GHz

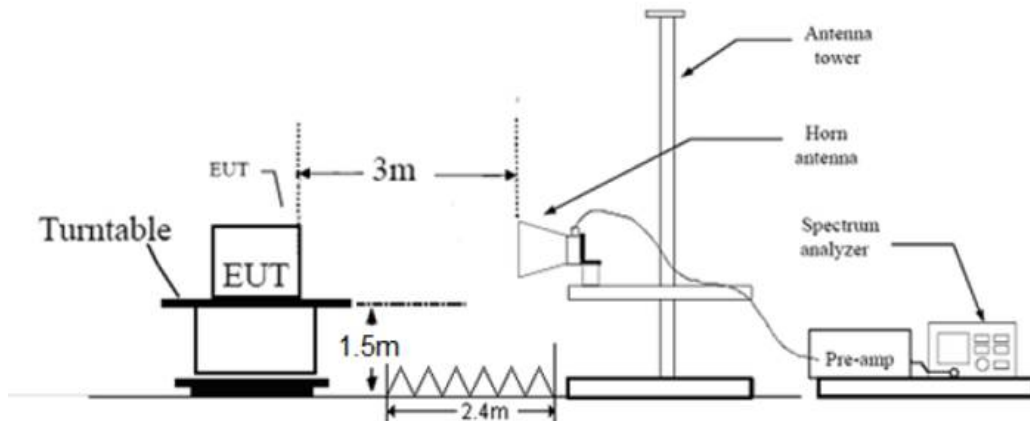

7.3 AC Power Line Conducted Emission test setups

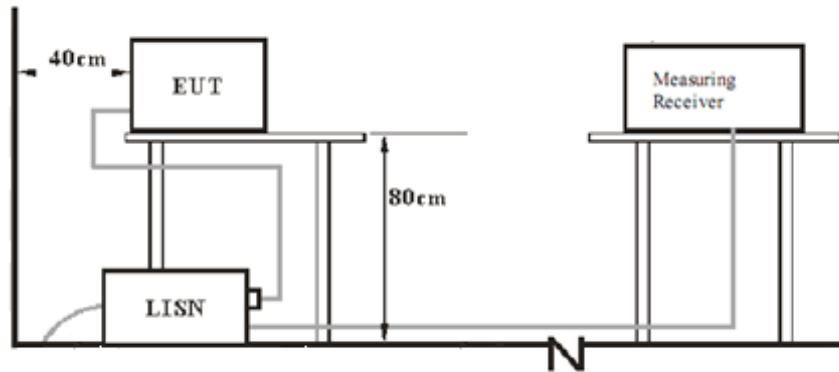

7.4 Conducted RF test setups

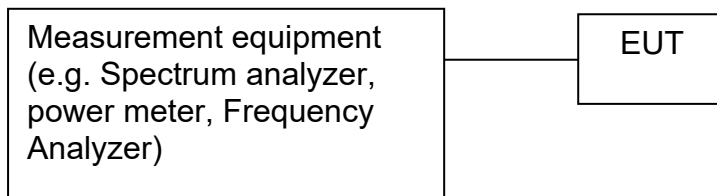

8 Emission Test Results

8.1 Spurious Radiated Emission

EUT: HG07822A-US
 Op Condition: Operated, TX Mode (2DH5)
 (Highest channel is the worst case)
 Test Specification: FCC15.205, 15.209 & 15.247(d)
 Comment: 3.7V DC
 Remark: Below 1GHz

Test Result	
<input checked="" type="checkbox"/>	Passed
<input type="checkbox"/>	Not Passed

Frequency MHz	Result dB μ V/m	Limit dB μ V/m	Margin dB	Detector PK/QP/AV	Ant. Polarity H/V	Corr. (dB)
48.430000	21.74	40.00	18.26	Peak	H	18.30
100.264375	17.49	43.50	26.01	Peak	H	16.23
150.946875	17.80	43.50	25.70	Peak	H	13.05
302.873125	24.37	46.00	21.63	Peak	H	18.71
590.538750	30.24	46.00	15.76	Peak	H	25.38
943.679375	35.45	46.00	10.55	Peak	H	30.46
34.365000	19.57	40.00	20.43	Peak	V	15.52
54.795625	20.24	40.00	19.76	Peak	V	18.00
100.628125	18.15	43.50	25.35	Peak	V	16.20
270.560000	22.01	46.00	23.99	Peak	V	18.08
589.568750	30.83	46.00	15.17	Peak	V	25.36
945.316250	36.05	46.00	9.95	Peak	V	30.47

Remark:

- As the measured peak value not exceeded the Quasi-peak limit, Quasi-peak value no need to be measured.
- Result Level=Reading Level + Correction Factor
 Above 1GHz: Corrector factor = Antenna Factor + Cable Loss- Amplifier Gain
 Below 1GHz: Corrector factor = Antenna Factor + Cable Loss
 (The Reading Level is recorded by software which is not shown in the sheet)

Spurious Radiated Emission

EUT: HG07822A-US
 Op Condition: Operated, TX Mode (2402MHz, DH5)
 Test Specification: FCC15.205, 15.209 & 15.247(d)
 Comment: 3.7V DC
 Remark: 1GHz to 25GHz

Test Result	
<input checked="" type="checkbox"/>	Passed
<input type="checkbox"/>	Not Passed

Frequency MHz	Result dBµV/m	Limit dBµV/m	Margin dB	Detector PK/QP/AV	Ant. Polarity H/V	Corr. (dB)
1049.047619	39.29	74.00	34.71	Peak	H	-12.78
2394.285714	50.53	74.00	23.47	Peak	H	-5.01
4803.500000	52.50	74.00	21.50	Peak	H	2.37
4803.500000	49.15	54.00	4.85	AV	H	2.37
7205.500000	49.73	74.00	24.27	Peak	H	7.00
2294.761905	50.11	74.00	23.89	Peak	V	-5.37
3188.500000	45.98	74.00	28.02	Peak	V	-2.67
4804.000000	48.14	74.00	25.86	Peak	V	2.37
7207.000000	48.39	74.00	25.61	Peak	V	7.00

Remark:

1. According to C63.10, if the peak (or quasi-peak) measured value complies with the average limit, it is unnecessary to perform an average measurement, so AV emission value did not show in data table if the peak value complies with average limit.
2. Consequence Level=Reading Level + Correction Factor
 Above 1GHz: Corrector factor = Antenna Factor + Cable Loss- Amplifier Gain
 Below 1GHz: Corrector factor = Antenna Factor + Cable Loss
 (The Reading Level is recorded by software which is not shown in the sheet)

Spurious Radiated Emission

EUT: HG07822A-US
 Op Condition: Operated, TX Mode (2441MHz, DH5)
 Test Specification: FCC15.205, 15.209 & 15.247(d)
 Comment: 3.7V DC
 Remark: 1GHz to 25GHz

Test Result	
<input checked="" type="checkbox"/>	Passed
<input type="checkbox"/>	Not Passed

Frequency MHz	Result dBµV/m	Limit dBµV/m	Margin dB	Detector PK/QP/AV	Ant. Polarity H/V	Corr. (dB)
1045.238095	38.00	74.00	36.00	Peak	H	-12.80
2480.476191	50.94	74.00	23.06	Peak	H	-4.67
4882.000000	56.17	74.00	17.83	Peak	H	2.69
4882.000000	52.12	54.00	1.88	AV	H	2.69
7322.500000	51.23	74.00	22.77	Peak	H	7.25
9920.000000	45.89	74.00	28.11	Peak	H	10.70
1596.666667	50.21	74.00	23.79	Peak	V	-8.85
2356.666667	49.50	74.00	24.50	Peak	V	-5.16
4788.500000	48.68	74.00	25.32	Peak	V	2.38
7323.500000	49.94	74.00	24.06	Peak	V	7.25

Remark:

1. According to C63.10, if the peak (or quasi-peak) measured value complies with the average limit, it is unnecessary to perform an average measurement, so AV emission value did not show in data table if the peak value complies with average limit.
2. Consequence Level=Reading Level + Correction Factor
 Above 1GHz: Corrector factor = Antenna Factor + Cable Loss- Amplifier Gain
 Below 1GHz: Corrector factor = Antenna Factor + Cable Loss
 (The Reading Level is recorded by software which is not shown in the sheet)

Spurious Radiated Emission

EUT: HG07822A-US
 Op Condition: Operated, TX Mode (2480MHz, DH5)
 Test Specification: FCC15.205, 15.209 & 15.247(d)
 Comment: 3.7V DC
 Remark: 1GHz to 25GHz

Test Result	
<input checked="" type="checkbox"/>	Passed
<input type="checkbox"/>	Not Passed

Frequency MHz	Result dBµV/m	Limit dBµV/m	Margin dB	Detector PK/QP/AV	Ant. Polarity H/V	Corr. (dB)
2545.500000	44.48	74.00	29.52	Peak	H	-1.55
3829.500000	46.91	74.00	27.09	Peak	H	1.25
4960.500000	50.40	74.00	23.60	Peak	H	4.09
7440.000000	45.02	74.00	28.98	Peak	H	7.22
11660.000000	44.53	74.00	29.47	Peak	H	10.00
15706.000000	47.31	74.00	26.69	Peak	H	15.45
2293.000000	44.22	74.00	29.78	Peak	V	-2.36
3301.000000	46.00	74.00	28.00	Peak	V	0.44
4960.500000	53.10	74.00	20.90	Peak	V	4.09
5862.500000	51.53	74.00	22.47	Peak	V	6.78
7440.000000	47.54	74.00	26.46	Peak	V	7.22
16135.500000	48.02	74.00	25.98	Peak	V	16.55

Remark:

1. According to C63.10, if the peak (or quasi-peak) measured value complies with the average limit, it is unnecessary to perform an average measurement, so AV emission value did not show in data table if the peak value complies with average limit.
2. Consequence Level=Reading Level + Correction Factor
 Above 1GHz: Corrector factor = Antenna Factor + Cable Loss- Amplifier Gain
 Below 1GHz: Corrector factor = Antenna Factor + Cable Loss
 (The Reading Level is recorded by software which is not shown in the sheet)

8.2 Conducted Emission at AC Power line

EUT: HG07822A-US
 Op Condition: BT Link and USB charging
 Test Specification: AC Mains, L Line
 Comment: 120V AC, 60Hz (supporting adapter input)

Test Result	
<input checked="" type="checkbox"/>	Passed
<input type="checkbox"/>	Not Passed

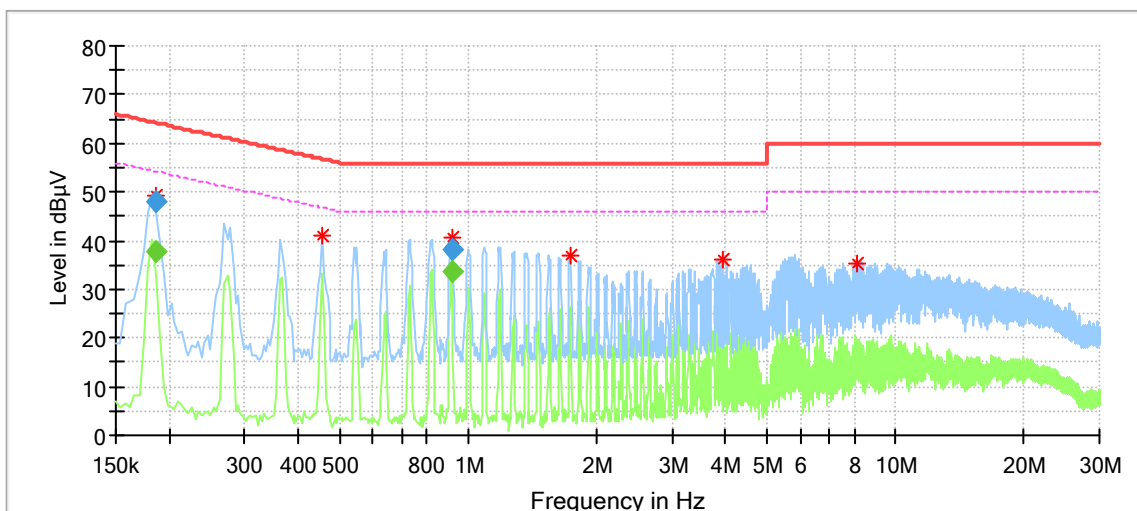

Frequency (MHz)	MaxPeak (dBµV)	Average (dBµV)	Limit (dBµV)	Margin (dB)	Corr. (dB)
0.185500	49.31	---	64.39	15.09	9.64
0.458000	41.17	---	56.73	15.56	9.64
0.918500	40.74	---	56.00	15.26	9.66
1.738000	36.90	---	56.00	19.10	9.68
3.938000	36.13	---	56.00	19.87	9.74
8.134000	35.14	---	60.00	24.86	9.85

Frequency (MHz)	QuasiPeak (dBµV)	Average (dBµV)	Limit (dBµV)	Margin (dB)	Corr. (dB)
0.185500	---	37.72	54.24	16.51	9.64
0.185500	47.86	---	64.24	16.37	9.64
0.918500	---	33.53	46.00	12.47	9.66
0.918500	38.35	---	56.00	17.65	9.66

Conducted Emission Test

EUT: HG07822A-US
 Op Condition: BT Link and USB charging
 Test Specification: AC Mains, N Line
 Comment: 120V AC, 60Hz (supporting adapter input)

Test Result	
<input checked="" type="checkbox"/>	Passed
<input type="checkbox"/>	Not Passed

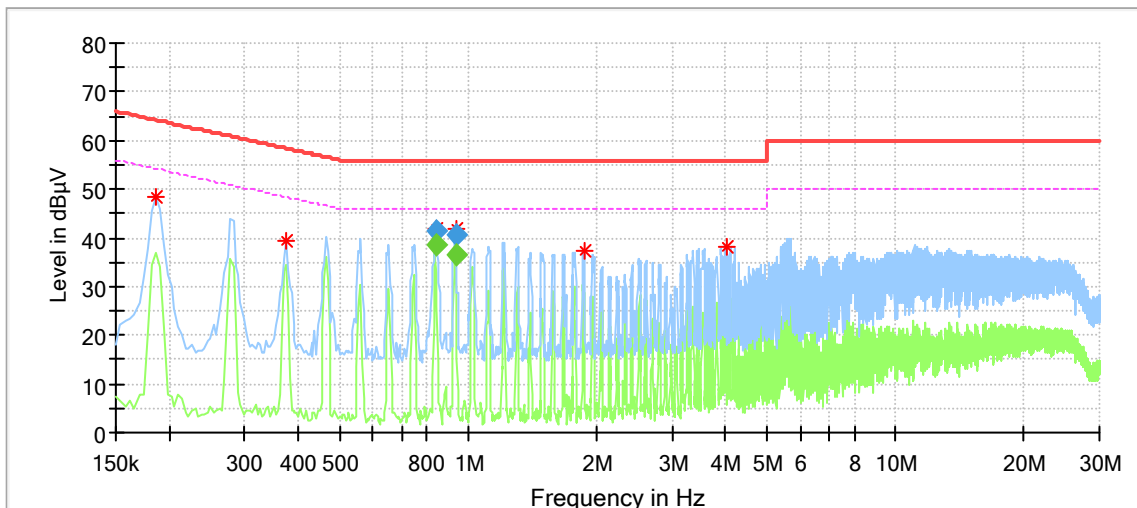

Frequency (MHz)	MaxPeak (dBµV)	Average (dBµV)	Limit (dBµV)	Margin (dB)	Corr. (dB)
0.186000	48.34	---	64.21	15.88	9.62
0.374000	39.50	---	58.41	18.91	9.63
0.841500	41.81	---	56.00	14.19	9.65
0.938500	41.93	---	56.00	14.07	9.65
1.870000	37.43	---	56.00	18.57	9.67
4.010000	38.27	---	56.00	17.73	9.73

Frequency (MHz)	QuasiPeak (dBµV)	Average (dBµV)	Limit (dBµV)	Margin (dB)	Corr. (dB)
0.841500	---	38.68	46.00	7.32	9.65
0.841500	41.43	---	56.00	14.57	9.65
0.938500	---	36.50	46.00	9.50	9.65
0.938500	40.76	---	56.00	15.24	9.65

8.3 20dB & 99% Bandwidth

EUT: HG07822A-US
 Op Condition: Operated, TX Mode (2402MHz, DH5)
 Test Specification: FCC15.247(a)(1), 20dB Bandwidth & 99% Bandwidth
 Comment: 3.7V DC

Test Result	
<input checked="" type="checkbox"/>	Passed
<input type="checkbox"/>	Not Passed

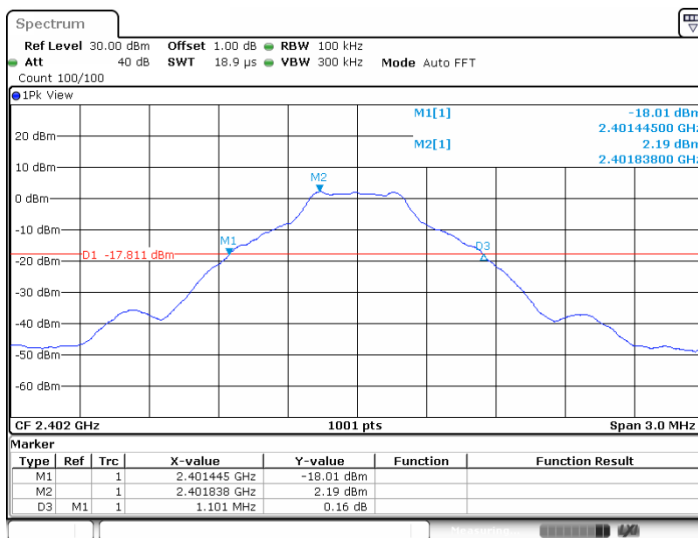

Date: 9 JUN 2021 17:10:04

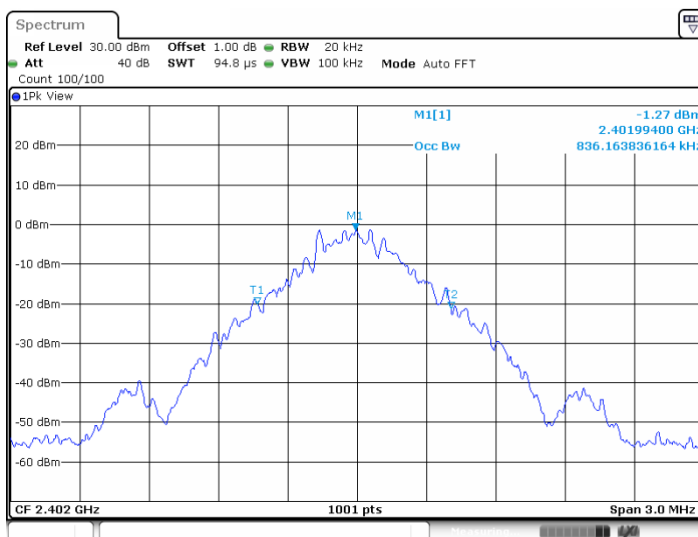

Date: 9 JUN 2021 17:10:15

Bandwidth	Measured Value	Limit
20dB bandwidth	1.101 MHz	NA
99% OCB	0.836 MHz	NA

20dB & 99% Bandwidth

EUT: HG07822A-US
 Op Condition: Operated, TX Mode (2441MHz, DH5)
 Test Specification: FCC15.247(a)(1), 20dB Bandwidth & 99% Bandwidth
 Comment: 3.7V DC

Test Result	
<input checked="" type="checkbox"/>	Passed
<input type="checkbox"/>	Not Passed

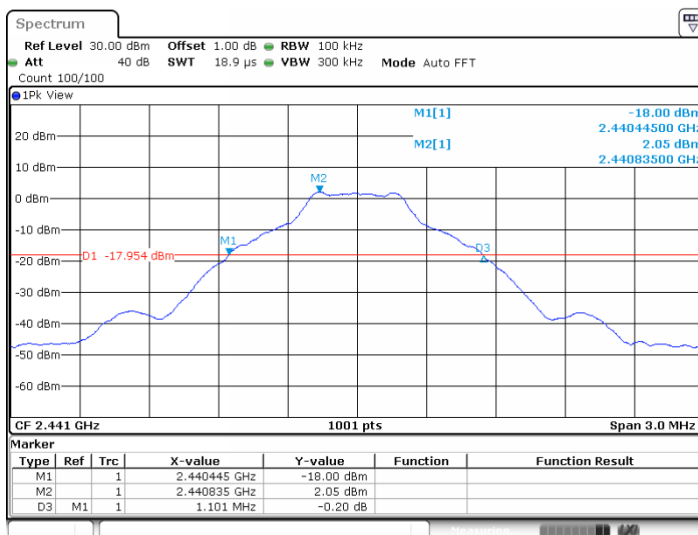

Date: 9 JUN 2021 18:03:53

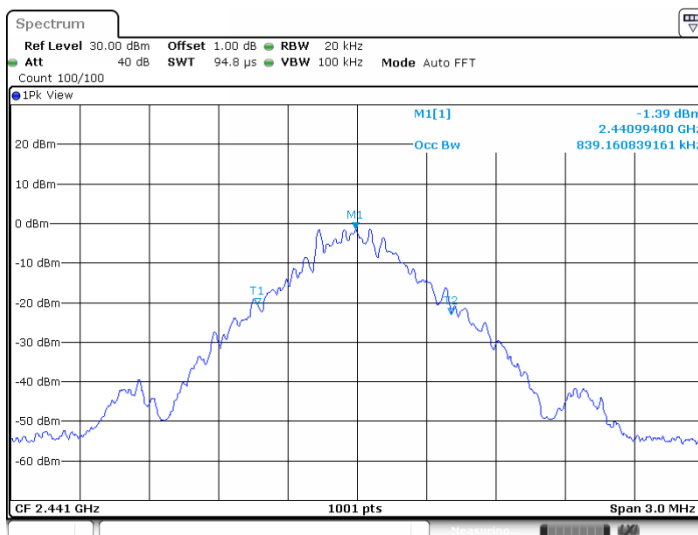

Date: 9 JUN 2021 18:04:04

Bandwidth	Measured Value	Limit
20dB bandwidth	1.101 MHz	NA
99% OCB	0.839 MHz	NA

20dB & 99% Bandwidth

EUT: HG07822A-US
 Op Condition: Operated, TX Mode (2480MHz, DH5)
 Test Specification: FCC15.247(a)(1), 20dB Bandwidth & 99% Bandwidth
 Comment: 3.7V DC

Test Result
 Passed
 Not Passed

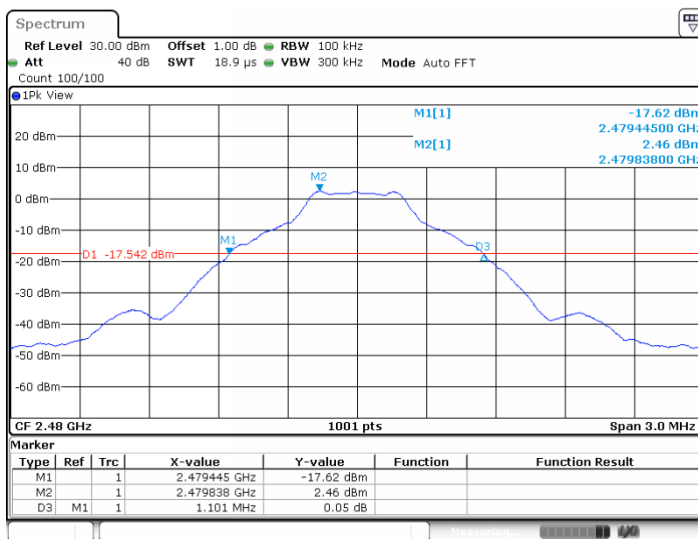

Date: 9 JUN 2021 17:15:00

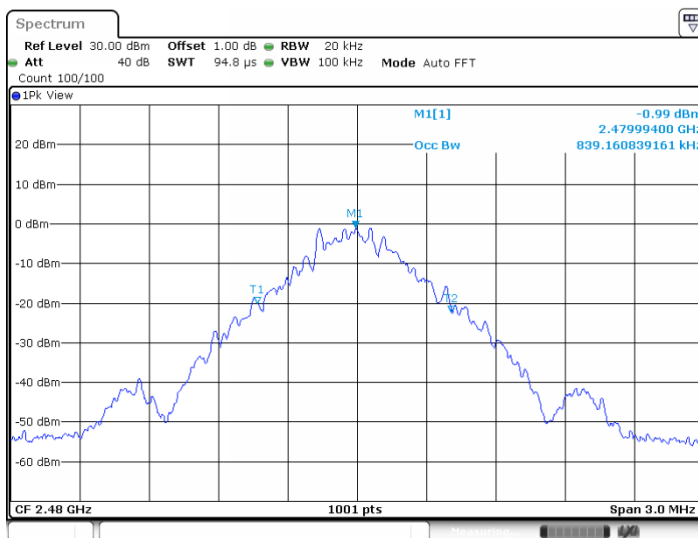

Date: 9 JUN 2021 17:15:11

Bandwidth	Measured Value	Limit
20dB bandwidth	1.101 MHz	NA
99% OCB	0.839 MHz	NA

20dB & 99% Bandwidth

EUT: HG07822A-US
 Op Condition: Operated, TX Mode (2402MHz, 2DH5)
 Test Specification: FCC15.247(a)(1), 20dB Bandwidth & 99% Bandwidth
 Comment: 3.7V DC

Test Result
 Passed
 Not Passed

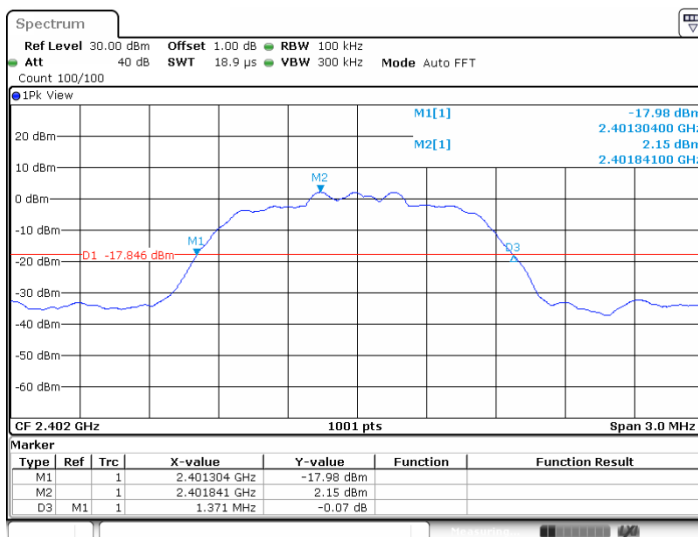

Date: 9 JUN 2021 17:16:34

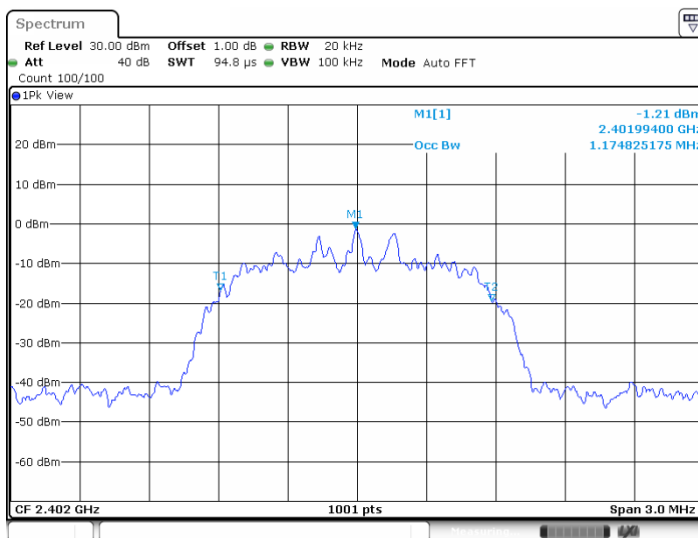

Date: 9 JUN 2021 17:16:45

Bandwidth	Measured Value	Limit
20dB bandwidth	1.371 MHz	NA
99% OCB	1.175 MHz	NA

20dB & 99% Bandwidth

EUT: HG07822A-US
 Op Condition: Operated, TX Mode (2441MHz, 2DH5)
 Test Specification: FCC15.247(a)(1), 20dB Bandwidth & 99% Bandwidth
 Comment: 3.7V DC

Test Result	
<input checked="" type="checkbox"/>	Passed
<input type="checkbox"/>	Not Passed

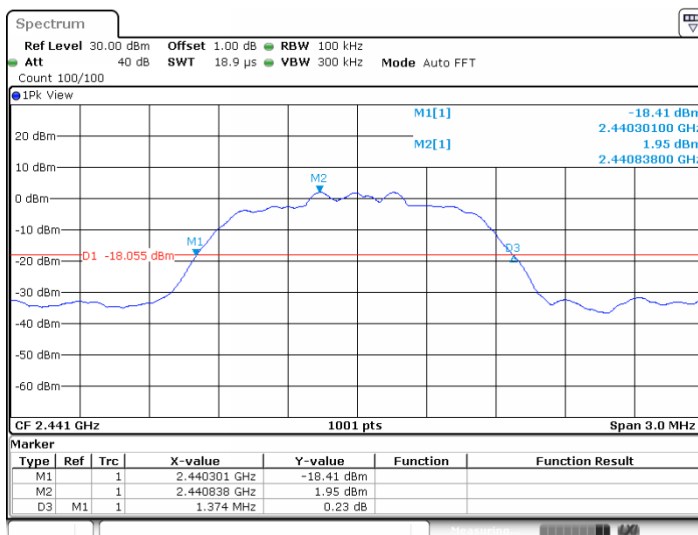

Date: 9 JUN 2021 18:05:39

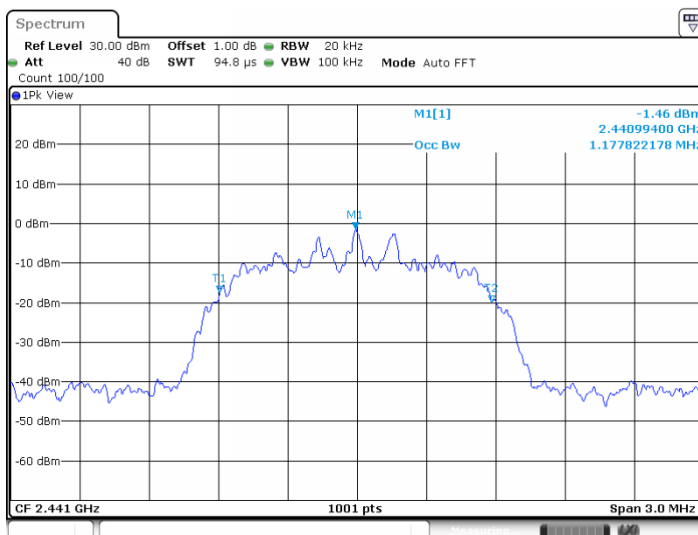

Date: 9 JUN 2021 18:05:50

Bandwidth	Measured Value	Limit
20dB bandwidth	1.374 MHz	NA
99% OCB	1.178 MHz	NA

20dB & 99% Bandwidth

EUT: HG07822A-US
 Op Condition: Operated, TX Mode (2480MHz, 2DH5)
 Test Specification: FCC15.247(a)(1), 20dB Bandwidth & 99% Bandwidth
 Comment: 3.7V DC

Test Result	
<input checked="" type="checkbox"/>	Passed
<input type="checkbox"/>	Not Passed

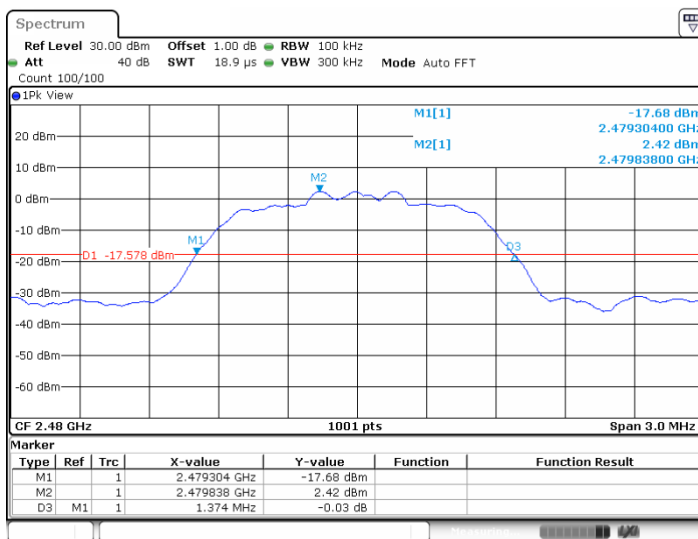

Date: 9 JUN 2021 17:20:29

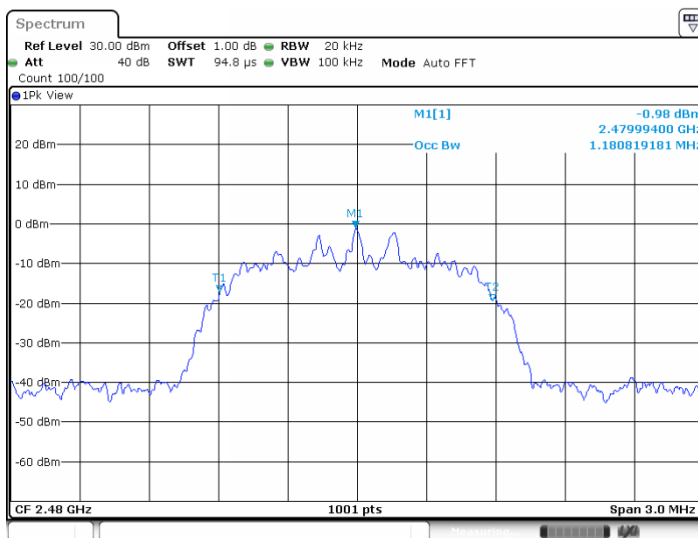

Date: 9 JUN 2021 17:20:40

Bandwidth	Measured Value	Limit
20dB bandwidth	1.374 MHz	NA
99% OCB	1.181 MHz	NA

8.4 Peak Output Power

EUT: HG07822A-US
 Op Condition: Operated, TX Mode (2402MHz, DH5)
 Test Specification: FCC15.247(b)
 Comment: 3.7V DC

Test Result	
<input checked="" type="checkbox"/>	Passed
<input type="checkbox"/>	Not Passed

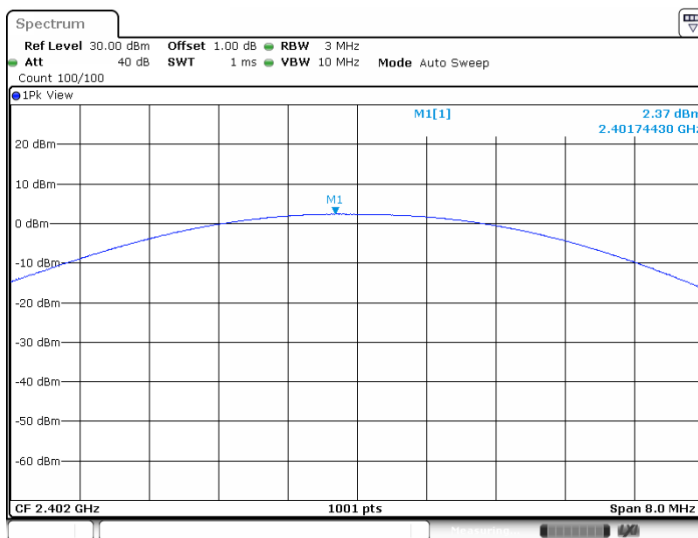

Date: 9 JUN 2021 17:41:56

Conducted Output Power	Limit
2.37 dBm	< 30dBm

Peak Output Power

EUT: HG07822A-US
 Op Condition: Operated, TX Mode (2441MHz, DH5)
 Test Specification: FCC15.247(b)
 Comment: 3.7V DC

Test Result	
<input checked="" type="checkbox"/>	Passed
<input type="checkbox"/>	Not Passed

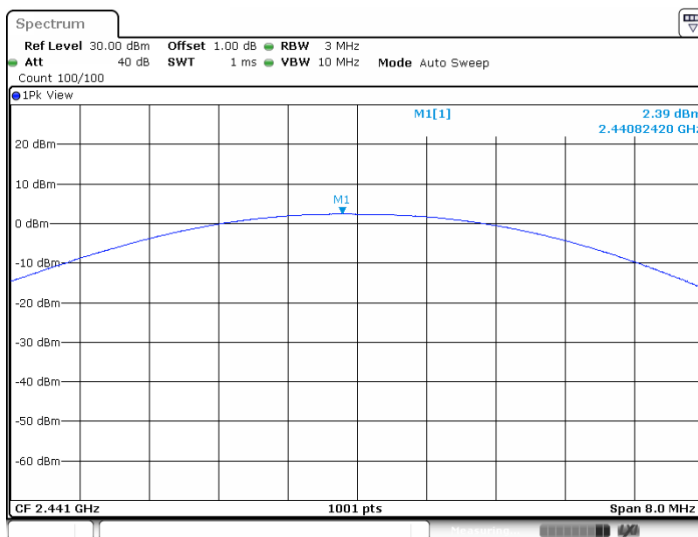

Date: 9 JUN 2021 17:33:20

Conducted Output Power	Limit
2.39 dBm	< 30dBm

Peak Output Power

EUT: HG07822A-US
 Op Condition: Operated, TX Mode (2480MHz, DH5)
 Test Specification: FCC15.247(b)
 Comment: 3.7V DC

Test Result	
<input checked="" type="checkbox"/>	Passed
<input type="checkbox"/>	Not Passed

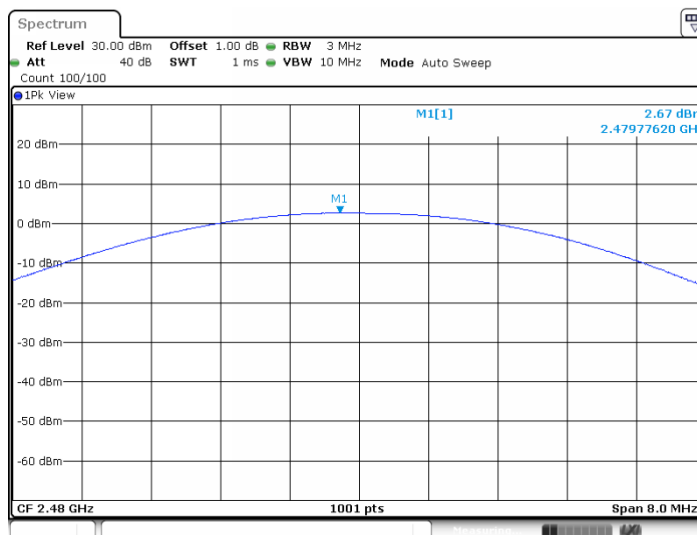

Date: 9 JUN 2021 17:31:47

Conducted Output Power	Limit
2.67 dBm	< 30dBm

Peak Output Power

EUT: HG07822A-US
 Op Condition: Operated, TX Mode (2402MHz, 2DH5)
 Test Specification: FCC15.247(b)
 Comment: 3.7V DC

Test Result	
<input checked="" type="checkbox"/>	Passed
<input type="checkbox"/>	Not Passed

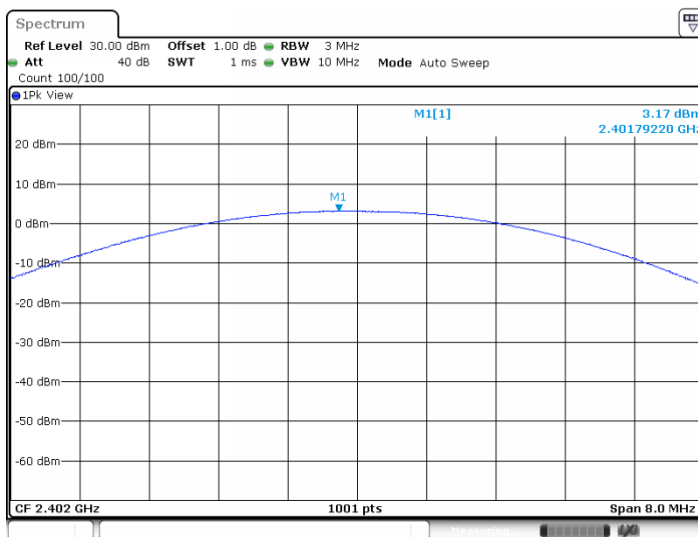

Date: 9 JUN 2021 17:32:07

Conducted Output Power	Limit
3.17 dBm	< 30dBm

Peak Output Power

EUT: HG07822A-US
 Op Condition: Operated, TX Mode (2441MHz, 2DH5)
 Test Specification: FCC15.247(b)
 Comment: 3.7V DC

Test Result	
<input checked="" type="checkbox"/>	Passed
<input type="checkbox"/>	Not Passed

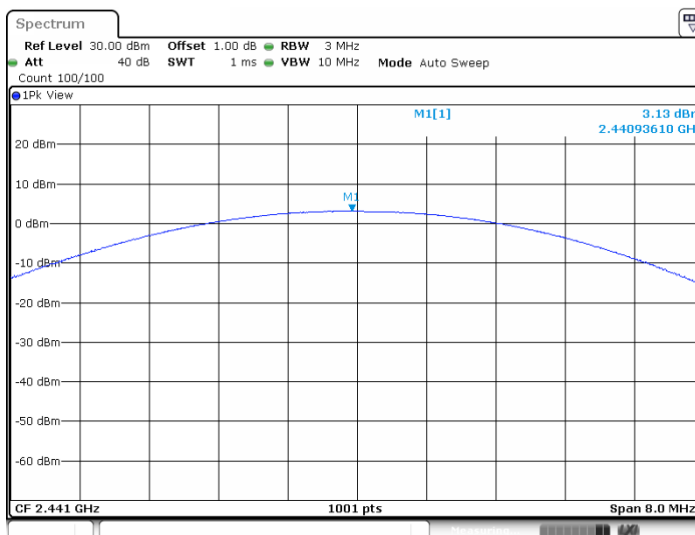

Date: 9 JUN 2021 17:32:26

Conducted Output Power	Limit
3.13 dBm	< 30dBm

Peak Output Power

EUT: HG07822A-US
 Op Condition: Operated, TX Mode (2480MHz, 2DH5)
 Test Specification: FCC15.247(b)
 Comment: 3.7V DC

Test Result	
<input checked="" type="checkbox"/>	Passed
<input type="checkbox"/>	Not Passed

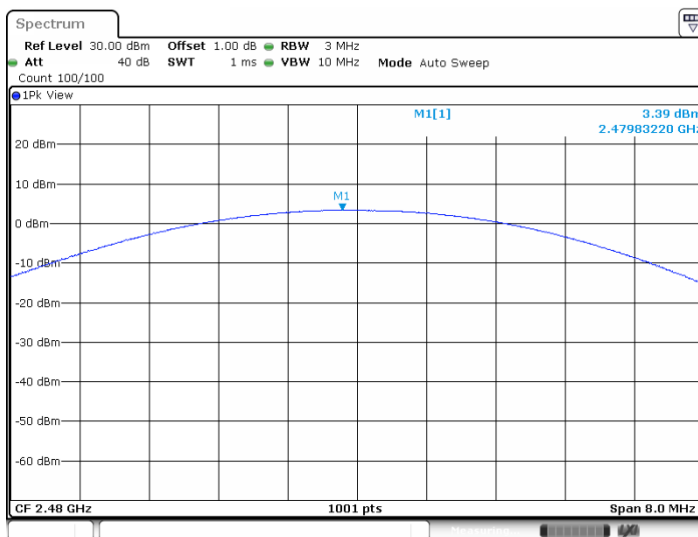

Date: 9 JUN 2021 17:32:48

Conducted Output Power	Limit
3.39 dBm	< 30dBm

8.5 Spurious Emissions at Antenna Terminals

EUT: HG07822A-US
 Op Condition: Operated, TX Mode (2402MHz, DH5)
 Test Specification: FCC2.1051 & 15.247(d)
 Comment: 3.7V DC

Test Result
<input checked="" type="checkbox"/> Passed
<input type="checkbox"/> Not Passed

Channel	FreqRange MHz	RefLevel dBm	Result dBm	Limit dBm	Verdict
2402	2402	2.30	2.30	---	PASS
2402	30~1000	2.30	-66.67	<=-17.7	PASS
2402	1000~26500	2.30	-29.33	<=-17.7	PASS

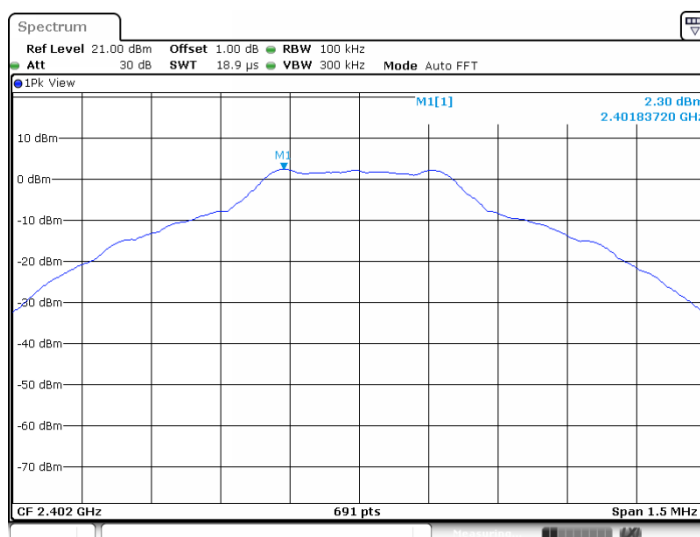

Date: 9 JUN 2021 17:10:30

Spurious Emissions at Antenna Terminals

EUT: HG07822A-US
 Op Condition: Operated, TX Mode (2402MHz, DH5)
 Test Specification: FCC2.1051 & 15.247(d)
 Comment: 3.7V DC

Test Result	
<input checked="" type="checkbox"/>	Passed
<input type="checkbox"/>	Not Passed

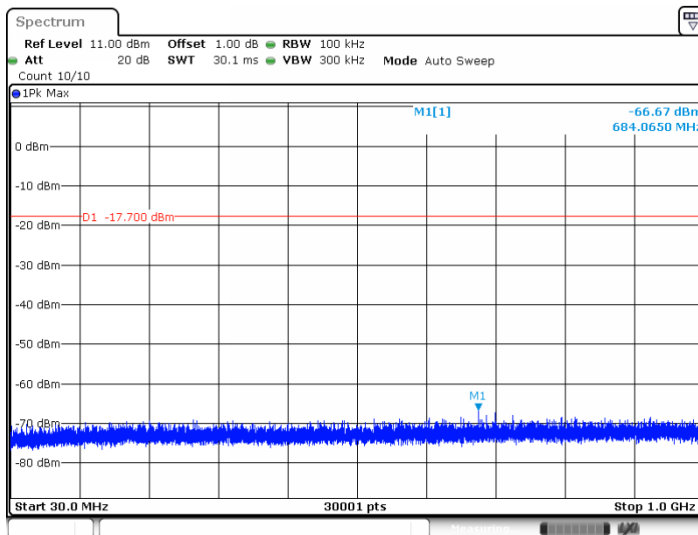

Date: 9 JUN 2021 17:10:36

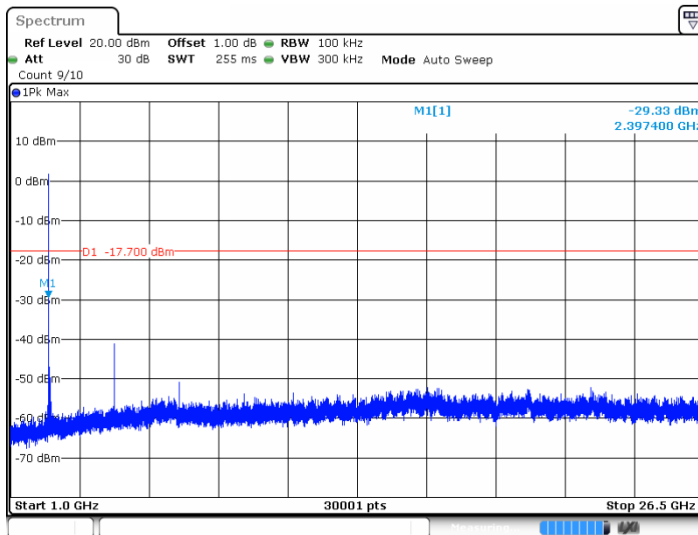

Date: 9 JUN 2021 17:10:44

Spurious Emissions at Antenna Terminals

EUT: HG07822A-US
 Op Condition: Operated, TX Mode (2441MHz, DH5)
 Test Specification: FCC2.1051 & 15.247(d)
 Comment: 3.7V DC

Test Result	
<input checked="" type="checkbox"/>	Passed
<input type="checkbox"/>	Not Passed

Channel	FreqRange MHz	RefLevel dBm	Result dBm	Limit dBm	Verdict
2440	2440	-5.15	-5.15	---	PASS
2440	30~1000	-5.15	-66.54	<=-25.15	PASS
2440	1000~26500	-5.15	-38.64	<=-25.15	PASS

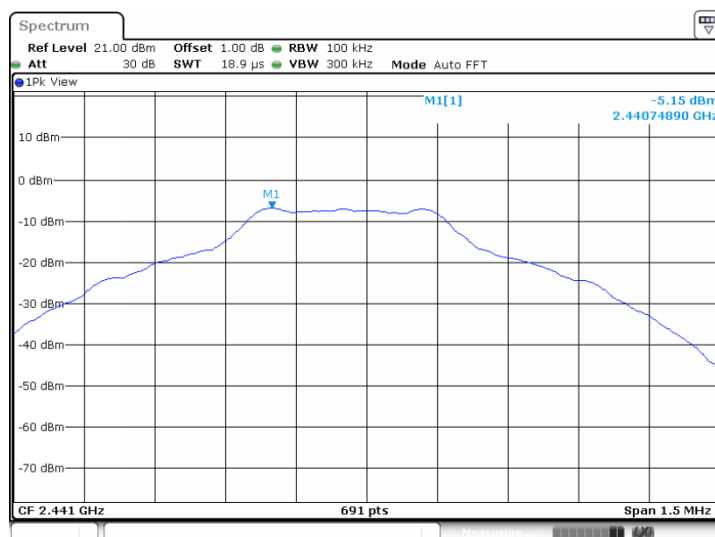

Date: 9 JUN 2021 17:13:11

Spurious Emissions at Antenna Terminals

EUT: HG07822A-US
 Op Condition: Operated, TX Mode (2441MHz, DH5)
 Test Specification: FCC2.1051 & 15.247(d)
 Comment: 3.7V DC

Test Result	
<input checked="" type="checkbox"/>	Passed
<input type="checkbox"/>	Not Passed

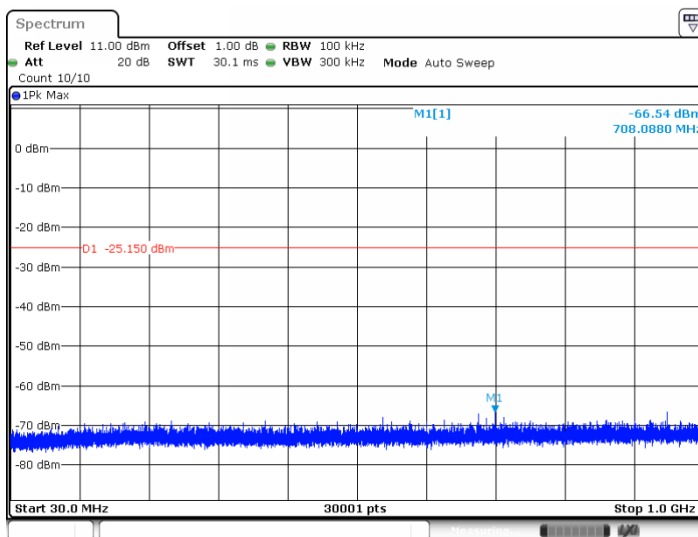

Date: 9 JUN 2021 17:13:17

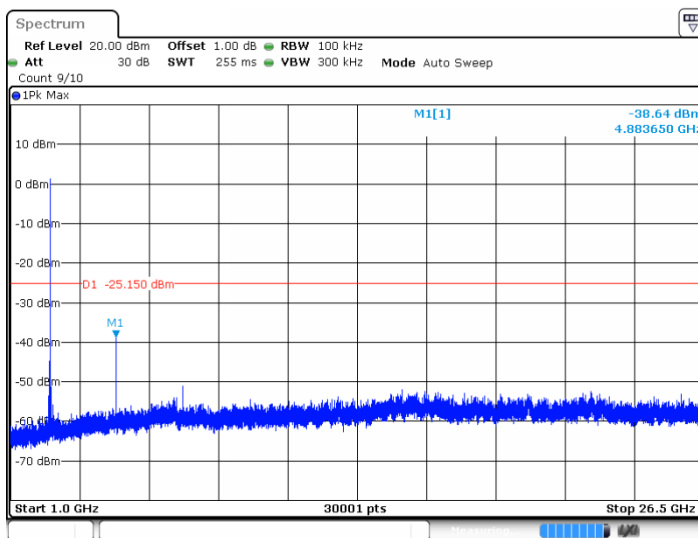

Date: 9 JUN 2021 17:13:25

Spurious Emissions at Antenna Terminals

EUT: HG07822A-US
 Op Condition: Operated, TX Mode (2480MHz, DH5)
 Test Specification: FCC2.1051 & 15.247(d)
 Comment: 3.7V DC

Test Result	
<input checked="" type="checkbox"/>	Passed
<input type="checkbox"/>	Not Passed

Channel	FreqRange MHz	RefLevel dBm	Result dBm	Limit dBm	Verdict
2480	2480	2.55	-6.05	---	PASS
2480	30~1000	2.55	-66.23	<=-17.45	PASS
2480	1000~26500	2.55	-43.00	<=-17.45	PASS

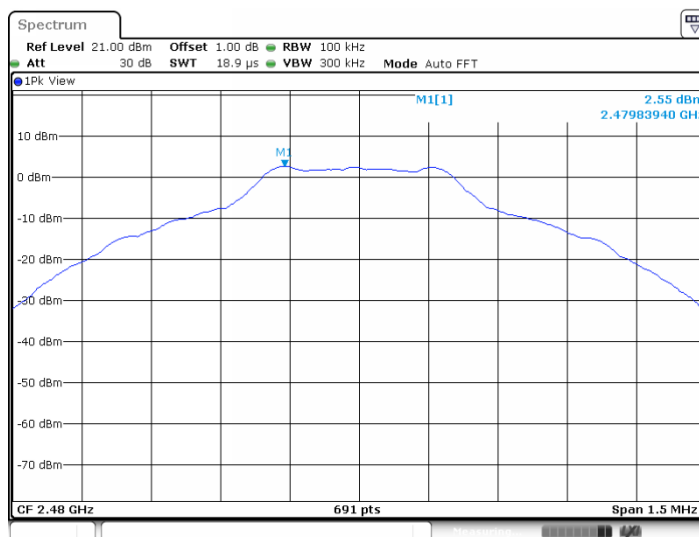

Date: 9 JUN 2021 17:15:26

Spurious Emissions at Antenna Terminals

EUT: HG07822A-US
 Op Condition: Operated, TX Mode (2480MHz, DH5)
 Test Specification: FCC2.1051 & 15.247(d)
 Comment: 3.7V DC

Test Result	
<input checked="" type="checkbox"/>	Passed
<input type="checkbox"/>	Not Passed

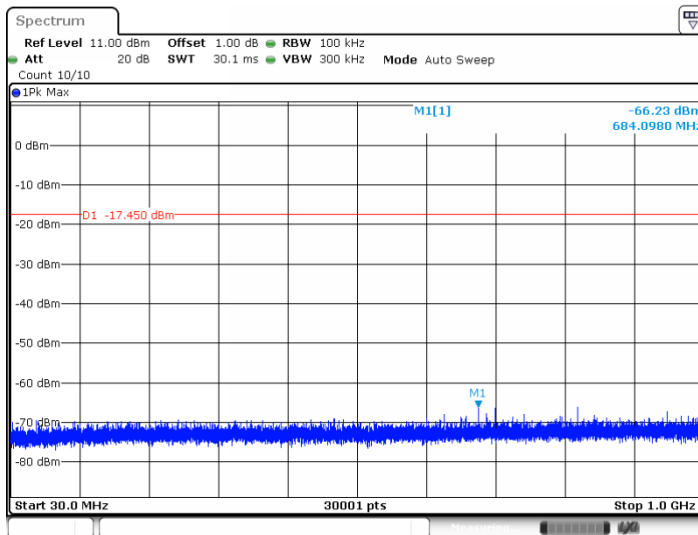

Date: 9 JUN 2021 17:15:32

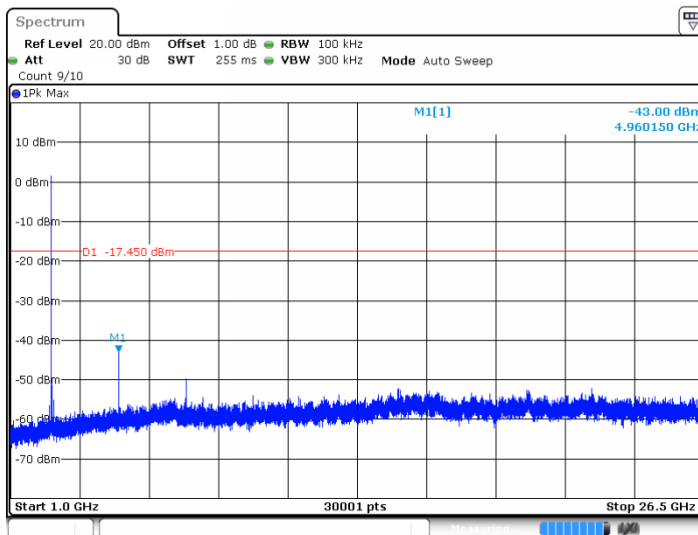

Date: 9 JUN 2021 17:15:39

8.6 100kHz Bandwidth of band edges

EUT: HG07822A-US
 Op Condition: Operated, TX Mode (2402MHz, DH5)
 Test Specification: FCC15.247(d), Conducted
 Comment: 3.7V DC

Test Result	
<input checked="" type="checkbox"/>	Passed
<input type="checkbox"/>	Not Passed

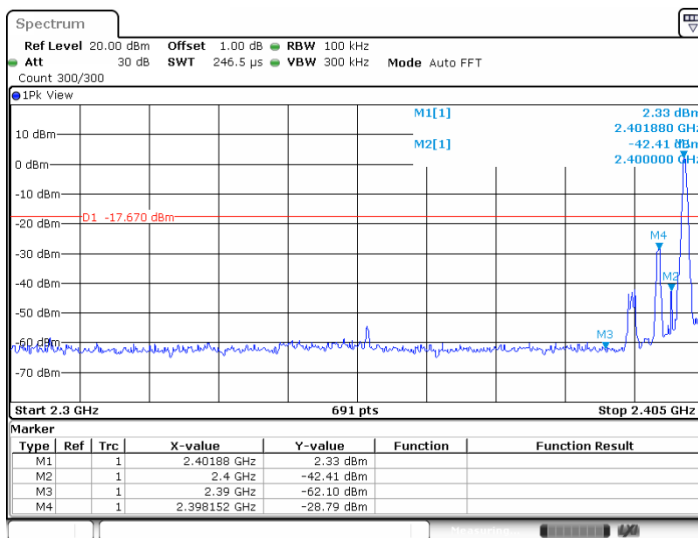

Date: 9 JUN 2021 17:10:24

Band edges	Limit
44.74 dB	> 20dB

100kHz Bandwidth of band edges

EUT: HG07822A-US
 Op Condition: Operated, TX Mode (2480MHz, DH5)
 Test Specification: FCC15.247(d), Conducted
 Comment: 3.7V DC

Test Result	
<input checked="" type="checkbox"/>	Passed
<input type="checkbox"/>	Not Passed

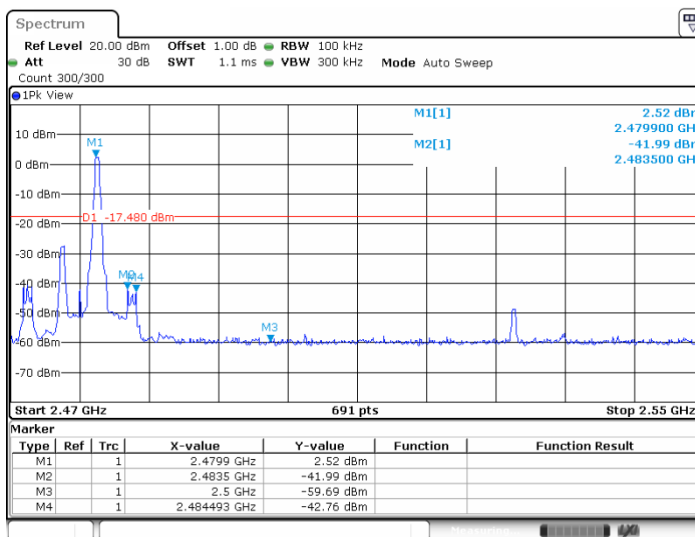

Date: 9 JUN 2021 17:15:20

Band edges	Limit
44.51 dB	> 20dB

100kHz Bandwidth of band edges

EUT: HG07822A-US
 Op Condition: Operated, TX Mode (2402MHz, 2DH5)
 Test Specification: FCC15.247(d), Conducted
 Comment: 3.7V DC

Test Result	
<input checked="" type="checkbox"/>	Passed
<input type="checkbox"/>	Not Passed

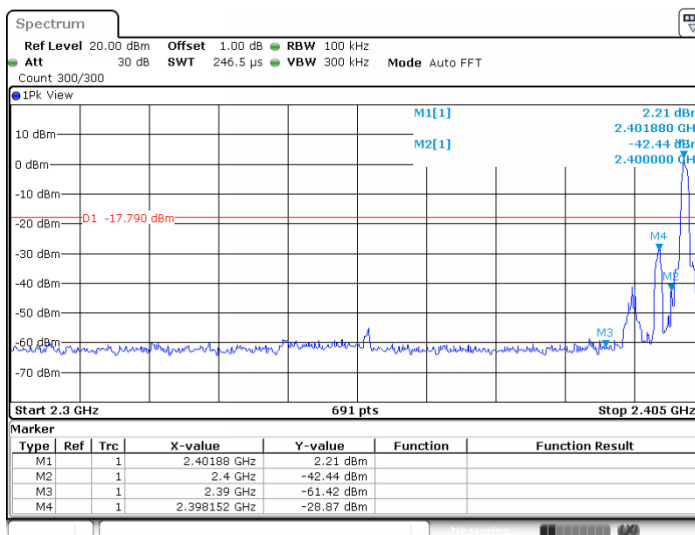

Date: 9 JUN 2021 17:16:54

Band edges	Limit
44.65 dB	> 20dB

100kHz Bandwidth of band edges

EUT: HG07822A-US
 Op Condition: Operated, TX Mode (2480MHz, 2DH5)
 Test Specification: FCC15.247(d), Conducted
 Comment: 3.7V DC

Test Result	
<input checked="" type="checkbox"/>	Passed
<input type="checkbox"/>	Not Passed

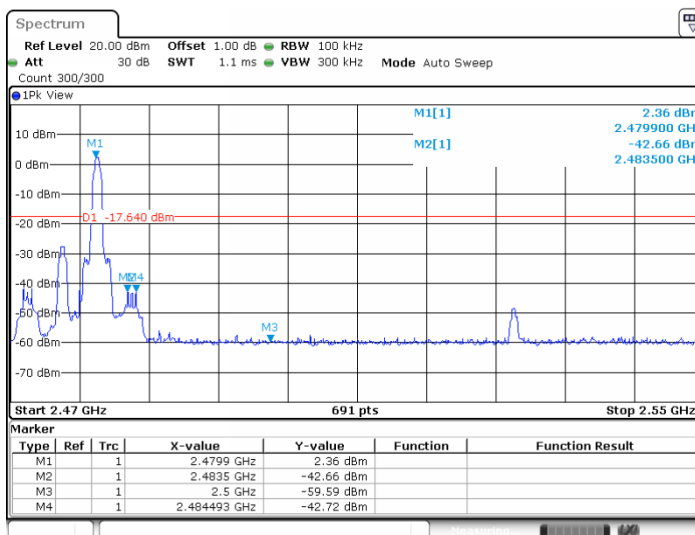

Date: 9 JUN 2021 17:20:49

Band edges	Limit
45.02 dB	> 20dB

8.7 Minimum. Number of Hopping Frequencies

EUT: HG07822A-US
 Op Condition: Operated, TX Mode (2402-2480MHz, DH5)
 Test Specification: FCC15.247(a)(1)
 Comment: 3.7 VDC

Test Result	
<input checked="" type="checkbox"/>	Passed
<input type="checkbox"/>	Not Passed

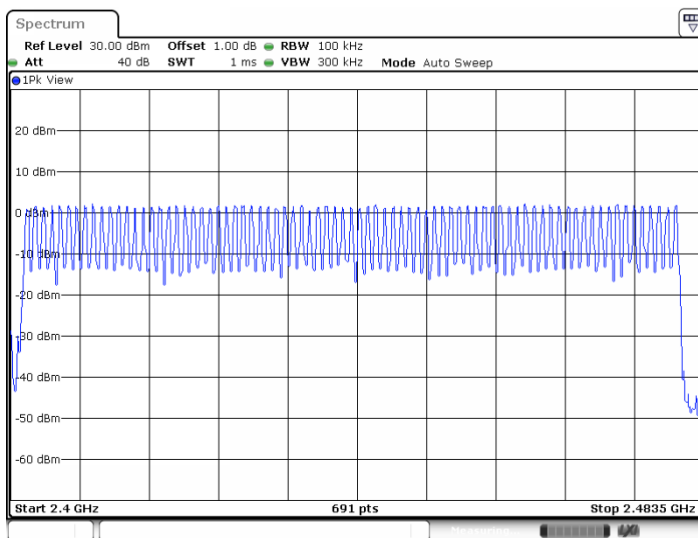

Date: 9 JUN 2021 17:37:04

Hopping Channels	Limit
79	≥ 15

Minimum. Number of Hopping Frequencies

EUT: HG07822A-US
 Op Condition: Operated, TX Mode (2402-2480MHz, 2DH5)
 Test Specification: FCC15.247(a)(1)
 Comment: 3.7 VDC

Test Result	
<input checked="" type="checkbox"/>	Passed
<input type="checkbox"/>	Not Passed

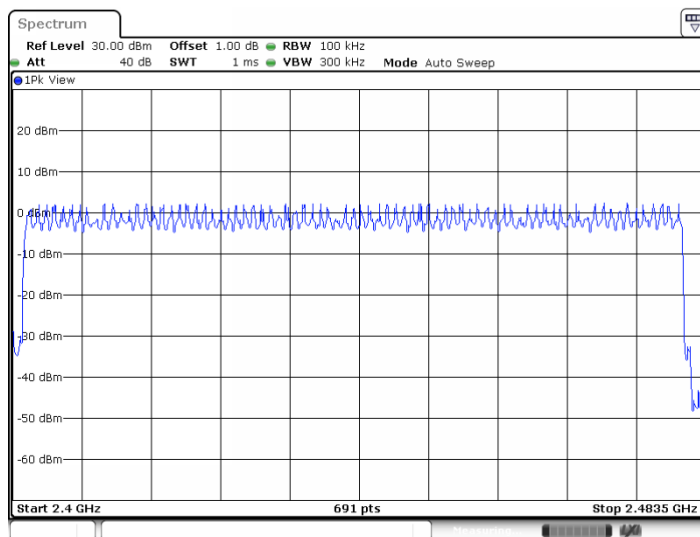

Date: 9 JUN 2021 17:29:07

Hopping Channels	Limit
79	≥ 15

8.8 Minimum Hopping Channel Carrier Frequency Separation

EUT: HG07822A-US
 Op Condition: Operated, TX Mode (2441MHz, DH5)
 Test Specification: FCC15.247(a)(1)
 Comment: 3.7 VDC

Test Result
<input checked="" type="checkbox"/> Passed
<input type="checkbox"/> Not Passed

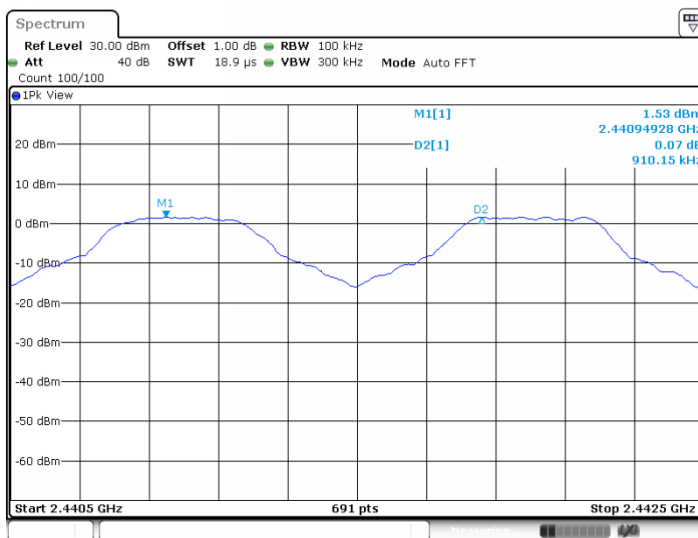

Date: 9 JUN 2021 17:36:57

Chanel Separation	Limit
910 kHz	734 kHz

Limit: 2/3 of 20dB bandwidth of hopping channel

8.9 Average Channel Occupancy Time

EUT: HG07822A-US
 Op Condition: Operated, TX Mode (2441MHz, DH1)
 Test Specification: FCC15.247(a)(1)
 Comment: 3.7 VDC

Test Result	
<input checked="" type="checkbox"/>	Passed
<input type="checkbox"/>	Not Passed

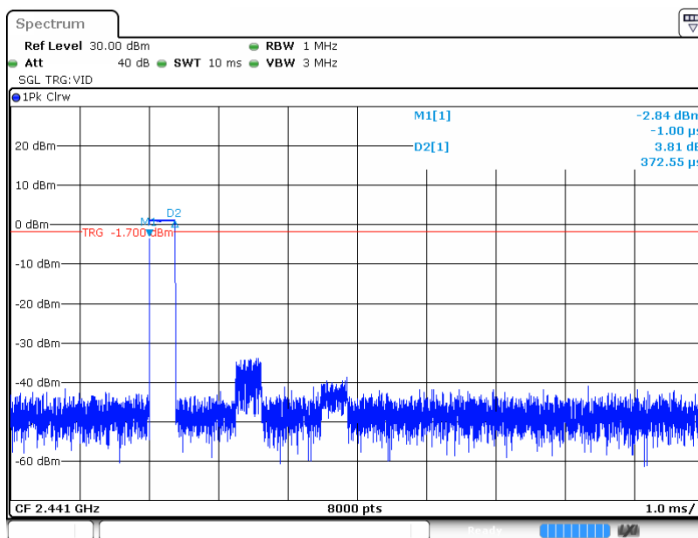

Date: 9 JUN 2021 17:37:47

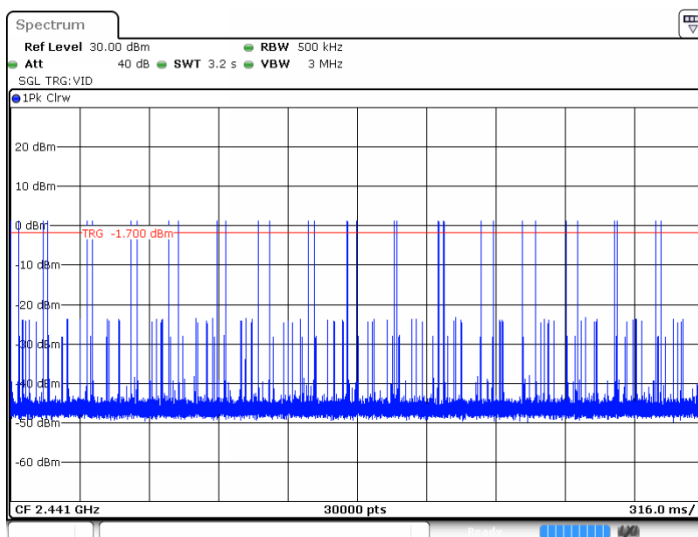

Date: 9 JUN 2021 17:37:52

TestMode	BurstWidth	TotalHops	Result	Limit	Verdict
DH1	0.37	320	0.119	<=0.4	PASS

Average Channel Occupancy Time

EUT: HG07822A-US
 Op Condition: Operated, TX Mode (2441MHz, DH3)
 Test Specification: FCC15.247(a)(1)
 Comment: 3.7 VDC

Test Result	
<input checked="" type="checkbox"/>	Passed
<input type="checkbox"/>	Not Passed

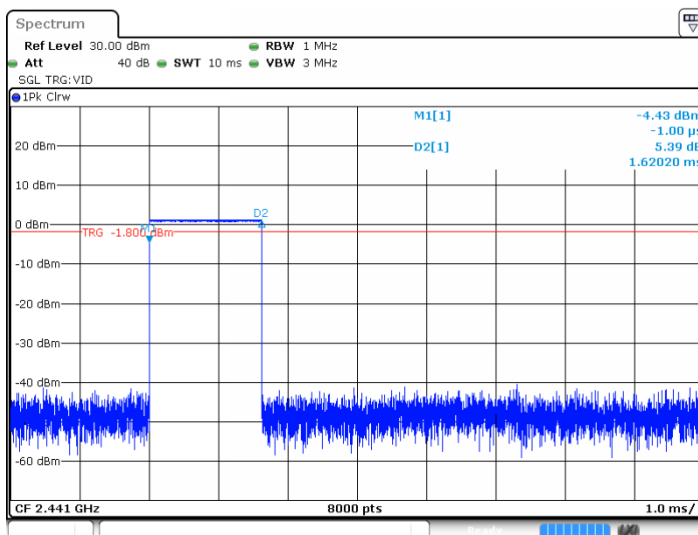

Date: 9 JUN 2021 17:26:18

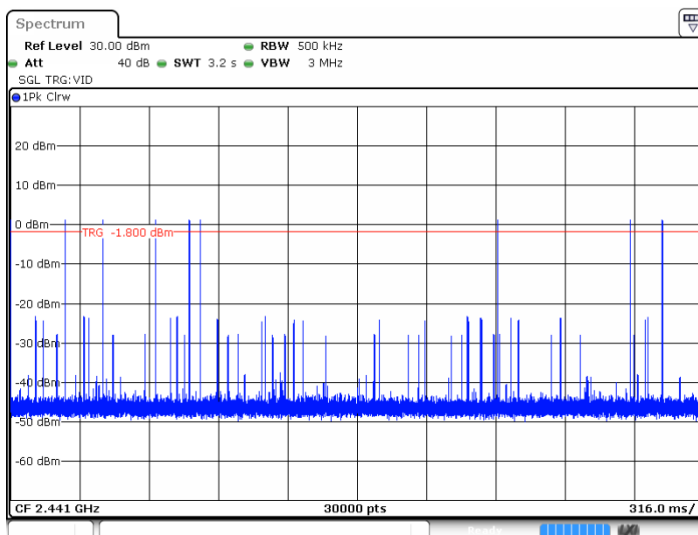

Date: 9 JUN 2021 17:26:23

TestMode	BurstWidth	TotalHops	Result	Limit	Verdict
DH3	1.62	90	0.146	<=0.4	PASS

Average Channel Occupancy Time

EUT: HG07822A-US
 Op Condition: Operated, TX Mode (2441MHz, DH5)
 Test Specification: FCC15.247(a)(1)
 Comment: 3.7 VDC

Test Result	
<input checked="" type="checkbox"/>	Passed
<input type="checkbox"/>	Not Passed

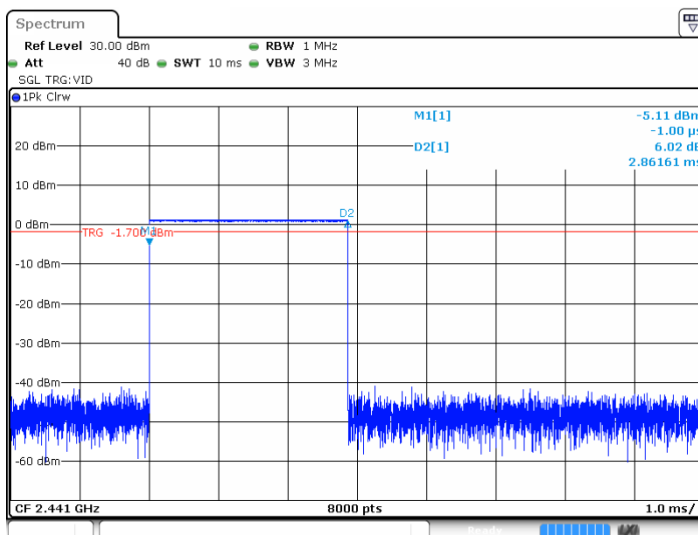

Date: 9 JUN 2021 17:37:16

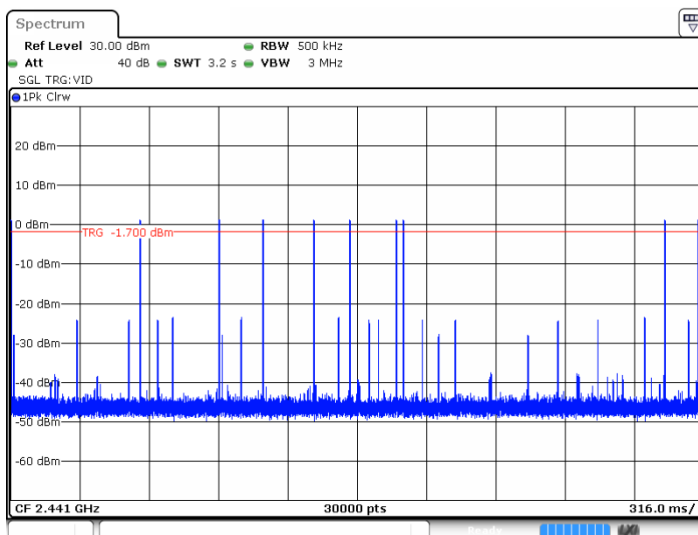

Date: 9 JUN 2021 17:37:21

TestMode	BurstWidth	TotalHops	Result	Limit	Verdict
DH5	2.86	100	0.286	≤ 0.4	PASS

Average Channel Occupancy Time

EUT: HG07822A-US
 Op Condition: Operated, TX Mode (2441MHz, 2DH1)
 Test Specification: FCC15.247(a)(1)
 Comment: 3.7 VDC

Test Result	
<input checked="" type="checkbox"/>	Passed
<input type="checkbox"/>	Not Passed

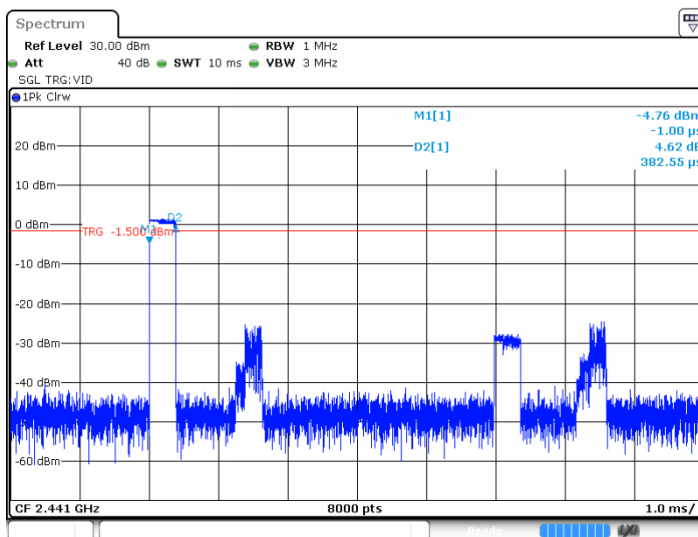

Date: 9 JUN 2021 17:29:47

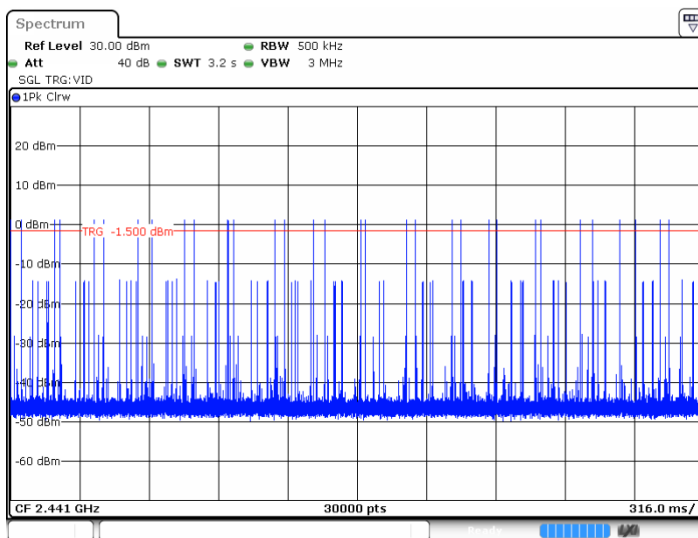

Date: 9 JUN 2021 17:29:52

TestMode	BurstWidth	TotalHops	Result	Limit	Verdict
2DH1	0.38	320	0.122	<=0.4	PASS

Average Channel Occupancy Time

EUT: HG07822A-US
 Op Condition: Operated, TX Mode (2441MHz, 2DH3)
 Test Specification: FCC15.247(a)(1)
 Comment: 3.7 VDC

Test Result	
<input checked="" type="checkbox"/>	Passed
<input type="checkbox"/>	Not Passed

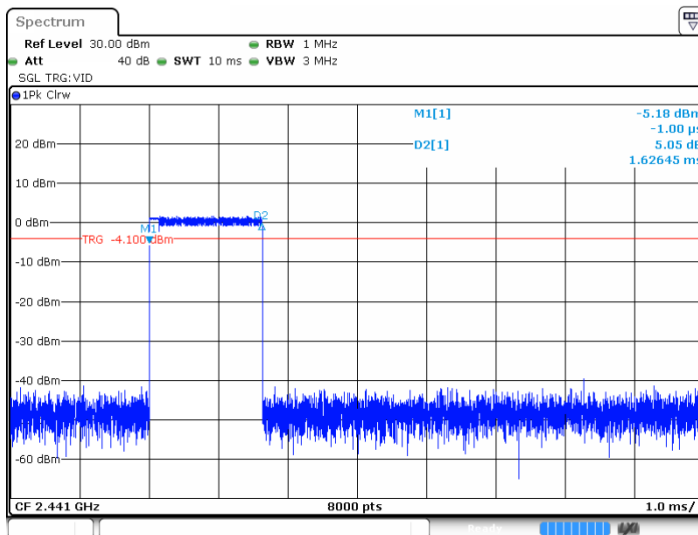

Date: 9 JUN 2021 17:30:14

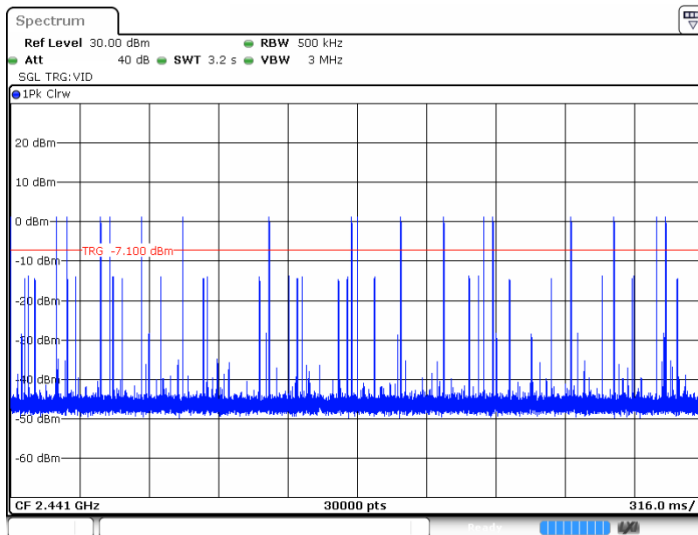

Date: 9 JUN 2021 17:30:20

TestMode	BurstWidth	TotalHops	Result	Limit	Verdict
2DH3	1.63	190	0.309	≤ 0.4	PASS

Average Channel Occupancy Time

EUT: HG07822A-US
 Op Condition: Operated, TX Mode (2441MHz, 2DH5)
 Test Specification: FCC15.247(a)(1)
 Comment: 3.7 VDC

Test Result	
<input checked="" type="checkbox"/>	Passed
<input type="checkbox"/>	Not Passed

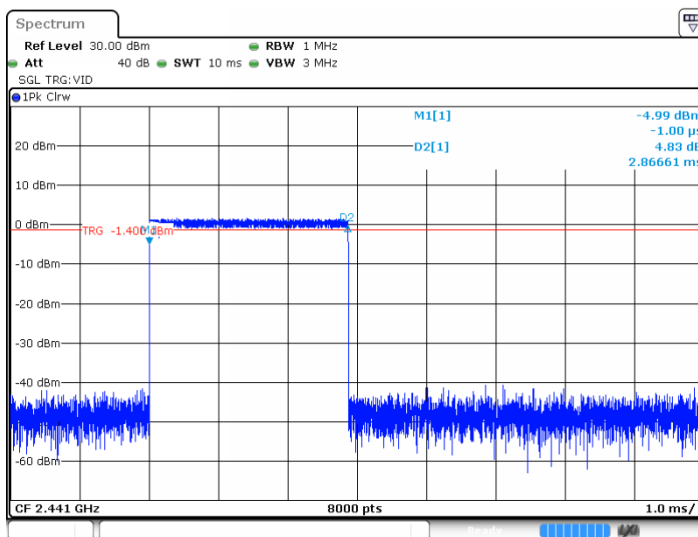

Date: 9 JUN 2021 17:29:20

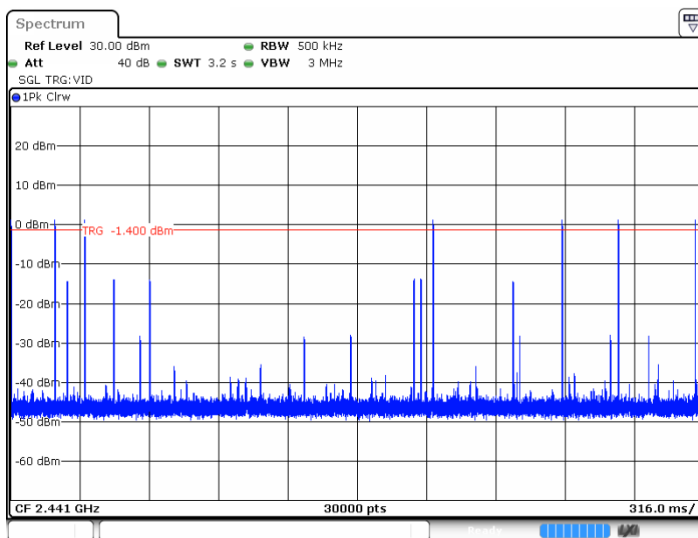

Date: 9 JUN 2021 17:29:25

TestMode	BurstWidth	TotalHops	Result	Limit	Verdict
2DH5	2.87	70	0.201	<=0.4	PASS

8.10 Antenna Requirement

EUT: HG07822A-US
Op Condition: Operated, TX Mode
Test Specification: FCC15.203 & 15.247(b)
Comment: 3.7V DC

Test Result	
<input checked="" type="checkbox"/>	Passed
<input type="checkbox"/>	Not Passed

Limit

For intentional device, according to FCC Title 47 Part 15.203, an intentional radiator shall be designed to ensure that no antenna other than that furnished by the responsible party shall be used with the device. And according to FCC Title 47 Part 15.247(b), if transmitting antennas of directional gain greater than 6 dBi are used, the power shall be reduced by the amount in dB that the directional gain of the antenna exceeds 6 dBi.

Antenna Connector Construction

The antenna used in this product is an integrated antenna on PCB, and the maximum gain of this antenna is -0.58dBi.

9 Test setup procedure

9.1 Spurious Radiated Emission

Test Method

- 1: The EUT was placed on a turn table which is 1.5m above ground plane for above 1GHz and 0.8m above ground for below 1GHz at 3 meter chamber room for test. The table was rotated 360 degrees to determine the position of the highest radiation.
- 2: The EUT was set 3 meters away from the interference – receiving antenna, which was mounted on the top of a variable – height antenna tower.
- 3: The height of antenna is varied from one meter to four meters above the ground to determine the maximum value of the field strength. Both horizontal and vertical polarizations of the antenna are set to make the measurement.
- 4: For each suspected emission, the EUT was arranged to its worst case and then the antenna was tuned to heights from 1 meter to 4 meters and the rotatable table was turned from 0 degrees to 360 degrees to find the maximum reading.
- 5: Use the following spectrum analyzer settings According to C63.10:

For Below 1GHz

Use the following spectrum analyzer settings:

Span = wide enough to capture the peak level of the in-band emission and all spurious
RBW = 100 KHz to 120KHz, VBW \geq RBW for peak measurement, Sweep = auto,
Detector function = peak, Trace = max hold.

For Peak unwanted emissions Above 1GHz:

Span = wide enough to capture the peak level of the in-band emission and all spurious
RBW = 1MHz, VBW \geq RBW for peak measurement, Sweep = auto,
Detector function = peak, Trace = max hold.

Procedures for average unwanted emissions measurements above 1000 MHz:

Span = wide enough to capture the peak level of the in-band emission and all spurious
RBW = 1MHz, VBW=10Hz, Sweep = auto, Detector function = peak, Trace = max hold.
If the dwell time per channel of the hopping signal is less than 100 ms, then the reading obtained with the 10 Hz VBW may be further adjusted by a “duty cycle correction factor”, derived from $20\log(\text{dwell time}/100 \text{ ms})$, in an effort to demonstrate compliance with the 15.209 limit.

If the emission is pulsed, modify the unit for continuous operation; use the settings shown above, then correct the reading by subtracting the peak-average correction factor, derived from the appropriate duty cycle calculation.

The setting method can refer to DA00-705.

Spurious Radiated Emission

Limit

The radio emission outside the operating frequency band shall be at least 20 dB below that in the 100 kHz bandwidth within the band that contains the highest level of the desired power. Radiated emissions which fall in the restricted bands, as defined in section 15.205, must comply with the radiated emission limits specified in section 15.209.

In any 100 kHz bandwidth outside the frequency band in which the spread spectrum or digitally modulated device is operating, the RF power that is produced shall be at least 20 dB below that in the 100 kHz bandwidth within the band that contains the highest level of the desired power, based on either an RF conducted or a radiated measurement, provided that the transmitter demonstrates compliance with the peak conducted power limits. If the transmitter complies with the conducted power limits based on the use of root-mean-square averaging over a time interval, as permitted under section 5.4(d), the attenuation required shall be 30 dB instead of 20 dB. Attenuation below the general field strength limits specified in RSS-Gen is not required.

Frequency MHz	Field Strength uV/m	Field Strength dB μ V/m	Detector
30-88	100	40	QP
88-216	150	43.5	QP
216-960	200	46	QP
960-1000	500	54	QP
Above 1000	500	54	AV
Above 1000	5000	74	PK

According to C63.10, if the peak (or quasi-peak) measured value complies with the average limit, it is unnecessary to perform an average measurement, so AV emission value did not show in below table if the peak value complies with average limit.

9.2 Conducted Emission at AC Power line

Test Method

1. The EUT was placed on a table, which is 0.8m above ground plane
2. The power line of the EUT is connected to the AC mains through a Artificial Mains Network (A.M.N.).
3. Maximum procedure was performed to ensure EUT compliance
4. A EMI test receiver is used to test the emissions from both sides of AC line

Limit

According to §15.207 & RSS-GEN 8.8, conducted emissions limit as below:

Frequency MHz	QP Limit dB μ V	AV Limit dB μ V
0.150-0.500	66-56*	56-46*
0.500-5	56	46
5-30	60	50

Remark: "*" Decreasing linearly with logarithm of the frequency

9.3 20dB & 99% Bandwidth

Test Method

1. Use the following spectrum analyzer settings:
RBW=100K, VBW \geq 3RBW, Sweep = auto, Detector function = peak, Trace = max hold
2. Use the automatic bandwidth measurement capability of an instrument, may be employed using the X dB bandwidth mode with X set to 20 dB, care shall be taken so that the bandwidth measurement is not influenced by any intermediate power nulls in the fundamental emission that might be \geq 20 dB.
3. Allow the trace to stabilize, record the X dB Bandwidth value.

Limit

Limit [kHz]

NA

9.4 Peak Output Power

Test Method

1. Connect the spectrum analyzer to the EUT
 - a) The EUT is configured to transmit continuously, or to transmit with a constant duty factor.
 - b) At all times the EUT is transmitting at its maximum power control level.
 - c) The integration period of the power meter exceeds the repetition period of the transmitted signal by at least a factor of five.
2. Measure the average power of the transmitter. This measurement is an average over both the on and off periods of the transmitter.
3. Adjust the measurement in dBm by adding $10\log(1/x)$, where x is the duty cycle to the measurement result.

Limits

According to §15.247 (b) (1) & RSS-247 5.4(d), conducted peak output power limit as below:

Frequency Range MHz	Limit W	Limit dBm
2400-2483.5	≤ 1	≤ 30

For e.i r.p:

Frequency Range MHz	Limit W	Limit dBm
2400-2483.5	≤ 4	≤ 30

9.5 Spurious Emissions at Antenna Terminals

Test Method

1. Establish a reference level by using the following procedure:
 - a. Set RBW=100 kHz. VBW \geq 3RBW. Detector =peak, Sweep time = auto couple, Trace mode = max hold.
 - b. Allow trace to fully stabilize, use the peak marker function to determine the maximum PSD level.
2. Use the maximum PSD level to establish the reference level.
 - a. Set the center frequency and span to encompass frequency range to be measured.
 - b. Use the peak marker function to determine the maximum amplitude level. Ensure that the amplitude of all unwanted emissions outside of the authorized frequency band (excluding restricted frequency bands) are attenuated by at least the minimum requirements, report the three highest emissions relative to the limit.
3. Repeat above procedures until other frequencies measured were completed.

Limit

Frequency Range MHz	Limit (dBc)
30-25000	-20

9.6 100kHz Bandwidth of band edges

Test Method

- 1 Use the following spectrum analyzer settings:
Span = wide enough to capture the peak level of the in-band emission and all spurious
RBW = 100 kHz, VBW \geq RBW, Sweep = auto, Detector function = peak, Trace = max hold.
- 2 Allow the trace to stabilize, use the peak and delta measurement to record the result.
- 3 The level displayed must comply with the limit specified in this Section.

Limit

Frequency Range MHz	Limit (dBc)
30-25000	-20

9.7 Number of hopping frequencies

Test Method

The EUT shall have its hopping function enabled. Use the following spectrum analyzer settings:

- a) Span: The frequency band of operation. Depending on the number of channels the device supports, it may be necessary to divide the frequency range of operation across multiple spans, to allow the individual channels to be clearly seen.
- b) RBW: To identify clearly the individual channels, set the RBW to less than 30% of the channel spacing or the 20 dB bandwidth, whichever is smaller.
- c) VBW \geq RBW.
- d) Sweep: Auto.
- e) Detector function: Peak.
- f) Trace: Max hold.
- g) Allow the trace to stabilize.
- h) Count the number of hopping frequencies

Limit

Limit

≥ 15

9.8 Minimum Hopping Channel Carrier Frequency Separation

Test Method

The EUT shall have its hopping function enabled. Use the following spectrum analyzer settings:

- a) Span: Wide enough to capture the peaks of two adjacent channels.
- b) RBW: Start with the RBW set to approximately 30% of the channel spacing; adjust as necessary to best identify the center of each individual channel.
- c) Video (or average) bandwidth (VBW) \geq RBW.
- d) Sweep: Auto.
- e) Detector function: Peak.
- f) Trace: Max hold.
- g) Allow the trace to stabilize.

Use the marker-delta function to determine the separation between the peaks of the adjacent channels. Compliance of an EUT with the appropriate regulatory limit shall be determined. A plot of the data shall be included in the test report.

Limit

Limit

$\geq 2/3$ of 20dB bandwidth of hopping channel

9.9 Average Channel Occupancy Time

Test Method

The EUT shall have its hopping function enabled. Use the following spectrum analyzer settings:

- a) Span: Zero span, centered on a hopping channel.
- b) RBW shall be \leq channel spacing and where possible RBW should be set $\gg 1 / T$, where T is the expected dwell time per channel.
- c) Sweep: As necessary to capture the entire dwell time per hopping channel; where possible use a video trigger and trigger delay so that the transmitted signal starts a little to the right of the start of the plot. The trigger level might need slight adjustment to prevent triggering when the system hops on an adjacent channel; a second plot might be needed with a longer sweep time to show two successive hops on a channel.
- d) Detector function: Peak.
- e) Trace: Max hold.

Use the marker-delta function to determine the transmit time per hop. If this value varies with different modes of operation (data rate, modulation format, number of hopping channels, etc.), then repeat this test for each variation in transmit time.

Repeat the measurement using a longer sweep time to determine the number of hops over the period specified in the requirements. The sweep time shall be equal to, or less than, the period specified in the requirements. Determine the number of hops over the sweep time and calculate the total number of hops in the period specified in the requirements, using the following equation:

(Number of hops in the period specified in the requirements) =
 (number of hops on spectrum analyzer) \times (period specified in the requirements / analyzer sweep time)

The average time of occupancy is calculated from the transmit time per hop multiplied by the number of hops in the period specified in the requirements. If the number of hops in a specific time varies with different modes of operation (data rate, modulation format, number of hopping channels, etc.), then repeat this test for each variation.

The measured transmit time and time between hops shall be consistent with the values described in the operational description for the EUT.

Limit

Limit

 $\leq 0.4s$

10 Appendix A - General Product Information

Radiofrequency radiation exposure evaluation

This exposure evaluation is intended for **FCC ID: 2AJ90-HG7822**

According to KDB 447498 D01v06 section 4.3.1, For frequencies between 100 MHz to 6GHz and test separation distances ≤ 50 mm, the Numeric threshold is determined as:

Step a)

$[(\text{max. power of channel, including tune-up tolerance, mW}) / (\text{min. test separation distance, mm})] \cdot [\sqrt{f(\text{GHz})}] \leq 3.0$ for 1-g SAR

>> The fundamental frequency of the EUT is 2402-2480MHz,
the test separation distance is ≤ 50 mm.
(Manufacturer specified the separation distance is: 5mm)
(5mm is the worst case according to the KDB)

Step b)

>> Numeric threshold (2402MHz), $\text{mW} / 5\text{mm} \cdot \sqrt{2.402\text{GHz}} \leq 3.0$
Numeric threshold (2402MHz) $\leq 9.678\text{mW}$

>> Numeric threshold (2441MHz), $\text{mW} / 5\text{mm} \cdot \sqrt{2.440\text{GHz}} \leq 3.0$
Numeric threshold (2441MHz) $\leq 9.602\text{mW}$

>> Numeric threshold (2480MHz), $\text{mW} / 5\text{mm} \cdot \sqrt{2.480\text{GHz}} \leq 3.0$
Numeric threshold (2480MHz) $\leq 9.525\text{mW}$

>> The power (measured + tune up tolerance) of EUT at 2402MHz is: 3.17dBm = 2.075mW
The power (measured + tune up tolerance) of EUT at 2441MHz is: 3.13dBm = 2.056mW
The power (measured + tune up tolerance) of EUT at 2480MHz is: 3.39dBm = 2.183mW

Which is smaller than the Numeric threshold.

Therefore, the device is exempt from stand-alone SAR test requirements.

Reviewed by:



Eric LI
EMC Project Manager

Prepared by:

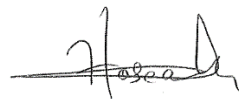
Hosea CHAN
EMC Project Engineer

11 Appendix B - Declaration of Model Difference

SILVERCREST

Lidl US LLC

To: TÜV SÜD Hong Kong Limited

Attention: Eric Li

From:

Date: July 26, 2021

Fax No:

Total Page (Cover Included): 1

Project No.: 60.790.21.002.01

Subject: **Declaration letter**

We: **Lidl US, LLC**

3500 South Clark Street, Arlington, VA 22202, US

Officially notify TÜV SÜV Hong Kong Limited that the <<Model A>> have the same technical construction including circuit diagram, PCB Layout, components and component layout, all electrical construction and mechanical construction, with <<PRODUCT>>, <<Model B>>. The difference lies only in the color of the different models.

<<Model A>>: **HG07822B-US**

<<Model B>>: **HG07822A-US**

<<Product>>: **Bluetooth Speaker**

Applicant: Lidl US, LLC

July 26, 2021

(Date)

(Applicant's authorized signature)

