



<b>Description of signal words</b> .....	Page 5
<b>Customer service</b> .....	Page 5
<b>Introduction</b> .....	Page 6
Intended use.....	Page 6
Description of parts.....	Page 7
Technical data.....	Page 14
Contents.....	Page 15
<b>Important safety notes</b> .....	Page 15
General safety information.....	Page 16
Safety warnings for batteries.....	Page 17
Before initial use.....	Page 19
<b>Before use</b> .....	Page 20
Setting up the devices.....	Page 20
Preparing to use the outdoor sensor.....	Page 21
Preparing the weather station for use.....	Page 21
<b>Operation</b> .....	Page 23
Receiving the WWVB radio time signal.....	Page 23
Disabling/Enabling DST (Daylight Saving Time) Function.....	Page 25
Setting the 12/24 hour mode/°C/°F/hPa/inHg/time zone/time/date/language manually.....	Page 26
Setting the alarm time.....	Page 28
Turning the alarm on/off.....	Page 29

Turning off the alarm.....	Page 29
SNOOZE function .....	Page 30
Preparing to use the weather forecasting function.....	Page 30
Selecting the location.....	Page 32
Selecting the location manually .....	Page 33
Lunar phases.....	Page 33
Reading the barometric pressure for the last 12 hours .....	Page 34
Adjusting the air pressure indication.....	Page 34
Setting the channel.....	Page 36
Displaying temperature and temperature trend.....	Page 36
Displaying the humidity and humidity trend .....	Page 37
Displaying the maximum / minimum temperature / humidity .....	Page 38
Temperature and frost alarm.....	Page 38
Activating / deactivating the the temperature and frost alarm .....	Page 39
Background lighting.....	Page 40
Battery state display.....	Page 40
Changing the batteries .....	Page 41

<b>Troubleshooting</b> .....	Page 42
------------------------------	---------

<b>Cleaning and care</b> .....	Page 43
--------------------------------	---------

<b>Disposal</b> .....	Page 44
-----------------------	---------

<b>Three year limited warranty</b> .....	Page 45
--	---------



## **WARNING**

WARNING indicates a hazardous situation that, if not avoided, could result in death or serious injury.

## **CAUTION**

CAUTION indicates a hazardous situation that, if not avoided, could result in minor or moderate injury.

## **NOTICE**

NOTICE indicates information considered important, but not hazard related (e.g. messages related to property damage).



Call customer service at  
**1 (844) 543-5872**

Visit a LIDL store for further assistance.

**IAN 314229**

Please have your  
IAN number  
ready.



Visit the Website Customer  
Service Platform at

**[www.lidl.com/contact-us](http://www.lidl.com/contact-us)**



## Wireless Weather Station

### ● Introduction

Congratulations on your purchase. You have selected a quality product. The instructions for use are a part of the product. They contain important information about the safety, use and disposal of the product. Before using the product, please learn about all the safety information and usage instructions. Only use the product as described and for the specified applications. If you lend the product to someone else, please also give all the instructions.

### ● Intended use

The weather station displays the indoor and outdoor temperatures in Celsius (°C) or Fahrenheit (°F) and their maximum and minimum values. It also displays the indoor and outdoor humidity (% RH) as well as their maximum and minimum values. The weather station additionally displays the weather forecast, the time in 12/24-hour clock mode and the date. The weather station displays the sunrise and sunset times for that day and the lunar phase as well. The weather station also has two different alarm functions. The product is only suitable for use in private households and is not intended for commercial use.



## ● Description of parts

### Weather station:

- |    |  |    |  |
|----|--|----|--|
| 1  | Date display                             | 21 | Humidity trend (outdoor)                           |
| 2  | Month display                            | 22 | Humidity (outdoor)                                 |
| 3  | Alarm 1                                  | 23 | Temperature and frost alarm<br>(maximum / minimum) |
| 4  | SNOOZE display                           | 24 | Temperature trend (outdoor)                        |
| 5  | Radio tower symbol                       | 25 | Outdoor temperature (°C / °F)                      |
| 6  | DST display (daylight saving time)       | 26 | Battery level display (outdoor<br>sensor)          |
| 7  | Time display                             | 27 | Selected channel                                   |
| 8  | Alarm 2                                  |    |  |
| 9  | Weekday display                          |    |  |
| 10 | Sunrise / time of sunrise                |    |  |
| 11 | Tidal range display                      |    |  |
| 12 | Location                                 |    |  |
| 13 | Lunar phase                              |    |  |
| 14 | Sunset / time of sunset                  |    |  |
| 15 | Temperature trend (indoor)               |    |  |
| 16 | Humidity trend (indoor)                  |    |  |
| 17 | Humidity (indoor)                        |    |  |
| 18 | Comfort indicator (maximum /<br>minimum) |    |  |
| 19 | Indoor temperature (°C / °F)             |    |  |
| 20 | Battery level display                    |    |  |

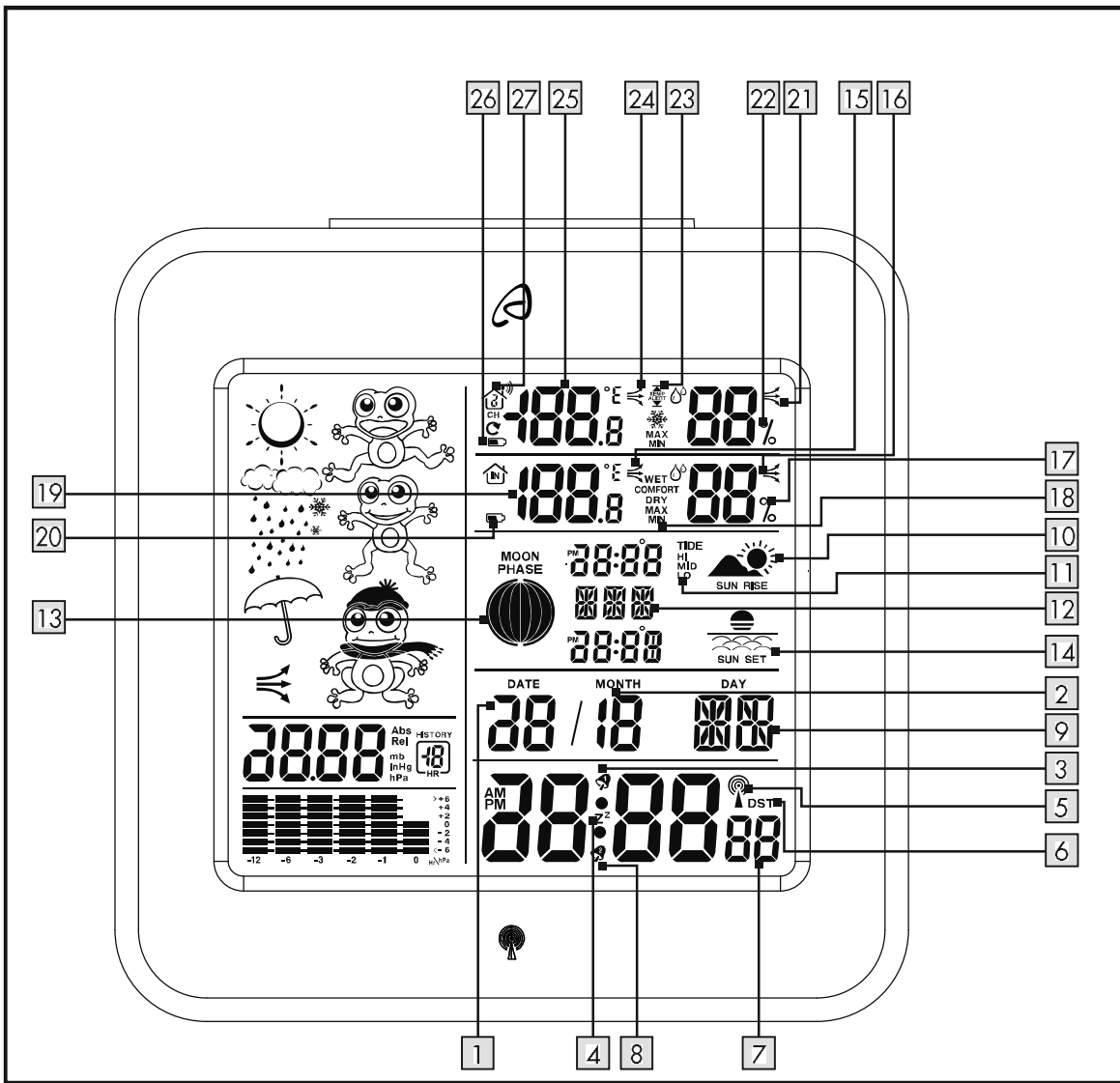

- 28 Barometric pressure bar display
- 29 Barometric pressure display of the last hour
- 30 Absolute / relative barometric pressure
- 31 Barometric pressure trend
- 32 Weather forecast
- 33 SNOOZE / LIGHT button

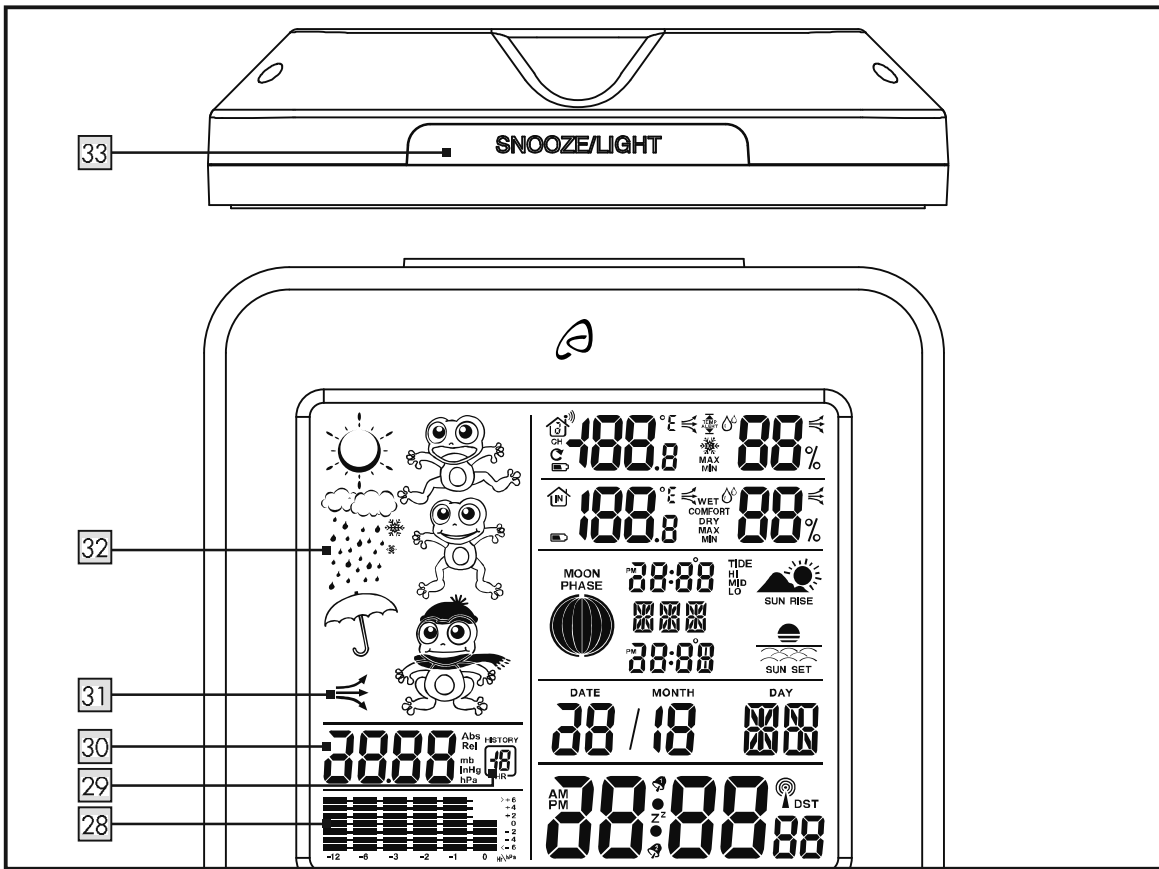



- 34 MODE button
- 35 + button
- 36 - button
- 37 Channel button (CH)
- 38 HISTORY ABS / REL button
- 39 CITY button

- 40 Battery compartment
- 41 RESET button
- 42 Folding stand
- 43 Hanging slot
- 44 Screw D 0.1 in (3 mm)
- 45 Dowel D 0.3 in (8 mm)



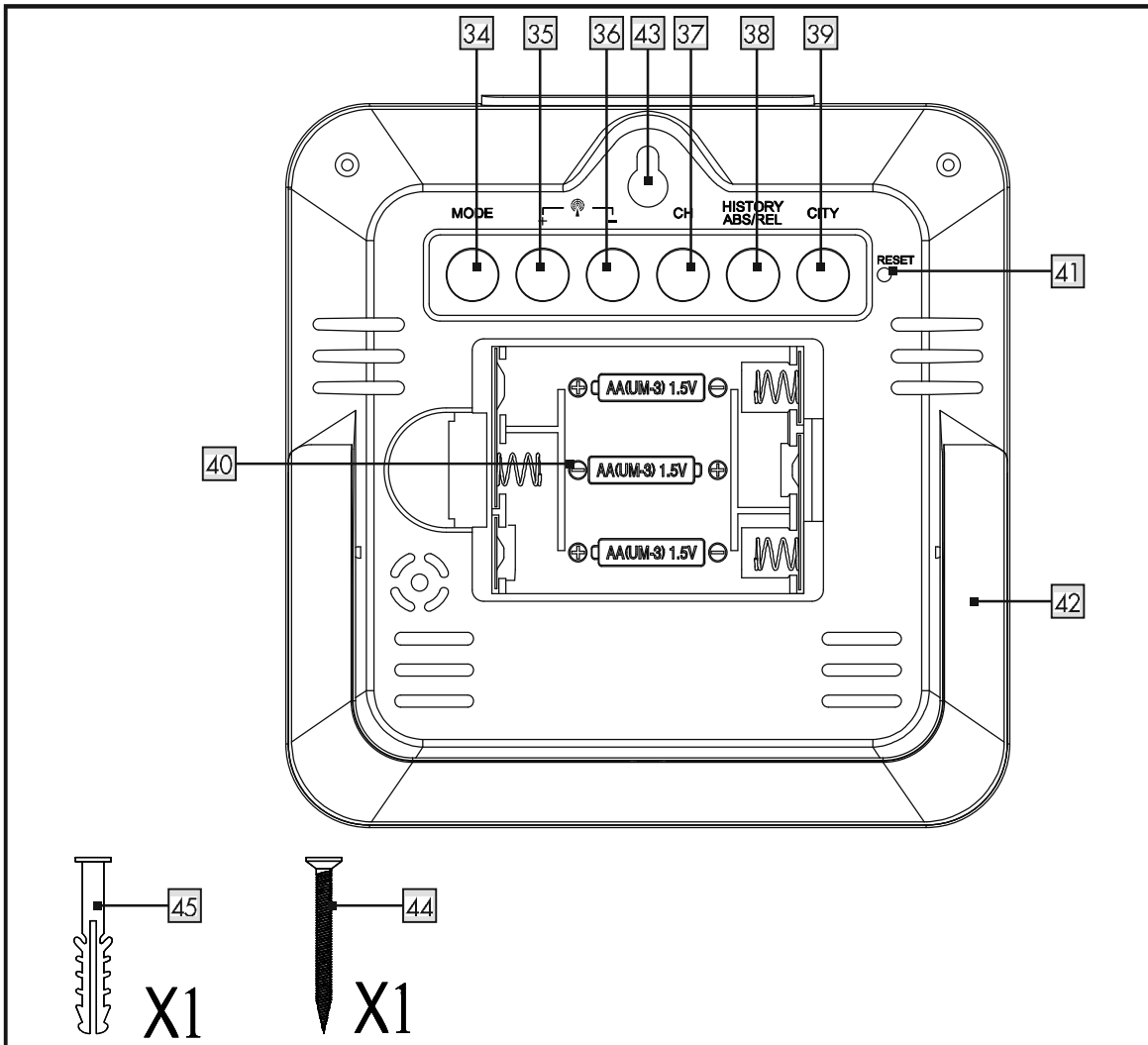



**Outdoor sensor:**

- 46 Control LED
- 47 Hanging slot
- 48 RESET button
- 49 Channel selector switch

- 50 Battery compartment
- 51 Screw D 0.1 in (3 mm)
- 52 Dowel D 0.3 in (8 mm)

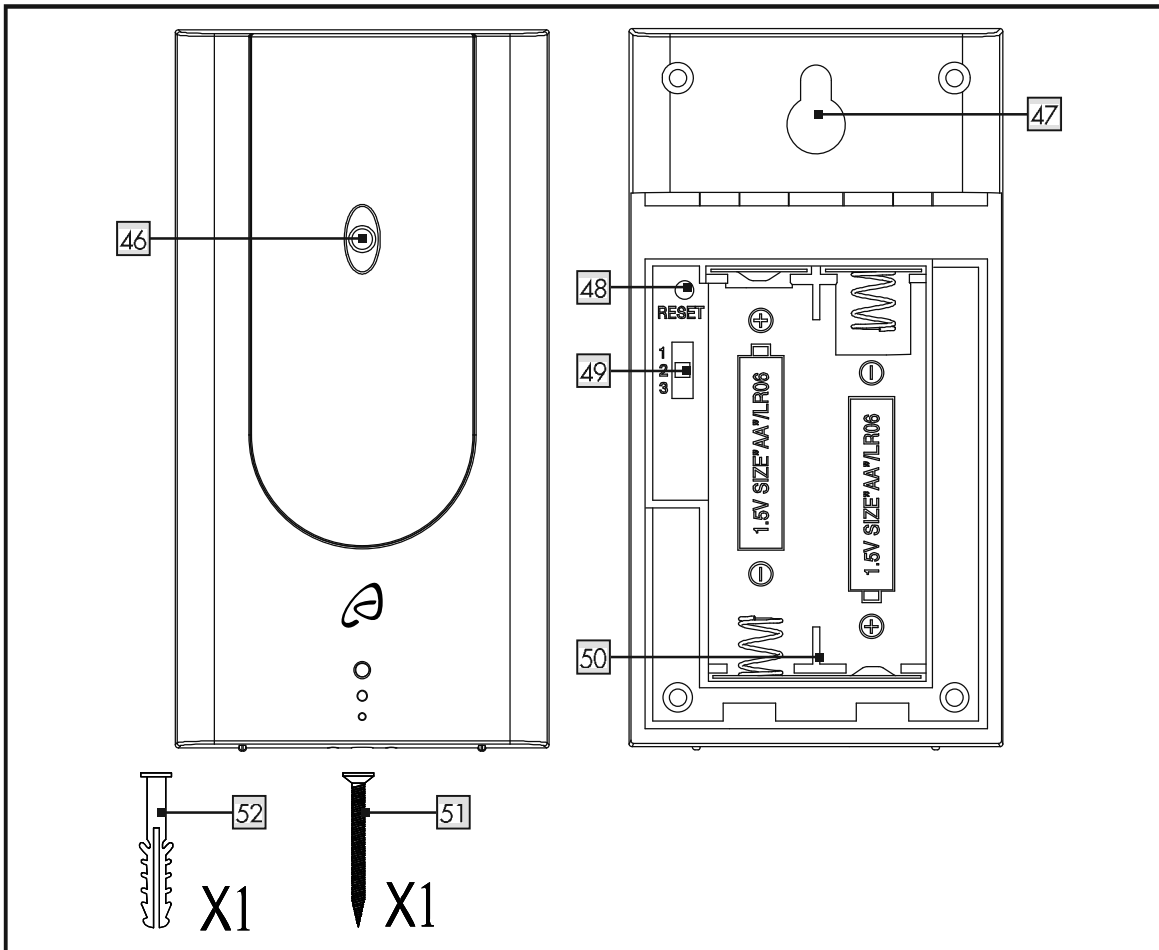

## ● Technical data

### Weather station:

Model No.:	HG04705-US-RX
FCCID:	2AJ90-HG4705RX
Temperature measurement range:	+32 °F to +122 °F / 0 °C to + 50 °C
Temperature resolution:	0.1 °F / 0.1 °C
Humidity measurement range:	20% - 95 %
Humidity resolution:	1 %
Radio signal:	WWVB
Batteries:	3 x AA, 1.5 V $\text{---}$ (direct current)
Air pressure range:	25.1 inHg to 31.1 inHg / 850 hPa to 1050 hPa
Frequency Band:	60 kHz, 433.050 MHz to 434.790 MHz
Batteries:	3 x AA 1.5 V $\text{---}$ (direct current)

### Outdoor sensor:

Model No.:	HG04705-US-TX
FCCID:	2AJ90-HG4705TX
Temperature measurement range:	-4 °F to +149 °F / -20 °C to +65 °C
Humidity measurement range:	20% - 95 %
Humidity resolution:	1 %
HF transmission signal:	433 MHz
HF transmission range:	max. 98.4 ft / 30 meters (in open area)
Batteries:	2 x AA 1.5 V $\text{---}$ (direct current)

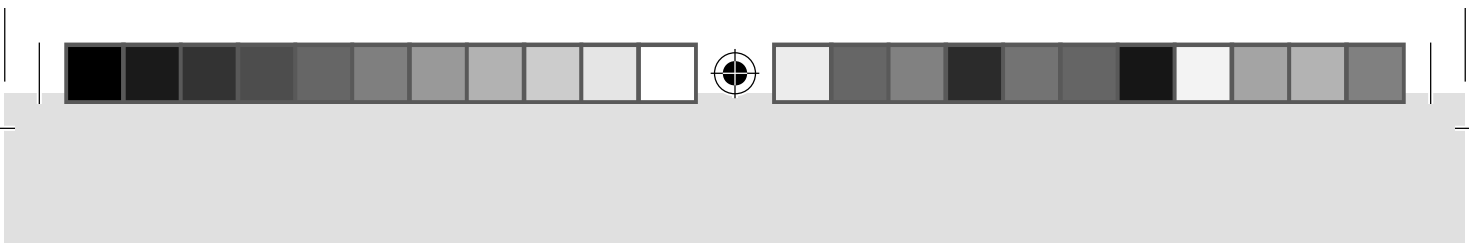

Degree of protection: IPX4 (Splash-proof) / suitable for wet locations  
Frequency band: 433.050 MHz to 434.790 MHz  
Max. transmitted power: < 10 dBm

## ● Contents

- 1 Weather station
- 1 Outdoor sensor
- 3 Batteries AA, 1.5 V (pre-installed in weather station)
- 2 Batteries AA, 1.5 V (pre-installed in outdoor sensor)
- 2 Screws D 0.1 in (3 mm)
- 2 Dowels D 0.3 in (8 mm)
- 1 Instructions for use



# **IMPORTANT SAFETY NOTES**

READ ALL INSTRUCTIONS. KEEP FOR FUTURE REFERENCE. INCLUDE ALL DOCUMENTATION WHEN PASSING THIS PRODUCT ON TO OTHERS.

## ● General safety information

### **⚠ WARNING** Failure to observe the following warnings can result in death or serious injuries.

- This product may be used by children 8 years and older and individuals with physical, sensory or cognitive impairments or lacking experience and knowledge when instructed on safe product use and they understand the associated risks. Do not allow children to play with the product. Never allow children to clean the product or perform user maintenance unsupervised.
- Changes or modifications to this product not expressly approved by the party responsible for compliance could void the user's authority to operate the product.

**Note:** This product has been tested and found to comply with the limits for a Class B digital device, pursuant to part 15 of the FCC Rules. These limits are designed to provide reasonable protection against harmful interference in a residential installation. This product generates, uses and can radiate radio frequency energy and, if not installed and used in accordance with the instructions, may cause harmful interference to radio communications.

However, there is no guarantee that interference will not occur in a particular installation. If this product causes harmful interference to radio or television reception, which can be determined by turning the product off and on, the user is encouraged to try and correct the interference by one or more of the following measures:

- Reorient or relocate the receiving antenna.
- Increase the separation between the product and receiver.

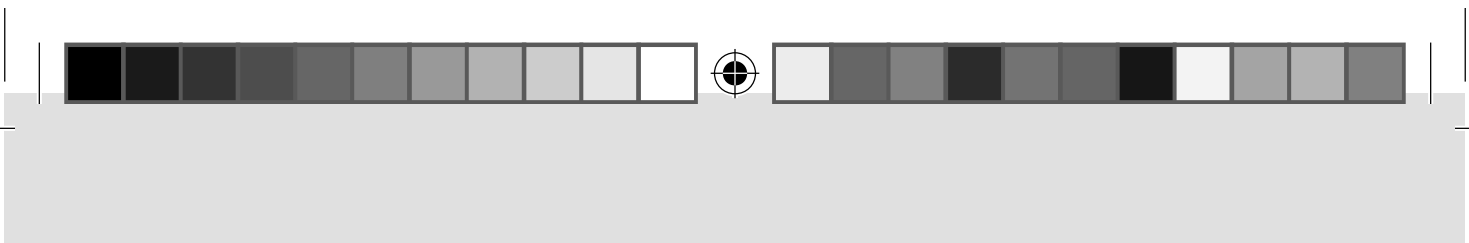
- 
- Connect the product into an outlet on a circuit different from that to which the receiver is connected.
  - Consult the dealer or an experienced radio / TV technician for help.
  - The RF Exposure Compliance distance is 0.78 in / 20 mm.

### **NOTICE**

- Do not expose the product to an extremely high electromagnetic field. This may impair the correct functioning of the product.
- Please note that the guarantee does not cover damage caused by incorrect handling, non-compliance with the operating instructions or interference with the product by unauthorized individuals.



### **Safety warnings for batteries**

- When used correctly, cells and batteries provide a safe and dependable source of portable power. However, if they are misused or abused, this may result in leakage, burns, fire, or explosion.
- Store batteries in a dry place at room temperature. Batteries are sensitive to high and low temperatures. Such thermal exposure may lead to leakage, fire, or explosion.
- Keep cells and batteries out of reach of children, especially small batteries. Ingestion may lead to choking or acute and serious personal injury.

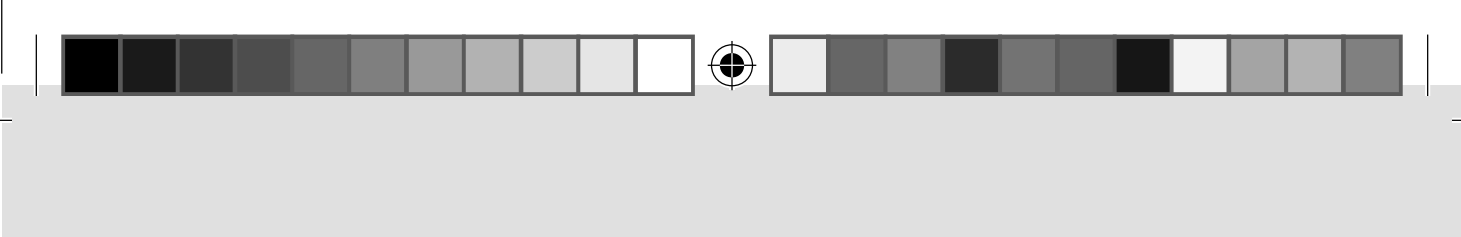
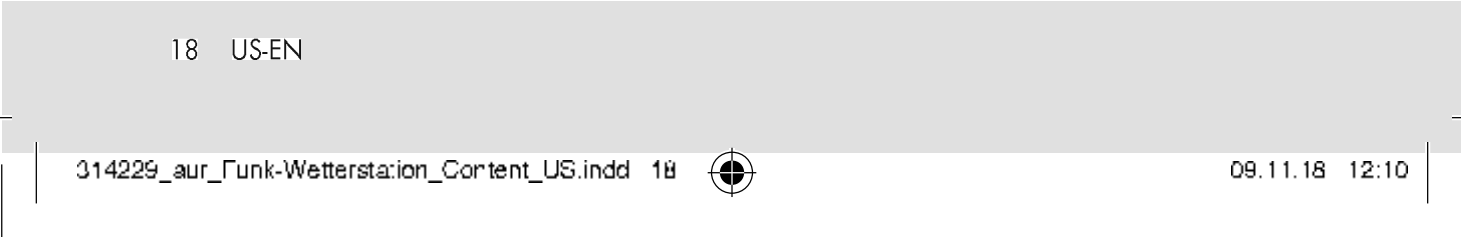
- 
- Keep cells or batteries clean and dry both during use and storage. Wipe metal terminals with a soft, dry cloth if they become dirty.
  - Immediately seek medical attention if a cell or battery has been swallowed. Also, contact your local poison control center.
  - In the event that the electrolyte comes into contact with the skin or eyes, immediately flush with fresh water for at least 15 minutes and seek medical attention.
  - Store unused batteries in their original packaging or in safe place and away from metal objects that may short-circuit them.
  - Exercise care in handling batteries in order to prevent shorting with conducting materials, such as rings, coins, bracelets, and keys. The battery or the conductor can overheat and cause burns, leakage, fire, or explosion.
  - Clean the battery contacts and also those of the product prior to battery installation. Keep the contacts clean.
  - Remove batteries from the product that will not be used for an extended period of time (months or longer).
  - Remove discharged batteries from product promptly to avoid possible damage from leakage.
  - Choose the proper battery for the intended application.
  - Always take care to correctly insert batteries observing (+) and (-) polarity marks on the battery and the product for which it is intended. Proper polarity must be observed to avoid damage to either product or batteries.
  - Always replace the whole set of batteries at one time, taking care not to mix old and new ones, or batteries of different types, capacities, or manufacturers.
  - Never heat batteries in order to revive them.
- 





## **⚠ WARNING**

Never charge a battery unless the battery label specifically states the battery is rechargeable. Charging a non-rechargeable battery, may result in leakage, fire, or explosion.

- Use only the power cord supplied with the product. The use of other cords may result in the batteries inside the product being charged.
- Do not open or mutilate a battery or cell. Electrolyte from the cell is corrosive and can cause damage to the eyes or skin. The cell contents can also be hazardous if ingested.
- Do not drop or subject the cell or battery to strong mechanical shock.
- Batteries should not be disassembled, crushed, punctured, or otherwise mutilated. Such abuses may result in leakage, fire, or explosion.
- Do not dispose of the battery in a fire. Failure to observe this precaution may result in an explosion.
- Dispose of batteries properly and in accordance with government regulations.

# SAVE THESE INSTRUCTIONS

## ● Before initial use

First activate the batteries inside the outdoor sensor, then inside the weather station.

**Note:** Remove all packaging material from the product.



## ● Before use

### ● Setting up the devices

**⚠ CAUTION!** When choosing where to position the weather station, make sure that it is not exposed to direct sunlight, vibrations, dust, heat, cold or moisture. Do not place the devices close to sources of heat, e.g. radiators. Otherwise they may be damaged.

- Do not place the devices on valuable or sensitive surfaces unless these are appropriately protected. Otherwise they may be damaged.
- Please ensure that neighboring devices are not operated at the same frequency of 433 MHz. These types of devices may interfere with the radio connection.
- Do not place the devices next to or on metal plates. Otherwise the quality of radio wave transmission may be reduced.
- Do not install the devices in buildings made of reinforced concrete, e.g. airports, high-rise buildings, factories or cellars. Otherwise the transmission of the radio waves between the devices may be severely impaired.



## ● Preparing to use the outdoor sensor

- Remove the battery compartment cover from the back of the outdoor sensor.
- Remove the battery insulation tab. The outdoor sensor is now ready for use and the control LED **46** will light up briefly.
- Close the battery compartment cover.
- Find an appropriate place for the outdoor sensor.

**Note:** Please ensure that you install the outdoor sensor within a radius of 98.4 ft / 30 meters from the weather station. Check that there are no obstacles between the outdoor sensor and the weather station. They may interfere with data transmission.



## ● Preparing the weather station for use



### Removing the battery insulation tab:

- Open the battery compartment **40** on the back of the weather station.
- Remove the battery insulation tab.
- Then close the battery compartment.

As soon as the battery insulation tab has been removed, the weather station will start receiving radio signal.

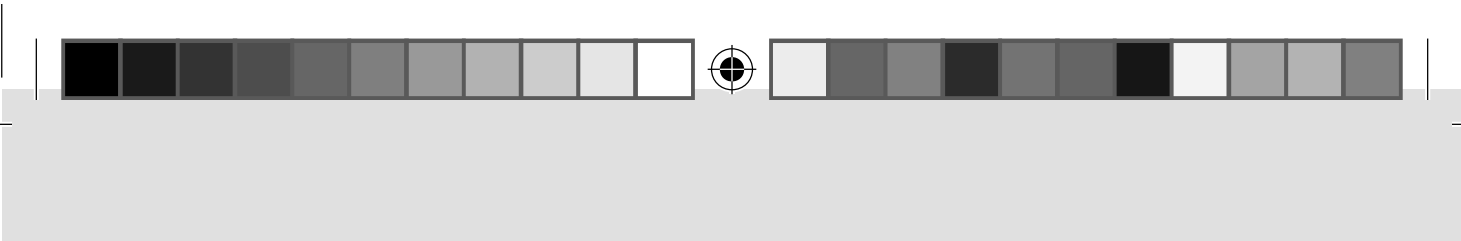

**Note:** Do not move the weather station while it is receiving the signal. This may disrupt reception.

### **Connecting the weather station with the outdoor sensor and the WWVB radio signal:**

After removing the battery insulation tab, the weather station will attempt to establish a connection with the outdoor sensor. This process can take a few minutes. The ))) symbol will keep flashing for a few minutes. After successfully connecting with the outdoor sensor, the selected channel symbol [27] will appear in the LC display with the channel of the outdoor sensor (if necessary you can change the channel of the outdoor sensor as shown under "Setting the channel"). If the connection with the outdoor sensor is not established automatically, this can be done manually as follows:

1. Press the channel button (CH) [37]. The icon of the selected channel [27] will flash in the LC display. Outdoor temperature [25] and Humidity(Outdoor) [22] will display "-.\_", weather station will start receive the outdoor sensor signal process.
2. Then press the RESET button [48] of the sensor. Weather station outdoor temperature [25] and Humidity(Outdoor) [22] will display the last value.

As soon as the weather station has established a connection with the outdoor sensor it automatically begins to receive the WWVB radio signal. This process takes several minutes and is indicated in the LC display by a flashing radio tower symbol [5].



When the WWVB radio signal is being successfully received, the radio tower symbol is shown permanently in the display. If the product cannot synchronize with the atomic clock during setup, you can also set the clock manually (“Setting the 12/24 Hour Mode/ °C/ °F/ hPa/ inHg/ Time Zone/ Time/ Date/ Language Manually”).

### **Radio signal (WWVB):**

The WWVB radio signal (time signal transmitter) is made up of time pulses transmitted from one of the highest precision clocks in the world close to Fort Collins, Colorado. Reception of the radio signal generally takes 3–10 minutes.

Reception can be considerably impaired by obstacles (e.g. concrete walls) or sources of interference (e.g. other electrical devices). In the event of reception problems, change the position of the weather station (e.g. to somewhere near a window).

## **● Operation**

### **● Receiving the WWVB radio time signal**

After a connection with the outdoor sensor is established or 3 minutes after the battery insulation tab is removed, the weather station automatically begins to search for the WWVB radio signal. The LC display will show a flashing radio tower symbol 5 during the search process.

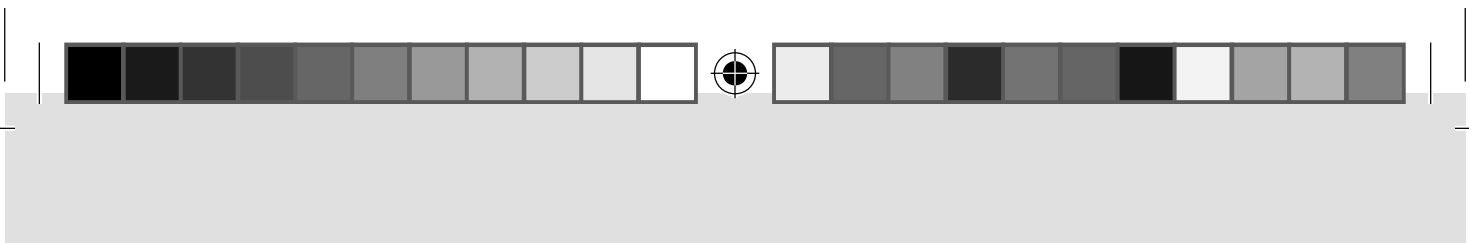

**Note:** In buildings made of reinforced concrete the reception of the radio signal may be severely impaired (see “Setting up the devices”).

In order to correct any deviations from the exact time, the clock is automatically synchronized with the WWVB radio signal every day at 1:00, 2:00 and 3:00. Reception of the WWVB radio signal can also be started manually on the weather station.



- Press the + and - button 35, 36 at the same time. The weather station will attempt to receive the WWVB radio signal. This process takes several minutes and is indicated in the LC display by a flashing radio tower symbol.

If the connection with the WWVB radio signal cannot be established, the search is stopped.

**Note:** If the clock of the weather station cannot receive the WWVB radio signal due to errors, or because the transmitter is too far away, or due to similar reasons, the time may also be set manually. If reception of the WWVB signal is successful, the manual settings are overwritten.

If the reception of the radio signal continues to be interrupted, you can turn the automatic radio time on/off manually.

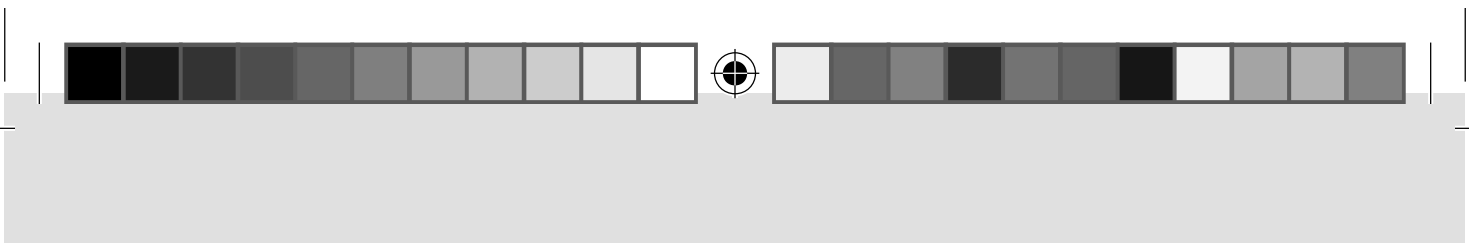
- Press and hold down the MODE button 34 and the + button 35 for about 3 seconds. WWVB  5 is shown in the LC display, the automatic radio time receive function is turned off. Now you can set the time and date manually (see “Setting the language / time zone / time / date manually”).

- 
- Press and hold down the MODE button **34** and the + button **35** for about 3 seconds again. WWVB  **5** disappear, the automatic radio time receive function is turned on. The weather station will start the reception of the radio time during early morning.

## ● Disabling / Enabling DST (Daylight Saving Time) Function

If your location does not observe DST, you may disable DST function.

To turn off DST function, press and hold the HISTORY **38** and CITY **39** button for about 2 seconds. DST **6** will not shown in the LC display, the DST function is turned off.





To turn on DST function, press and hold the HISTORY **38** and CITY **39** button for about 2 seconds. DST **6** will start flashing to receive the signal. DST **6** will be shown in LC display once DST function is turned on. The product will change times automatically.



## ● Setting the 12/24 hour mode / °C / °F / hPa / inHg / time zone / time / date / language manually

The reception of WWVB radio signal where the weather station has been positioned may deteriorate or be interrupted. If this happens you can set the device manually.

### Follow these steps:

1. Press and hold down the MODE button  for about 3 seconds. The display will flash "12 Hr" or "24 Hr". Press the + or - button ,  to choose the desired hour format.  
**Note:** The AM symbol in the time display  stands for before noon in the 12 hour mode. In 12 hour mode the PM symbol in the time display stands for afternoon.
2. Confirm your setting by pressing the MODE button. The temperature unit "°C" or "°F" flashes in the display. Press the + or - button to choose the desired temperature unit.
3. Confirm your setting by pressing the MODE button. The barometric pressure unit flashes in the display. Press the + or - button to set the desired unit (hPa / inHg).
4. Confirm your setting by pressing the MODE button. The time zone indicator flashes in the display. Press the + or - button to set the desired value P-8, M-7, C-6, E-5).

**Note:** If you are in a country where the WWVB radio signal can be received but the time differs from your current local time, you can use the time zone







setting to have the clock display your current local time. If you are in a country where e.g. the local time is an hour ahead of Pacific Standard Time (PST), set the time zone to -8. The product is now still controlled by WWVB but shows the time as one hour ahead of PST. Confirm your setting by pressing the MODE button. The DST  symbol flashes in the display. Press the + or - button to desired the DST function ON/OFF.

5. Confirm your setting by pressing the MODE button. The hour value of the time display flashes. Press the + or - button to set the desired value.

**Note:** The time and date settings will be done automatically if the weather station receives the WWVB signal. You should manually adjust the time and date if you have no reception of WWVB.

**Tip:** Hold the + or - button pressed down. This will speed up the process of setting the values. You can also use this fast setting option for subsequent settings. If you do not press any button for 20 seconds, the LCD automatically reverts to the standard display.

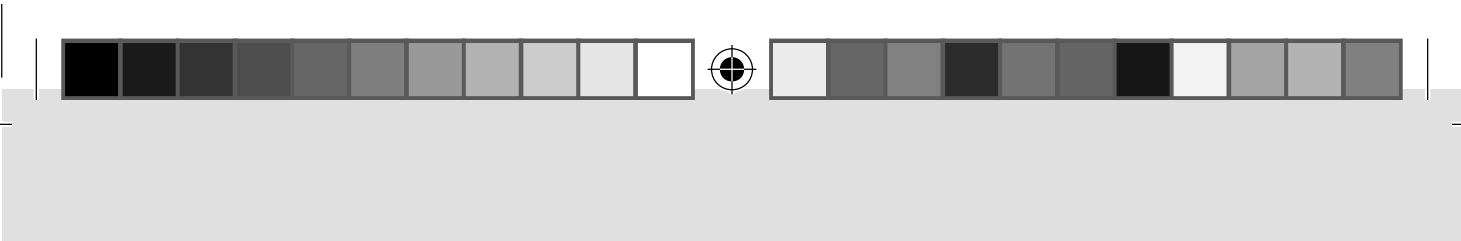



6. Confirm your setting by pressing the MODE button. The minute indicator of the time display will flash. Press the + or - button to set the desired value.
7. Confirm your setting by pressing the MODE button. The year indicator flashes in the time display. Press the + or - button to set the desired value.
8. Confirm your setting by pressing the MODE button. The month indicator flashes in the date display . Press the + or - button to set the desired value.
9. Confirm your setting by pressing the MODE button. The day indicator flashes in the date display. Press the + or - button to set the desired value.

- 
10. Confirm your setting by pressing the MODE button. At the place of the day of the week display , the language indicator of this display flashes. Press the + or - button to choose the desired language.

**Note:** You have the choice of German (GE), English (EN), Italian (IT), French (FR) and Spanish (SP) (English is set as the standard language).



11. Confirm your setting by pressing the MODE button.

## ● Setting the alarm time



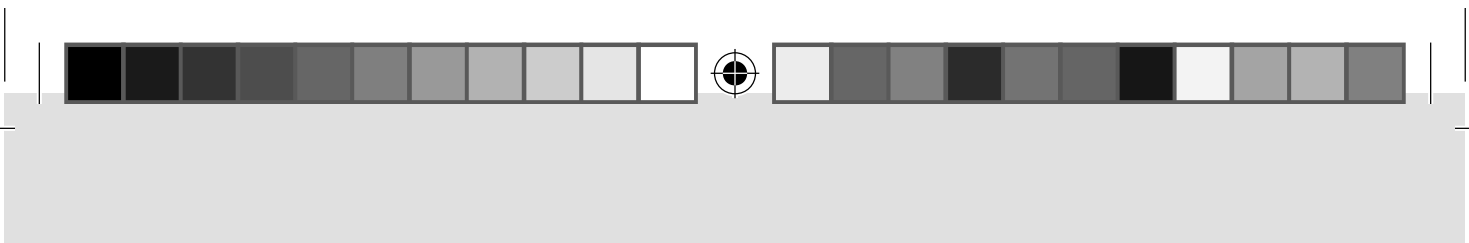

- 
1. Press the MODE button  briefly to set the alarm. The current alarm time will appear in the LC display.
  2. Press and hold down the MODE button for about 2 seconds. The hours display flashes.
  3. Press the + or - button ,  to set the desired value.
  4. Confirm your setting by pressing the MODE button. The minutes display flashes. Repeat step 3 to set the minutes.
  5. Confirm your setting by pressing the MODE button.
- 

**Tip:** Hold the + or - button. This will speed up the process of setting the values. You can also use this fast setting option for subsequent settings. If you do not press any button for 20 seconds, the LCD automatically reverts to the standard display.

**Note:** You can set two different alarms.

- 
6. Press the MODE button twice briefly if the weather station is in time display  mode. Press the MODE button once briefly if the weather station is in ALARM 1 mode. This will take you to ALARM 2 mode.
  7. Repeat steps 2–5 to set the value for ALARM 2.

## ● Turning the alarm on / off

1. Press the MODE button  briefly once or twice for ALARM 1 or ALARM 2 mode.
2. Press the + button . The ALARM 1 symbol  or ALARM 2 symbol  appears in the LC display. The alarm has been activated.
3. Press the button + again. The ALARM 1 or ALARM 2 symbol in the LC display goes out. The alarm has been deactivated.

## ● Turning off the alarm

- Press any button except the SNOOZE-/LIGHT button  to stop the alarm signal. It is not necessary to reactivate the alarm. It will automatically go off again at the set time.

**Note:** The alarm signal sounds for 2 minutes.



## ● SNOOZE function

- Press the SNOOZE-/LIGHT button  when the alarm sounds to SNOOZE the alarm. The alarm signal sounds again after 5 minutes.

## ● Preparing to use the weather forecasting function

**Note:** Please take the weather forecast from your local weather forecasting service into account as well as the forecast from your weather station. If there are discrepancies between the information from your product and from the local weather forecasting service, please take the advice of the latter as authoritative.

The weather forecast is calculated from evaluation of fluctuations in the barometric pressure and may deviate from the actual weather conditions.

The weather station displays the following weather symbols:

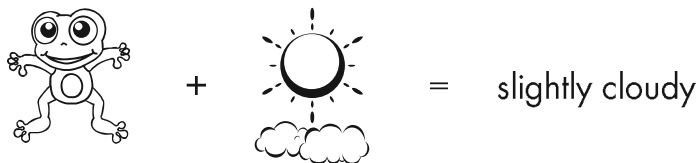

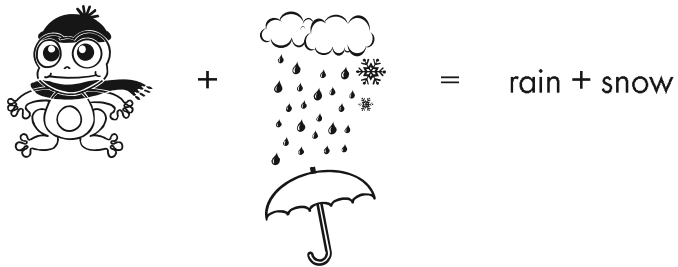
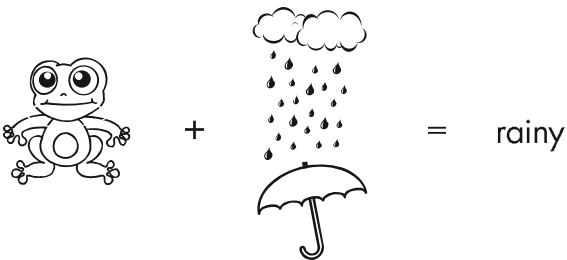



The weather symbols indicate the weather fluctuation over the next eight hours and not the current weather.

The weather station can display the barometric pressure trend 31.



You may see the following displays:

-  The barometric pressure will rise.
-  The barometric pressure will remain constant.
-  The barometric pressure will fall.

## ● Selecting the location

- Press the CITY button 39. The location display 12 blinks and the longitude and latitude are displayed.
- Press the + or - button 35, 36 to select your location.
- Press the CITY button to confirm your entry. If the abbreviation for your location does not appear in the display, you may enter a user-defined location (see "Selecting the location manually").

After a brief moment, the weather station displays the sunrise and sunset times, the lunar phases as well as the tidal range - low (TIDE LO), medium (TIDE MID) and high (TIDE TH).





## ● Selecting the location manually

- Press the CITY button **[39]** down for 2 seconds and keep it pressed. Press the + or - button **[35]**, **[36]** to select the beginning letters of your location.
- Press the CITY button to confirm your entry. Enter the 2nd and 3rd letters in the same fashion.  
GMT appears in the LC display and the time zone indicator blinks.
- Press the + or - button to set the difference from your time zone to GMT.
- Press the CITY button to confirm your entry. Set the longitude and latitude of your location in the same fashion.





After a brief moment, the weather station displays the sunrise and sunset times, the lunar phases as well as the tidal range - low (TIDE LO), medium (TIDE MID) and high (TIDE TH).

## ● Lunar phases

The weather station has a display which automatically displays the current lunar phase **[13]**.

			
New moon	Waxing half-moon	Half-moon	Waxing full moon



			
Full moon	Waning full moon	Half-moon	Waning half-moon

## ● Reading the barometric pressure for the last 12 hours

- Press the HISTORY ABS / REL button **38** repeatedly to read the barometric pressure values for the last 12 hours.  
OHR = present barometric pressure,  
- 1HR = barometric pressure an hour earlier  
- 2HR = barometric pressure two hours earlier, etc.

## ● Adjusting the air pressure indication

The forecast of this weather station is based on an analysis of the changes in air pressure.

The barometric pressure **30** is factory provided adjusted to the absolute air pressure. As the air pressure generally decreases with the elevation above sea level, the public weather service always announces the so-called relative air pressure. This relative air pressure is adjusted to the topography of the country in order to get comparable values.



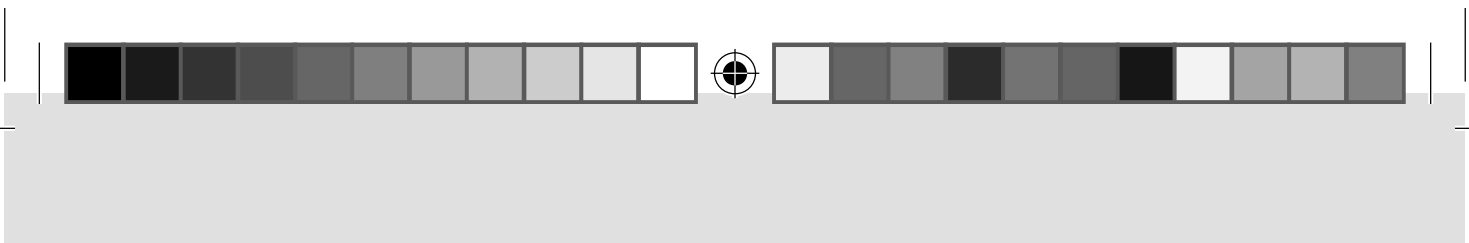

You can adjust the air-pressure of your weather station to the proportion of its place. In this case you will need to customize the weather station's current air pressure. Ask your local weather forecast service for the barometric pressure at sea level or get the current value from the Internet. To adjust the weather station:

- Press and hold the HISTORY ABS/REL button **38** for 3 seconds. Then press the + or - button **35**, **36** to toggle between the absolute or relative air pressure.
- Choose "Rel" and press the HISTORY ABS/REL button to confirm. The air pressure indication blinks. Now you can choose the correct value by pressing the + or - button.
- Confirm your choice by pressing the HISTORY ABS/REL button. Your weather station now shows the relative air pressure.





If you want your weather station to announce the absolute air pressure, proceed as follows:

- Press and hold the HISTORY ABS/REL button for 3 seconds. Then press the + or - button to change to the absolute air pressure. Confirm by pressing the HISTORY ABS/REL button.





## ● Setting the channel



The weather station automatically receives the outdoor sensor signal once you have completed all the settings.

**Note:** In the event of interference from nearby equipment transmitting radio signals, both the humidity (outdoor)  and outdoor temperature  symbols will flash. Please select a different channel for the outdoor sensor by pressing the CH button  on the weather station or the channel selector switch  on the outdoor sensor. The relevant information is shown in the LC display.



- 1: Outdoor sensor channel 1
- 2: Outdoor sensor channel 2
- 3: Outdoor sensor channel 3
- : automatic channel change

## ● Displaying temperature and temperature trend

The current indoor temperature  and the temperature trend (indoors)  are shown in the LC display.

After successfully connecting with the outdoor sensor, the weather station can display the outdoor temperature  and the temperature trend (outdoor) . You may see the following displays:



-  The temperature is rising.
-  The temperature is remaining constant.
-  The temperature is falling.

## ● Displaying the humidity and humidity trend

The current humidity trend (indoors) 16 and the current humidity (indoors) 17 are shown in the LC display.

The COMFORT indicator 18 displays the humidity in three categories. The categories are:

- DRY = Humidity < 40 %
- COMFORT = Humidity 40-70 %, indoor temperature 68 °F-82.4 °F / 20 °C-28 °C
- WET = Humidity > 70 %

After successfully connecting with the outdoor sensor, the weather station shows the humidity trend (outdoors) 21 and the humidity (outdoors) 22 in the LC display.



## ● Displaying the maximum / minimum temperature / humidity

The minimum / maximum temperature / humidity is measured for the first time after the batteries have been inserted and stored in the weather station.

The maximum and minimum values for temperature, hygrometer and barometric pressure are automatically saved.

- If the weather station is in time display **7**, press the + button **35** to display the maximum values.
- Press the + button twice to display the minimum values.
- Hold the + button down for 3 seconds to erase the stored maximum and minimum values.

## ● Temperature and frost alarm

The temperature alarm is a short beep, which sounds as soon as the outdoor temperature exceeds or falls below the preset temperature range. Follow the below procedures to set the desired temperature range.

- Press the - button **36** to access the temperature alarm mode.

- Hold the - button down for 3 seconds. The maximum temperature display blinks. Press the + or - button to set the values.
- Press the MODE button **34** to confirm your setting. The minimum temperature display blinks. Press the + or - button to set the values.
- Press the MODE button to confirm your setting.

## ● **Activating / deactivating the the temperature and frost alarm**

- If more than one outdoor sensor is activated, press the channel button **37** to select one.
- Press the - button **36** repeatedly to activate the temperature and frost alarms.

If the frost alarm is activated, the corresponding symbol **23** appears next to the outdoor temperature. The alarm signal sounds at 30.2 °F to +37.4 °F / -1 °C to + 3 °C.

If the temperature alarm is activated, the corresponding symbol appears next to the outdoor temperature. The alarm signal sounds at the set values.

If the temperature and frost alarm are activated, both symbols appear in the display.



## ● Background lighting

- Press the SNOOZE / LIGHT button [33](#). The backlight will light up for 5 seconds.

## ● Battery state display

The battery state display [20](#), [26](#) appears in the weather station's LC display if the batteries are weak. Make sure you replace the batteries soon (see "Changing the batteries").

## Mounting the weather station and / or the outdoor sensor on a wall:

**Note:** You will require an electric drill and a crosshead screwdriver for this step.

### **CAUTION! DANGER TO LIFE, RISK OF INJURY AND PROPERTY**

**DAMAGE!** Carefully read the instructions for use and safety notes for your drill.

**⚠ WARNING! DANGER TO LIFE!** Be sure not to hit electrical, gas or water lines when drilling into the wall. If necessary, check with a pipe and cable detector before drilling.

**Note:** Before mounting the weather station, please close the folding stand [42](#) by simply pulling it off.

- Mark the position of the hole (D 0.3 in (8 mm)) on the wall.
- Drill the hole with an electric drill.



- Insert the dowel [45], [52] into the drilled hole.
- Using a crosshead screwdriver, screw the screw [44], [51] into the dowel.
- Hang the weather station or outdoor sensor by placing the hanging slot [43], [47] on the corresponding screw.

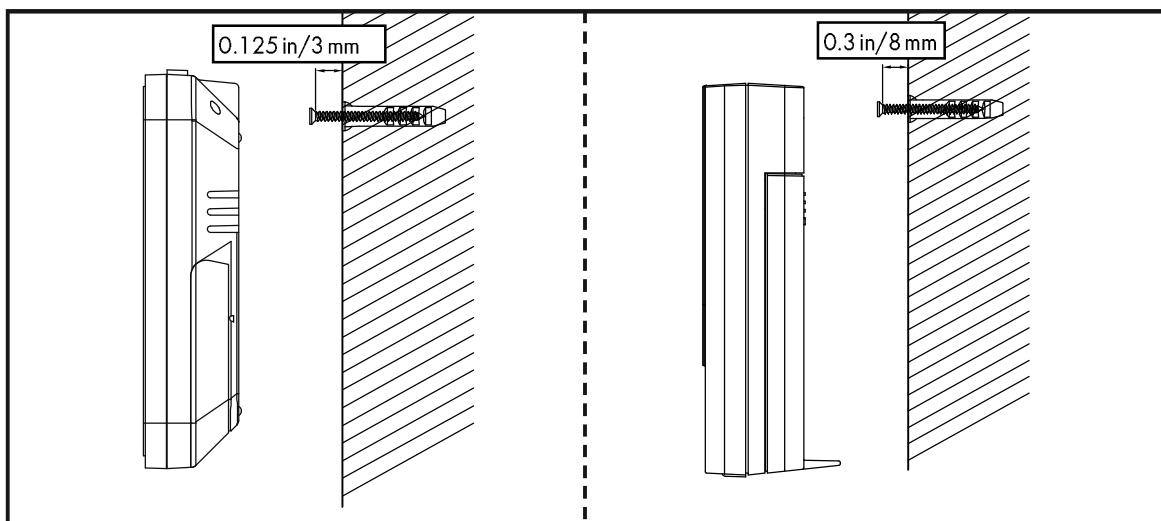

## ● Changing the batteries

### **Weather station:**

Replace the batteries if the LC display becomes illegible or if the battery display [20] is shown.



- Remove the battery compartment cover on the back of the weather station.
- Remove the used batteries.
- Insert 3 new batteries type AA, 1.5 V.  
**Note:** Make sure that the polarity is correct when you insert the battery. The correct polarity is shown inside the battery compartment [40](#).
- Close the battery compartment.

### **Outdoor sensor:**



Replace the batteries if battery display [26](#) is shown.

- Remove the battery compartment cover from the back of the outdoor sensor.
- Remove the used batteries.
- Insert 2 new batteries type AA, 1.5 V.  
**Note:** Make sure you insert the batteries with the correct polarity. The correct polarity is shown inside the battery compartment [50](#).
- Close the battery compartment.

## **● Troubleshooting**

**Note:** This product has delicate electronic components. This means that if it is placed near an object that transmits radio signals, it could cause interference.

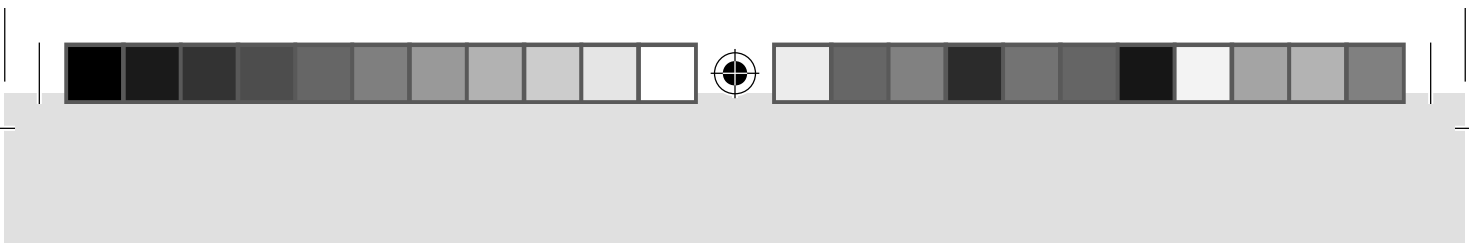

- 
- If the display indicates a problem, move such objects away from the weather station or outdoor sensor or remove the batteries from the weather station or outdoor sensor for a short while and then replace them or press the RESET button  back of the weather station.

Obstacles such as concrete walls can also interfere with reception. In this case, change the location (e.g. near a window). Please take note that the external sensor should always be set up within max. 98.4 ft / 30 meters (in open area) from the base station. The specified range is the free-field range and means that no obstacle should be between the remote sensor and the base station. A “visual contact” between remote sensor and base station often improves the transmission.

Cold (outdoor temperatures below 32° F / 0° C) can reduce the battery power of the outdoor sensor and thereby negatively impair the radio transmission. Another factor that may cause harmful interference is dead or weak batteries in the outdoor sensor. Replace them with new ones.

## ● Cleaning and care

- Under no circumstances should you use liquids or detergents, as these will damage the product.
- Clean only the outside of the product with a soft, dry cloth.
- Never spray the outdoor sensor, e.g. with a garden hose. The outdoor sensor is only protected against rain from above.

## ● Disposal

Dispose of the packaging through your local recycling facilities and in compliance with all federal, state and local regulations.



Please note the package markings regarding waste separation, indicated by abbreviations (a) and numbers (b), meaning: 1-7: plastics / 20-22: paper and cardboard / 80-98: composite materials.

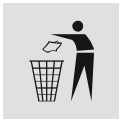

Contact your local waste management authority for additional information on how to dispose of the used product.

To help protect the environment, please dispose of the product properly when it has reached the end of its useful life, do not throw in the garbage. Information on collection sites and their opening hours is available from your local authority.



### **Improper disposal of batteries can damage the environment!**

Never throw batteries in the garbage. They may contain toxic heavy metals and must be handled as special waste. The chemical symbols of heavy metals are: Cd = cadmium, Hg = mercury, Pb = lead. Used batteries should therefore be disposed of through a local collection point.



## ● **Three year limited warranty**

### **What does this warranty cover?**

The warranty covers:

- Damage, breakage or inoperability due to defect.
- Damage not caused by normal wear and tear or failure to follow the safety and maintenance instructions provided in the user manual.

### **What is not covered by the warranty?**

The warranty does not cover damage caused by:

- Normal wear and tear of the product, including fragile parts (such as switches, glass, etc.);
- Improper use or transport;
- Disregarding safety and maintenance instructions;
- Accidents or acts of nature (e.g. lightning, fire, water, etc.);
- Tampering with the product (such as removing cover, unscrewing screws etc.).

Consequential and incidental damages are also not covered under this warranty. However, some states do not allow the exclusion or limitation of incidental or consequential damages, so this limitation or exclusion may not apply to you.

### **What is the period of coverage and warranty resolution?**

The warranty is for 3 years from the date of purchase. At our discretion, product will either be refunded or replaced.



## **What will we not do?**

We will not:

- Start a new warranty period upon product exchange;
- Repair product.

## **How to process the warranty?**

To initiate, please:

- Call customer service at 1 (844) 543-5872
- Visit the Website Customer Service Platform at [www.lidl.com/contact-us](http://www.lidl.com/contact-us)  
or
- Visit a LIDL store for further assistance



To ensure the quickest warranty return process, please have the following available:



- The original sales receipt that includes the date purchased;
- The product and manual in the original package;
- A statement of the problem.

## **What must you do to keep the warranty in effect?**

- Retain the original receipt;
- Follow all product instructions;
- Do not repair or modify the product.



### **How does state law relate to this warranty?**

This warranty gives you specific legal rights, and you may also have other rights which vary from state to state. All implied warranties are limited by the duration and terms of this warranty. Some states do not allow limitations on how long an implied warranty lasts, so the above limitation may not apply to you.

