

Description of signal words	Page	4
Customer service	Page	5
Introduction	Page	6
Intended use.....	Page	6
Description of parts and features.....	Page	7
Technical data.....	Page	13
Contents.....	Page	14
Important safety notes	Page	15
General safety information.....	Page	15
Safety warnings for batteries	Page	17
Before initial use	Page	21
General information.....	Page	22
Preparing to use the outdoor sensor.....	Page	23
Preparing the temperature station for use	Page	23
Temperature station	Page	26
Outdoor sensor	Page	28
Setting the language / time zone / time / date manually.....	Page	30
Daylight saving time.....	Page	32
Setting the alarm	Page	32
Displaying the alarms	Page	33
Switching the alarm on / off	Page	33
Using the snooze button.....	Page	34
Displaying the temperature	Page	34
Displaying the minimum / maximum values.....	Page	35
Displaying the temperature trends	Page	36
Battery indicator	Page	36
Replacing the batteries	Page	36
Troubleshooting	Page	39
Cleaning and maintenance	Page	40
Disposal	Page	41
Three year limited warranty	Page	42



DESCRIPTION OF SIGNAL WORDS



WARNING

WARNING indicates a hazardous situation that, if not avoided, could result in death or serious injury.

CAUTION

CAUTION indicates a hazardous situation that, if not avoided, could result in minor or moderate injury.



NOTICE

NOTICE indicates information considered important, but not hazard related (e.g. messages related to property damage).



CUSTOMER SERVICE



Call customer service at
1 (844) 543-5872



Visit the Website Customer Service Platform at
www.lidl.com/contact-us

Visit a LIDL store for further assistance.



IAN 307351

Please have your IAN number ready.



US-EN 5



Temperature Station Alarm Clock

● Introduction



Congratulations on your purchase. You have selected a quality product. The instructions for use are a part of the product. They contain important information about the safety, use and disposal of the product. Before using the product, please learn about all the safety information and usage instructions. Only use the product as described and for the specified applications. If you lend the product to someone else, please also give all the instructions.



























● Intended use

The product displays the indoor and outdoor temperatures in Celsius (°C) or Fahrenheit (°F) and their maximum and minimum values. The product also displays the time in 12/24-hour clock mode and the date. In addition, the product has two alarm functions. The product is only suitable for use in private households and is not intended for commercial use.



● Description of parts and features

LC display

- | | |
|---|---|
|   1 DST daylight saving time symbol |  11  Low battery symbol (outdoor sensor) |
|  2  WWVB symbol |  12 MAX/MIN display (indoor temperature) |
|  3 ZZ snooze function symbol |  13 Indoor temperature |
|  4 Date/month |  14  Low battery symbol (temperature station) |
|  5 Second |  15 Temperature trend (indoor) |
|  6 Weekday display |  16  Alarm 1/2 symbol |
|  7 MAX/MIN display (outdoor temperature) |  17 Hour/minute |
|  8 Temperature trend (outdoor) |  18 ZONE time zone symbol |
|  9 Outdoor temperature | |
|  10  Radio signal symbol | |
- 

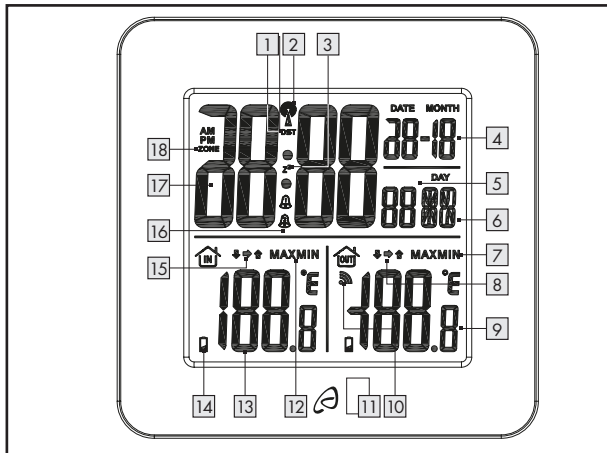



Temperature station

- | | | | |
|----|---|----|----------------------------------|
| 19 | CLOCK button | 24 | SET / RESET button |
| 20 | ALARM button | 25 | Battery compartment |
| 21 | ZZ / (snooze function) / REGISTER button | 26 | Stand |
| 22 | Hanging slot | 27 | Screw (D 0.1 in / 3 mm) |
| 23 | SELECT button | 28 | Wall anchor
(D 0.3 in / 8 mm) |

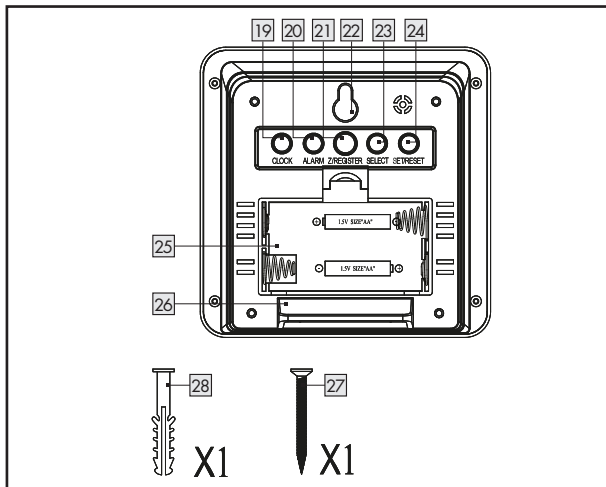

10 US-EN





Outdoor sensor

29 Control LED

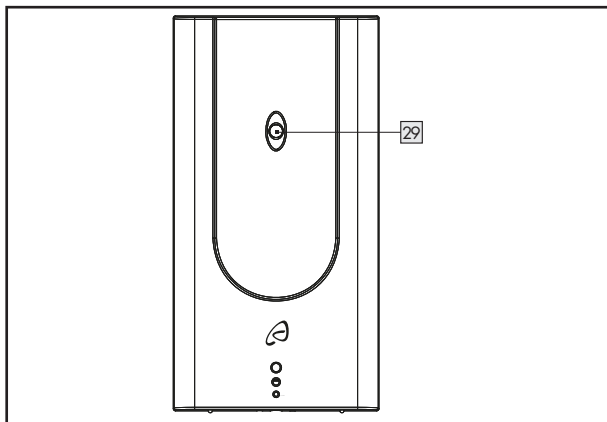

US-EN 11



- 30 Hanging slot
31 Battery compartment
32 Screw (D 0.1 in / 3 mm)
33 Wall anchor (D 0.3 in / 8 mm)

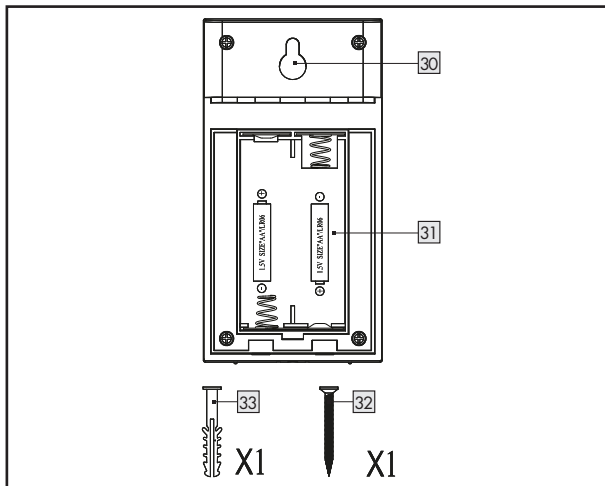

12 US-EN



● Technical data

Temperature station:

Model No.: HG04641A-US-RX/ HG04641B-US-RX

FCCID: 2AJ9O-HG4641RX

Temperature

measurement range: +32 °F to +122 °F
0 °C to +50 °C

Note: If the temperature is ≤ 32 °F (0 °C), the LC display shows "LL.L". If the temperature is ≥ 122 °F (50 °C), the LC display shows "HH.H".

Temperature increment: 0.1 °F/0.1 °C

Radio signal: WWVB

Batteries: 2 x AA 1.5V --- (direct current)

Frequency band: 60 kHz, 433.050MHz to 434.790MHz



Outdoor sensor:

Model No.: HG04641A-US-TX/ HG04641B-US-TX

FCCID: 2AJ9O-HG4641TX

Temperature

measurement range: -4 °F to +140 °F -20 °C to +60 °C



HF transmission signal: 433 MHz
HF transmission range: max. 98.4 ft / 30 meters (in open area)
Batteries: 2 x AA 1.5 V=== (direct current)
Degree of protection: IPX4 (Splash-proof)/suitable for wet locations
Frequency band: 433.050MHz to 434.790MHz
Max. Transmitted power: < 10 dBm



● Contents

1 Temperature station	2 Wall anchors (D 0.3 in / 8 mm)
1 Outdoor sensor	1 Drill template
4 Batteries AA, 1.5 V	1 Set of instructions for use
2 Screws (D 0.1 in / 3 mm)	







IMPORTANT SAFETY NOTES

READ ALL INSTRUCTIONS. KEEP FOR FUTURE REFERENCE.
INCLUDE ALL DOCUMENTATION WHEN PASSING THIS
PRODUCT ON TO OTHERS.

● General safety information

⚠ WARNING Failure to observe the following warnings can result in death or serious injuries.



- This product may be used by children 8 years and older and individuals with physical, sensory or cognitive impairments or lacking experience and knowledge when instructed on safe product use and they understand the associated risks. Do not allow children to play with the product. Never allow children to clean the product or perform user maintenance unsupervised.

- 
- 
- Changes or modifications to this product not expressly approved by the party responsible for compliance could void the user's authority to operate the product.



Note: This product has been tested and found to comply with the limits for a Class B digital device, pursuant to part 15 of the FCC Rules. These limits are designed to provide reasonable protection against harmful interference in a residential installation. This product generates, uses and can radiate radio frequency energy and, if not installed and used in accordance with the instructions, may cause harmful interference to radio communications.

However, there is no guarantee that interference will not occur in a particular installation. If this product causes harmful interference to radio or television reception, which can be determined by turning the product off and on, the user is encouraged to try and correct the interference by one or more of the following measures:

- Reorient or relocate the receiving antenna.
- Increase the separation between the product and receiver.

- 
- 
- Connect the product into an outlet on a circuit different from that to which the receiver is connected.
 - Consult the dealer or an experienced radio/TV technician for help.
 - The RF Exposure Compliance distance is 0.78 in / 20 mm.



NOTICE

- 
- Do not expose the product to an extremely high electromagnetic field. This may impair the correct functioning of the product.
 - Please note that the guarantee does not cover damage caused by incorrect handling, non-compliance with the operating instructions or interference with the product by unauthorized individuals.
- 





Safety warnings for batteries

- When used correctly, cells and batteries provide a safe and dependable source of portable power. However, if they are



misused or abused, this may result in leakage, burns, fire, or explosion.

- Store batteries in a dry place at room temperature. Batteries are sensitive to high and low temperatures. Such thermal exposure may lead to leakage, fire, or explosion.
 - Keep cells and batteries out of reach of children, especially small batteries. Ingestion may lead to choking or acute and serious personal injury.
 - Keep cells or batteries clean and dry both during use and storage. Wipe metal terminals with a soft, dry cloth if they become dirty.
 - Immediately seek medical attention if a cell or battery has been swallowed. Also, contact your local poison control center.
 - In the event that the electrolyte comes into contact with the skin or eyes, immediately flush with fresh water for at least 15 minutes and seek medical attention.
 - Store unused batteries in their original packaging or in safe place and away from metal objects that may short-circuit them.
- 
- 





- Exercise care in handling batteries in order to prevent shorting with conducting materials, such as rings, coins, bracelets, and keys. The battery or the conductor can overheat and cause burns, leakage, fire, or explosion.
- Clean the battery contacts and also those of the product prior to battery installation. Keep the contacts clean.
- Remove batteries from the product that will not be used for an extended period of time (months or longer).
- Remove discharged batteries from product promptly to avoid possible damage from leakage.
- Choose the proper battery for the intended application.
- Always take care to correctly insert batteries observing (+) and (-) polarity marks on the battery and the product for which it is intended. Proper polarity must be observed to avoid damage to either product or batteries.
- Always replace the whole set of batteries at one time, taking care not to mix old and new ones, or batteries of different types, capacities, or manufacturers.
- Never heat batteries in order to revive them.







⚠ WARNING

Never charge a battery unless the battery label specifically states the battery is rechargeable. Charging a non-rechargeable battery, may result in leakage, fire, or explosion.

- Use only the power cord supplied with the product. The use of other cords may result in the batteries inside the product being charged.
 - Do not open or mutilate a battery or cell. Electrolyte from the cell is corrosive and can cause damage to the eyes or skin. The cell contents can also be hazardous if ingested.
 - Do not drop or subject the cell or battery to strong mechanical shock.
 - Batteries should not be disassembled, crushed, punctured, or otherwise mutilated. Such abuses may result in leakage, fire, or explosion.
 - Do not dispose of the battery in a fire. Failure to observe this precaution may result in an explosion.
- 
- 

- 
- 
- Dispose of batteries properly and in accordance with government regulations.

SAVE THESE INSTRUCTIONS



● Before initial use



First activate the batteries inside the outdoor sensor, then inside the temperature station.



Note: Remove all packaging material from the product.

Note: Before initial use, remove the protective film from the LC display.



● General information

NOTICE When choosing where to position the product, make sure that it is not exposed to direct sunlight, vibration, dust, heat, cold or moisture. Do not place the product near heat sources, e.g. radiators, to prevent product damage.

- Please make sure that nearby devices do not use the same frequency of 433 MHz. These types of devices may interfere with the radio connection.
 - Do not place the product next to or on metal plates. Otherwise the quality of radio wave transmission may be reduced.
- 
- 

Radio signal (WWVB):

The WWVB radio signal (time signal transmitter) is made up of time pulses transmitted from one of the highest precision clocks in the world close to Fort Collins, Colorado.



● Preparing to use the outdoor sensor

- Remove the battery cover from the back of the outdoor sensor.
- Insert the included batteries with the correct polarity.
- The outdoor sensor is now ready for use and the control LED 29 illuminates briefly.
- Close the battery cover.



● Preparing the temperature station for use



- Remove the battery cover from the back of the temperature station.
- Insert the included batteries with the correct polarity, the temperature station will “beep”.
- Close the battery cover.

Connecting the temperature station with the outdoor sensor and the WWVB radio signal:



After inserting the batteries, the temperature station will attempt to connect to the outdoor sensor. This process can take a few minutes. The  Radio signal symbol 10 flashes. Once the temperature









station has successfully connected to the outdoor sensor, the  Radio signal symbol  stops flashing and the temperature is shown in the LC display.

Note: If the temperature station does not receive the signal from the outdoor sensor within 3 minutes, the temperature station automatically starts with the reception of the radio time signal.

After successful reception of the outdoor sensor signal or after 3 minutes, the temperature station starts with the reception of the radio time signal. This process can take up to 5 minutes and is indicated in the LC display by the flashing  WWVB symbol .









After successful reception of the WWVB radio signal, the  WWVB symbol  is displayed continuously in the LC display.

Note: Do not move the temperature station while it is receiving the signal. This could otherwise interfere with reception. If synchronization fails during initial set up, try changing the location (e.g. place the temperature station near a window).



Reception may be considerably reduced by obstructions (e.g. concrete walls) or sources of interference (e.g. other electrical devices).

If the reception of the radio signal continues to be interrupted, you can turn on/off the automatic radio time receive function manually.

- 
- 
- Press and hold down the SET / RESET button  for about 3 seconds.  WWVB symbol  is shown in the LC display, the automatic radio time receive function is turned off. Now you can set the time and date manually (see “Setting the language / time zone / time / date manually”).
 - Press and hold down the SET / RESET button  for about 3 seconds again.  WWVB symbol  disappear, the automatic radio time receive function is turned on. The temperature station will start the reception of the radio time during early morning.



Wall-mounting the temperature station and / or the outdoor sensor:

Note: This step requires an electric drill and a crosshead screwdriver.

⚠ WARNING DANGER TO LIFE, RISK OF INJURY AND PROPERTY DAMAGE! Carefully read the instructions for use and safety notes for your drill.

⚠ WARNING DANGER TO LIFE! Be careful that you do not hit electrical, gas or water lines when drilling into the wall. If necessary, check the wall with a wall scanner before drilling.



● **Temperature station**

Note: Before mounting the temperature station, please remove the stand  by simply pulling it off.

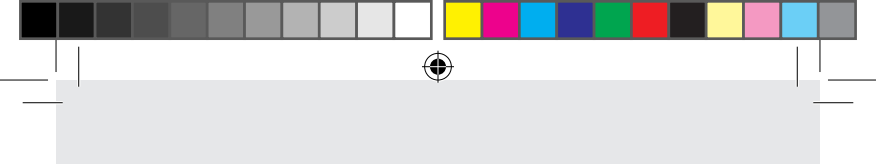

- Mark the location of the hole (D 0.3 in / 8 mm) on the wall.
Note: Use the included drilling template intended for marking the drill holes.
- Drill the hole with an electric drill.

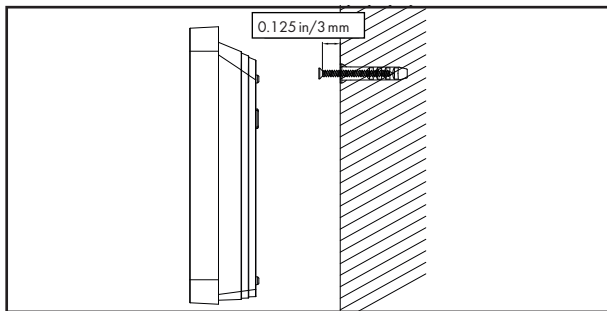
- 
- Push the wall anchor **28** into the drilled hole.
 - Using a crosshead screwdriver, screw the screw **27** into the wall anchor.
 - Hang the temperature station by placing the hanging slot **22** on the screw.





● Outdoor sensor

- Mark the location of the hole (D 0.3 in / 8 mm) on the wall.
Note: Use the included drilling template intended for marking the drill holes.
 - Drill the hole with an electric drill.
 - Push the wall anchor **33** into the drilled hole.
 - Using a crosshead screwdriver, screw the screw **32** into the wall anchor.
 - Hang the outdoor sensor by placing the hanging slot **30** on the screw.
- 
- 

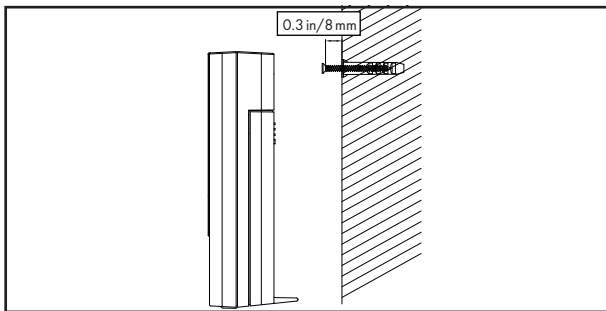



Note: Never immerse the outdoor sensor in water and protect from direct sunlight. Electronic devices may adversely affect the wireless signal reception.



● Setting the language / time zone / time / date manually

The reception of WWVB radio signal where the temperature station has been positioned may become poor or interrupted. If this happens you can set the product manually.



1. Press and hold the CLOCK button  for about 3 seconds.
2. Press the SET / RESET button  to switch between 12- and 24-hour clock mode.
3. Press the CLOCK button to confirm your settings. The language option flashes.



Tip: Press and hold the SET / RESET button to quickly scan the numbers and speed up this process. This quicker method can also be used for the following settings. If no buttons are pressed for 30 seconds, the LC display will automatically return to the standard display.



4. Press the SET / RESET button to set the desired language (GE = German, FR = French, SP = Spanish, IT = Italian, EN = English).
5. Press the CLOCK button to confirm your settings. The time zone display flashes.

- 
- 
6. Press the SET / RESET button to change the time zone (-8 hours to -5 hours).

Note: If you are in a country where the WWVB radio signal can be received but the time differs from your current local time, you can use the time zone setting to have the clock display your current local time. If you are in a country where e.g. the local time is an hour ahead of Pacific Standard Time (PST), set the time zone to -8. The product is now still controlled by WWVB but shows the time as one hour ahead of PST.

- 
7. Press the CLOCK button to confirm your settings. The hour display flashes.
8. Press the SET / RESET button to set the desired value.
9. Press the CLOCK button to confirm your settings.
10. Repeat steps 6 and 7 to set the minute, second, year, month and date.

Note: The seconds can only be reset to 00.

11. Press the SET / RESET button to toggle DST (ON/OFF).
12. Press the CLOCK button to confirm your settings.
13. The LC display will then return to the standard display.
- 







● Daylight saving time



The DST symbol  in the LC display indicates the clock is on daylight saving time.

The temperature station automatically detects DST from the WWVB radio signal.

● Setting the alarm

You can set two different alarm.



- 
- 
1. Press and hold the ALARM button  for about 3 seconds.
Note: If an alarm has already been set, the LC display will show the time the alarm was set to. If not, the display shows **0:00 or AM 12:00**.
 2. The hour display flashes. Press the SET / RESET button  to set the desired value.
 3. Press the ALARM button to confirm your settings. The minute display flashes.
 4. Press the SET / RESET button to set the desired value.



- 
- 
5. Press the ALARM button to confirm your settings.
6. Repeat steps 2 to 5 to set the time for Alarm 2.

● **Displaying the alarms**



- Press ALARM button 20 once or twice to display the setting for Alarm 1 or Alarm 2.
- Press the ALARM button again to return to the standard display.

● **Switching the alarm on/off**



- 
- Press the SET/RESET button 24 once to activate Alarm 1. Press the SET/RESET button twice to activate Alarm 2. Press the SET/RESET button three times to activate Alarm 1 and Alarm 2.
- 

Note: The  /  Alarm 1 / 2 symbol 16 appears in the LC display.

- The alarm sounds at the set time. The alarm automatically stops after 2 minutes.



- 
- 
- Press the SELECT **23**/SET/RESET **24**/ALARM **20**/CLOCK button **19** to stop the alarm manually.
- Note:** The alarm goes off at the set time every day.
- Press the SET/RESET button three times to deactivate Alarm 1. Press the SET/RESET button twice to deactivate Alarm 2. Press the SET/RESET button once to deactivate Alarm 1 and Alarm 2.

● Using the snooze button

- 
- 
- Press the **ZZ**/(snooze function)/REGISTER button **21** while the alarm is going off to snooze the alarm.
- The alarm is silenced and the  Alarm 1/2 symbol **16** will flash along with the **ZZ** snooze function symbol **3**.
- The alarm sounds again after 5 minutes.
- Press the SELECT button **23** to deactivate the snooze function.

● Displaying the temperature

The LC display shows the indoor temperature **13** and the outdoor temperature **9**.

- 
- 
- 
- Press and hold the SELECT button **23** for 3 seconds. The display will flash °F.
 - Press the SET/RESET button **24** to switch between the °C (Celsius) and °F (Fahrenheit) temperature units.
 - Press the SELECT button to confirm your settings.

● **Displaying the minimum / maximum values**





The temperature station stores the maximum and minimum values of the outdoor sensor and of the temperature station itself.





- Press the SELECT button **23** to display the maximum values of the indoor and outdoor temperature.
- Press the SELECT button again to display the minimum values of the indoor and outdoor temperature.
- Press the SET/RESET button **24** while the maximum and minimum values are being displayed to erase the memory.
- Press the SELECT button to return to the standard display.



● Displaying the temperature trends

After successfully connecting with the outdoor sensor, the temperature station can display the temperature trend (outdoor)  and the temperature trend (indoor) .



You may see the following displays:

-  = The temperature is rising.
-  = The temperature is constant.
-  = The temperature is falling.





● Battery indicator



The  low battery symbols ,  appear in the temperature station's LC display if the batteries in the outdoor sensor or the temperature station are weak.

● Replacing the batteries

- Open the battery compartment  or .
- Remove the drained batteries.
- Insert two new 1.5V  (direct current) batteries (AA) into the battery compartments.

Note: Make sure you insert the batteries the correct way (polarity). This is shown in the battery compartment.

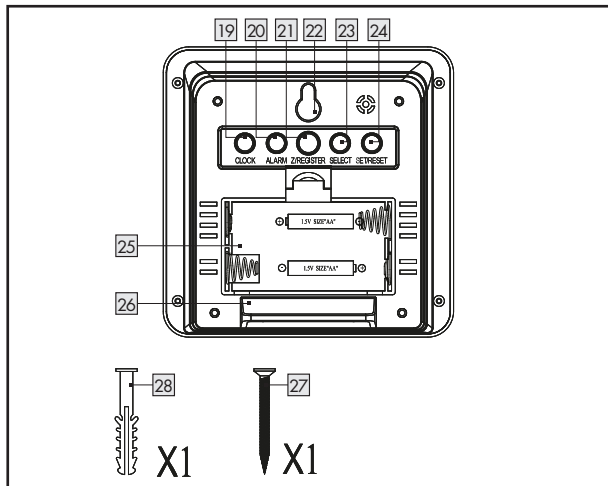

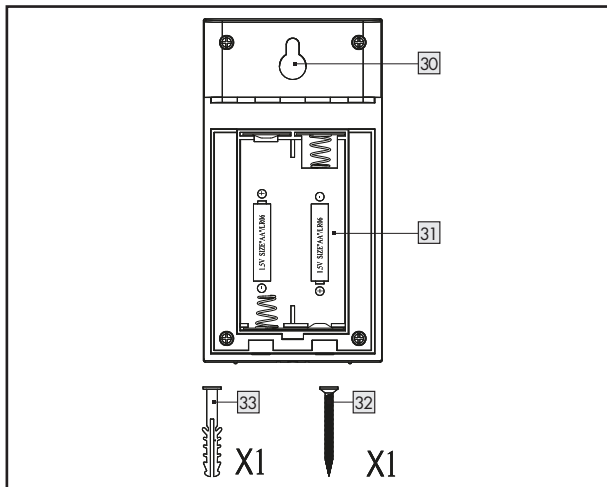



- Close the battery compartments.







● Troubleshooting

Note: This product has delicate electronic components. This means that if it is placed near an object that transmits radio signals, it could cause interference.

- If the display indicates a problem, move such objects away from the temperature station / outdoor sensor or remove the batteries for a short while from the temperature station / outdoor sensor and then replace them.
- 
- 

Obstacles such as concrete walls can also interfere with reception. In this case, change the location (e.g. near a window). Please note, the outdoor sensor should always be set up within max. 98.4 ft / 30 meters (open space) from the temperature station. The specified range is the free-field range and means that no obstacle should be between the outdoor sensor and the temperature station. A “visual contact” between outdoor sensor and temperature station often improves the transmission.



Cold (outdoor temperatures below 32 °F/0 °C) can reduce the battery power of the outdoor sensor and thereby negatively affect radio transmission.

Another factor that may cause harmful interference is dead or weak batteries in the outdoor sensor. Replace them with new ones.

First activate the batteries inside the outdoor sensor, then inside the temperature station.



-> the outdoor sensor will only need to be restarted if problems occur by holding the the **Z^Z** / (snooze function) / REGISTER button **21**, or the temperature station needs to be restarted. To restart the temperature station, briefly remove and reinsert the batteries.



● Cleaning and maintenance

- Only clean the outside of the product using a soft, dry cloth.
- Never spray the outdoor sensor, e.g. with a garden hose. The outdoor sensor is protected against splashing water from all directions.



● Disposal



Dispose of the packaging through your local recycling facilities and in compliance with all federal, state and local regulations.



Please note the package markings regarding waste separation, indicated by abbreviations (a) and numbers (b), meaning: 1–7: plastics / 20–22: paper and cardboard / 80–98: composite materials.



Contact your local waste management authority for additional information on how to dispose of the used product.

To help protect the environment, please dispose of the product properly when it has reached the end of its useful life, do not throw in the garbage. Information on collection sites and their opening hours is available from your local authority.



Improper disposal of batteries can damage the environment!

Never throw batteries in the garbage. They may contain toxic heavy metals and must be handled as special waste. The chemical symbols of heavy metals are: Cd = cadmium, Hg = mercury, Pb = lead. Used batteries should therefore be disposed of through a local collection point.



● Three year limited warranty



What does this warranty cover?

The warranty covers:

- Damage, breakage or inoperability due to defect.
- Damage not caused by normal wear and tear or failure to follow the safety and maintenance instructions provided in the user manual.



What is not covered by the warranty?

The warranty does not cover damage caused by:

- Normal wear and tear of the product, including fragile parts (such as switches, glass, etc.);
- Improper use or transport;
- Disregarding safety and maintenance instructions;
- Accidents or acts of nature (e.g. lightning, fire, water, etc.);
- Tampering with the product (such as removing cover, unscrewing screws etc.)



Consequential and incidental damages are also not covered under this warranty. However, some states do not allow the exclusion or limitation of incidental or consequential damages, so this limitation or exclusion may not apply to you.





What is the period of coverage and warranty resolution?

The warranty is for 3 years from the date of purchase. At our discretion, product will either be refunded or replaced.

What will we not do?

We will not:



- Start a new warranty period upon product exchange;
- Repair product.



How to process the warranty?

To initiate, please:



- Call customer service at 1 (844) 543-5872
 - Visit the Website Customer Service Platform at www.lidl.com/contact-us
- or
- Visit a LIDL store for further assistance
- 



To ensure the quickest warranty return process, please have the following available:

- The original sales receipt that includes the date purchased;
- The product and manual in the original package;
- A statement of the problem.

What must you do to keep the warranty in effect?

- Retain the original receipt;
 - Follow all product instructions;
 - Do not repair or modify the product.
- 
- 

How does state law relate to this warranty?

This warranty gives you specific legal rights, and you may also have other rights which vary from state to state. All implied warranties are limited by the duration and terms of this warranty. Some states do not allow limitations on how long an implied warranty lasts, so the above limitation may not apply to you.