

FCC - TEST REPORT

Report Number : **60.792.21.010.01R01** Date of Issue : January 11, 2022

Model : **HG09055A-US, HG09055B-US**

Product Type : **MAGNETIC CHARGING PAD**

Applicant : Lidl US, LLC

Address : 3500 S Clark Street, ARLINGTON VA 22202, USA

Production Facility : FUJIAN YOUTONG INDUSTRIES CO., LTD

Address : North part of 1st, 2nd-3rd floor, Building 1#, M9511 industries Park, No.18, Majiang Road, Mawei District, Fuzhou City, Fujian, China

Test Result : **Positive** **Negative**

Total pages including Appendices : 24

TÜV SÜD Certification and Testing (China) Co., Ltd. Shenzhen Branch is a subcontractor to TÜV SÜD Product Service GmbH according to the principles outlined in ISO 17025.

TÜV SÜD Certification and Testing (China) Co., Ltd. Shenzhen Branch reports apply only to the specific samples tested under stated test conditions. Construction of the actual test samples has been documented. It is the manufacturer's responsibility to assure that additional production units of this model are manufactured with identical electrical and mechanical components. The manufacturer/importer is responsible to the Competent Authorities in Europe for any modifications made to the production units which result in non-compliance to the relevant regulations. TÜV SÜD Certification and Testing (China) Co., Ltd. Shenzhen Branch shall have no liability for any deductions, inferences or generalizations drawn by the client or others from TÜV SÜD Certification and Testing (China) Co., Ltd. Shenzhen Branch issued reports.

This report is the confidential property of the client. As a mutual protection to our clients, the public and ourselves, extracts from the test report shall not be reproduced except in full without our written approval

1 Table of Contents

1 Table of Contents.....	2
2 Description of Equipment Under Test	3
3 Summary of Test Standards	4
4 Details about the Test Laboratory	5
4.1 Test Equipment Site List	6
4.2 Measurement System Uncertainty	7
5 Summary of Test Results.....	8
6 General Remarks.....	9
7 Test Setups.....	10
7.1 Radiated test setups 9kHz-30MHz.....	10
7.2 Radiated test setups 30MHz-1GHz.....	10
7.3 Radiated test setups Above 1GHz	10
7.4 AC Power Line Conducted Emission test setups	11
7.5 Conducted RF test setups.....	11
8 Emission Test Results	12
8.1 Spurious Radiated Emission	12
8.2 Conducted Emission at AC Power Line.....	15
8.3 20dB Down Bandwidth.....	17
9 Test setup procedure	18
10 Appendix A - General Product Information	22
11 Appendix B - General product information	24

2 Description of Equipment Under Test

Description of the Equipment Under Test

Product: MAGNETIC CHARGING PAD

Model no.: HG09055A-US, HG09055B-US

FCC ID: 2AJ90-HG09055

Rating: Input:5V DC, 2.4A; Output: 5W max.
Input:9V DC, 2.22A, Output 7.5W max

Frequency: 128kHz

Modulation: ASK

Auxiliary Equipment Used during Test:

DESCRIPTION	MANUFACTURER	MODEL NO.	REMARK
AC/DC adapter	Flextronics Sales & Marketing (A-P) Ltd.	G1000-US	Provided by test Lab
Supporting Phone	Apple Inc.	iPhone 12	Provided by test Applicant

Auxiliary Software Used during Test:

DESCRIPTION	SOFTWARE NAME	VERSION	REMARK
/	/	/	/



3 Summary of Test Standards

Test Standards

FCC Part 15 Subpart C 10-1-21 Edition Federal Communications Commission, PART 15 — Radio Frequency Devices, Subpart C — Unintentional Radiators

All the tests were performed using the procedures from ANSI C63.4(2014) and ANSI C63.10 (2013).

4 Details about the Test Laboratory

Site 1

Company name: TÜV SÜD Certification and Testing (China) Co., Ltd. Shenzhen Branch
Building 12&13 Zhiheng Wisdomland Business Park,
Nantou Checkpoint Road 2,
Shenzhen 518052, P.R.China
FCC Registration Number: 514049
ISED test site number: 10320A

Emission Tests	
Test Item	Test Site
FCC Part 15 Subpart C	
FCC Title 47 Part 15.205, 15.209 Spurious Radiated Emission	Site 1
FCC Title 47 Part 15.207 Conduct Emission	Site 1
FCC Title 47 Part 15.215 20dB Down Bandwidth	Site 1

4.1 Test Equipment Site List

Radiated emission Test – Site 1

DESCRIPTION	MANUFACTURER	MODEL NO.	SERIAL NO.	CAL. DUE DATE
EMI Test Receiver	Rohde & Schwarz	ESR 7	102176	2022-6-4
EMI Test Receiver	Rohde & Schwarz	ESR 26	101269	2022-6-4
Loop Antenna	Rohde & Schwarz	HFH2-Z2	100398	2022-8-25
Trilog Super Broadband Test Antenna	Schwarzbeck	VULB 9163	707	2022-7-23
Horn Antenna	Rohde & Schwarz	HF907	102294	2022-6-23
Pre-amplifier	Rohde & Schwarz	SCU 18	102230	2022-6-6
Attenuator	Mini-circuits	UNAT-6+	15542	2022-8-23
3m Semi-anechoic chamber	TDK	SAC-3 #1	----	2023-5-28
Test software	Rohde & Schwarz	EMC32	Version10.35.0 2	N/A

Conducted Emission Test – Site 1

DESCRIPTION	MANUFACTURER	MODEL NO.	SERIAL NO.	CAL. DUE DATE
EMI Test Receiver	Rohde & Schwarz	ESR 3	101782	2022-6-4
LISN	Rohde & Schwarz	ENV4200	100249	2022-6-5
LISN	Rohde & Schwarz	ENV432	101318	2022-6-5
LISN	Rohde & Schwarz	ENV216	100326	2022-6-5
LISN	Rohde & Schwarz	ENV216	102472	2022-6-5
ISN	Rohde & Schwarz	ENY81	100177	2022-6-5
ISN	Rohde & Schwarz	ENY81-CA6	101664	2022-6-5
High Voltage Probe	Schwarzbeck	TK9420(VT9420)	9420-584	2022-6-5
RF Current Probe	Rohde & Schwarz	EZ-17	100816	2022-6-3
Attenuator	Shanghai Huaxiang	TS2-26-3	080928189	N/A
Test software	Rohde & Schwarz	EMC32	Version9.15.00	2022-11-07
Shielding Room	TDK	CSR #1	----	2022-6-4

20dB Down Bandwidth – Site 1

DESCRIPTION	MANUFACTURER	MODEL NO.	SERIAL NO.	CAL. DUE DATE
Signal Analyzer	Rohde & Schwarz	FSV40	101030	2022-6-3
RF Switch Module	Rohde & Schwarz	OSP120/OSP-B157	101226/100851	2022-6-3
10dB Attenuator	Weinschel	4M-10	43152	2022-6-3
10dB Attenuator	R&S	DNF	DNF-001	2022-6-3

4.2 Measurement System Uncertainty

Measurement System Uncertainty Emissions

System Measurement Uncertainty	
Items	Extended Uncertainty
Uncertainty for Radiated Emission in 3m chamber 9kHz-30MHz	4.66dB
Uncertainty for Radiated Emission in 3m chamber 30MHz-1000MHz	Horizontal: 4.68dB; Vertical: 4.65dB;
Uncertainty for Conducted Emission at AC Power Line 150kHz-30MHz	3.31dB
Uncertainty for conducted power test	1.27
Uncertainty for frequency test	0.6×10^{-7}

5 Summary of Test Results

Emission Tests				
FCC Part 15 Subpart C				
Test Condition	Pages	Test Result		
		Pass	Fail	N/A
FCC Title 47 Part 15.205, 15.209 Spurious Radiated Emission	12-14	<input checked="" type="checkbox"/>	<input type="checkbox"/>	<input type="checkbox"/>
FCC Title 47 Part 15.207 Conduct Emission	15-16	<input checked="" type="checkbox"/>	<input type="checkbox"/>	<input type="checkbox"/>
FCC Title 47 Part 15.215 20dB Down Bandwidth	17	<input checked="" type="checkbox"/>	<input type="checkbox"/>	<input type="checkbox"/>

6 General Remarks

Remarks

This submittal(s) (test report) is intended for **FCC ID: 2AJ90-HG09055**, complies with Section 15.205, 15.207, 15.209, 15.215 of the FCC Part 15, Subpart C rules for the DCD grant.

The TX and RX frequency range is 128kHz.

EUT supports two input voltages (5V DC and 9V DC), after pro-test, we find both results have no obvious difference, therefore, all RF test results on this report are based on 9V DC input.

According to applicant's declaration, HG09055A-US and HG09055B-US have the same technical construction including circuit diagram and electrical construction. The difference lies only in the color of the different models. (Applicant's declaration letters are shown at Appendix B)

All the tests were performed on model HG09055A-US.

SUMMARY:

- All tests according to the regulations cited on page 8 were

- Performed

- **Not** Performed

- The Equipment Under Test

- **Fulfills** the general approval requirements.

- **Does not** fulfill the general approval requirements.

Sample Received Date: November 30, 2021

Testing Start Date: December 1, 2021



Testing End Date: December 10, 2021

- TÜV SÜD Certification and Testing (China) Co., Ltd. Shenzhen Branch -

Reviewed by:

Prepared by:

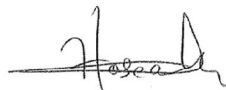
Tested by:



Eric Li
EMC Project Manager

Hosea CHAN
EMC Project Engineer

Louise Liu
EMC Test Engineer

7 Test Setups

7.1 Radiated test setups 9kHz-30MHz

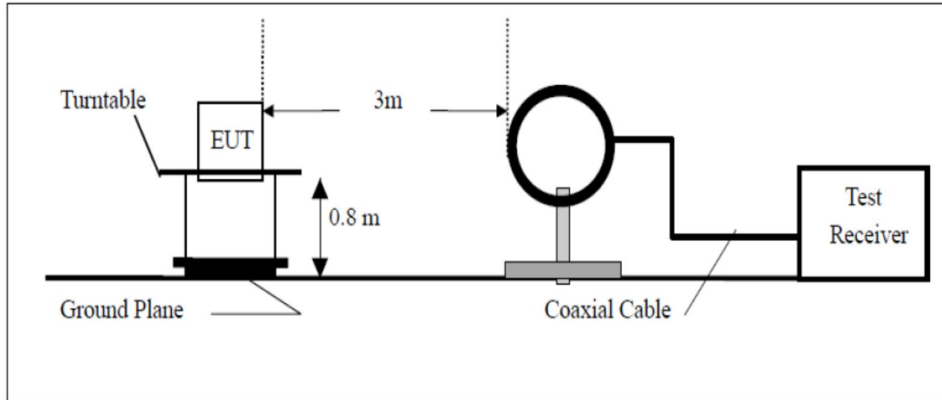

7.2 Radiated test setups 30MHz-1GHz

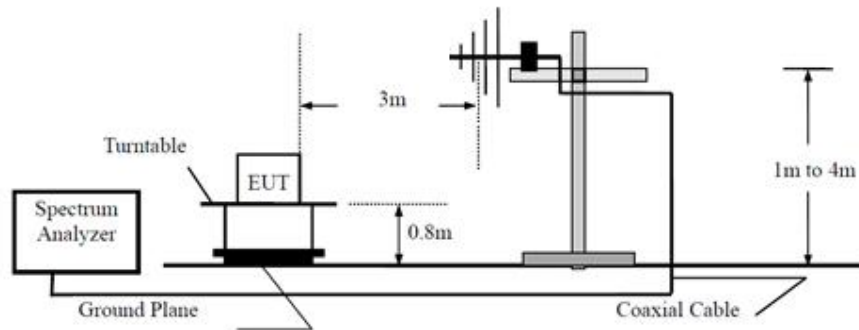

7.3 Radiated test setups Above 1GHz

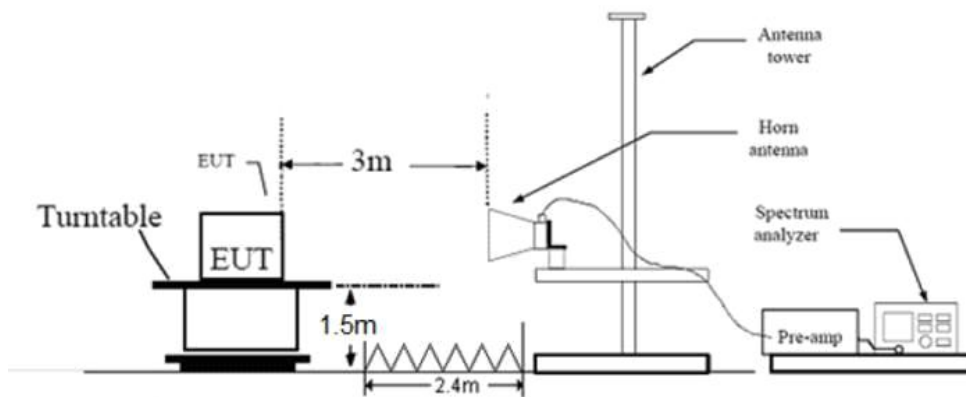

7.4 AC Power Line Conducted Emission test setups

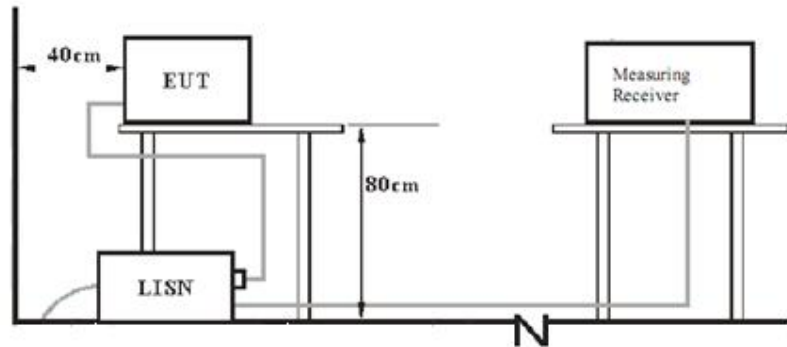

7.5 Conducted RF test setups

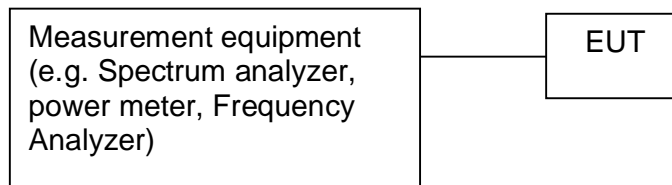

8 Emission Test Results

8.1 Spurious Radiated Emission

EUT: HG09055A-US
 Op Condition: Operated, TX Mode
 Test Specification: FCC15.205, 15.209
 Comment: 120V AC (at the input of AC/DC adapter)
 Remark: 9kHz to 30MHz

Test Result	
<input checked="" type="checkbox"/>	Passed
<input type="checkbox"/>	Not Passed

Frequency MHz	Result dB μ V/m	Limit dB μ V/m	Over Limit dB	Detector PK/QP/AV	Corr. (dB)	RSE. or Fund.
0.033957	49.58	116.97	67.39	Peak	20.13	Spurious emission
0.052381	49.95	113.21	63.26	Peak	20.16	Spurious emission
0.067938	44.70	110.95	66.25	Peak	20.15	Spurious emission
0.101402	43.52	107.48	63.96	Peak	20.14	Spurious emission
0.128000	60.58	105.41	44.83	Peak	20.12	Fundamental
0.135994	39.31	104.93	65.62	Peak	20.12	Spurious emission
0.254475	51.60	99.49	47.88	Peak	20.08	Spurious emission
0.383825	46.96	95.92	48.96	Peak	20.05	Spurious emission
0.468400	51.48	94.19	42.71	Peak	19.98	Spurious emission
0.513175	42.67	73.40	30.73	Peak	19.95	Spurious emission
0.642525	39.98	71.45	31.47	Peak	19.96	Spurious emission
3.493200	35.02	69.50	34.48	Peak	20.14	Spurious emission
6.886150	33.58	69.50	35.92	Peak	20.15	Spurious emission
15.885925	32.40	69.50	37.10	Peak	20.31	Spurious emission

Remark:

- According to C63.10, if the peak measured value complies with the quasi-peak limit, it is unnecessary to perform a quasi-peak measurement, so quasi-peak emission value did not show in data table if the peak value complies with quasi-peak limit.
- Consequence Level=Reading Level + Correction Factor
 Above 1GHz: Corrector factor = Antenna Factor + Cable Loss- Amplifier Gain
 Below 1GHz: Corrector factor = Antenna Factor + Cable Loss
 (The Reading Level is recorded by software which is not shown in the sheet)
- The testing was performed at 3m distance, the limit has been transferred from 300m/30m to 3m.

Spurious Radiated Emission

EUT: HG09055A-US
 Op Condition: Operated, TX Mode
 Test Specification: FCC15.205, 15.209
 Comment: 120V AC (at the input of AC/DC adapter)
 Remark: 30MHz to 1GHz, Antenna: Horizontal

Test Result	
<input checked="" type="checkbox"/>	Passed
<input type="checkbox"/>	Not Passed

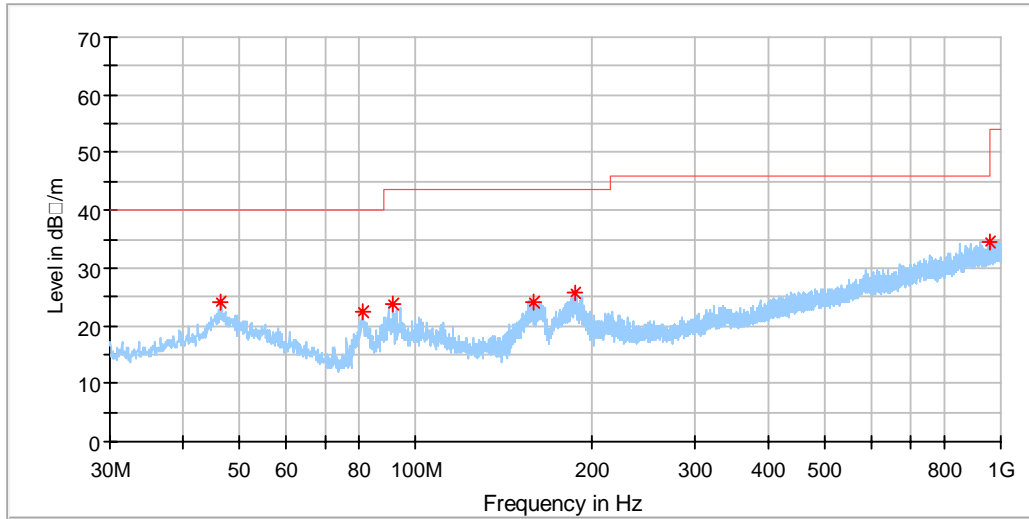

Frequency (MHz)	MaxPeak (dBµV/m)	Limit (dBµV/m)	Margin (dB)	Corr. (dB/m)
46.490000	24.19	40.00	15.81	21.35
81.046250	22.36	40.00	17.64	14.23
91.413125	23.77	43.50	19.73	17.38
159.010000	24.11	43.50	19.39	16.19
187.261250	25.77	43.50	17.73	17.93
958.835625	34.42	46.00	11.58	33.08

Spurious Radiated Emission

EUT: HG09055A-US
 Op Condition: Operated, TX Mode
 Test Specification: FCC15.205, 15.209
 Comment: 120V AC (at the input of AC/DC adapter)
 Remark: 30MHz to 1GHz, Antenna: Vertical

Test Result	
<input checked="" type="checkbox"/>	Passed
<input type="checkbox"/>	Not Passed

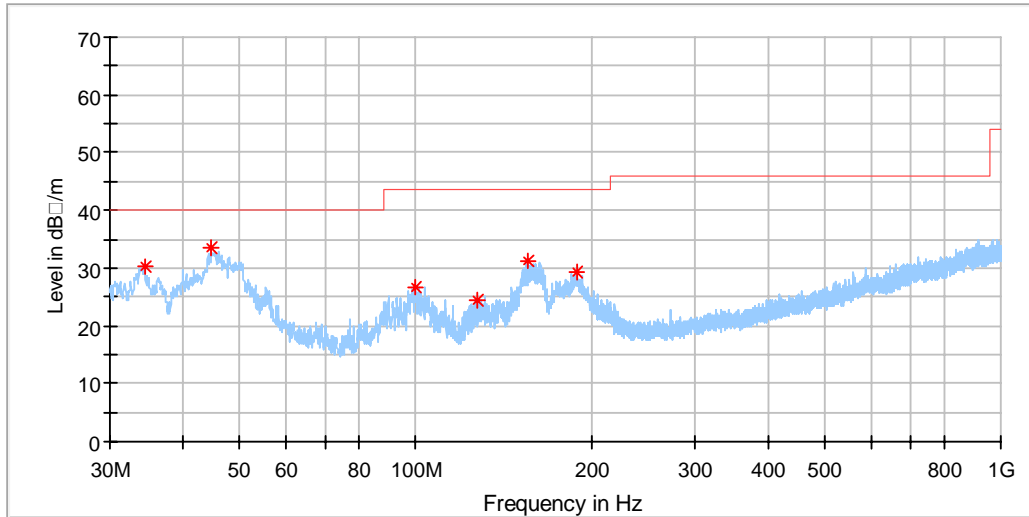

Frequency (MHz)	MaxPeak (dBµV/m)	Limit (dBµV/m)	Margin (dB)	Corr. (dB/m)
34.486250	30.37	40.00	9.63	17.71
44.731875	33.38	40.00	6.62	21.04
99.961250	26.78	43.50	16.72	18.87
127.606250	24.55	43.50	18.95	16.33
156.100000	31.10	43.50	12.40	15.86
188.049375	29.31	43.50	14.19	18.01

8.2 Conducted Emission at AC Power Line

EUT: HG09055A-US
 Op Condition: 128kHz Working and charging battery
 Test Specification: AC Mains, L Line
 Comment: 120V AC, 60Hz (at the input of AC/DC adapter)

Test Result	
<input checked="" type="checkbox"/>	Passed
<input type="checkbox"/>	Not Passed

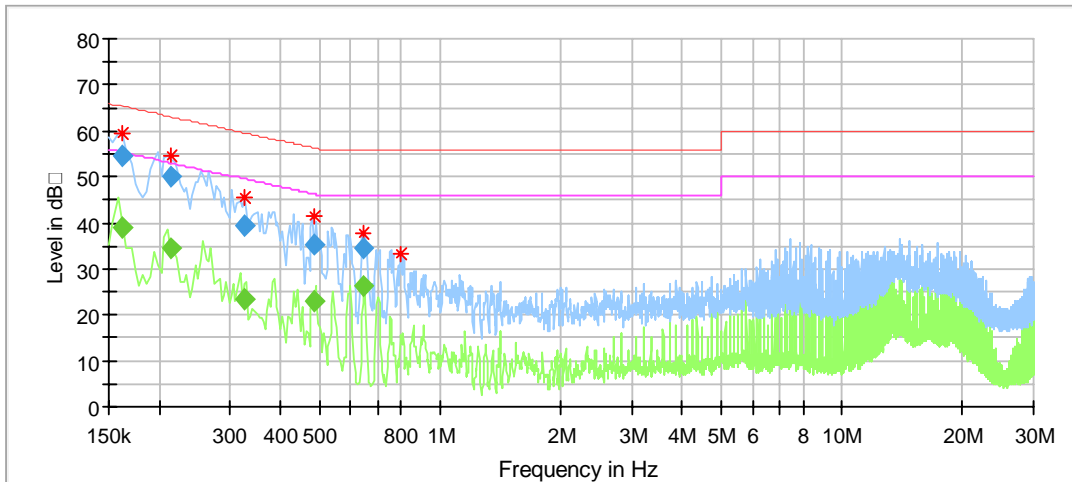

Critical_Freqs

Frequency (MHz)	MaxPeak (dBµV)	Average (dBµV)	Limit (dBµV)	Margin (dB)	Corr. (dB)
0.161500	59.56	---	65.36	5.80	9.26
0.214500	54.75	---	63.21	8.46	9.23
0.325500	45.64	---	59.55	13.91	9.21
0.485500	41.56	---	56.31	14.75	9.20
0.645500	37.80	---	56.00	18.20	9.20
0.802000	33.07	---	56.00	22.93	9.20

Final_Result

Frequency (MHz)	QuasiPeak (dBµV)	Average (dBµV)	Limit (dBµV)	Margin (dB)	Corr. (dB)
0.161500	54.39	---	65.39	10.99	9.26
0.161500	---	38.95	55.39	16.44	9.26
0.214500	50.10	---	63.03	12.93	9.23
0.214500	---	34.55	53.03	18.48	9.23
0.325500	---	23.57	49.57	25.99	9.21
0.325500	39.37	---	59.57	20.19	9.21
0.485500	---	22.77	46.24	23.47	9.20
0.485500	35.24	---	56.24	21.01	9.20
0.645500	---	26.06	46.00	19.94	9.20
0.645500	34.53	---	56.00	21.47	9.20

Conducted Emission Test

EUT: HG09055A-US
 Op Condition: 128kHz Working and charging battery
 Test Specification: AC Mains, N Line
 Comment: 120V AC, 60Hz (at the input of AC/DC adapter)

Test Result	
<input checked="" type="checkbox"/>	Passed
<input type="checkbox"/>	Not Passed

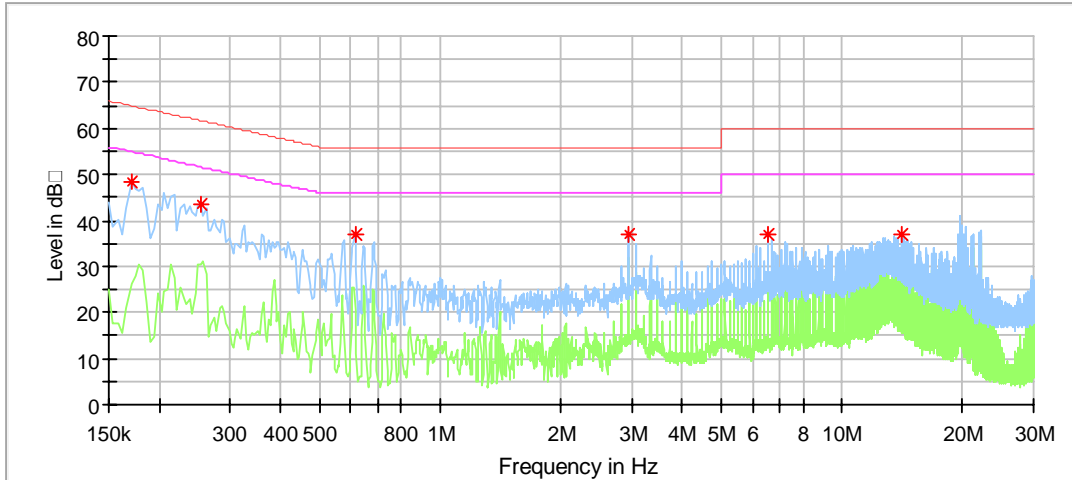

Frequency (MHz)	MaxPeak (dBµV)	Average (dBµV)	Limit (dBµV)	Margin (dB)	Corr. (dB)
0.170000	48.50	---	64.96	16.46	9.40
0.254000	43.57	---	61.63	18.06	9.39
0.614000	36.88	---	56.00	19.12	9.39
2.954000	36.95	---	56.00	19.05	9.44
6.546000	37.00	---	60.00	23.00	9.55
14.118000	36.73	---	60.00	23.27	9.62

8.3 20dB Down Bandwidth

EUT: HG09055A-US
 Op Condition: Operated, TX Mode
 Test Specification: FCC15.215, 20dB Bandwidth
 Comment: 120V AC (at the input of AC/DC adapter)

Test Result	
<input checked="" type="checkbox"/>	Passed
<input type="checkbox"/>	Not Passed

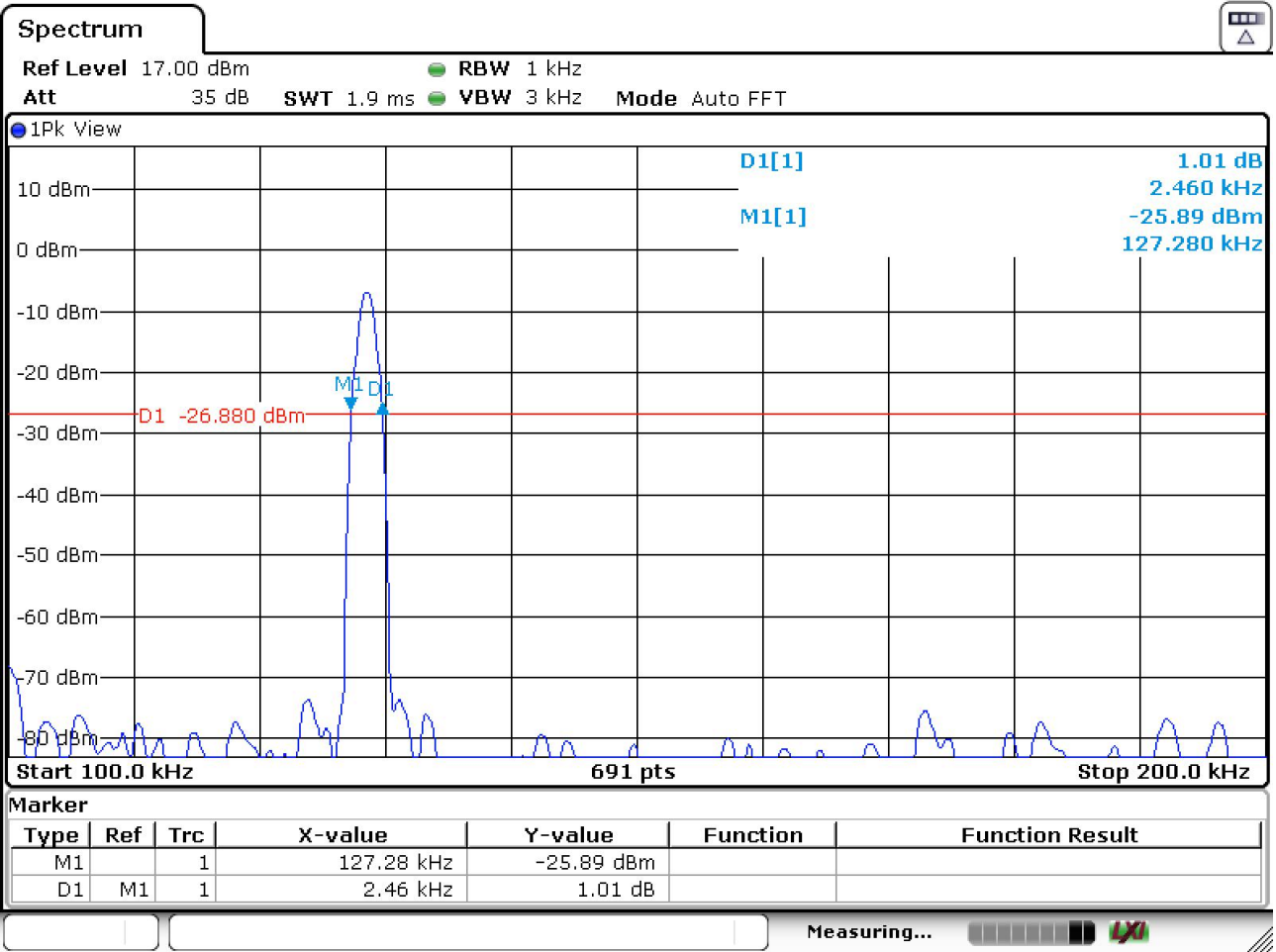

Date: 8.DEC.2021 16:47:37

Bandwidth	Measured Value
20dB bandwidth	2.5 kHz

9 Test setup procedure

9.1 Field strength of emissions and Restricted bands

Test Method

- 1: The EUT was placed on a turn table which is 1.5m above ground plane for above 1GHz and 0.8m above ground for below 1GHz at 3-meter chamber room for test. The table was rotated 360 degrees to determine the position of the highest radiation.
- 2: The EUT was set 3 meters away from the interference – receiving antenna, which was mounted on the top of a variable – height antenna tower.
- 3: The height of antenna is varied from one meter to four meters above the ground to determine the maximum value of the field strength. Both horizontal and vertical polarizations of the antenna are set to make the measurement.
- 4: For each suspected emission, the EUT was arranged to its worst case and then the antenna was tuned to heights from 1 meter to 4 meters and the rotatable table was turned from 0 degrees to 360 degrees to find the maximum reading.
- 5: Use the following spectrum analyzer settings According to C63.10:

For Above 1GHz

Span = wide enough to capture the peak level of the in-band emission and all spurious
RBW = 1MHz, VBW \geq 3RBW, Sweep = auto, Detector function = peak and average,
Trace = max hold.

For Below 1GHz

Use the following spectrum analyzer settings:

Span = wide enough to capture the peak level of the in-band emission and all spurious
RBW = 120KHz, VBW \geq 3RBW, Sweep = auto, Detector function = QP,
Trace = max hold.

Field strength of emissions and Restricted bands

Limits

According to §15.209 (a), the field strength of emissions from intentional radiators shall not exceed the field strength levels specified in the following table:

Fundamental frequency (MHz)	Field strength (microvolts/meter)	Field strength of harmonics (microvolts/meter)
0.009-0.490	2400/F(kHz)	300
0.490-1.705	24000/F(kHz)	30
1.705-30.0	30	30
30-88	100	3
88-216	150	3
216-960	200	3
Above 960	500	3

9.2 Conducted Emission at AC Power line

Test Method

1. The EUT was placed on a table, which is 0.8m above ground plane
2. The power line of the EUT is connected to the AC mains through a Artificial Mains Network (A.M.N.).
3. Maximum procedure was performed to ensure EUT compliance
4. A EMI test receiver is used to test the emissions from both sides of AC line

Limit

Frequency MHz	QP Limit dB μ V	AV Limit dB μ V
0.150-0.500	66-56*	56-46*
0.500-5	56	46
5-30	60	50

*Decreasing linearly with logarithm of the frequency.

9.3 20dB Down Bandwidth

Test Method

1. Check the calibration of the measuring instrument using either an internal calibrator or a known signal from an external generator.
2. Position the EUT without connection to spectrum analyser. Turn on the EUT and connect it to measurement instrument. Then set it to any one convenient frequency within its operating range. Set a reference level on the measuring instrument equal to the highest peak value.
3. Measure the frequency difference of two frequencies that were attenuated 20dB from the reference level. Record the frequency difference as the emission bandwidth.

Limits:

According to 15.215 (c) Intentional radiators operating under the alternative provisions to the general emission limits, as contained in §§ 15.217 through 15.257 and in Subpart E of this part, must be designed to ensure that the 20 dB bandwidth of the emission, or whatever bandwidth may otherwise be specified in the specific rule section under which the equipment operates, is contained within the frequency band designated in the rule section under which the equipment is operated. The requirement to contain the designated bandwidth of the emission within the specified frequency band includes the effects from frequency sweeping, frequency hopping and other modulation techniques that may be employed as well as the frequency stability of the transmitter over expected variations in temperature and supply voltage. If a frequency stability is not specified in the regulations, it is recommended that the fundamental emission be kept within at least the central 80% of the permitted band in order to minimize the possibility of out-of-band operation.

10 Appendix A - General Product Information

Radiofrequency radiation exposure evaluation

This exposure evaluation is intended for **FCC ID: 2AJ90-HG09055**

According to KDB 447498 D01v06 section 4.3.1, For frequencies below 100 MHz and test separation distances ≤ 50 mm, the Numeric threshold is determined as:

Step a)

$[(\text{max. power of channel, including tune-up tolerance, mW}) / (\text{min. test separation distance, mm})] \cdot [\sqrt{f(\text{GHz})}] \leq 3.0$
for 1-g SAR

Step b)

$\{[\text{Power allowed at numeric threshold for 50mm in step a)}] + [(\text{test separation distance} - 50\text{mm}) \cdot (f(\text{MHz})/150)]\}$
mW

Step c) 1)

For test separation distances $> 50\text{mm}$ and $< 200\text{mm}$, the power threshold at the corresponding test separation distance at 100MHz in step b) is multiplied by $[1 + \log(100/f(\text{MHz}))]$

Step c) 2)

For test separation distances $\leq 50\text{mm}$, the power threshold determined by the equation in c) 1) for 50mm and 100MHz is multiplied by $\frac{1}{2}$.

>> The fundamental frequency of the EUT is 128kHz, the test separation distance is $\leq 50\text{mm}$.
(Manufacturer specified the separation distance is: 20mm)

Step a)

>> Numeric threshold, $\text{mW} / 50\text{mm} \cdot \sqrt{0.1\text{GHz}} \leq 3.0$
Numeric threshold $\leq 474.3\text{mW}$

Step b)

>> Numeric threshold $\leq 474.3\text{mW} + (50\text{mm} - 50\text{mm}) \cdot 100\text{MHz}/150$
Numeric threshold $\leq 474.3\text{mW}$

Step c) 1) & c) 2)

>> Numeric threshold $\leq 474.3\text{mW} \cdot [1 + \log 100/100\text{MHz}] \cdot \frac{1}{2}$
Numeric threshold $\leq 237.15\text{mW}$

>> The power (calculated power + tune up tolerance) of EUT at 128kHz is: 0.0003mW
Which is smaller than the Numeric threshold.
Therefore, the device is exempt from stand-alone SAR test requirements.

Appendix A

Power calculation (According to C63.10 chapter 9.5)

	Value	Unit
Field Strength Measured (E)	60.58	dB μ V/m
Measurement Distance (D)	3	m
Equivalent Isotropically Radiated Power (E.I.R.P in dBm)	-34.58	dBm
Equivalent Isotropically Radiated Power (E.I.R.P in mW)	0.0003	mW

Remark: $EIRP = E + 20\log(D) - 104.7$
 (EIRP is in dBm, E is in dB μ V/m, D is in meters)

Reviewed by:

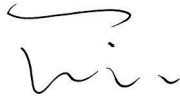

Eric LI
EMC Project Manager

Prepared by:

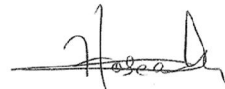
Hosea CHAN
EMC Project Engineer

11 Appendix B - General product information

DECLARATION LETTER OF MODEL DIFFERENCE

To: TÜV SÜD Hong Kong Limited

Attention: Eric Li

From: Meagan McNamee

Date: December 1, 2021

Fax No: N/A

Total Page (Cover Included): 1

Project No.:

Subject: **Declaration letter**

We: LIDL US LLC
3500 S Clark Street, ARLINGTON VA 22202, USA

Officially notify TÜV SÜD Hong Kong Limited that the <<HG09055B-US>> have the same technical construction including circuit diagram, PCB Layout, components and component layout, all electrical construction and mechanical construction, with <<Magnetic charging pad>>. <<HG09055A-US>> The difference lies only in the color of the different models.

<<Model A>>: **HG09055A-US**

<<Model B>>: **HG09055B-US**

<<Product>>: **MAGNETIC CHARGING PAD**

Applicant:

MCNAMEEME



2021.12.03

09:42:25 -05'00'

(Date)

(Applicant's authorized signature and company Chop)



Digitally signed

by SULLIVANE

Date: 2021.12.01

12:34:00 -05'00'