

# FCC RADIO TEST REPORT

The device described below is tested by Dongguan Nore Testing Center Co., Ltd. to determine the maximum emission levels emanating from the device, the severe levels which the device can endure and E.U.T.'s performance criterion. The test results, data evaluation, test procedures, and equipment of configurations shown in this report were made in accordance with the procedures in ANSI C63.10(2013).

Applicant : Shenzhen Oceantech Electronics Co., Ltd  
Address : Baoan Zhigu Science and Technology Park, Yintian Road, Xixiang Street, Bao'an District, Shenzhen, Guangdong, China  
Manufacturer / Factory : Shenzhen Oceantech Electronics Co., Ltd  
Address : Baoan Zhigu Science and Technology Park, Yintian Road, Xixiang Street, Bao'an District, Shenzhen, Guangdong, China  
E.U.T. : Bluetooth Speaker  
Model No. : OS-528, UZ-S045B  
Brand Name : N/A  
FCC ID : 2AJ5Q-OS528  
Measurement Standard : FCC PART 15.247  
Date of Receiver : October 08, 2019  
Date of Test : October 09, 2019 to October 28, 2019  
Date of Report : October 29, 2019

This Test Report is Issued Under the Authority of :

Prepared by



Evan Yang / Engineer

Approved & Authorized Signer



Iori Fan / Authorized Signatory

This test report is for the customer shown above and their specific product only. This report applies to above tested sample only and shall not be reproduced in part without written approval of Dongguan Nore Testing Center Co., Ltd.

## Table of Contents

<b>1. GENERAL INFORMATION .....</b>	<b>5</b>
1.1 PRODUCT DESCRIPTION FOR EQUIPMENT UNDER TEST .....	5
1.2 RELATED SUBMITTAL(S) / GRANT (S) .....	7
1.3 TEST METHODOLOGY .....	7
1.4 EQUIPMENT MODIFICATIONS .....	7
1.5 SUPPORT DEVICE .....	7
1.6 TEST FACILITY AND LOCATION .....	8
1.7 SUMMARY OF TEST RESULTS .....	9
<b>2. SYSTEM TEST CONFIGURATION .....</b>	<b>10</b>
2.1 EUT CONFIGURATION .....	10
2.2 SPECIAL ACCESSORIES .....	10
2.3 DESCRIPTION OF TEST MODES .....	10
<b>3. FREQUENCY HOPPING SYSTEM REQUIREMENTS .....</b>	<b>11</b>
3.1 STANDARD AND LIMIT .....	11
3.2 EUT PSEUDORANDOM FREQUENCY HOPPING SEQUENCE .....	11
3.3 FREQUENCY HOPPING SYSTEM .....	12
<b>4. AC POWER LINE CONDUCTED EMISSIONS .....</b>	<b>13</b>
4.1 TEST SET-UP (BLOCK DIAGRAM OF CONFIGURATION) .....	13
4.2 TEST CONDITION .....	13
4.3 MEASUREMENT RESULTS .....	13
<b>5. RADIATED EMISSION .....</b>	<b>16</b>
5.1 TEST SET-UP (BLOCK DIAGRAM OF CONFIGURATION) .....	16
5.2 MEASUREMENT PROCEDURE .....	17
5.3 LIMIT .....	18
5.4 MEASUREMENT RESULTS .....	18
<b>6. CHANNEL SEPARATION .....</b>	<b>22</b>
6.1 MEASUREMENT PROCEDURE .....	22
6.2 LIMIT .....	22
6.3 TEST SET-UP (BLOCK DIAGRAM OF CONFIGURATION) .....	22
6.4 MEASUREMENT RESULTS .....	22
<b>7. 20DB BANDWIDTH .....</b>	<b>26</b>
7.1 MEASUREMENT PROCEDURE .....	26
7.2 TEST SET-UP (BLOCK DIAGRAM OF CONFIGURATION) .....	26
7.3 MEASUREMENT RESULTS .....	26
<b>8. HOPPING CHANNEL NUMBER .....</b>	<b>30</b>

---

8.1 MEASUREMENT PROCEDURE .....	30
8.2 LIMIT .....	30
8.3 TEST SET-UP (BLOCK DIAGRAM OF CONFIGURATION) .....	30
8.4 MEASUREMENT RESULTS.....	30
<b>9. TIME OF OCCUPANCY (DWELL TIME) .....</b>	<b>32</b>
9.1 MEASUREMENT PROCEDURE .....	32
9.2 LIMIT .....	32
9.3 TEST SET-UP (BLOCK DIAGRAM OF CONFIGURATION) .....	32
9.4 MEASUREMENT RESULTS.....	32
<b>10. MAXIMUM PEAK OUTPUT POWER .....</b>	<b>36</b>
10.1 MEASUREMENT PROCEDURE .....	36
10.2 LIMIT .....	36
10.3 TEST SET-UP (BLOCK DIAGRAM OF CONFIGURATION) .....	36
10.4 MEASUREMENT RESULTS.....	36
<b>11. BAND EDGE.....</b>	<b>40</b>
11.1 MEASUREMENT PROCEDURE .....	40
11.2 LIMIT .....	40
11.3 MEASUREMENT RESULTS.....	40
<b>12. ANTENNA APPLICATION.....</b>	<b>49</b>
12.1 ANTENNA REQUIREMENT .....	49
12.2 MEASUREMENT RESULTS.....	49
<b>13. CONDUCTED SPURIOUS EMISSIONS.....</b>	<b>50</b>
13.1 MEASUREMENT PROCEDURE .....	50
13.2 LIMIT .....	50
13.3 TEST SET-UP (BLOCK DIAGRAM OF CONFIGURATION) .....	50
13.4 MEASUREMENT RESULTS.....	50
<b>14. TEST EQUIPMENT LIST.....</b>	<b>54</b>



## 1. GENERAL INFORMATION

### 1.1 Product Description for Equipment under Test

Product Name : Bluetooth Speaker

Model No. : OS-528, UZ-S045B

Model difference : We hereby state that these models are identical in interior structure, electrical circuits and components, just model name is different. Therefore only model OS-528 is for tests.

E.U.T. Type : Class B

Rating : DC 5V from USB Port  
DC 3.7V from built-in battery

**Technical Specification:**

BT Function

Version : V5.0 (BR/EDR)

Frequency Range : 2402-2480MHz

Modulation Type : GFSK,  $\pi/4$ -DQPSK

Number of Channel : 79

Channel Space : 1MHz

Antenna Type : PCB Antenna

Antenna Gain : -0.58dBi

### Bluetooth Channel List

Channel	Frequency (MHz)	Channel	Frequency (MHz)	Channel	Frequency (MHz)	Channel	Frequency (MHz)
0	2402	20	2422	40	2442	60	2462
1	2403	21	2423	41	2443	61	2463
2	2404	22	2424	42	2444	62	2464
3	2405	23	2425	43	2445	63	2465
4	2406	24	2426	44	2446	64	2466
5	2407	25	2427	45	2447	65	2467
6	2408	26	2428	46	2448	66	2468
7	2409	27	2429	47	2449	67	2469
8	2410	28	2430	48	2450	68	2470
9	2411	29	2431	49	2451	69	2471
10	2412	30	2432	50	2452	70	2472
11	2413	31	2433	51	2453	71	2473
12	2414	32	2434	52	2454	72	2474
13	2415	33	2435	53	2455	73	2475
14	2416	34	2436	54	2456	74	2476
15	2417	35	2437	55	2457	75	2477
16	2418	36	2438	56	2458	76	2478
17	2419	37	2439	57	2459	77	2479
18	2420	38	2440	58	2460	78	2480
19	2421	39	2441	59	2461		

**Note:** According to section 15.31(m), regards to the operating frequency range over 10MHz, the Lowest, middle, and the Highest frequency of channel were selected to perform the test. The selected frequency and test software see below:

Channel	Frequency (MHz)
0	2402
39	2441
78	2480

## 1.2 Related Submittal(s) / Grant (s)

This submittal(s) (test report) is intended for **FCC ID: 2AJ5Q-OS528** filing to comply with Section 15.247 of the FCC Part 15, Subpart C Rule.

## 1.3 Test Methodology

Both AC mains line-conducted and radiated emission measurements were performed according to the procedures in ANSI C63.10 (2013). Radiated emission measurement was performed in semi-anechoic chamber and conducted emission measurement was performed in shield room. For radiated emission measurement, preliminary scans were performed in the semi-anechoic chamber only to determine the worst case modes. All radiated tests were performed at an antenna to EUT distance of 3 meters.

## 1.4 Equipment Modifications

Not available for this EUT intended for grant.

## 1.5 Support Device

Description	Manufacturer	Model	S/N
AC/DC Adapter	SAMSUNG	ETA-U90CBC	RT4F629wS/B-E

Note: The adapter is used for ac power line conducted emission tests

## 1.6 Test Facility and Location

### Site Description

- EMC Lab : Listed by CNAS, August 13, 2018  
The certificate is valid until August 13, 2024  
The Laboratory has been assessed and proved to be in compliance with CNAS/CL01  
The Certificate Registration Number is L5795.
- Listed by A2LA, November 01, 2017  
The certificate is valid until December 31, 2019  
The Laboratory has been assessed and proved to be in compliance with ISO17025  
The Certificate Registration Number is 4429.01
- Listed by FCC, November 06, 2017  
The Designation Number is CN1214  
Test Firm Registration Number: 907417
- Listed by Industry Canada, June 08, 2017  
The Certificate Registration Number. Is 46405-9743
- Name of Firm : Dongguan Nore Testing Center Co., Ltd.  
(Dongguan NTC Co., Ltd.)
- Site Location : Building D, Gaosheng Science and Technology Park, Hongtu Road, Nancheng District, Dongguan City, Guangdong Province, China



### 1.7 Summary of Test Results

FCC Rules	Description Of Test	Uncertainty	Result
§15.207 (a)	AC Power Line Conducted Emission	±1.06dB	Compliant
§15.247(d),§15.209, §15.205	Radiated Emission	±3.70dB	Compliant
§15.247(a)(1)	Channel Separation	±1.42 x10 <sup>-4</sup> %	Compliant
§15.247(a)(1)	20dB Bandwidth	±1.42 x10 <sup>-4</sup> %	Compliant
§15.247(a)(1)(iii)	Hopping Channel Number	±1.42 x10 <sup>-4</sup> %	Compliant
§15.247(a)(1)(iii)	Time of Occupancy (Dwell Time)	±5%	Compliant
§15.247(b)	Max Peak Output Power	±1.06dB	Compliant
§15.247(d)	Band Edge	±1.70dB	Compliant
§15.203	Antenna Requirement	N/A	Compliant
§15.247(d)	Conducted Spurious Emission	±1.70dB	Compliant

## 2. SYSTEM TEST CONFIGURATION

### 2.1 EUT Configuration

The EUT configuration for testing is installed on RF field strength measurement to meet the Commissions requirement and operating in a manner which intends to maximize its emission characteristics in a continuous normal application.

### 2.2 Special Accessories

Not available for this EUT intended for grant.

### 2.3 Description of test modes

The EUT has been tested under operating condition. Test program used to control the EUT for staying in continuous transmitting and normal mode is programmed. The Lowest, middle and highest channel were chosen for testing, and all packets DH1, DH3, DH5, 2-DH1, 2-DH3, 2-DH5 mode in all modulation type GFSK,  $\pi/4$ -DQPSK were tested.

The EUT was operated in the engineering mode to fix the Tx frequency that was for the purpose of the measurements.

Test Item	Software	Description
Conducted RF Testing and Radiated testing	FCCAssist 2.4	Set the EUT to different modulation and channel

Output power setting table:

Test Mode	Set Tx Output Power Level	Data rate
GFSK	10	DH1
$\pi/4$ -DQPSK	10	2-DH1

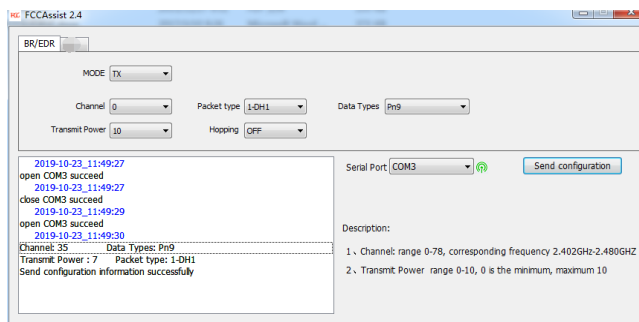

### 3. FREQUENCY HOPPING SYSTEM REQUIREMENTS

#### 3.1 Standard and Limit

According to FCC Part 15.247(a)(1), The system shall hop to channel frequencies that are selected at the system hopping rate from a pseudo randomly ordered list of hopping frequencies. Each frequency must be used equally on the average by each transmitter. The system receivers shall have input bandwidths that match the hopping channel bandwidths of their corresponding transmitters and shall shift frequencies in synchronization with the transmitted signals.

(g) Frequency hopping spread spectrum systems are not required to employ all available hopping channels during each transmission. However, the system, consisting of both the transmitter and the receiver, must be designed to comply with all of the regulations in this section should the transmitter be presented with a continuous data (or information) stream. In addition, a system employing short transmission bursts must comply with the definition of a frequency hopping system and must distribute its transmissions over the minimum number of hopping channels specified in this section.

(h) The incorporation of intelligence within a frequency hopping spread spectrum system that permits the system to recognize other users within the spectrum band so that it individually and independently chooses and adapts its hop sets to avoid hopping on occupied channels is permitted. The coordination of frequency hopping systems in any other manner for the express purpose of avoiding the simultaneous occupancy of individual hopping frequencies by multiple transmitters is not permitted.

#### 3.2 EUT Pseudorandom Frequency Hopping Sequence

Pseudorandom Frequency Hopping Sequence Table as below:

Channel: 08, 24, 40, 56, 34, 51, 72, 09, 01, 64, 22, 33, 41, 32, 47, 65, 73, 53, 69, 06, 17, 04, 20, 36, 52, 38, 66, 70, 78, 68, 76, 21, 29, 10, 26, 49, 00, 58, 44, 59, 75, 13, 03, 14, 11, 35, 43, 37, 50, 61, 77, 55, 71, 02, 23, 07, 27, 39, 54, 46, 48, 15, 63, 62, 67, 25, 31, 12, 28, 19, 60, 42, 57, 74, 16, 05, 18, 30, 45, etc.

The system receiving have input bandwidths that match the hopping channel bandwidths of their corresponding transmitters and shift frequencies in synchronization with the transmitted signals.

### 3.3 Frequency Hopping System

This transmitter device is frequency hopping device, and complies with FCC part 15.247 rule.

This device uses Bluetooth radio which operates in 2400-2483.5 MHz band. Bluetooth uses a radio technology called frequency-hopping spread spectrum, which chops up the data being sent and transmits chunks of it on up to 79 bands (1 MHz each; centred from 2402 to 2480 MHz) in the range 2,400-2,483.5MHz. The transmitter switches hop frequencies 1,600 times per second to assure a high degree of data security. All Bluetooth devices participating in a given piconet are synchronized to the frequency-hopping channel for the piconet. The frequency hopping sequence is determined by the master's device address and the phase of the hopping sequence (the frequency to hop at a specific time) is determined by the master's internal clock. Therefore, all slaves in a piconet must know the master's device address and must synchronize their clocks with the master's clock.

Adaptive Frequency Hopping (AFH) was introduced in the Bluetooth specification to provide an effective way for a Bluetooth radio to counteract normal interference. AFH identifies "bad" channels, where either other wireless devices are interfering with the Bluetooth signal or the Bluetooth signal is interfering with another device. The AFH-enabled Bluetooth device will then communicate with other devices within its piconet to share details of any identified bad channels. The devices will then switch to alternative available "good" channels, away from the areas of interference, thus having no impact on the bandwidth used.

This device was tested with a bluetooth system receiver to check that the device maintained hopping synchronization, and the device complied with these requirements FCC Part 15.247 rule.



E.U.T:	Bluetooth Speaker	Phase:	Line
Model No.:	OS-528	Temperature:	25 °C
Test Mode:	BT Communication	Humidity:	64 %
Test Voltage:	AC 120V/60Hz	Test By:	Sance
Test Results:	PASS		

Test Time: 2019-10-24 9:39:08

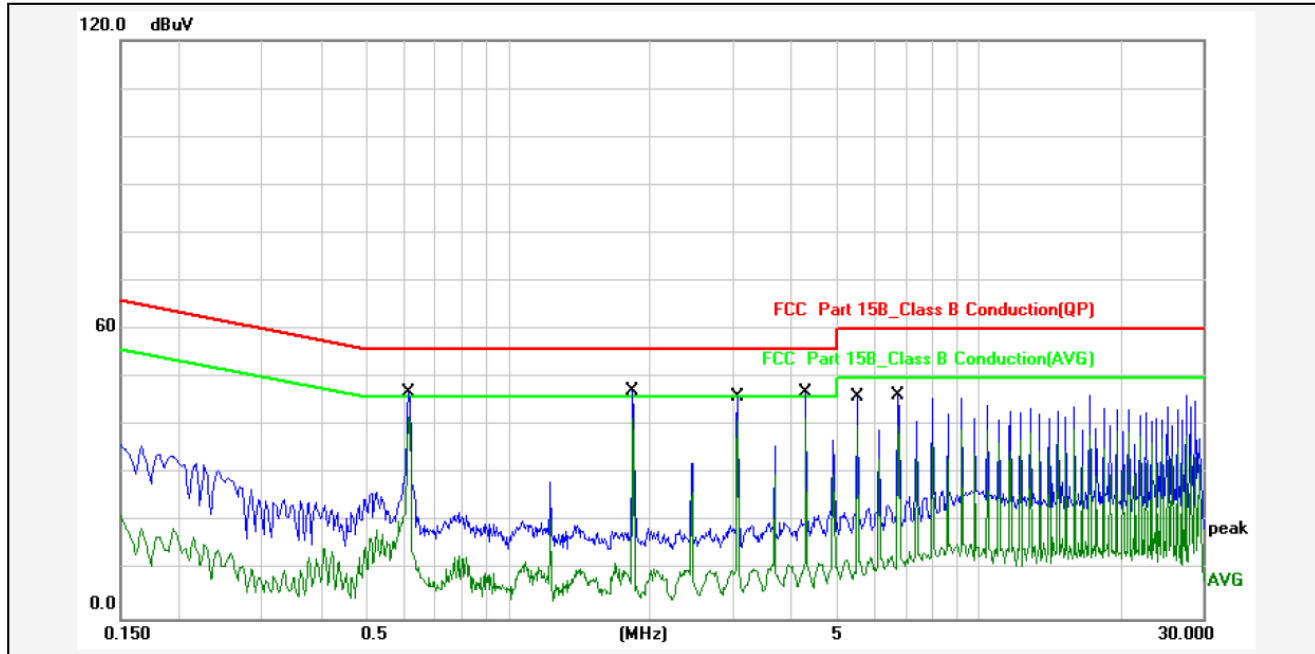

No.	Frequency (MHz)	Factor (dB)	Reading (dBuV)	Level (dBuV)	Limit (dBuV)	Margin (dB)	Detector	P/F	Remark
1	0.6140	6.61	40.28	46.89	56.00	-9.11	QP	P	
2	0.6140	6.61	35.30	41.91	46.00	-4.09	AVG	P	
3	1.8460	6.58	40.78	47.36	56.00	-8.64	QP	P	
4	1.8460	6.58	35.05	41.63	46.00	-4.37	AVG	P	
5	3.0780	6.56	39.60	46.16	56.00	-9.84	QP	P	
6	3.0780	6.56	34.77	41.33	46.00	-4.67	AVG	P	
7	4.3060	6.55	40.54	47.09	56.00	-8.91	QP	P	
8	4.3060	6.55	34.92	41.47	46.00	-4.53	AVG	P	
9	5.5380	6.58	39.51	46.09	60.00	-13.91	QP	P	
10	5.5380	6.58	33.55	40.13	50.00	-9.87	AVG	P	
11	6.7660	6.58	39.82	46.40	60.00	-13.60	QP	P	
12	6.7660	6.58	33.52	40.10	50.00	-9.90	AVG	P	

E.U.T:	BLUETOOTH SPEAKER	Phase:	Neutral
Model No.:	OS-528	Temperature:	25 °C
Test Mode:	BT Communication	Humidity:	64 %
Test Voltage:	AC 120V/60Hz	Test By:	Sance
Test Results:	PASS		

Test Time: 2019-10-24 9:36:43

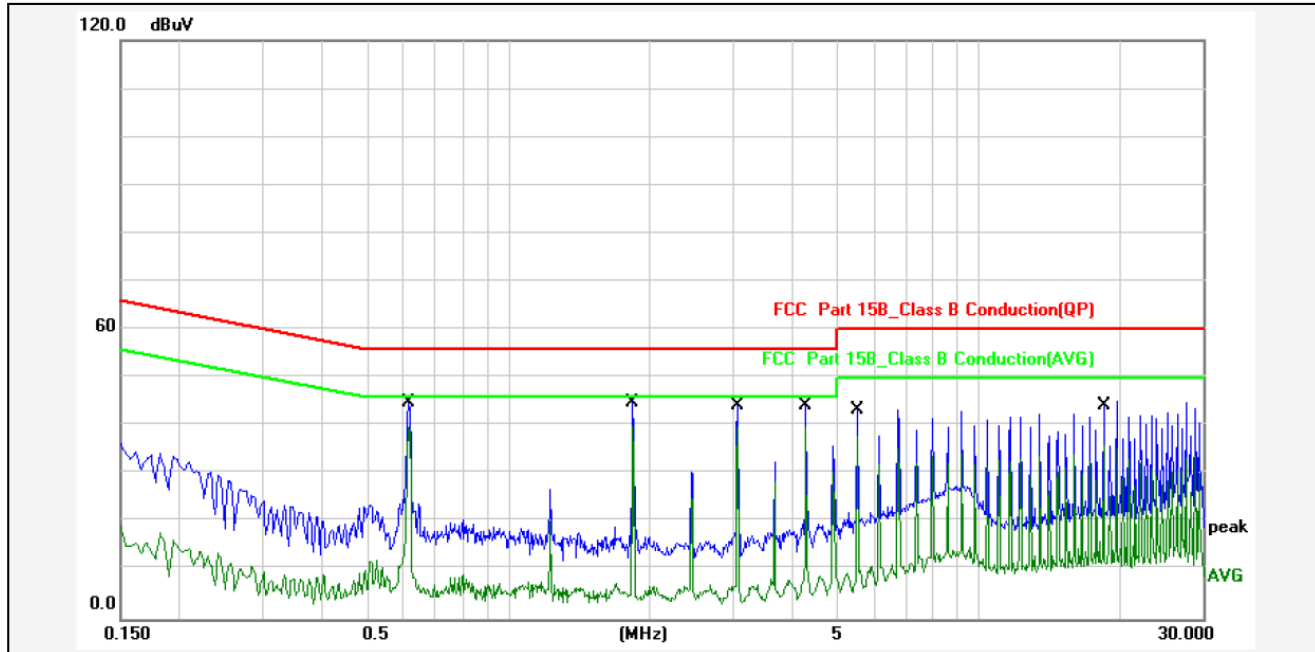

No.	Frequency (MHz)	Factor (dB)	Reading (dBuV)	Level (dBuV)	Limit (dBuV)	Margin (dB)	Detector	P/F	Remark
1	0.6140	6.61	38.31	44.92	56.00	-11.08	QP	P	
2	0.6140	6.61	33.27	39.88	46.00	-6.12	AVG	P	
3	1.8460	6.58	38.39	44.97	56.00	-11.03	QP	P	
4	1.8460	6.58	33.53	40.11	46.00	-5.89	AVG	P	
5	3.0740	6.56	37.58	44.14	56.00	-11.86	QP	P	
6	3.0740	6.56	33.08	39.64	46.00	-6.36	AVG	P	
7	4.3060	6.55	37.65	44.20	56.00	-11.80	QP	P	
8	4.3060	6.55	33.08	39.63	46.00	-6.37	AVG	P	
9	5.5340	6.58	36.75	43.33	60.00	-16.67	QP	P	
10	5.5340	6.58	31.38	37.96	50.00	-12.04	AVG	P	
11	18.4500	6.67	37.63	44.30	60.00	-15.70	QP	P	
12	18.4500	6.67	29.33	36.00	50.00	-14.00	AVG	P	

## 5. RADIATED EMISSION

### 5.1 Test SET-UP (Block Diagram of Configuration)

#### 5.1.1 Radiated Emission Test Set-Up, Frequency below 30MHz

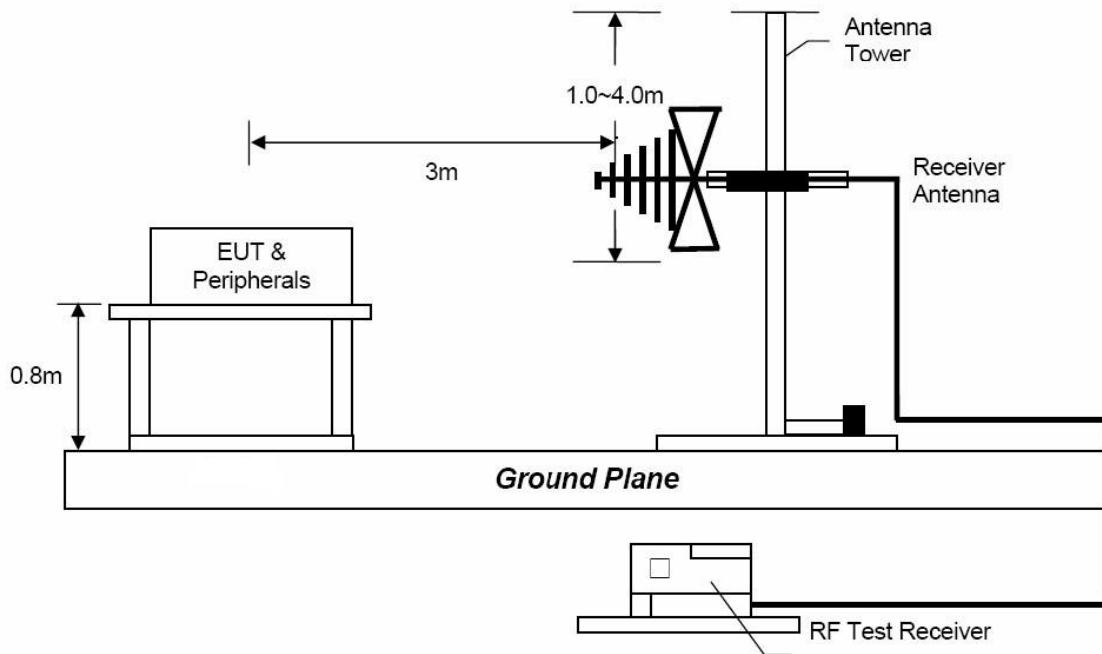
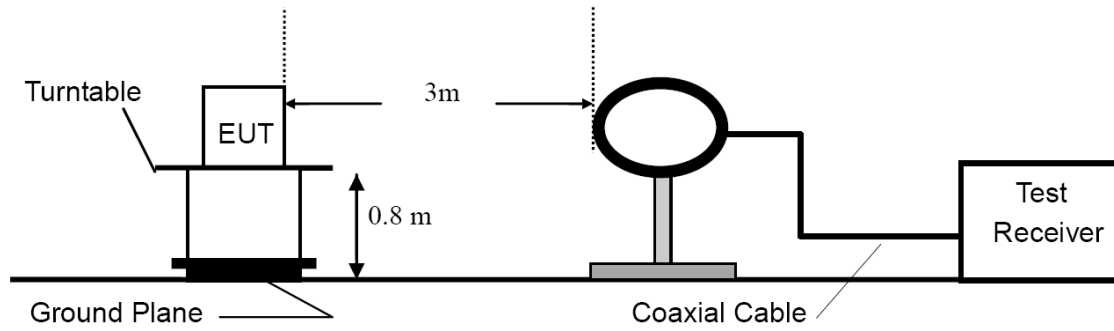



### 5.1.2 Radiated Emission Test Set-Up, Frequency above 1GHz

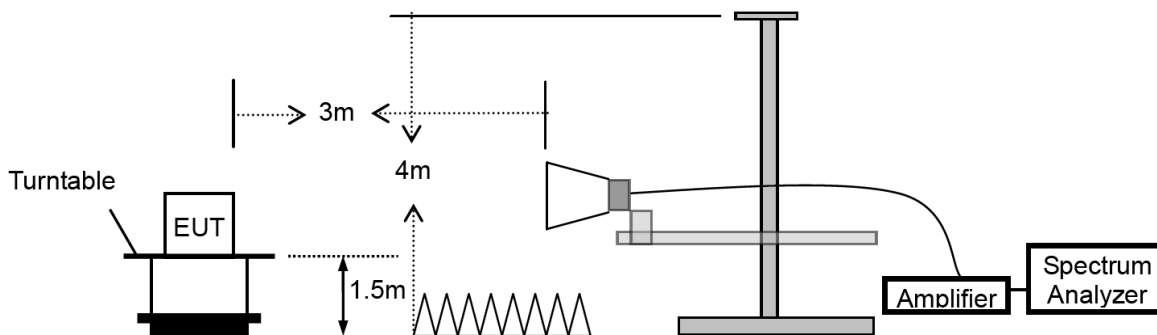

## 5.2 Measurement Procedure

- a. Blow 1GHz, the EUT was placed on the top of a rotating table 0.8 meters above the ground at a 3 meter semi- anechoic chamber room.
- b. For the radiated emission test above 1GHz:  
The EUT was placed on the top of a rotating table 1.5 meters above the ground at a 3 meter full anechoic chamber room. The table was rotated 360 degrees to determine the position of the highest radiation. Place the measurement antenna away from each area of the EUT determined to be a source of emissions at the specified measurement distance, while keeping the measurement antenna aimed at the source of emissions at each frequency of significant emissions, with polarization oriented for maximum response. The measurement antenna may have to be higher or lower than the EUT, depending on the radiation pattern of the emission and staying aimed at the emission source for receiving the maximum signal. The final measurement antenna elevation shall be that which maximizes the emissions. The measurement antenna elevation for maximum emissions shall be restricted to a range of heights of from 1 m to 4 m above the ground or reference ground plane.
- c. The EUT was set 3 meters away from the interference-receiving antenna, which was mounted on the top of a variable-height antenna tower.
- d. The height of antenna is varied from one meter to four meters above the ground to determine the maximum value of the field strength. Both horizontal and vertical polarizations of the antenna are set to make the measurement.
- e. For each suspected emission, the EUT was arranged to its worst case and then the antenna was tuned to heights from 1 meter to 4 meters and the rotatable table was turned from 0 degrees to 360 degrees to find the maximum reading. The test-receiver system was set to peak detect function and specified bandwidth with maximum hold mode.
- f. A Quasi-peak measurement was then made for that frequency point for below 1GHz test. PK and AV for above 1GHz emission test.

During the radiated emission test, the spectrum analyzer was set with the following configurations:

Frequency Band (MHz)	Level	Resolution Bandwidth	Video Bandwidth
30 to 1000	QP	120 kHz	300 kHz
Above 1000	Peak	1 MHz	3 MHz
	Average	1 MHz	If $D \geq 98$ then $VBW \geq 3 * RBW$ , If $D \leq 98$ then $VBW \geq 1/T$

### 5.3 Limit

Frequency range MHz	Distance Meters	Field Strengths Limit (15.209)
		$\mu V/m$
0.009 ~ 0.490	300	$2400/F(\text{kHz})$
0.490 ~ 1.705	30	$24000/F(\text{kHz})$
1.705 ~ 30	30	30
30 ~ 88	3	100
88 ~ 216	3	150
216 ~ 960	3	200
Above 960	3	500

- Remark :
- (1) Emission level (dB) $\mu V = 20 \log$  Emission level  $\mu V/m$
  - (2) The smaller limit shall apply at the cross point between two frequency bands.
  - (3) As shown in 15.35(b), for frequencies above 1000MHz, the field strength limits are based on average detector, however, the peak field strength of any emission shall not exceed the maximum permitted average limits, specified above by more than 20dB under any condition of modulation.
  - (4) The frequency range scanned is from the lowest radio frequency signal generated in the device which is greater than 9 kHz to the tenth harmonic of the highest fundamental frequency or 40 GHz, whichever is lower.

### 5.4 Measurement Results

Please refer to following plots of the worst case:  $\pi/4$ -DQPSK Low channel.

Note: Below 30MHz, the emissions are lower than 20dB below the allowable limit. Therefore, 9kHz-30MHz data were not recorded.

E.U.T:	Bluetooth Speaker	Polarization:	Horizontal
Model No.:	OS-528	Temperature:	25 °C
Test Mode:	TX 2402 (π/4-DQPSK)	Humidity:	64 %
Frequency Range:	30MHz-1GHz	Test By:	Sance
Test Distance:	3m	Test Voltage:	DC 3.7V
Test Results:	PASS	Test Date:	October 16, 2019

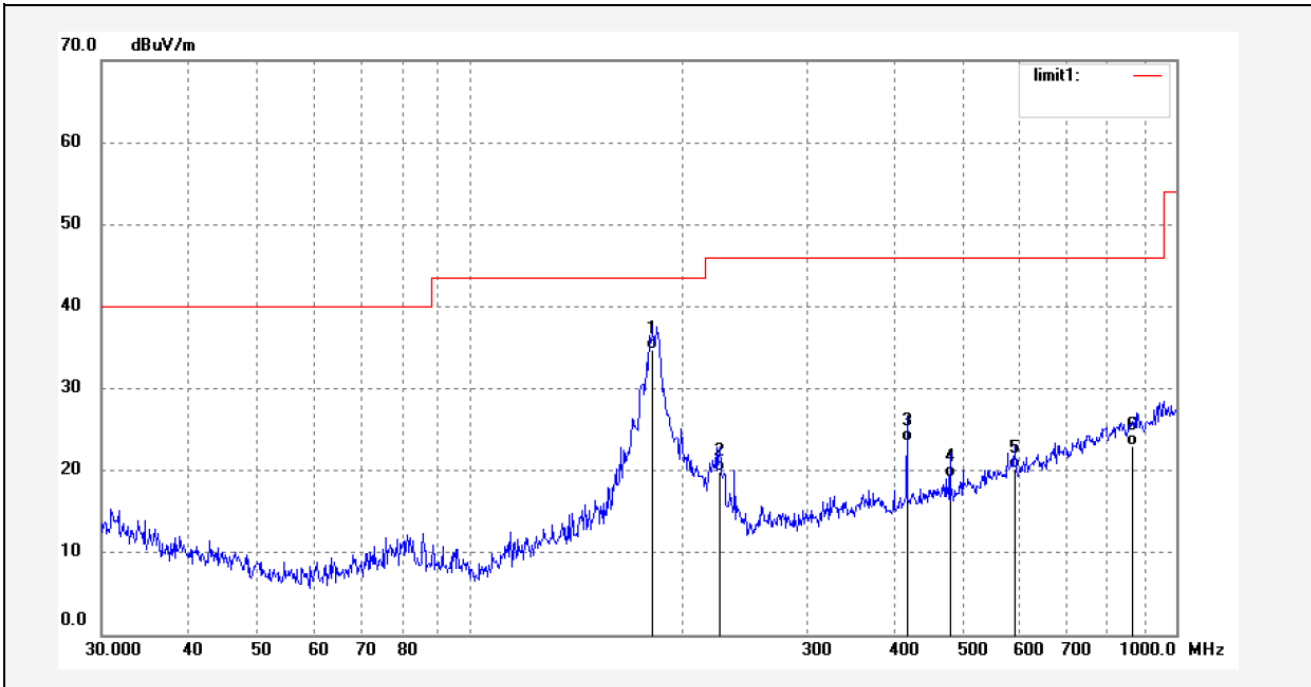

No.	Freq. (MHz)	Reading (dBuV/m)	Factor (dB)	Result (dBuV/m)	Limit (dBuV/m)	Margin (dB)	Detector	Height (cm)	Degree (deg.)	Remark
1	181.3000	60.69	-25.89	34.80	43.50	-8.70	QP	200	103	
2	225.4267	43.73	-23.93	19.80	46.00	-26.20	QP	200	156	
3	415.4485	41.65	-18.05	23.60	46.00	-22.40	QP	200	196	
4	478.1394	35.85	-16.65	19.20	46.00	-26.80	QP	200	202	
5	590.3509	34.08	-13.88	20.20	46.00	-25.80	QP	200	275	
6	868.8858	30.72	-7.72	23.00	46.00	-23.00	QP	200	302	

E.U.T:	BLUETOOTH SPEAKER	Polarization:	Vertical
Model No.:	OS-528	Temperature:	25 °C
Test Mode:	TX 2402 (π/4-DQPSK)	Humidity:	64 %
Frequency Range:	30MHz-1GHz	Test By:	Sance
Test Distance:	3m	Test Voltage	DC 3.7V
Test Results:	PASS	Test Date:	October 16, 2019

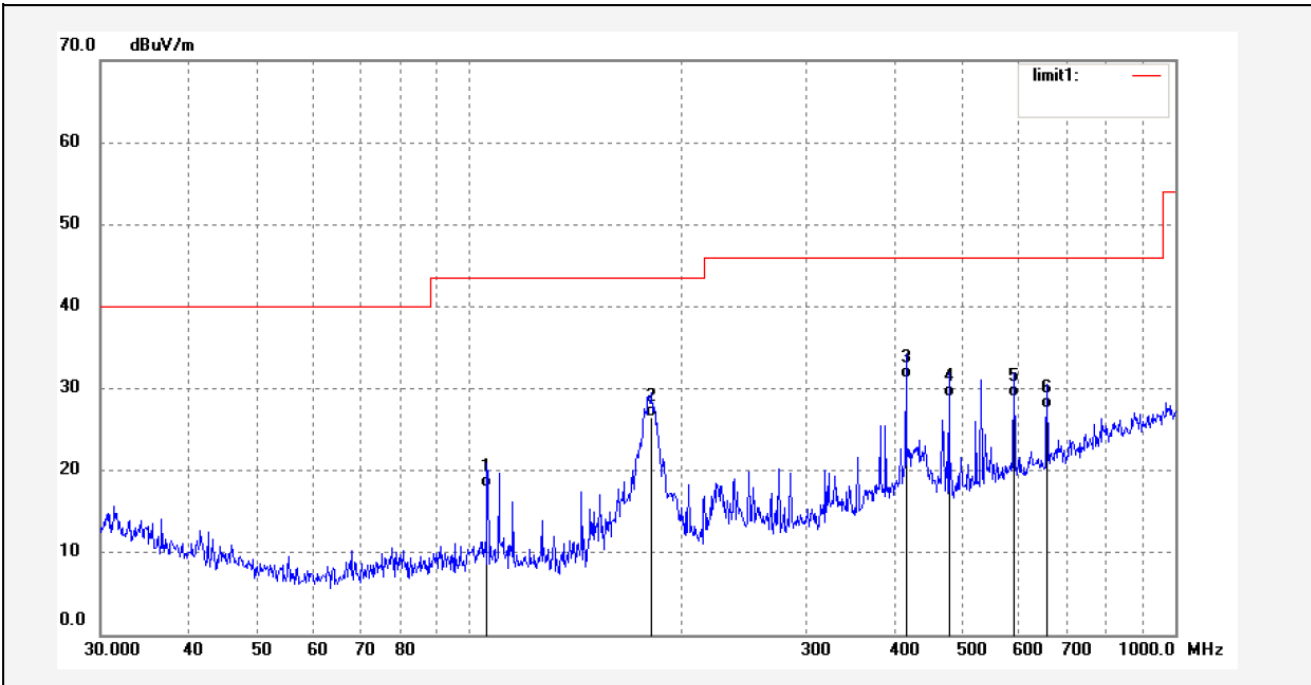

No.	Freq. (MHz)	Reading (dBuV/m)	Factor (dB)	Result (dBuV/m)	Limit (dBuV/m)	Margin (dB)	Detector	Height (cm)	Degree (deg.)	Remark
1	105.9084	45.99	-27.99	18.00	43.50	-25.50	QP	100	102	
2	181.3000	52.39	-25.89	26.50	43.50	-17.00	QP	100	146	
3	415.4486	49.25	-18.05	31.20	46.00	-14.80	QP	100	186	
4	478.1394	45.55	-16.65	28.90	46.00	-17.10	QP	100	202	
5	590.3510	42.88	-13.88	29.00	46.00	-17.00	QP	100	286	
6	658.2854	40.04	-12.44	27.60	46.00	-18.40	QP	100	315	

E.U.T:	Bluetooth Speaker	Temperature:	25 °C
Model No.:	OS-528	Humidity:	64 %
Modulation:	$\pi/4$ -DQPSK (the worst case)	Test By:	Sance
Frequency Range:	1-25GHz	Test Voltage	DC 3.7V
Test Distance:	3m	Test Date:	October 16, 2019
Test Results:	PASS		

Freq. (MHz)	Ant. Pol. (H/V)	Reading Level(dBuV)		Factor (dB/m)	Emission Level (dBuV)		Limit @3m (dBuV/m)		Margin (dB)	
		PK	AV		PK	AV	PK	AV	PK	AV
<b>Operation Mode: TX 2402MHz</b>										
4804	H	44.92	35.14	7.40	52.32	42.54	74.00	54.00	-21.68	-11.46
---										
---										
4804	V	44.35	34.22	7.40	51.65	41.62	74.00	54.00	-22.35	-12.38
---										
---										
<b>Operation Mode: TX 2441MHz</b>										
4882	H	43.96	33.83	8.17	52.13	42.00	74.00	54.00	-21.87	-12.00
---										
---										
4882	V	44.69	34.57	8.17	52.86	42.74	74.00	54.00	-21.14	-11.26
---										
---										
<b>Operation Mode: TX 2480MHz</b>										
4960	H	44.41	35.05	8.58	52.99	43.63	74.00	54.00	-21.01	-10.37
---										
---										
4960	V	43.71	34.66	8.58	52.29	43.24	74.00	54.00	-21.71	-10.76
---										
---										

**Other harmonics emissions are lower than 20dB below the allowable limit.**

- Note:** (1) All Readings are Peak Value and AV.  
 (2) Emission Level= Reading Level + Factor  
 (3) Factor= Antenna Gain + Cable Loss – Amplifier Gain  
 (4) Data of measurement within this frequency range shown “---” in the table above means the reading of emissions are attenuated more than 20dB below the permissible limits, therefore, than 20 dB below the limit do no reported.  
 (5) Measurement uncertainty:  $\pm 3.7$ dB.  
 (6) Horn antenna used for the emission over 1000MHz.

## 6. CHANNEL SEPARATION

### 6.1 Measurement Procedure

Minimum Hopping Channel Carrier Frequency Separation, FCC Rule 15.247(a)(1):

Connect EUT antenna terminal to the spectrum analyzer with a low loss cable, and using the Marker and Max-Hold function to record the separation of two adjacent channels.

### 6.2 Limit

Frequency hopping systems shall have hopping channel carrier frequencies separated by a minimum of 25 kHz or the 20 dB bandwidth of the hopping channel, whichever is greater. Alternatively, frequency hopping systems operating in the 2400-2483.5 MHz band may have hopping channel carrier frequencies that are separated by 25 kHz or two-thirds of the 20 dB bandwidth of the hopping channel, whichever is greater.

### 6.3 Test SET-UP (Block Diagram of Configuration)

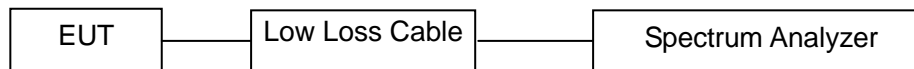

### 6.4 Measurement Results

RBW:	30kHz	Temperature:	24 °C
VBW:	100kHz	Humidity:	50 %
Spectrum Detector:	PK	Test By:	Sance
Packet:	DH1, 2DH1 (Worst case)	Test Date:	October 25, 2019
Test Result:	PASS		

Channel	Test Frequency (MHz)	Separation Read Value (kHz)	Separation Limit 2/3 20dB Bandwidth (kHz)
<b>GFSK</b>			
Lowest	2402	992.0	>584.0
Middle	2441	1002	>588.0
Highest	2480	1002	>584.0
<b><math>\pi/4</math>-DQPSK</b>			
Lowest	2402	1002	>820.0
Middle	2441	1002	>820.0
Highest	2480	996.0	>820.0

### GFSK Lowest Channel

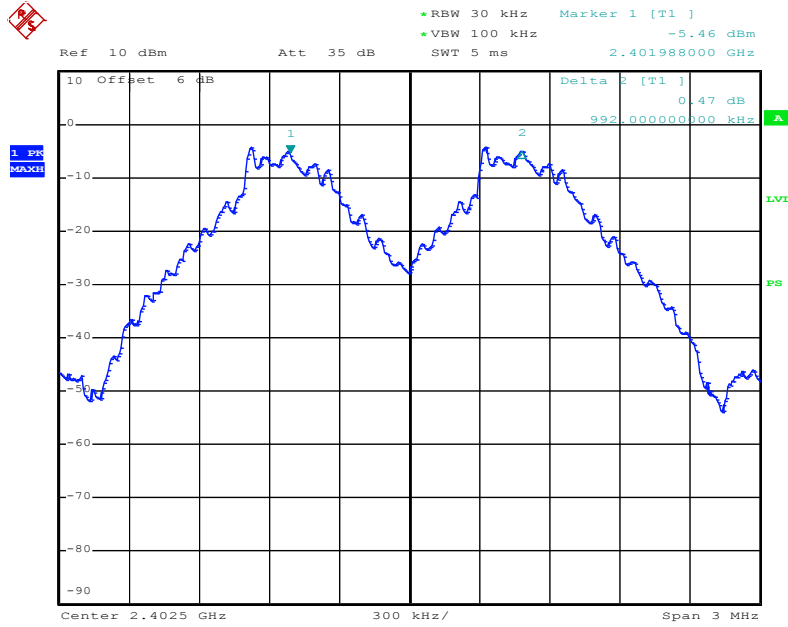

Date: 25.OCT.2019 16:26:13

### GFSK Middle Channel

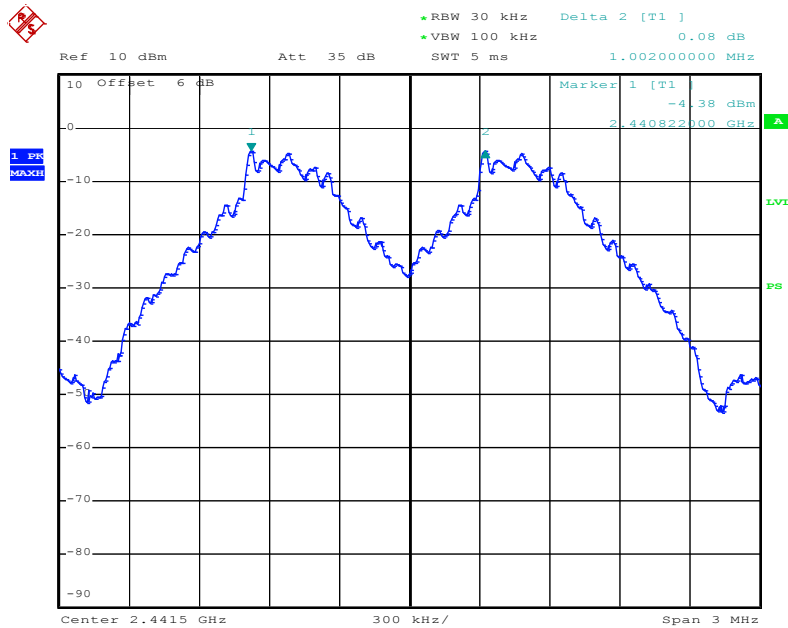

Date: 25.OCT.2019 16:27:01

### GFSK Highest Channel

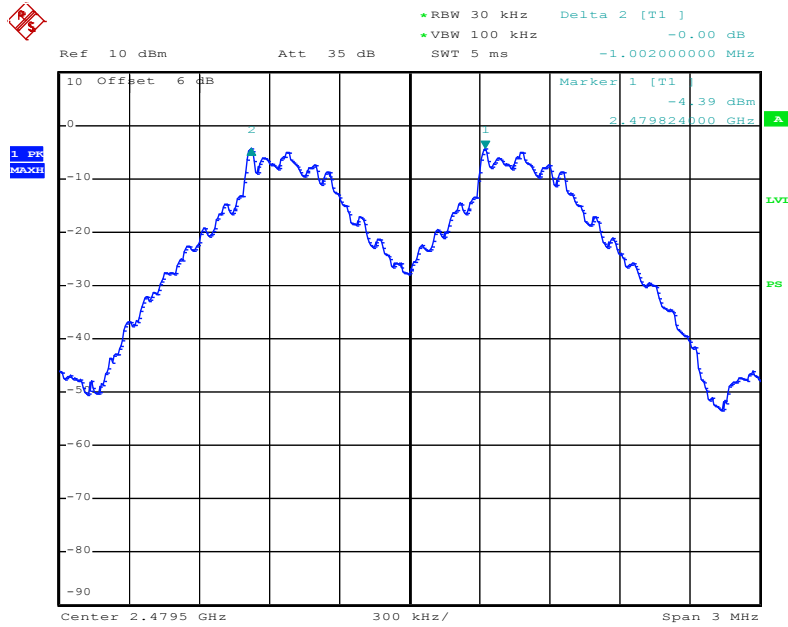

Date: 25.OCT.2019 16:28:08

### $\pi/4$ -DQPSK Lowest Channel

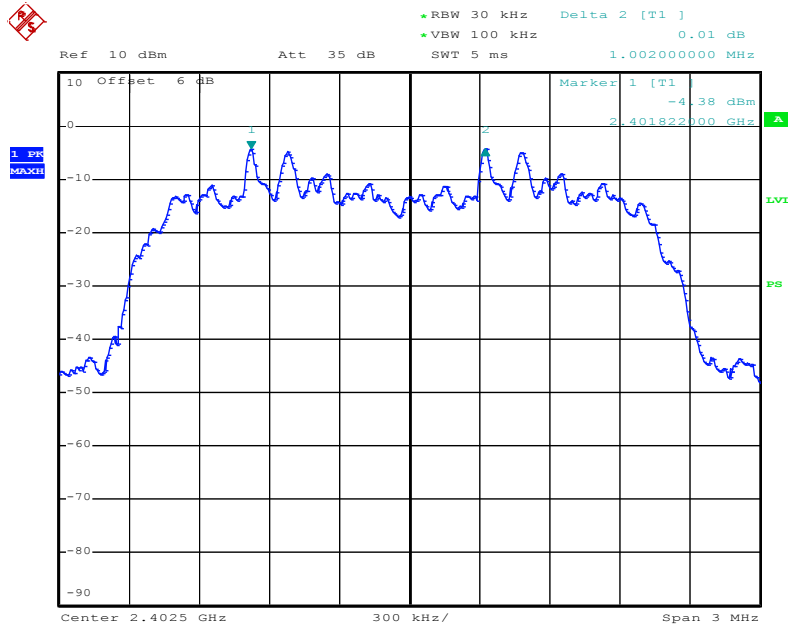

Date: 25.OCT.2019 16:28:56



### $\pi/4$ -DQPSK Middle Channel

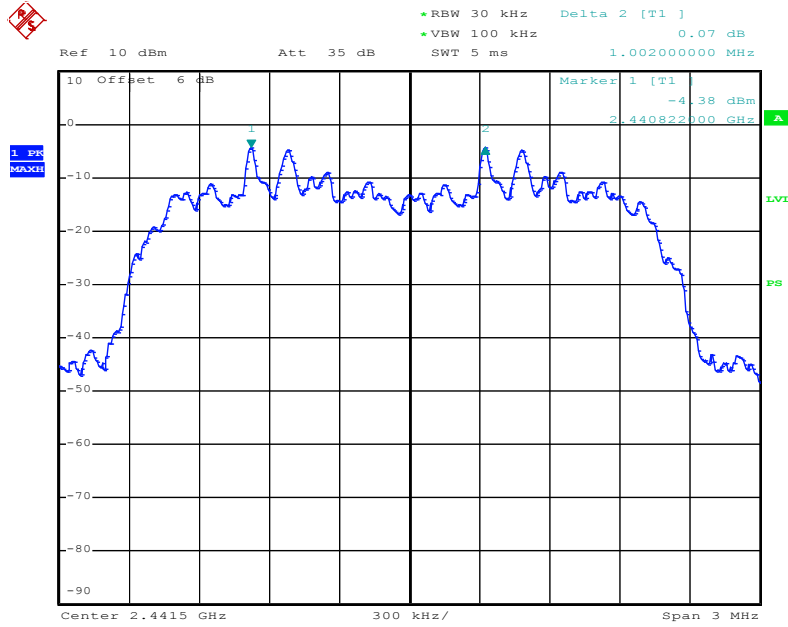

Date: 25.OCT.2019 16:29:42

### $\pi/4$ -DQPSK Highest Channel

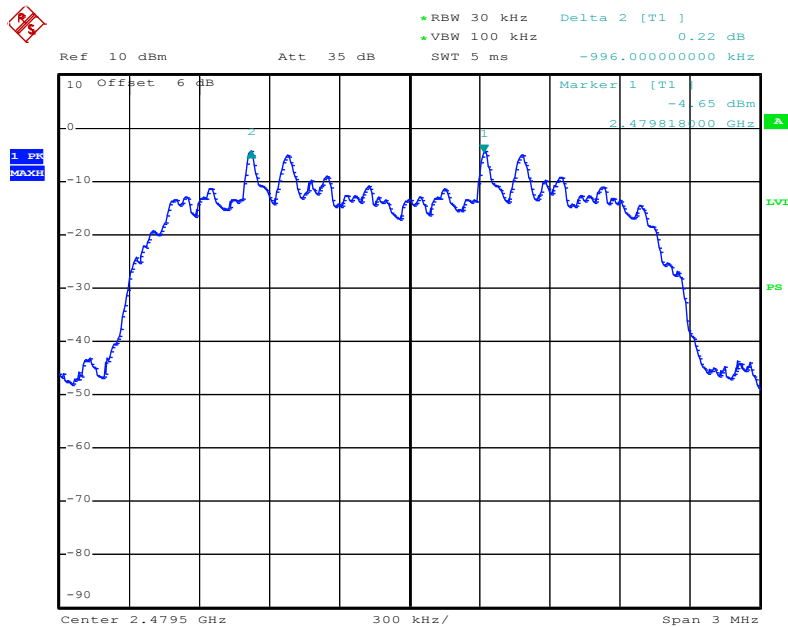

Date: 25.OCT.2019 16:30:18

## 7. 20DB BANDWIDTH

### 7.1 Measurement Procedure

Maximum 20dB RF Bandwidth, FCC Rule 15.247(a)(1):

The antenna port of the EUT was connected to the input of a spectrum analyzer. Analyzer RBW was chosen so that the display was a result of the hopping channel modulation. For each RF output channel investigated, the spectrum analyzer center frequency was set to the channel carrier. Use the spectrum 20dB down delta function to measure the bandwidth.

### 7.2 Test SET-UP (Block Diagram of Configuration)

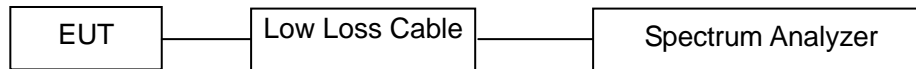

### 7.3 Measurement Results

Refer to attached data chart.

RBW:	30kHz	Temperature:	24 °C
VBW:	100kHz	Humidity:	50 %
Spectrum Detector:	PK	Test By:	Sance
Packet:	DH1, 2DH1 (Worst case)	Test Date:	October 25, 2019
Test Result:	PASS		

Channel	Test Frequency (MHz)	20dB Down BW (MHz)
<b>GFSK</b>		
Lowest	2402	0.876
Middle	2441	0.882
Highest	2480	0.876
<b><math>\pi/4</math>-DQPSK</b>		
Lowest	2402	1.230
Middle	2441	1.230
Highest	2480	1.230

### GFSK Lowest Channel

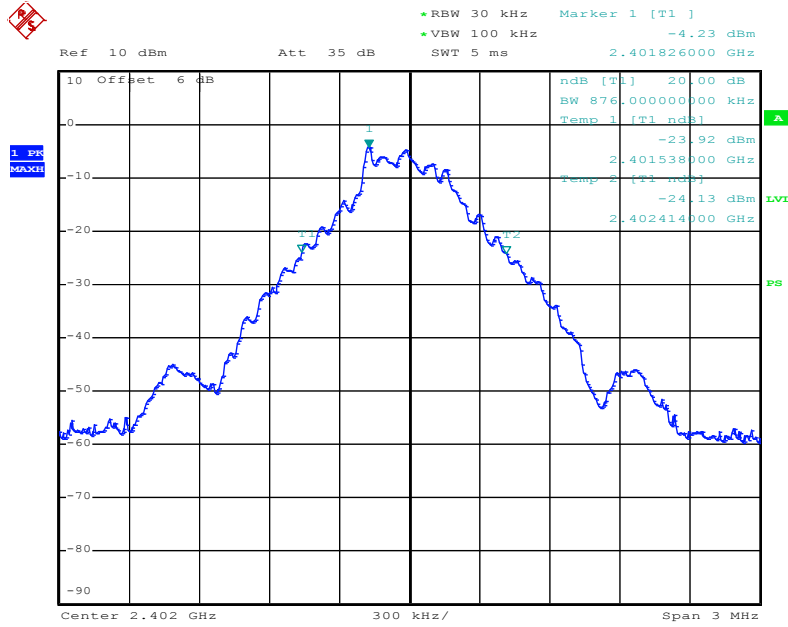

Date: 25.OCT.2019 16:06:08

### GFSK Middle Channel

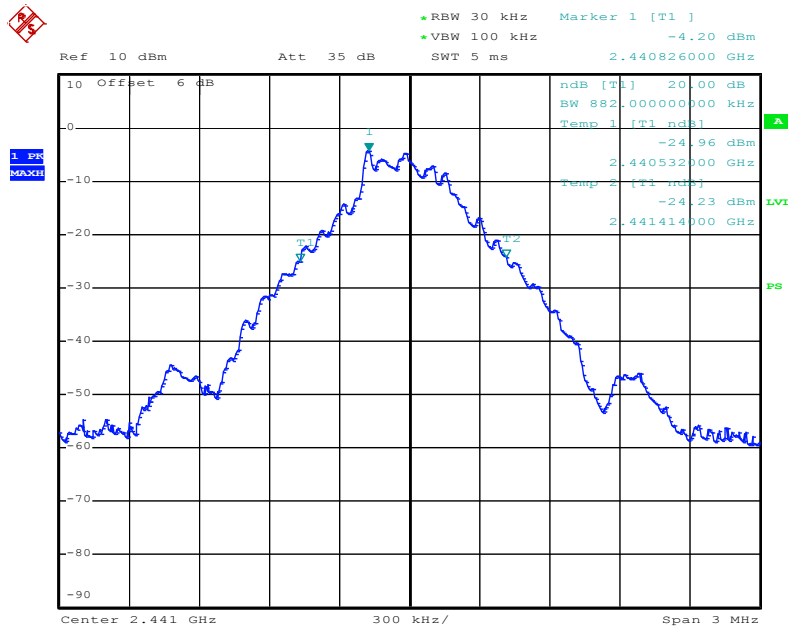

Date: 25.OCT.2019 16:12:08

### GFSK Highest Channel

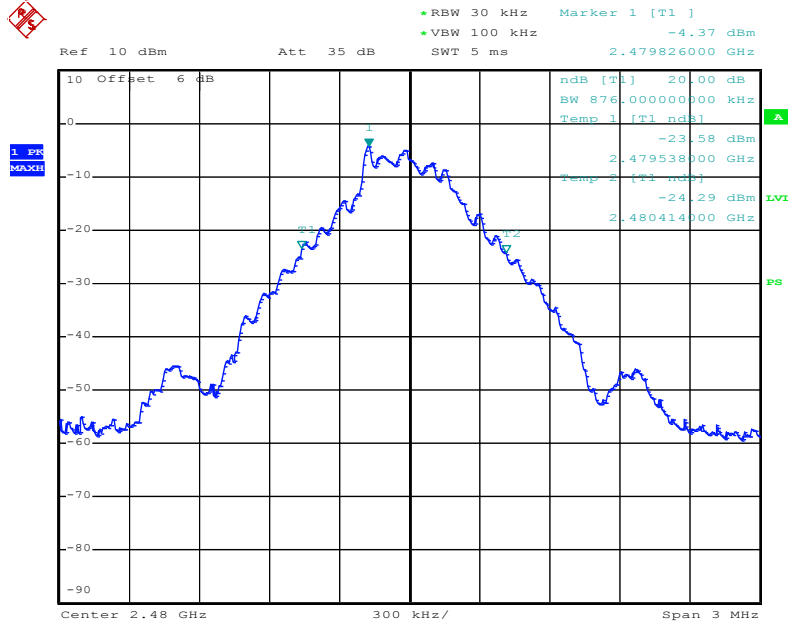

Date: 25.OCT.2019 16:13:08

### $\pi/4$ -DQPSK Lowest Channel

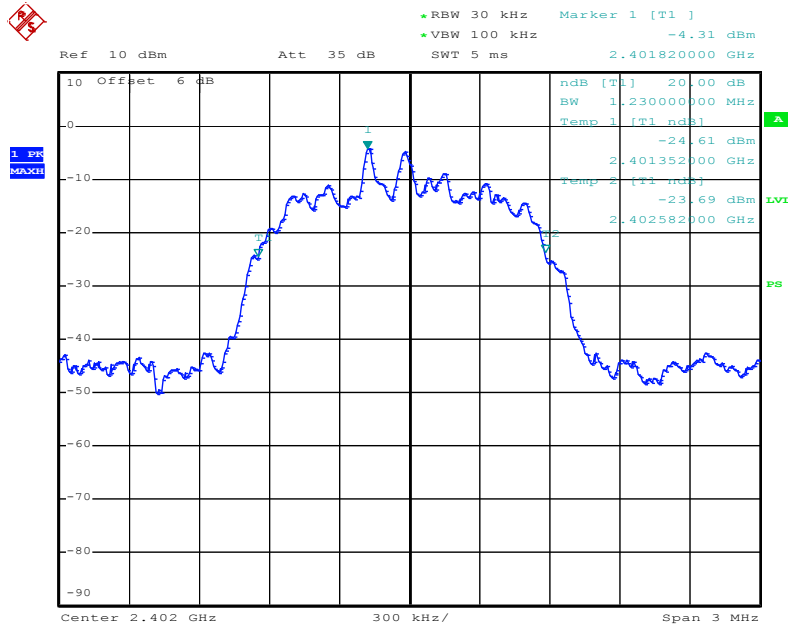

Date: 25.OCT.2019 16:14:22

### $\pi/4$ -DQPSK Middle Channel

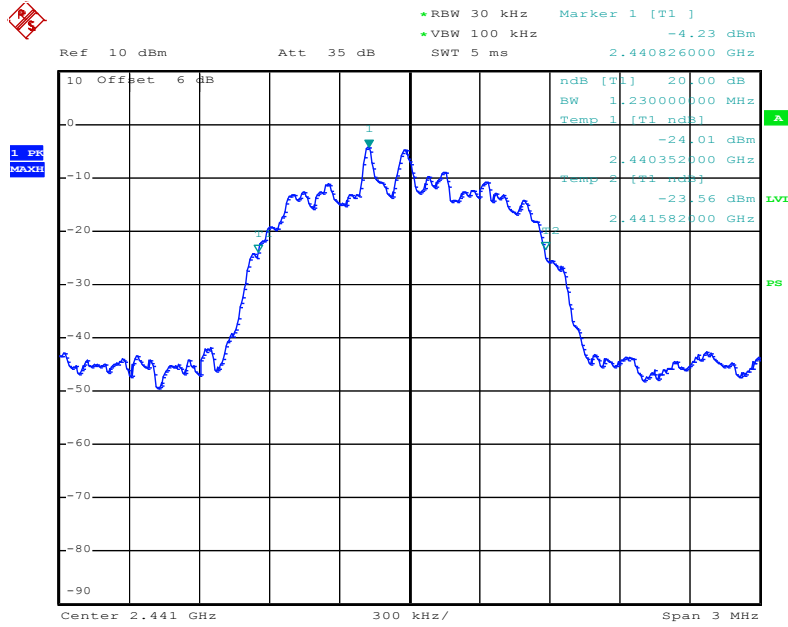

Date: 25.OCT.2019 16:15:09

### $\pi/4$ -DQPSK Highest Channel

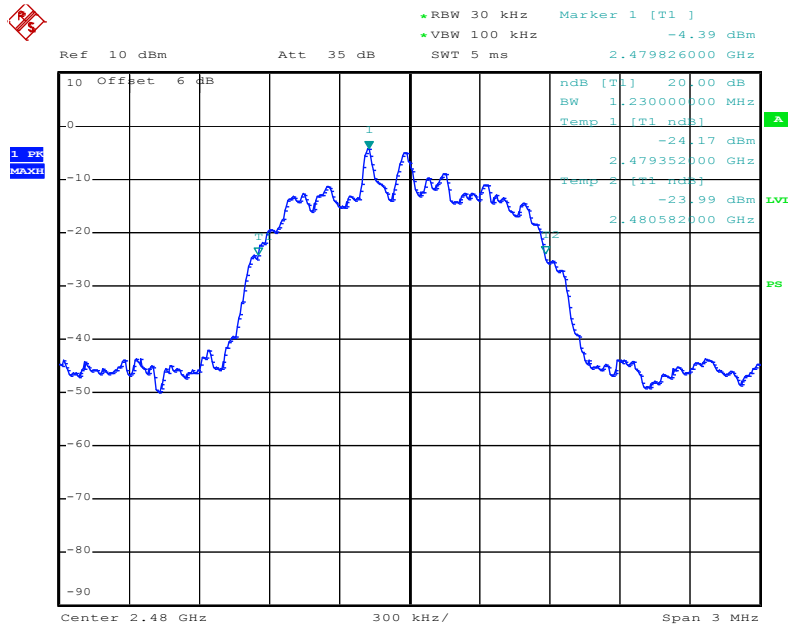

Date: 25.OCT.2019 16:16:14

## 8. HOPPING CHANNEL NUMBER

### 8.1 Measurement Procedure

Minimum Number of Hopping Frequencies, FCC Rule 15.247(a)(1)(iii):

Remove the antenna from the EUT and then connect a low RF cable from the antenna port to the spectrum, and the spectrum analyzer set to MAX HOLD readings were taken for 3-5 minutes. The channel peaks so recorded were added together, and the total number compared to the minimum number of channels required in the regulation.

### 8.2 Limit

Frequency hopping systems in the 2400-2483.5MHz band shall use at least 15 channels.

### 8.3 Test SET-UP (Block Diagram of Configuration)

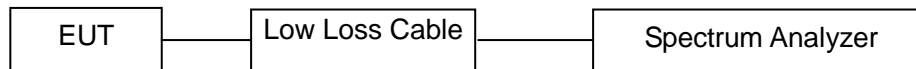

### 8.4 Measurement Results

RBW:	100kHz	Temperature:	24 °C
VBW:	300kHz	Humidity:	50 %
Spectrum Detector:	PK	Test By:	Sance
Packet:	DH1, 2DH1(Worst case)	Test Date:	October 25, 2019
Test Result:	PASS		

Hopping Channel Frequency Range	Number of Hopping Channels	Limit
2400-2483.5	79	≥15

### GFSK

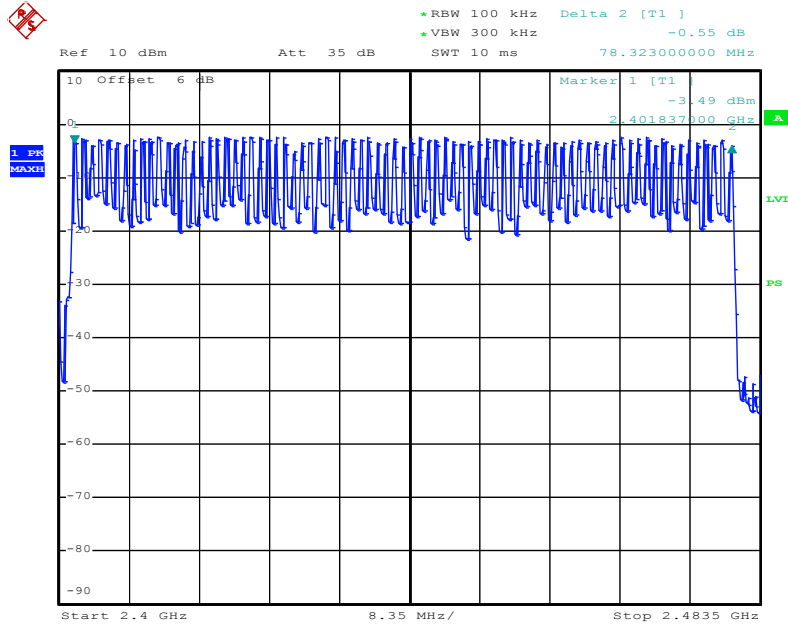

Date: 25.OCT.2019 16:53:34

### $\pi/4$ -DQPSK

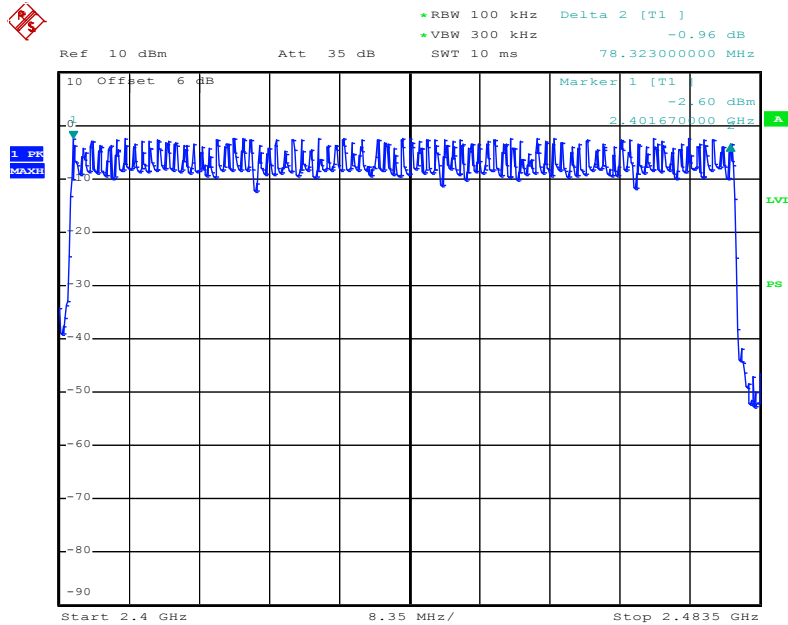

Date: 25.OCT.2019 16:55:46

## 9. TIME OF OCCUPANCY (DWELL TIME)

### 9.1 Measurement Procedure

Average Channel Occupancy Time, FCC Ref:15.247(a)(1)(iii):

Connect EUT antenna terminal to the spectrum analyzer with a low loss cable. The spectrum analyzer center frequency was set to one of the known hopping channels. The Sweep was set to 5ms, 10ms, 15ms, the SPAN was set to Zero SPAN. The time duration of the transmissions so captured was measured with the Marker Delta function.

### 9.2 Limit

The average time of occupancy on any channel shall not be greater than 0.4 seconds within a period of 0.4 seconds multiplied by the number of hopping channels employed.

### 9.3 Test SET-UP (Block Diagram of Configuration)

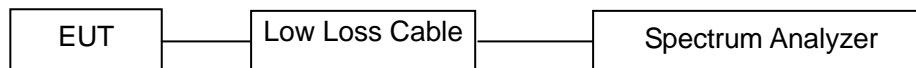

### 9.4 Measurement Results

The maximum number of hopping channels in 31.6s (0.4s/Channel x 79 Channel)

RBW:	1MHz	Temperature:	24 °C
VBW:	3MHz	Humidity:	50 %
Spectrum Detector:	PK	Test By:	Sance
Test Result:	PASS	Test Date:	October 25, 2019

Packet	Frequency (MHz)	Result (msec)		Limit (msec)
<b>GFSK</b>				
DH1	2441	0.400	$(ms) * (1600 / (2 * 79)) * 31.6 =$	128.0
DH3	2441	1.680	$(ms) * (1600 / (4 * 79)) * 31.6 =$	268.8
DH5	2441	2.940	$(ms) * (1600 / (6 * 79)) * 31.6 =$	313.6
<b><math>\pi/4</math>-DQPSK</b>				
2-DH1	2441	0.410	$(ms) * (1600 / (2 * 79)) * 31.6 =$	131.2
2-DH3	2441	1.680	$(ms) * (1600 / (4 * 79)) * 31.6 =$	268.8
2-DH5	2441	2.940	$(ms) * (1600 / (6 * 79)) * 31.6 =$	313.6



### GFSK DH1

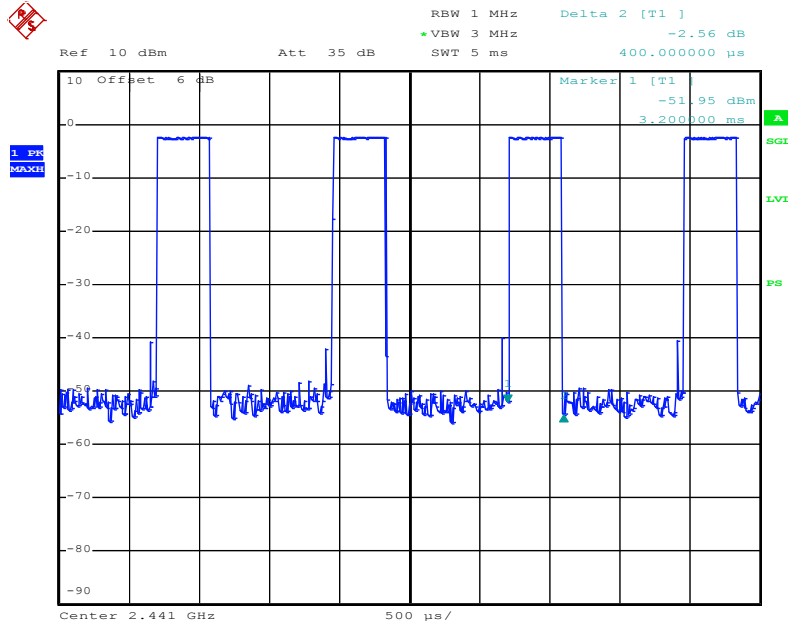

Date: 25.OCT.2019 16:32:49

### GFSK DH3

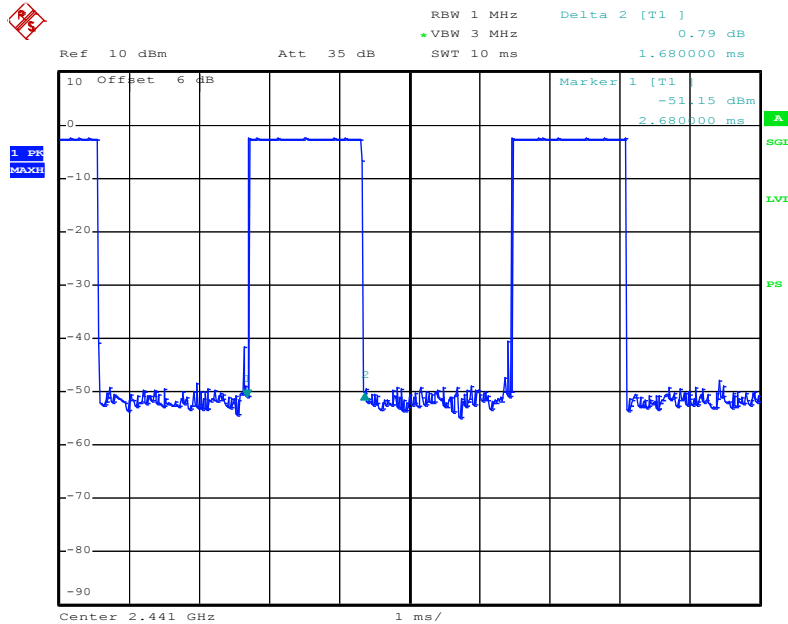

Date: 25.OCT.2019 16:33:53

### GFSK DH5

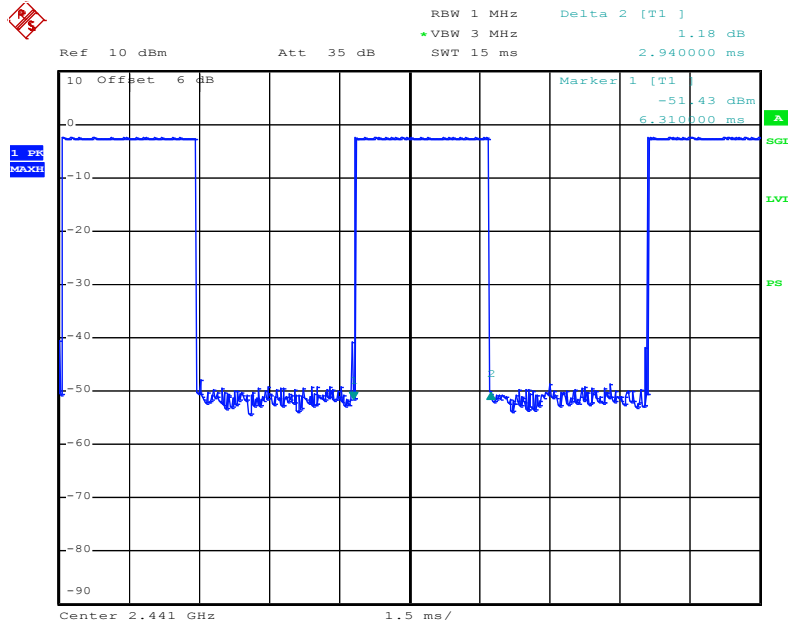

Date: 25.OCT.2019 16:34:30

### $\pi/4$ -DQPSK 2-DH1

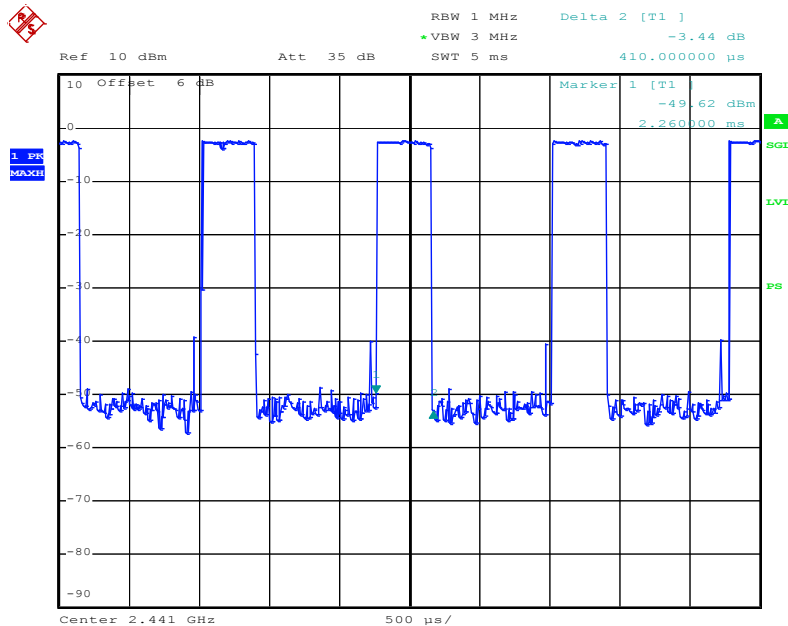

Date: 25.OCT.2019 16:35:24

### $\pi/4$ -DQPSK 2-DH3

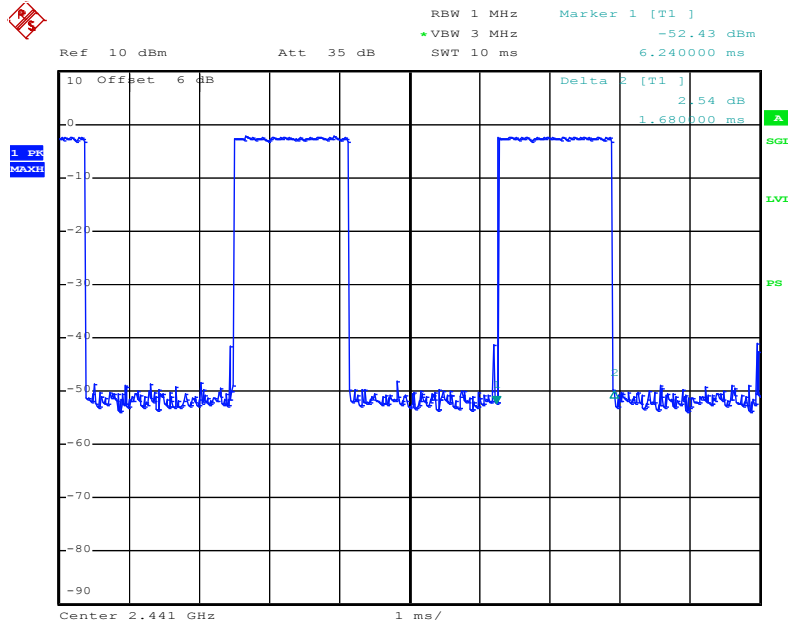

Date: 25.OCT.2019 16:36:13

### $\pi/4$ -DQPSK 2-DH5

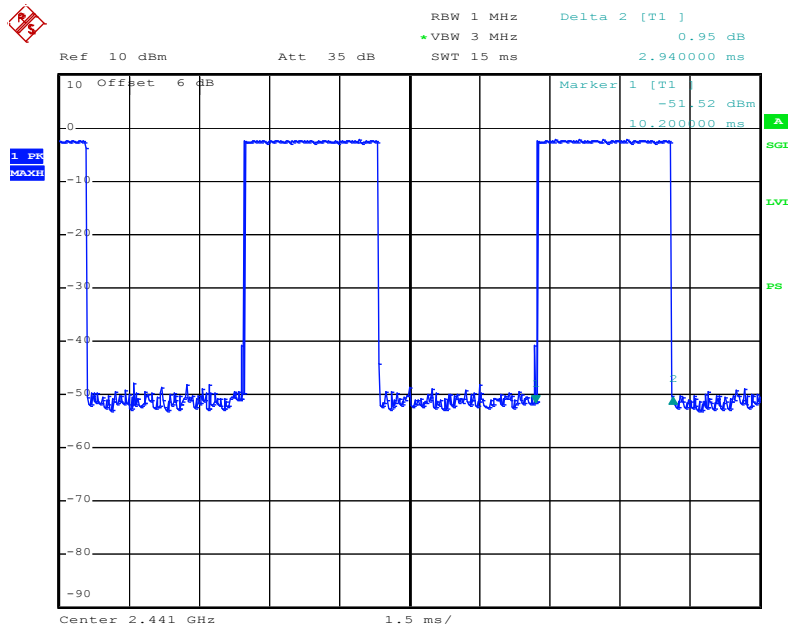

Date: 25.OCT.2019 16:36:47

## 10. MAXIMUM PEAK OUTPUT POWER

### 10.1 Measurement Procedure

Maximum Conducted Output Power at Antenna Terminals, FCC Rules 15.247(b)(1):

Remove the antenna from the EUT and then connect a low RF cable from the antenna port to the spectrum. The analyzer was set for RBW > 20dB bandwidth and power was read directly in dBm. Cable loss was considered during this measurement.

### 10.2 Limit

For all other frequency hopping systems in the 2400-2483.5MHz band: 0.125 watts.

### 10.3 Test SET-UP (Block Diagram of Configuration)

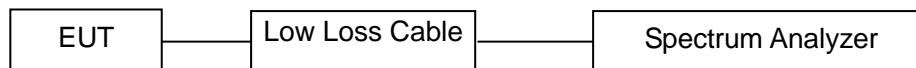

### 10.4 Measurement Results

RBW:	3MHz	Temperature:	24 °C
VBW:	10MHz	Humidity:	50 %
Spectrum Detector:	PK	Test By:	Sance
Packet:	DH1, 2DH1(Worst case)	Test Date:	October 25, 2019

Channel Frequency (MHz)	Peak Power output (dBm)	Peak Power output (W)	Peak Power Limit (dBm / W)	Results
<b>GFSK</b>				
2402.00	-2.51	0.0006	21 / 0.125	PASS
2441.00	-2.42	0.0006	21 / 0.125	PASS
2480.00	-2.60	0.0005	21 / 0.125	PASS
<b><math>\pi/4</math>-DQPSK</b>				
2402.00	-1.84	0.0007	21 / 0.125	PASS
2441.00	-1.77	0.0007	21 / 0.125	PASS
2480.00	-1.90	0.0006	21 / 0.125	PASS

### GFSK Lowest Channel

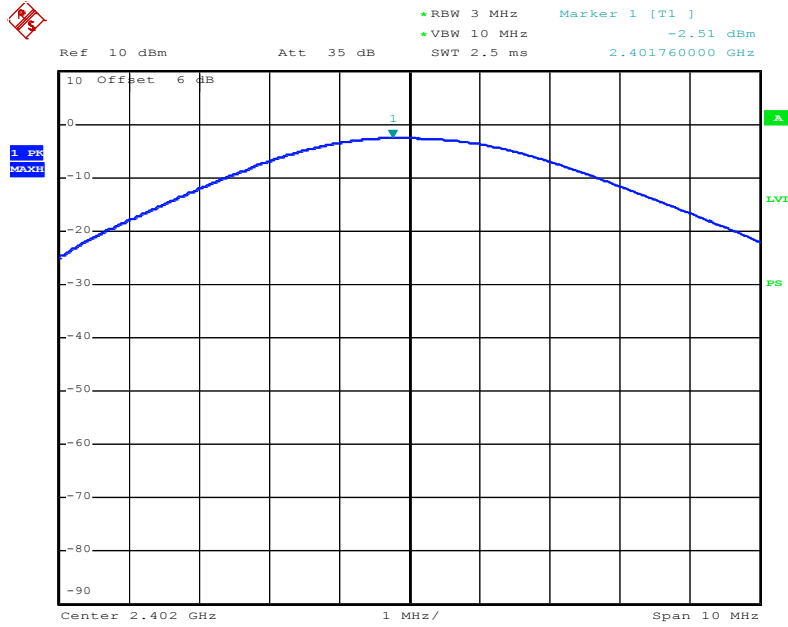

Date: 25.OCT.2019 16:56:47

### GFSK Middle Channel

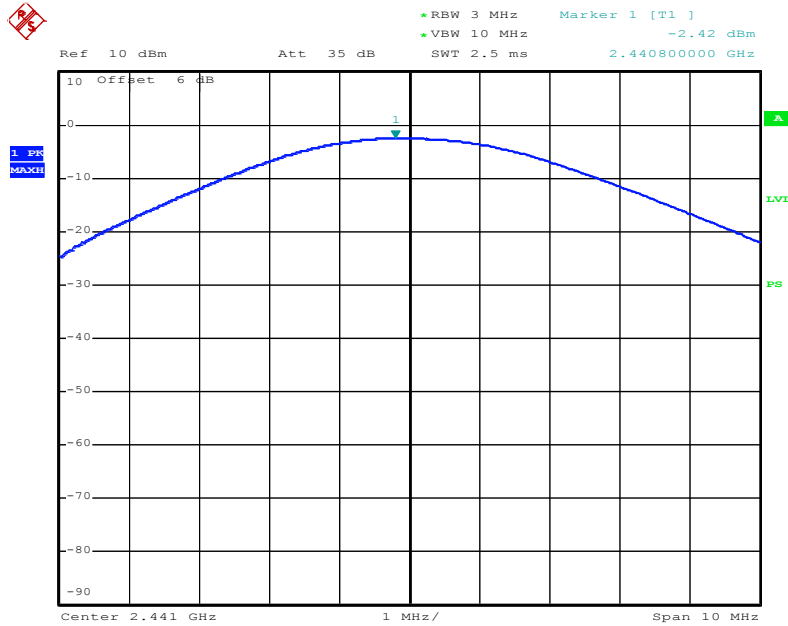

Date: 25.OCT.2019 16:57:11

### GFSK Highest Channel

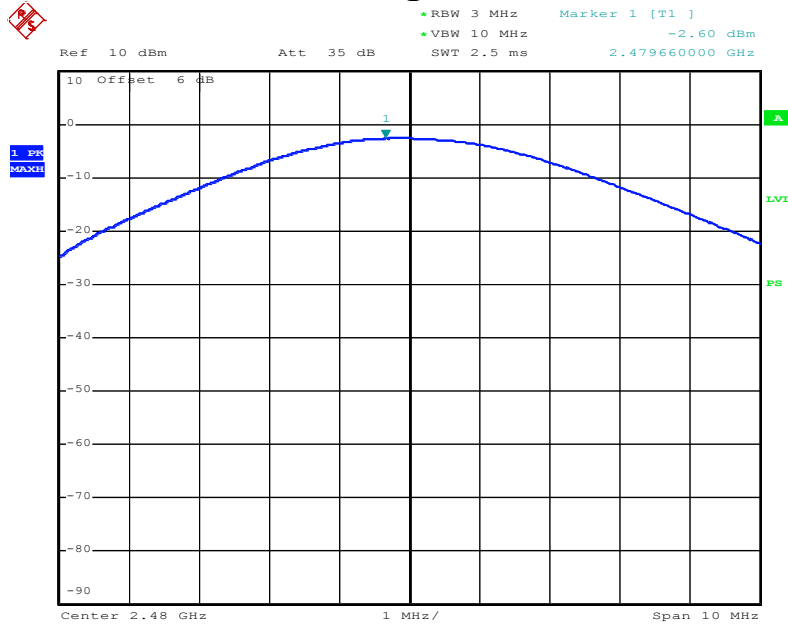

Date: 25.OCT.2019 16:57:37

### $\pi/4$ -DQPSK Lowest Channel

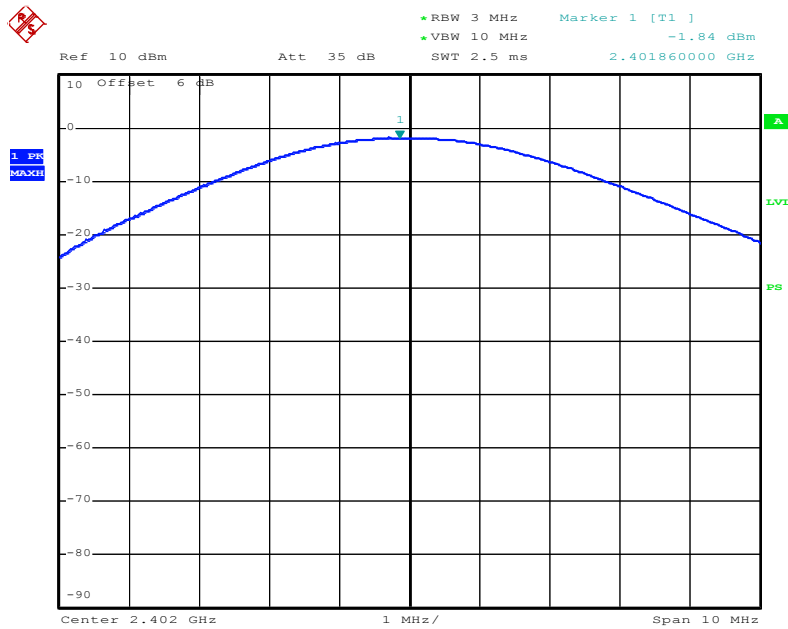

Date: 25.OCT.2019 16:58:14

### $\pi/4$ -DQPSK Middle Channel

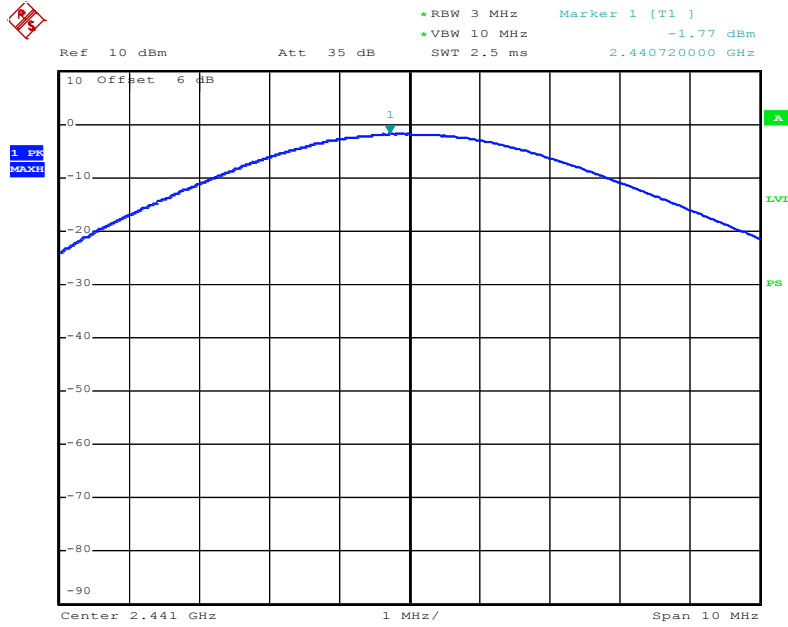

Date: 25.OCT.2019 16:58:42

### $\pi/4$ -DQPSK Highest Channel

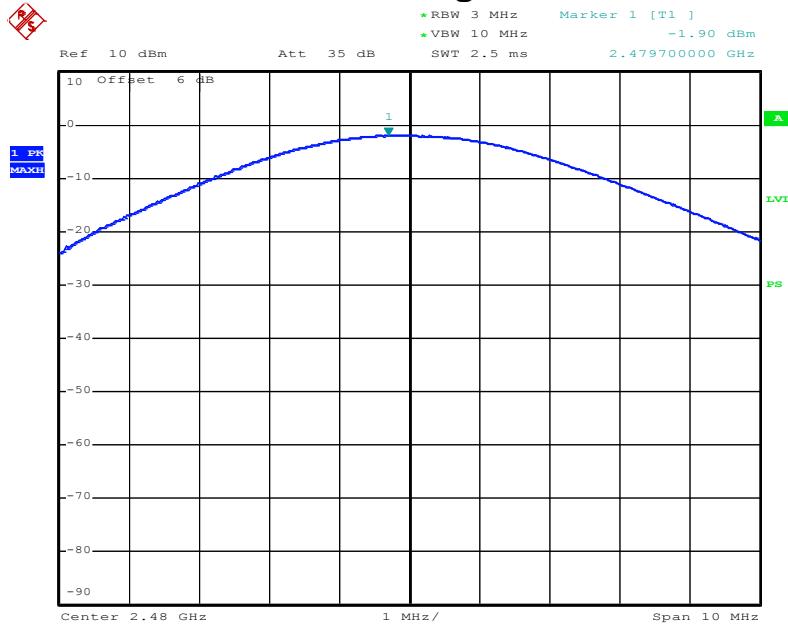

Date: 25.OCT.2019 16:59:05

## 11. BAND EDGE

### 11.1 Measurement Procedure

Out of Band Emissions, FCC Rule 15.247(d):

During the radiated emission test, the spectrum analyzer was set with the following configurations:

- 1.The resolution bandwidth of test receiver/spectrum analyzer is 1MHz and video bandwidth is 3MHz for peak measurement with peak detector at frequency above 1GHz.
- 2.The resolution bandwidth of test receiver/spectrum analyzer is 1MHz and video bandwidth is 10Hz for Average measurement with peak detection at frequency above 1GHz.

During the conducted emission test, the spectrum analyzer was set with the following configurations:

The transmitter output is connected to spectrum analyzer. The resolution bandwidth is set to 100KHz, and the video bandwidth set to 300kHz.

### 11.2 Limit

15.247(d) In any 100KHz bandwidth outside the frequency band in which the spread spectrum or digitally modulated intentional radiator is operating, the radio frequency power that is produced by the intentional radiator shall be at least 20dB below that in the 100KHz bandwidth within the band that contains the highest level of the desired power, based on either an RF conducted or a radiated measurement.

### 11.3 Measurement Results

Please see below test table and plots.

Note: All modes of operation were investigated and the worst case ( $\pi/4$  DQPSK Mode) emissions are reported.



For Radiated restricted band:

E.U.T:	Bluetooth Speaker	Polarization:	Horizontal
Model No.:	OS-528	Temperature:	25 °C
Test Mode:	TX 2402MHz (π/4-DQPSK)	Humidity:	64 %
Test Distance:	3m	Test By:	Sance
Test Results:	PASS	Test Voltage	DC 3.7V

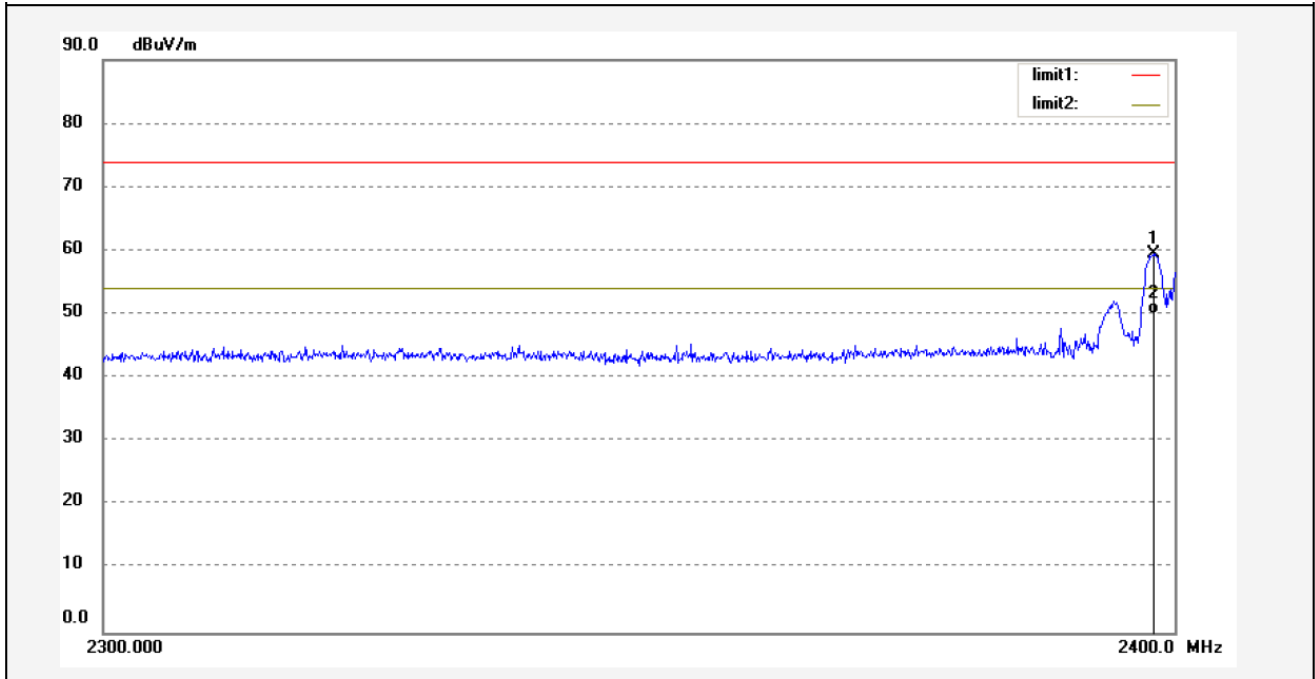

No.	Freq. (MHz)	Reading (dBuV/m)	Factor (dB)	Result (dBuV/m)	Limit (dBuV/m)	Margin (dB)	Detector	Height (cm)	Degree (deg.)	Remark
1	2398.100	58.71	0.86	59.57	74.00	-14.43	peak	200	188	
2	2398.100	49.31	0.86	50.17	54.00	-3.83	AVG	200	247	

E.U.T:	Bluetooth Speaker	Polarization:	Vertical
Model No.:	OS-528	Temperature:	25 °C
Test Mode:	TX 2402MHz (π/4-DQPSK)	Humidity:	64 %
Test Distance:	3m	Test By:	Sance
Test Results:	PASS	Test Voltage	DC 3.7V

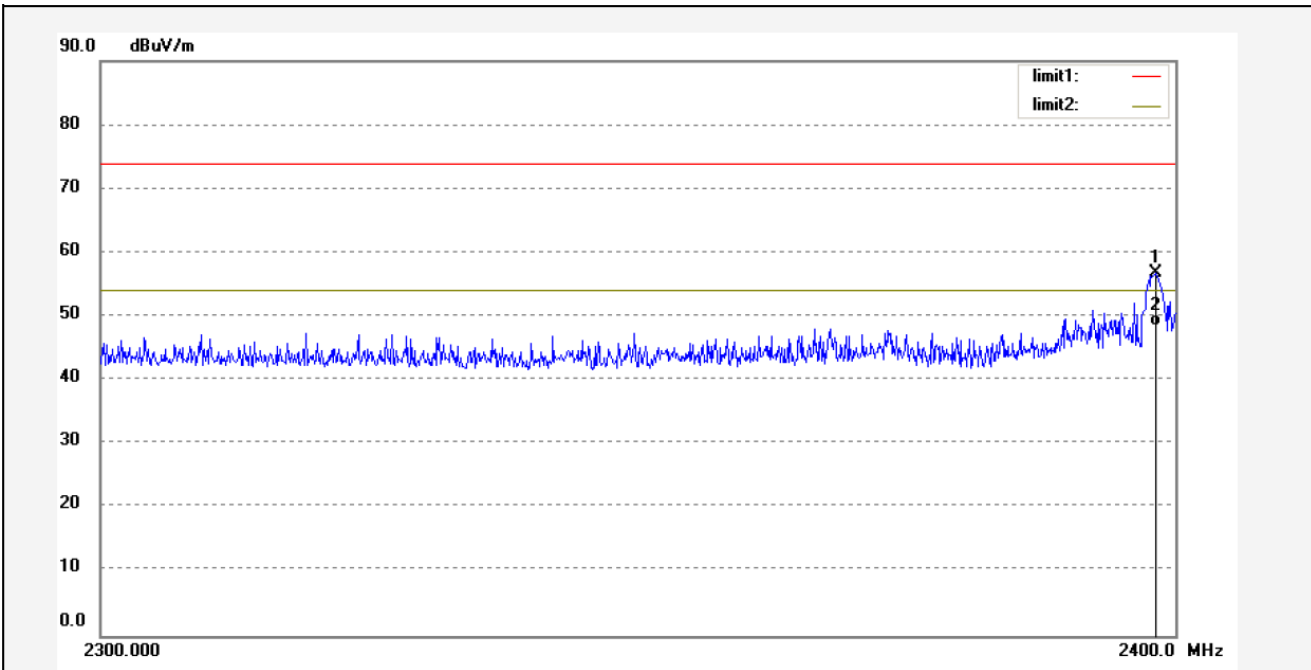

No.	Freq. (MHz)	Reading (dBuV/m)	Factor (dB)	Result (dBuV/m)	Limit (dBuV/m)	Margin (dB)	Detector	Height (cm)	Degree (deg.)	Remark
1	2398.200	55.89	0.87	56.76	74.00	-17.24	peak	100	122	
2	2398.200	47.65	0.87	48.52	54.00	-5.48	AVG	100	99	

E.U.T:	Bluetooth Speaker	Polarization:	Horizontal
Model No.:	OS-528	Temperature:	25 °C
Test Mode:	TX 2480MHz (π/4-DQPSK)	Humidity:	64 %
Test Distance:	3m	Test By:	Sance
Test Results:	PASS	Test Voltage	DC 3.7V

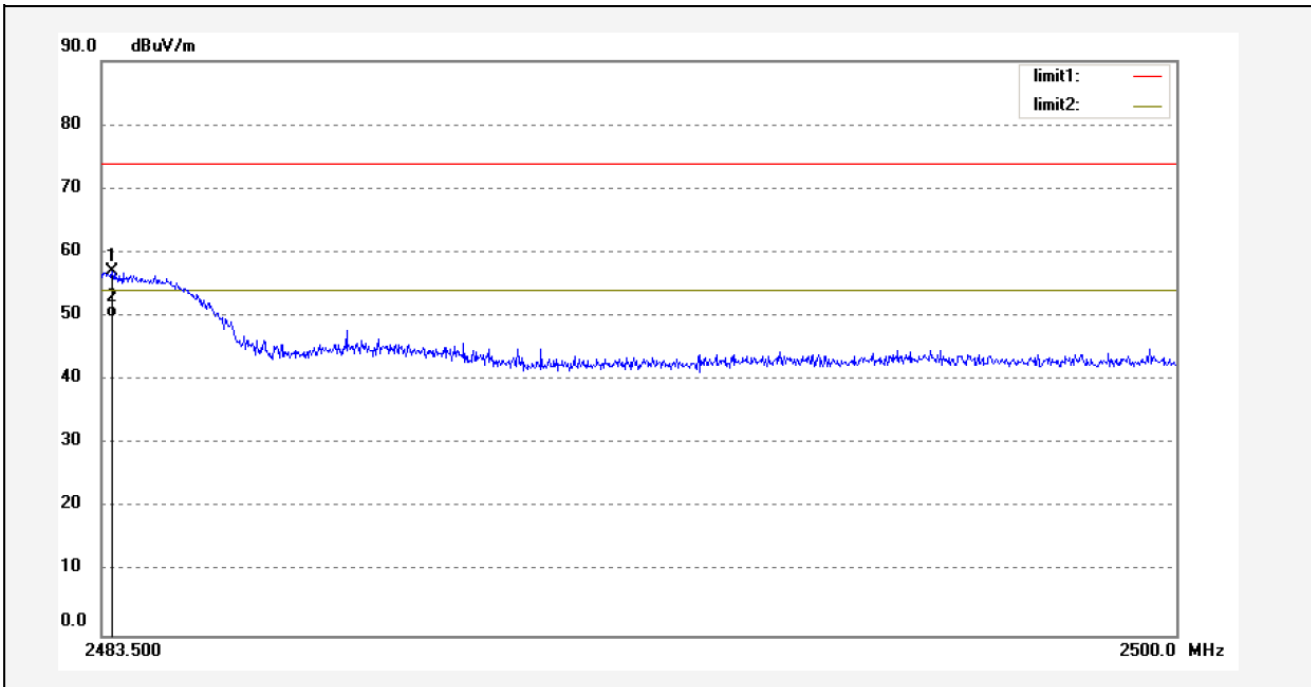

No.	Freq. (MHz)	Reading (dBuV/m)	Factor (dB)	Result (dBuV/m)	Limit (dBuV/m)	Margin (dB)	Detector	Height (cm)	Degree (deg.)	Remark
1	2483.665	55.92	1.10	57.02	74.00	-16.98	peak	200	281	
2	2483.665	48.69	1.10	49.79	54.00	-4.21	AVG	200	136	

E.U.T:	Bluetooth Speaker	Polarization:	Vertical
Model No.:	OS-528	Temperature:	25 °C
Test Mode:	TX 2480MHz (π/4-DQPSK)	Humidity:	64 %
Test Distance:	3m	Test By:	Sance
Test Results:	PASS	Test Voltage	DC 3.7V

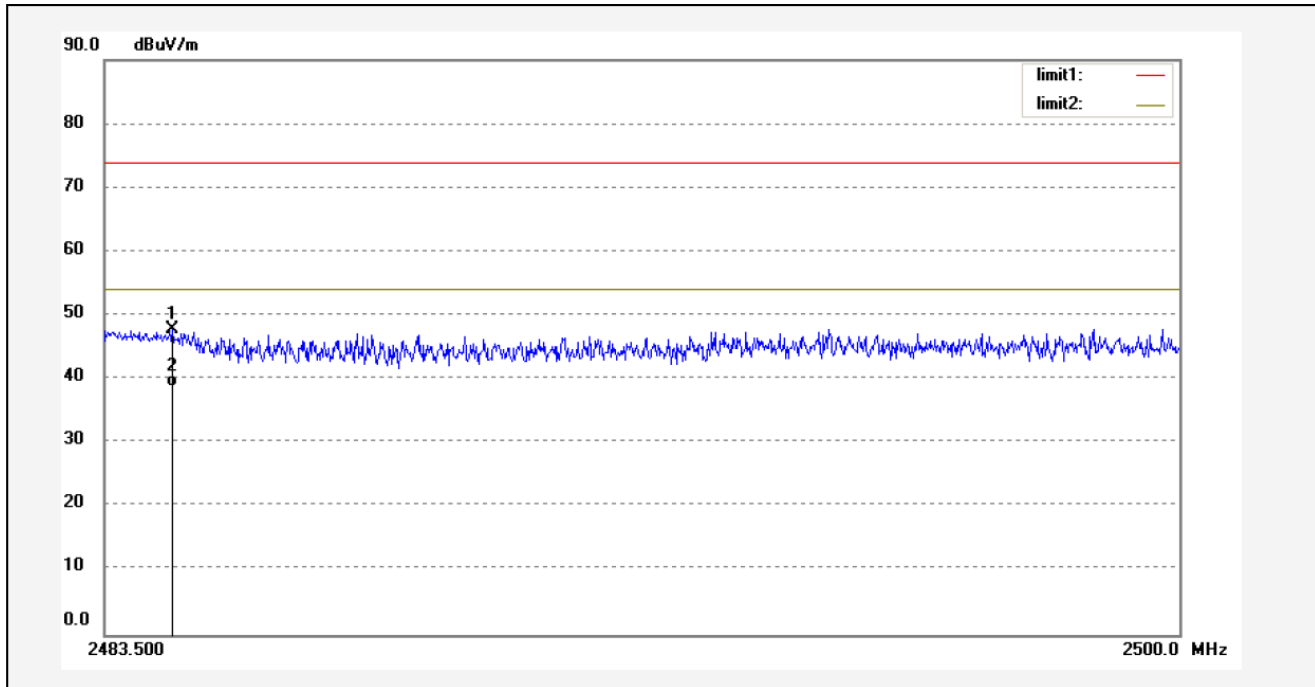

No.	Freq. (MHz)	Reading (dBuV/m)	Factor (dB)	Result (dBuV/m)	Limit (dBuV/m)	Margin (dB)	Detector	Height (cm)	Degree (deg.)	Remark
1	2484.539	46.68	1.09	47.77	74.00	-26.23	peak	100	141	
2	2484.539	37.70	1.09	38.79	54.00	-15.21	AVG	100	106	

- Note:**
- (1) Result= Reading + Factor
  - (2) Factor= Antenna Gain + Cable Loss – Amplifier Gain
  - (3) Horn antenna used for the emission over 1000MHz.

For RF Conducted restricted band:

### GFSK Lowest Channel

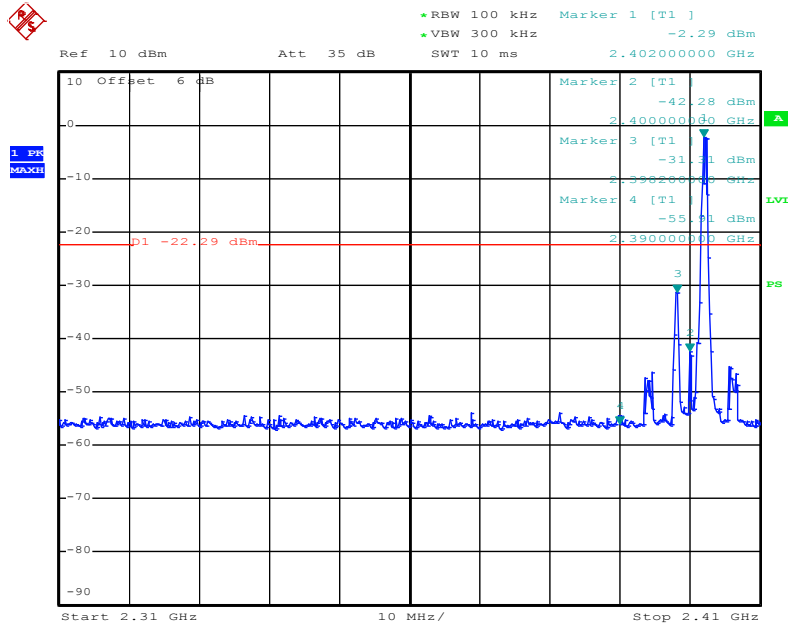

Date: 25.OCT.2019 16:39:47

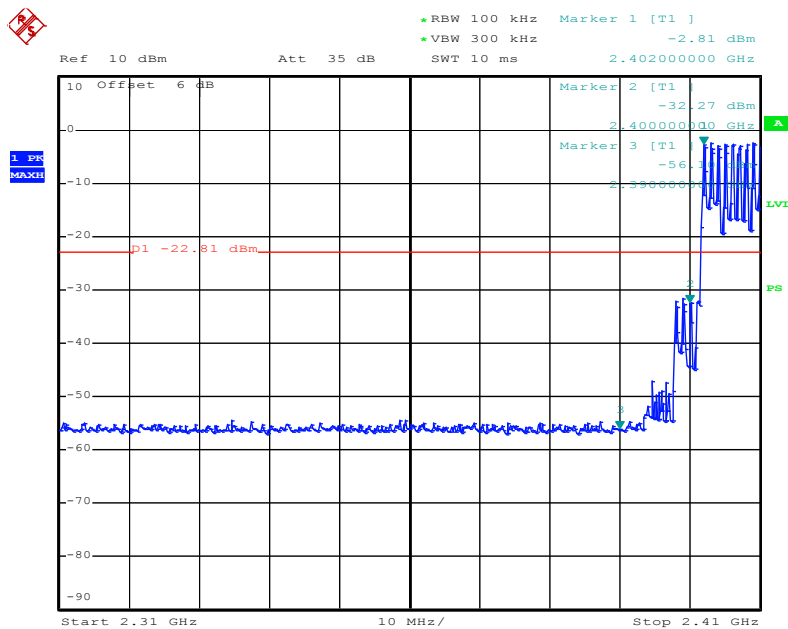

Date: 25.OCT.2019 16:41:48

### GFSK Highest Channel

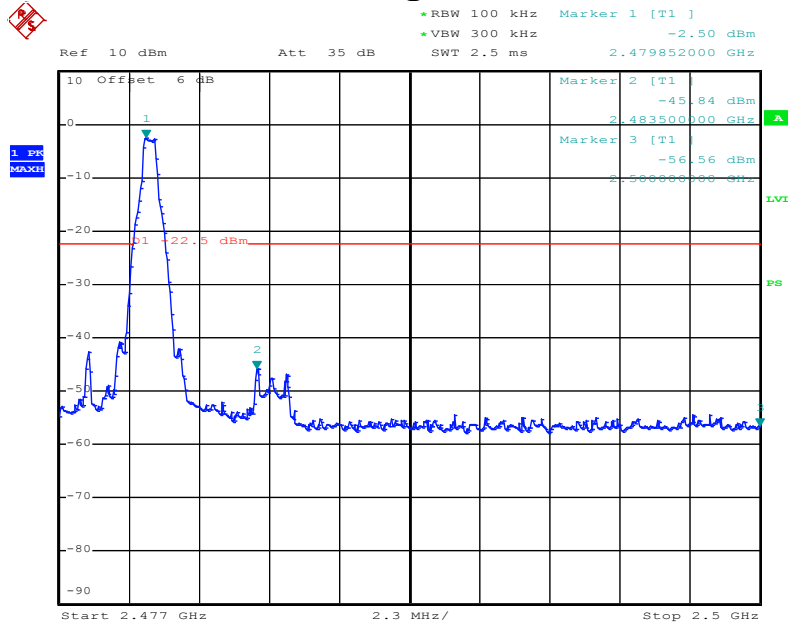

Date: 25.OCT.2019 16:43:40

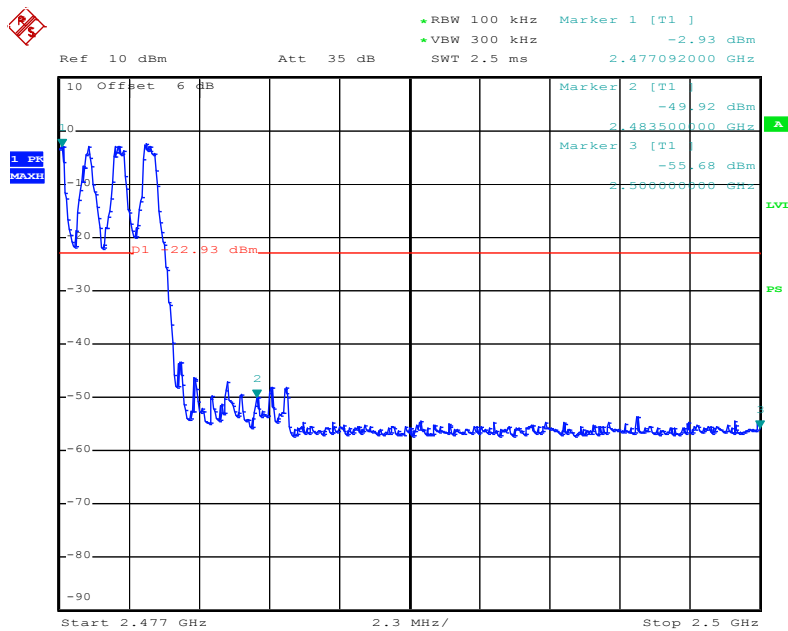

Date: 25.OCT.2019 16:45:15

### $\pi/4$ -DQPSK Lowest Channel

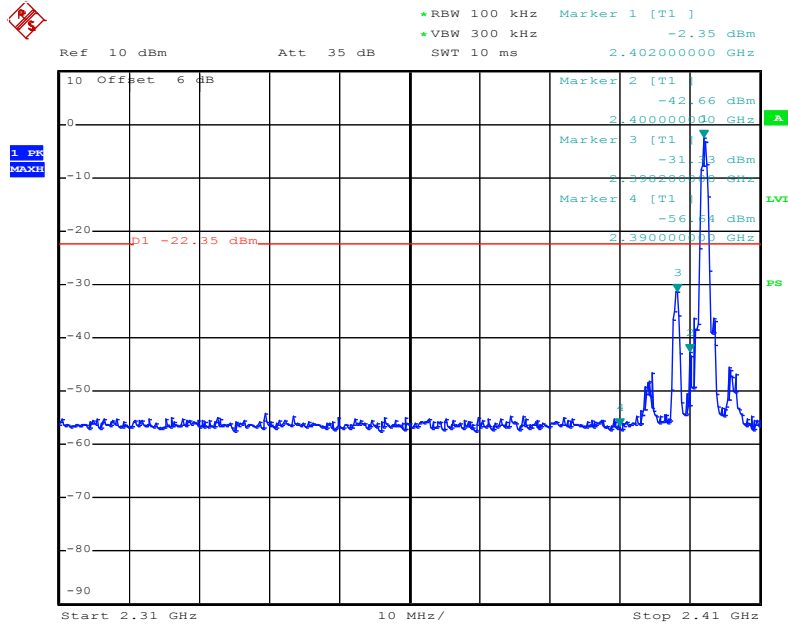

Date: 25.OCT.2019 16:49:57

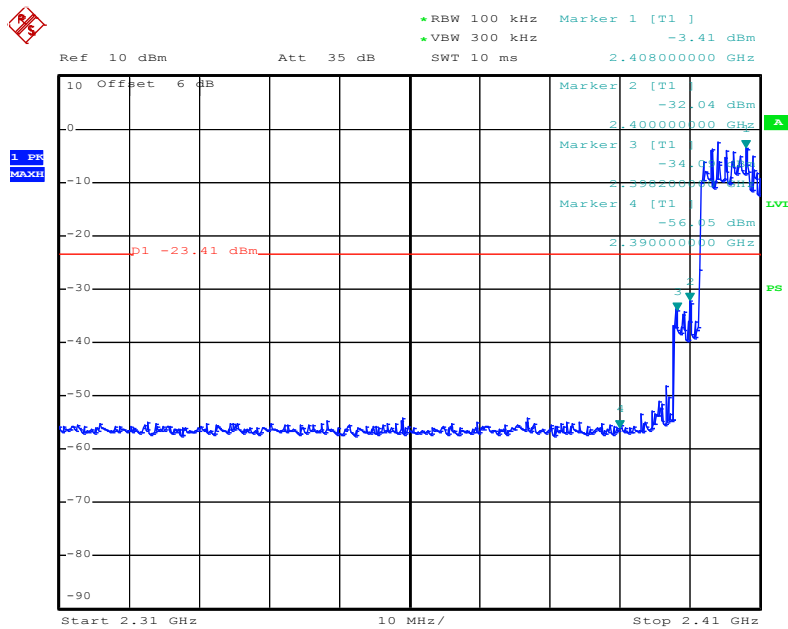

Date: 25.OCT.2019 16:51:08

### $\pi/4$ -DQPSK Highest Channel

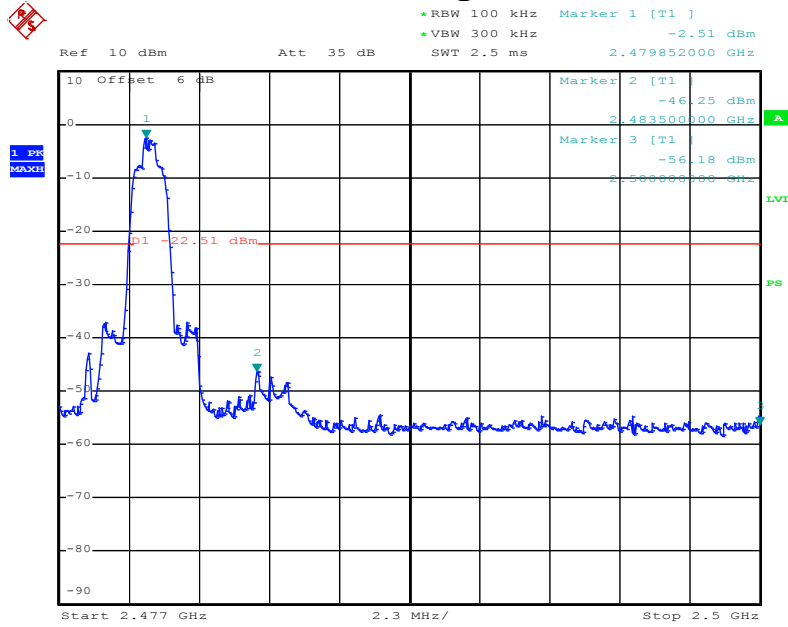

Date: 25.OCT.2019 16:47:34

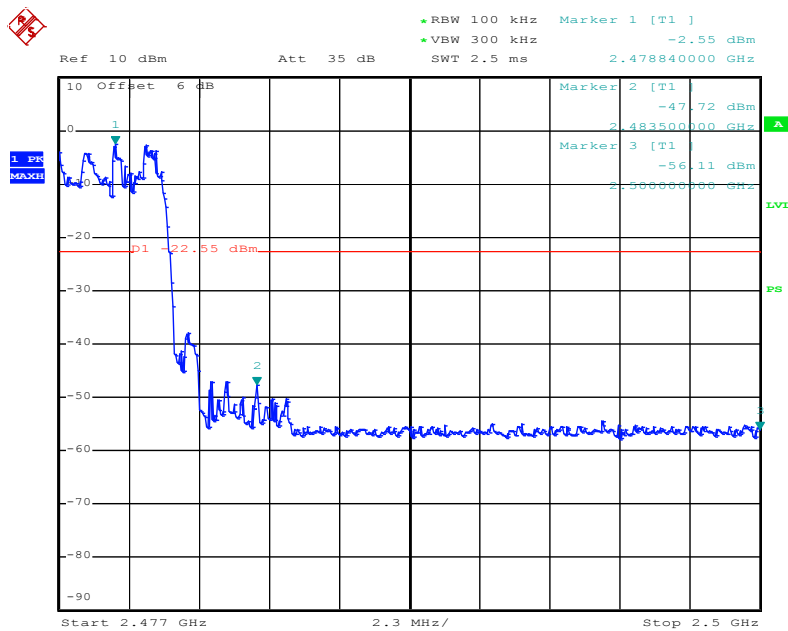

Date: 25.OCT.2019 16:46:45



---

## 12. ANTENNA APPLICATION

### 12.1 Antenna requirement

According to of FCC part 15C section 15.203 and 15.240:

An intentional radiator shall be designed to ensure that no antenna other than that furnished by the responsible party shall be used with the device. The use of a permanently attached antenna or of an antenna that uses a unique coupling to the intentional radiator, the manufacturer may design the unit so that a broken antenna can be replaced by the user, but the use of a standard antenna jack or electrical connector is prohibited. Systems operating in the 2400-2483.5MHz band that are used exclusively for fixed, point-to-point operations may employ transmitting antennas with directional gain greater than 6dBi provided the maximum peak output power of the intentional radiator is reduced by 1dB for every 3dB that the directional gain of the antenna exceeds 6dBi.

### 12.2 Measurement Results

The antenna is PCB antenna and no consideration of replacement, and the best case gain of the antenna is -0.58dBi. Therefore, the antenna is consider meet the requirement.

## 13. CONDUCTED SPURIOUS EMISSIONS

### 13.1 Measurement Procedure

Out of Band Conducted Spurious Emissions, FCC Rule 15.247(d):

The transmitter output is connected to spectrum analyzer. All spurious emission and up to the tenth harmonic was measured and they were found to be at least 20dB below the highest level of the desired power in the passband.

### 13.2 Limit

In any 100KHz bandwidth outside the frequency band in which the spread spectrum intentional radiator is operating, the radio frequency power that is produced by the intentional radiator shall be at least 20dB below that in the 100KHz bandwidth within the band that contains the highest level of the desired power, based on either an RF conducted or a radiated measurement.

### 13.3 Test SET-UP (Block Diagram of Configuration)

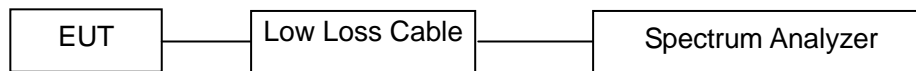

### 13.4 Measurement Results

Please refer to following plots, the worst case ( $\pi/4$ -DQPSK) was shown.

### Lowest Channel

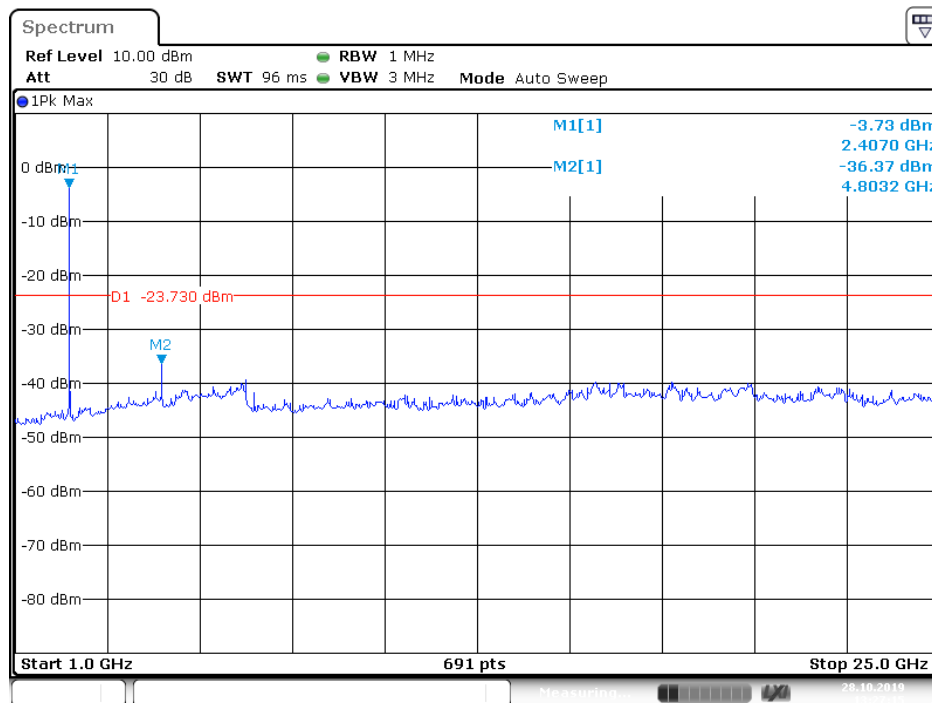
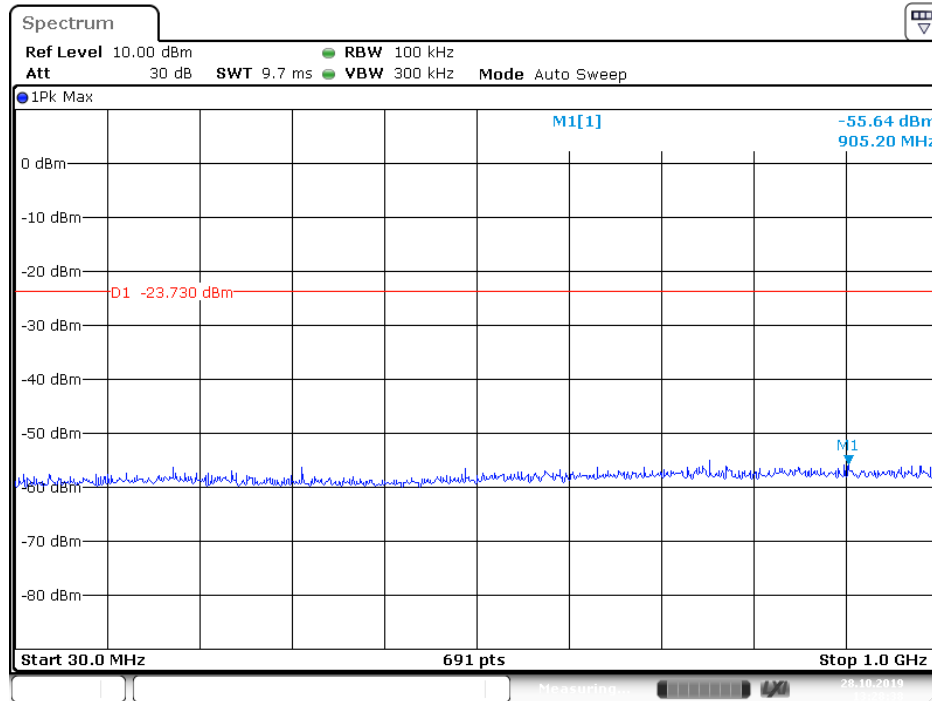

### Middle Channel

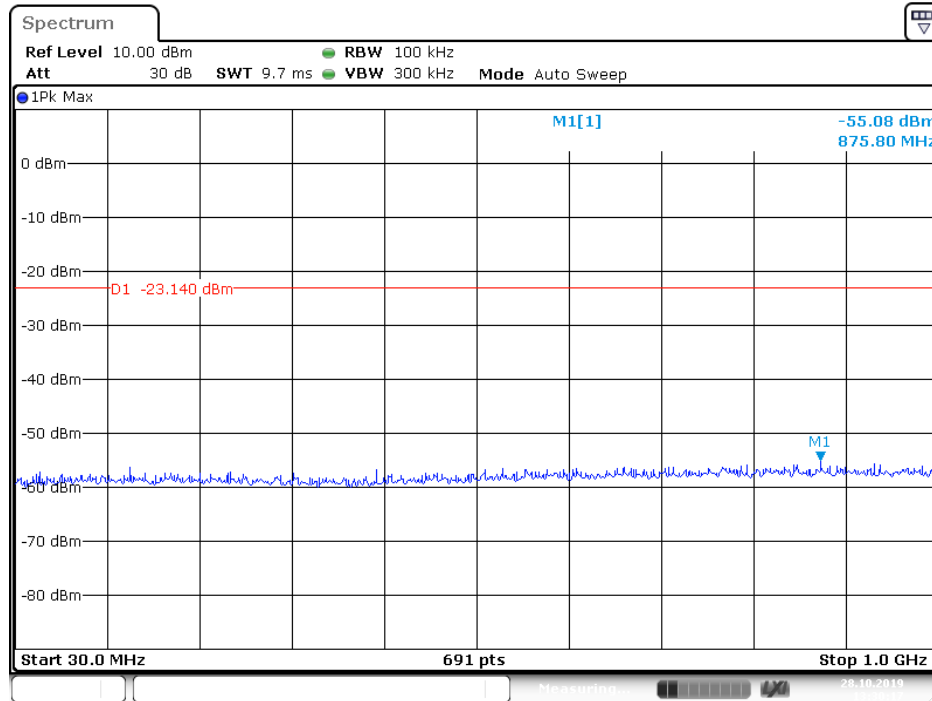

Date: 28.OCT.2019 13:30:17

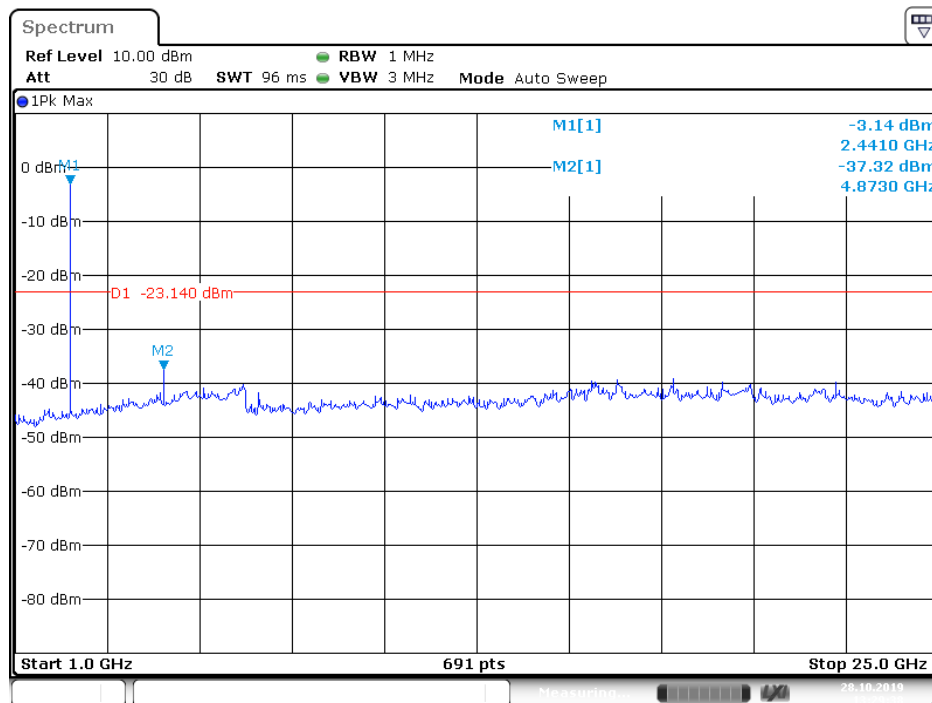

Date: 28.OCT.2019 13:29:39

### Highest Channel

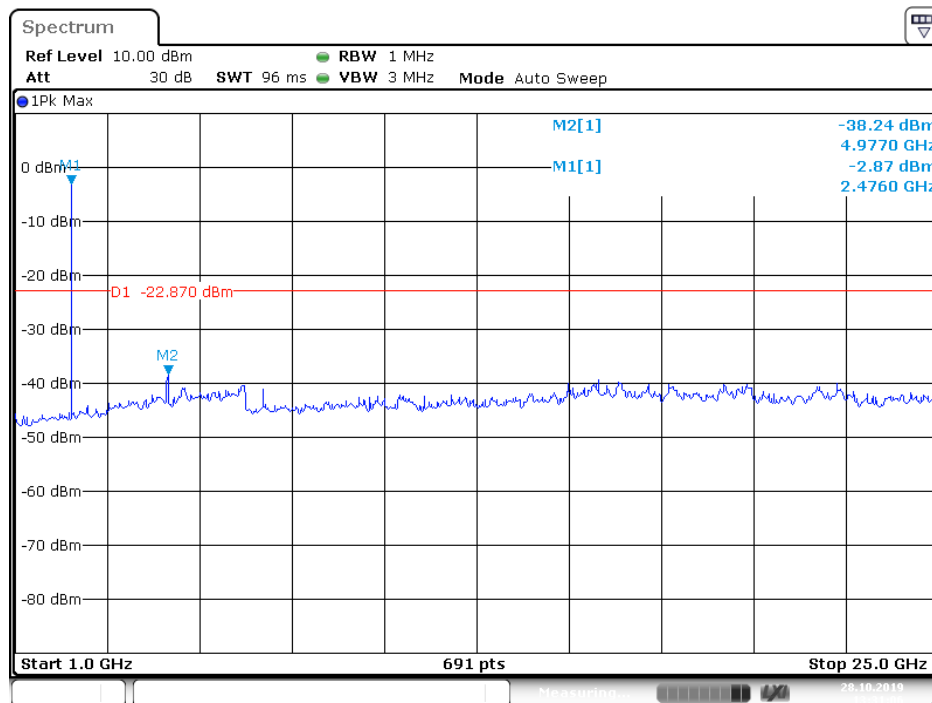
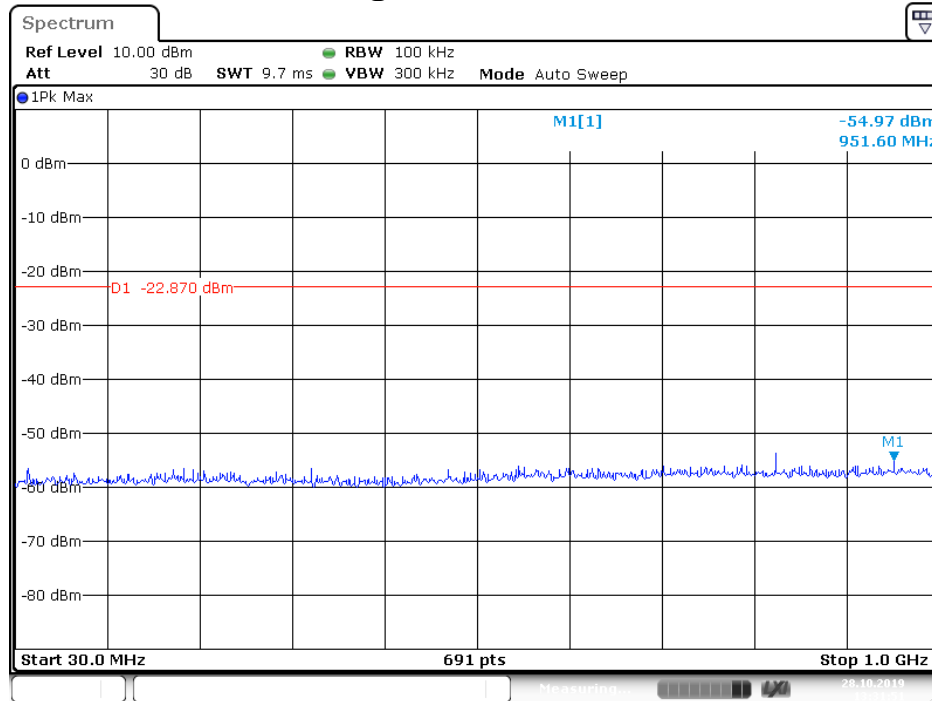

## 14. TEST EQUIPMENT LIST

Description	Manufacturer	Model Number	Serial Number	Characteristics	Calibration Date	Calibration Due Date
Test Receiver	Rohde & Schwarz	ESCI7	100837	9KHz~7GHz	Mar. 14, 2019	1 year
Antenna	Schwarzbeck	VULB9162	9162-010	30MHz~7GHz	Mar. 23, 2019	1 year
Spectrum Analyzer	Rohde & Schwarz	FSU26	200409/026	20Hz~26.5GHz	Mar. 14, 2019	1 year
Spectrum Analyzer	Keysight	N9020A	MY54200831	20Hz~26.5GHz	Apr. 24, 2019	1 year
Spectrum Analyzer	Rohde & Schwarz	FSV40	101003	10Hz~40GHz	Apr. 24, 2019	1 year
L.I.S.N	Rohde & Schwarz	ESH2-Z5	893606/014	9KHz~30MHz	Mar. 13, 2019	1 Year
Horn Antenna	Schwarzbeck	BBHA9170	9170-372	15GHz~40GHz	Mar. 23, 2019	1 year
Pre-Amplifier	EMCI	EMC 184045	980102	18GHz~40GHz	Apr. 24, 2019	1 year
Power Sensor	DARE	RPR3006W	15100041SN O64	100MHz~6GHz	Mar. 14, 2019	1 year
Communication Tester	Rohde & Schwarz	CMW500	149004	70MHz~6GHz	Mar. 14, 2019	1 year
Horn Antenna	COM-Power	AH-118	071078	500MHz~18GHz	Mar. 23, 2019	1 year
Pre-Amplifier	HP	HP 8449B	3008A00964	1GHz~26.5GHz	Mar. 14, 2019	1 year
Pre-Amplifier	HP	HP 8447D	1145A00203	100KHz~1.3GHz	Mar. 14, 2019	1 year
Loop Antenna	Schwarzbeck	FMZB 1513	1513-272	9KHz~30MHz	Apr. 24, 2019	1 year
Temperature & Humidity Chamber	REMAFEE	SYHR225L	N/A	-40~150℃	Apr. 24, 2019	1 year
DC Source	MY	MY8811	N/A	0~30V	N/A	N/A
Temporary antenna connector	TESCOM	SS402	N/A	9KHz~25GHz	N/A	N/A
Power Meter	Anritsu	ML2495A	1139001	100k-65GHz	Apr. 24, 2019	1 year
Power Sensor	Anritsu	MA2411B	100345	300M-40GHz	Apr. 24, 2019	1 year
Test Software	EZ	EZ_EMG	N/A	N/A	N/A	N/A

Note: The temporary antenna connector is soldered on the PCB board in order to perform conducted tests and this temporary antenna connector is listed in the equipment list.

---END---