

FCC Radio Test Report

FCC ID: 2AJ5B-C78

Original Grant

Report No. : TB-FCC177636
Applicant : SAGE HUMAN ELECTRONICS INTERNATIONAL CO.,LTD.
Equipment Under Test (EUT)
EUT Name : Bluetooth FM Transmitter for Car
Model No. : C78
Series Model No. : C78Q, C78S, BH477A, BH477B, BH477C
Brand Name : ----
Sample ID : 20201118-14-5#& 20201118-14-6#
Receipt Date : 2020-12-04
Test Date : 2020-12-05 to 2021-02-22
Issue Date : 2021-02-23
Standards : FCC Part 15, Subpart C 15.247
Test Method : ANSI C63.10: 2013
Conclusions : **PASS**

In the configuration tested, the EUT complied with the standards specified above,
The EUT technically complies with the FCC requirements

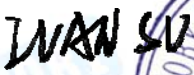
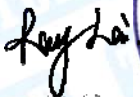
Test/Witness Engineer :  Rebeca
Engineer Supervisor :  Ivan Su
Engineer Manager :  Ray Lai



This report details the results of the testing carried out on one sample. The results contained in this test report do not relate to other samples of the same product. The manufacturer should ensure that all products in series production are in conformity with the product sample detailed in the report.

Contents

CONTENTS	2
1. GENERAL INFORMATION ABOUT EUT	5
1.1 Client Information.....	5
1.2 General Description of EUT (Equipment Under Test)	5
1.3 Block Diagram Showing the Configuration of System Tested.....	7
1.4 Description of Support Units	7
1.5 Description of Test Mode.....	8
1.6 Description of Test Software Setting	9
1.7 Measurement Uncertainty	9
1.8 Test Facility.....	10
2. TEST SUMMARY	11
3. TEST SOFTWARE	11
4. TEST EQUIPMENT	12
5. CONDUCTED EMISSION TEST	13
5.1 Test Standard and Limit.....	13
5.2 Test Setup.....	13
5.3 Test Procedure.....	14
5.4 Deviation From Test Standard.....	14
5.5 EUT Operating Mode	14
5.6 Test Data.....	14
6. RADIATED EMISSION TEST	15
6.1 Test Standard and Limit.....	15
6.2 Test Setup.....	16
6.3 Test Procedure.....	17
6.4 Deviation From Test Standard.....	17
6.4 EUT Operating Condition	17
6.5 Test Data.....	17
7. RESTRICTED BANDS REQUIREMENT	18
7.1 Test Standard and Limit.....	18
7.2 Test Setup.....	18
7.3 Test Procedure.....	19
7.4 Deviation From Test Standard.....	19
7.5 EUT Operating Condition	19
7.6 Test Data.....	19
8. NUMBER OF HOPPING CHANNEL	20
8.1 Test Standard and Limit.....	20
8.2 Test Setup.....	20
8.3 Test Procedure.....	20
8.4 Deviation From Test Standard.....	20
8.5 EUT Operating Condition	20

8.6 Test Data.....	20
9. AVERAGE TIME OF OCCUPANCY.....	21
9.1 Test Standard and Limit.....	21
9.2 Test Setup.....	21
9.3 Test Procedure.....	21
9.4 EUT Operating Condition	21
9.4 Deviation From Test Standard.....	22
9.5 EUT Operating Condition	22
9.6 Test Data.....	22
10. CHANNEL SEPARATION AND BANDWIDTH TEST.....	23
10.1 Test Standard and Limit	23
10.2 Test Setup.....	23
10.3 Test Procedure.....	23
10.4 Deviation From Test Standard.....	24
10.5 EUT Operating Condition	24
10.6 Test Data.....	24
11. PEAK OUTPUT POWER TEST.....	25
11.1 Test Standard and Limit	25
11.2 Test Setup.....	25
11.3 Test Procedure.....	25
11.4 Deviation From Test Standard.....	25
11.5 EUT Operating Condition	25
11.6 Test Data.....	25
12. ANTENNA REQUIREMENT.....	26
12.1 Standard Requirement.....	26
12.2 Deviation From Test Standard.....	26
12.3 Antenna Connected Construction	26
12.4 Result.....	26
ATTACHMENT A-- RADIATED EMISSION TEST DATA	27
ATTACHMENT B-- RESTRICTED BANDS REQUIREMENT AND BAND EDGE TEST DATA	38
ATTACHMENT C-- NUMBER OF HOPPING CHANNEL TEST DATA.....	56
ATTACHMENT D-- AVERAGE TIME OF OCCUPANCY TEST DATA.....	58
ATTACHMENT E-- CHANNEL SEPARATION AND BANDWIDTH TEST DATA	64
ATTACHMENT F-- PEAK OUTPUT POWER TEST DATA.....	72

1. General Information about EUT

1.1 Client Information

Applicant	:	SAGE HUMAN ELECTRONICS INTERNATIONAL CO.,LTD.
Address	:	4F.,A Building,Rongli Industrial Park,No.2 Guiyuan Rd.Guihua Community,Guanlan Town,Longhua New Dist. Shenzhen, China
Manufacturer	:	SAGE HUMAN ELECTRONICS INTERNATIONAL CO.,LTD.
Address	:	4F.,A Building,Rongli Industrial Park,No.2 Guiyuan Rd.Guihua Community,Guanlan Town,Longhua New Dist. Shenzhen, China

1.2 General Description of EUT (Equipment Under Test)

EUT Name	:	Bluetooth FM Transmitter for Car	
Models No.	:	C78, C78Q, C78S, BH477A, BH477B, BH477C	
Model Difference	:	All these models are identical in the same PCB, layout and electrical circuit, the only difference is appearance color.	
Product Description	:	Operation Frequency:	Bluetooth V5.0: 2402~2480 MHz
		Number of Channel:	Bluetooth: 79 Channels See Note 2
		Max Peak Output Power:	Bluetooth: 1.177dBm(GFSK)
		Antenna Gain:	-0.68dBi Chip Antenna
		Modulation Type:	GFSK(1Mbps) π /4-DQPSK(2Mbps) 8-DPSK(3Mbps)
Power Supply	:	Input: DC 12-24V USB Output: QC3.0(DC 5V 3A, 9V2A, 12V1.5A) Type-C Output: PD3.0(DC 5V 3A, 9V2A, 12V1.5A) Shared Output: DC 5V4.8A(MAX)	
Software Version	:	N/A	
Hardware Version	:	C78_2819-V1.0	
Connecting I/O Port(S)	:	Please refer to the User's Manual	

Note:

This Test Report is FCC Part 15.247 for Bluetooth, the test procedure follows the KDB 558074 D01 15.247 Meas Guidance v05r02.

(1) For a more detailed features description, please refer to the manufacturer’s specifications or the User’s Manual. Channel List:

Bluetooth Channel List					
Channel	Frequency (MHz)	Channel	Frequency (MHz)	Channel	Frequency (MHz)
00	2402	27	2429	54	2456
01	2403	28	2430	55	2457
02	2404	29	2431	56	2458
03	2405	30	2432	57	2459
04	2406	31	2433	58	2460
05	2407	32	2434	59	2461
06	2408	33	2435	60	2462
07	2409	34	2436	61	2463
08	2410	35	2437	62	2464
09	2411	36	2438	63	2465
10	2412	37	2439	64	2466
11	2413	38	2440	65	2467
12	2414	39	2441	66	2468
13	2415	40	2442	67	2469
14	2416	41	2443	68	2470
15	2417	42	2444	69	2471
16	2418	43	2445	70	2472
17	2419	44	2446	71	2473
18	2420	45	2447	72	2474
19	2421	46	2448	73	2475
20	2422	47	2449	74	2476
21	2423	48	2450	75	2477
22	2424	49	2451	76	2478
23	2425	50	2452	77	2479
24	2426	51	2453	78	2480
25	2427	52	2454		
26	2428	53	2455		

(2) The Antenna information about the equipment is provided by the applicant.

1.3 Block Diagram Showing the Configuration of System Tested

Charging + TX Mode

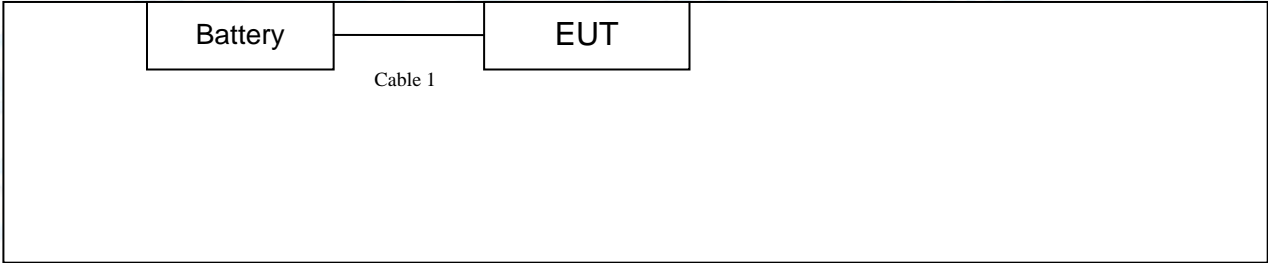

1.4 Description of Support Units

Equipment Information				
Name	Model	FCC ID/VOC	Manufacturer	Used “√”
----	---	----	---	----
Cable Information				
Number	Shielded Type	Ferrite Core	Length	Note
---	----	----	----	---

1.5 Description of Test Mode

To investigate the maximum EMI emission characteristics generates from EUT, the test system was pre-scanning tested base on the consideration of following EUT operation mode or test configuration mode which possible have effect on EMI emission level. Each of these EUT operation mode(s) or test configuration mode(s) mentioned follow was evaluated respectively.

For Conducted Test	
Final Test Mode	Description
Mode 1	Charging + TX Mode Channel 00
For Radiated Test	
Final Test Mode	Description
Mode 1	TX GFSK Mode Channel 00
Mode 2	TX Mode(GFSK) Channel 00/39/78
Mode 3	TX Mode($\pi/4$ -DQPSK) Channel 00/39/78
Mode 4	TX Mode(8-DPSK) Channel 00/39/78
Mode 5	Hopping Mode(GFSK)
Mode 6	Hopping Mode($\pi/4$ -DQPSK)
Mode 7	Hopping Mode(8-DPSK)
Note : The antenna gain provided by the applicant, The battery and the verified for the RF conduction test provided by TOBY test lab.	

Note:

- (1) For all test, we have verified the construction and function in typical operation. And all the test modes were carried out with the EUT in transmitting operation in maximum power with all kinds of data rate. We have pretested all the test modes above.

According to ANSI C63.10 standards, the measurements are performed at the highest, middle, lowest available channels, and the worst case data rate as follows:

- TX Mode: GFSK (1 Mbps)
- TX Mode: $\pi/4$ -DQPSK (2 Mbps)
- TX Mode: 8-DPSK (3Mbps)

- (2) The EUT is considered a portable unit; it was pre-tested on the positioned of each 3 axis, X-plane, Y-plane and Z-plane. The worst case was found positioned on X-plane as the normal use. Therefore only the test data of this X-plane was used for radiated emission measurement test.

1.6 Description of Test Software Setting

During testing channel power controlling software provided by the customer was used to control the operating channel as well as the output power level. The RF output power selection is for the setting of RF output power expected by the customer and is going to be fixed on the firmware of the final end product power parameters of Bluetooth mode.

Test Software Version	BT FCC TOOL		
Frequency	2402 MHz	2441MHz	2480 MHz
GFSK	DEF	DEF	DEF
$\pi/4$ -DQPSK	DEF	DEF	DEF
8-DPSK	DEF	DEF	DEF

1.7 Measurement Uncertainty

The reported uncertainty of measurement $y \pm U$, where expended uncertainty U is based on a standard uncertainty multiplied by a coverage factor of $k=2$, providing a level of confidence of approximately 95 %.

Test Item	Parameters	Expanded Uncertainty (U_{Lab})
Conducted Emission	Level Accuracy: 9kHz~150kHz 150kHz to 30MHz	± 3.50 dB ± 3.10 dB
Radiated Emission	Level Accuracy: 9kHz to 30 MHz	± 4.60 dB
Radiated Emission	Level Accuracy: 30MHz to 1000 MHz	± 4.50 dB
Radiated Emission	Level Accuracy: Above 1000MHz	± 4.20 dB

1.8 Test Facility

The testing report were performed by the Shenzhen Toby Technology Co., Ltd., in their facilities located at 1/F.,Building 6, Rundongsheng Industrial Zone, Longzhu, Xixiang, Bao'an District, Shenzhen, Guangdong, China. At the time of testing, the following bodies accredited the Laboratory:

CNAS (L5813)

The Laboratory has been accredited by CNAS to ISO/IEC 17025: 2017 General Requirements for the Competence of Testing and Calibration Laboratories for the competence in the field of testing. And the Registration No.: CNAS L5813.

A2LA Certificate No.: 4750.01

The laboratory has been accredited by American Association for Laboratory Accreditation(A2LA) to ISO/IEC 17025: 2017 General Requirements for the Competence of Testing and Calibration Laboratories for the technical competence in the field of Electrical Testing. And the A2LA Certificate No.: 4750.01. FCC Accredited Test Site Number: 854351. Designation Number: CN1223.

IC Registration No.: (11950A)

The Laboratory has been registered by Certification and Engineering Bureau of Industry Canada for radio equipment testing. The site registration: Site# 11950A.

2. Test Summary

FCC Part 15 Subpart C(15.247)/ RSS 247 Issue 2					
Standard Section		Test Item	Test Sample(s)	Judgment	Remark
FCC	IC				
15.203		Antenna Requirement	20201118-14-5#	PASS	N/A
15.207	RSS-GEN 7.2.2	Conducted Emission	N/A	N/A	N/A
15.205	RSS-Gen 7.2.3	Restricted Bands	20201118-14-5#	PASS	N/A
15.247(a)(1)	RSS 247 5.1 (2)	Hopping Channel Separation	20201118-14-5#	PASS	N/A
15.247(a)(1)	RSS 247 5.1 (4)	Dwell Time	20201118-14-5#	PASS	N/A
15.247(b)(1)	RSS 247 5.4 (2)	Peak Output Power	20201118-14-5#	PASS	N/A
15.247(b)(1)	RSS 247 5.1 (4)	Number of Hopping Frequency	20201118-14-5#	PASS	N/A
15.247(d)	RSS 247 5.5	Band Edge	20201118-14-6#	PASS	N/A
15.247(c)& 15.209	RSS 247 5.5	Radiated Spurious Emission	20201118-14-6#	PASS	N/A
15.247(a)	RSS 247 5.1 (1)	99% Occupied Bandwidth & 20dB Bandwidth	20201118-14-5#	PASS	N/A

Note: (1)N/A is an abbreviation for Not Applicable.
 (2) The EUT is powered by DC battery, no requirement for this test item.

3. Test Software

Test Item	Test Software	Manufacturer	Version No.
Conducted Emission	EZ-EMC	EZ	CDI-03A2
Radiation Emission	EZ-EMC	EZ	FA-03A2RE
RF Conducted Measurement	MTS-8310	MWRfTest	V2.0.0.0

4. Test Equipment

Conducted Emission Test					
Equipment	Manufacturer	Model No.	Serial No.	Last Cal.	Cal. Due Date
EMI Test Receiver	Rohde & Schwarz	ESCI	100321	Jul. 06, 2020	Jul. 05, 2021
RF Switching Unit	Compliance Direction Systems Inc	RSU-A4	34403	Jul. 06, 2020	Jul. 05, 2021
AMN	SCHWARZBECK	NNBL 8226-2	8226-2/164	Jul. 06, 2020	Jul. 05, 2021
LISN	Rohde & Schwarz	ENV216	101131	Jul. 06, 2020	Jul. 05, 2021
Radiation Emission Test					
Equipment	Manufacturer	Model No.	Serial No.	Last Cal.	Cal. Due Date
Spectrum Analyzer	Agilent	E4407B	MY45106456	Jul. 06, 2020	Jul. 05, 2021
EMI Test Receiver	Rohde & Schwarz	ESPI	100010/007	Jul. 06, 2020	Jul. 05, 2021
Spectrum Analyzer	Rohde & Schwarz	FSVR	102197	Jul. 06, 2020	Jul. 05, 2021
Bilog Antenna	ETS-LINDGREN	3142E	00117537	Mar.01, 2020	Feb. 28, 2022
Horn Antenna	ETS-LINDGREN	3117	00143207	Mar.01, 2020	Feb. 28, 2022
Horn Antenna	ETS-LINDGREN	BBHA 9170	BBHA9170582	Mar.01, 2020	Feb. 28, 2022
Loop Antenna	SCHWARZBECK	FMZB 1519 B	1519B-059	Jul. 07, 2020	Jul. 06, 2021
Pre-amplifier	Sonoma	310N	185903	Mar.01, 2020	Feb. 28, 2021
Pre-amplifier	HP	8449B	3008A00849	Mar.01, 2020	Feb. 28, 2021
Cable	HUBER+SUHNER	100	SUCOFLEX	Mar.01, 2020	Feb. 28, 2021
Positioning Controller	ETS-LINDGREN	2090	N/A	N/A	N/A
Antenna Conducted Emission					
Equipment	Manufacturer	Model No.	Serial No.	Last Cal.	Cal. Due Date
Spectrum Analyzer	Agilent	E4407B	MY45106456	Jul. 06, 2020	Jul. 05, 2021
Spectrum Analyzer	Rohde & Schwarz	ESCI	100010/007	Jul. 06, 2020	Jul. 05, 2021
MXA Signal Analyzer	Agilent	N9020A	MY49100060	Sep. 11, 2020	Sep. 10, 2021
Vector Signal Generator	Agilent	N5182A	MY50141294	Sep. 11, 2020	Sep. 10, 2021
Analog Signal Generator	Agilent	N5181A	MY50141953	Sep. 11, 2020	Sep. 10, 2021
RF Power Sensor	DARE!! Instruments	RadiPowerRPR3006W	17100015SNO26	Sep. 11, 2020	Sep. 10, 2021
	DARE!! Instruments	RadiPowerRPR3006W	17100015SNO29	Sep. 11, 2020	Sep. 10, 2021
	DARE!! Instruments	RadiPowerRPR3006W	17100015SNO31	Sep. 11, 2020	Sep. 10, 2021
	DARE!! Instruments	RadiPowerRPR3006W	17100015SNO33	Sep. 11, 2020	Sep. 10, 2021

5. Conducted Emission Test

5.1 Test Standard and Limit

5.1.1 Test Standard
FCC Part 15.207

5.1.2 Test Limit

Conducted Emission Test Limit

Frequency	Maximum RF Line Voltage (dB μ V)	
	Quasi-peak Level	Average Level
150kHz~500kHz	66 ~ 56 *	56 ~ 46 *
500kHz~5MHz	56	46
5MHz~30MHz	60	50

Notes:

- (1) *Decreasing linearly with logarithm of the frequency.
- (2) The lower limit shall apply at the transition frequencies.
- (3) The limit decrease in line with the logarithm of the frequency in the range of 0.15 to 0.50MHz.

5.2 Test Setup

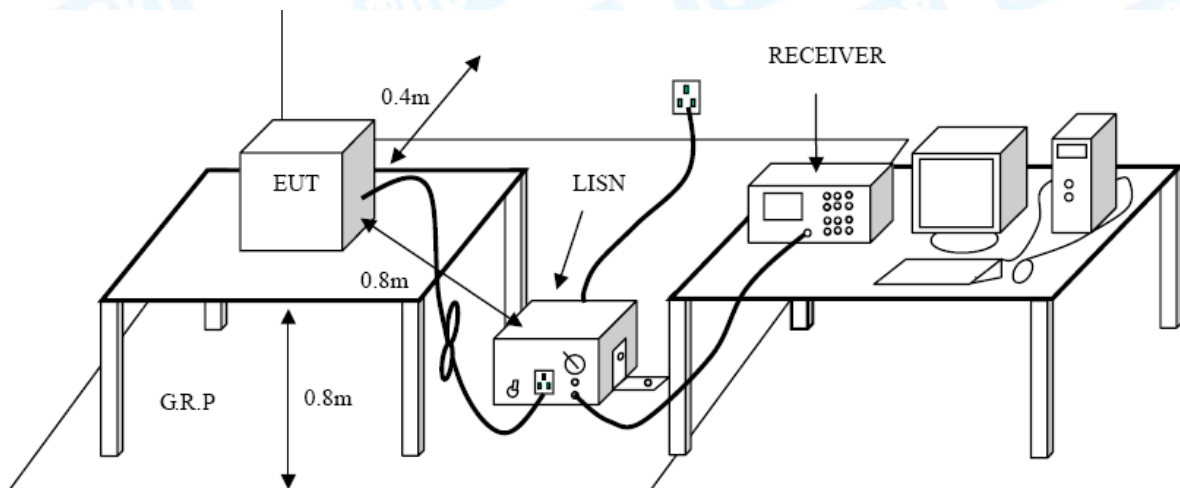

5.3 Test Procedure

The EUT was placed 0.8 meters from the horizontal ground plane with EUT being connected to the power mains through a line impedance stabilization network (LISN). All other support equipments powered from additional LISN(s). The LISN provide 50 Ohm/50uH of coupling impedance for the measuring instrument.

Interconnecting cables that hang closer than 40 cm to the ground plane shall be folded back and forth in the center forming a bundle 30 to 40 cm long.

I/O cables that are not connected to a peripheral shall be bundled in the center. The end of the cable may be terminated, if required, using the correct terminating impedance. The overall length shall not exceed 1 m.

LISN at least 80 cm from nearest part of EUT chassis

The bandwidth of EMI test receiver is set at 9kHz, and the test frequency band is from 0.15MHz to 30MHz.

5.4 Deviation From Test Standard

No deviation

5.5 EUT Operating Mode

Please refer to the description of test mode.

5.6 Test Data

The EUT is powered by DC battery, no requirement for this test item.

6. Radiated Emission Test

6.1 Test Standard and Limit

- 6.1.1 Test Standard
FCC Part 15.209
- 6.1.2 Test Limit

Radiated Emission Limit (9 kHz~1000MHz)

Frequency (MHz)	Field Strength (microvolt/meter)	Measurement Distance (meters)
0.009~0.490	2400/F(KHz)	300
0.490~1.705	24000/F(KHz)	30
1.705~30.0	30	30
30~88	100	3
88~216	150	3
216~960	200	3
Above 960	500	3

Radiated Emission Limit (Above 1000MHz)

Frequency (MHz)	Distance of 3m (dBuV/m)	
	Peak	Average
Above 1000	74	54

Note:

- (1) The tighter limit applies at the band edges.
- (2) Emission Level (dBuV/m)=20log Emission Level (uV/m)

6.2 Test Setup

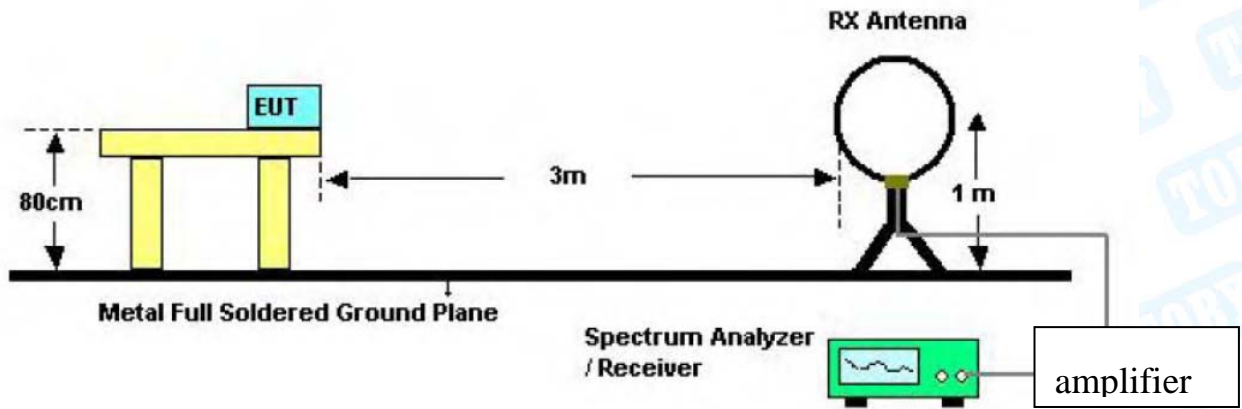

Below 30MHz Test Setup

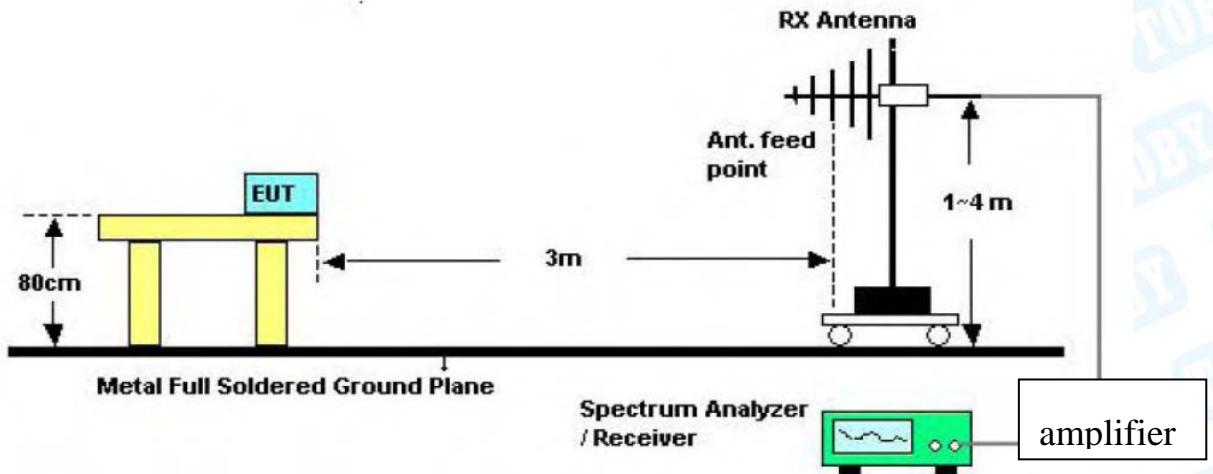

Below 1000MHz Test Setup

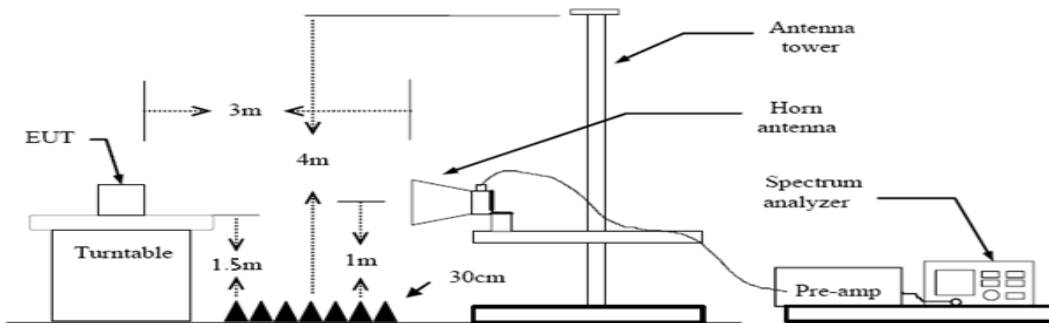

Above 1GHz Test Setup

6.3 Test Procedure

- (1) The measuring distance of 3m shall be used for measurements at frequency up to 1GHz and above 1 GHz. The EUT was placed on a rotating 0.8m high above ground, the table was rotated 360 degrees to determine the position of the highest radiation.
- (2) Measurements at frequency above 1GHz. The EUT was placed on a rotating 1.5m high above the ground. RF absorbers covered the ground plane with a minimum area of 3.0m by 3.0m between the EUT and measurement receiver antenna. The RF absorber shall not exceed 30cm in high above the conducting floor. The table was rotated 360 degrees to determine the position of the highest radiation.
- (3) The Test antenna shall vary between 1m and 4m, Both Horizontal and Vertical antenna are set to make measurement.
- (4) The initial step in collecting conducted emission data is a spectrum analyzer peak detector mode pre-scanning the measurement frequency range. Significant peaks are then marked and then Quasi Peak detector mode re-measured.
- (5) If the Peak Mode measured value compliance with and lower than Quasi Peak Mode Limit Bellow 1 GHz, the EUT shall be deemed to meet QP Limits and then no additional QP Mode measurement performed. But the Peak Value and average value both need to comply with applicable limit above 1 GHz.
- (6) Testing frequency range below 1GHz the measuring instrument use VBW=120 kHz with Quasi-peak detection.
- (7) Testing frequency range above 1GHz the measuring instrument use RBW=1 MHz and VBW=3 MHz with Peak Detector for Peak Values, and use RBW=1 MHz and VBW=10 Hz with Peak Detector for Average Values.
- (8) For the actual test configuration, please see the test setup photo.

6.4 Deviation From Test Standard

No deviation

6.4 EUT Operating Condition

The Equipment Under Test was set to Continual Transmitting in maximum power in TX mode.

6.5 Test Data

Remark: During testing above 1GHz the measuring instrument use RBW=1 MHz and VBW=3 MHz with Peak Detector for Peak Values, and use RBW=1 MHz and VBW=10 Hz with Peak Detector for Average Values.

Please refer to the Attachment A.

7. Restricted Bands Requirement

7.1 Test Standard and Limit

7.1.1 Test Standard

FCC Part 15.209

FCC Part 15.205

7.1.2 Test Limit

Restricted Frequency Band (MHz)	Distance of 3m (dBuV/m)	
	Peak	Average
2310 ~2390	74	54
2483.5 ~2500	74	54

Note: All restriction bands have been tested, only the worst case is reported.

7.2 Test Setup

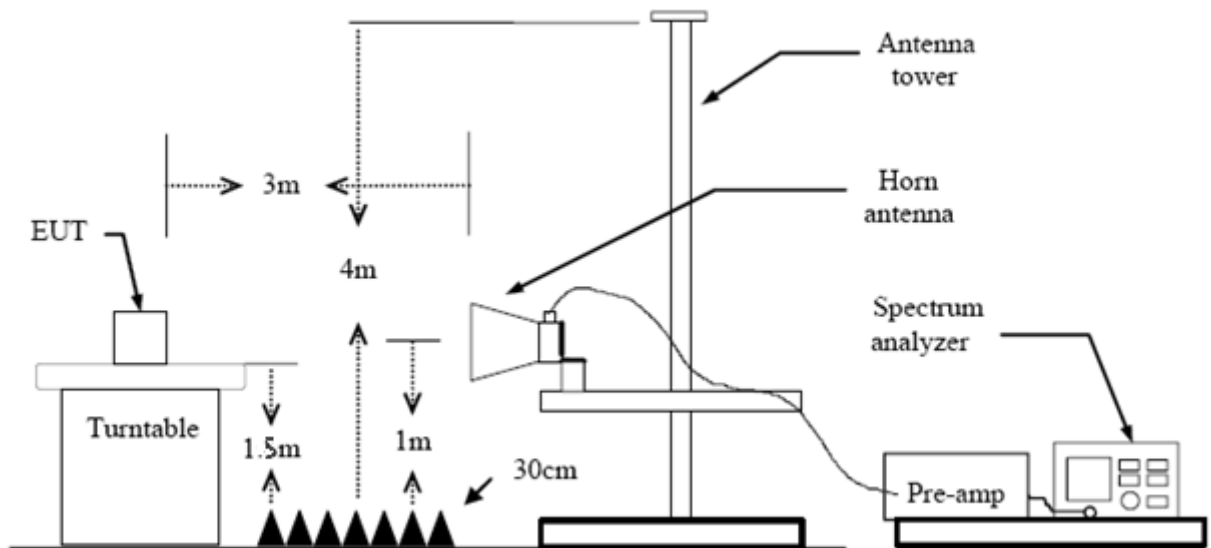

7.3 Test Procedure

- (1) The measuring distance of 3m shall be used for measurements at frequency up to 1GHz and above 1 GHz. The EUT was placed on a rotating 0.8m high above ground, the table was rotated 360 degrees to determine the position of the highest radiation.
- (2) Measurements at frequency above 1GHz. The EUT was placed on a rotating 1.5m high above the ground. RF absorbers covered the ground plane with a minimum area of 3.0m by 3.0m between the EUT and measurement receiver antenna. The RF absorber shall not exceed 30cm in high above the conducting floor. The table was rotated 360 degrees to determine the position of the highest radiation.
- (3) The Test antenna shall vary between 1m and 4m, Both Horizontal and Vertical antenna are set to make measurement.
- (4) The initial step in collecting conducted emission data is a spectrum analyzer peak detector mode pre-scanning the measurement frequency range. Significant peaks are then marked and then Quasi Peak detector mode re-measured.
- (5) If the Peak Mode measured value compliance with and lower than Quasi Peak Mode Limit Bellow 1 GHz, the EUT shall be deemed to meet QP Limits and then no additional QP Mode measurement performed. But the Peak Value and average value both need to comply with applicable limit above 1 GHz.
- (6) Testing frequency range below 1GHz the measuring instrument use VBW=120 kHz with Quasi-peak detection.
- (7) Testing frequency range above 1GHz the measuring instrument use RBW=1 MHz and VBW=3 MHz with Peak Detector for Peak Values, and use RBW=1 MHz and VBW=10 Hz with AVG Detector for Average Values.
- (8) For the actual test configuration, please see the test setup photo.

7.4 Deviation From Test Standard

No deviation

7.5 EUT Operating Condition

The Equipment Under Test was set to Continual Transmitting in maximum power.

7.6 Test Data

Remark: During testing above 1GHz the measuring instrument use RBW=1 MHz and VBW=3 MHz with Peak Detector for Peak Values, and use RBW=1 MHz and VBW=10 Hz with Peak Detector for Average Values.

All restriction bands have been tested, only the worst case is reported.

Please refer to the Attachment B.

8. Number of Hopping Channel

8.1 Test Standard and Limit

- 8.1.1 Test Standard
FCC Part 15.247 (a)(1)
- 8.1.2 Test Limit

Section	Test Item	Limit
15.247	Number of Hopping Channel	>15

8.2 Test Setup

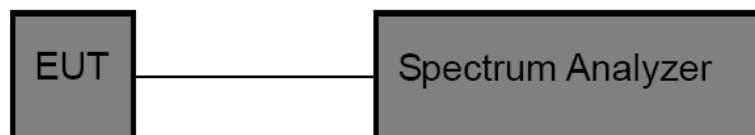

8.3 Test Procedure

- (1) The EUT was directly connected to the spectrum analyzer and antenna output port as show in the block diagram above.
- (2) Spectrum Setting: RBW=100 KHz, VBW=100 KHz, Sweep time= Auto.

8.4 Deviation From Test Standard

No deviation

8.5 EUT Operating Condition

The EUT was set to the Hopping Mode by the Customer.

8.6 Test Data

Please refer to the Attachment C.

9. Average Time of Occupancy

9.1 Test Standard and Limit

9.1.1 Test Standard
FCC Part 15.247 (a)(1)

9.1.2 Test Limit

Section	Test Item	Limit
15.247(a)(1)	Average Time of Occupancy	0.4 sec

9.2 Test Setup

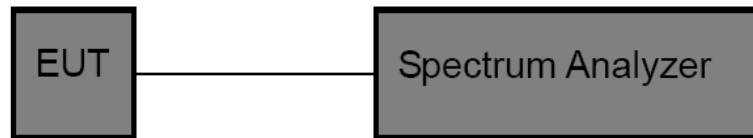

9.3 Test Procedure

- (1) The EUT was directly connected to the spectrum analyzer and antenna output port as show in the block diagram above.
- (2) Spectrum Setting: RBW=1MHz, VBW=1MHz.
- (3) Use video trigger with the trigger level set to enable triggering only on full pulses.
- (4) Sweep Time is more than once pulse time.
- (5) Set the centre frequency on any frequency would be measure and set the frequency span to zero.
- (6) Measure the maximum time duration of one single pulse.
- (7) Set the EUT for packet transmitting.
- (8) Measure the maximum time duration of one single pulse.

9.4 EUT Operating Condition

The average time of occupancy on any channel within the Period can be calculated with formulas:

$$\{\text{Total of Dwell}\} = \{\text{Pulse Time}\} * (1600 / X) / \{\text{Number of Hopping Frequency}\} * \{\text{Period}\}$$

$$\{\text{Period}\} = 0.4s * \{\text{Number of Hopping Frequency}\}$$

Note: X=2 or 4 or 6 (1DH1=2, 1DH3=4, 1DH5=6. 2DH1=2, 2DH3=4, 2DH5=6. 3DH1=2, 3DH3=4, 3DH5=6)

The lowest, middle and highest channels are selected to perform testing to record the dwell time of each occupation measured in this channel, which is called Pulse Time here.

9.4 Deviation From Test Standard

No deviation

9.5 EUT Operating Condition

The EUT was set to the Hopping Mode by the Customer.

9.6 Test Data

Please refer to the Attachment D.

10. Channel Separation and Bandwidth Test

10.1 Test Standard and Limit

- 10.1.1 Test Standard
FCC Part 15.247
- 10.1.2 Test Limit

Test Item	Limit	Frequency Range(MHz)
Bandwidth	≤ 1 MHz (20dB bandwidth)	2400~2483.5
Channel Separation	>25 KHz or $>$ two-thirds of the 20 dB bandwidth Which is greater	2400~2483.5

10.2 Test Setup

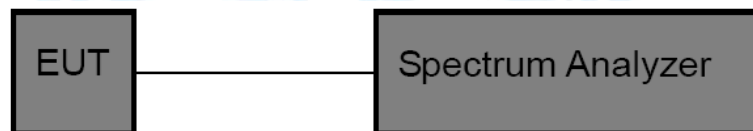

10.3 Test Procedure

- (1) The EUT was directly connected to the spectrum analyzer and antenna output port as show in the block diagram above.
- (2) Spectrum Setting:
Channel Separation: RBW=100 kHz, VBW=100 kHz.
Bandwidth: RBW=30 kHz, VBW=100 kHz.
- (3) The bandwidth is measured at an amplitude level reduced 20dB from the reference level. The reference level is the level of the highest amplitude signal observed from the transmitter at the fundamental frequency. Once the reference level is established, the equipment is conditioned with typical modulating signal to produce the worst –case (i.e the widest) bandwidth.
- (4) Measure the channel separation the spectrum analyzer was set to Resolution Bandwidth:30 kHz, and Video Bandwidth:100 kHz. Sweep Time set auto.

10.4 Deviation From Test Standard

No deviation

10.5 EUT Operating Condition

The EUT was set to the Hopping Mode for Channel Separation Test and continuously transmitting for the Bandwidth Test.

10.6 Test Data

Please refer to the Attachment E.

11. Peak Output Power Test

11.1 Test Standard and Limit

11.1.1 Test Standard

FCC Part 15.247 (b) (1)

11.1.2 Test Limit

Test Item	Limit	Frequency Range(MHz)
Peak Output Power	Hopping Channels>75 Power<1W(30dBm) Other <125 mW(21dBm)	2400~2483.5

11.2 Test Setup

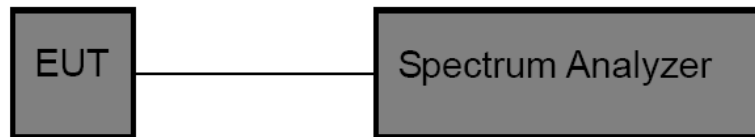

11.3 Test Procedure

- (1) The EUT was directly connected to the spectrum analyzer and antenna output port as show in the block diagram above.
- (2) Spectrum Setting:
 Peak Detector: RBW=1 MHz, VBW=3 MHz for bandwidth less than 1MHz.
 RBW=3 MHz, VBW ≥ RBW for bandwidth more than 1MHz.

11.4 Deviation From Test Standard

No deviation

11.5 EUT Operating Condition

The EUT was set to continuously transmitting in the max power during the test.

11.6 Test Data

Please refer to the Attachment F.

12. Antenna Requirement

12.1 Standard Requirement

12.1.1 Standard

FCC Part 15.203

12.1.2 Requirement

An intentional radiator shall be designed to ensure that no antenna other than that furnished by the responsible party shall be used with the device. The use of a permanently attached antenna or of an antenna that uses a unique coupling to the intentional radiator shall be considered sufficient to comply with the provisions of this Section. The manufacturer may design the unit so that a broken antenna can be replaced by the user, but the use of a standard antenna jack or electrical connector is prohibited.

12.2 Deviation From Test Standard

No deviation

12.3 Antenna Connected Construction

The gains of the antenna used for transmitting is -0.68dBi, and the antenna connector is de-signed with permanent attachment and no consideration of replacement. Please see the EUT photo for details.

12.4 Result

The EUT antenna is a Chip Antenna. It complies with the standard requirement.

Antenna Type
<input checked="" type="checkbox"/> Permanent attached antenna
<input type="checkbox"/> Unique connector antenna
<input type="checkbox"/> Professional installation antenna

Attachment A-- Radiated Emission Test Data

9KHz~30MHz

From 9KHz to 30MHz: Conclusion: PASS

Note: The amplitude of spurious emissions which are attenuated by more than 20dB below the permissible value has no need to be reported.

30MHz~1GHz

Temperature:	23.6°C	Relative Humidity:	45%
Test Voltage:	DC 12V		
Ant. Pol.	Horizontal		
Test Mode:	Mode 1 (GFSK 2402MHz)		
Remark:	Only worse case is reported		

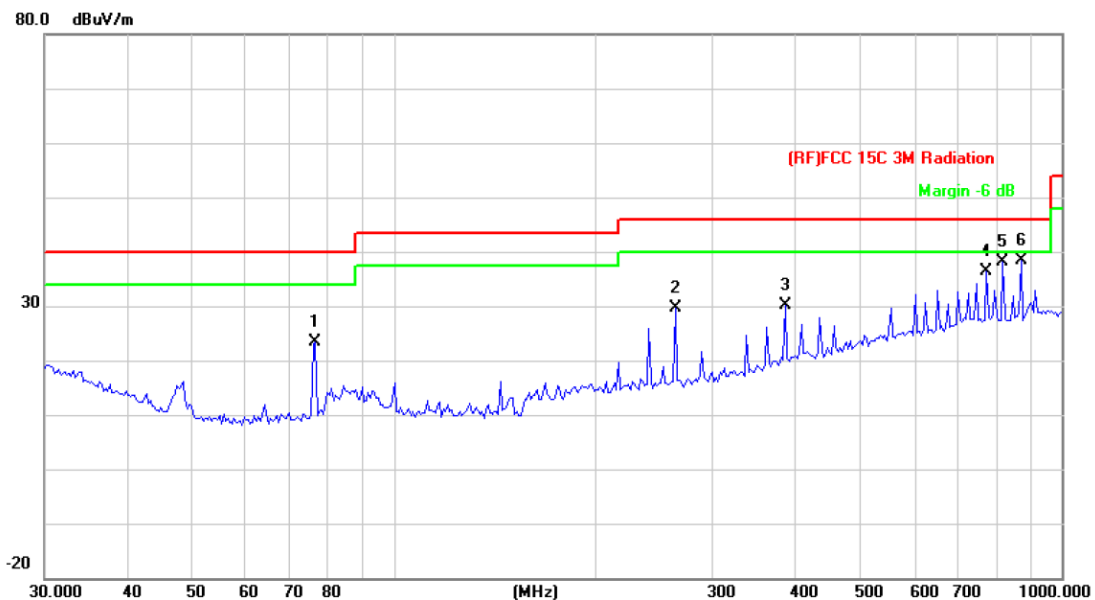

No.	Mk.	Freq. MHz	Reading Level dBuV	Correct Factor dB/m	Measure- ment dBuV/m	Limit dBuV/m	Over dB	Detector
1		76.2442	46.22	-22.82	23.40	40.00	-16.60	peak
2		263.8190	46.60	-16.96	29.64	46.00	-16.36	peak
3		385.2805	43.19	-12.98	30.21	46.00	-15.79	peak
4		771.4486	42.65	-6.20	36.45	46.00	-9.55	peak
5		815.9678	43.77	-5.73	38.04	46.00	-7.96	peak
6	*	869.1301	43.57	-5.26	38.31	46.00	-7.69	peak

*:Maximum data x:Over limit !:over margin

Remark:

1. Corr. = Antenna Factor (dB/m) + Cable Loss (dB)
2. QuasiPeak (dBμV/m)= Corr. (dB/m)+ Read Level (dBμV)
3. Margin (dB) = QuasiPeak (dBμV/m)-Limit QPK(dBμV/m)

Temperature:	23.6°C	Relative Humidity:	45%
Test Voltage:	DC 12V		
Ant. Pol.	Vertical		
Test Mode:	Mode 1 (GFSK 2402MHz)		
Remark:	Only worse case is reported		

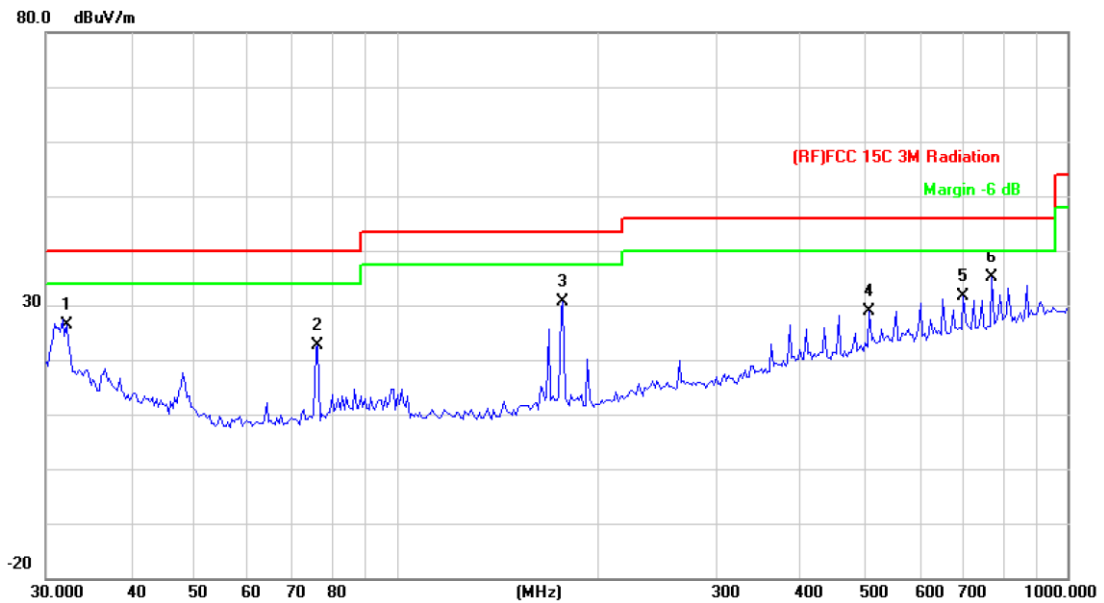

No.	Mk.	Freq. MHz	Reading Level dBuV	Correct Factor dB/m	Measure- ment dBuV/m	Limit dBuV/m	Over dB	Detector
1		32.1794	40.85	-14.57	26.28	40.00	-13.72	peak
2		76.2442	45.55	-22.82	22.73	40.00	-17.27	peak
3		176.8877	50.98	-20.23	30.75	43.50	-12.75	peak
4		506.4791	39.12	-10.28	28.84	46.00	-17.16	peak
5		699.3046	38.39	-6.78	31.61	46.00	-14.39	peak
6	*	771.4486	41.35	-6.20	35.15	46.00	-10.85	peak

*:Maximum data x:Over limit !:over margin

Remark:

1. Corr. = Antenna Factor (dB/m) + Cable Loss (dB)
2. QuasiPeak (dBμV/m)= Corr. (dB/m)+ Read Level (dBμV)
3. Margin (dB) = QuasiPeak (dBμV/m)-Limit QPK(dBμV/m)

Above 1GHz(Only worse case is reported)

Temperature:	23.6°C	Relative Humidity:	45%
Test Voltage:	DC 12V		
Ant. Pol.	Horizontal		
Test Mode:	TX GFSK Mode 2402MHz		
Remark:	No report for the emission which more than 20 dB below the prescribed limit.		

No.	Mk.	Freq.	Reading Level	Correct Factor	Measurement	Limit	Over	Detector
		MHz	dBuV	dB	dBuV/m	dBuV/m	dB	
1		4804.640	40.71	13.44	54.15	74.00	-19.85	peak
2	*	4804.640	28.56	13.44	42.00	54.00	-12.00	AVG

Remark:
 1. Corr. = Antenna Factor (dB/m) + Cable Loss (dB)
 2. Peak/AVG (dBμV/m)= Corr. (dB/m)+ Read Level (dBμV)
 3. Margin (dB) = Peak/AVG (dBμV/m)-Limit PK/AVG(dBμV/m)

Temperature:	23.6°C	Relative Humidity:	45%
Test Voltage:	DC 12V		
Ant. Pol.	Vertical		
Test Mode:	TX GFSK Mode 2402MHz		
Remark:	No report for the emission which more than 20 dB below the prescribed limit.		

No.	Mk.	Freq.	Reading Level	Correct Factor	Measurement	Limit	Over	Detector
		MHz	dBuV	dB	dBuV/m	dBuV/m	dB	
1		4804.150	43.27	13.44	56.71	74.00	-17.29	peak
2	*	4804.150	28.78	13.44	42.22	54.00	-11.78	AVG

Remark:
 1. Corr. = Antenna Factor (dB/m) + Cable Loss (dB)
 2. Peak/AVG (dBμV/m)= Corr. (dB/m)+ Read Level (dBμV)
 3. Margin (dB) = Peak/AVG (dBμV/m)-Limit PK/AVG(dBμV/m)

Temperature:	23.6°C	Relative Humidity:	45%
Test Voltage:	DC 12V		
Ant. Pol.	Horizontal		
Test Mode:	TX GFSK Mode 2441MHz		
Remark:	No report for the emission which more than 20 dB below the prescribed limit.		

No.	Mk.	Freq.	Reading Level	Correct Factor	Measurement	Limit	Over	Detector
		MHz	dBuV	dB	dBuV/m	dBuV/m	dB	
1	*	4881.900	29.21	13.90	43.11	54.00	-10.89	AVG
2		4882.320	42.57	13.90	56.47	74.00	-17.53	peak

Remark:

1. Corr. = Antenna Factor (dB/m) + Cable Loss (dB)
2. Peak/AVG (dBμV/m)= Corr. (dB/m)+ Read Level (dBμV)
3. Margin (dB) = Peak/AVG (dBμV/m)-Limit PK/AVG(dBμV/m)

Temperature:	23.6°C	Relative Humidity:	45%
Test Voltage:	DC 12V		
Ant. Pol.	Vertical		
Test Mode:	TX GFSK Mode 2441MHz		
Remark:	No report for the emission which more than 20 dB below the prescribed limit.		

No.	Mk.	Freq.	Reading Level	Correct Factor	Measurement	Limit	Over	Detector
		MHz	dBuV	dB	dBuV/m	dBuV/m	dB	
1		4882.100	41.15	13.90	55.05	74.00	-18.95	peak
2	*	4882.100	28.43	13.90	42.33	54.00	-11.67	AVG

Remark:

1. Corr. = Antenna Factor (dB/m) + Cable Loss (dB)
2. Peak/AVG (dBμV/m)= Corr. (dB/m)+ Read Level (dBμV)
3. Margin (dB) = Peak/AVG (dBμV/m)-Limit PK/AVG(dBμV/m)

Temperature:	23.6°C	Relative Humidity:	45%
Test Voltage:	DC 12V		
Ant. Pol.	Horizontal		
Test Mode:	TX GFSK Mode 2480MHz		
Remark:	No report for the emission which more than 20 dB below the prescribed limit.		

No.	Mk.	Freq.	Reading Level	Correct Factor	Measurement	Limit	Over	Detector
		MHz	dBuV	dB	dBuV/m	dBuV/m	dB	
1		4959.752	40.65	14.36	55.01	74.00	-18.99	peak
2	*	4960.145	27.80	14.36	42.16	54.00	-11.84	AVG

Remark:

1. Corr. = Antenna Factor (dB/m) + Cable Loss (dB)
2. Peak/AVG (dBuV/m)= Corr. (dB/m)+ Read Level (dBuV)
3. Margin (dB) = Peak/AVG (dBuV/m)-Limit PK/AVG(dBuV/m)

Temperature:	23.6°C	Relative Humidity:	45%
Test Voltage:	DC 12V		
Ant. Pol.	Vertical		
Test Mode:	TX GFSK Mode 2480MHz		
Remark:	No report for the emission which more than 20 dB below the prescribed limit.		

No.	Mk.	Freq.	Reading Level	Correct Factor	Measurement	Limit	Over	Detector
		MHz	dBuV	dB	dBuV/m	dBuV/m	dB	
1		4960.022	41.18	14.36	55.54	74.00	-18.46	peak
2	*	4960.022	27.69	14.36	42.05	54.00	-11.95	AVG

Remark:

1. Corr. = Antenna Factor (dB/m) + Cable Loss (dB)
2. Peak/AVG (dBuV/m)= Corr. (dB/m)+ Read Level (dBuV)
3. Margin (dB) = Peak/AVG (dBuV/m)-Limit PK/AVG(dBuV/m)

Temperature:	23.6°C	Relative Humidity:	45%
Test Voltage:	DC 12V		
Ant. Pol.	Horizontal		
Test Mode:	TX π /4-DQPSK Mode 2402MHz		
Remark:	No report for the emission which more than 20 dB below the prescribed limit.		

No.	Mk.	Freq.	Reading Level	Correct Factor	Measurement	Limit	Over	Detector
		MHz	dBuV	dB	dBuV/m	dBuV/m	dB	
1		4803.900	40.74	13.44	54.18	74.00	-19.82	peak
2	*	4804.201	28.57	13.44	42.01	54.00	-11.99	AVG

Remark:

1. Corr. = Antenna Factor (dB/m) + Cable Loss (dB)
2. Peak/AVG (dB μ V/m)= Corr. (dB/m)+ Read Level (dB μ V)
3. Margin (dB) = Peak/AVG (dB μ V/m)-Limit PK/AVG(dB μ V/m)

Temperature:	23.6°C	Relative Humidity:	45%
Test Voltage:	DC 12V		
Ant. Pol.	Vertical		
Test Mode:	TX π /4-DQPSK Mode 2402MHz		
Remark:	No report for the emission which more than 20 dB below the prescribed limit.		

No.	Mk.	Freq.	Reading Level	Correct Factor	Measurement	Limit	Over	Detector
		MHz	dBuV	dB	dBuV/m	dBuV/m	dB	
1		4803.662	42.71	13.44	56.15	74.00	-17.85	peak
2	*	4804.120	28.76	13.44	42.20	54.00	-11.80	AVG

Remark:

1. Corr. = Antenna Factor (dB/m) + Cable Loss (dB)
2. Peak/AVG (dB μ V/m)= Corr. (dB/m)+ Read Level (dB μ V)
3. Margin (dB) = Peak/AVG (dB μ V/m)-Limit PK/AVG(dB μ V/m)

Temperature:	23.6°C	Relative Humidity:	45%
Test Voltage:	DC 12V		
Ant. Pol.	Horizontal		
Test Mode:	TX π /4-DQPSK Mode 2441MHz		
Remark:	No report for the emission which more than 20 dB below the prescribed limit.		

No.	Mk.	Freq.	Reading Level	Correct Factor	Measurement	Limit	Over	Detector
		MHz	dBuV	dB	dBuV/m	dBuV/m	dB	
1	*	4881.225	27.21	13.90	41.11	54.00	-12.89	AVG
2		4881.762	42.14	13.90	56.04	74.00	-17.96	peak

Remark:

1. Corr. = Antenna Factor (dB/m) + Cable Loss (dB)
2. Peak/AVG (dB μ V/m)= Corr. (dB/m)+ Read Level (dB μ V)
3. Margin (dB) = Peak/AVG (dB μ V/m)-Limit PK/AVG(dB μ V/m)

Temperature:	23.6°C	Relative Humidity:	45%
Test Voltage:	DC 12V		
Ant. Pol.	Vertical		
Test Mode:	TX π /4-DQPSK Mode 2441MHz		
Remark:	No report for the emission which more than 20 dB below the prescribed limit.		

No.	Mk.	Freq.	Reading Level	Correct Factor	Measurement	Limit	Over	Detector
		MHz	dBuV	dB	dBuV/m	dBuV/m	dB	
1		4881.901	42.27	13.90	56.17	74.00	-17.83	peak
2	*	4882.152	29.00	13.90	42.90	54.00	-11.10	AVG

Remark:

1. Corr. = Antenna Factor (dB/m) + Cable Loss (dB)
2. Peak/AVG (dB μ V/m)= Corr. (dB/m)+ Read Level (dB μ V)
3. Margin (dB) = Peak/AVG (dB μ V/m)-Limit PK/AVG(dB μ V/m)

Temperature:	23.6°C	Relative Humidity:	45%
Test Voltage:	DC 12V		
Ant. Pol.	Horizontal		
Test Mode:	TX π /4-DQPSK Mode 2480MHz		
Remark:	No report for the emission which more than 20 dB below the prescribed limit.		

No.	Mk.	Freq.	Reading Level	Correct Factor	Measurement	Limit	Over	Detector
		MHz	dBuV	dB	dBuV/m	dBuV/m	dB	
1	*	4959.780	27.74	14.36	42.10	54.00	-11.90	AVG
2		4960.120	42.34	14.36	56.70	74.00	-17.30	peak

Remark:

1. Corr. = Antenna Factor (dB/m) + Cable Loss (dB)
2. Peak/AVG (dB μ V/m)= Corr. (dB/m)+ Read Level (dB μ V)
3. Margin (dB) = Peak/AVG (dB μ V/m)-Limit PK/AVG(dB μ V/m)

Temperature:	23.6°C	Relative Humidity:	45%
Test Voltage:	DC 12V		
Ant. Pol.	Vertical		
Test Mode:	TX π /4-DQPSK Mode 2480MHz		
Remark:	No report for the emission which more than 20 dB below the prescribed limit.		

No.	Mk.	Freq.	Reading Level	Correct Factor	Measurement	Limit	Over	Detector
		MHz	dBuV	dB	dBuV/m	dBuV/m	dB	
1		4960.220	40.89	14.36	55.25	74.00	-18.75	peak
2	*	4960.220	28.06	14.36	42.42	54.00	-11.58	AVG

Remark:

1. Corr. = Antenna Factor (dB/m) + Cable Loss (dB)
2. Peak/AVG (dB μ V/m)= Corr. (dB/m)+ Read Level (dB μ V)
3. Margin (dB) = Peak/AVG (dB μ V/m)-Limit PK/AVG(dB μ V/m)

Temperature:	23.6°C	Relative Humidity:	45%
Test Voltage:	DC 12V		
Ant. Pol.	Horizontal		
Test Mode:	TX 8-DPSK Mode 2402MHz		
Remark:	No report for the emission which more than 20 dB below the prescribed limit.		

No.	Mk.	Freq.	Reading Level	Correct Factor	Measurement	Limit	Over	Detector
		MHz	dBuV	dB	dBuV/m	dBuV/m	dB	
1		4803.870	43.16	13.44	56.60	74.00	-17.40	peak
2	*	4804.054	29.75	13.44	43.19	54.00	-10.81	AVG

Remark:

1. Corr. = Antenna Factor (dB/m) + Cable Loss (dB)
2. Peak/AVG (dBµV/m)= Corr. (dB/m)+ Read Level (dBµV)
3. Margin (dB) = Peak/AVG (dBµV/m)-Limit PK/AVG(dBµV/m)

Temperature:	23.6°C	Relative Humidity:	45%
Test Voltage:	DC 12V		
Ant. Pol.	Vertical		
Test Mode:	TX 8-DPSK Mode 2402MHz		
Remark:	No report for the emission which more than 20 dB below the prescribed limit.		

No.	Mk.	Freq.	Reading Level	Correct Factor	Measurement	Limit	Over	Detector
		MHz	dBuV	dB	dBuV/m	dBuV/m	dB	
1		4804.400	43.33	13.44	56.77	74.00	-17.23	peak
2	*	4804.400	27.78	13.44	41.22	54.00	-12.78	AVG

Remark:

1. Corr. = Antenna Factor (dB/m) + Cable Loss (dB)
2. Peak/AVG (dBµV/m)= Corr. (dB/m)+ Read Level (dBµV)
3. Margin (dB) = Peak/AVG (dBµV/m)-Limit PK/AVG(dBµV/m)

Temperature:	23.6°C	Relative Humidity:	45%
Test Voltage:	DC 12V		
Ant. Pol.	Horizontal		
Test Mode:	TX 8-DPSK Mode 2441MHz		
Remark:	No report for the emission which more than 20 dB below the prescribed limit.		

No.	Mk.	Freq.	Reading Level	Correct Factor	Measurement	Limit	Over	Detector
		MHz	dBuV	dB	dBuV/m	dBuV/m	dB	
1		4882.461	43.01	13.90	56.91	74.00	-17.09	peak
2	*	4882.461	27.27	13.90	41.17	54.00	-12.83	AVG

Remark:

1. Corr. = Antenna Factor (dB/m) + Cable Loss (dB)
2. Peak/AVG (dBµV/m)= Corr. (dB/m)+ Read Level (dBµV)
3. Margin (dB) = Peak/AVG (dBµV/m)-Limit PK/AVG(dBµV/m)

Temperature:	23.6°C	Relative Humidity:	45%
Test Voltage:	DC 12V		
Ant. Pol.	Vertical		
Test Mode:	TX 8-DPSK Mode 2441MHz		
Remark:	No report for the emission which more than 20 dB below the prescribed limit.		

No.	Mk.	Freq.	Reading Level	Correct Factor	Measurement	Limit	Over	Detector
		MHz	dBuV	dB	dBuV/m	dBuV/m	dB	
1	*	4881.800	28.20	13.90	42.10	54.00	-11.90	AVG
2		4882.011	42.81	13.90	56.71	74.00	-17.29	peak

Remark:

1. Corr. = Antenna Factor (dB/m) + Cable Loss (dB)
2. Peak/AVG (dBµV/m)= Corr. (dB/m)+ Read Level (dBµV)
3. Margin (dB) = Peak/AVG (dBµV/m)-Limit PK/AVG(dBµV/m)

Temperature:	23.6°C	Relative Humidity:	45%
Test Voltage:	DC 12V		
Ant. Pol.	Horizontal		
Test Mode:	TX 8-DPSK Mode 2480MHz		
Remark:	No report for the emission which more than 20 dB below the prescribed limit.		

No.	Mk.	Freq.	Reading Level	Correct Factor	Measurement	Limit	Over	Detector
		MHz	dBuV	dB	dBuV/m	dBuV/m	dB	
1		4960.100	39.66	14.36	54.02	74.00	-19.98	peak
2	*	4960.100	29.44	14.36	43.80	54.00	-10.20	AVG

Remark:

1. Corr. = Antenna Factor (dB/m) + Cable Loss (dB)
2. Peak/AVG (dBμV/m)= Corr. (dB/m)+ Read Level (dBμV)
3. Margin (dB) = Peak/AVG (dBμV/m)-Limit PK/AVG(dBμV/m)

Temperature:	23.6°C	Relative Humidity:	45%
Test Voltage:	DC 12V		
Ant. Pol.	Vertical		
Test Mode:	TX 8-DPSK Mode 2480MHz		
Remark:	No report for the emission which more than 20 dB below the prescribed limit.		

No.	Mk.	Freq.	Reading Level	Correct Factor	Measurement	Limit	Over	Detector
		MHz	dBuV	dB	dBuV/m	dBuV/m	dB	
1	*	4960.180	28.75	14.36	43.11	54.00	-10.89	AVG
2		4959.598	42.54	14.36	56.90	74.00	-17.10	peak

Remark:

1. Corr. = Antenna Factor (dB/m) + Cable Loss (dB)
2. Peak/AVG (dBμV/m)= Corr. (dB/m)+ Read Level (dBμV)
3. Margin (dB) = Peak/AVG (dBμV/m)-Limit PK/AVG(dBμV/m)

Attachment B-- Restricted Bands Requirement and Band Edge Test Data

(1) Radiation Test

Temperature:	25°C	Relative Humidity:	55%
Test Voltage:	DC 12V		
Ant. Pol.	Horizontal		
Test Mode:	TX GFSK Mode 2402MHz		
Remark:	Only worse case is reported		

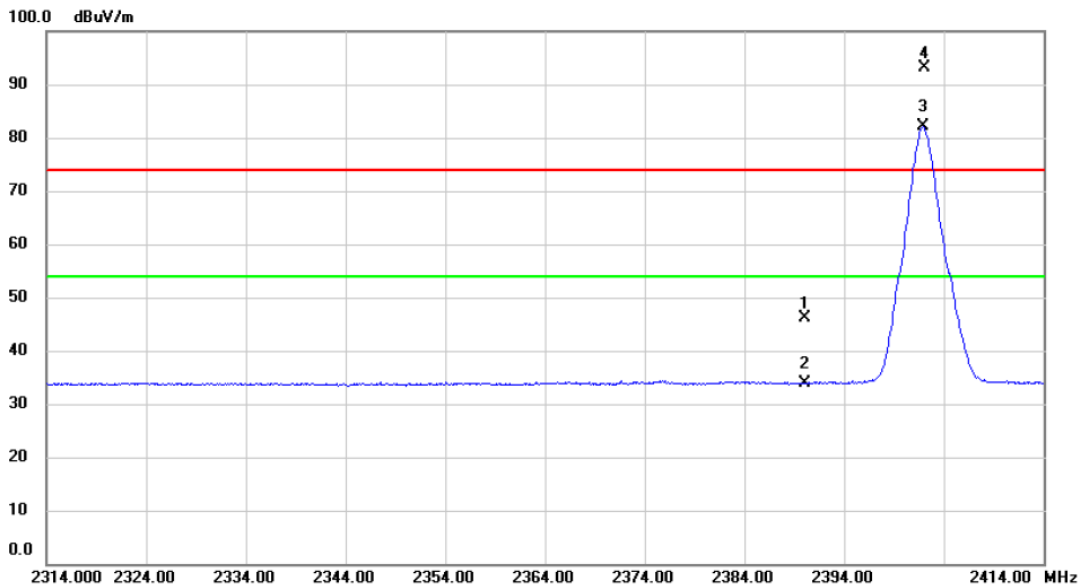

No.	Mk.	Freq. MHz	Reading Level dBuV	Correct Factor dB	Measure- ment dBuV/m	Limit dBuV/m	Over dB	Detector
1		2390.000	45.35	0.77	46.12	74.00	-27.88	peak
2		2390.000	33.22	0.77	33.99	54.00	-20.01	AVG
3	*	2401.900	81.19	0.82	82.01	Fundamental Frequency		AVG
4	X	2402.000	92.39	0.82	93.21	Fundamental Frequency		peak

Remark:

1. Corr. = Antenna Factor (dB/m) + Cable Loss (dB)
2. Peak/AVG (dBuV/m) = Corr. (dB/m) + Read Level (dBuV)
3. Margin (dB) = Peak/AVG (dBuV/m) - Limit PK/AVG (dBuV/m)

Temperature:	25°C	Relative Humidity:	55%
Test Voltage:	DC 12V		
Ant. Pol.	Vertical		
Test Mode:	TX GFSK Mode 2402MHz		
Remark:	Only worse case is reported		

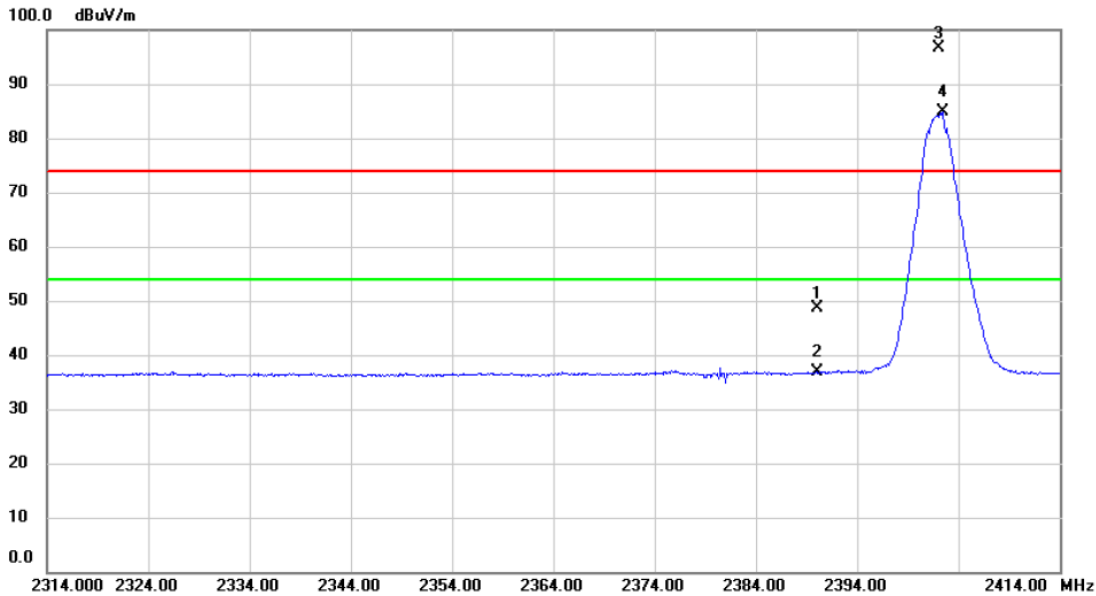

No.	Mk.	Freq. MHz	Reading Level dBuV	Correct Factor dB	Measure- ment dBuV/m	Limit dBuV/m	Over dB	Detector
1		2390.000	47.93	0.77	48.70	74.00	-25.30	peak
2		2390.000	36.21	0.77	36.98	54.00	-17.02	AVG
3	X	2402.100	95.84	0.82	96.66	Fundamental Frequency		peak
4	*	2402.400	84.07	0.82	84.89	Fundamental Frequency		AVG

Remark:
 1. Corr. = Antenna Factor (dB/m) + Cable Loss (dB)
 2. Peak/AVG (dBμV/m)= Corr. (dB/m)+ Read Level (dBμV)
 3. Margin (dB) = Peak/AVG (dBμV/m)-Limit PK/AVG(dBμV/m)

Temperature:	25°C	Relative Humidity:	55%
Test Voltage:	DC 12V		
Ant. Pol.	Horizontal		
Test Mode:	TX GFSK Mode 2480 MHz		
Remark:	Only worse case is reported		

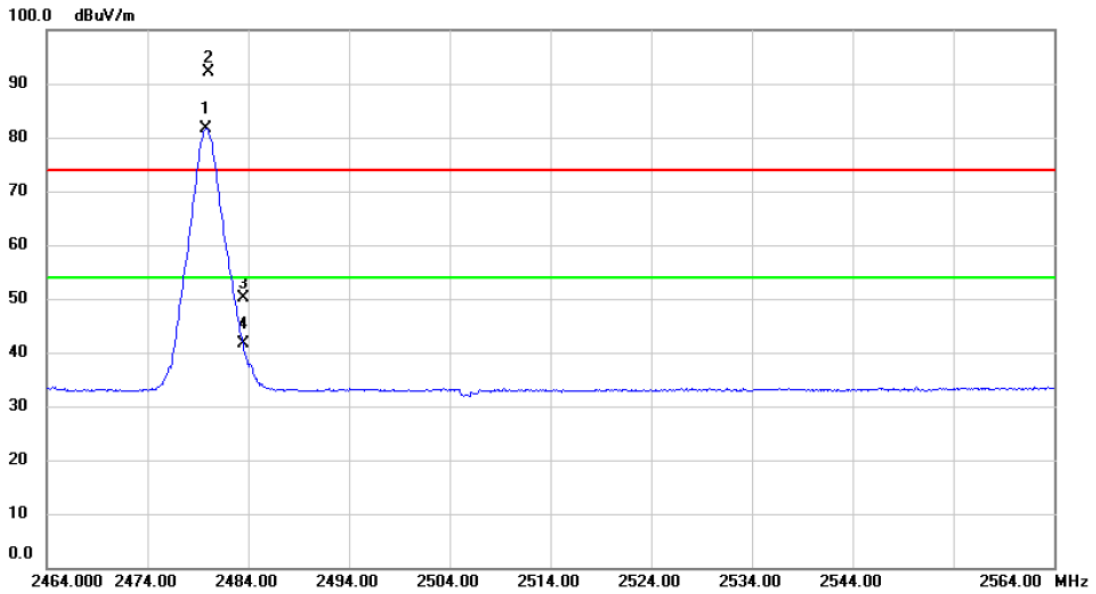

No.	Mk.	Freq. MHz	Reading Level dBuV	Correct Factor dB	Measure- ment dBuV/m	Limit dBuV/m	Over dB	Detector
1	*	2479.800	80.44	1.15	81.59	Fundamental Frequency		AVG
2	X	2480.100	90.95	1.15	92.10	Fundamental Frequency		peak
3		2483.500	49.01	1.17	50.18	74.00	-23.82	peak
4		2483.500	40.47	1.17	41.64	54.00	-12.36	AVG

Remark:

1. Corr. = Antenna Factor (dB/m) + Cable Loss (dB)
2. Peak/AVG (dBuV/m) = Corr. (dB/m) + Read Level (dBuV)
3. Margin (dB) = Peak/AVG (dBuV/m) - Limit PK/AVG (dBuV/m)

Temperature:	25°C	Relative Humidity:	55%
Test Voltage:	DC 12V		
Ant. Pol.	Vertical		
Test Mode:	TX GFSK Mode 2480 MHz		
Remark:	Only worse case is reported		

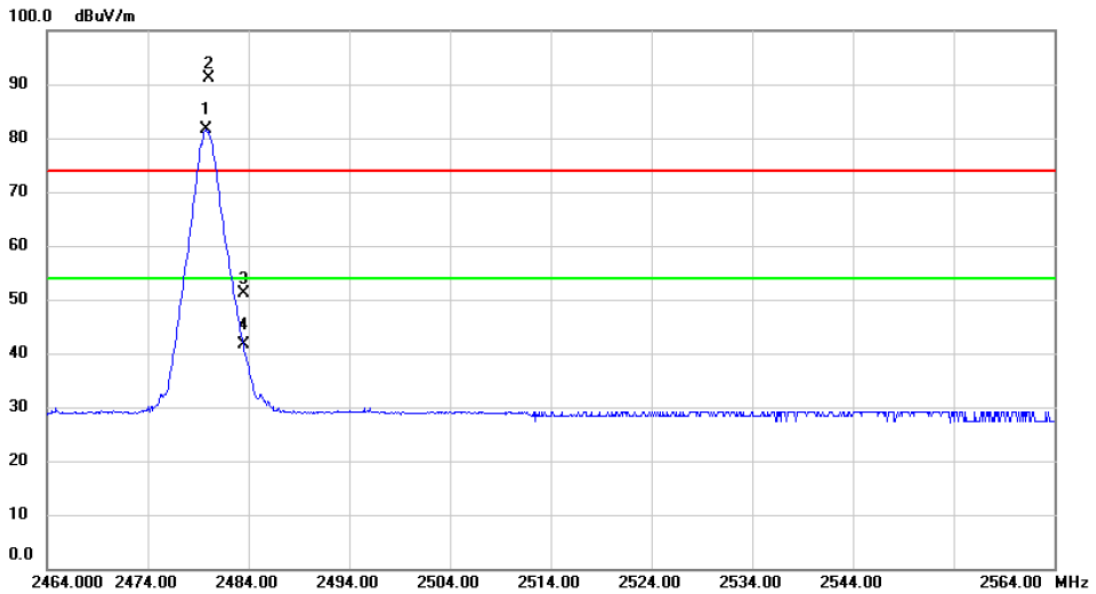

No.	Mk.	Freq. MHz	Reading Level dBuV	Correct Factor dB	Measure- ment dBuV/m	Limit dBuV/m	Over dB	Detector
1	*	2479.800	80.43	1.15	81.58			AVG
2	X	2480.100	89.86	1.15	91.01	Fundamental Frequency		peak
3		2483.500	49.93	1.17	51.10	74.00	-22.90	peak
4		2483.500	40.57	1.17	41.74	54.00	-12.26	AVG

Remark:

1. Corr. = Antenna Factor (dB/m) + Cable Loss (dB)
2. Peak/AVG (dBμV/m)= Corr. (dB/m)+ Read Level (dBμV)
3. Margin (dB) = Peak/AVG (dBμV/m)-Limit PK/AVG(dBμV/m)

Temperature:	25°C	Relative Humidity:	55%
Test Voltage:	DC 12V		
Ant. Pol.	Horizontal		
Test Mode:	TX π /4-DQPSK Mode 2402MHz		
Remark:	Only worse case is reported		

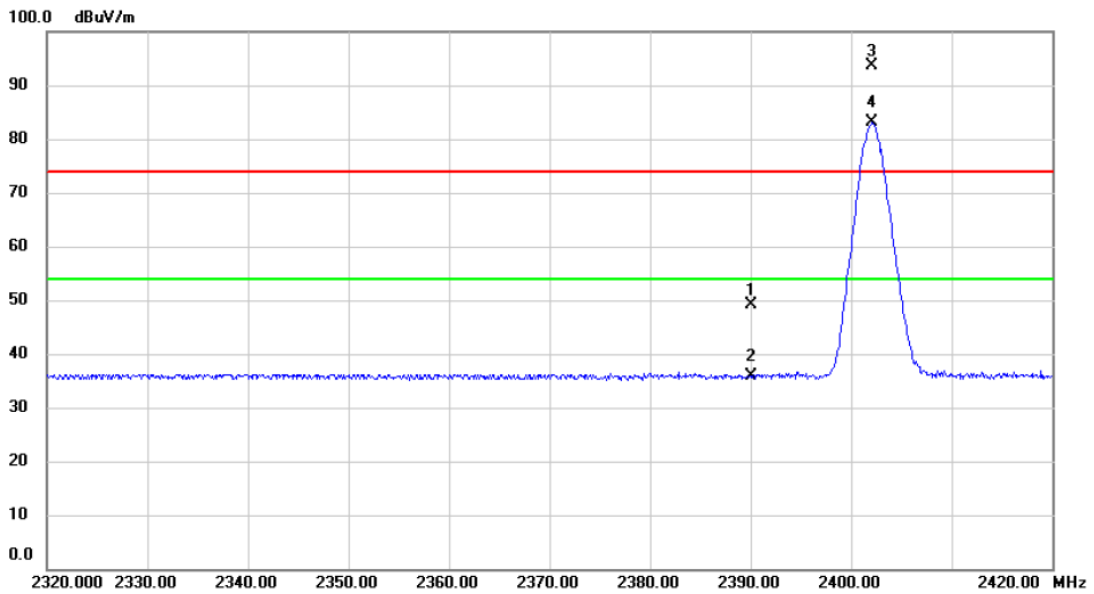

No.	Mk.	Freq. MHz	Reading Level dBuV	Correct Factor dB	Measure- ment dBuV/m	Limit dBuV/m	Over dB	Detector
1		2390.000	48.37	0.77	49.14	74.00	-24.86	peak
2		2390.000	35.15	0.77	35.92	54.00	-18.08	AVG
3	X	2402.000	92.79	0.82	93.61	Fundamental Frequency		peak
4	*	2402.100	82.31	0.82	83.13	Fundamental Frequency		AVG

Remark:

1. Corr. = Antenna Factor (dB/m) + Cable Loss (dB)
2. Peak/AVG (dB μ V/m) = Corr. (dB/m) + Read Level (dB μ V)
3. Margin (dB) = Peak/AVG (dB μ V/m) - Limit PK/AVG (dB μ V/m)

Temperature:	25°C	Relative Humidity:	55%
Test Voltage:	DC 12V		
Ant. Pol.	Vertical		
Test Mode:	TX $\pi/4$ -DQPSK Mode 2402MHz		
Remark:	Only worse case is reported		

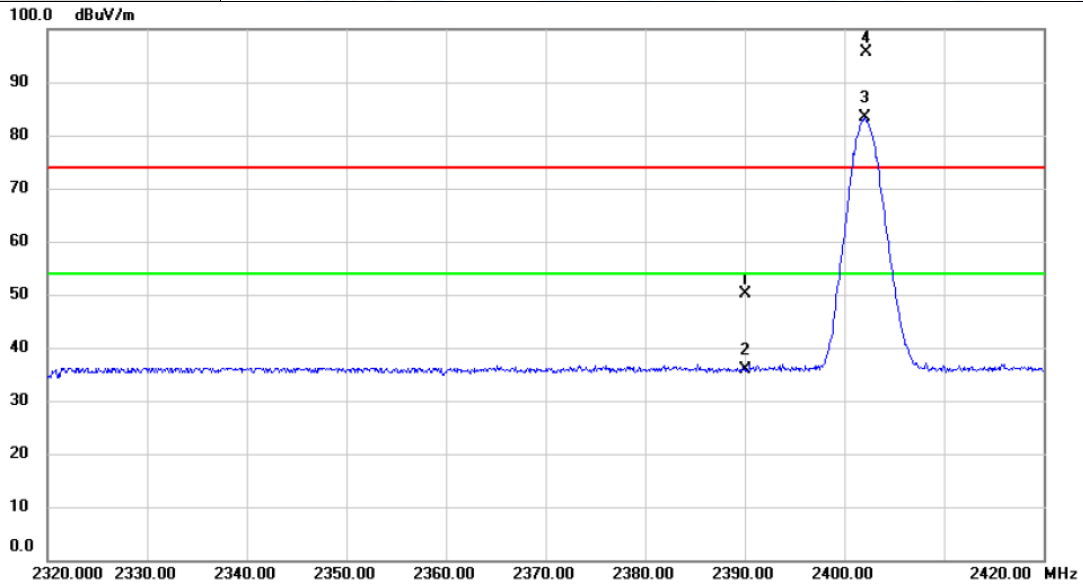

No.	Mk.	Freq. MHz	Reading Level dBuV	Correct Factor dB	Measure- ment dBuV/m	Limit dBuV/m	Over dB	Detector
1		2390.000	49.33	0.77	50.10	74.00	-23.90	peak
2		2390.000	35.08	0.77	35.85	54.00	-18.15	AVG
3	*	2402.100	82.57	0.82	83.39	Fundamental Frequency		AVG
4	X	2402.200	94.82	0.82	95.64	Fundamental Frequency		peak

Remark:

1. Corr. = Antenna Factor (dB/m) + Cable Loss (dB)
2. Peak/AVG (dB μ V/m) = Corr. (dB/m) + Read Level (dB μ V)
3. Margin (dB) = Peak/AVG (dB μ V/m) - Limit PK/AVG (dB μ V/m)

Temperature:	25°C	Relative Humidity:	55%
Test Voltage:	DC 12V		
Ant. Pol.	Horizontal		
Test Mode:	TX π /4-DQPSK Mode 2480MHz		
Remark:	Only worse case is reported		

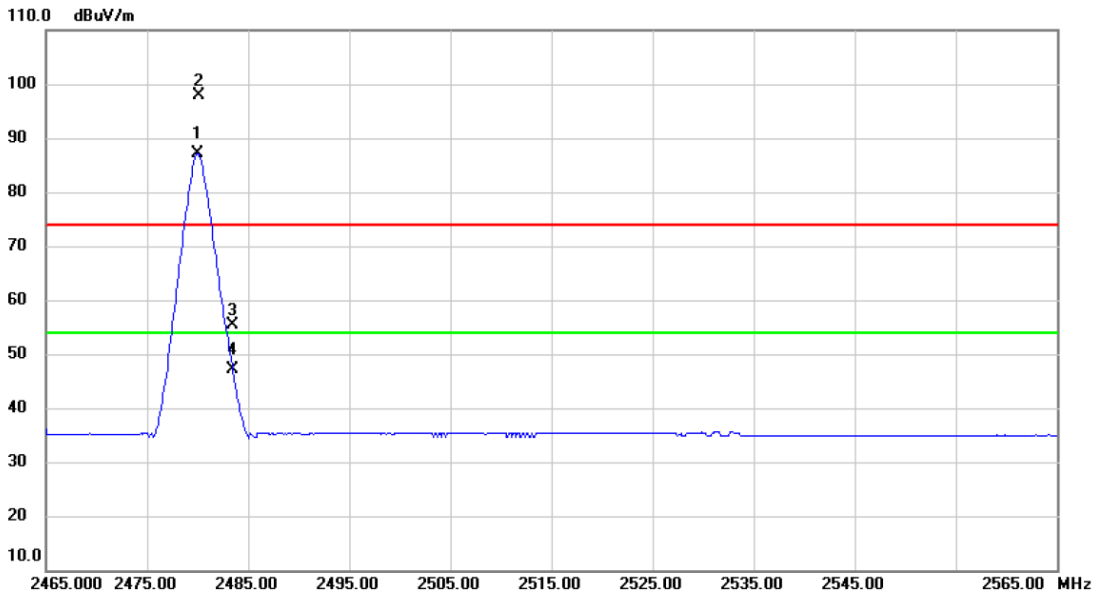

No.	Mk.	Freq. MHz	Reading Level dBuV	Correct Factor dB	Measure- ment dBuV/m	Limit dBuV/m	Over dB	Detector
1	*	2480.000	85.95	1.15	87.10	Fundamental Frequency		AVG
2	X	2480.143	96.66	1.15	97.81	Fundamental Frequency		peak
3		2483.500	54.13	1.17	55.30	74.00	-18.70	peak
4		2483.500	46.00	1.17	47.17	54.00	-6.83	AVG

Remark:
 1. Corr. = Antenna Factor (dB/m) + Cable Loss (dB)
 2. Peak/AVG (dB μ V/m) = Corr. (dB/m) + Read Level (dB μ V)
 3. Margin (dB) = Peak/AVG (dB μ V/m) - Limit PK/AVG (dB μ V/m)

Temperature:	25°C	Relative Humidity:	55%
Test Voltage:	DC 12V		
Ant. Pol.	Vertical		
Test Mode:	TX π /4-DQPSK Mode 2480MHz		
Remark:	Only worse case is reported		

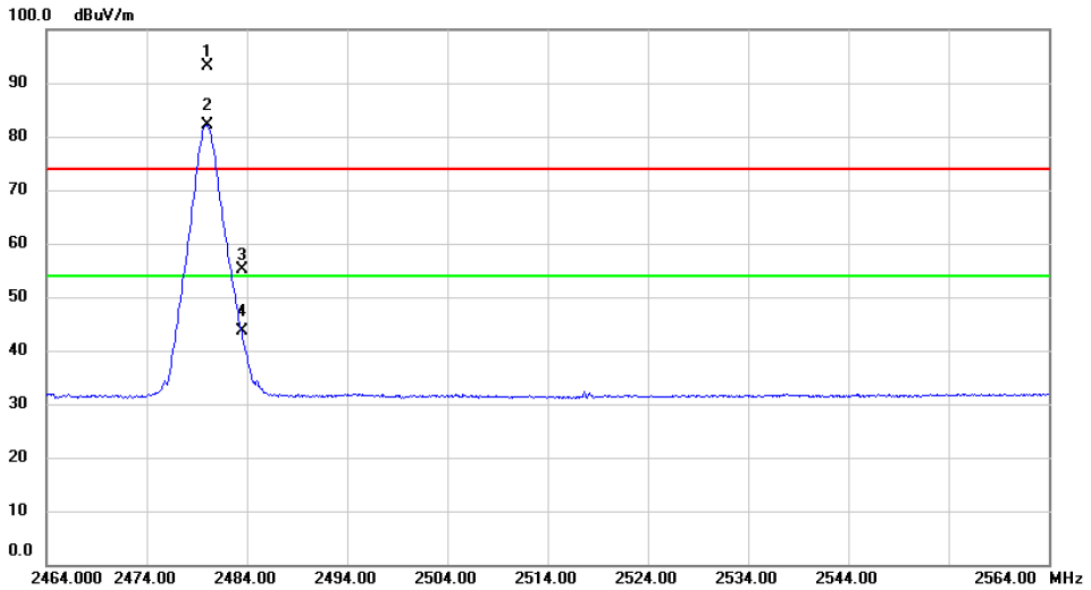

No.	Mk.	Freq. MHz	Reading Level dBuV	Correct Factor dB	Measure- ment dBuV/m	Limit dBuV/m	Over dB	Detector
1	X	2480.000	91.92	1.15	93.07	Fundamental Frequency		peak
2	*	2480.000	81.06	1.15	82.21	Fundamental Frequency		AVG
3		2483.500	53.84	1.17	55.01	74.00	-18.99	peak
4		2483.500	42.35	1.17	43.52	54.00	-10.48	AVG

Remark:

1. Corr. = Antenna Factor (dB/m) + Cable Loss (dB)
2. Peak/AVG (dB μ V/m) = Corr. (dB/m) + Read Level (dB μ V)
3. Margin (dB) = Peak/AVG (dB μ V/m) - Limit PK/AVG (dB μ V/m)

Temperature:	25°C	Relative Humidity:	55%
Test Voltage:	DC 12V		
Ant. Pol.	Horizontal		
Test Mode:	TX 8-DPSK Mode 2402MHz		
Remark:	Only worse case is reported		

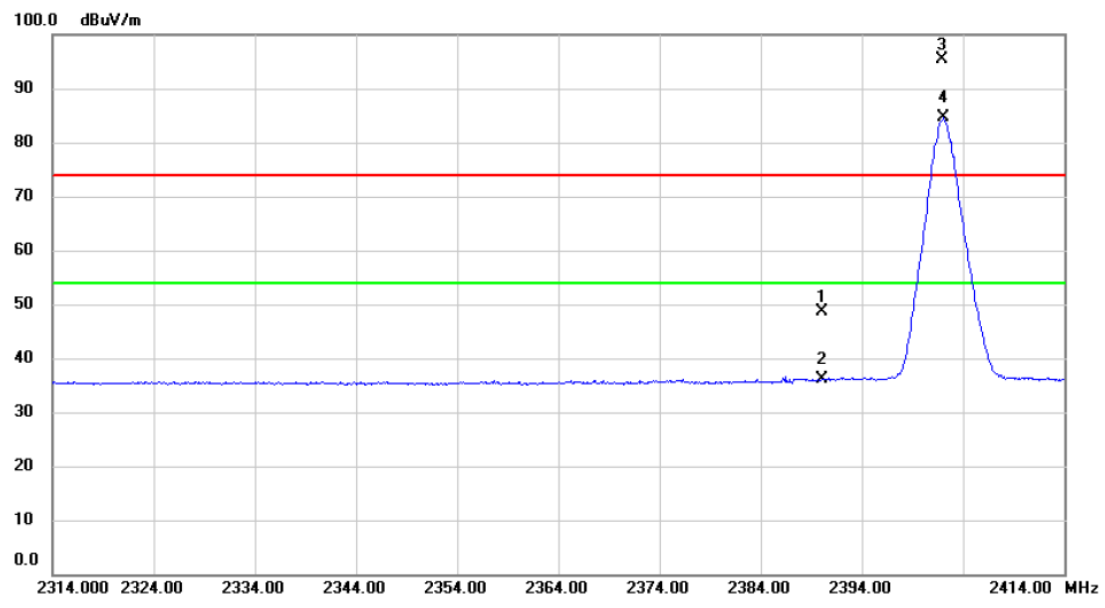

No.	Mk.	Freq. MHz	Reading Level dBuV	Correct Factor dB	Measure- ment dBuV/m	Limit dBuV/m	Over dB	Detector
1		2390.000	47.83	0.77	48.60	74.00	-25.40	peak
2		2390.000	35.45	0.77	36.22	54.00	-17.78	AVG
3	X	2401.900	94.66	0.82	95.48	Fundamental Frequency		peak
4	*	2402.100	83.69	0.82	84.51	Fundamental Frequency		AVG

Remark:
 1. Corr. = Antenna Factor (dB/m) + Cable Loss (dB)
 2. Peak/AVG (dBμV/m)= Corr. (dB/m)+ Read Level (dBμV)
 3. Margin (dB) = Peak/AVG (dBμV/m)-Limit PK/AVG(dBμV/m)

Temperature:	25°C	Relative Humidity:	55%
Test Voltage:	DC 12V		
Ant. Pol.	Vertical		
Test Mode:	TX 8-DPSK Mode 2402MHz		
Remark:	Only worse case is reported		

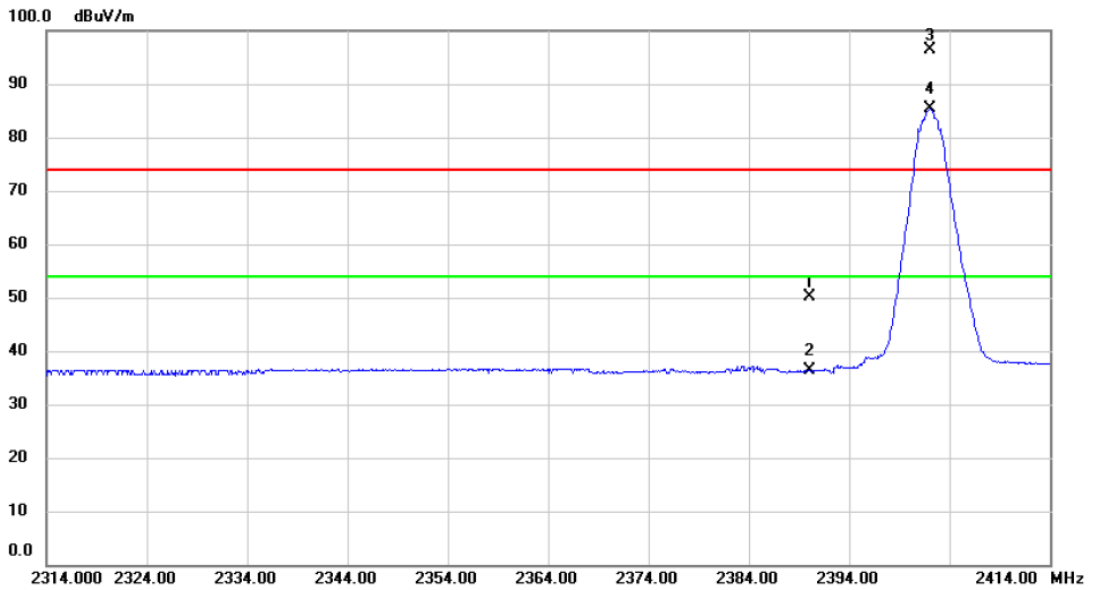

No.	Mk.	Freq. MHz	Reading Level dBuV	Correct Factor dB	Measure- ment dBuV/m	Limit dBuV/m	Over dB	Detector
1		2390.000	49.45	0.77	50.22	74.00	-23.78	peak
2		2390.000	35.53	0.77	36.30	54.00	-17.70	AVG
3	X	2402.000	95.68	0.82	96.50	Fundamental Frequency		peak
4	*	2402.000	84.57	0.82	85.39	Fundamental Frequency		AVG

Remark:

1. Corr. = Antenna Factor (dB/m) + Cable Loss (dB)
2. Peak/AVG (dBμV/m) = Corr. (dB/m) + Read Level (dBμV)
3. Margin (dB) = Peak/AVG (dBμV/m) - Limit PK/AVG (dBμV/m)

Temperature:	25°C	Relative Humidity:	55%
Test Voltage:	DC 12V		
Ant. Pol.	Horizontal		
Test Mode:	TX 8-DPSK Mode 2480MHz		
Remark:	Only worse case is reported		

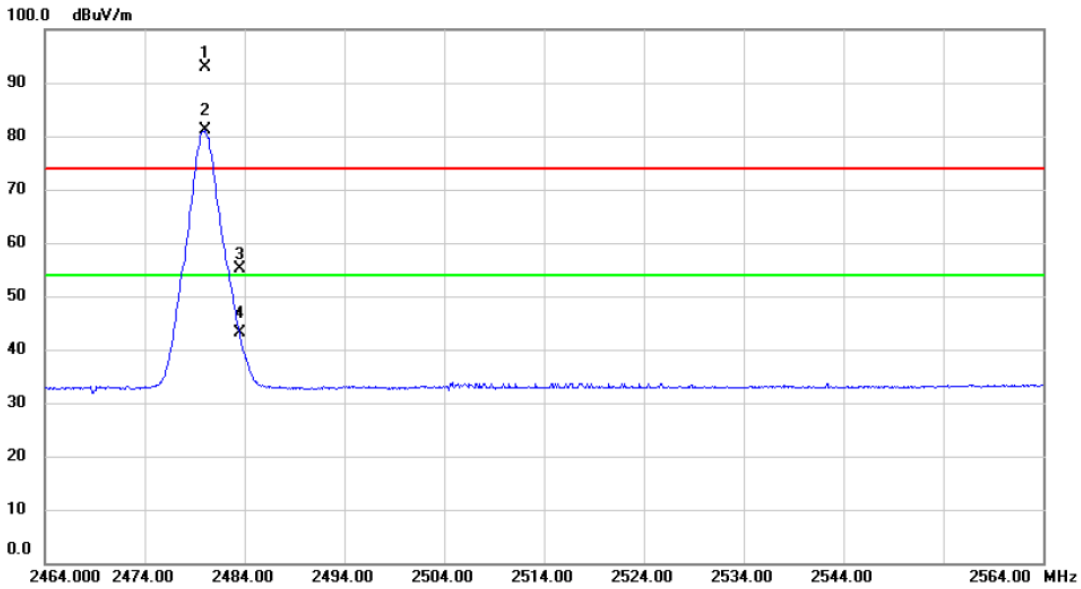

No.	Mk.	Freq. MHz	Reading Level dBuV	Correct Factor dB	Measure- ment dBuV/m	Limit dBuV/m	Over dB	Detector
1	X	2480.000	91.65	1.15	92.80	Fundamental Frequency		peak
2	*	2480.000	79.94	1.15	81.09	Fundamental Frequency		AVG
3		2483.500	54.02	1.17	55.19	74.00	-18.81	peak
4		2483.500	42.00	1.17	43.17	54.00	-10.83	AVG

Remark:
 1. Corr. = Antenna Factor (dB/m) + Cable Loss (dB)
 2. Peak/AVG (dBμV/m)= Corr. (dB/m)+ Read Level (dBμV)
 3. Margin (dB) = Peak/AVG (dBμV/m)-Limit PK/AVG(dBμV/m)

Temperature:	25°C	Relative Humidity:	55%
Test Voltage:	DC 12V		
Ant. Pol.	Vertical		
Test Mode:	TX 8-DPSK Mode 2480MHz		
Remark:	Only worse case is reported		

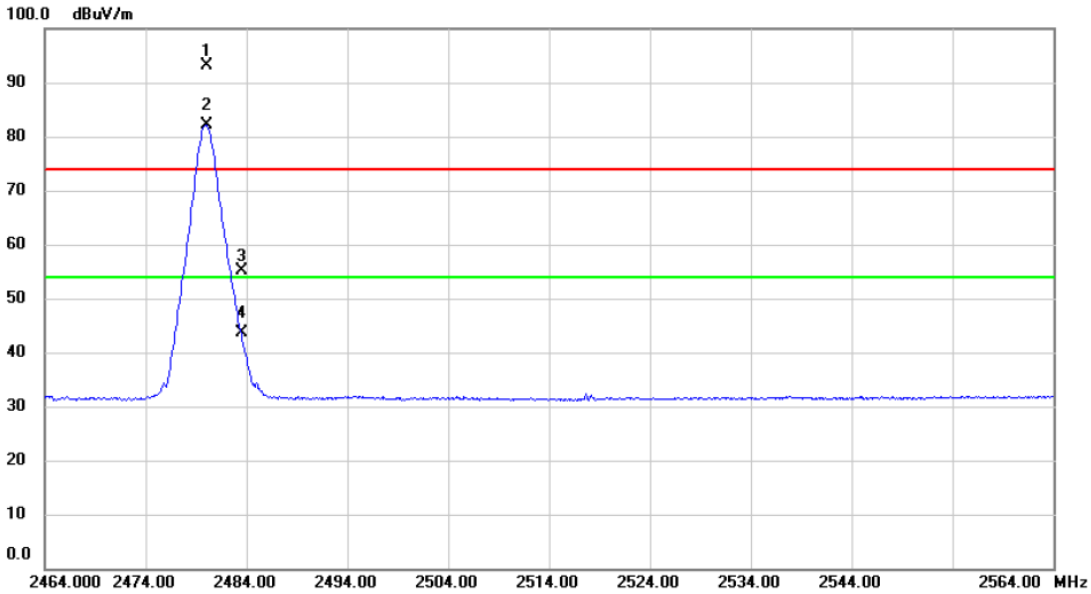

No.	Mk.	Freq. MHz	Reading Level dBuV	Correct Factor dB	Measure- ment dBuV/m	Limit dBuV/m	Over dB	Detector
1	X	2480.000	91.92	1.15	93.07	Fundamental Frequency		peak
2	*	2480.000	81.06	1.15	82.21	Fundamental Frequency		AVG
3		2483.500	53.84	1.17	55.01	74.00	-18.99	peak
4		2483.500	42.35	1.17	43.52	54.00	-10.48	AVG

Remark:

1. Corr. = Antenna Factor (dB/m) + Cable Loss (dB)
2. Peak/AVG (dBμV/m) = Corr. (dB/m) + Read Level (dBμV)
3. Margin (dB) = Peak/AVG (dBμV/m) - Limit PK/AVG (dBμV/m)

(2) Conducted Test

Temperature:	25°C	Relative Humidity:	55%
Test Voltage:	DC 12V		
Test Mode:	TX GFSK Mode 2402MHz/2480 MHz		
Remark:	Only worse case is reported		

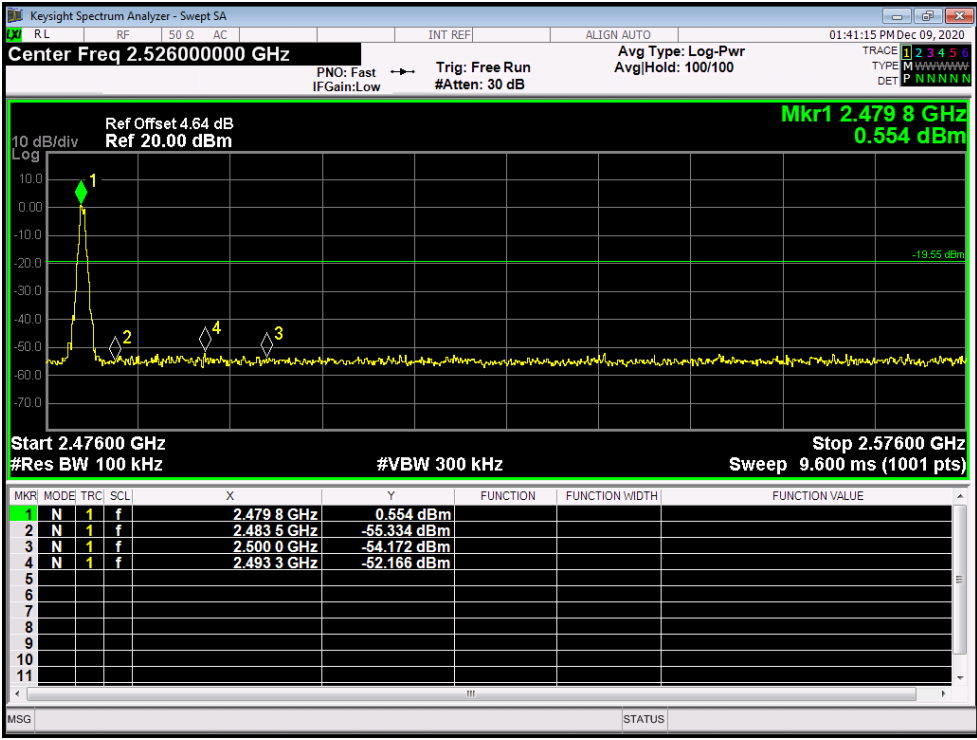
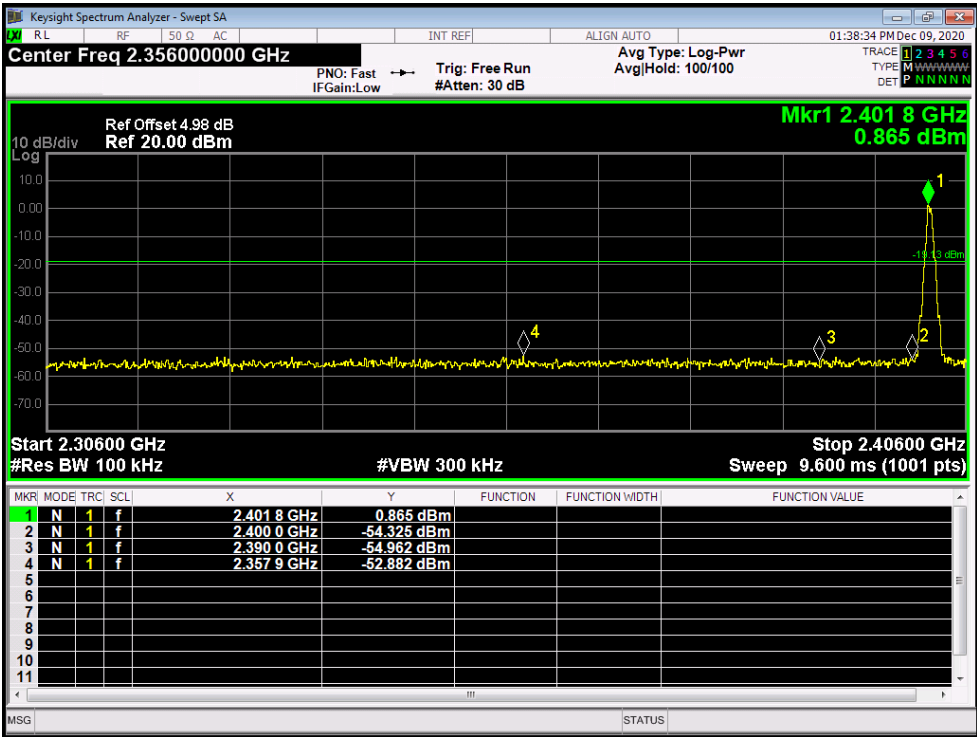

Temperature:	25°C	Relative Humidity:	55%
Test Voltage:	DC 12V		
Test Mode:	GFSK Hopping Mode		
Remark:	Only worse case is reported		

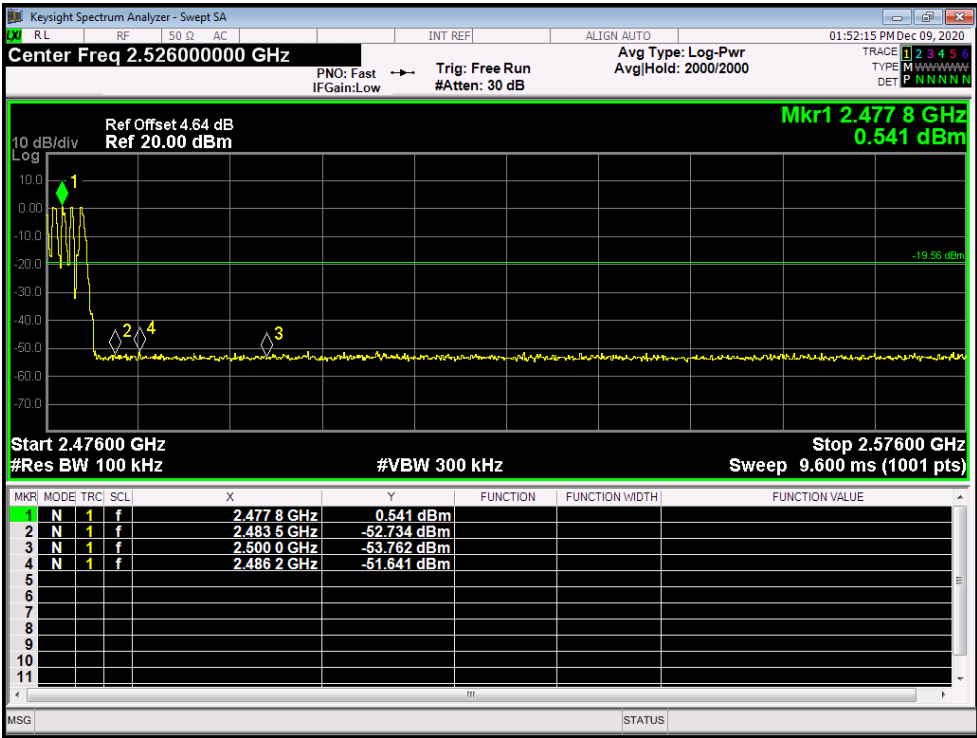
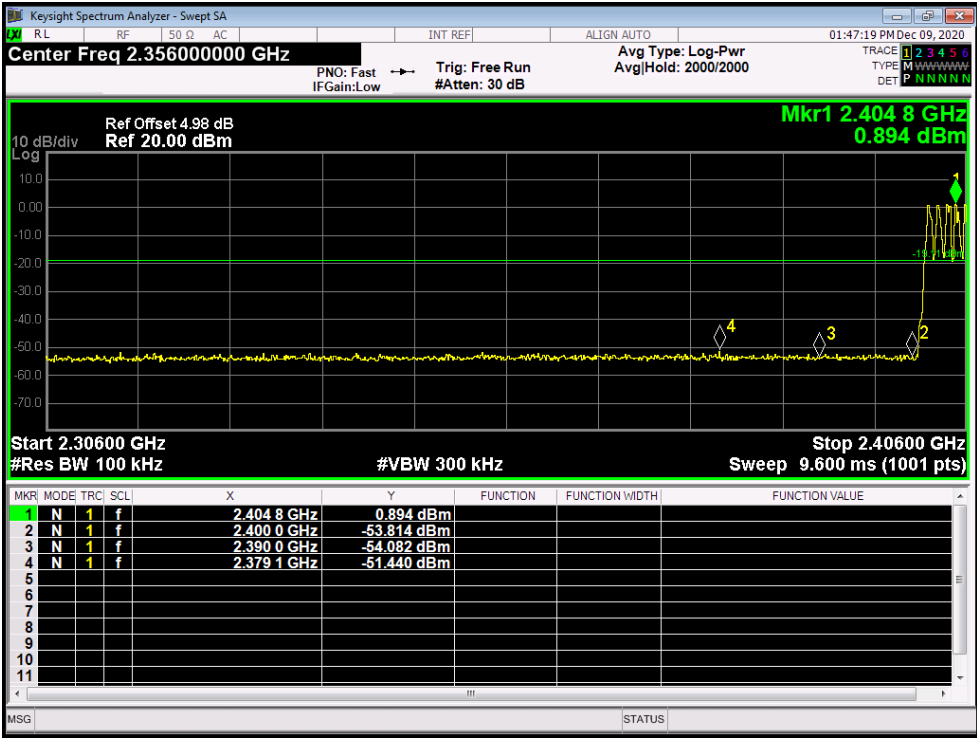

Temperature:	25°C	Relative Humidity:	55%
Test Voltage:	DC 12V		
Test Mode:	TX π /4-DQPSK Mode 2402MHz/2480 MHz		
Remark:	Only worse case is reported		

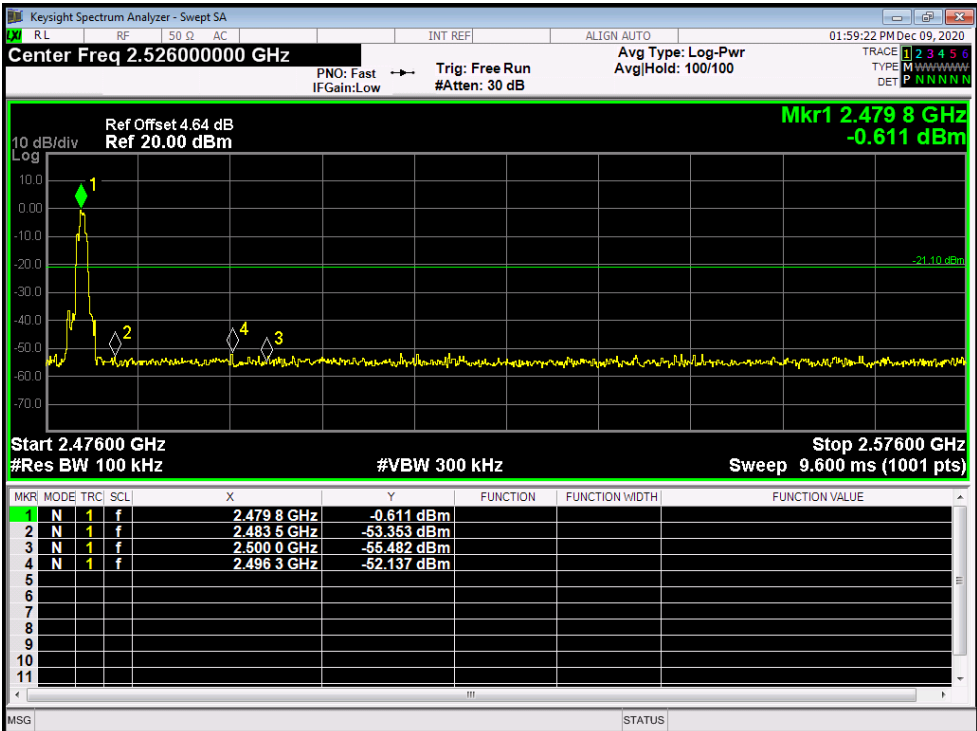
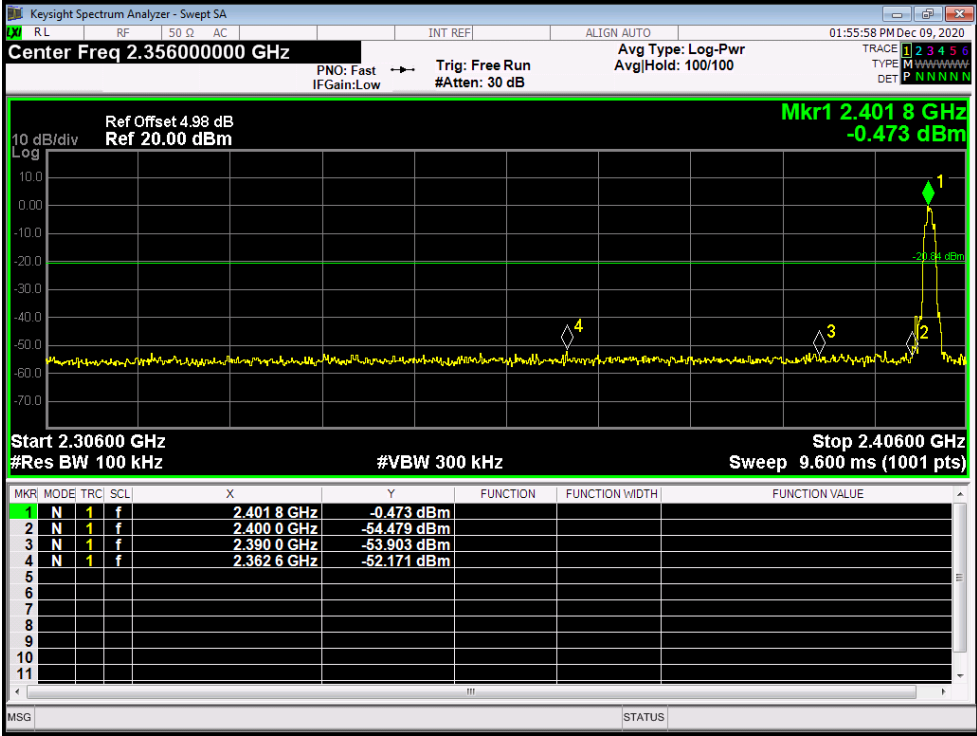

Temperature:	25°C	Relative Humidity:	55%
Test Voltage:	DC 12V		
Test Mode:	π /4-DQPSK Hopping Mode		
Remark:	Only worse case is reported		

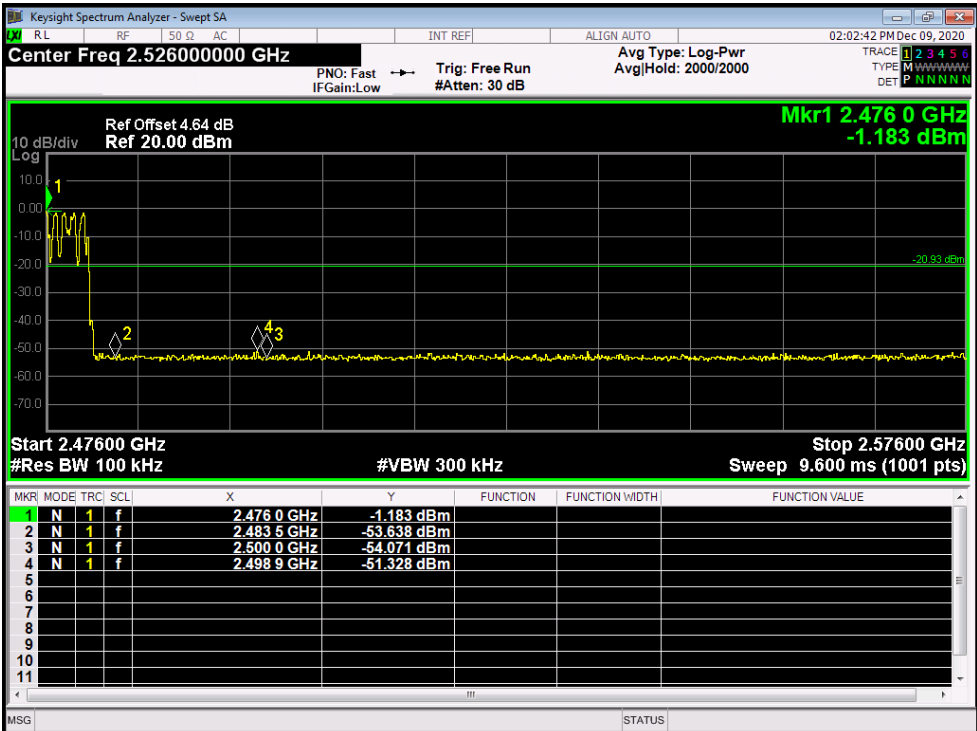
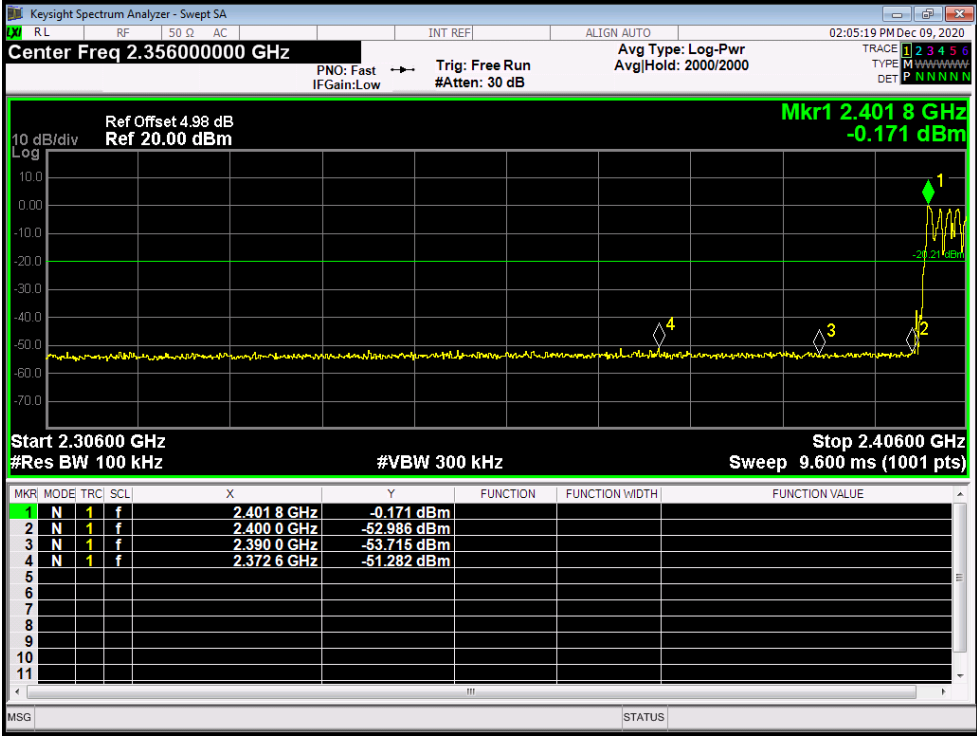

Temperature:	25°C	Relative Humidity:	55%
Test Voltage:	DC 12V		
Test Mode:	TX 8-DPSK Mode 2402MHz/2480 MHz		
Remark:	Only worse case is reported		

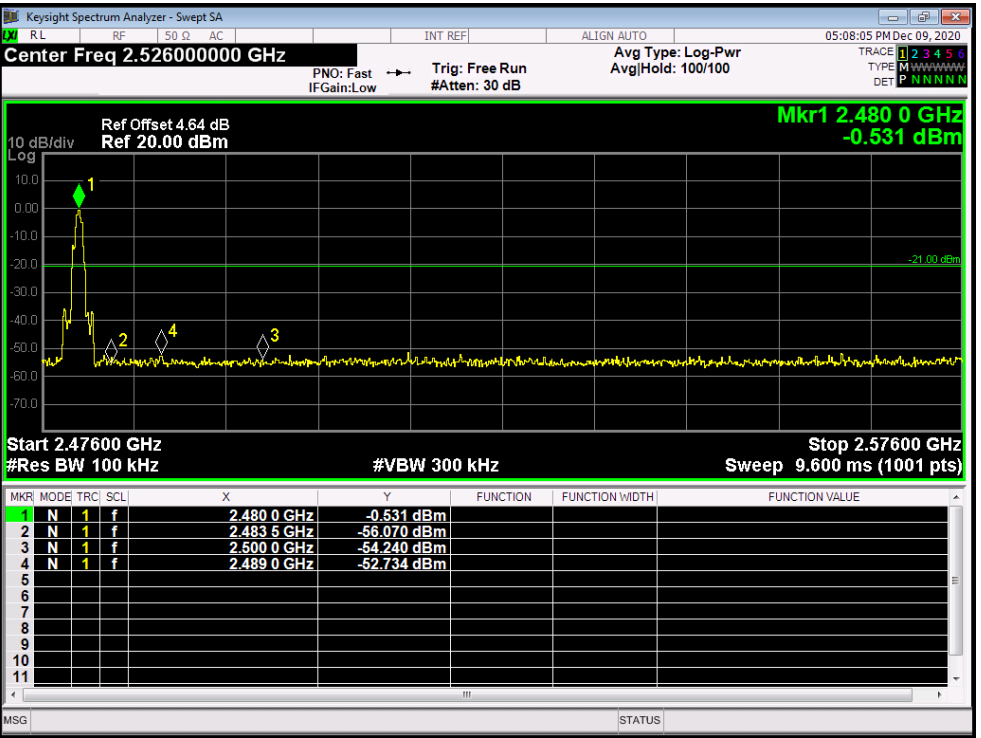
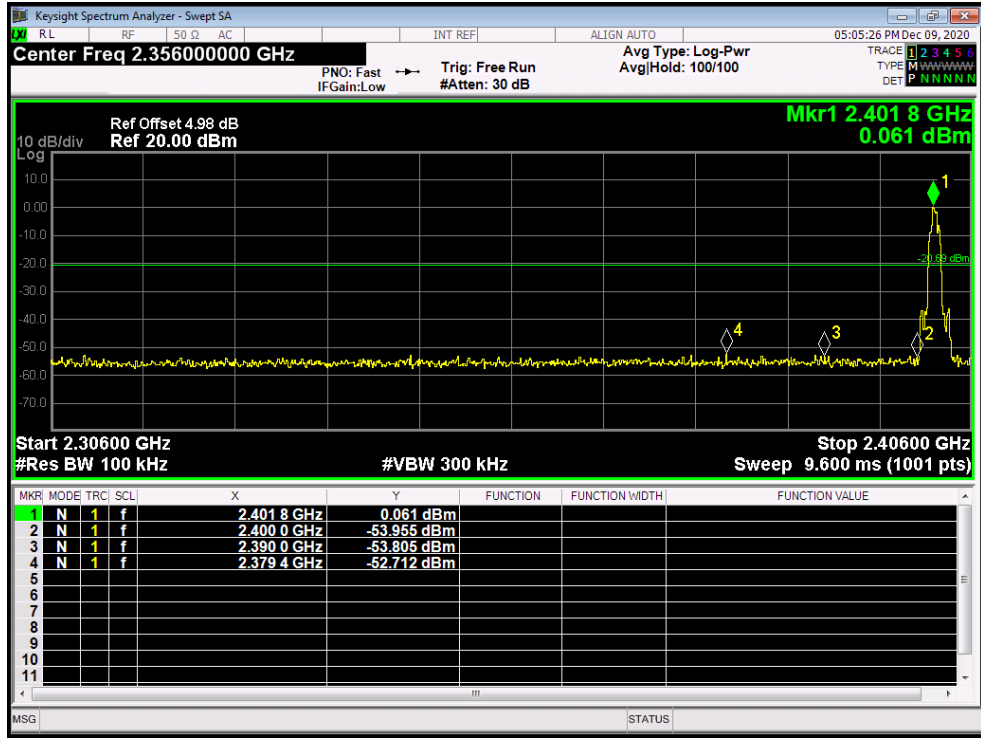

Temperature:	25°C	Relative Humidity:	55%
Test Voltage:	DC 12V		
Test Mode:	8-DPSK Hopping Mode		
Remark:	Only worse case is reported		

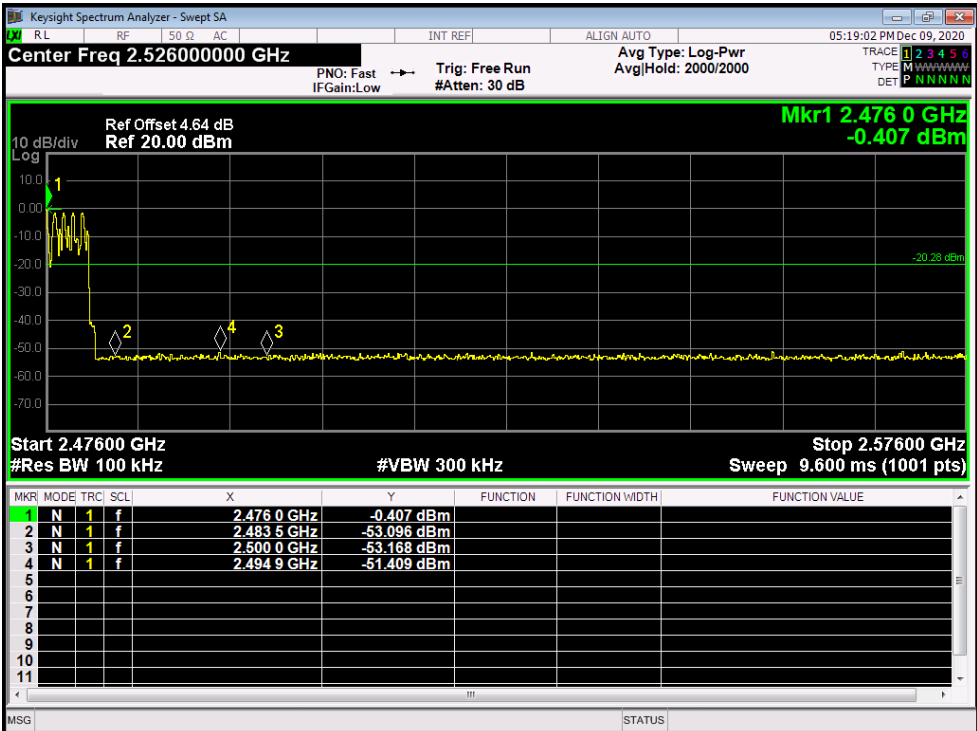
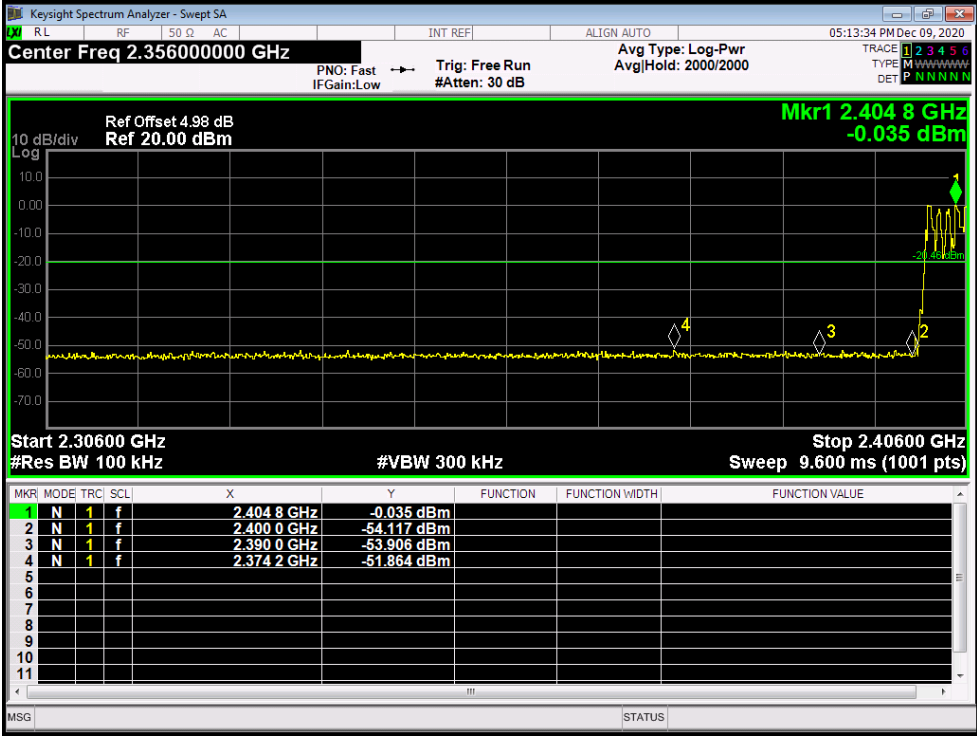

Attachment C-- Number of Hopping Channel Test Data

Temperature:	25°C	Relative Humidity:	55%
Test Voltage:	DC 12V		
Test Mode:	Hopping Mode		
Frequency Range	Test Mode	Quantity of Hopping Channel	Limit
2402MHz~2480MHz	GFSK	79	>15
	$\pi/4$ -DQPSK	79	
	8-DPSK	79	

GFSK Mode

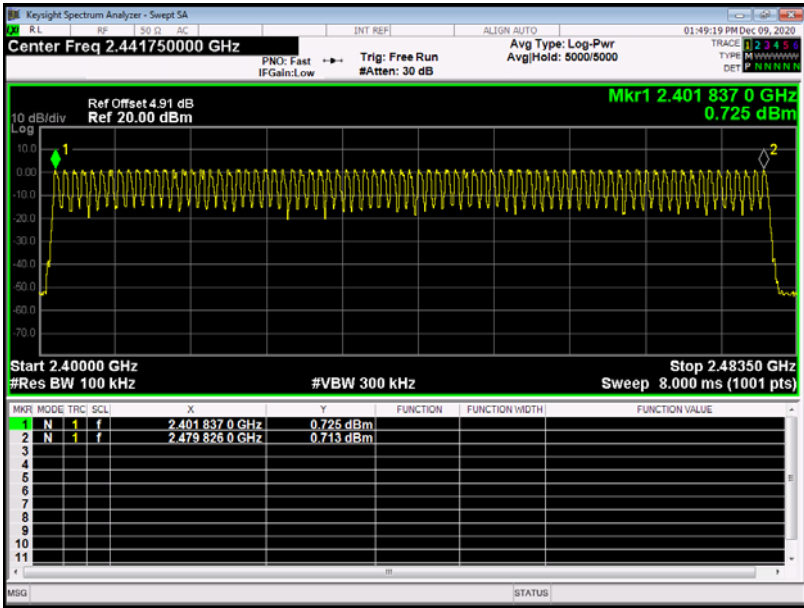

$\pi/4$ -DQPSK Mode

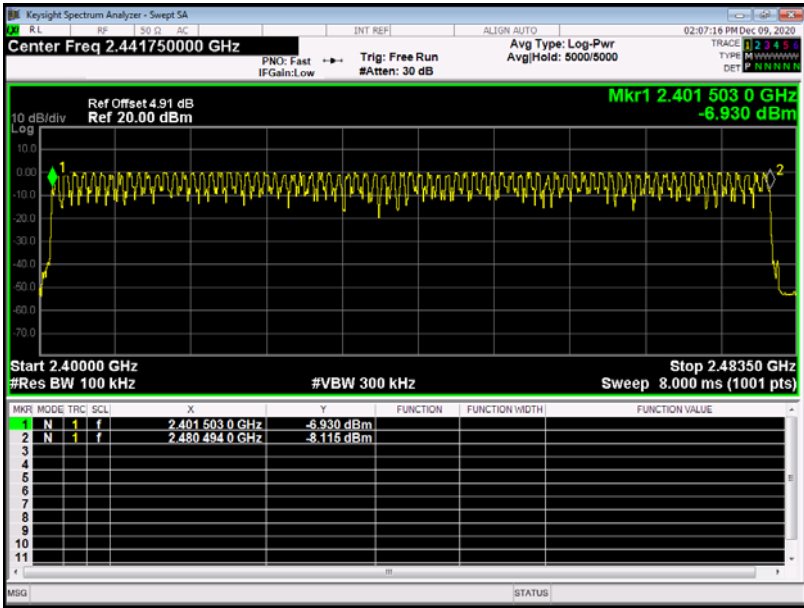

8-DPSK Mode

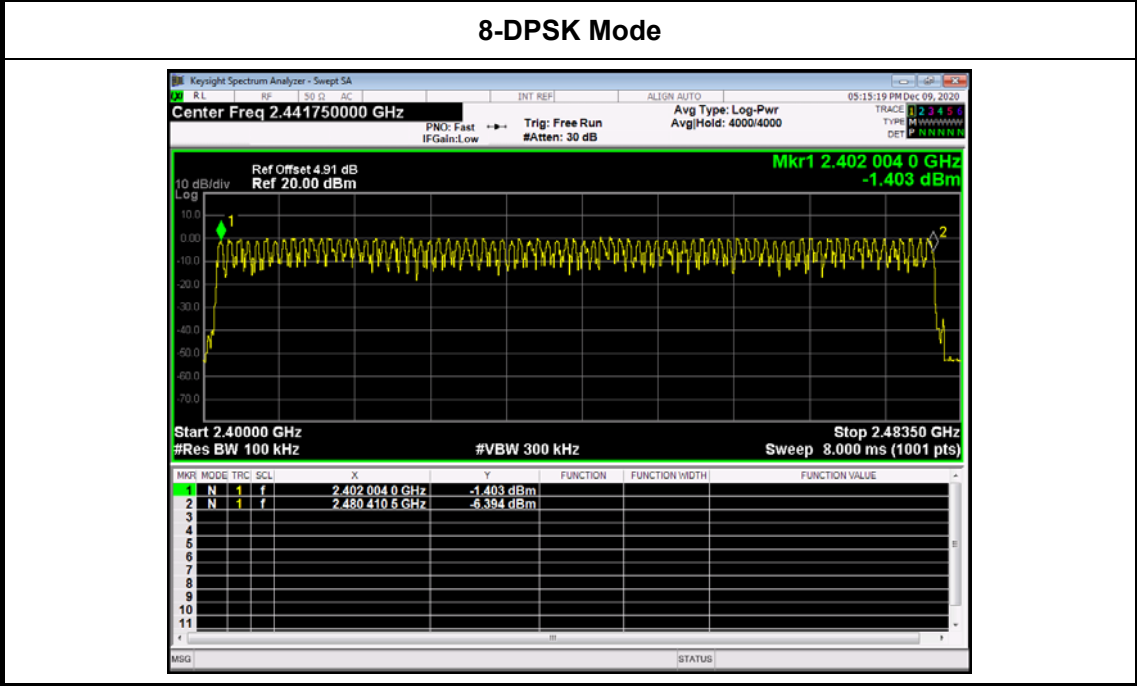

Attachment D-- Average Time of Occupancy Test Data

Temperature: 25°C		Relative Humidity: 55%				
Test Voltage: DC 12V						
Test Mode: Hopping Mode (GFSK)						
Test Mode	Channel (MHz)	Pulse Time (ms)	Total of Dwell (ms)	Period Time (s)	Limit (ms)	Result
1DH1	2441	0.371	118.72	31.60	400	PASS
1DH3	2441	1.627	260.32	31.60	400	PASS
1DH5	2441	2.875	306.667	31.60	400	PASS

1DH1 Total of Dwell= Pulse Time*(1600/2)*31.6/79
 1DH3 Total of Dwell= Pulse Time*(1600/4)*31.6/79
 1DH5 Total of Dwell= Pulse Time*(1600/6)*31.6/79

GFSK Hopping Mode 1DH1

2441 MHz

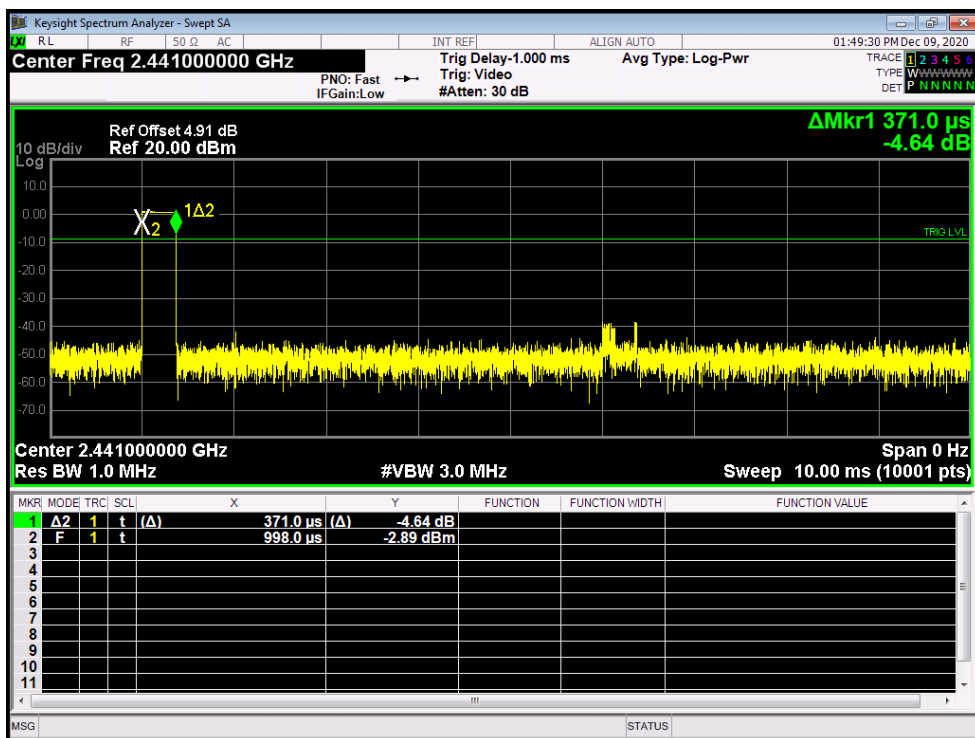

GFSK Hopping Mode 1DH3

2441 MHz

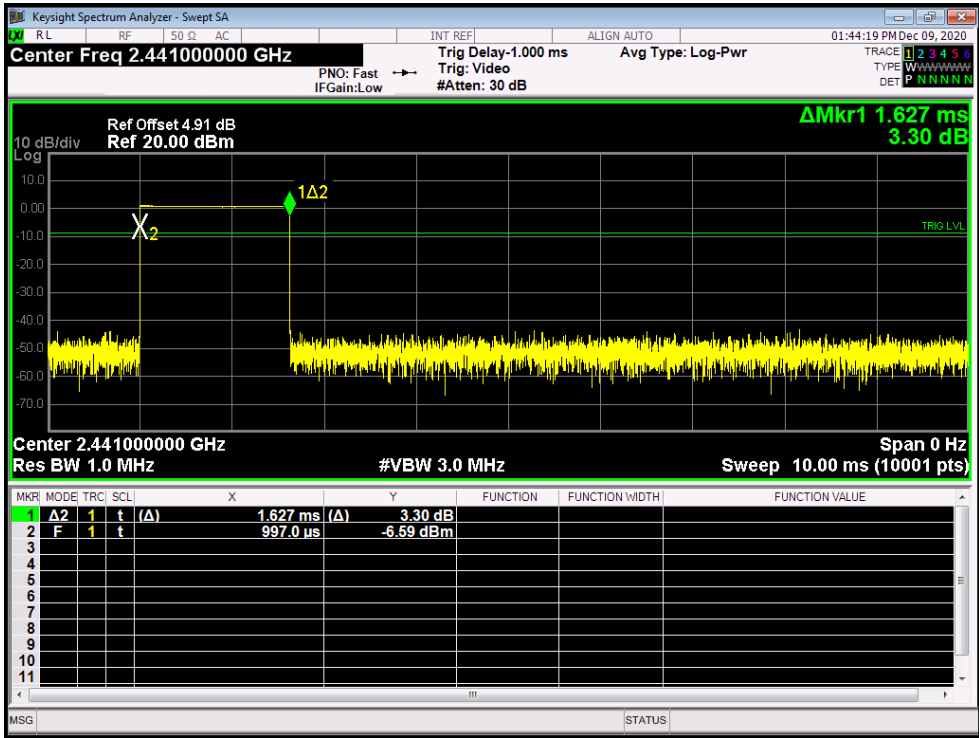

GFSK Hopping Mode 1DH5

2441 MHz

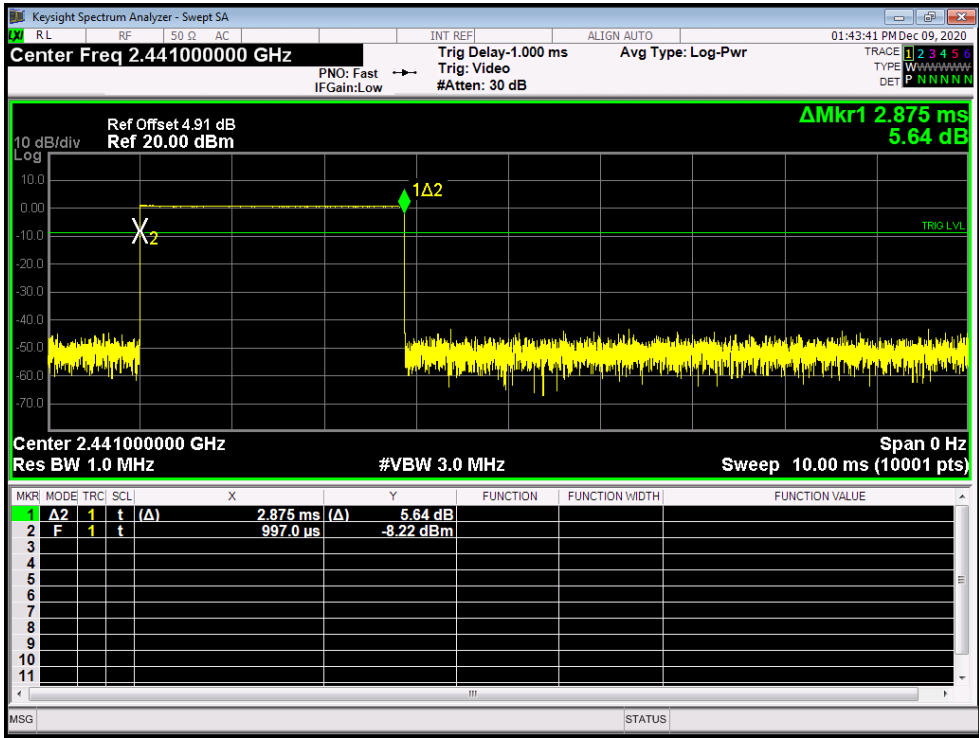

Temperature: 25°C		Relative Humidity: 55%				
Test Voltage: DC 12V						
Test Mode: Hopping Mode ($\pi/4$ -DQPSK)						
Test Mode	Channel (MHz)	Pulse Time (ms)	Total of Dwell (ms)	Period Time (s)	Limit (ms)	Result
2DH1	2441	0.379	121.28	31.60	400	PASS
2DH3	2441	1.63	260.8	31.60	400	PASS
2DH5	2441	2.879	307.093	31.60	400	PASS

2DH1 Total of Dwell= Pulse Time*(1600/2)*31.6/79
 2DH3 Total of Dwell= Pulse Time*(1600/4)*31.6/79
 2DH5 Total of Dwell= Pulse Time*(1600/6)*31.6/79

$\pi/4$ -DQPSK Hopping Mode 2DH1
2441 MHz

MKRI	MODE	TRC	SCL	X	Y	FUNCTION	FUNCTION WIDTH	FUNCTION VALUE
1	Δ2	1	t	(Δ)	379.0 μs (Δ)	-1.27 dB		
2	F	1	t		997.0 μs	-8.29 dBm		
3								
4								
5								
6								
7								
8								
9								
10								
11								

$\pi/4$ -DQPSK Hopping Mode 2DH3

2441 MHz

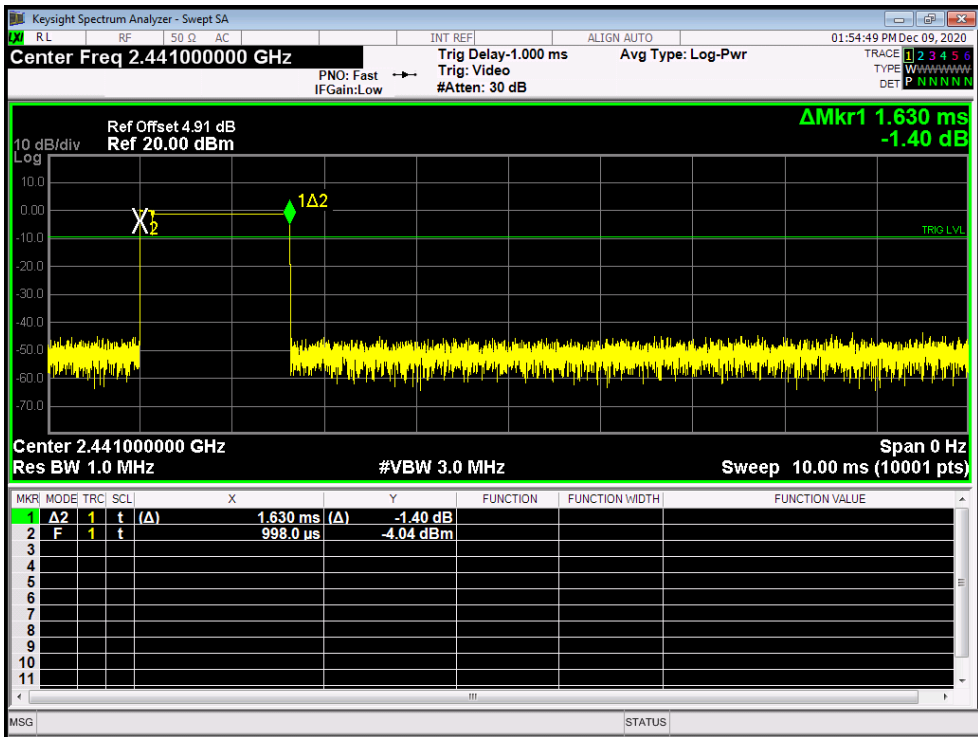

$\pi/4$ -DQPSK Hopping Mode 2DH5

2441 MHz

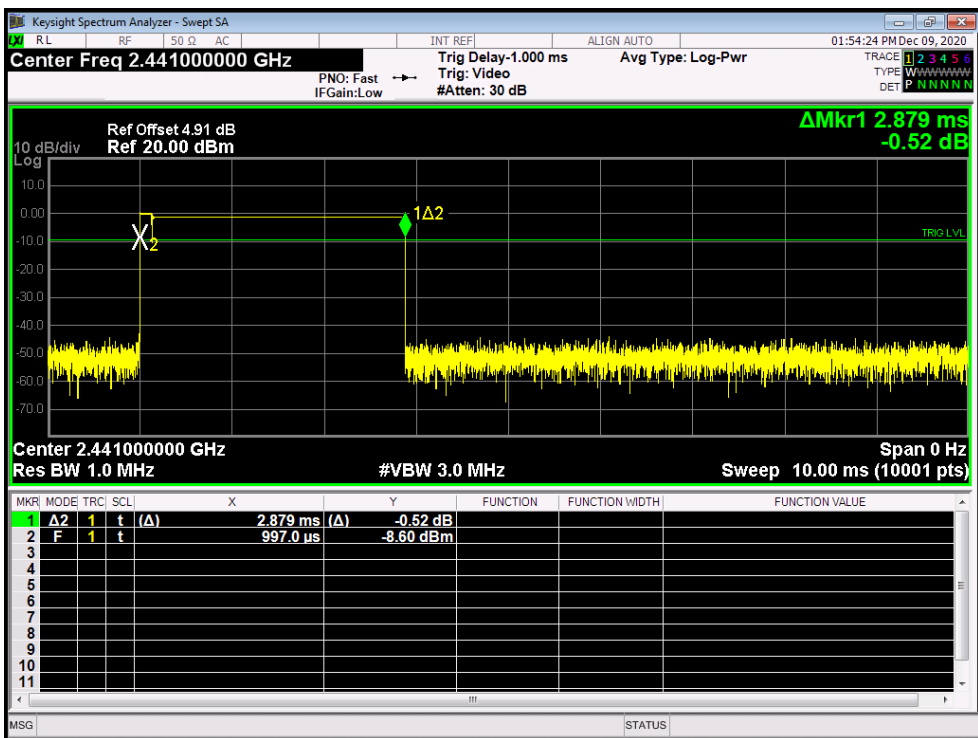

Temperature: 25°C		Relative Humidity: 55%				
Test Voltage: DC 12V						
Test Mode: Hopping Mode (8-DPSK)						
Test Mode	Channel (MHz)	Pulse Time (ms)	Total of Dwell (ms)	Period Time (s)	Limit (ms)	Result
3DH1	2441	0.379	121.28	31.60	400	PASS
3DH3	2441	1.629	260.64	31.60	400	PASS
3DH5	2441	2.88	307.2	31.60	400	PASS

1DH1 Total of Dwell= Pulse Time*(1600/2)*31.6/79
 1DH3 Total of Dwell= Pulse Time*(1600/4)*31.6/79
 1DH5 Total of Dwell= Pulse Time*(1600/6)*31.6/79

8-DPSK Hopping Mode 3DH1
2441 MHz

Center Freq 2.441000000 GHz
 Ref Offset 4.91 dB
 Ref 20.00 dBm
 ΔMkr1 379.0 μs
 -5.76 dB

MKR	MODE	TRC	SCL	X	Y	FUNCTION	FUNCTION WIDTH	FUNCTION VALUE
1	Δ2	1	t	379.0 μs (Δ)	-5.76 dB			
2	F	1	t	998.0 μs	-1.90 dBm			

8-DPSK Hopping Mode 3DH3

2441 MHz

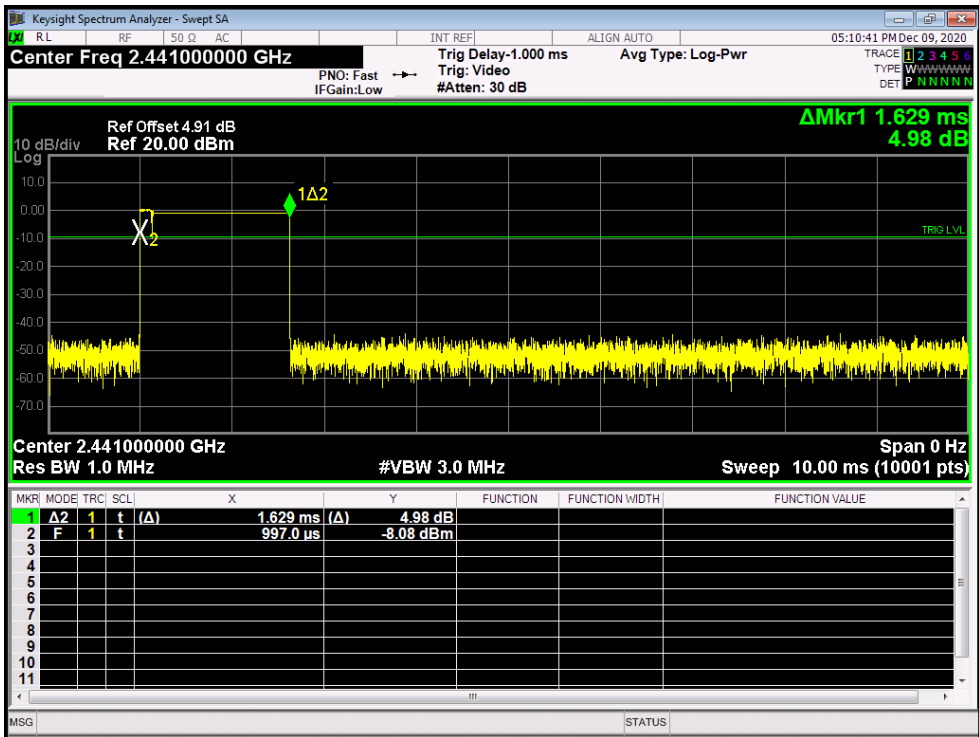

8-DPSK Hopping Mode 3DH5

2441 MHz

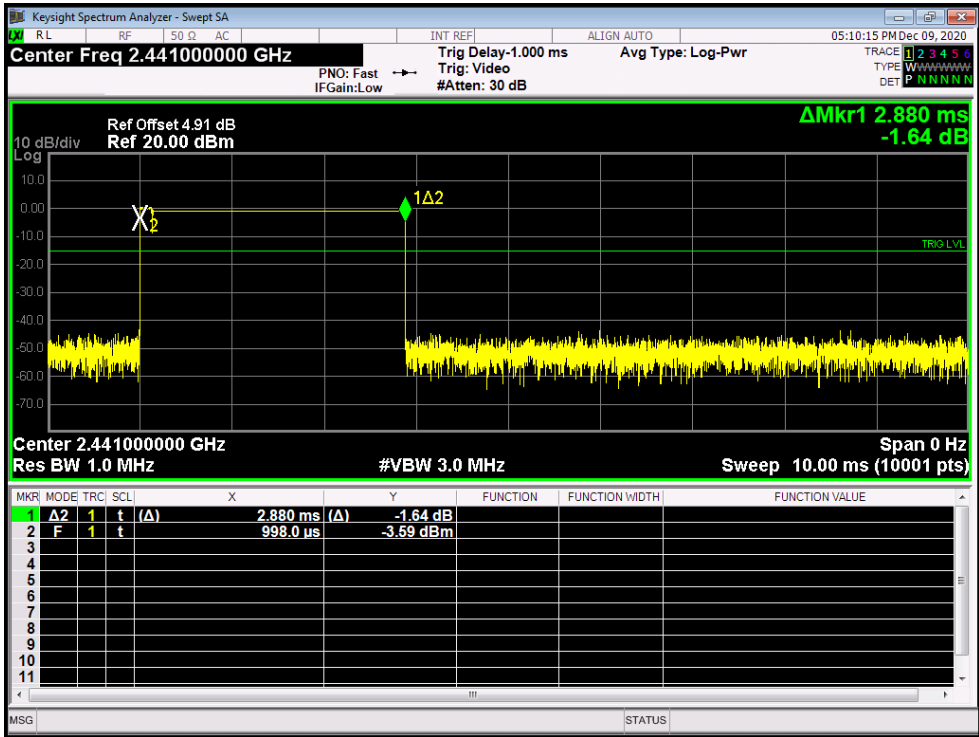

Attachment E-- Channel Separation and Bandwidth Test Data

Temperature:	25°C	Relative Humidity:	55%
Test Voltage:	DC 12V		
Test Mode:	TX Mode (GFSK)		
Channel frequency (MHz)	99% OBW (KHz)	20dB Bandwidth (KHz)	20dB Bandwidth *2/3 (MHz)
2402	860.46	821.8	
2441	857.47	825.4	
2480	833.62	826.9	
GFSK TX Mode			
2402 MHz			
<p>Keysight Spectrum Analyzer - Occupied BW Center Freq 2.402000000 GHz Ref Offset 4.98 dB Ref 24.98 dBm Occupied Bandwidth: 860.46 kHz Total Power: 5.97 dBm Transmit Freq Error: -20.771 kHz % of OBW Power: 99.00 % x dB Bandwidth: 821.8 kHz x dB: -20.00 dB</p>			

GFSK TX Mode

2441 MHz

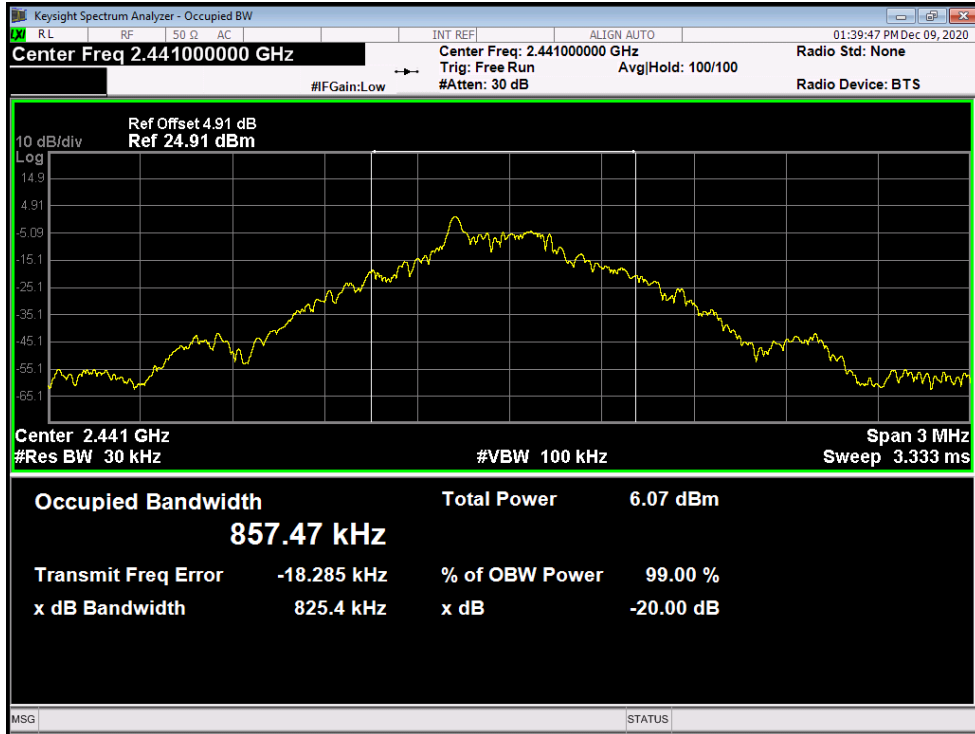

GFSK TX Mode

2480 MHz

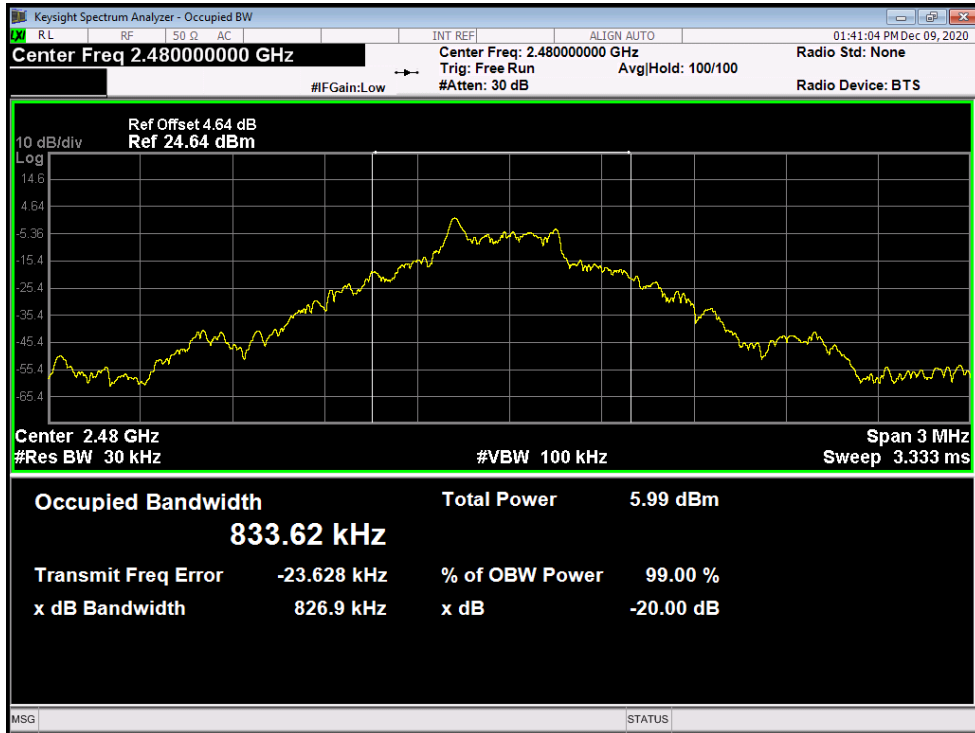

Temperature:	25°C	Relative Humidity:	55%
Test Voltage:	DC 12V		
Test Mode:	TX Mode ($\pi/4$ -DQPSK)		
Channel frequency (MHz)	99% OBW (KHz)	20dB Bandwidth (KHz)	20dB Bandwidth *2/3 (KHz)
2402	1059.7	1098	732.00
2441	1053.1	1095	730.00
2480	1043.4	1078	718.67

$\pi/4$ -DQPSK TX Mode

2402 MHz

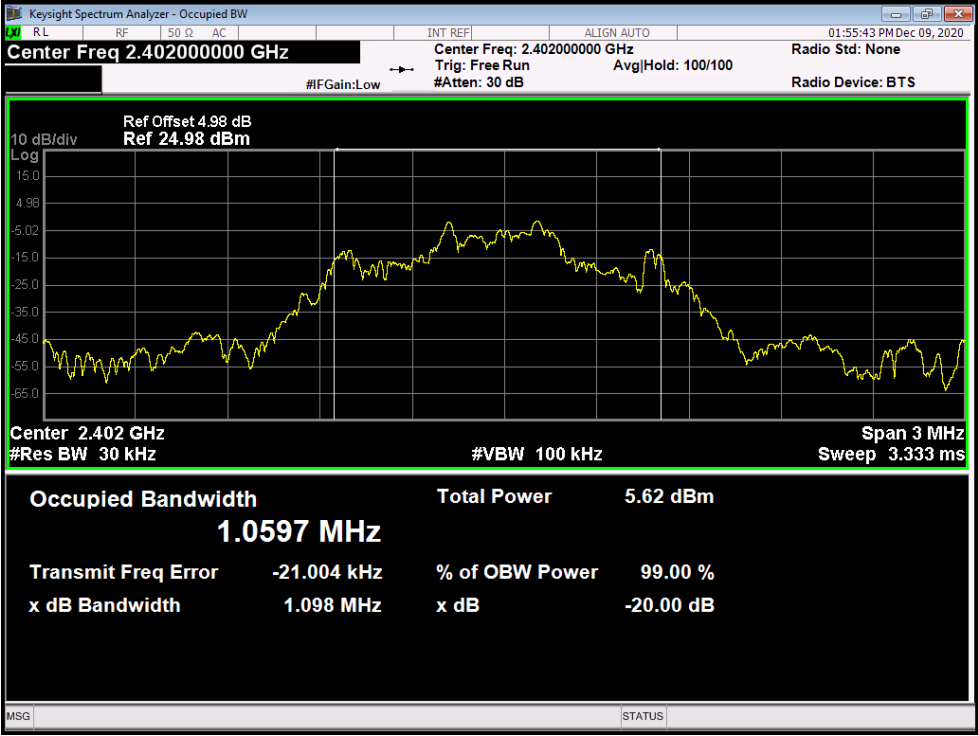

π /4-DQPSK TX Mode

2441 MHz



π /4-DQPSK TX Mode

2480 MHz

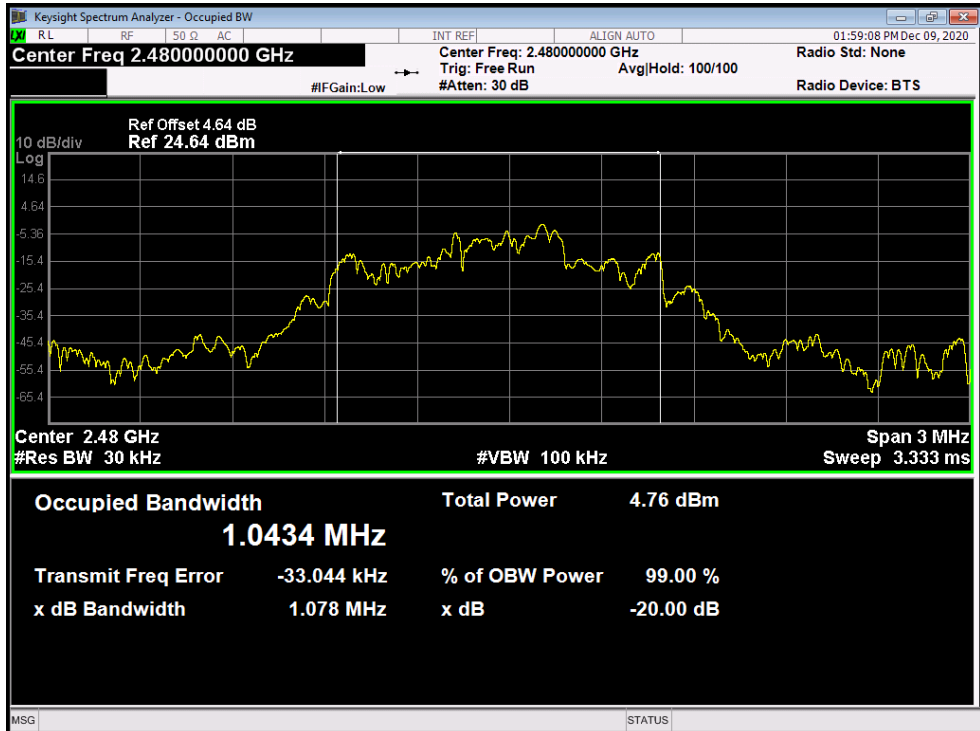

Temperature:	25°C	Relative Humidity:	55%
Test Voltage:	DC 12V		
Test Mode:	TX Mode (8-DPSK)		
Channel frequency (MHz)	99% OBW (KHz)	20dB Bandwidth (KHz)	20dB Bandwidth *2/3 (KHz)
2402	1101.3	1161	774.00
2441	1085.2	1146	764.00
2480	1099.7	1145	763.33

8-DPSK TX Mode

2402 MHz

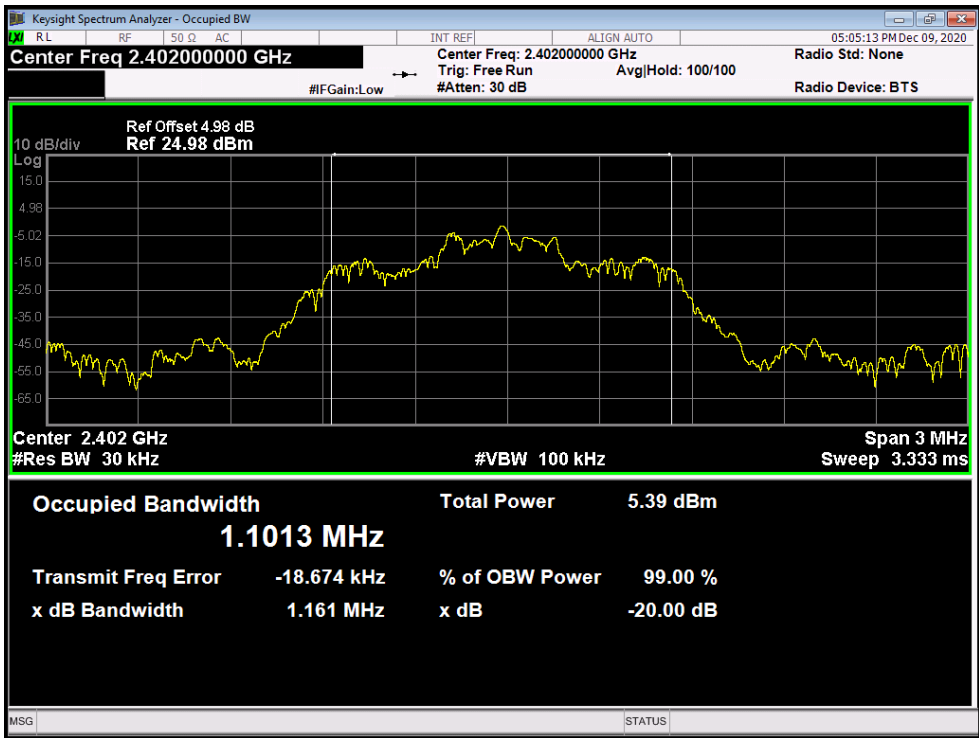

8-DPSK TX Mode

2441 MHz



8-DPSK TX Mode

2480 MHz

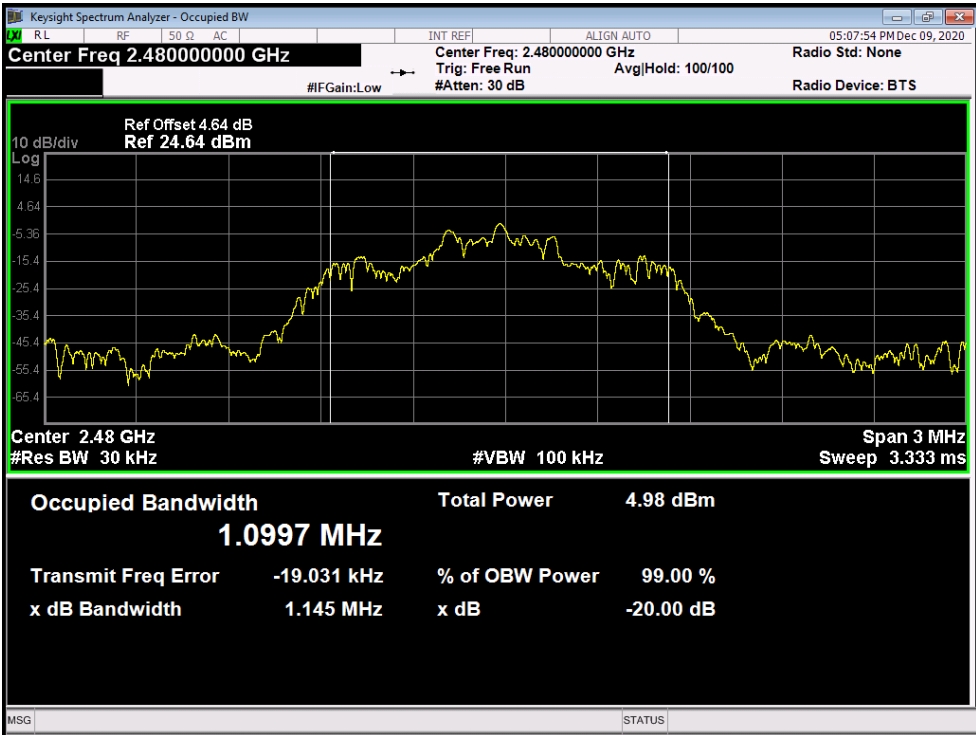

Temperature:	25°C	Relative Humidity:	55%
Test Voltage:	DC 12V		
Test Mode:	Hopping Mode		
Channel frequency (MHz)	Separation Read Value (KHz)	Separation Limit (KHz)	
DH1 2441	999	825.40	
2DH1 2441	1002	730.00	
3DH1 2441	999	764.00	

GFSK Hopping Mode

DH1 2441 MHz

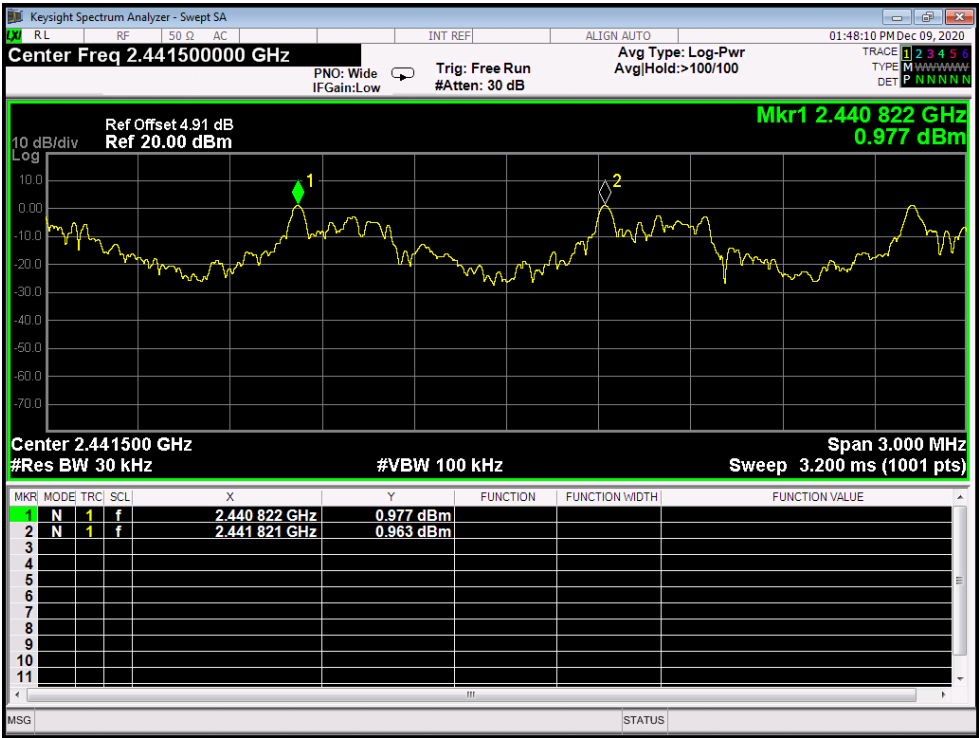

π /4-QPSK Hopping Mode

2DH1 2441 MHz

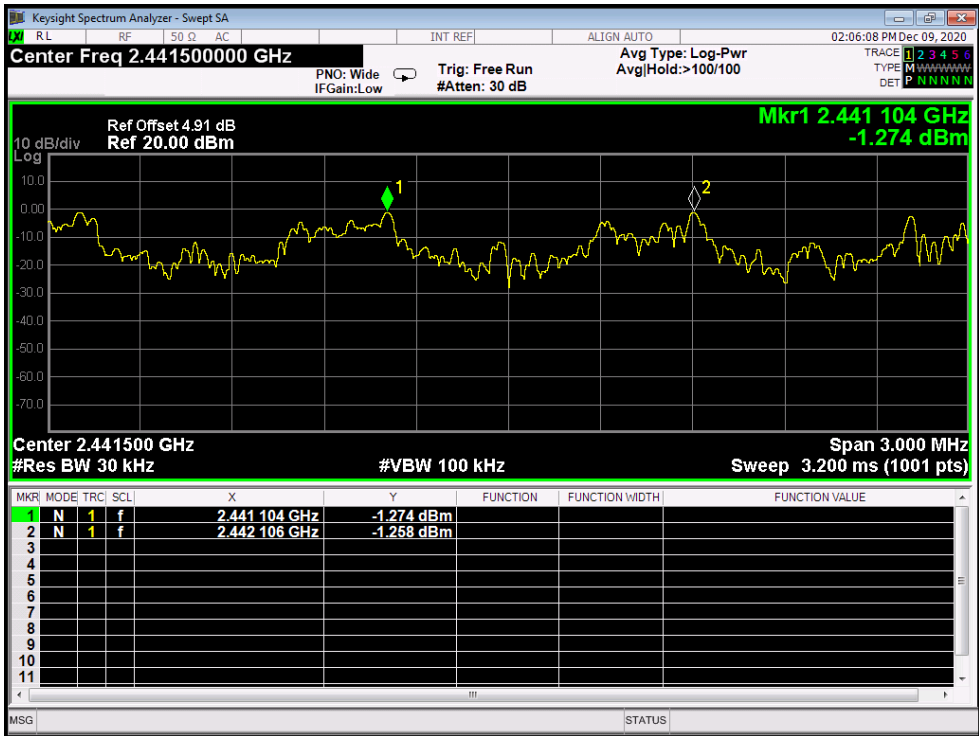

8DPSK Hopping Mode

3DH1 2441 MHz

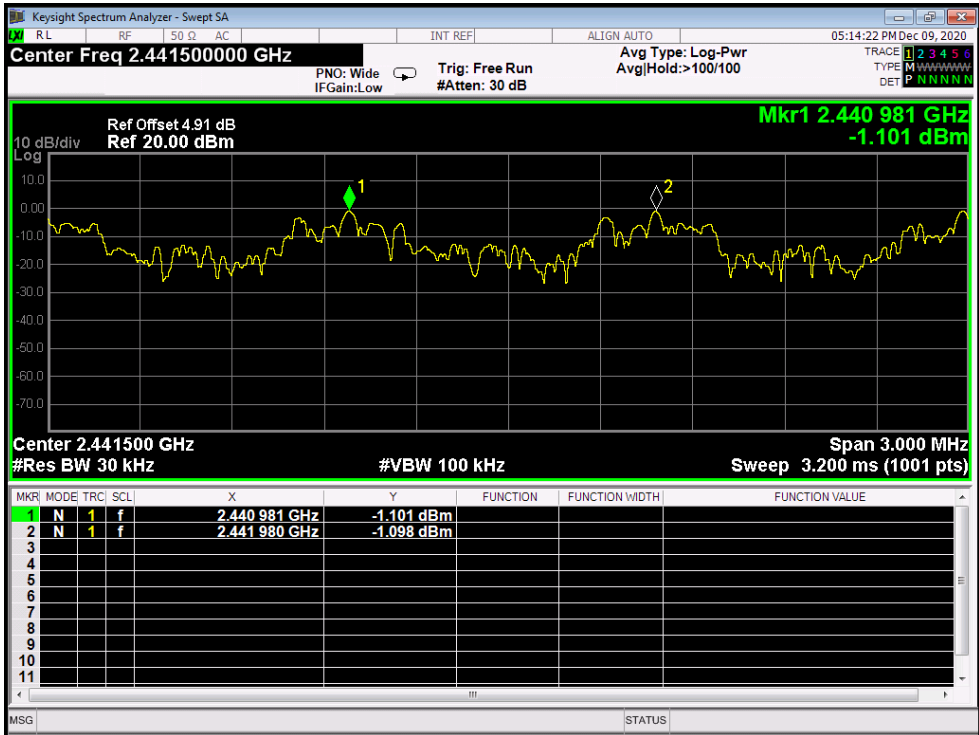

Attachment F-- Peak Output Power Test Data

Temperature:	25°C	Relative Humidity:	55%
Test Voltage:	DC 12V		
Test Mode:	TX Mode (GFSK)		
Channel frequency (MHz)	Test Result (dBm)	Limit (dBm)	
2402	1.141	21	
2441	1.177		
2480	0.609		

GFSK TX Mode

2402 MHz

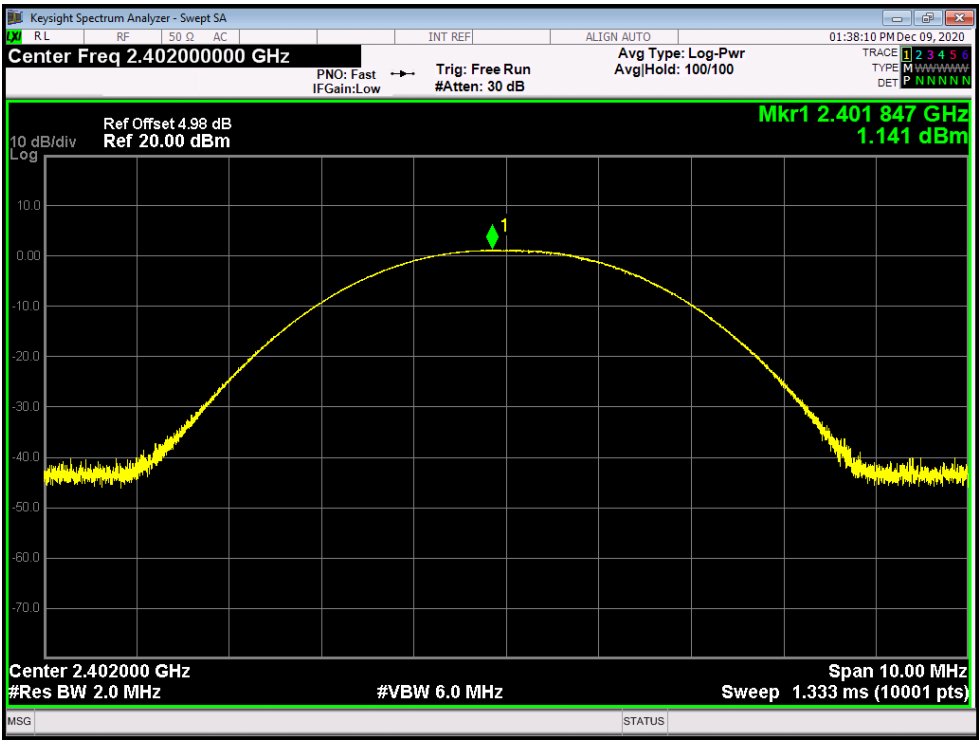

GFSK TX Mode

2441 MHz

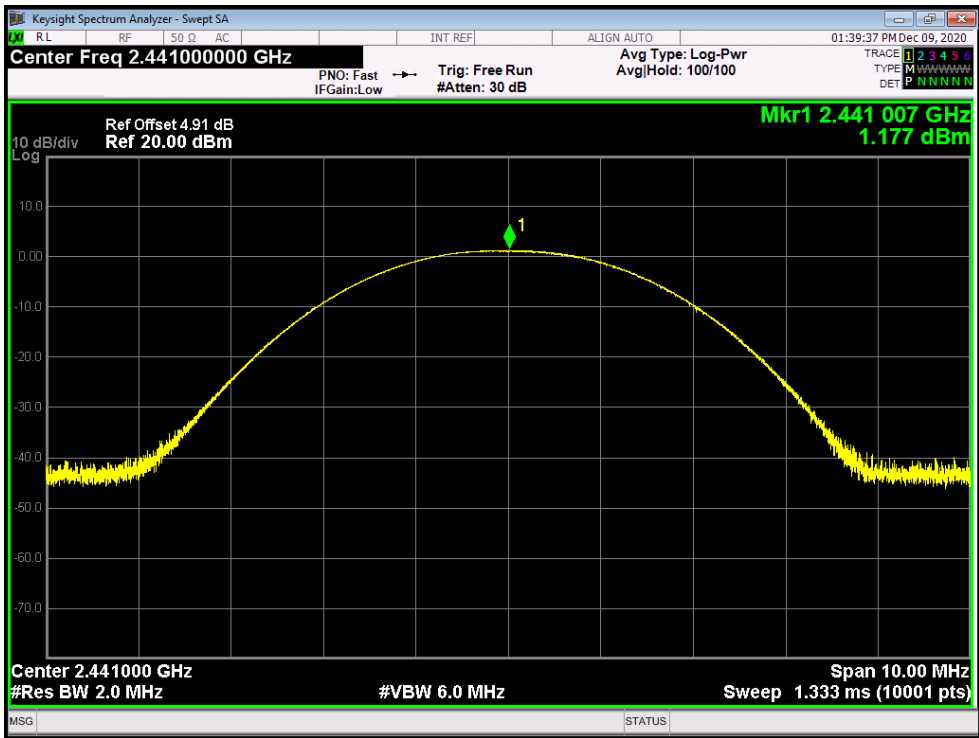

GFSK TX Mode

2480 MHz

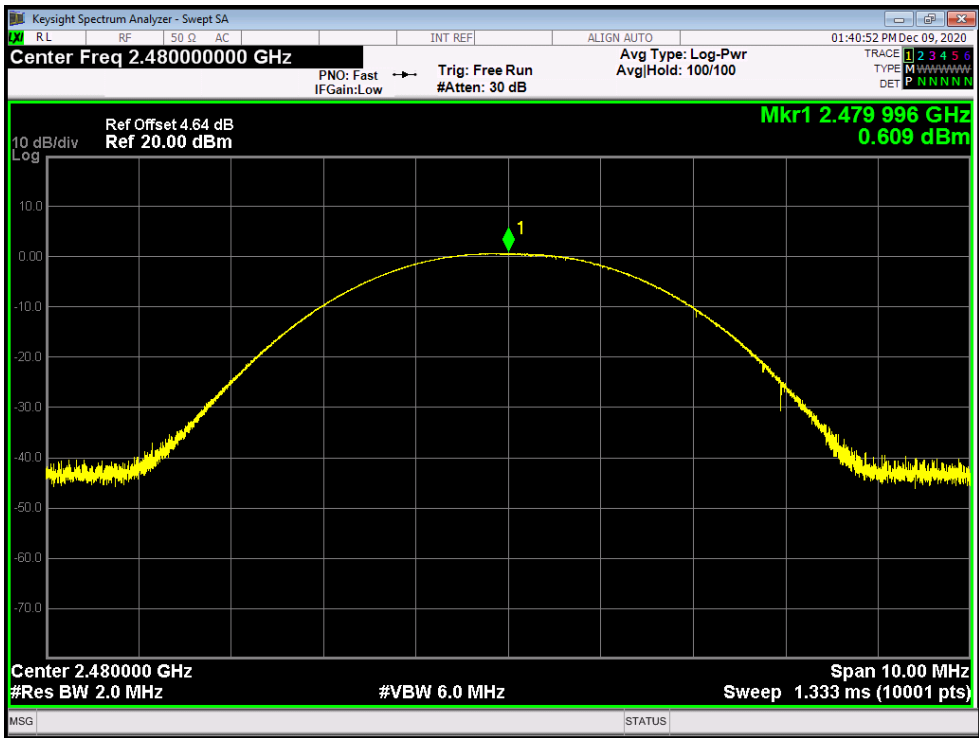

Temperature:	25°C	Relative Humidity:	55%
Test Voltage:	DC 12V		
Test Mode:	TX Mode ($\pi/4$ -DQPSK)		
Channel frequency (MHz)	Test Result (dBm)	Limit (dBm)	
2402	0.186	21	
2441	0.340		
2480	-0.196		

$\pi/4$ -DQPSK TX Mode

2402 MHz

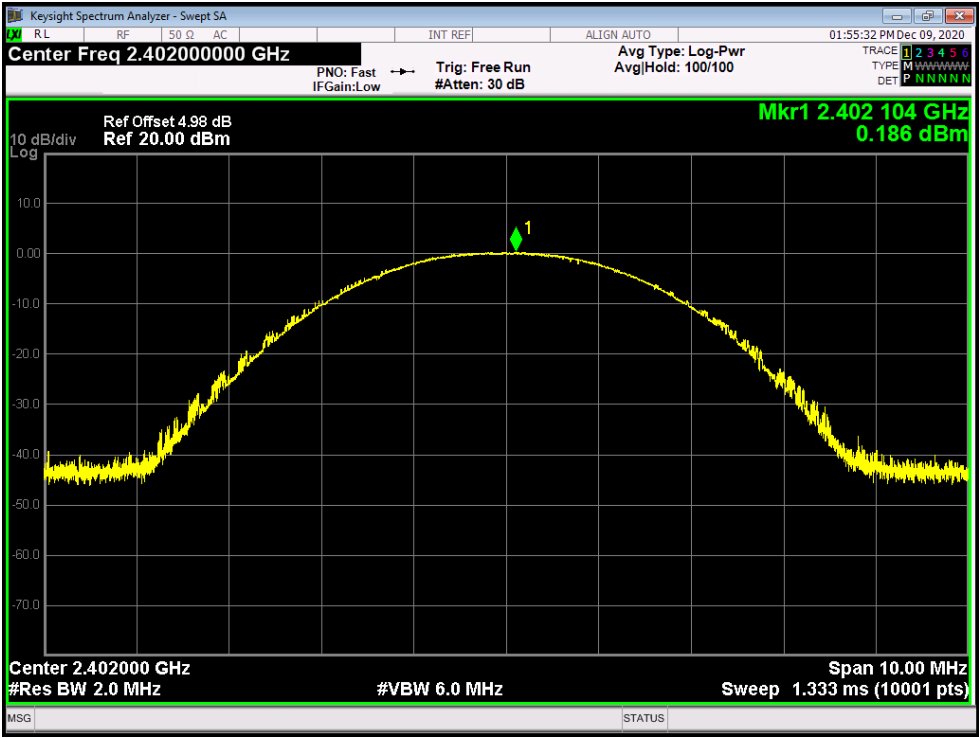

$\pi/4$ -DQPSK TX Mode

2441 MHz

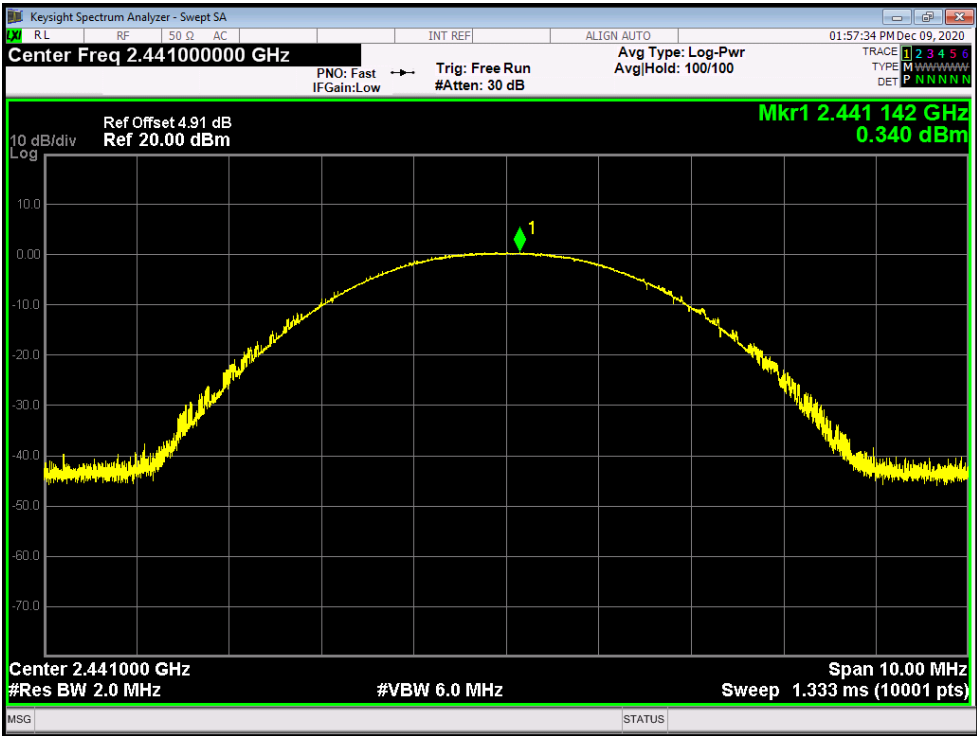

$\pi/4$ -DQPSK TX Mode

2480 MHz

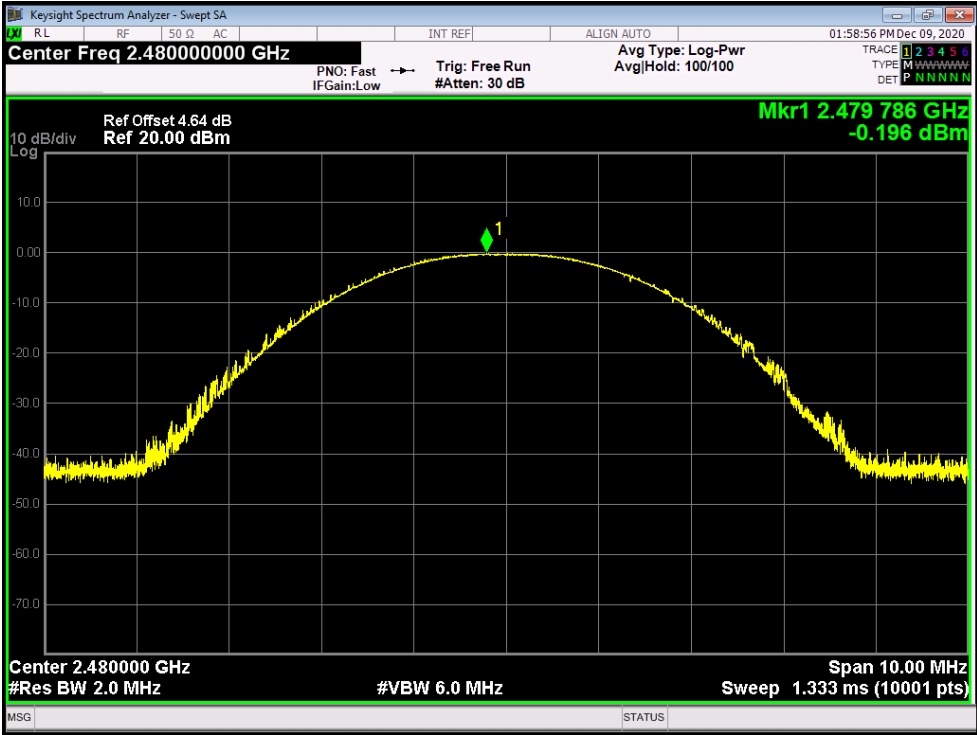

Temperature:	25°C	Relative Humidity:	55%
Test Voltage:	DC 12V		
Test Mode:	TX Mode (8-DPSK)		
Channel frequency (MHz)	Test Result (dBm)	Limit (dBm)	
2402	0.515	21	
2441	0.670		
2480	0.151		

8-DPSK TX Mode

2402 MHz

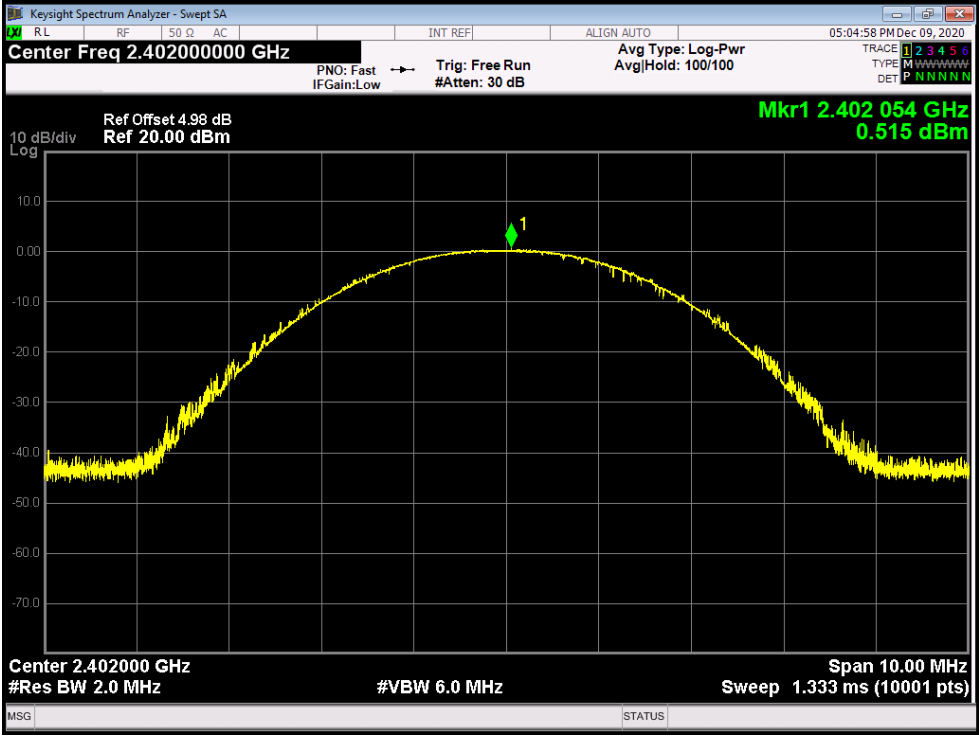

8-DPSK TX Mode

2441 MHz

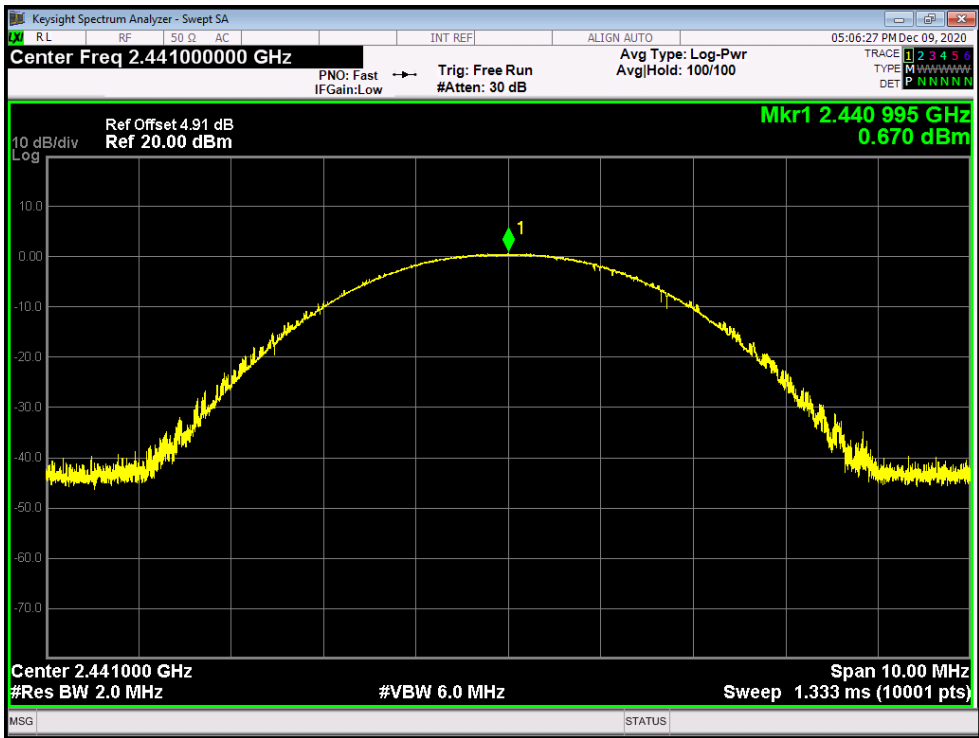

8-DPSK TX Mode

2480 MHz

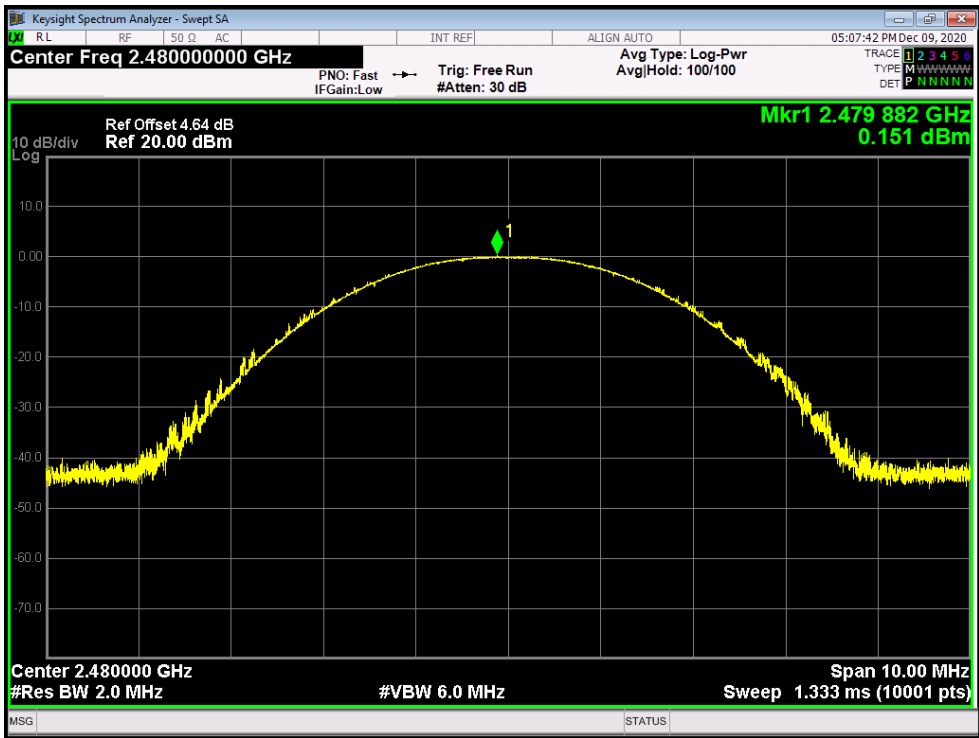

-----END OF REPORT-----