

FCC Radio Test Report

FCC ID: 2AJ5B-C73

Original Grant

Report No. : TB-FCC175155
Applicant : SAGE HUMAN ELECTRONICS INTERNATIONAL CO.,LTD.
Equipment Under Test (EUT)
EUT Name : Bluetooth FM Transmitter for Car
Model No. : C73
Serial Model No. : ----
Brand Name : C73
Sample ID : TBBJ-20200804-09-1-2#& TBBJ-20200804-09-2-2#
Receipt Date : 2020-08-24
Test Date : 2020-08-25 to 2020-09-05
Issue Date : 2020-09-05
Standards : FCC Part 15, Subpart C 15.239
Test Method : ANSI C63.10:2013
Conclusions : **PASS**

In the configuration tested, the EUT complied with the standards specified above, The EUT technically complies with the FCC requirements

Test/Witness Engineer :

Jack

Jack Deng

Engineer Supervisor :

IVAN SU

Ivan Su

Engineer Manager :

Ray Lai

Ray Lai



This report details the results of the testing carried out on one sample. The results contained in this test report do not relate to other samples of the same product. The manufacturer should

TB-RF-074-1.0

ensure that all products in series production are in conformity with the product sample detailed in the report.

Contents

CONTENTS	2
1. GENERAL INFORMATION ABOUT EUT	5
1.1 Client Information.....	5
1.2 General Description of EUT (Equipment Under Test)	5
1.3 Block Diagram Showing the Configuration of System Tested.....	6
1.4 Description of Support Units	6
1.5 Description of Test Mode.....	6
1.6 Description of Test Software Setting	7
1.7 Measurement Uncertainty	7
1.8 Test Facility	8
2. TEST SUMMARY	9
3. TEST SOFTWARE	9
4. TEST EQUIPMENT	10
5. CONDUCTED EMISSION TEST	10
5.1 Test Standard and Limit.....	11
5.2 Test Setup.....	11
5.3 Test Procedure.....	12
5.4 Deviation From Test Standard.....	12
5.5 Test Data.....	12
6. RADIATED EMISSION TEST	13
6.1 Test Standard and Limit.....	13
6.2 Test Setup.....	14
6.3 Test Procedure.....	15
6.4 EUT Operating Condition	15
6.5 Deviation From Test Standard.....	15
6.6 Test Data.....	15
7. FUNDAMENTAL AND BAND EDGE TEST	16
7.1 Test Standard and Limit.....	16
7.2 Test Setup.....	16

7.3 Test Procedure.....	17
7.4 EUT Operating Condition	17
7.5 Deviation From Test Standard.....	17
7.6 Test Data.....	17
8. BANDWIDTH.....	18
8.1 Test Standard and Limit.....	18
8.2 Test Setup.....	18
8.3 Test Procedure.....	18
8.4 EUT Operating Condition	18
8.5 Deviation From Test Standard.....	18
8.6 Test Data.....	18
9. ANTENNA REQUIREMENT.....	19
9.1 Standard Requirement.....	19
9.2 Antenna Connected Construction	19
ATTACHMENT A-- RADIATED EMISSION TEST DATA	20
ATTACHMENT B--FUNDAMENTAL AND BAND EDGE TEST DATA.....	26
ATTACHMENT C-- BANDWIDTH DATA	32

Revision History

Report No.	Version	Description	Issued Date
TB-FCC175155	Rev.01	Initial issue of report	2020-09-05

1. General Information about EUT

1.1 Client Information

Applicant	:	SAGE HUMAN ELECTRONICS INTERNATIONAL CO.,LTD.
Address	:	4F.,A Building,Rongli Industrial Park,No.2 Guiyuan Rd.Guihua Community,Guanlan Town,Longhua New Dist. Shenzhen, China
Manufacturer	:	SAGE HUMAN ELECTRONICS INTERNATIONAL CO.,LTD.
Address	:	4F.,A Building,Rongli Industrial Park,No.2 Guiyuan Rd.Guihua Community,Guanlan Town,Longhua New Dist. Shenzhen, China

1.2 General Description of EUT (Equipment Under Test)

EUT Name	:	Bluetooth FM Transmitter for Car	
Models No.	:	C73	
Model Difference	:	N/A	
Product Description	:	Operation Frequency:	FM: 88.1-107.9 MHz
	:	Antenna Gain:	Internal Antenna(1.5dBi)
	:	Modulation Type:	FM
Power Rating	:	Input: DC 12-24V Output: QC3.0:DC 5V 3A, 9V2A, 12V1.5A PD: DC 5V 3A, 9V2A, 12V1.5A	
Software Version	:	CGBT1843_2819(C73)_[C73]_[87.5(87.5-108.0)]_(CarKit)_SDK230_2020_0811_v1.0.0	
Hardware Version	:	JMS_C73_Main(2819)-V1.0 // JMS_C73_SW3517_V1.0	
Connecting I/O Port(S)	:	Please refer to the User's Manual	

Note:

- (1) For a more detailed features description, please refer to the manufacturer's specifications or the User's Manual.

1.3 Block Diagram Showing the Configuration of System Tested

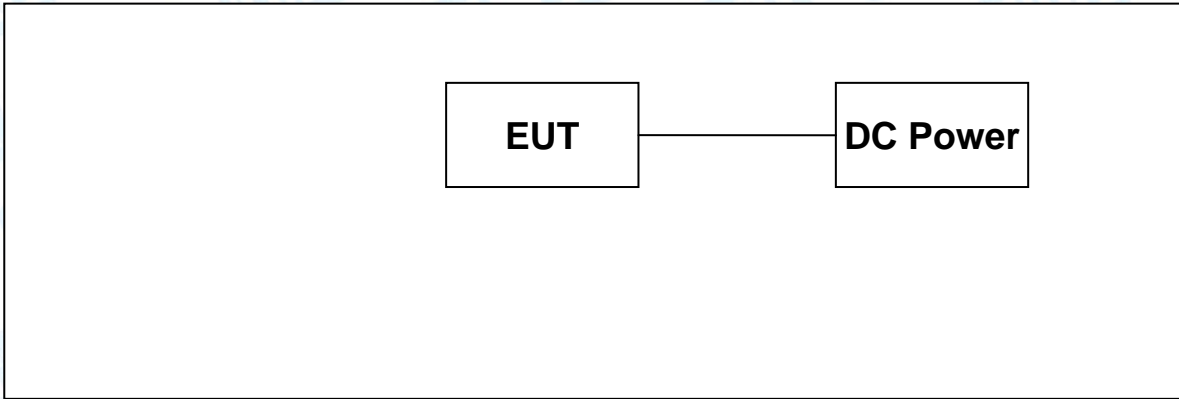

1.4 Description of Support Units

The EUT has been tested as an independent unit.

1.5 Description of Test Mode

To investigate the maximum EMI emission characteristics generates from EUT, the test system was pre-scanning tested base on the consideration of following EUT operation mode or test configuration mode which possible have effect on EMI emission level. Each of these EUT operation mode(s) or test configuration mode(s) mentioned follow was evaluated respectively.

Pretest Mode	
Pretest Mode	Description
Mode 1	Continuously transmitting (88.1MHz/98.1MHz/107.9MHz)
Conducted Emission	
Test Mode	Description
Mode 1	Continuously transmitting (88.1MHz)
Radiated Emission	
Test Mode	Description
Mode 1	Continuously transmitting (88.1MHz/98.1MHz/107.9MHz)
Note : The antenna gain provided by the applicant, the verified for the RF conduction test provided by TOBY test lab.	

Note:

- (1) During the testing procedure, the continuously transmitting mode was programmed by the customer.
- (2) The EUT is considered a portable unit, and it was pre-tested on the positioned of each 3 axis: X axis, Y axis and Z axis. The worst case was found positioned on Z-plane. There for only the test data of this Z-plane were used for radiated emission measurement test.

1.6 Description of Test Software Setting

During testing channel & Power controlling software provided by the customer was used to control the operating channel as well as the output power level. The RF output power selection is for the setting of RF output power expected by the customer and is going to be fixed on the firmware of the final end product power parameters of transmitting mode.

1	Product SW/HW Version :	N/A
2	Radio SW/HW Version:	N/A
3	Test SW Version:	N/A
4	RF Power Setting in Test SW:	DEF

1.7 Measurement Uncertainty

The reported uncertainty of measurement $y \pm U$, where expanded uncertainty U is based on a standard uncertainty multiplied by a coverage factor of $k=2$, providing a level of confidence of approximately 95 %.

Test Item	Parameters	Expanded Uncertainty (U_{Lab})
Conducted Emission	Level Accuracy: 9kHz~150kHz 150kHz to 30MHz	± 3.50 dB ± 3.10 dB
Radiated Emission	Level Accuracy: 9kHz to 30 MHz	± 4.60 dB
Radiated Emission	Level Accuracy: 30MHz to 1000 MHz	± 4.50 dB
Radiated Emission	Level Accuracy: Above 1000MHz	± 4.20 dB

1.8 Test Facility

The testing report were performed by the Shenzhen Toby Technology Co., Ltd., in their facilities located at 1A/F., Bldg.6, Yusheng Industrial Zone, The National Road No.107 Xixiang Section 467, Xixiang, Bao'an, Shenzhen, Guangdong, China. At the time of testing, the following bodies accredited the Laboratory:

CNAS (L5813)

The Laboratory has been accredited by CNAS to ISO/IEC 17025: 2005 General Requirements for the Competence of Testing and Calibration Laboratories for the competence in the field of testing. And the Registration No.: CNAS L5813.

A2LA Certificate No.: 4750.01

The laboratory has been accredited by American Association for Laboratory Accreditation(A2LA) to ISO/IEC 17025: 2005 General Requirements for the Competence of Testing and Calibration Laboratories for the technical competence in the field of Electrical Testing. And the A2LA Certificate No.: 4750.01. FCC Accredited Test Site Number: 854351.

IC Registration No.: (11950A-1)

The Laboratory has been registered by Certification and Engineering Bureau of Industry Canada for radio equipment testing. The site registration: Site# 11950A.

2. Test Summary

FCC Part 15 Subpart (15.239)				
Standard Section	Test Item	Test Sample(s)	Judgment	Remark
15.203	Antenna Requirement	TBBJ-20200804-09-2-2#	PASS	
15.207	Conducted Emission	TBBJ-20200804-09-1-2#	PASS	
15.239 & 15.209	Radiation Emission	TBBJ-20200804-09-1-2# TBBJ-20200804-09-2-2#	PASS	
15.239	Occupied Bandwidth	TBBJ-20200804-09-2-2#	PASS	

Note: N/A is an abbreviation for Not Applicable.

3. Test Software

Test Item	Test Software	Manufacturer	Version No.
Conducted Emission	EZ-EMC	EZ	CDI-03A2
Radiation Emission	EZ-EMC	EZ	FA-03A2RE
RF Conducted Measurement	MTS-8310	MWRfTest	V2.0.0.0

4. Test Equipment

Conducted Emission Test					
Equipment	Manufacturer	Model No.	Serial No.	Last Cal.	Cal. Due Date
EMI Test Receiver	Rohde & Schwarz	ESCI	100321	Jul. 06, 2020	Jul. 05, 2021
RF Switching Unit	Compliance Direction Systems Inc	RSU-A4	34403	Jul. 06, 2020	Jul. 05, 2021
AMN	SCHWARZBECK	NNBL 8226-2	8226-2/164	Jul. 06, 2020	Jul. 05, 2021
LISN	Rohde & Schwarz	ENV216	101131	Jul. 06, 2020	Jul. 05, 2021
Radiation Emission Test					
Equipment	Manufacturer	Model No.	Serial No.	Last Cal.	Cal. Due Date
Spectrum Analyzer	Agilent	E4407B	MY45106456	Jul. 06, 2020	Jul. 05, 2021
EMI Test Receiver	Rohde & Schwarz	ESPI	100010/007	Jul. 06, 2020	Jul. 05, 2021
Spectrum Analyzer	Rohde & Schwarz	FSV40-N	102197	Jul. 06, 2020	Jul. 05, 2021
Bilog Antenna	ETS-LINDGREN	3142E	00117537	Mar.01, 2020	Feb. 28, 2022
Horn Antenna	ETS-LINDGREN	3117	00143207	Mar.01, 2020	Feb. 28, 2022
Horn Antenna	ETS-LINDGREN	BBHA 9170	BBHA9170582	Mar.01, 2020	Feb. 28, 2022
Loop Antenna	SCHWARZBECK	FMZB 1519 B	1519B-059	Jul. 07, 2020	Jul. 06, 2021
Pre-amplifier	Sonoma	310N	185903	Mar.01, 2020	Feb. 28, 2021
Pre-amplifier	HP	8449B	3008A00849	Mar.01, 2020	Feb. 28, 2021
Pre-amplifier	SKET	LNPA_1840G-50	SK201904032	Mar.01, 2020	Feb. 28, 2021
Cable	HUBER+SUHNER	100	SUCOFLEX	Mar.01, 2020	Feb. 28, 2021
Positioning Controller	ETS-LINDGREN	2090	N/A	N/A	N/A
Antenna Conducted Emission					
Equipment	Manufacturer	Model No.	Serial No.	Last Cal.	Cal. Due Date
Spectrum Analyzer	Agilent	E4407B	MY45106456	Jul. 06, 2020	Jul. 05, 2021
Spectrum Analyzer	Rohde & Schwarz	ESPI	100010/007	Jul. 06, 2020	Jul. 05, 2021
MXA Signal Analyzer	Agilent	N9020A	MY49100060	Sep. 11, 2020	Sep. 10, 2021
Vector Signal Generator	Agilent	N5182A	MY50141294	Sep. 11, 2020	Sep. 10, 2021
Analog Signal Generator	Agilent	N5181A	MY50141953	Sep. 11, 2020	Sep. 10, 2021
RF Power Sensor	DARE!! Instruments	RadiPowerRPR3006W	17100015SNO26	Sep. 11, 2020	Sep. 10, 2021
	DARE!! Instruments	RadiPowerRPR3006W	17100015SNO29	Sep. 11, 2020	Sep. 10, 2021
	DARE!! Instruments	RadiPowerRPR3006W	17100015SNO31	Sep. 11, 2020	Sep. 10, 2021
	DARE!! Instruments	RadiPowerRPR3006W	17100015SNO33	Sep. 11, 2020	Sep. 10, 2021

5. Conducted Emission Test

5.1 Test Standard and Limit

5.1.1 Test Standard
FCC Part 15.207

5.1.2 Test Limit

Conducted Emission Test Limit

Frequency	Maximum RF Line Voltage (dB μ V)	
	Quasi-peak Level	Average Level
150kHz~500kHz	66 ~ 56 *	56 ~ 46 *
500kHz~5MHz	56	46
5MHz~30MHz	60	50

Notes:

- (1) *Decreasing linearly with logarithm of the frequency.
- (2) The lower limit shall apply at the transition frequencies.
- (3) The limit decrease in line with the logarithm of the frequency in the range of 0.15 to 0.50MHz.

5.2 Test Setup

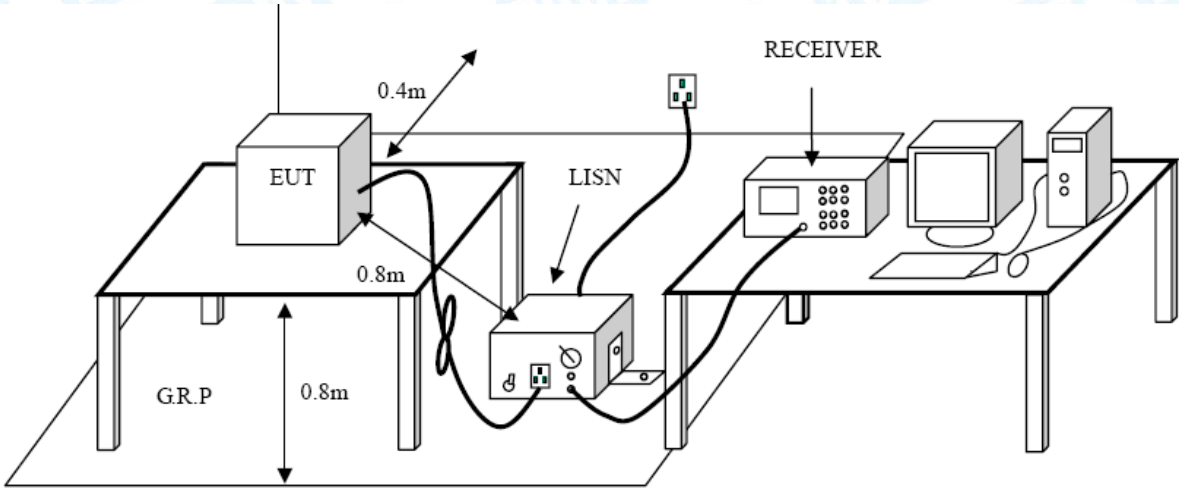

5.3 Test Procedure

The EUT was placed 0.8 meters from the horizontal ground plane with EUT being connected to the power mains through a line impedance stabilization network (LISN). All other support equipments powered from additional LISN(s). The LISN provide 50 Ohm/50uH of coupling impedance for the measuring instrument.

Interconnecting cables that hang closer than 40 cm to the ground plane shall be folded back and forth in the center forming a bundle 30 to 40 cm long.

I/O cables that are not connected to a peripheral shall be bundled in the center. The end of the cable may be terminated, if required, using the correct terminating impedance. The overall length shall not exceed 1 m.

LISN at least 80 cm from nearest part of EUT chassis.

The bandwidth of EMI test receiver is set at 9kHz, and the test frequency band is from 0.15MHz to 30MHz.

5.4 Deviation From Test Standard

No deviation

5.5 Test Data

Not Applicable

6. Radiated Emission Test

6.1 Test Standard and Limit

6.1.1 Test Standard

FCC Part 15.209 & 15.239

6.1.2 Test Limit

According to FCC 15.209 requirement:

In addition to the provisions of Section 15.209, the field strength of emissions from intentional radiators operated under this Section shall not exceed the following:

Frequency (MHz)	Field Strength (microvolt/meter)	Measurement Distance (meters)
0.009~0.490	2400/F(KHz)	300
0.490~1.705	24000/F(KHz)	30
1.705~30.0	30	30
30~88	100	3
88~216	150	3
216~960	200	3
Above 960	500	3

Radiated Emission Limit (Above 1000MHz)

Frequency (MHz)	Distance Meters(at 3m)	
	Peak	Average
Above 1000	74	54

Note:

- (1) The tighter limit applies at the band edges.
- (2) Emission Level (dBuV/m)=20log Emission Level (uV/m)

6.2 Test Setup

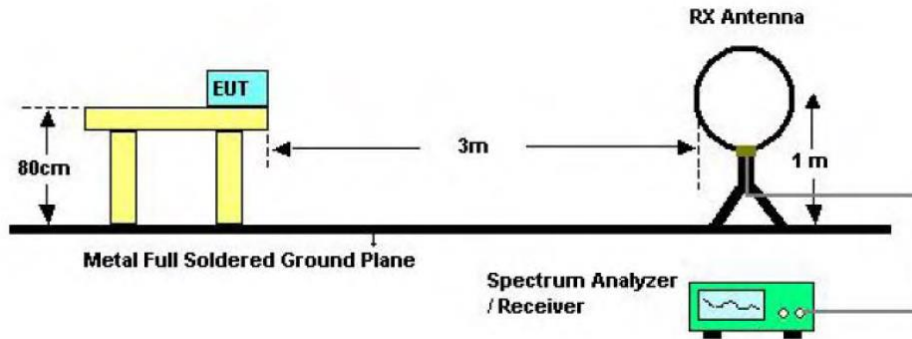

Below 30MHz Test Setup

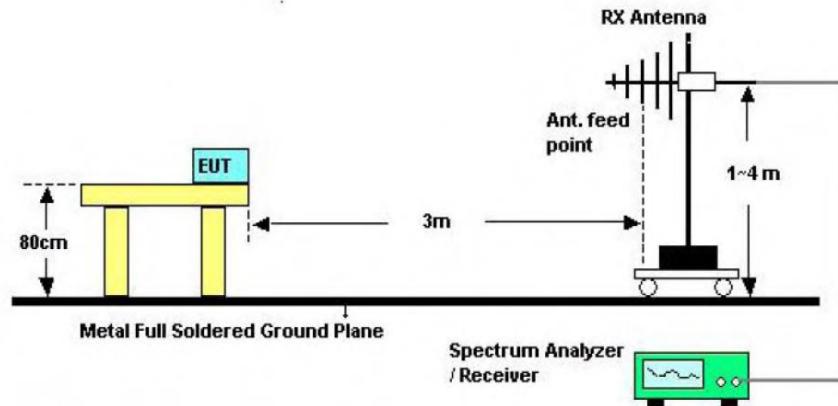

Below 1000MHz Test Setup

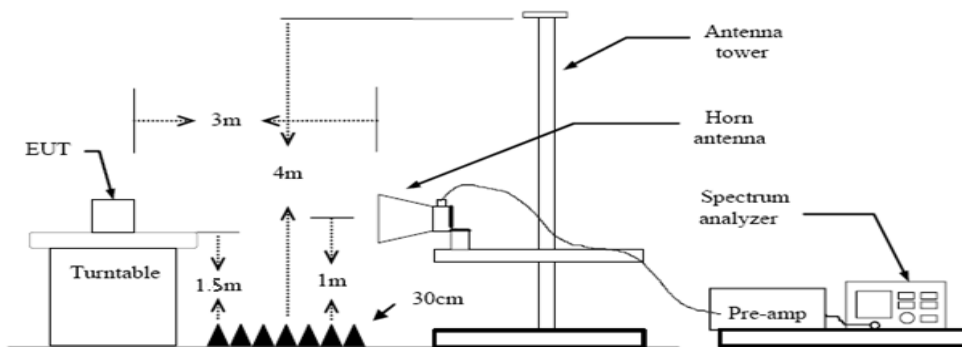

Above 1GHz Test Setup

6.3 Test Procedure

- (1) The measuring distance of 3m shall be used for measurements at frequency up to 1GHz. The EUT was placed on a rotating 0.8m high above the ground, the table was rotated 360 degrees to determine the position of the highest radiation.
- (2) Measurements at frequency above 1GHz. The EUT was placed on a rotating 1.5m high above the ground. RF absorbers covered the ground plane with a minimum area of 3.0m by 3.0m between the EUT and measurement receiver antenna. The RF absorber shall not exceed 30cm in high above the conducting floor. The table was rotated 360 degrees to determine the position of the highest radiation.
- (3) The Test antenna shall vary between 1m and 4m, Both Horizontal and Vertical antenna are set to make measurement.
- (4) The initial step in collecting conducted emission data is a spectrum analyzer peak detector mode pre-scanning the measurement frequency range. Significant peaks are then marked and then Quasi Peak detector mode re-measured.
- (5) If the Peak Mode measured value compliance with and lower than Quasi Peak Mode Limit Bellow 1 GHz, the EUT shall be deemed to meet QP Limits and then no additional QP Mode measurement performed. But the Peak Value and average value both need to comply with applicable limit above 1 GHz.
- (6) Testing frequency range below 1GHz the measuring instrument use VBW=120 kHz with Quasi-peak detection.
- (7) Testing frequency range above 1GHz the measuring instrument use RBW=1 MHz and VBW=3 MHz with Peak Detector for Peak Values, and use RBW=1 MHz and VBW=10 Hz with Peak Detector for Average Values.
- (8) For the actual test configuration, please see the test setup photo.

6.4 EUT Operating Condition

The Equipment Under Test was set to Continual Transmitting in maximum power.

6.5 Deviation From Test Standard

No deviation

6.6 Test Data

Please refer to the Attachment A.

7. Fundamental and Band Edge Test

7.1 Test Standard and Limit

- 7.1.1 Test Standard
FCC Part 15.209 & 15.239
- 7.1.2 Test Limit

According to FCC 15.239(a)(b) and 15.209 requirement:
The field strength of emissions from the intentional radiators operated under these frequency bands shall not exceed the following:

Fundamental Frequency (MHz)	Field Strength of Fundamental (dBUV/m)	
	Peak	Average
88 to 108	67.96	47.96

According to FCC 15.239(c) and 15.209 requirements:
Field strength of outside of the frequency bands limit show in below table.

Outside Frequency Band Edge	Distance Meters(at 3m)
Below 88 MHz	40.0 (QP)
Above 108 MHz	43.5 (QP)

7.2 Test Setup

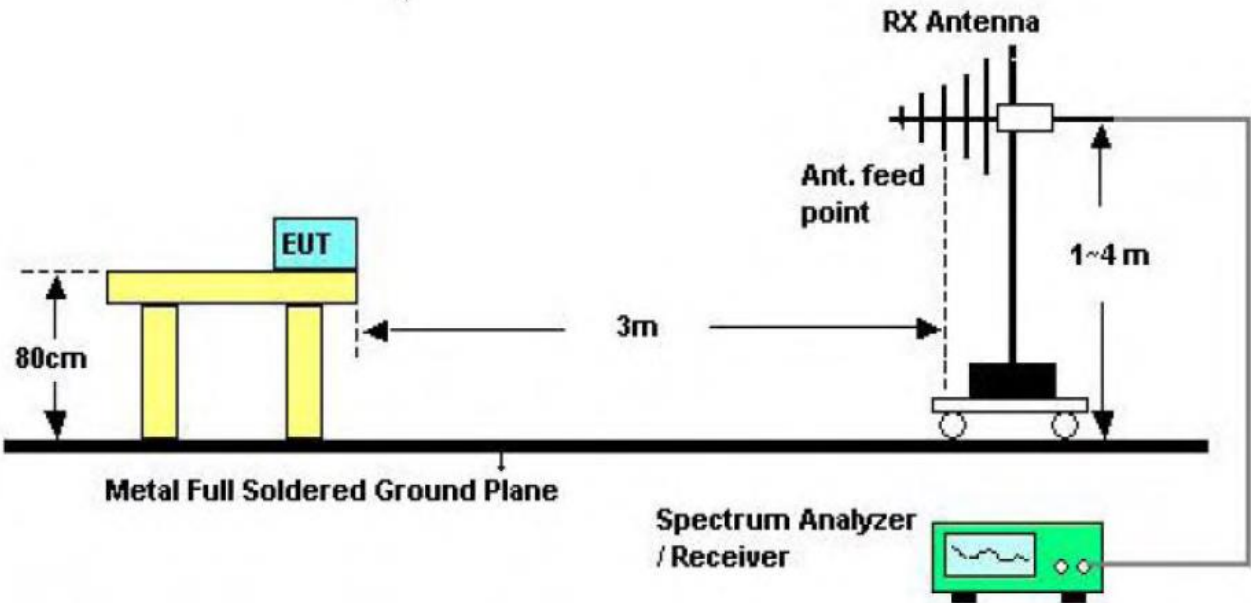

7.3 Test Procedure

- (1) The measuring distance of 3m shall be used for measurements at frequency up to 1GHz. The EUT was placed on a rotating 0.8m high above the ground, the table was rotated 360 degrees to determine the position of the highest radiation.
- (2) Measurements at frequency above 1GHz. The EUT was placed on a rotating 1.5m high above the ground. RF absorbers covered the ground plane with a minimum area of 3.0m by 3.0m between the EUT and measurement receiver antenna. The RF absorber shall not exceed 30cm in high above the conducting floor. The table was rotated 360 degrees to determine the position of the highest radiation.
- (3) The Test antenna shall vary between 1m and 4m, Both Horizontal and Vertical antenna are set to make measurement.
- (4) The initial step in collecting conducted emission data is a spectrum analyzer peak detector mode pre-scanning the measurement frequency range. Significant peaks are then marked and then Quasi Peak detector mode re-measured.
- (5) If the Peak Mode measured value compliance with and lower than Quasi Peak Mode Limit Bellow 1 GHz, the EUT shall be deemed to meet QP Limits and then no additional QP Mode measurement performed. But the Peak Value and average value both need to comply with applicable limit above 1 GHz.
- (6) Testing frequency range below 1GHz the measuring instrument use VBW=120 kHz with Quasi-peak detection.
- (7) Testing frequency range above 1GHz the measuring instrument use RBW=1 MHz and VBW=3 MHz with Peak Detector for Peak Values, and use RBW=1 MHz and VBW=10 Hz with Peak Detector for Average Values.
- (8) For the actual test configuration, please see the test setup photo.

7.4 EUT Operating Condition

The Equipment Under Test was set to Continual Transmitting in maximum power.

7.5 Deviation From Test Standard

No deviation

7.6 Test Data

Please refer to the Attachment B.

8. Bandwidth

8.1 Test Standard and Limit

8.1.1 Test Standard

FCC Part 15.239

8.1.2 Test Limit

Emissions from the intentional radiator shall be confined within a band 200 kHz wide centered on the operating frequency. The 200 kHz band shall lie wholly within the frequency range of 88-108 MHz.

8.2 Test Setup

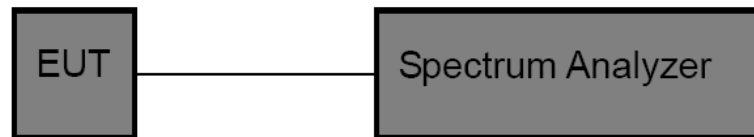

8.3 Test Procedure

- (1) Set Spectrum Analyzer Center Frequency= Fundamental Frequency, RBW=3 kHz, VBW= 10 kHz, Span= 300 kHz.
- (2) Measured the spectrum width with power higher than 20 dB below carrier.

8.4 EUT Operating Condition

The Equipment Under Test was Programmed to be in continuously transmitting mode.

8.5 Deviation From Test Standard

No deviation

8.6 Test Data

Please refer to the Attachment C.

9. Antenna Requirement

9.1 Standard Requirement

9.1.1 Standard

FCC Part 15.203

9.1.2 Requirement

An intentional radiator shall be designed to ensure that no antenna other than that furnished by the responsible party shall be used with the device. The use of a permanently attached antenna or of an antenna that uses a unique coupling to the intentional radiator shall be considered sufficient to comply with the provisions of this Section. The manufacturer may design the unit so that a broken antenna can be replaced by the user, but the use of a standard antenna jack or electrical connector is prohibited.

9.2 Antenna Connected Construction

The gains of the antenna used for transmitting is 1.5 dBi, and the antenna connector is de-signed with permanent attachment and no consideration of replacement. Please see the EUT photo for details.

The EUT antenna is a Internal Antenna. It complies with the standard requirement.

Antenna Type
<input checked="" type="checkbox"/> Permanent attached antenna
<input type="checkbox"/> Unique connector antenna
<input type="checkbox"/> Professional installation antenna

Attachment A-- Radiated Emission Test Data

9 KHz~30 MHz

From 9 KHz to 30 MHz: Conclusion: PASS

Note: The amplitude of spurious emissions which are attenuated by more than 20dB
Below the permissible value has no need to be reported.

30MHz~1GHz

Temperature:	25 °C	Relative Humidity:	55%
Test Voltage:	DC 12V		
Ant. Pol.	Horizontal		
Test Mode:	88.1MHz		
Remark:			

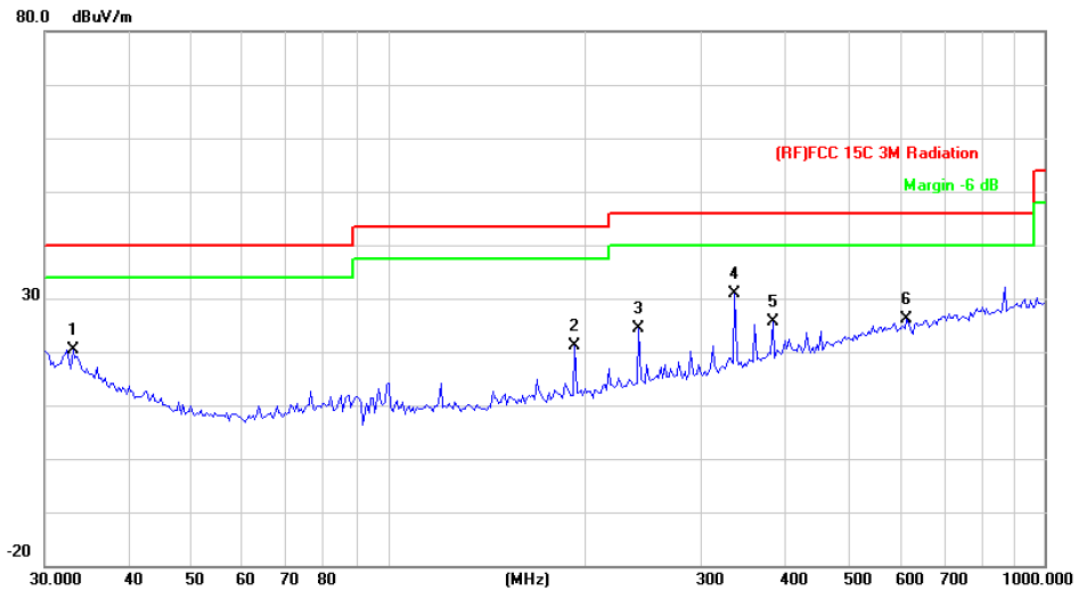

No.	Mk.	Freq. MHz	Reading Level dBuV	Correct Factor dB/m	Measure- ment dBuV/m	Limit dBuV/m	Over dB	Detector
1		33.0950	35.60	-15.26	20.34	40.00	-19.66	QP
2		192.4186	40.99	-19.83	21.16	43.50	-22.34	QP
3		240.8304	42.06	-17.72	24.34	46.00	-21.66	QP
4	*	337.2155	45.98	-15.05	30.93	46.00	-15.07	QP
5		385.2805	38.70	-12.98	25.72	46.00	-20.28	QP
6		616.3718	34.25	-8.19	26.06	46.00	-19.94	QP

Emission Level= Read Level+ Correct Factor

Temperature:	25 °C	Relative Humidity:	55%
Test Voltage:	DC 12V		
Ant. Pol.	Vertical		
Test Mode:	88.1MHz		
Remark:			

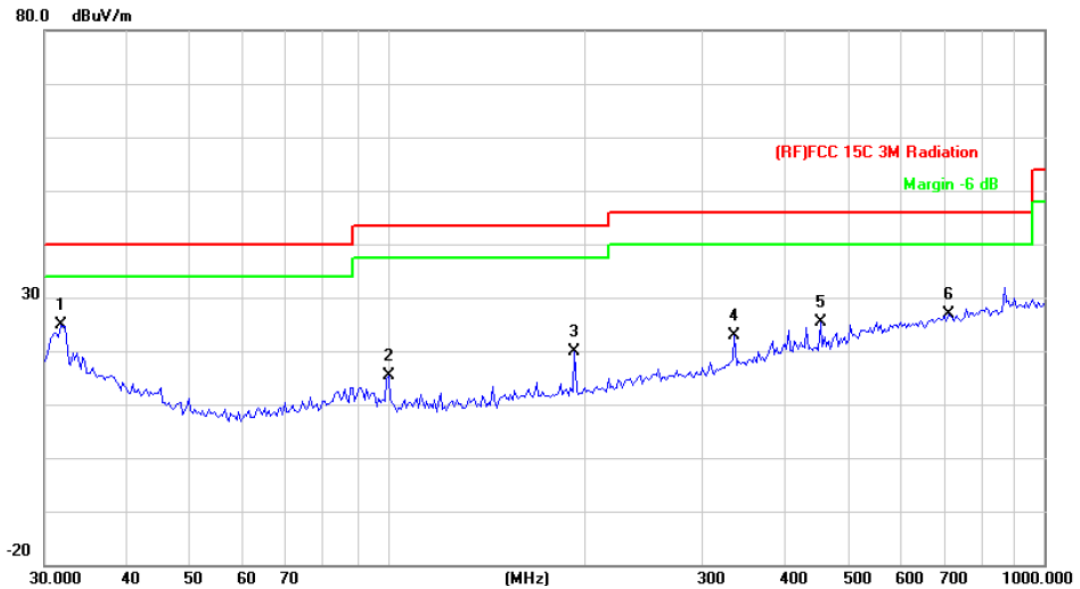

No.	Mk.	Freq. MHz	Reading Level dBuV	Correct Factor dB/m	Measure- ment dBuV/m	Limit dBuV/m	Over dB	Detector
1	*	31.7313	39.01	-14.25	24.76	40.00	-15.24	QP
2		100.2286	37.37	-21.95	15.42	43.50	-28.08	QP
3		192.4186	39.74	-19.83	19.91	43.50	-23.59	QP
4		337.2155	37.94	-15.05	22.89	46.00	-23.11	QP
5		455.9058	37.27	-11.77	25.50	46.00	-20.50	QP
6		714.1734	33.62	-6.72	26.90	46.00	-19.10	QP

Emission Level= Read Level+ Correct Factor

Temperature:	25 °C	Relative Humidity:	55%
Test Voltage:	DC 12V		
Ant. Pol.	Horizontal		
Test Mode:	98.1MHz		
Remark:			

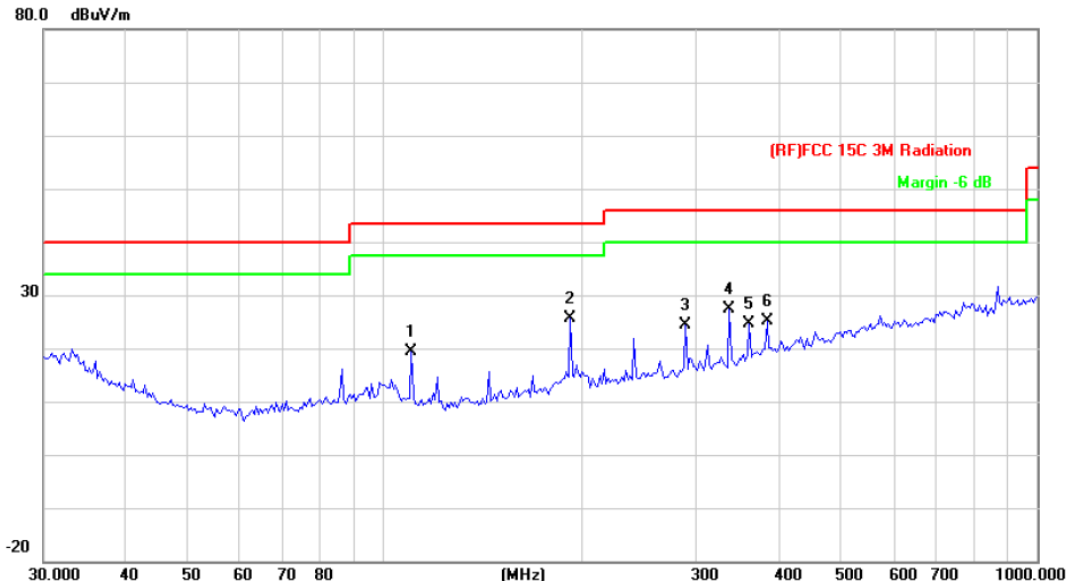

No.	Mk.	Freq. MHz	Reading Level dBuV	Correct Factor dB/m	Measure- ment dBuV/m	Limit dBuV/m	Over dB	Detector
1		109.7960	41.70	-22.29	19.41	43.50	-24.09	QP
2	*	192.4186	45.43	-19.83	25.60	43.50	-17.90	QP
3		289.0021	40.92	-16.50	24.42	46.00	-21.58	QP
4		337.2155	42.37	-15.05	27.32	46.00	-18.68	QP
5		361.7139	38.79	-14.09	24.70	46.00	-21.30	QP
6		385.2805	38.02	-12.98	25.04	46.00	-20.96	QP

Emission Level= Read Level+ Correct Factor

Temperature:	25 °C	Relative Humidity:	55%
Test Voltage:	DC 12V		
Ant. Pol.	Vertical		
Test Mode:	98.1MHz		
Remark:			

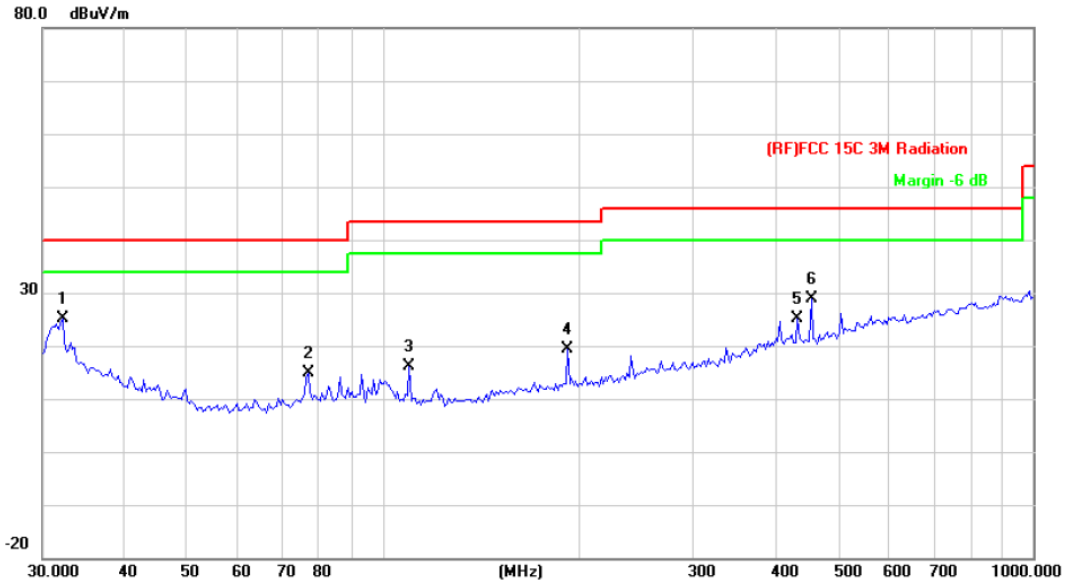

No.	Mk.	Freq. MHz	Reading Level dBuV	Correct Factor dB/m	Measure- ment dBuV/m	Limit dBuV/m	Over dB	Detector
1	*	32.1795	39.62	-14.57	25.05	40.00	-14.95	QP
2		76.7808	37.59	-22.76	14.83	40.00	-25.17	QP
3		109.7960	38.50	-22.29	16.21	43.50	-27.29	QP
4		192.4186	39.27	-19.83	19.44	43.50	-24.06	QP
5		434.0651	37.17	-12.04	25.13	46.00	-20.87	QP
6		455.9058	40.56	-11.77	28.79	46.00	-17.21	QP

Emission Level= Read Level+ Correct Factor

Temperature:	25 °C	Relative Humidity:	55%
Test Voltage:	DC 12V		
Ant. Pol.	Horizontal		
Test Mode:	107.9MHz		
Remark:			

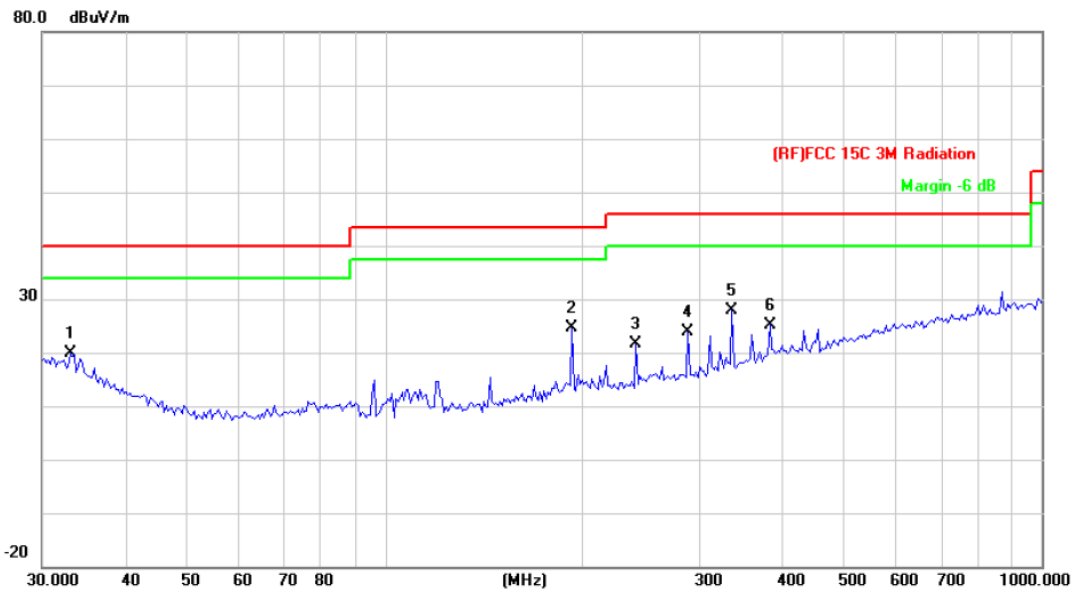

No.	Mk.	Freq. MHz	Reading Level dBuV	Correct Factor dB/m	Measure- ment dBuV/m	Limit dBuV/m	Over dB	Detector
1		33.0950	35.09	-15.26	19.83	40.00	-20.17	QP
2		192.4186	44.54	-19.83	24.71	43.50	-18.79	QP
3		240.8304	39.42	-17.72	21.70	46.00	-24.30	QP
4		289.0021	40.40	-16.50	23.90	46.00	-22.10	QP
5	*	337.2155	42.94	-15.05	27.89	46.00	-18.11	QP
6		385.2805	38.23	-12.98	25.25	46.00	-20.75	QP

Emission Level= Read Level+ Correct Factor

Temperature:	25 °C	Relative Humidity:	55%
Test Voltage:	DC 12V		
Ant. Pol.	Vertical		
Test Mode:	107.9MHz		
Remark:			

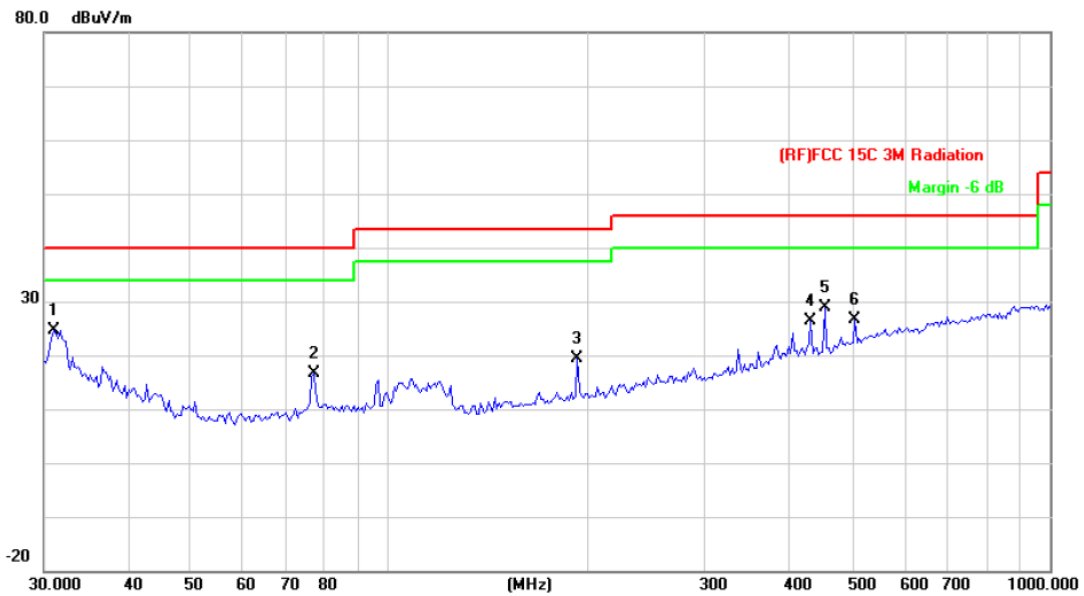

No.	Mk.	Freq. MHz	Reading Level dBuV	Correct Factor dB/m	Measurement dBuV/m	Limit dBuV/m	Over dB	Detector
1	*	31.0706	38.38	-13.74	24.64	40.00	-15.36	QP
2		76.7808	39.40	-22.76	16.64	40.00	-23.36	QP
3		192.4186	39.26	-19.83	19.43	43.50	-24.07	QP
4		434.0651	38.32	-12.04	26.28	46.00	-19.72	QP
5		455.9058	40.56	-11.77	28.79	46.00	-17.21	QP
6		506.4791	36.97	-10.28	26.69	46.00	-19.31	QP

Emission Level= Read Level+ Correct Factor

Attachment B--Fundamental and Band Edge Test Data

Temperature:	25 °C	Relative Humidity:	55%
Test Voltage:	DC 12V		
Ant. Pol.	Horizontal		
Test Mode:	88.1MHz		
Remark:			

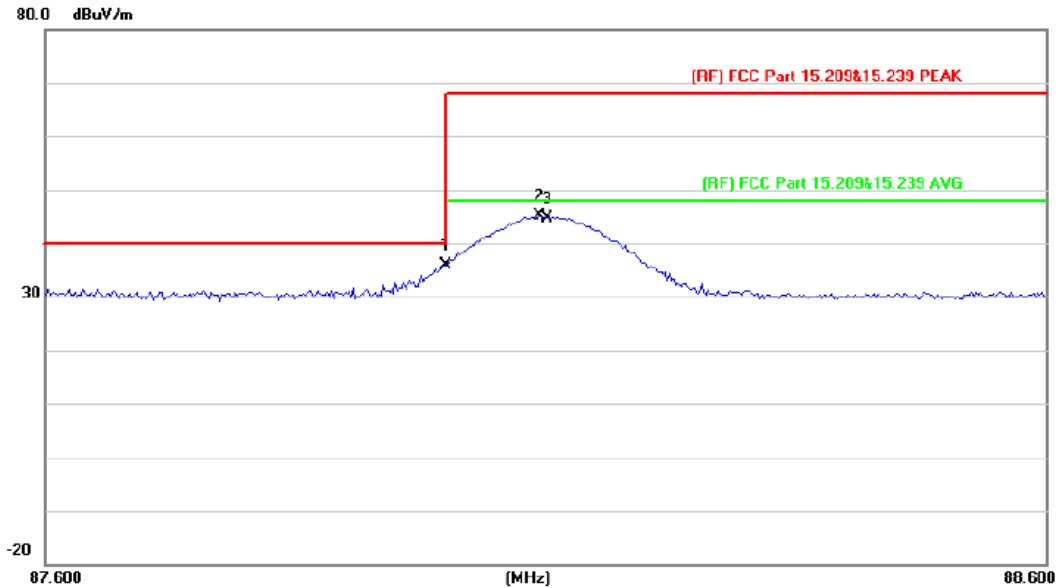

No.	Mk.	Freq.	Reading Level	Correct Factor	Measurement	Limit	Over	Detector
		MHz	dBuV	dB/m	dBuV/m	dBuV/m	dB	
1		88.0000	66.59	-30.68	35.91	40.00	-4.09	peak
2		88.0940	75.85	-30.68	45.17	67.96	-22.79	peak
3	*	88.1000	75.43	-30.68	44.75	47.96	-3.21	AVG

Emission Level= Read Level+ Correct Factor

Temperature:	25 °C	Relative Humidity:	55%
Test Voltage:	DC 12V		
Ant. Pol.	Vertical		
Test Mode:	88.1MHz		
Remark:			

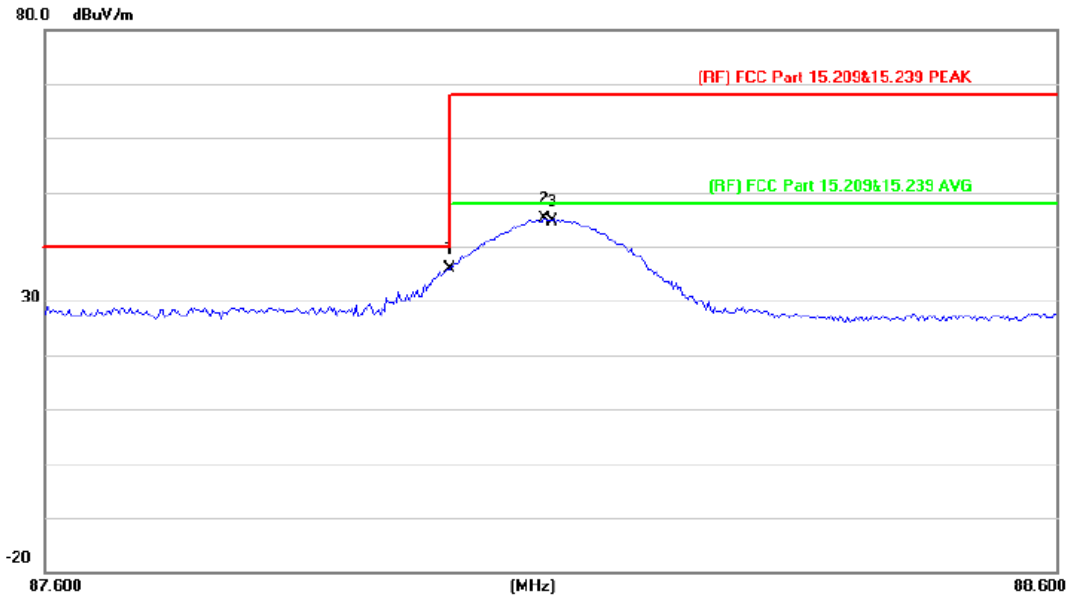

No.	Mk.	Freq.	Reading Level	Correct Factor	Measurement	Limit	Over	Detector
		MHz	dBuV	dB/m	dBuV/m	dBuV/m	dB	
1		88.0000	66.58	-30.68	35.90	40.00	-4.10	peak
2		88.0940	75.82	-30.68	45.14	67.96	-22.82	peak
3	*	88.1000	75.39	-30.68	44.71	47.96	-3.25	AVG

Emission Level= Read Level+ Correct Factor

Temperature:	25 °C	Relative Humidity:	55%
Test Voltage:	DC 12V		
Ant. Pol.	Horizontal		
Test Mode:	98.1MHz		
Remark:			

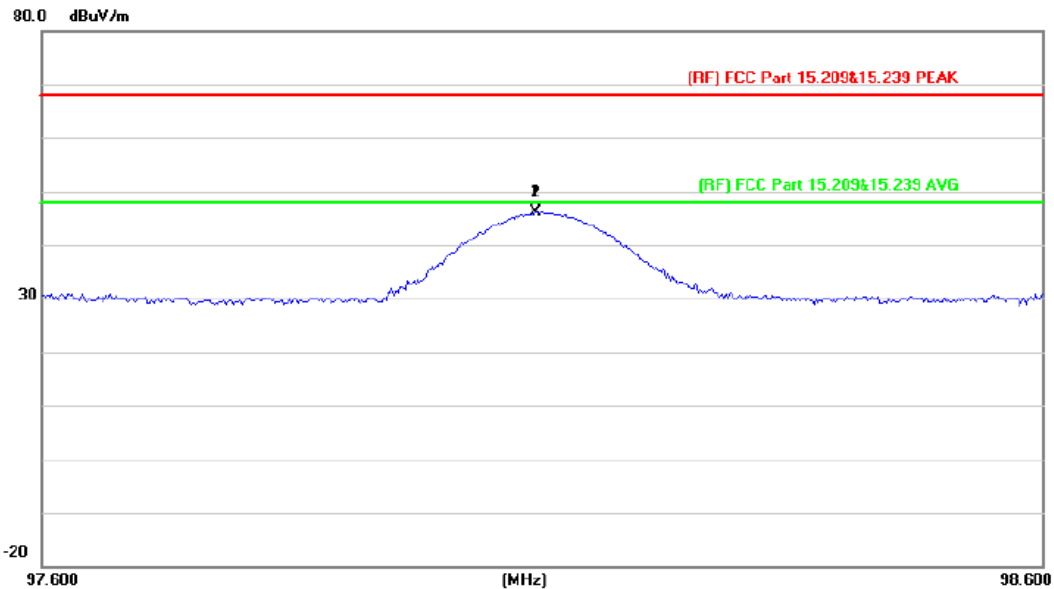

No.	Mk.	Freq.	Reading Level	Correct Factor	Measurement	Limit	Over	Detector
		MHz	dBuV	dB/m	dBuV/m	dBuV/m	dB	
1		98.0940	76.70	-30.56	46.14	67.96	-21.82	peak
2	*	98.0940	76.71	-30.56	46.15	47.96	-1.81	AVG

Emission Level= Read Level+ Correct Factor

Temperature:	25 °C	Relative Humidity:	55%
Test Voltage:	DC 12V		
Ant. Pol.	Vertical		
Test Mode:	98.1MHz		
Remark:			

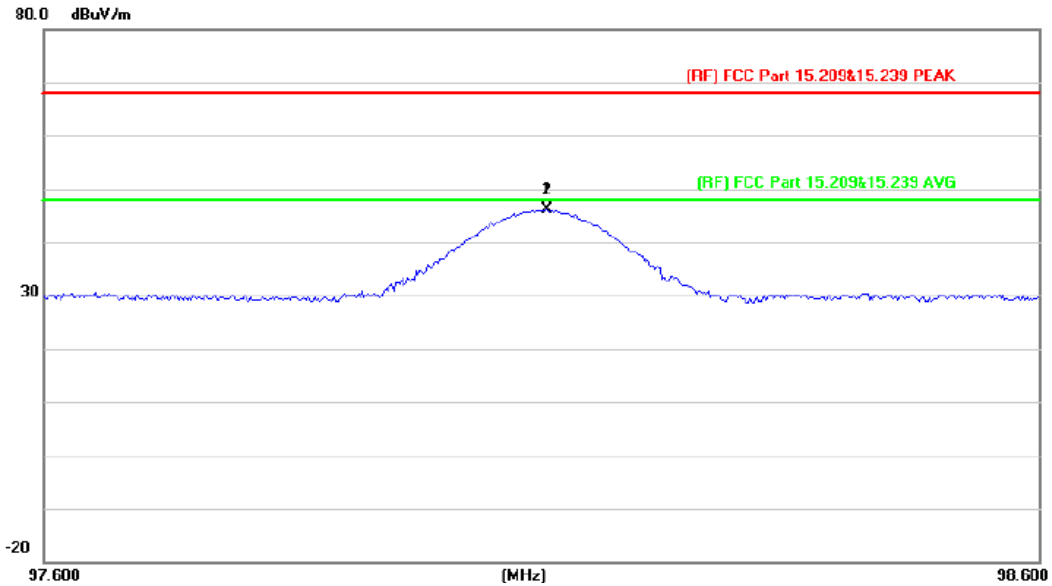

No.	Mk.	Freq. MHz	Reading Level dBuV	Correct Factor dB/m	Measure- ment dBuV/m	Limit dBuV/m	Over dB	Detector
1		98.1059	76.66	-30.56	46.10	67.96	-21.86	peak
2	*	98.1059	76.66	-30.56	46.10	47.96	-1.86	AVG

Emission Level= Read Level+ Correct Factor

Temperature:	25 °C	Relative Humidity:	55%
Test Voltage:	DC 12V		
Ant. Pol.	Horizontal		
Test Mode:	107.9MHz		
Remark:			

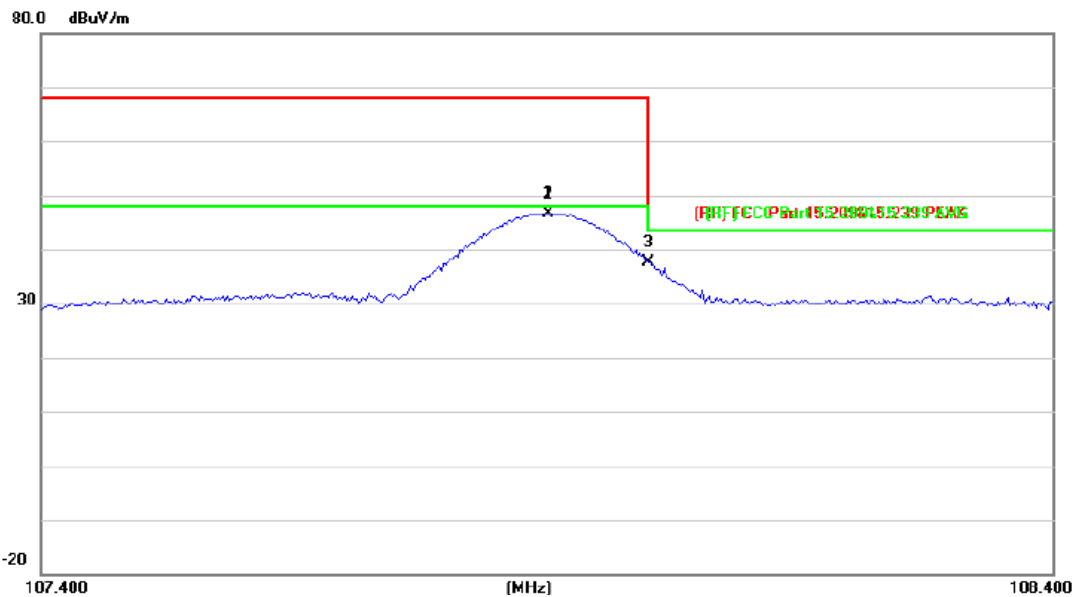

No.	Mk.	Freq. MHz	Reading Level dBuV	Correct Factor dB/m	Measure- ment dBuV/m	Limit dBuV/m	Over dB	Detector
1		107.9020	77.16	-30.51	46.65	67.96	-21.31	peak
2	*	107.9020	77.15	-30.51	46.64	47.96	-1.32	AVG
3		108.0000	68.04	-30.51	37.53	43.50	-5.97	peak

Emission Level= Read Level+ Correct Factor

Temperature:	25 °C	Relative Humidity:	55%
Test Voltage:	DC 12V		
Ant. Pol.	Vertical		
Test Mode:	107.9MHz		
Remark:			

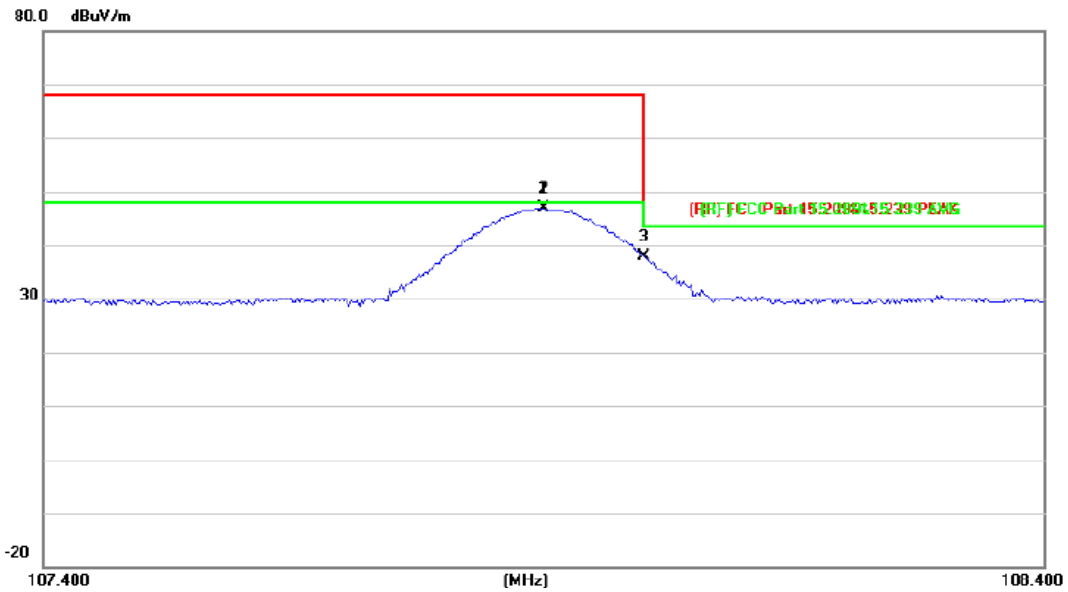

No.	Mk.	Freq. MHz	Reading Level dBuV	Correct Factor dB/m	Measure- ment dBuV/m	Limit dBuV/m	Over dB	Detector
1		107.9000	77.45	-30.51	46.94	67.96	-21.02	peak
2	*	107.9000	77.45	-30.51	46.94	47.96	-1.02	AVG
3		108.0000	68.40	-30.51	37.89	43.50	-5.61	peak

Emission Level= Read Level+ Correct Factor

Attachment C-- Bandwidth Data

Frequency (MHz)	20 dB Bandwidth (kHz)	Limits (kHz)	Result
88.1	149.1	200	PASS
98.1	148.1		PASS
107.9	148.7		PASS

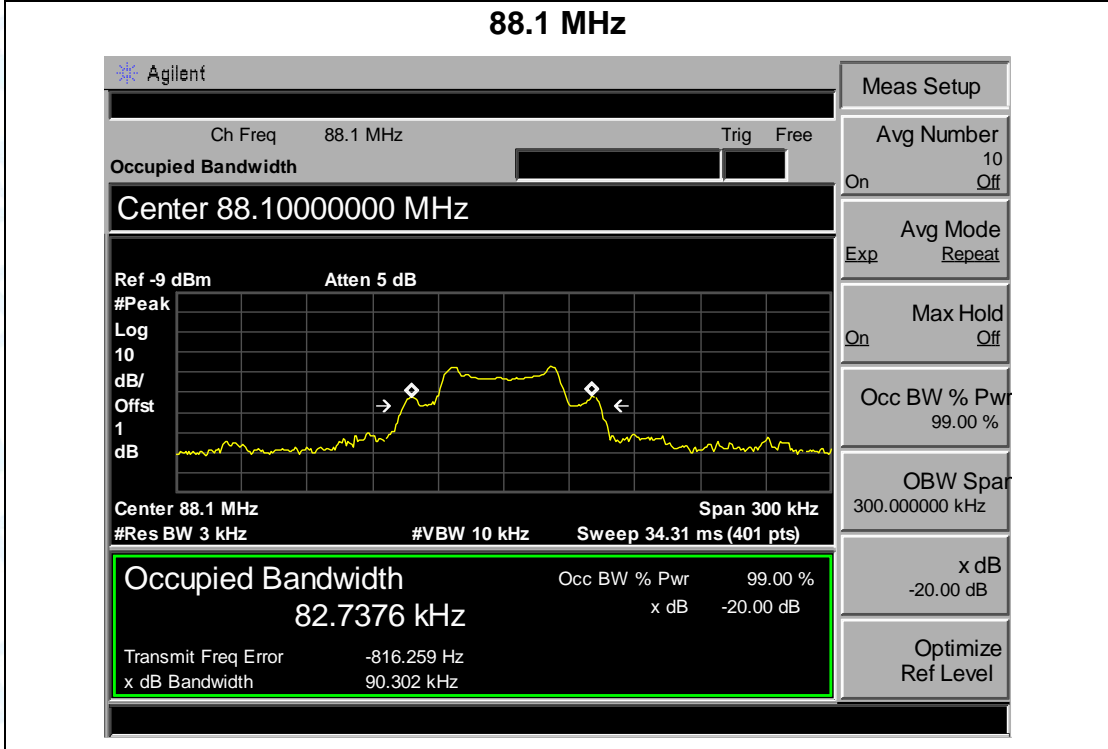

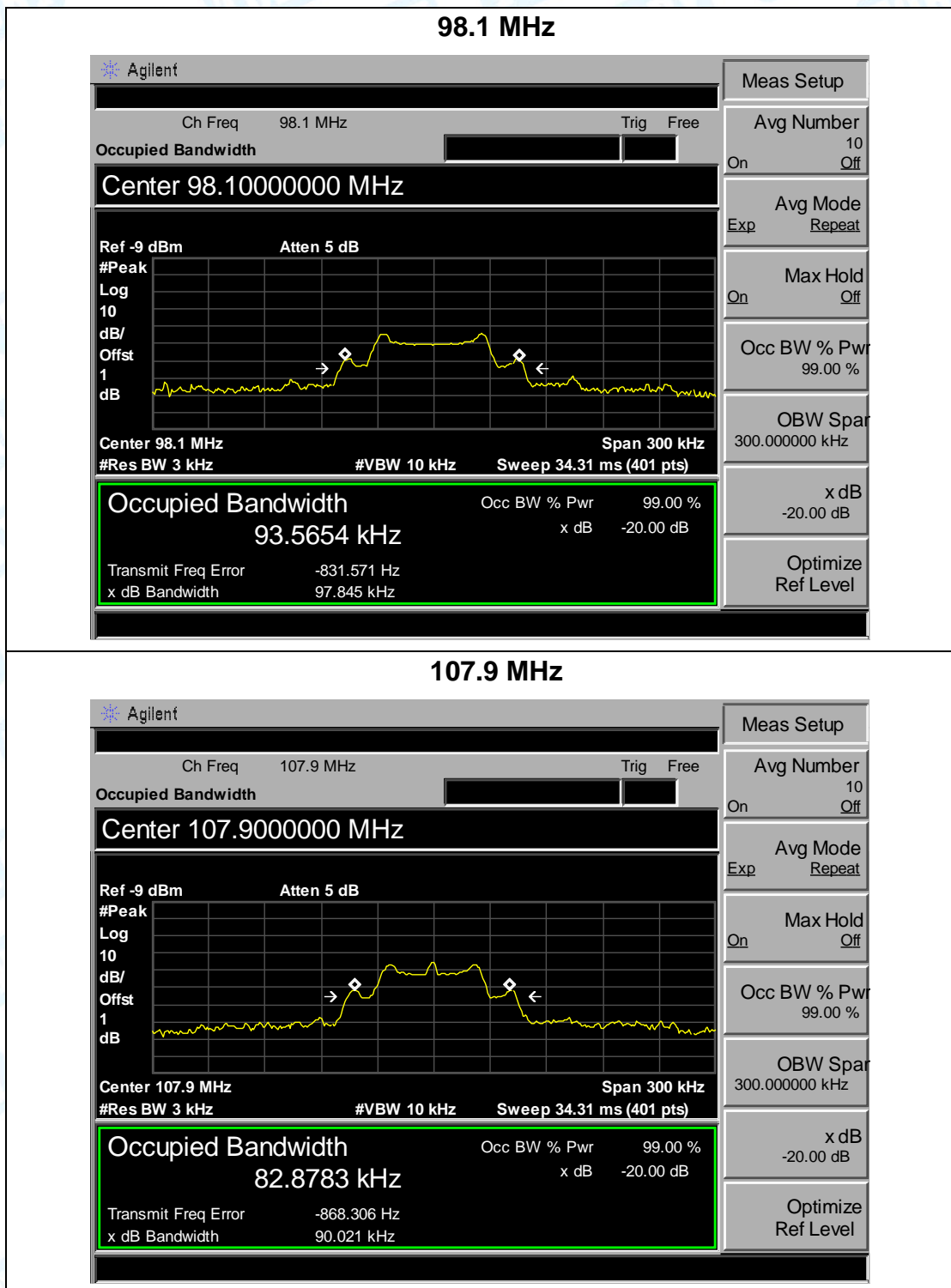

-----END OF REPORT-----