

# EUCHNER

## Operating Instructions

## Contents

<b>1.</b>	<b>About this document</b> .....	<b>3</b>
1.1.	Scope.....	3
1.1.1.	Notes on older product versions .....	3
1.2.	Target group .....	3
1.3.	Key to symbols.....	3
1.4.	Supplementary documents .....	3
<b>2.</b>	<b>Correct use</b> .....	<b>4</b>
<b>3.</b>	<b>Description of the safety function</b> .....	<b>5</b>
<b>4.</b>	<b>Exclusion of liability and warranty</b> .....	<b>5</b>
<b>5.</b>	<b>General safety precautions</b> .....	<b>5</b>
<b>6.</b>	<b>Function</b> .....	<b>6</b>
<b>7.</b>	<b>Mounting</b> .....	<b>7</b>
<b>8.</b>	<b>Protection against environmental effects</b> .....	<b>7</b>
<b>9.</b>	<b>Electrical connection</b> .....	<b>7</b>
<b>10.</b>	<b>Setup</b> .....	<b>8</b>
10.1.	Configuring the key adapter and teaching-in the key for the first time .....	8
10.2.	Teaching-in a new key .....	9
<b>11.</b>	<b>Data blocks</b> .....	<b>9</b>
<b>12.</b>	<b>Status and error messages</b> .....	<b>10</b>
12.1.	LED indicator.....	10
12.2.	Status messages.....	11
12.3.	Error messages.....	12
12.4.	Acknowledging error messages .....	13
<b>13.</b>	<b>Diagnostics, troubleshooting and aids</b> .....	<b>13</b>
<b>14.</b>	<b>Technical data</b> .....	<b>14</b>
14.1.	Technical data for submodule MSM-1-R-CKS2-FLX-... .....	14
14.2.	Radio frequency approvals.....	15
14.3.	Technical data for key A-FLX-K-... .....	16
14.3.1.	Dimension drawing for key.....	16
<b>15.</b>	<b>Service</b> .....	<b>17</b>
<b>16.</b>	<b>Inspection and service</b> .....	<b>17</b>

## 1. About this document

### 1.1. Scope

This document is valid for all submodules MSM-1-R-CKS2-FLX...

These operating instructions, the document *Safety information*, the operating instructions for the modules connected and any supplementary data sheets form the complete user information for your system.

Series	Module connection type	Product version
MSM-1-R-CKS2-FLX...	...MLI...	V1.0.0





#### 1.1.1. Notes on older product versions

Products with lower product versions or without a version number are not described by these operating instructions. Please contact our support team in this case.

### 1.2. Target group





Design engineers and installation planners for safety systems on machines, as well as setup and servicing staff possessing special expertise in handling safety components as well as expertise in the installation, setup, programming and diagnostics of programmable logic controllers (PLCs) and bus systems.

### 1.3. Key to symbols

Symbol/depiction	Meaning
	Printed document
	Document is available for download at <a href="http://www.euchner.com">www.euchner.com</a>
 <b>DANGER</b> <b>WARNING</b> <b>CAUTION</b>	Safety precautions <b>Danger</b> of death or severe injuries <b>Warning</b> about possible injuries <b>Caution</b> Slight injuries possible
 <b>NOTICE</b> <b>Important!</b>	<b>Notice</b> about possible device damage <b>Important</b> information
<b>Tip</b>	Tip/useful information

### 1.4. Supplementary documents

The overall documentation for this device consists of the following documents:

Document title (document number)	Contents	
Safety information (2525460)	Basic safety information	
Operating instructions (MAN20001527)	(this document)	
Operating instructions for the connected modules and their submodules	Device-specific information for the related module and the submodules installed	
Any supplementary data sheets	Item-specific information about deviations or additions	



#### Important!

Always read all documents to gain a complete overview of safe installation, setup and use of the device. The documents can be downloaded from [www.euchner.com](http://www.euchner.com). For this purpose enter the doc. no. or the order number for the device in the search box.

## 2. Correct use

The submodule MSM-1-R-CKS2-FLX-... is installed in suitable MGB2 Modular system components and used for safe reading and safe evaluation of CKS2 keys. The keys have a high coding level according to EN ISO 14119. Only the keys listed in *Table 1: System components* may be used.

Among other applications, they can be used as part of a trapped key system according to ISO/TS 19837.

Table 1: System components

Key adapter	1 key per packaging unit	Several keys per packaging unit, with identical key code and different key identification
MSM-1-R-CKS2-FLX-...	A-FLX-K-0A-RD-168921	A-FLX-K-0B-RD-...

Before the device is used in combination with a safety function, a risk assessment must be performed on the machine, e.g. in accordance with the following standards:

- › EN ISO 13849-1
- › EN ISO 12100
- › EN IEC 62061
- › EN ISO 14119

Correct use includes observing the relevant requirements for installation and operation, particularly based on the following standards:

- › EN 60204-1
- › Possibly others (depending on the connected switches)

The submodule MSM-1-R-CKS2-FLX-... may be combined only with suitable MLI modules (see *Table 2: Combination options for modules with MLI technology*).

On the impermissible use of other keys or the modification of system components, EUCHNER provides no warranty for safe function.

The user is responsible for the safe overall function, especially for the safe integration into an overall system.



**Important!**

- › The user is responsible for the proper integration of the device into a safe overall system. For this purpose, the overall system must be validated, e.g. in accordance with EN ISO 13849-2.
- › Correct use requires observing the permissible operating parameters (see chapter 14. *Technical data on page 14*).
- › If a data sheet is included with the product, the information on the data sheet applies.

Table 2: Combination options for modules with MLI technology

Submodules	Bus module MBM-...-MLI from V1.00.0	
	Base units	Expansion module MCM-...-MLI from V1.2.0
MSM-1-R-CKS2-FLX-...	●	●
Key to symbols	●	Combination possible

### 3. Description of the safety function



In combination with the base unit, the submodule MSM-1-R-CKS2-FLX-... has the function *safe detection and checking of the associated key code and forwarding to the bus module MBM*. The safety outputs are switched on if the key is valid. Observe the description of the safety functions in the operating instructions for your bus module MBM and in any data sheet for your submodule MSM.

### 4. Exclusion of liability and warranty

In case of failure to comply with the conditions for correct use stated above, or if the safety regulations are not followed, or if any servicing is not performed as required, liability will be excluded and the warranty void.

### 5. General safety precautions

Additionally observe the safety precautions in the operating instructions for your bus module MBM.

	<p><b>DANGER</b></p> <p>Danger to life due to selecting the wrong key or tampering.</p> <ul style="list-style-type: none"> <li>› When selecting the key version used, make sure that all measures for risk assessment for the intended application are performed.</li> <li>› Unused keys must be rendered unusable or protected against unauthorized access to prevent bypassing the safety function.</li> <li>› If master keys or replacement keys are used, the operating organization must take suitable organizational measures and use a corresponding risk assessment to prevent the system's safety function from being bypassed. For this purpose, observe the information in ISO/TS 19837.</li> </ul>
	<p><b>WARNING</b></p> <p>Danger to life due to improper installation or due to bypassing (tampering). Any contained safety components fulfill a personnel protection function.</p> <ul style="list-style-type: none"> <li>› Contained safety components must not be bypassed, turned away, removed or otherwise rendered ineffective. On this topic pay attention in particular to the measures for reducing the possibility of bypassing according to EN ISO 14119:2013, section 7.</li> <li>› Mounting, electrical connection and setup only by authorized personnel possessing the following knowledge: <ul style="list-style-type: none"> <li>- specialist knowledge in handling safety components</li> <li>- knowledge about the applicable EMC regulations</li> <li>- knowledge about the applicable regulations on operational safety and accident prevention</li> </ul> </li> </ul>
	<p><b>Important!</b></p> <p>Prior to use, read the operating instructions and keep these in a safe place. Ensure the operating instructions are always available during mounting, setup and servicing. For this reason you should archive a printed copy of the operating instructions. You can download the operating instructions from <a href="http://www.euchner.com">www.euchner.com</a>.</p>

## 6. Function

### Submodule MSM-1-R-CKS2-FLX-...

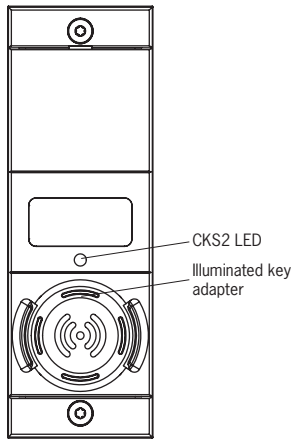

### Key A-FLX-K-0A-RD-168921

1 key per packaging unit

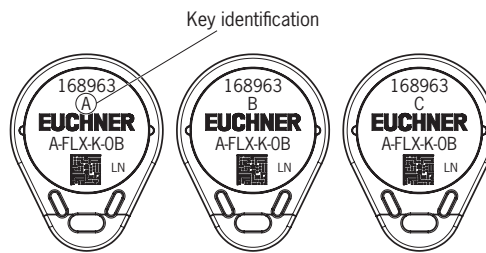

### Key A-FLX-K-0B-RD-...

Several keys per packaging unit, with identical key code and different key identification

The submodule MSM-1-R-CKS2-FLX-... has a key adapter with integrated evaluation electronics. The submodule forms a safe system together with a corresponding key and forwarding of the evaluated data to the bus module MBM. The key determines the function. You will find further information in chapter 10.1. *Configuring the key adapter and teaching-in the key for the first time on page 8.*

A safe bit is set when there is a valid key in the key adapter. The safe bit is cleared when the key is removed.

A key is valid if its key code was allocated to the key adapter in a teach-in operation, see chapter 10. *Setup on page 8.* Keys of the version A-FLX-K-0A-RD-168921 are unambiguously allocated to the key adapter in a teach-in operation. With keys of the version A-FLX-K-0B-RD-..., the taught-in key and all other keys from the same packaging unit are valid after the teach-in operation because they have the same key code.

Each key is supplied with a unique electronic code. The high coding level ensures a high level of protection against tampering.

The key's code cannot be reprogrammed.

In case of a fault in the key adapter, the safe bit is cleared and the LED signals a fault (see chapter 12.3. *Error messages on page 12.*)

The key adapter illumination can be externally controlled via the control system.

## 7. Mounting



### Important!

- › Mounting must be performed only by authorized personnel.
- › The submodule MSM-1-R-CKS2-FLX-... can be used only in base units with MLI technology (see *Table 2: Combination options for modules with MLI technology on page 4*).
- › Submodule mounting is described in the operating instructions for the respective base unit. Observe the relevant information.

## 8. Protection against environmental effects

A lasting and correct safety function requires that the system must be protected against foreign bodies such as swarf, sand, blasting shot, etc., which can become lodged in the housing.

Pay attention to the following measures:

- › Seal unused connections using the covers provided.
- › Make sure the housing covers are correctly sealed and the cover screws are tightened to the necessary tightening torque.
- › Cover the device during painting work.

## 9. Electrical connection



### Important!

- › For setup and further teach-in operations, a function must be prepared in the software of your control system (PLC) that is capable of processing the bit `SM_O_Jx`.
- › Pay attention to the instructions on electrical connection in the operating instructions for your bus module MBM.
- › Avoid touching the contacts on the underside of the submodule. Risk of ESD damage and contact problems due to soiling.

Refer to the supplementary data sheet for the exact connection options.



### Important!

- › If the device does not appear to function when operating voltage is applied (e.g. LED does not illuminate or flash), it must be returned unopened to the manufacturer.

## 10. Setup



### DANGER

Danger to life due to tampering.

- › Unused keys must be rendered unusable or protected against unauthorized access to prevent bypassing the safety function.
- › If master keys or replacement keys are used, the operating organization must take suitable organizational measures and use a corresponding risk assessment to prevent the system's safety function from being bypassed. For this purpose, observe the information in ISO/TS 19837.

For information on setting up the submodule, refer to the operating instructions for your bus module MBM.

### 10.1. Configuring the key adapter and teaching-in the key for the first time

The key adapter must be configured and the key must be allocated to the key adapter before the key system forms a functional unit. The device function is defined during configuration using the key. Configuration and the teach-in operation occur simultaneously in the delivery state.

Key	Function
A-FLX-K-OA-RD-168921	1 key per packaging unit
A-FLX-K-OB-RD-...	Several keys per packaging unit, with identical key code and different key identification



### WARNING

Danger to life due to improper use.

- › During the initial configuration, ensure that all risk assessment measures for the selected function are performed.



### Important!

- › After configuration, the submodule can be used only with the key version with which it was configured. Reconfiguration is not possible.
- › If the key to be taught-in is in the key adapter for less than 30 s, the device will not be configured and the key will not be activated.
- › For keys of version A-FLX-K-OB-RD-...: Only one key per packaging unit has to be taught-in. All other keys from the same package can be used without an additional teach-in operation.

#### Prerequisite:

- › The device is in the delivery state.
- › The overall MGB2 Modular system is isolated from the operating voltage.

1. Make sure that no key is inserted.
2. Apply operating voltage to the overall MGB2 Modular system.
  - ➔ The LED flashes white quickly. The device is carrying out a self-test.
  - ➔ The LED flashes white slowly. The device is in teach-in standby.
3. Insert a key.
  - ➔ The teach-in operation begins. The LED alternately flashes white/violet slowly.
  - ➔ The teach-in operation ends after approx. 30 s. The LED alternately flashes green/blue quickly (approx. 3 Hz).
4. Switch off the operating voltage of the overall MGB2 Modular system for at least 3 s.
  - ➔ The code of the taught-in key is activated in the key adapter. The key is valid.
5. Switch on the operating voltage of the overall MGB2 Modular system.
  - ➔ The device operates normally.



## 10.2. Teaching-in a new key



### Important!

- › Only the key version with which the device was configured can be taught-in. Reconfiguration is not possible.
- › The teach-in operation may be performed only if the device functions flawlessly. The LED flashes green slowly.
- › The safe bit is cleared during a teach-in operation.
- › The key adapter disables the code of the previous key if teach-in is carried out for a new key. Teach-in is not possible again immediately for this device if a new teach-in operation is carried out. The disabled code is released again in the key adapter only after a third code has been taught-in.
- › The key adapter can be operated only with the last key taught-in.
- › The number of teach-in operations is unlimited.
- › If the key adapter recognizes the most recently taught-in key during teach-in standby, the teach-in operation will be continued and completed with positive acknowledgment. The LED alternately flashes green/blue quickly. Follow steps 5 and 6 to change to normal operation.
- › If the key to be taught-in is within the key adapter for less than 30 s, it will not be activated and the most recently taught-in key will remain saved.
- › For keys of version A-FLX-K-OB-RD-...: Only one key per packaging unit has to be taught-in. All other keys from the same package can be used without an additional teach-in operation.

### Prerequisite:

- › The overall MGB2 Modular system is isolated from the operating voltage.
1. Make sure that no key is inserted.
  2. Apply operating voltage to the overall MGB2 Modular system.
    - ➔ The LED flashes green slowly. The device is ready for operation.
  3. Within 3 minutes, set bit  $SM\_O\_Jx$  for the teach-in input on the control system for at least 5 s and no more than 30 s.
    - ➔ The device is in teach-in standby for up to 3 minutes. The LED illuminates white.
  4. Insert a non-taught-in key.
    - ➔ The teach-in operation begins. The LED alternately flashes white/violet slowly.
    - ➔ The teach-in operation ends after approx. 30 s. The LED alternately flashes green/blue quickly (approx. 3 Hz).
  5. Switch off the operating voltage of the overall MGB2 Modular system for at least 3 s.
    - ➔ The code of the taught-in key is activated in the key adapter. The key is valid.
  6. Switch on the operating voltage of the overall MGB2 Modular system.
    - ➔ The device operates normally.

## 11. Data blocks



### Important!

- › Refer to the supplementary data sheet for information about the communication data and the data blocks of your submodule.
- › You will find more information about the communication data and the data blocks in the operating instructions for your bus module.

## 12. Status and error messages

### 12.1. LED indicator

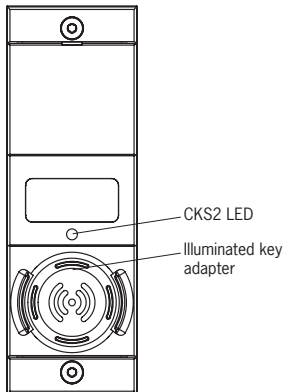

LED	Color
CKS2	RGB
Illuminated key adapter	red, green, yellow (externally controlled)







#### Important!











If you do not find the displayed device status in the following tables, this indicates an internal device fault. Contact the manufacturer.

Key to symbols			LED not illuminated
			LED illuminated
	quickly		LED flashes quickly (3 Hz)
	slowly		LED flashes slowly (0.6 Hz)
			LED flashes alternately
	X		Any state

## 12.2. Status messages

Operating mode	LED indicator	Bit SM_FI_S3	Bit SM_I_S3_E	Status
Normal operation	 green slowly	off	off	Device is ready for operation. No key inserted.
	 green	on	off	Key inserted.
Teach-in operation	 white	off	off	Device is in teach-in standby (see chapter 10.2. <i>Teaching-in a new key on page 9</i> ).
	 white/violet slowly		off	Teach-in operation
	 green/blue quickly		off	Positive acknowledgment after successful teach-in operation.
Error	depending on the error	off	on	Error message (see chapter 12.3. <i>Error messages on page 12</i> )

### 12.3. Error messages

LED indicator	Error	Troubleshooting	Acknowledging errors	
			Remove key for 2 s	Reset
<b>Teach-in errors</b>				
 white/red slowly	No key detected during teach-in standby.	Once bit $SM\_O\_Jx$ has been set for the teach-in input, the key must be inserted within 3 minutes.		●
	Key removed from the key adapter prior to the end of the teach-in operation.	Repeat teach-in operation.		●
	The bit $SM\_O\_Jx$ for the teach-in input was set for too long.	Set bit $SM\_O\_Jx$ for no longer than 30 s.		●
 blue quickly	Disabled key detected during the teach-in operation: The key was taught-in during the penultimate teach-in operation and is disabled for the current teach-in operation.	Repeat the teach-in operation with a new key (see chapter 10.2. <i>Teaching-in a new key on page 9</i> ).		●
 blue slowly	Invalid key detected: The key is not intended for the current device configuration.	<ul style="list-style-type: none"> <li>Perform the teach-in operation with a key intended for the current device configuration.</li> <li>If the device is to be reconfigured, observe chapter 10.1. <i>Configuring the key adapter and teaching-in the key for the first time on page 8</i>.</li> </ul>		●
 blue	Faulty or incompatible key detected: The key's data structure cannot be read. The key is faulty or is not suitable for the device.	Repeat teach-in operation with a new key.		●
<b>Transponder/read errors</b>				
 blue slowly	Invalid key detected during operation: The key is not intended for the current device configuration.	Use a valid key.	●	
 blue	Faulty or incompatible key detected during operation: The key's data structure cannot be read. The key is faulty or is not suitable for the device.		●	
 blue quickly	Disabled key detected during operation: The key is not the currently valid key.		●	
 white/blue slowly	Non-taught-in key detected during operation.	<ul style="list-style-type: none"> <li>Use the currently valid key.</li> <li>Teach-in the key.</li> </ul>	●	
<b>Environment errors</b>				
 orange/red slowly	Supply voltage too high	Decrease supply voltage.	●	
	Supply voltage too low	<ul style="list-style-type: none"> <li>Increase supply voltage.</li> <li>Check the system configuration.</li> </ul>	●	
 orange/red quickly	Device temperature too high.	<ul style="list-style-type: none"> <li>Observe the specified temperature range, see chapter 14. <i>Technical data on page 14</i></li> </ul>		●
	Device temperature too low.			
<b>Internal error</b>				
 red	<ul style="list-style-type: none"> <li>Internal device error</li> <li>Supply voltage extremely high or extremely low.</li> <li>Device temperature extremely high or extremely low.</li> </ul>	<ul style="list-style-type: none"> <li>Check supply voltage.</li> <li>Check device temperature.</li> <li>Restart the device. On repeated occurrence, contact the manufacturer.</li> </ul>		●

## 12.4. Acknowledging error messages

Depending on the error type, the error message can be acknowledged by briefly removing the key or by a reset.

After a reset, the overall system must be restarted. For this purpose, disconnect the bus module MBM from the power supply for a few seconds.



### **Important!**

Contact the manufacturer if the fault display is not reset after briefly disconnecting the power supply.

---

## 13. Diagnostics, troubleshooting and aids

For instructions on diagnostics and troubleshooting, refer to the operating instructions for your bus module MBM.

## 14. Technical data

### 14.1. Technical data for submodule MSM-1-R-CKS2-FLX-...



**NOTICE**

If a data sheet is included with the product, the information on the data sheet applies.

Parameter	Value
Housing material	Fiber glass reinforced plastic
Dimensions	See dimension drawing data sheet
Weight	0.1 kg net
Ambient temperature	-25 ... +55 °C
Degree of protection	IP65 <sup>1)</sup> (IP20)
Installation orientation	Any
Internal current consumption, max.	50 mA
Shock and vibration resistance	Acc. to EN 60947-5-3
EMC protection requirements	Acc. to EN 61000-4 and DIN EN 61326-3-1
Max. transponder risk times (turn-off times)	125 ms Refer to the operating instructions for your bus module for more information
<b>Reliability values acc. to EN ISO 13849-1</b>	
Category	4
Performance Level	PL e
MTTF <sub>D</sub>	>2,500 years
Mission time	20 years
PFH <sub>D</sub> <sup>2)</sup>	4.11 x 10 <sup>-9</sup> (2,500 years MTTF <sub>D</sub> )

1) IP65 only in the screwed tight state with the specified base units.

2) Applies only in combination with the base units MGB2 and the expansion modules MCM.

## 14.2. Radio frequency approvals

**FCC ID:** 2AJ58-20

**IC:** 22052-20

### FCC/IC-Requirements

This device complies with part 15 of the FCC Rules and with Industry Canada's licence-exempt RSSs. Operation is subject to the following two conditions:

- 1) This device may not cause harmful interference, and
- 2) this device must accept any interference received, including interference that may cause undesired operation.

Changes or modifications not expressly approved by the party responsible for compliance could void the user's authority to operate the equipment.

NOTE: This equipment has been tested and found to comply with the limits for a Class A digital device, pursuant to part 15 of the FCC Rules. These limits are designed to provide reasonable protection against harmful interference when the equipment is operated in a commercial environment. This equipment generates, uses, and can radiate radio frequency energy and, if not installed and used in accordance with the instruction manual, may cause harmful interference to radio communications.

Operation of this equipment in a residential area is likely to cause harmful interference in which case the user will be required to correct the interference at his own expense.

Le présent appareil est conforme aux CNR d'Industrie Canada applicables aux appareils radio exempts de licence. L'exploitation est autorisée aux deux conditions suivantes :

- (1) l'appareil ne doit pas produire de brouillage, et
- (2) l'utilisateur de l'appareil doit accepter tout brouillage radioélectrique subi, même si le brouillage est susceptible d'en compromettre le fonctionnement.

### Unique Identifier:

MSM-1-R-CKS2 Series  
MSM-1-R-CKS2BP Series  
MSM-1-R-CKS2BR Series  
MSM-1-K-CKS2 Series  
MSM-1-K-CKS2BP Series  
MSM-1-K-CKS2BR Series

### U.S. Contact Information

**EUCHNER USA Inc.**  
1860 Jarvis Avenue  
Elk Grove Village, Illinois 60007  
+1 315 701-0315  
info(at)euchner-usa.com  
<http://www.euchner-usa.com>

### 14.3. Technical data for key A-FLX-K-...

Parameter	Value			Unit
	min.	typ.	max.	
Housing material	ABS plastic			
Dimensions	40 x 31 x 5			mm
Weight	0.004			kg
Ambient temperature	-25	-	+70	°C
Degree of protection	IP65/IP67			
Power supply	Inductive via key adapter			

#### 14.3.1. Dimension drawing for key

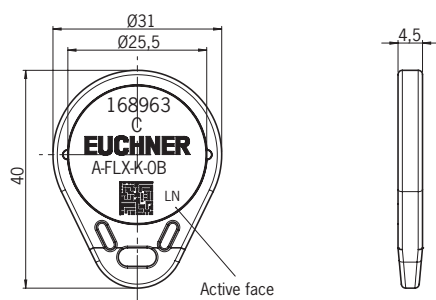



### 15. Service

If servicing is required, please contact:

EUCHNER GmbH + Co. KG  
Kohlhammerstraße 16  
70771 Leinfelden-Echterdingen  
Germany

**Service telephone:**

+49 711 7597-500

**E-mail:**

support@euchner.de

**Internet:**

www.euchner.com

### 16. Inspection and service



**WARNING**

Loss of the safety function because of damage to the device.

In case of damage, the affected module must be replaced completely. Only accessories or spare parts that can be ordered from EUCHNER may be replaced.

Regular inspection of the following is necessary to ensure trouble-free long-term operation:

- › Check the secure mounting of the devices and the connections

Further inspection measures may be necessary for the modules connected and submodules installed. Refer to the related operating instructions.

No servicing is required. Repairs to the device are only allowed to be made by the manufacturer.



**NOTICE**

The year of manufacture can be seen in the lower right corner of the type label.





EUCHNER GmbH + Co. KG  
Kohlhammerstraße 16  
70771 Leinfelden-Echterdingen  
Germany  
info@euchner.de  
www.euchner.com

Edition:  
MAN20001527-03-04/23  
Title:  
Operating Instructions Submodule MSM-1-R-CKS2-FLX-...  
(translation of the original operating instructions)  
Copyright:  
© EUCHNER GmbH + Co. KG, 04/2023

Subject to technical modifications; no responsibility is accepted for the accuracy of this information.