

TEST REPORT

Product Name : quadcopter
Model Number : HS360S, HS360E, HS360G, HS360D, HS360, DE22G, DE22R, DE22S, F11, F22, F7, F5, HS600, HS600D, HS600R, HS600G, HS110G, HS120S, HS270D, HS270S, F7, HS100G, D65, D75, D80, D90, D11, D100, HT40, HT50, HT60, HT65, HT70, HT300, HS290, HS320, HS390, HS410, HS460, HS480, HS490, HS520, HS530, HS540, HS560, HS570, HS580, HS590, HS610, HS620, HS630, HS640, HS650, HS660, HS670, HS680, HS690, HS730, HS740, HS750, HS760, HS770, HS780, HS790, HS810, HS820, HS900, HS176, HS101, HS155, HS176, D85, 2452EFK
FCC ID : 2AJ55HOLYSTONEOW

Prepared for Address : Xiamen Huoshiquan Import & Export CO., LTD
Unit 1, Room 501, Hongxiang Building, No.258 Hubin Nan Road, Siming District, Xiamen, China

Prepared by Address : EMTEK (SHENZHEN) CO., LTD.
Building 69, Majialong Industry Zone, Nanshan District, Shenzhen, Guangdong, China

Tel: (0755) 26954280
Fax: (0755) 26954282

Report Number : ENS2302130030W00601R
Date(s) of Tests : February 13, 2023 to April 8, 2023
Date of issue : April 8, 2023

1 TEST RESULT CERTIFICATION

Applicant : Xiamen Huoshiquan Import & Export CO., LTD

Address : Unit 1, Room 501, Hongxiang Building, No.258 Hubin Nan Road, Siming District, Xiamen, China

Manufacturer : Xiamen Huoshiquan Import & Export CO., LTD

Address : Unit 1, Room 501, Hongxiang Building, No.258 Hubin Nan Road, Siming District, Xiamen, China

EUT : quadcopter

Model Name : HS360S, HS360E, HS360G, HS360D, HS360, DE22G, DE22R, DE22S, F11, F22, F7, F5, HS600, HS600D, HS600R, HS600G, HS110G, HS120S, HS270D, HS270S, F7, HS100G, D65, D75, D80, D90, D11, D100, HT40, HT50, HT60, HT65, HT70, HT300, HS290, HS320, HS390, HS410, HS460, HS480, HS490, HS520, HS530, HS540, HS560, HS570, HS580, HS590, HS610, HS620, HS630, HS640, HS650, HS660, HS670, HS680, HS690, HS730, HS740, HS750, HS760, HS770, HS780, HS790, HS810, HS820, HS900, HS176, HS101, HS155, HS176, D85, 2452EFK

Trademark : Holy Stone

Measurement Procedure Used:

APPLICABLE STANDARDS	
STANDARD	TEST RESULT
FCC 47 CFR Part 2, Subpart J FCC 47 CFR Part 15, Subpart E	PASS

The above equipment was tested by EMTEK (SHENZHEN) CO., LTD. The test data, data evaluation, test procedures, and equipment configurations shown in this report were made in accordance with the procedures given in ANSI C63.10 (2013) and the energy emitted by the sample EUT tested as described in this report is in compliance with the requirements of FCC Rules Part 2 and Part 15.407

The test results of this report relate only to the tested sample identified in this report.

Date of Test : February 13, 2023 to April 8, 2023

Prepared by : *Luo Pei Ye*
Luo peiye /Editor

Reviewer : *Joe Xia*
Joe Xia /Supervisor

Approve & Authorized Signer : *[Signature]*
Lisa Wang/Manager



Modified History

Version	Report No.	Revision Date	Summary
Ver.1.0	ENS2302130030W00601R	/	Original Report



TABLE OF CONTENTS

1	TEST RESULT CERTIFICATION	2
2	EUT TECHNICAL DESCRIPTION	5
3	SUMMARY OF TEST RESULT	7
4	TEST METHODOLOGY	8
4.1	GENERAL DESCRIPTION OF APPLIED STANDARDS	8
4.2	MEASUREMENT EQUIPMENT USED	8
4.3	DESCRIPTION OF TEST MODES	9
5	FACILITIES AND ACCREDITATIONS	10
5.1	FACILITIES	10
5.2	EQUIPMENT	10
5.3	LABORATORY ACCREDITATIONS AND LISTINGS	10
6	TEST SYSTEM UNCERTAINTY	11
7	SETUP OF EQUIPMENT UNDER TEST	12
7.1	RADIO FREQUENCY TEST SETUP	12
7.2	RADIO FREQUENCY TEST SETUP	12
7.3	CONDUCTED EMISSION TEST SETUP	14
7.4	BLOCK DIAGRAM CONFIGURATION OF TEST SYSTEM	15
7.5	SUPPORT EQUIPMENT	15
8	TEST REQUIREMENTS	16
8.1	BANDWIDTH MEASUREMENT	16
8.2	MAXIMUM CONDUCTED OUTPUT POWER	45
8.3	MAXIMUM PEAK POWER DENSITY	79
8.4	UNDESIRABLE RADIATED SPURIOUS EMISSION	94
8.5	POWER LINE CONDUCTED EMISSIONS	113
8.6	ANTENNA APPLICATION	114

2 EUT TECHNICAL DESCRIPTION

Characteristics	Description
Product:	quadcopter
Model Number:	HS360S, HS360E, HS360G, HS360D, HS360, DE22G, DE22R, DE22S, F11, F22, F7, F5, HS600, HS600D, HS600R, HS600G, HS110G, HS120S, HS270D, HS270S, F7, HS100G, D65, D75, D80, D90, D11, D100, HT40, HT50, HT60, HT65, HT70, HT300, HS290, HS320, HS390, HS410, HS460, HS480, HS490, HS520, HS530, HS540, HS560, HS570, HS580, HS590, HS610, HS620, HS630, HS640, HS650, HS660, HS670, HS680, HS690, HS730, HS740, HS750, HS760, HS770, HS780, HS790, HS810, HS820, HS900, HS176, HS101, HS155, HS176, D85, 2452EFK (These models are identical in circuitry and electrical, mechanical and physical construction; The differences among them are model name and the color of appearance. Only indicates for different market purposes; We chose HS360S as the final test prototype)
Sample Number:	2#
Wifi Type:	<input checked="" type="checkbox"/> Wifi 5G with 5150MHz-5250MHz Band <input checked="" type="checkbox"/> Wifi 5G with 5725MHz-5850MHz Band
WLAN Supported:	<input checked="" type="checkbox"/> 802.11a <input checked="" type="checkbox"/> 802.11n(20MHz channel bandwidth)
Data Rate :	<input checked="" type="checkbox"/> 802.11a:54/48/36/24/18/12/9/6Mbps <input checked="" type="checkbox"/> 802.11n:up to 300 Mbps
Modulation:	<input checked="" type="checkbox"/> OFDM with BPSK/QPSK/16QAM/64QAM for 802.11a/n
Frequency Range:	<input checked="" type="checkbox"/> UNII-1: 5150MHz-5250MHz Band
	<input checked="" type="checkbox"/> 5180-5240MHz for 802.11a; <input checked="" type="checkbox"/> 5180-5240MHz for 802.11n(HT20);
	<input checked="" type="checkbox"/> UNII-3 with 5725MHz-5850MHz Band
	<input checked="" type="checkbox"/> 5745-5805MHz for 802.11a; <input checked="" type="checkbox"/> 5745-5805MHz for 802.11n(HT20);
TPC Function:	<input type="checkbox"/> Applicable <input checked="" type="checkbox"/> Not Applicable
Antenna Port:	<input checked="" type="checkbox"/> Antenna port 1 <input checked="" type="checkbox"/> Antenna port 2
Antenna Type:	Copper Tube Antenna
Antenna Gain:	<input checked="" type="checkbox"/> ANT 1: 2.16 dBi <input checked="" type="checkbox"/> ANT 2: 2.16 dBi
Transmit Power:	5150MHz-5250MHz : 18.51 dBm 5725MHz-5850MHz : 19.11 dBm

Power Supply :	DC 7.4V from Internal battery
Date of Received:	February 13, 2023
Temperature Range:	Refer to manufacturer user manual/operating manual

Note: For more details, please refer to the User's manual of the EUT.



3 SUMMARY OF TEST RESULT

FCC Part Clause	Test Parameter	Verdict	Remark
15.407 (a) 15.407 (e)	99% , 6dB and 26dB Bandwidth	PASS	
15.407 (a)	Maximum Conducted Output Power	PASS	
15.407 (a)	Peak Power Spectral Density	PASS	
15.407 (b)	Radiated Spurious Emission	PASS	
15.407(g)	Frequency Stability	PASS	
15.407 (b)(6) 15.207	Power Line Conducted Emission	PASS	
15.407(a) 15.203	Antenna Application	PASS	
NOTE1: N/A (Not Applicable) NOTE2: According to FCC OET KDB 789033 D2 General UNII Test Procedures New Rules v02r01, In addition, the radiated test is also performed to ensure the emissions emanating from the device cabinet also comply with the applicable limits.			

RELATED SUBMITTAL(S) / GRANT(S):

This submittal(s) (test report) is intended for **FCC ID:2AJ55HOLYSTONEOW** filing to comply with Section 15.407 of the FCC Part 15, Subpart 15E Rules.

4 TEST METHODOLOGY

4.1 GENERAL DESCRIPTION OF APPLIED STANDARDS

According to its specifications, the EUT must comply with the requirements of the following standards:

FCC 47 CFR Part 2, Subpart J

FCC 47 CFR Part 15, Subpart E

FCC KDB 662911 D01 Multiple Transmitter Output v02r01

FCC KDB 789033 D2 General UNII Test Procedures New Rules v02r01

4.2 MEASUREMENT EQUIPMENT USED

Conducted Emission Test Equipment

Equipment	Manufacturer	Model No.	Serial No.	Last Cal.	Cal. Interval
EMI Test Receiver	Rohde & Schwarz	ESCI	101384	2022/5/14	1Year
AMN	Rohde & Schwarz	ENV216	101161	2022/5/14	1Year
AMN	Kyoritsu	KNW-407	8-1492-9	2022/5/15	1Year

For Spurious Emissions Test

Equipment	Manufacturer	Model No.	Serial No.	Last Cal.	Cal. Interval
Pre-Amplifier	HP	8447F	2944A07999	2022/5/14	1Year
EMI Test Receiver	Rohde & Schwarz	ESCI	101414	2022/5/14	1Year
Bilog Antenna	Schwarzbeck	VULB9163	712	2022/7/5	2 Year
Horn antenna	Schwarzbeck	BBHA9120D	9120D-1178	2022/7/4	2 Year
Pre-Amplifie	Lunar EM	LNA1G18-48	J101113101000 1	2022/5/15	1Year
Spectrum Analyzer	Rohde & Schwarz	FSV40	100967	2022/5/14	1Year
Horn antenna	Schwarzbeck	BBHA9170	9170-399	2021/6/12	2 Year
Loop Antenna	Schwarzbeck	FMZB1519	1519-012	2021/6/12	2 Year
Band reject Filter(50dB)	WI/DE	WRCGV-2400(2400-2485MHz)	2	2022/5/15	1 Year

For other test items:

Equipment	Manufacturer	Model No.	Serial No.	Last Cal.	Cal. Interval
Signal Analyzer	Agilent	N9010A	MY53470879	2022/5/14	1Year
Vector Signal Generater	Agilent	N5182B	MY53050878	2022/5/14	1Year
Analog Signal Generator	Agilent	N5171B	MY53050553	2022/5/14	1Year
Power Meter	Agilent	PS-X10-100	\	2022/5/15	1Year
Blocking Box	THEDA	AD211	TW5451140	2022/5/14	1Year
Switchgroup	THEDA	ETF-025(VASC6)	TW5451008	N/A	N/A
MIMO Matrix Switch	THEDA	4P5TM18	TW5451009	N/A	N/A
Temperature&Humidity Chamber	ESPEC	EL-02KA	12107166	2022/7/3	1 Year

4.3 DESCRIPTION OF TEST MODES

The EUT has been tested under its typical operating condition.

The EUT configuration for testing is installed on RF field strength measurement to meet the Commissions requirement and operating in a manner which intends to maximize its emission characteristics in a continuous normal application.

The Transmitter was operated in the normal operating mode. The TX frequency was fixed which was for the purpose of the measurements.

Test of channel included the lowest and middle and highest frequency to perform the test, then record on this report.

Pre-defined engineering program for regulatory testing used to control the EUT for staying in continuous transmitting and receiving mode is programmed.

Wifi 5G with U-NII - 1

Frequency and Channel list for 802.11a, 802.11n (HT20):

Channel	Frequency (MHz)	Channel	Frequency (MHz)	Channel	Frequency (MHz)
36	5180	44	5220		
40	5200	48	5240		

Test Frequency and Channel for 802.11a, 802.11n (HT20):

Lowest Frequency		Middle Frequency		Highest Frequency	
Channel	Frequency (MHz)	Channel	Frequency (MHz)	Channel	Frequency (MHz)
36	5180	40	5200	48	5240

Wifi 5G with U-NII -3

Frequency and Channel list for 802.11a, 802.11n (HT20):

Channel	Frequency (MHz)	Channel	Frequency (MHz)	Channel	Frequency (MHz)
149	5745	157	5785		
153	5765	161	5805		

Test Frequency and Channel for 802.11a, 802.11n (HT20):

Lowest Frequency		Middle Frequency		Highest Frequency	
Channel	Frequency (MHz)	Channel	Frequency (MHz)	Channel	Frequency (MHz)
149	5745	157	5785	161	5805

The 5G WIFI has two antennas and support Multiple Outputs for 802.11n mode for this report; Antenna 1 Gain is 2.16 dBi; Antenna 2 Gain is 2.16 dBi; for this function is belong to Correlated Categorization equipment

According to KDB 662911, for Equal antenna gains,

Directional gain = GANT + 10 log(NANT) dBi=5.50 dBi

5 FACILITIES AND ACCREDITATIONS

5.1 FACILITIES

All measurement facilities used to collect the measurement data are located at:

EMTEK (Shenzhen) Co., Ltd.

Building 69, Majialong Industry Zone District, Nanshan District, Shenzhen, China

The sites are constructed in conformance with the requirements of ANSI C63.7, ANSI C63.4 and CISPR Publication 22.

5.2 EQUIPMENT

Radiated emissions are measured with one or more of the following types of linearly polarized antennas: tuned dipole, biconical, log periodic, bi-log, and/or ridged waveguide, horn. Spectrum analyzers with preselectors and quasi-peak detectors are used to perform radiated measurements.

Conducted emissions are measured with Line Impedance Stabilization Networks and EMI Test Receivers.

Calibrated wideband preamplifiers, coaxial cables, and coaxial attenuators are also used for making measurements.

All receiving equipment conforms to CISPR Publication 16-1, "Radio Interference Measuring Apparatus and Measurement Methods."

5.3 LABORATORY ACCREDITATIONS AND LISTINGS

Site Description	
EMC Lab.	<p>Accredited by CNAS The Certificate Registration Number is L2291. The Laboratory has been assessed and proved to be in compliance with CNAS-CL01 (identical to ISO/IEC 17025:2017)</p> <p>Accredited by FCC Designation Number: CN1204 Test Firm Registration Number: 882943</p> <p>Accredited by A2LA The Certificate Number is 4321.01.</p> <p>Accredited by Industry Canada The Conformity Assessment Body Identifier is CN0008</p>
Name of Firm	: EMTEK (SHENZHEN) CO., LTD.
Site Location	: Building 69, Majialong Industry Zone, Nanshan District, Shenzhen, Guangdong, China

6 TEST SYSTEM UNCERTAINTY

The following measurement uncertainty levels have been estimated for tests performed on the apparatus:

Parameter	Uncertainty
Radio Frequency	$\pm 1 \times 10^{-5}$
Maximum Peak Output Power Test	$\pm 1.0\text{dB}$
Conducted Emissions Test	$\pm 2.0\text{dB}$
Radiated Emission Test	$\pm 2.0\text{dB}$
Power Density	$\pm 2.0\text{dB}$
Occupied Bandwidth Test	$\pm 1.0\text{dB}$
Band Edge Test	$\pm 3\text{dB}$
All emission, radiated	$\pm 3\text{dB}$
Antenna Port Emission	$\pm 3\text{dB}$
Temperature	$\pm 0.5^\circ\text{C}$
Humidity	$\pm 3\%$

Measurement Uncertainty for a level of Confidence of 95%

7 SETUP OF EQUIPMENT UNDER TEST

7.1 RADIO FREQUENCY TEST SETUP

The WLAN component's antenna ports(s) of the EUT are connected to the measurement instrument per an appropriate attenuator. The EUT is controlled by PC/software to emit the specified signals for the purpose of measurements.

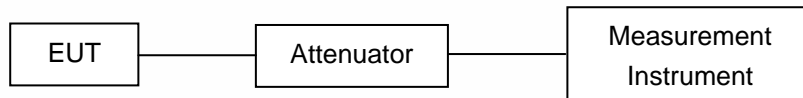

7.2 RADIO FREQUENCY TEST SETUP

The test site semi-anechoic chamber has met the requirement of NSA tolerance 4 dB according to the standards: ANSI C63.10. The test distance is 3m. The setup is according to the requirements in Section 13.1.4.1 of ANSI C63.10-2013 and CAN/CSA-CEI/IEC CISPR 22.

Below 30MHz:

The EUT is placed on a turntable 0.8 meters above the ground in the chamber, 3 meter away from the antenna (loop antenna). The Antenna should be positioned with its plane vertical at the specified distance from the EUT and rotated about its vertical axis for maximum response at each azimuth about the EUT. The center of the loop shall be 1 m above the ground. For certain applications, the loop antenna plane may also need to be positioned horizontally at the specified distance from the EUT.

Above 30MHz:

The EUT is placed on a turntable 0.8 meters above the ground in the chamber, 3 meter away from the antenna. The maximal emission value is acquired by adjusting the antenna height, polarisation and turntable azimuth. Normally, the height range of antenna is 1 m to 4 m, the azimuth range of turntable is 0° to 360°, and the receive antenna has two polarizations Vertical (V) and Horizontal (H).

Above 1GHz:

(Note: the FCC's permission to use 1.5m as an alternative per TCBC Conf call of Dec. 2, 2014.)

The EUT is placed on a turntable 1.5 meters above the ground in the chamber, 3 meter away from the antenna. The maximal emission value is acquired by adjusting the antenna height, polarisation and turntable azimuth. Normally, the height range of antenna is 1 m to 4 m, the azimuth range of turntable is 0° to 360°, and the receive antenna has two polarizations Vertical (V) and Horizontal (H).

(a) Radiated Emission Test Set-Up, Frequency Below 30MHz

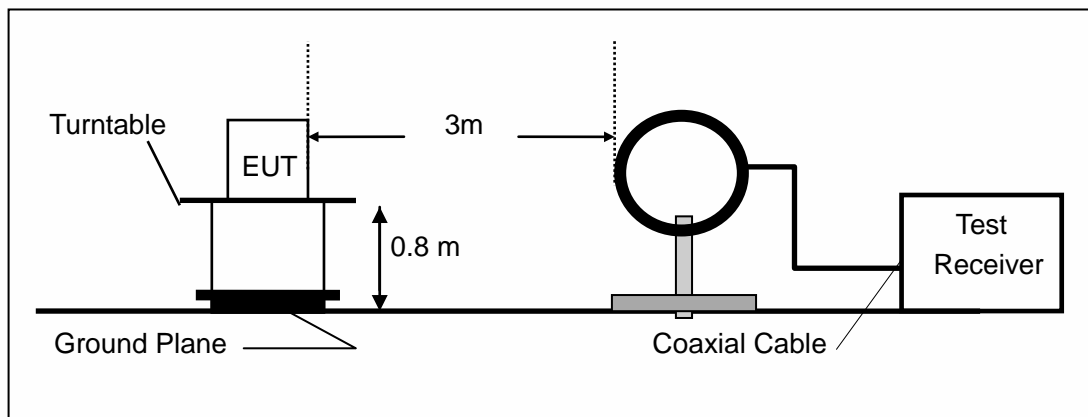

(b) Radiated Emission Test Set-Up, Frequency Below 1000MHz

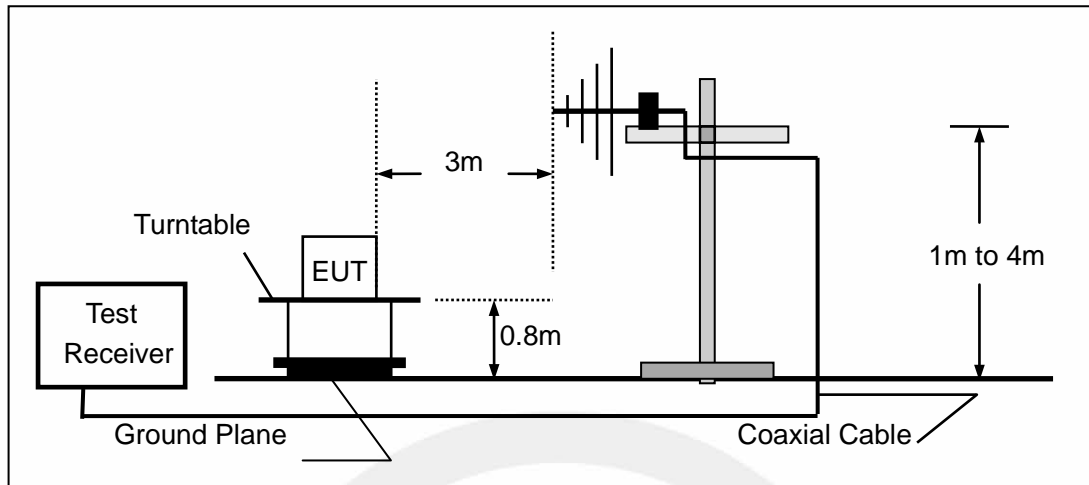

(c) Radiated Emission Test Set-Up, Frequency above 1000MHz

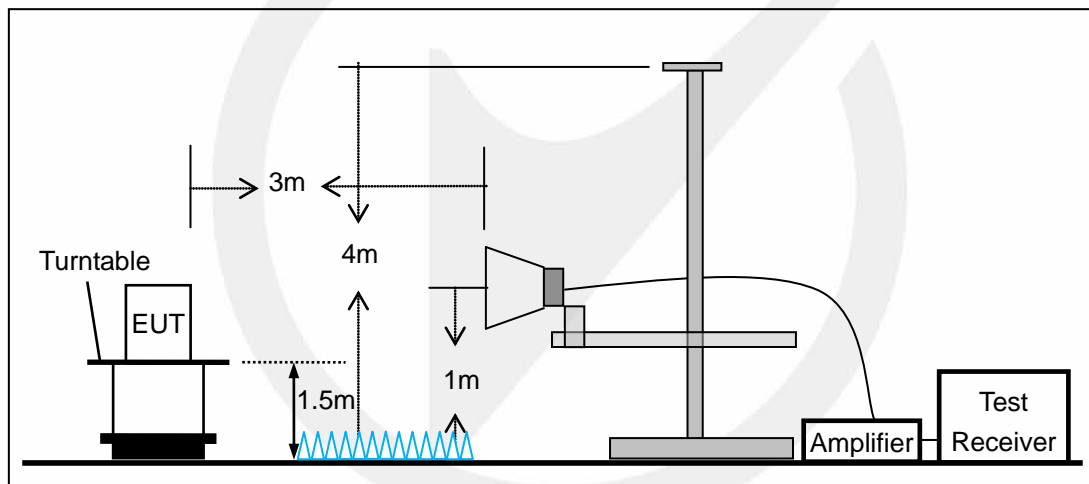

7.3 CONDUCTED EMISSION TEST SETUP

The mains cable of the EUT (maybe per AC/DC Adapter) must be connected to LISN. The LISN shall be placed 0.8 m from the boundary of EUT and bonded to a ground reference plane for LISN mounted on top of the ground reference plane. This distance is between the closest points of the LISN and the EUT. All other units of the EUT and associated equipment shall be at least 0.8m from the LISN.

Ground connections, where required for safety purposes, shall be connected to the reference ground point of the LISN and, where not otherwise provided or specified by the manufacturer, shall be of same length as the mains cable and run parallel to the mains connection at a separation distance of not more than 0.1 m.

According to the requirements in Section 13.1.4.1 of ANSI C63.10-2013 Conducted emissions from the EUT measured in the frequency range between 0.15 MHz and 30 MHz using CISPR Quasi-Peak and average detector mode.

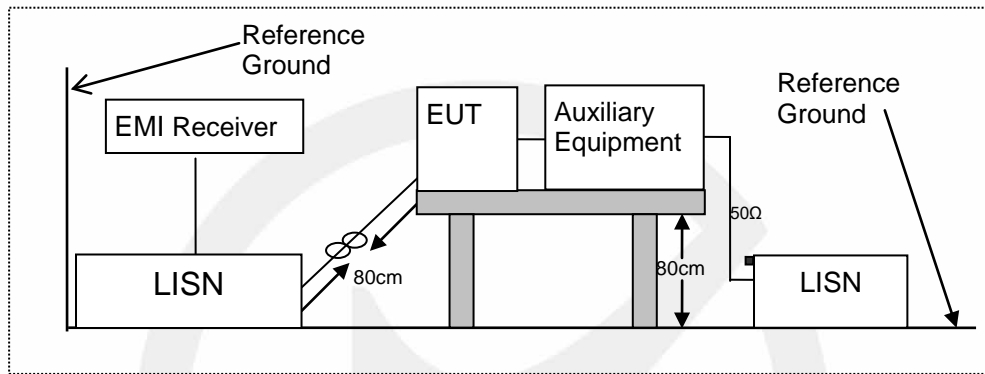

7.4 BLOCK DIAGRAM CONFIGURATION OF TEST SYSTEM

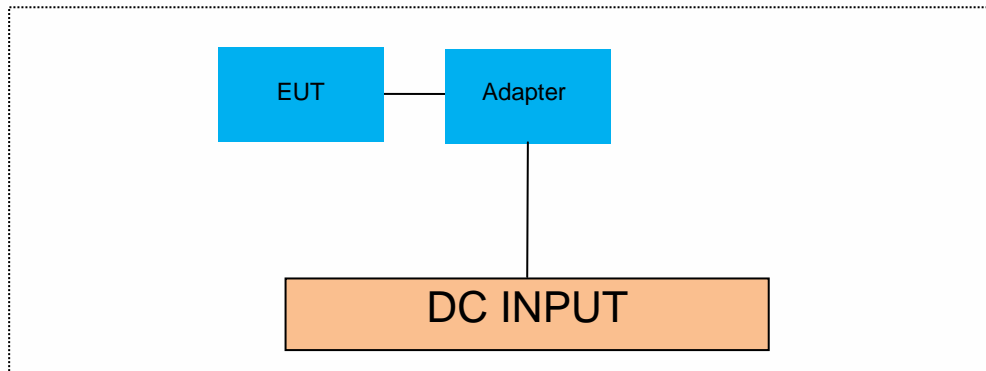

7.5 SUPPORT EQUIPMENT

EUT Cable List and Details			
Cable Description	Length (m)	Shielded/Unshielded	With / Without Ferrite
/	/	/	/

Auxiliary Cable List and Details			
Cable Description	Length (m)	Shielded/Unshielded	With / Without Ferrite
/	/	/	/

Auxiliary Equipment List and Details			
Description	Manufacturer	Model	Serial Number
Notebook	Lenove	M713A	SA12582190

Notes:

- 1.All the equipment/cables were placed in the worst-case configuration to maximize the emission during the test.
- 2.Grounding was established in accordance with the manufacturer’s requirements and conditions for the intended use.

8 TEST REQUIREMENTS

8.1 BANDWIDTH MEASUREMENT

8.1.1 Applicable Standard

According to FCC Part 15.407(a)(1) for UNII Band I
According to FCC Part 15.407(a)(2) for UNII Band II-A and UNII Band II-C
According to FCC Part 15.407(a)(3) for UNII Band III
According to FCC Part 15.407(e) for UNII Band III
According to 789033 D02 Section II(C)
According to 789033 D02 Section II(D)

8.1.2 Conformance Limit

(1) For the band 5.15-5.25 GHz.

(iv) For mobile and portable client devices in the 5.15-5.25 GHz band, the maximum conducted output power over the frequency band of operation shall not exceed 250 mW provided the maximum antenna gain does not exceed 6 dBi. In addition, the maximum power spectral density shall not exceed 11 dBm in any 1 megahertz band. If transmitting antennas of directional gain greater than 6 dBi are used, both the maximum conducted output power and the maximum power spectral density shall be reduced by the amount in dB that the directional gain of the antenna exceeds 6 dBi.

(2) For the 5.25-5.35 GHz and 5.47-5.725 GHz bands, the maximum conducted output power over the frequency bands of operation shall not exceed the lesser of 250 mW or 11 dBm + 10 log B, where B is the 26 dB emission bandwidth in megahertz. In addition, the maximum power spectral density shall not exceed 11 dBm in any 1 megahertz band. If transmitting antennas of directional gain greater than 6 dBi are used, both the maximum conducted output power and the maximum power spectral density shall be reduced by the amount in dB that the directional gain of the antenna exceeds 6 dBi.

(3) For the band 5.725-5.85 GHz, the maximum conducted output power over the frequency band of operation shall not exceed 1 W. In addition, the maximum power spectral density shall not exceed 30 dBm in any 500-kHz band. If transmitting antennas of directional gain greater than 6 dBi are used, both the maximum conducted output power and the maximum power spectral density shall be reduced by the amount in dB that the directional gain of the antenna exceeds 6 dBi. However, fixed point-to-point U-NII devices operating in this band may employ transmitting antennas with directional gain greater than 6 dBi without any corresponding reduction in transmitter conducted power. Fixed, point-to-point operations exclude the use of point-to-multipoint systems, omnidirectional applications, and multiple collocated transmitters transmitting the same information. The operator of the U-NII device, or if the equipment is professionally installed, the installer, is responsible for ensuring that systems employing high gain directional antennas are used exclusively for fixed, point-to-point operations.

(e) Within the 5.725-5.85 GHz band, the minimum 6 dB bandwidth of U-NII devices shall be at least 500 kHz.

8.1.3 Test Configuration

Test according to clause 7.1 radio frequency test setup

8.1.4 Test Procedure

According to 789033 D02 v02r01 section C&D, the following is the measurement procedure.

1. Emission Bandwidth (EBW)

- a) Set RBW = approximately 1% of the emission bandwidth.
- b) Set the VBW > RBW.
- c) Detector = Peak.
- d) Trace mode = max hold.
- e) Measure the maximum width of the emission that is 26 dB down from the maximum of the emission.

Compare this with the RBW setting of the analyzer. Readjust RBW and repeat measurement as needed until the RBW/EBW ratio is approximately 1%.

2. Minimum Emission Bandwidth for the band 5.725-5.85 GHz

Section 15.407(e) specifies the minimum 6 dB emission bandwidth of at least 500 KHz for the band 5.715-5.85 GHz. The following procedure shall be used for measuring this bandwidth:

- a) Set RBW = 100 kHz.
- b) Set the video bandwidth (VBW) $\geq 3 \times$ RBW.
- c) Detector = Peak.
- d) Trace mode = max hold.
- e) Sweep = auto couple.
- f) Allow the trace to stabilize.
- g) Measure the maximum width of the emission that is constrained by the frequencies associated with the two outermost amplitude points (upper and lower frequencies) that are attenuated by 6 dB relative to the maximum level measured in the fundamental emission.

Note: The automatic bandwidth measurement capability of a spectrum analyzer or EMI receiver may be employed if it implements the functionality described above.

D. 99 Percent Occupied Bandwidth

The 99-percent occupied bandwidth is the frequency bandwidth such that, below its lower and above its upper frequency limits, the mean powers are each equal to 0.5 % of the total mean power of the given emission. Measurement of the 99-percent occupied bandwidth is required only as a condition for using the optional band-edge measurement techniques described in section II.G.3.d). Measurements of 99-percent occupied bandwidth may also optionally be used in lieu of the EBW to 789033 D02 v01r02 General UNII Test Procedures New Rules v01 define the minimum frequency range over which the spectrum is integrated when measuring maximum conducted output power as described in section II.E. However, the EBW must be measured to determine bandwidth dependent limits on maximum conducted output power in accordance with 15.407(a).

The following procedure shall be used for measuring (99 %) power bandwidth:

1. Set center frequency to the nominal EUT channel center frequency.
2. Set span = 1.5 times to 5.0 times the OBW.
3. Set RBW = 1 % to 5 % of the OBW
4. Set VBW $\geq 3 \cdot$ RBW
5. Video averaging is not permitted. Where practical, a sample detection and single sweep mode shall be used. Otherwise, peak detection and max hold mode (until the trace stabilizes) shall be used.
6. Use the 99 % power bandwidth function of the instrument (if available).
7. If the instrument does not have a 99 % power bandwidth function, the trace data points are recovered and directly summed in power units. The recovered amplitude data points, beginning at the lowest frequency, are placed in a running sum until 0.5 % of the total is reached; that frequency is recorded as the lower frequency. The process is repeated until 99.5 % of the total is reached; that frequency is recorded as the upper frequency. The 99% occupied bandwidth is the difference between these two frequencies.

8.1.5 Test Results

TestMode	Antenna	Frequency[MHz]	26db EBW [MHz]	FL[MHz]	FH[MHz]	Limit[MHz]	Verdict
11A	Ant1	5180	18.68	5170.76	5189.44	---	---
	Ant2	5180	18.72	5170.72	5189.44	---	---
	Ant1	5200	18.52	5190.84	5209.36	---	---
	Ant2	5200	18.68	5190.76	5209.44	---	---
	Ant1	5240	18.56	5230.84	5249.40	---	---
	Ant2	5240	18.64	5230.72	5249.36	---	---
	Ant1	5745	18.84	5735.56	5754.40	---	---
	Ant2	5745	19.40	5735.68	5755.08	---	---
	Ant1	5785	18.92	5775.64	5794.56	---	---
	Ant2	5785	18.76	5775.72	5794.48	---	---
	Ant1	5805	19.72	5795.16	5814.88	---	---
	Ant2	5805	18.76	5795.76	5814.52	---	---
11N20MIMO	Ant1	5180	19.56	5170.24	5189.80	---	---
	Ant2	5180	19.32	5170.36	5189.68	---	---
	Ant1	5200	19.80	5190.24	5210.04	---	---
	Ant2	5200	19.56	5190.24	5209.80	---	---
	Ant1	5240	19.52	5230.32	5249.84	---	---
	Ant2	5240	19.52	5230.24	5249.76	---	---
	Ant1	5745	19.52	5735.32	5754.84	---	---
	Ant2	5745	19.60	5735.24	5754.84	---	---
	Ant1	5785	19.52	5775.32	5794.84	---	---
	Ant2	5785	19.56	5775.28	5794.84	---	---
	Ant1	5805	19.56	5795.24	5814.80	---	---
	Ant2	5805	19.48	5795.24	5814.72	---	---

11A_Ant1_5180

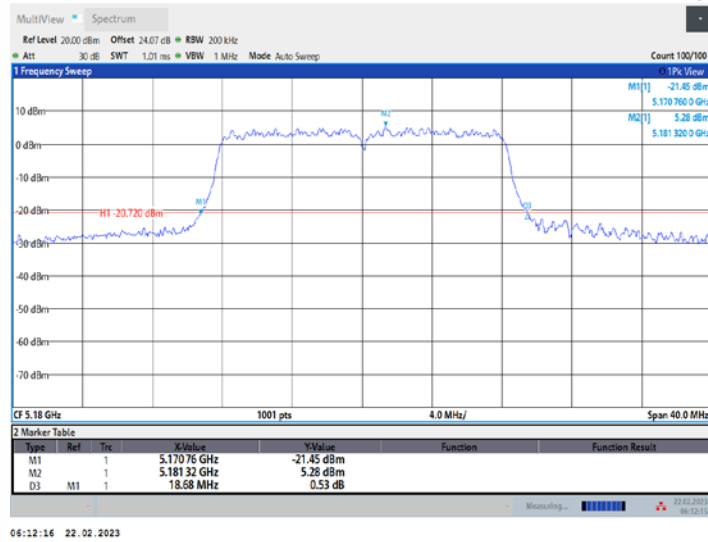

11A_Ant2_5180

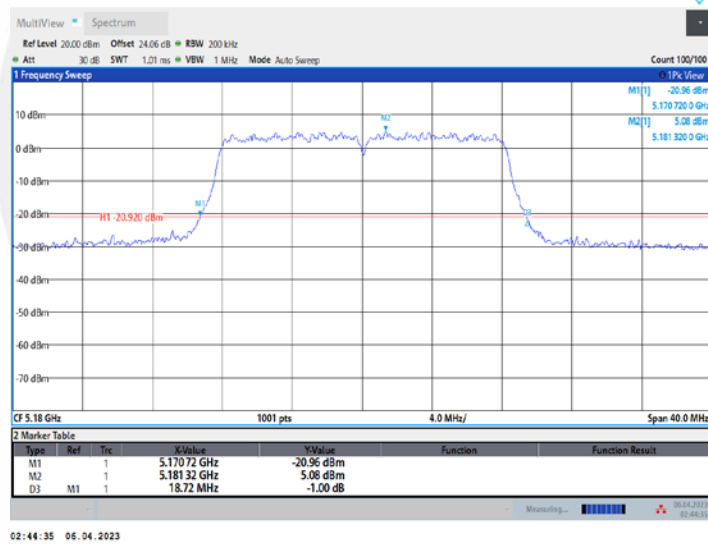

11A_Ant1_5200

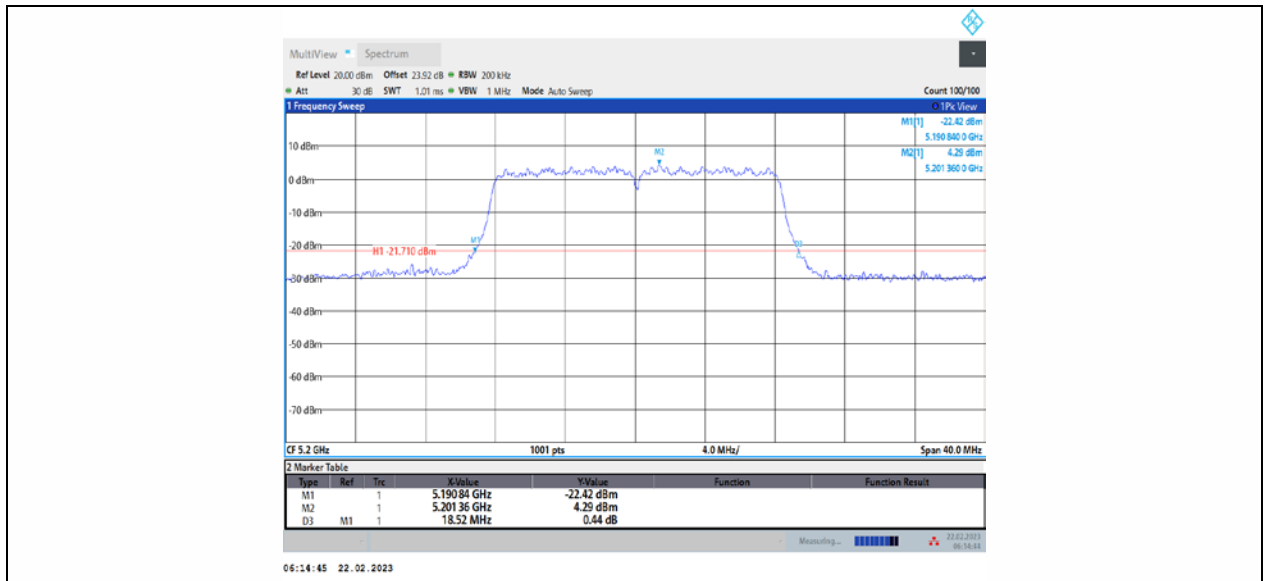

11A_Ant2_5200

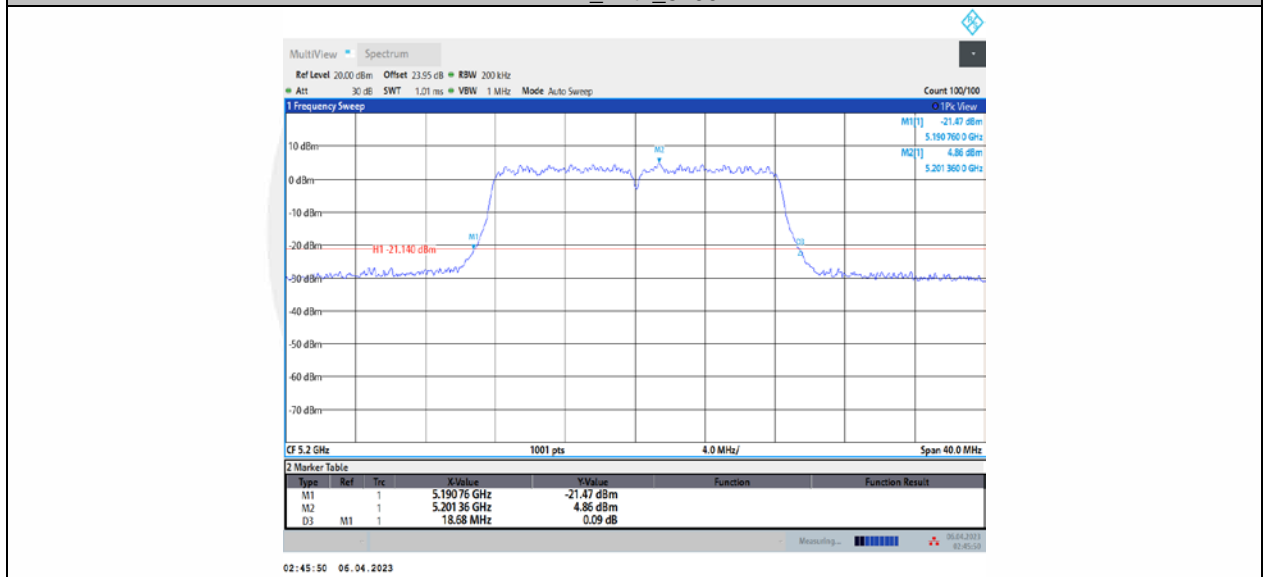

11A_Ant1_5240

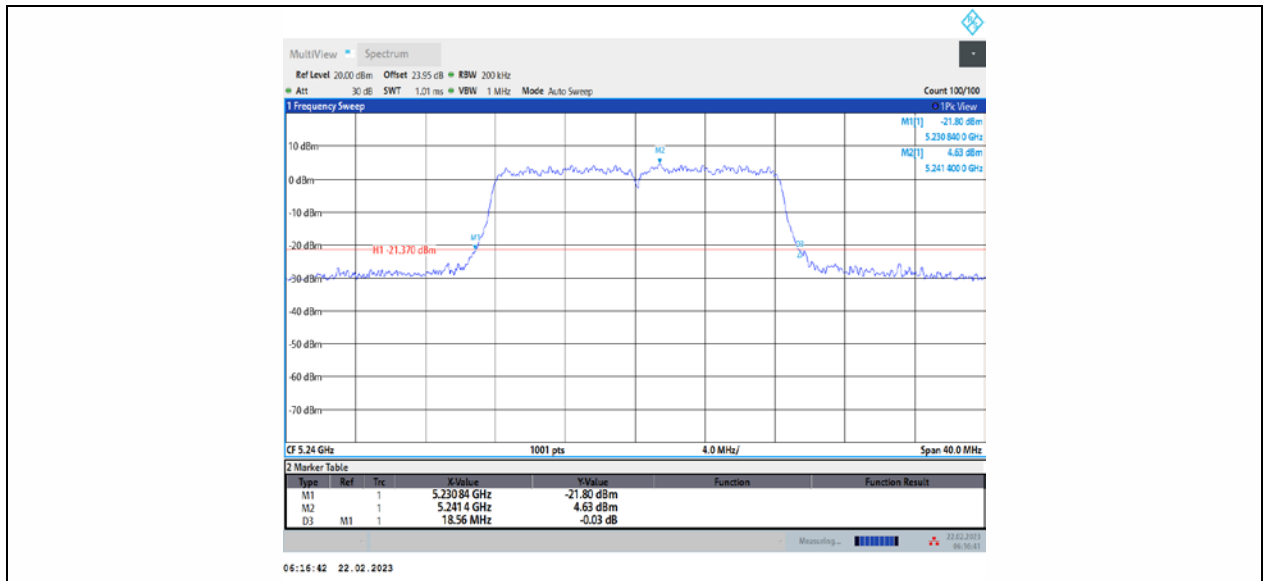

11A_Ant2_5240

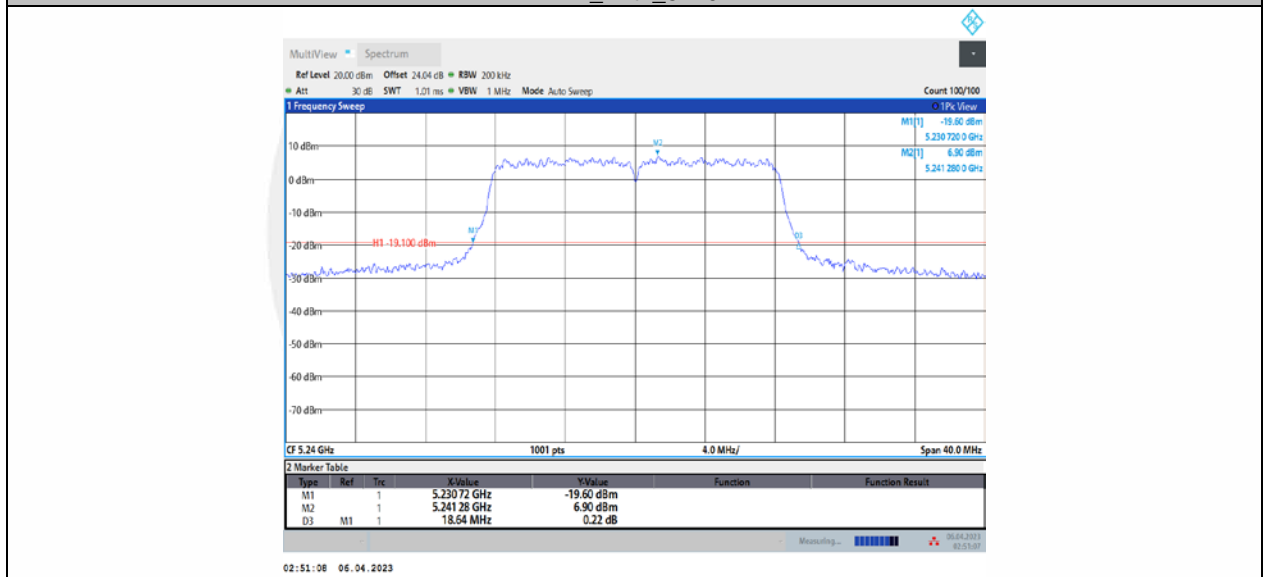

11A_Ant1_5745

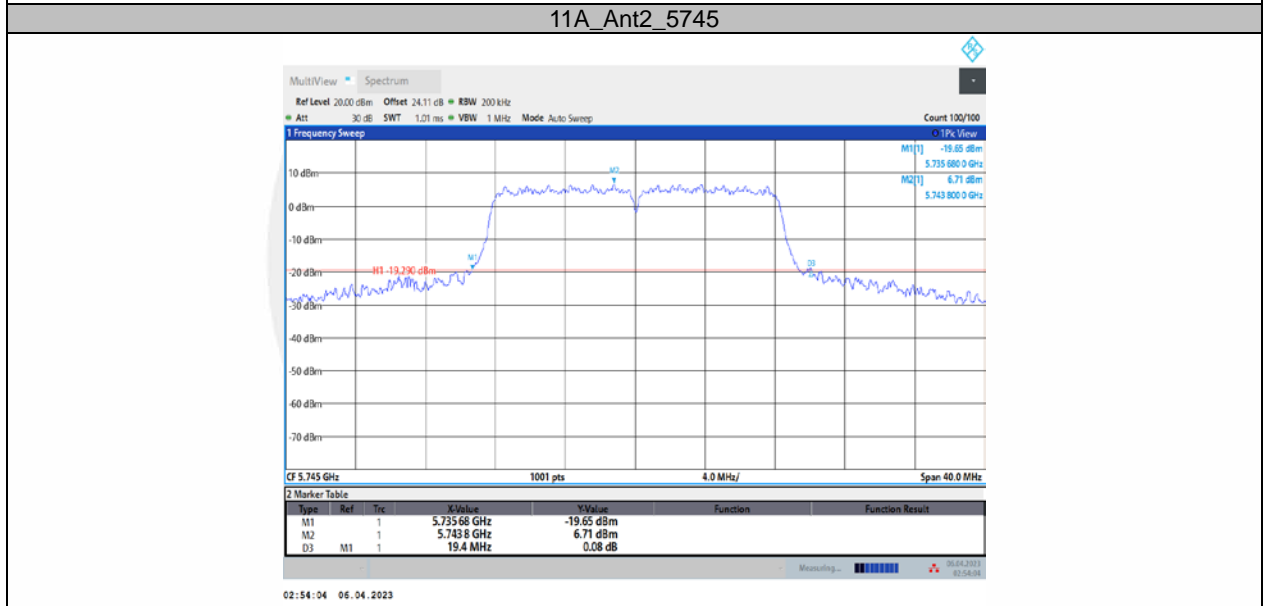
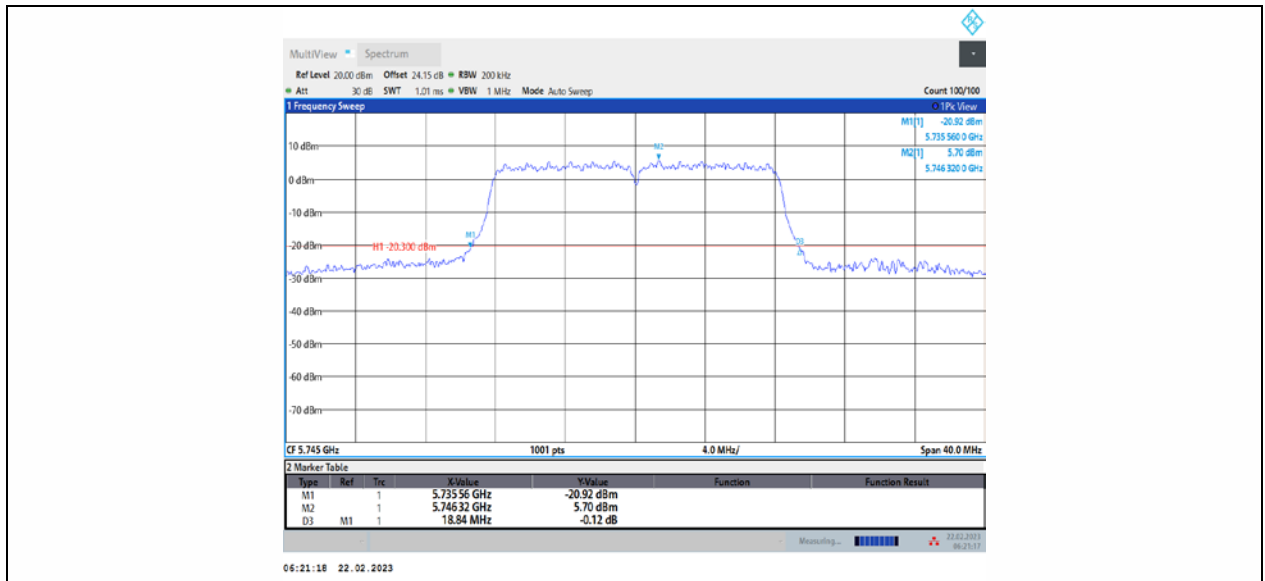

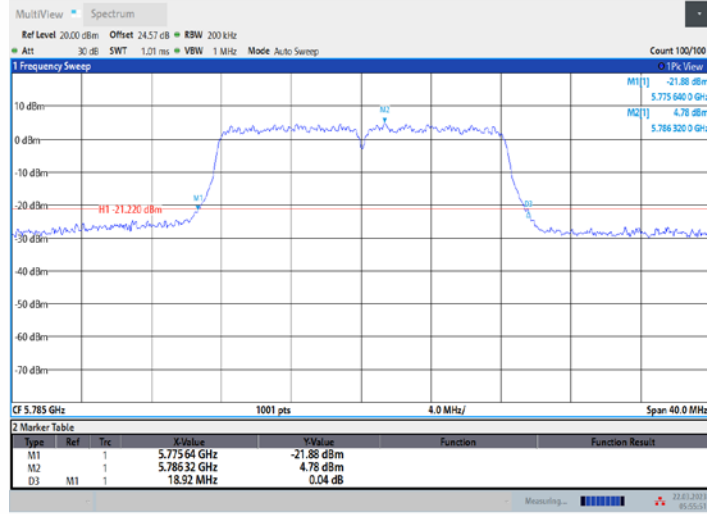

05:55:52 22.03.2023

11A_Ant2_5785

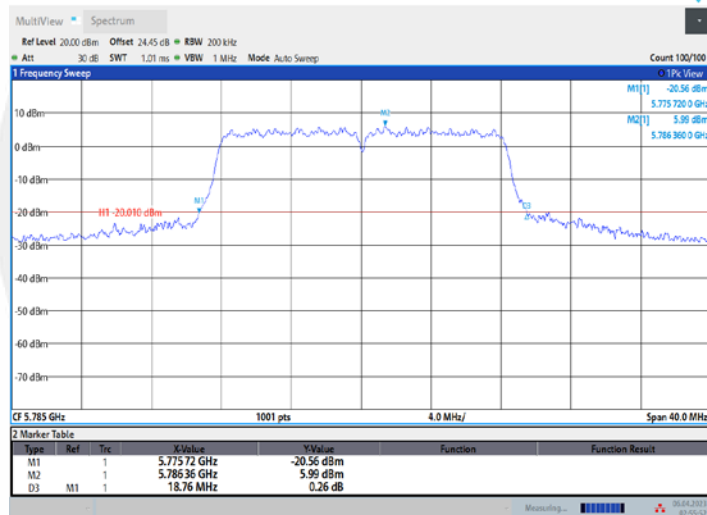

02:55:53 06.04.2023

11A_Ant1_5805

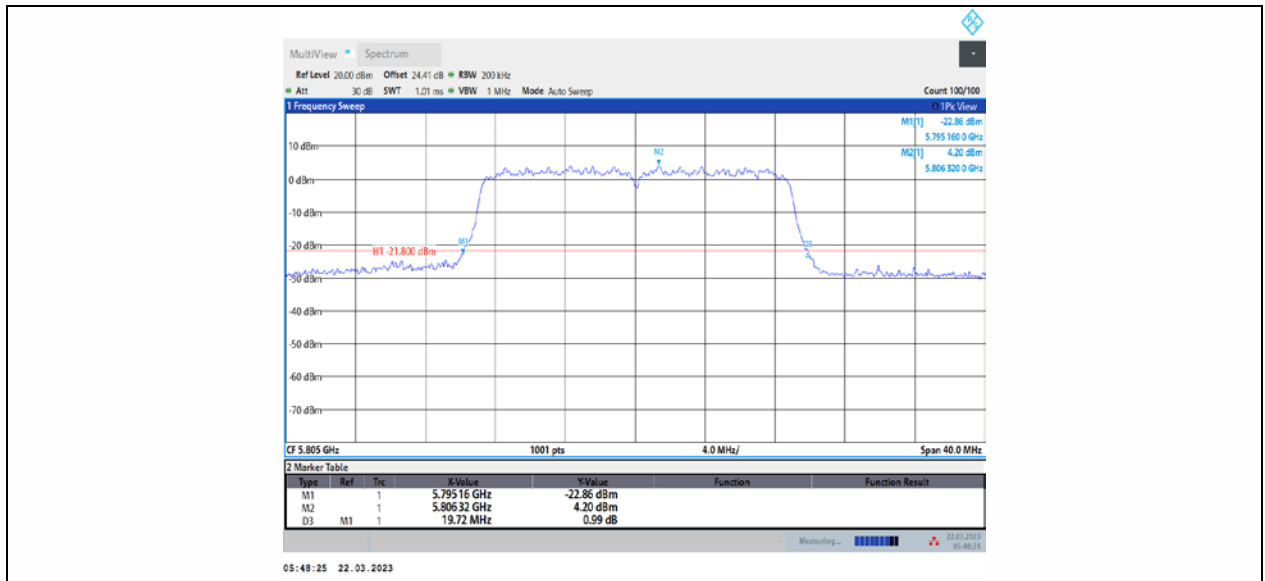

11A_Ant2_5805

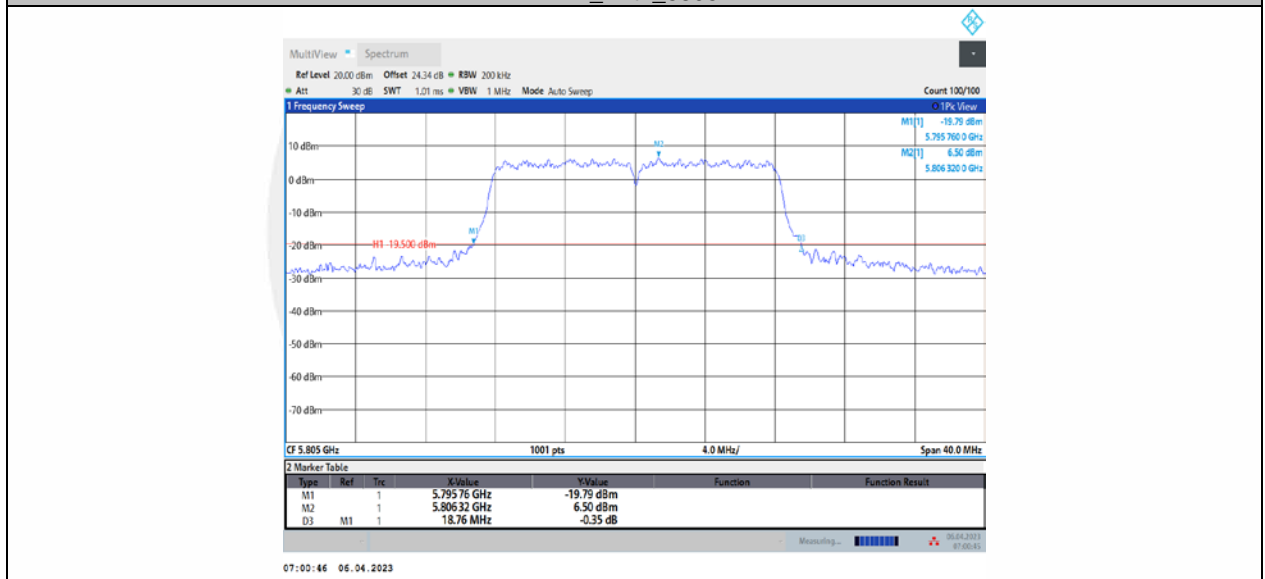

11N20MIMO_Ant1_5180

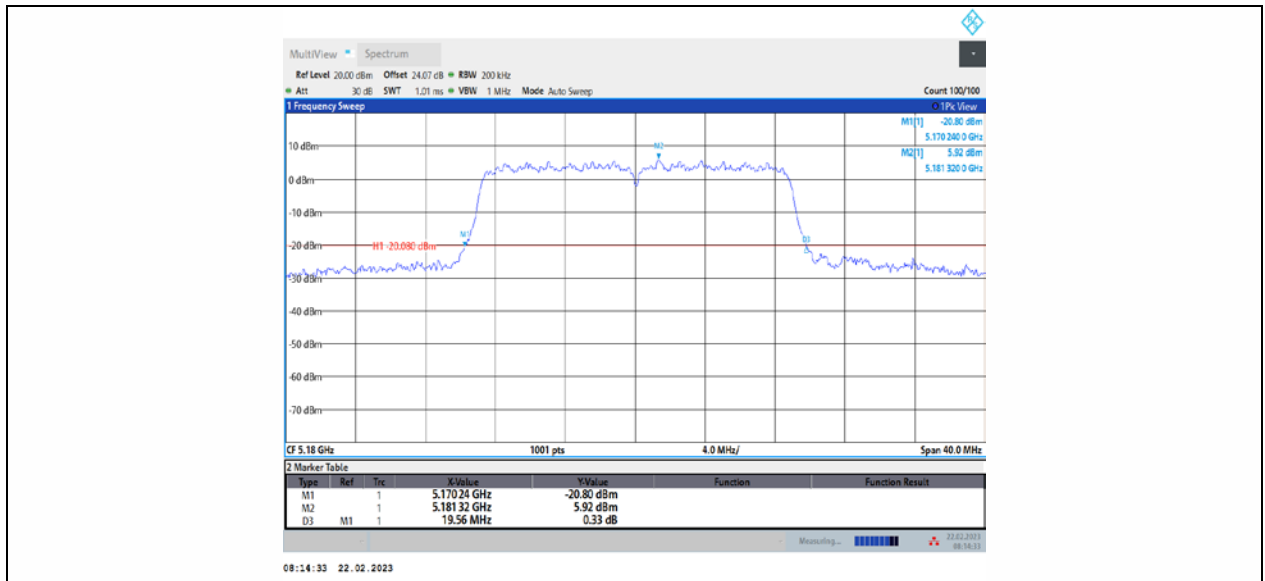

11N20MIMO_Ant2_5180

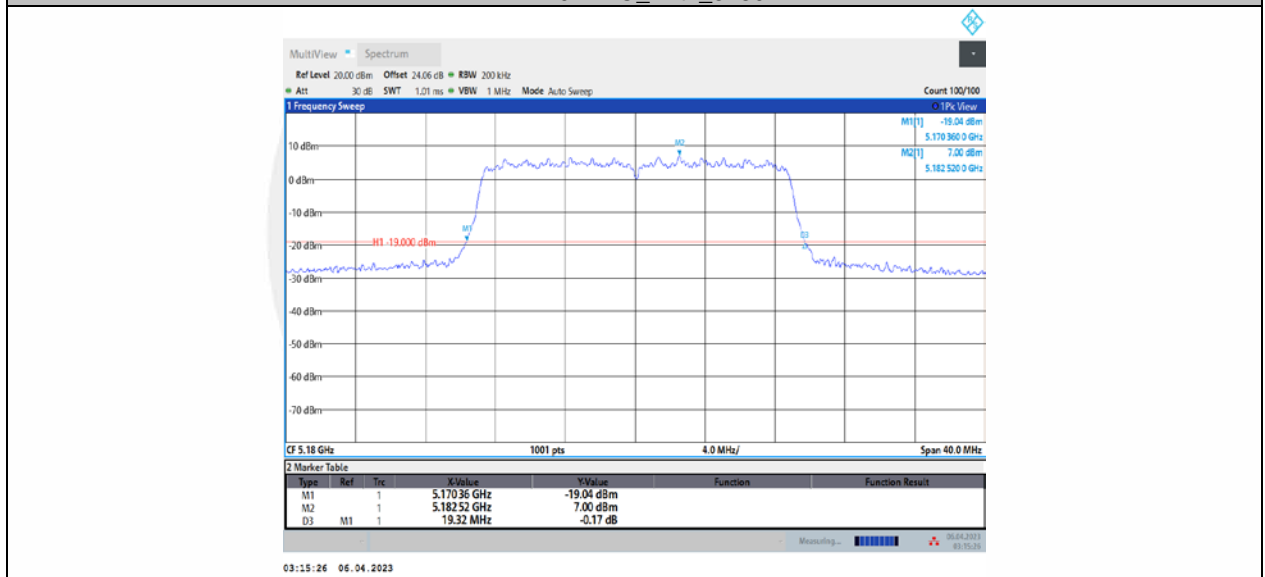

11N20MIMO_Ant1_5200

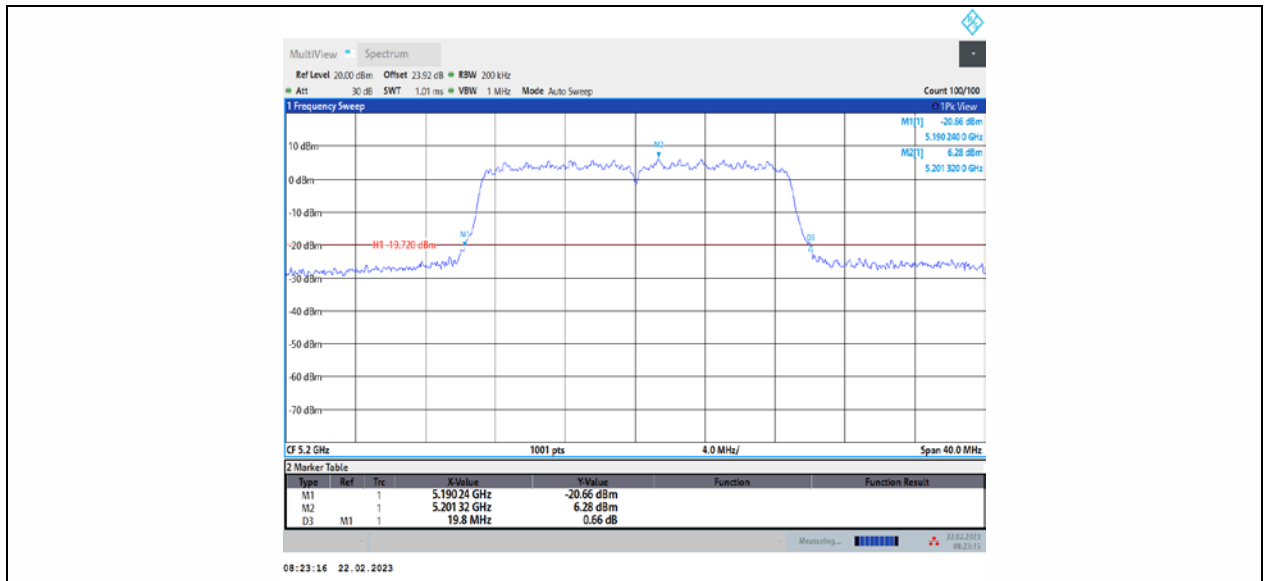

11N20MIMO_Ant2_5200

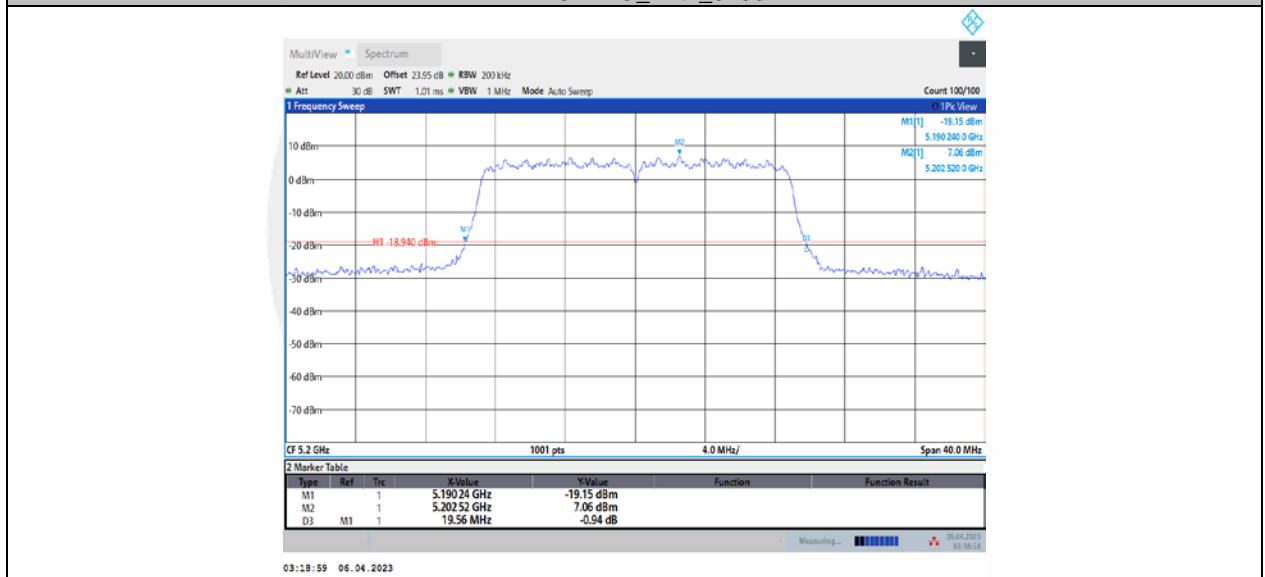

11N20MIMO_Ant1_5240

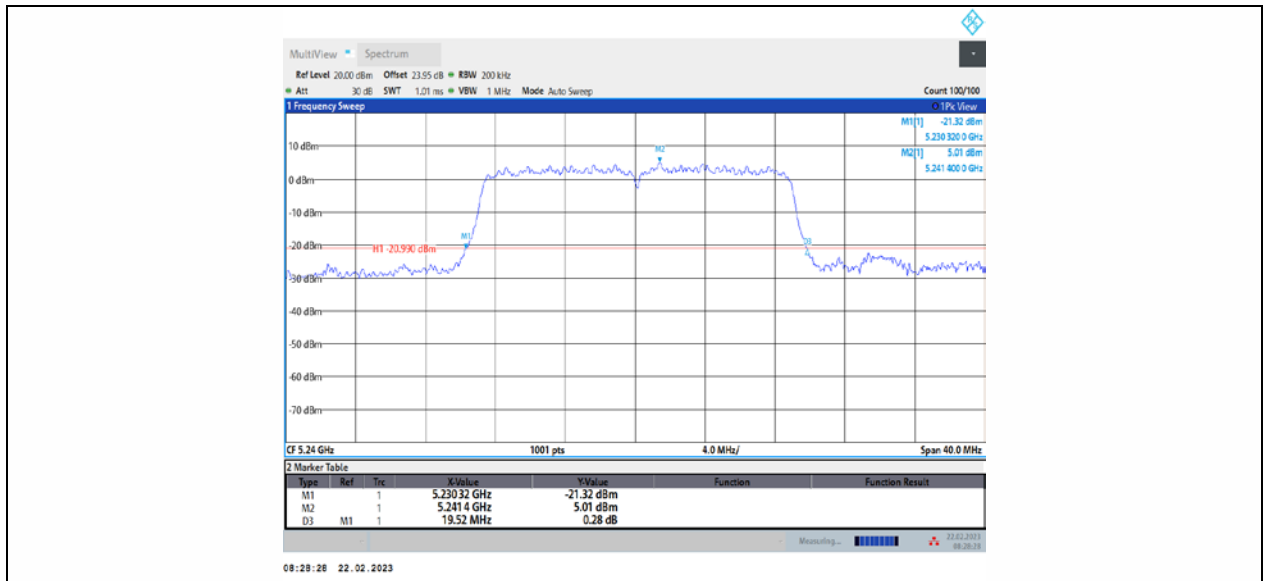

11N20MIMO_Ant2_5240

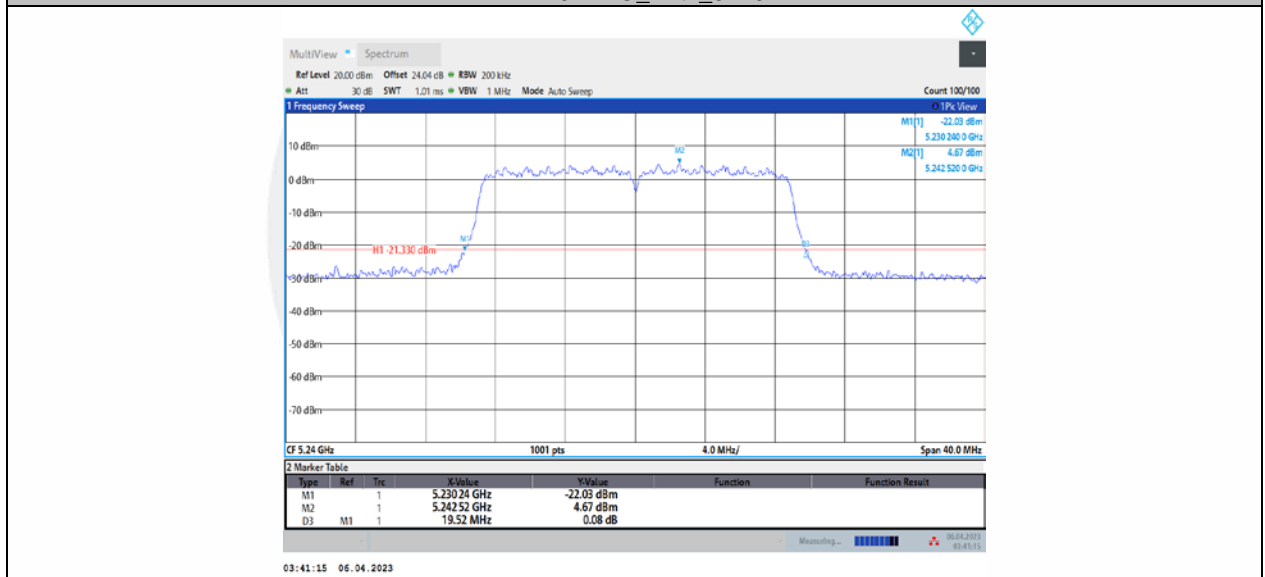

11N20MIMO_Ant1_5745

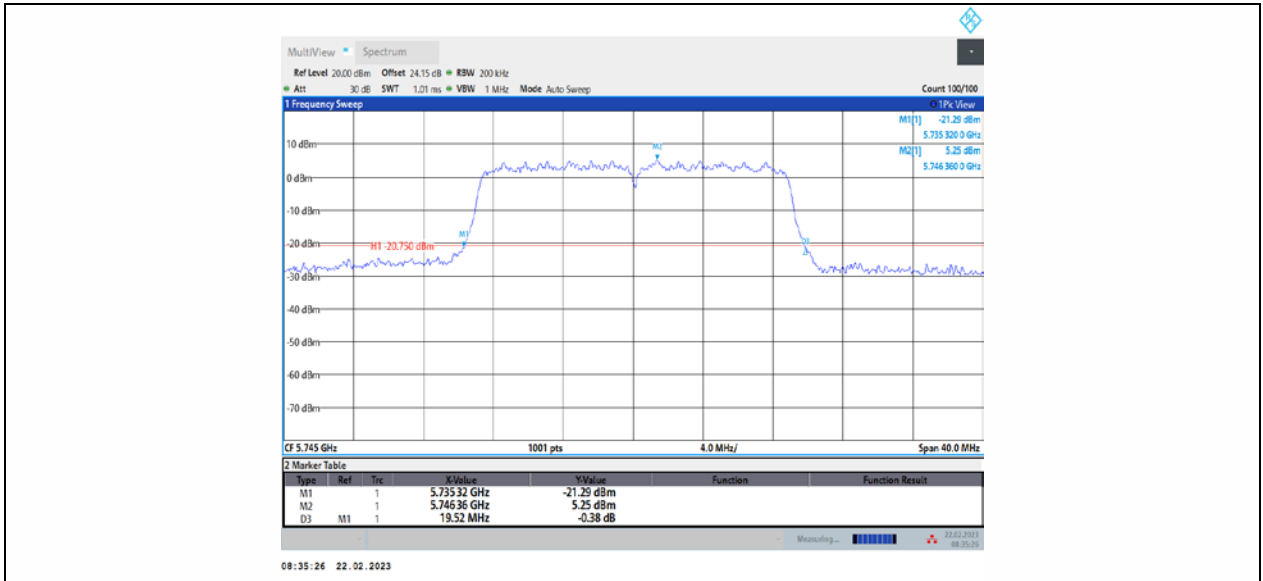

11N20MIMO_Ant2_5745

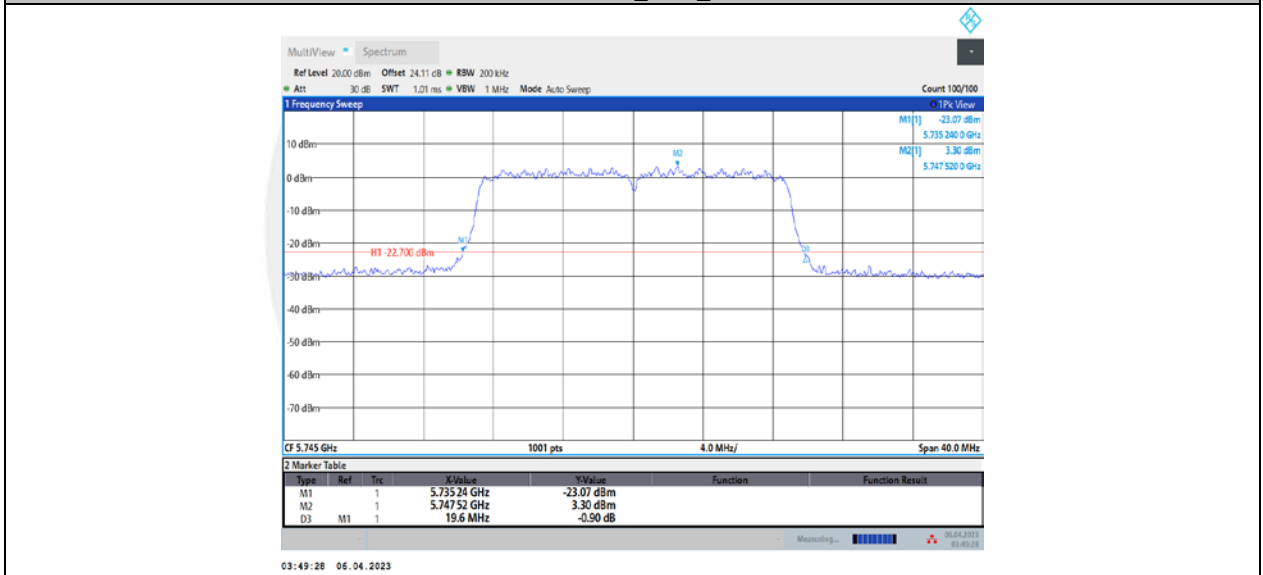

11N20MIMO_Ant1_5785

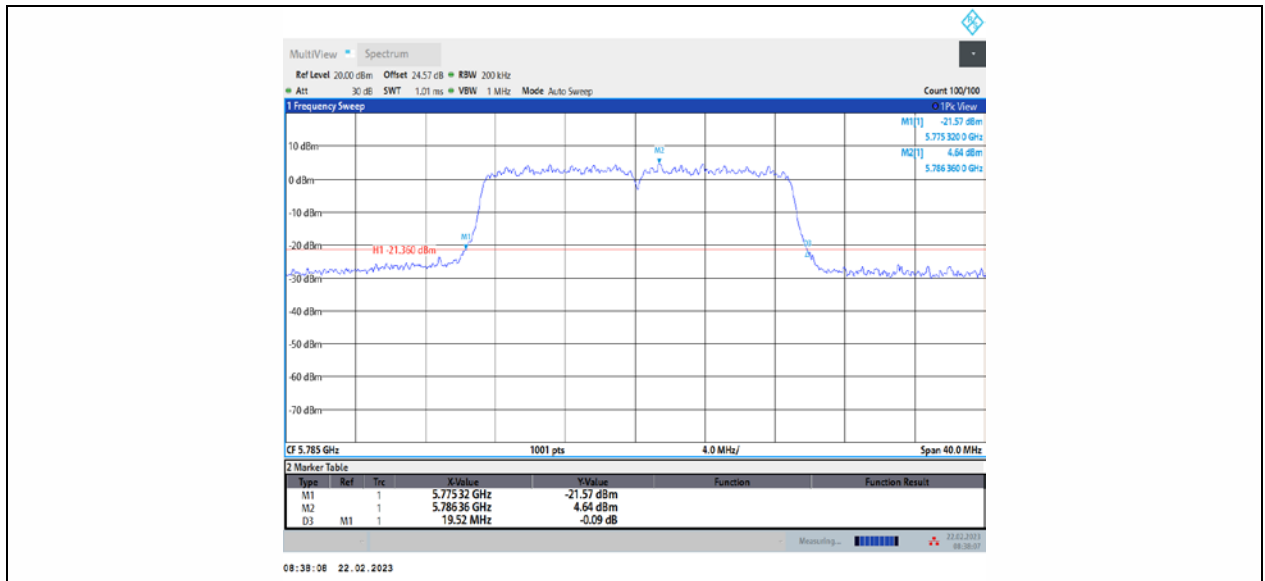

11N20MIMO_Ant2_5785

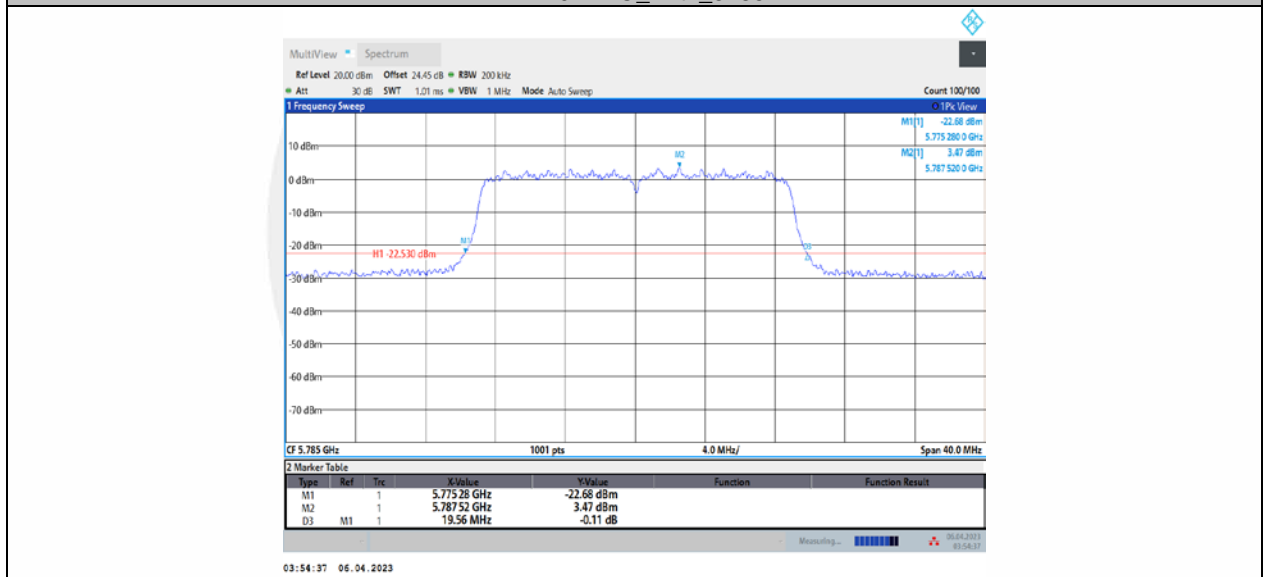

11N20MIMO_Ant1_5805

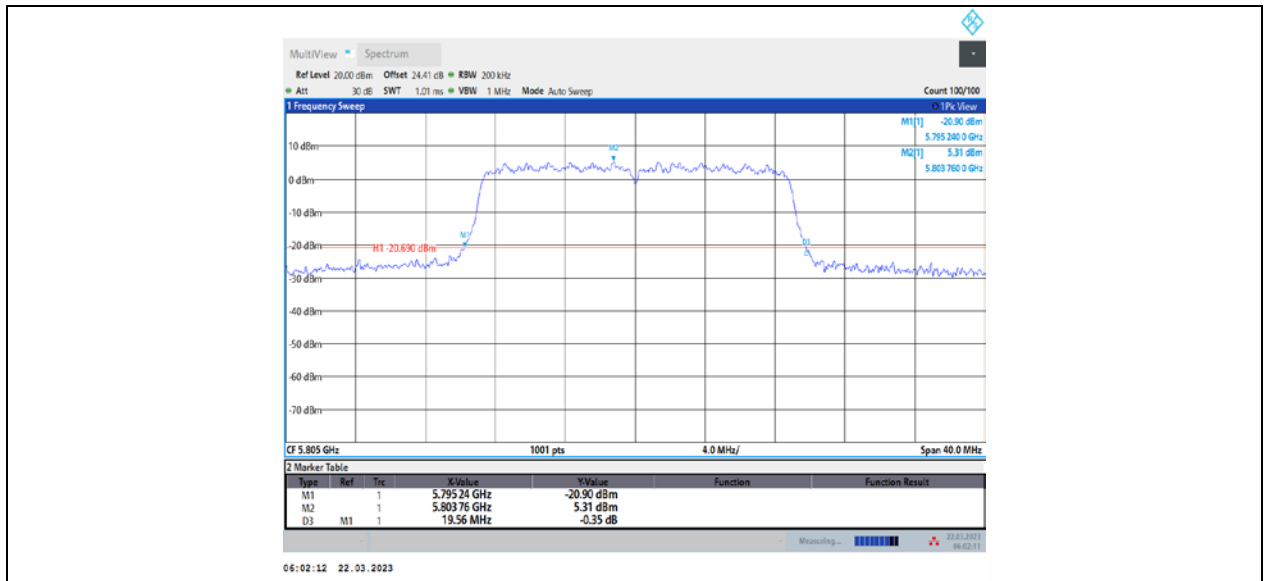

11N20MIMO_Ant2_5805

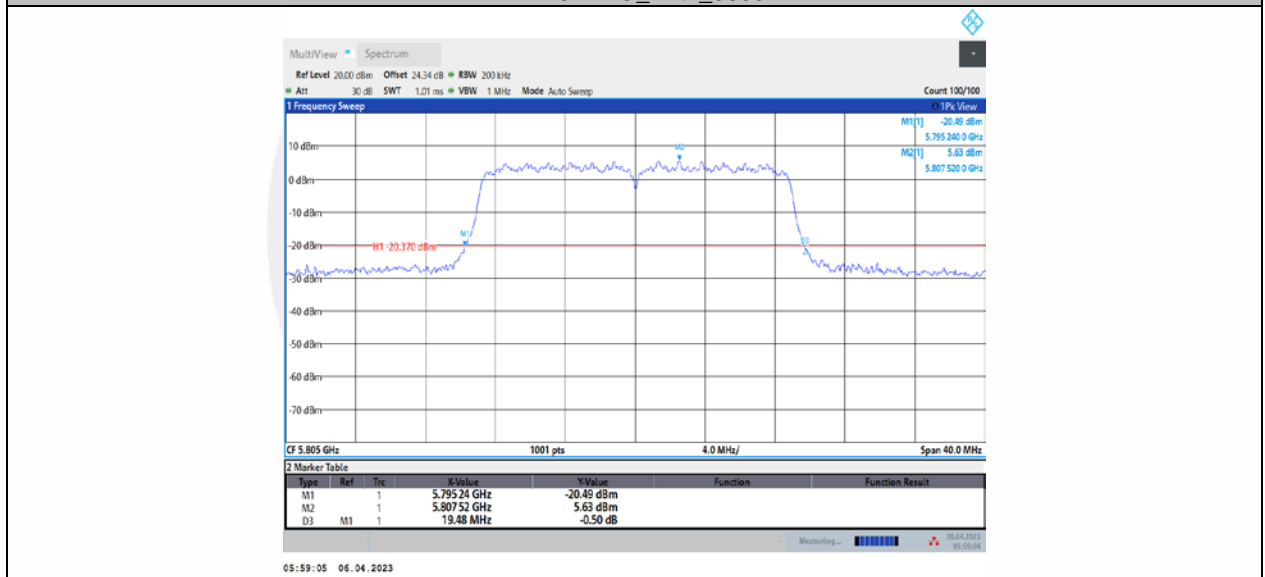

TestMode	Antenna	Frequency[MHz]	OCB [MHz]	FL[MHz]	FH[MHz]	Limit[MHz]	Verdict
11A	Ant1	5180	16.645	5171.7441	5188.3894	---	---
	Ant2	5180	16.657	5171.6924	5188.3496	---	---
	Ant1	5200	16.599	5191.7853	5208.3847	---	---
	Ant2	5200	16.64	5191.7607	5208.4007	---	---
	Ant1	5240	16.655	5231.8105	5248.4652	---	---
	Ant2	5240	16.645	5231.7117	5248.3571	---	---
	Ant1	5745	16.679	5736.7004	5753.3796	---	---
	Ant2	5745	16.747	5736.6881	5753.4350	---	---
	Ant1	5785	16.632	5776.8178	5793.4499	---	---
	Ant2	5785	16.733	5776.7414	5793.4740	---	---
	Ant1	5805	16.677	5796.6984	5813.3758	---	---
Ant2	5805	16.662	5796.6861	5813.3481	---	---	
11N20MIMO	Ant1	5180	17.765	5171.1846	5188.9497	---	---
	Ant2	5180	17.693	5171.1952	5188.8878	---	---
	Ant1	5200	17.766	5191.1875	5208.9533	---	---
	Ant2	5200	17.739	5191.1673	5208.9064	---	---
	Ant1	5240	17.818	5231.2148	5249.0326	---	---
	Ant2	5240	17.745	5231.1514	5248.8966	---	---
	Ant1	5745	17.755	5736.2008	5753.9555	---	---
	Ant2	5745	17.745	5736.1636	5753.9085	---	---
	Ant1	5785	17.753	5776.2447	5793.9980	---	---
	Ant2	5785	17.768	5776.1541	5793.9218	---	---
	Ant1	5805	17.741	5796.1634	5813.9041	---	---
Ant2	5805	17.765	5796.1417	5813.9065	---	---	

11A_Ant1_5180

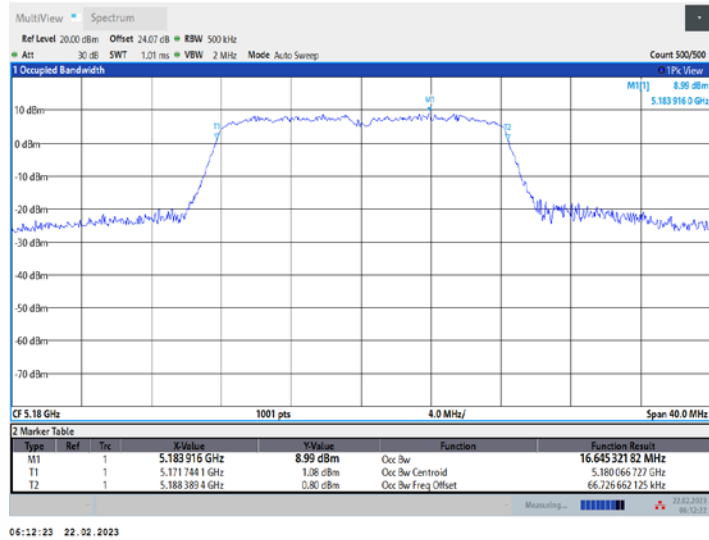

11A_Ant2_5180

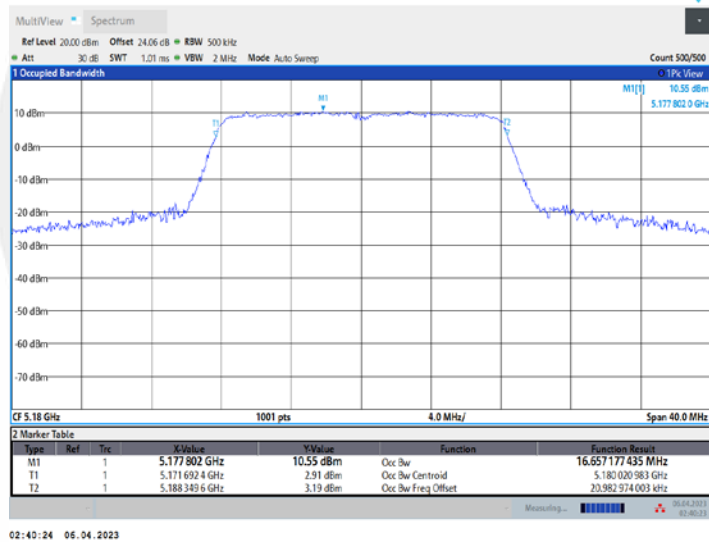

11A_Ant1_5200

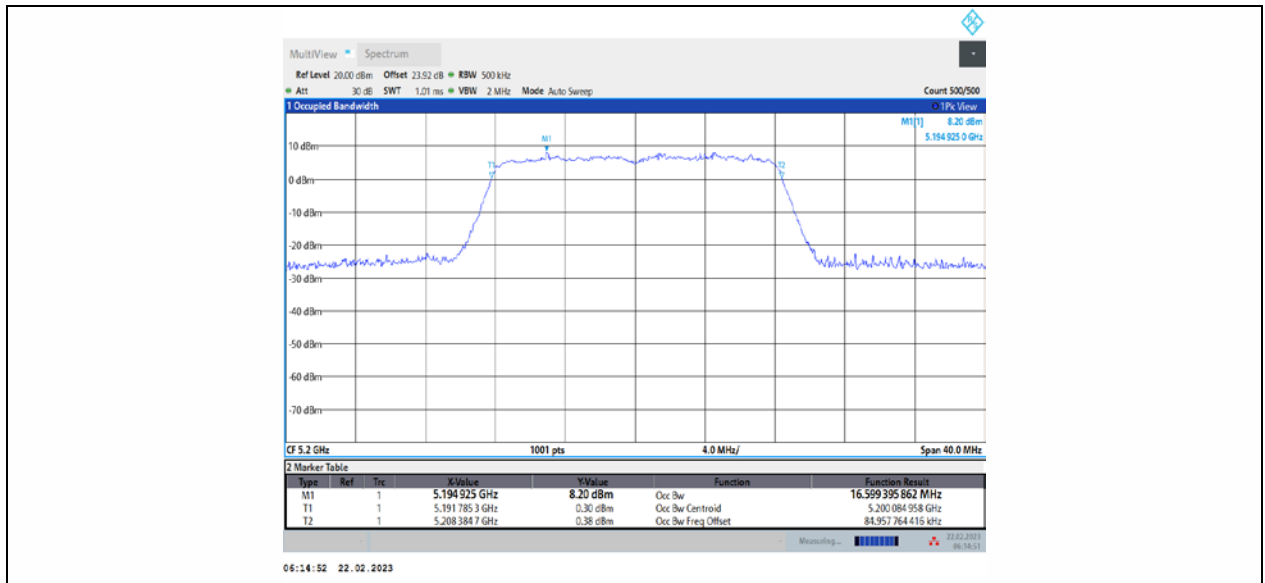

11A_Ant2_5200

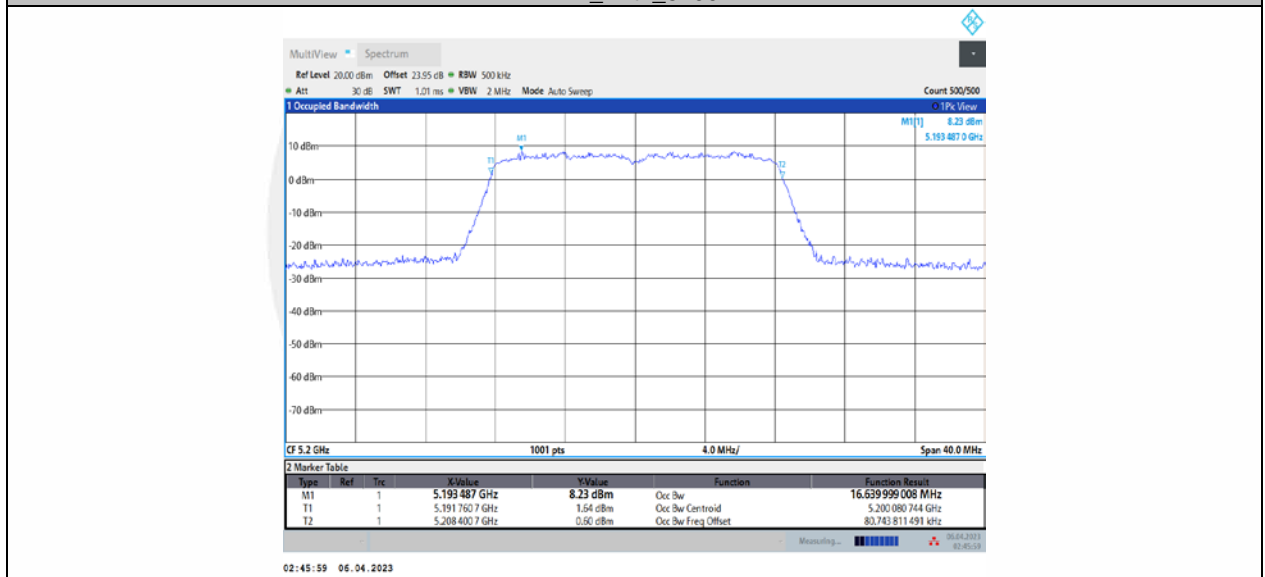

11A_Ant1_5240

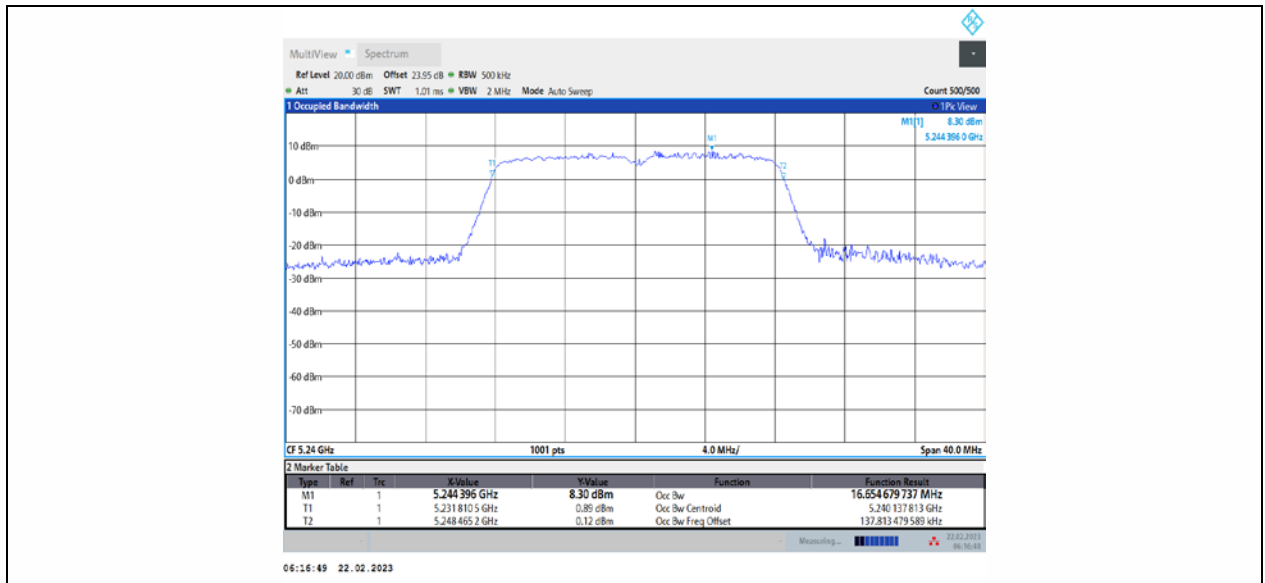

11A_Ant2_5240

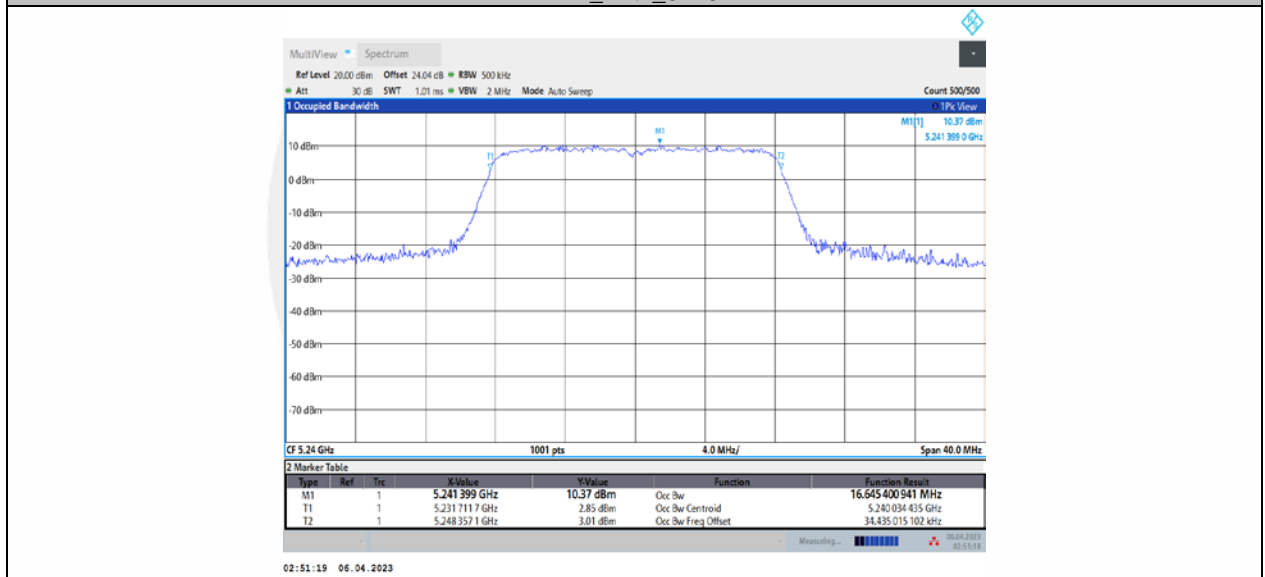

11A_Ant1_5745

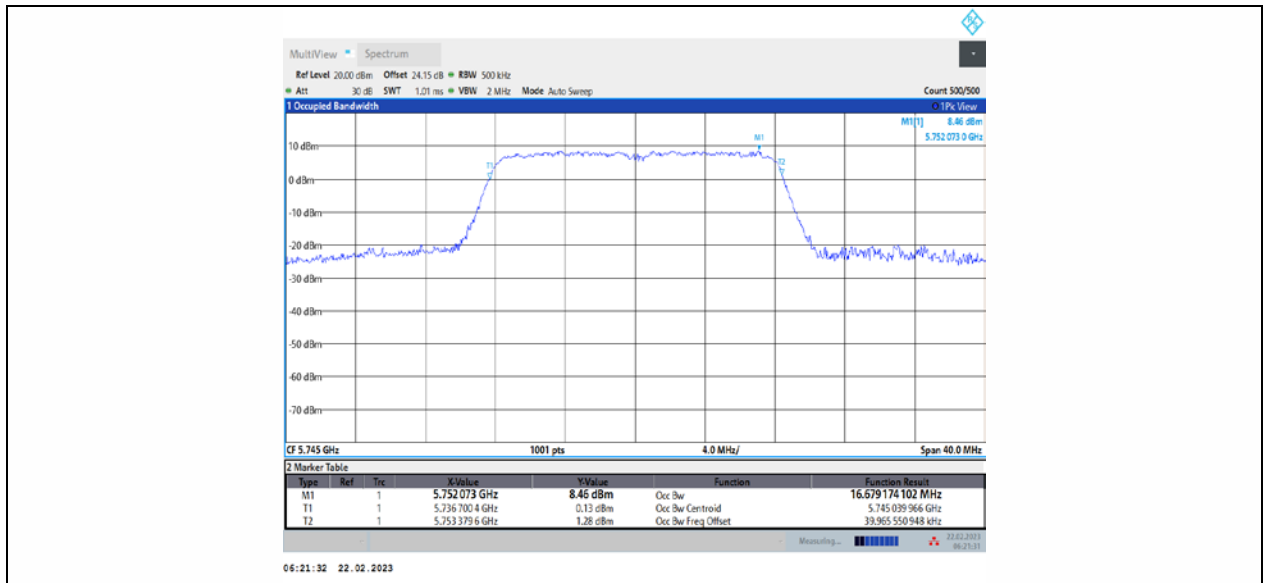

11A_Ant2_5745

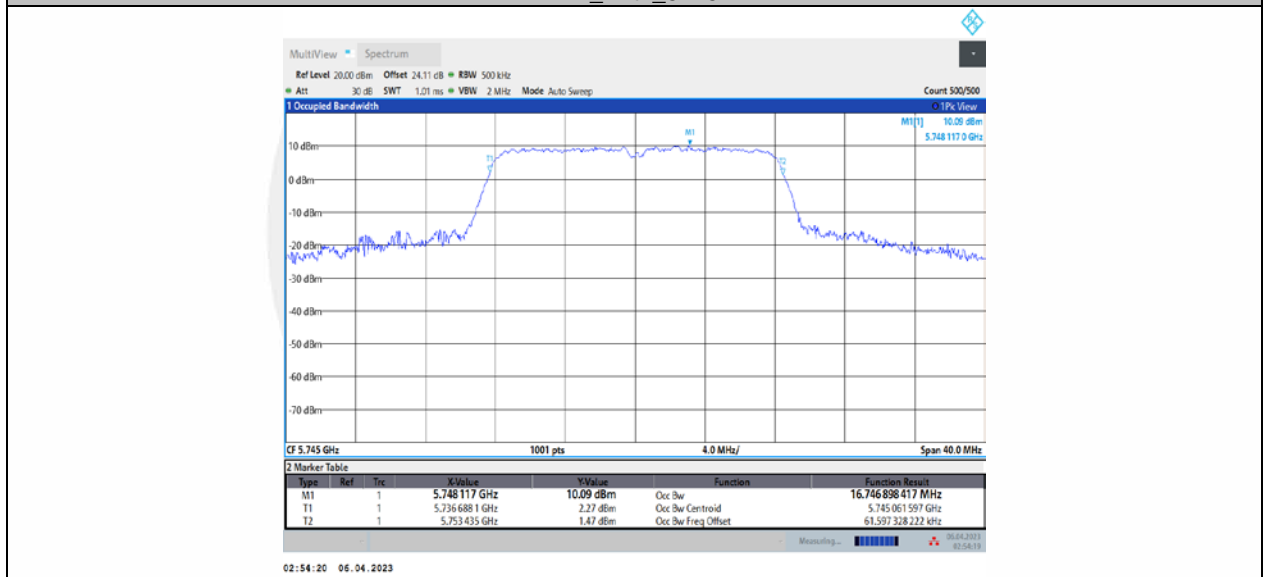

11A_Ant1_5785

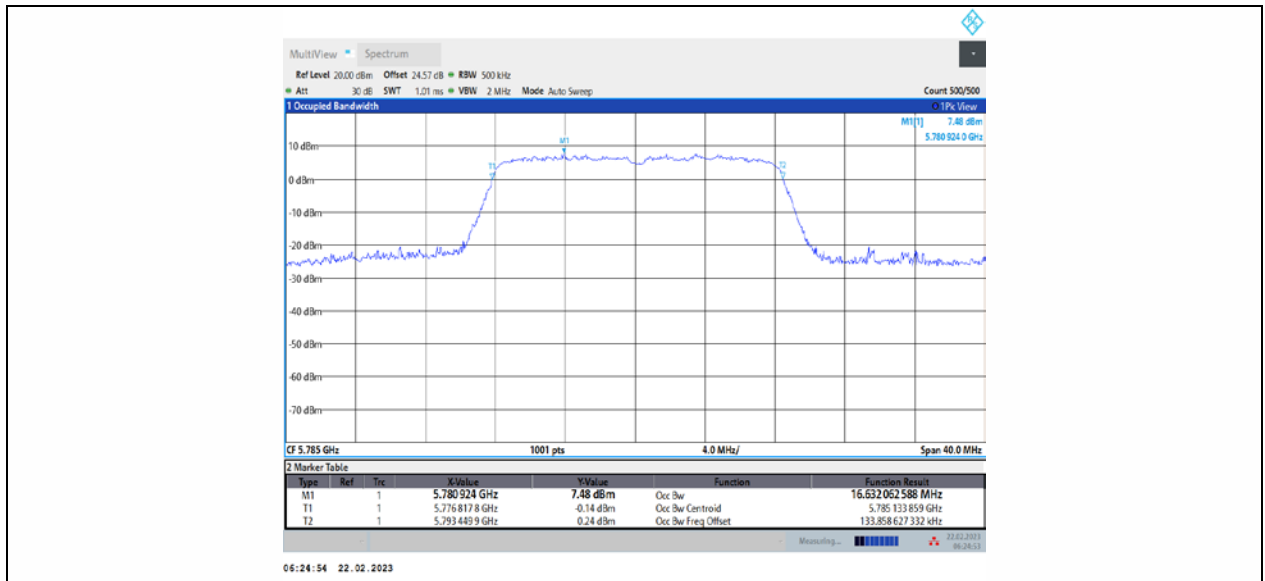

11A_Ant2_5785

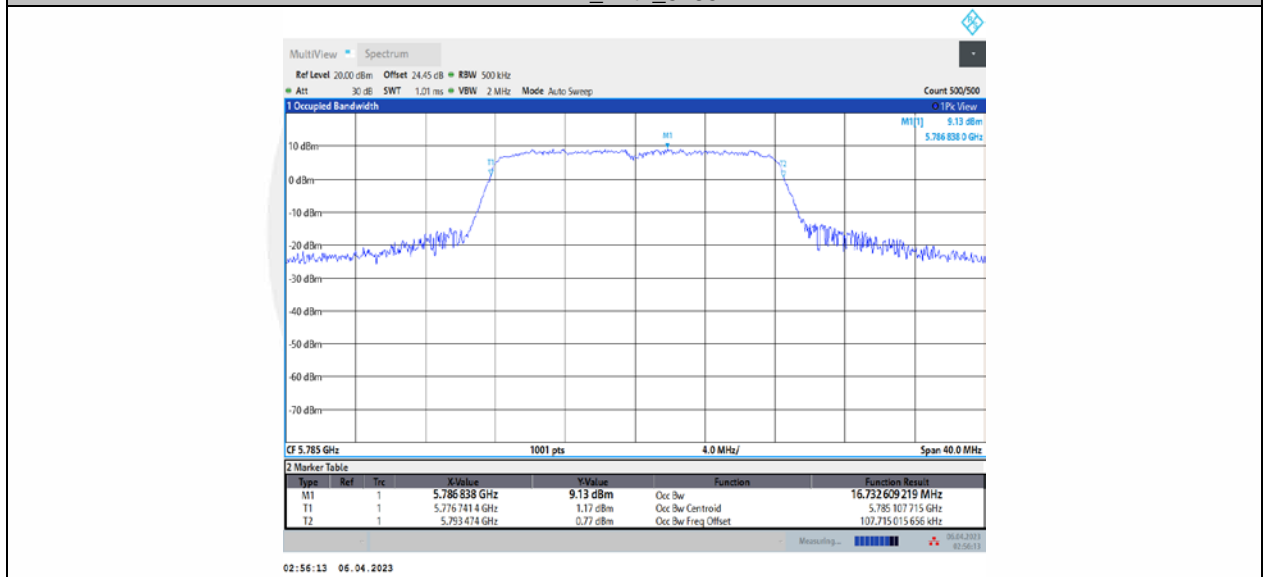

11A_Ant1_5805

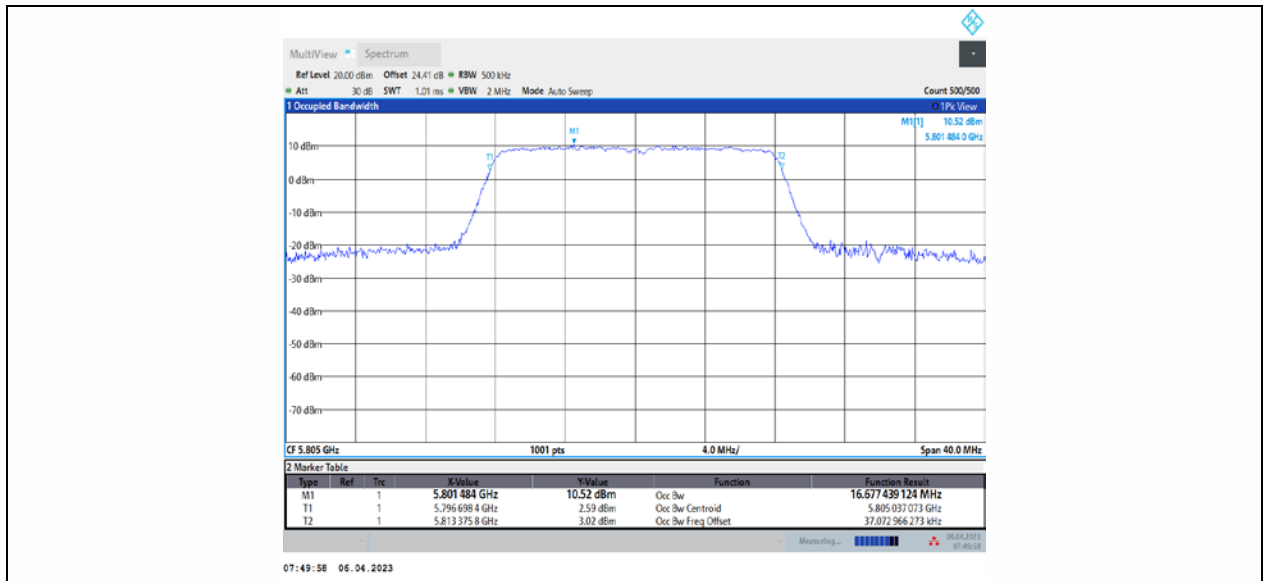

11A_Ant2_5805

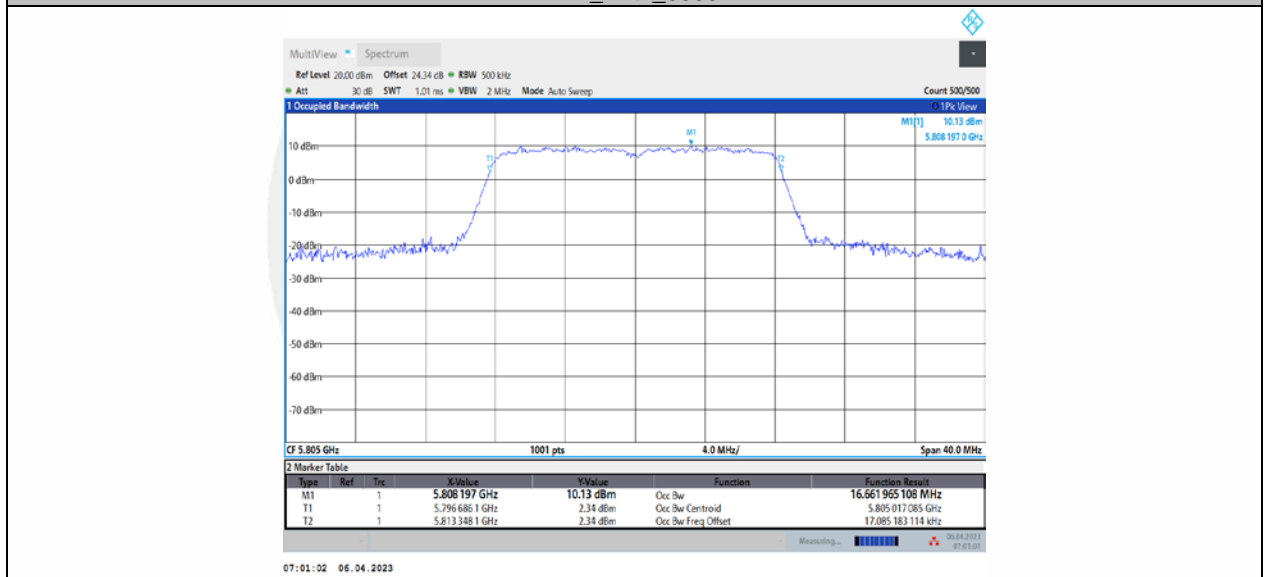

11N20MIMO_Ant1_5180

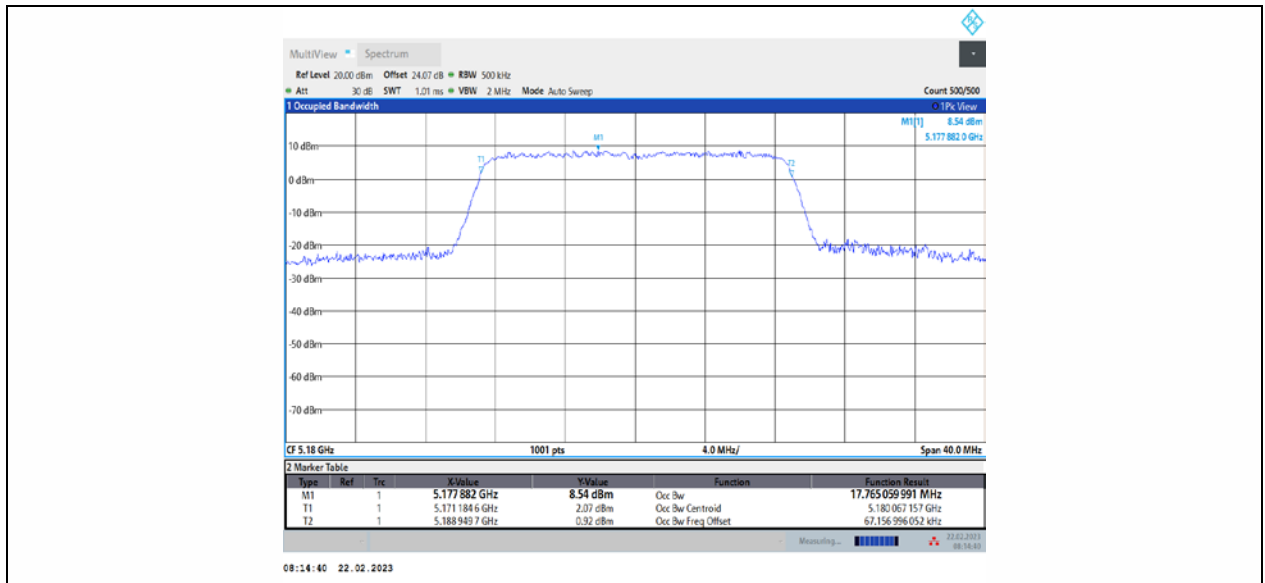

11N20MIMO_Ant2_5180

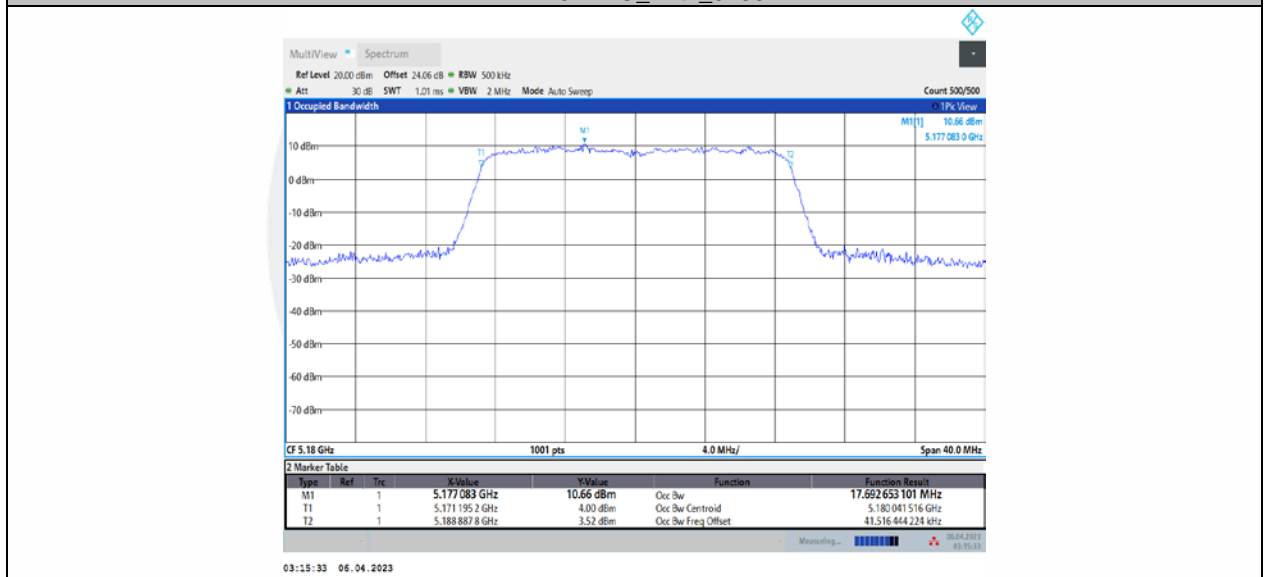

11N20MIMO_Ant1_5200

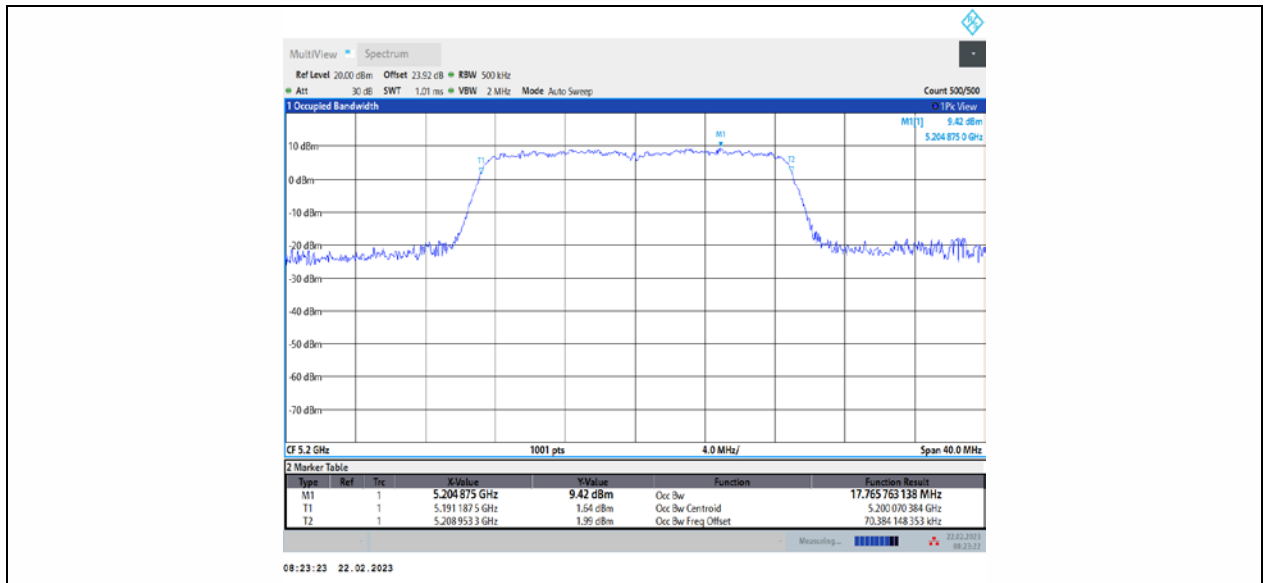

11N20MIMO_Ant2_5200

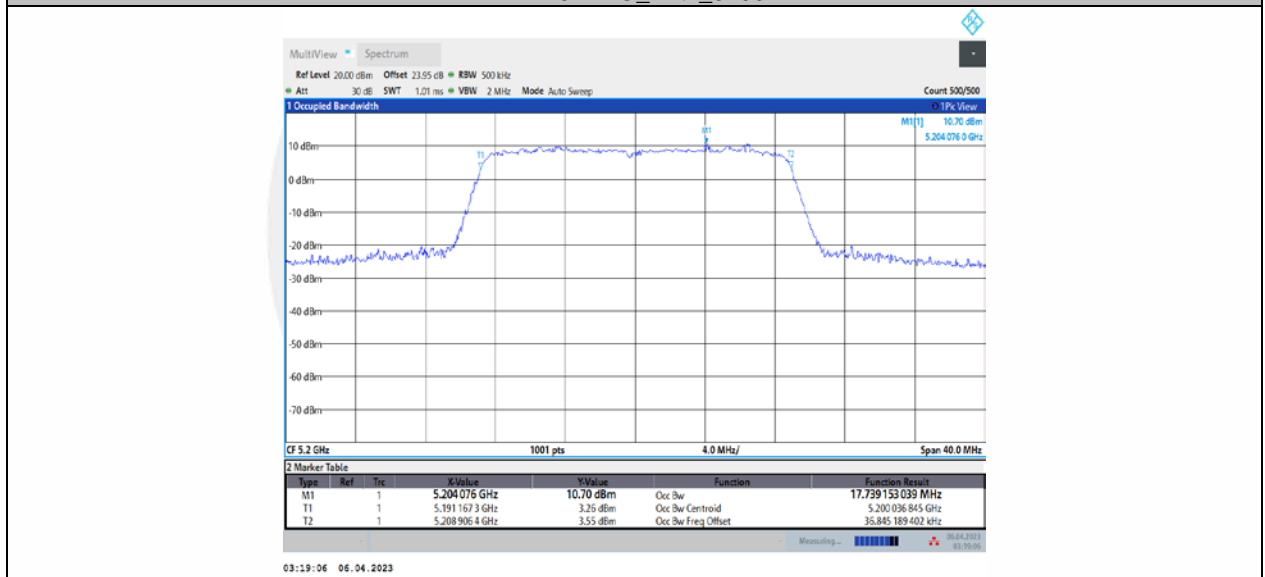

11N20MIMO_Ant1_5240

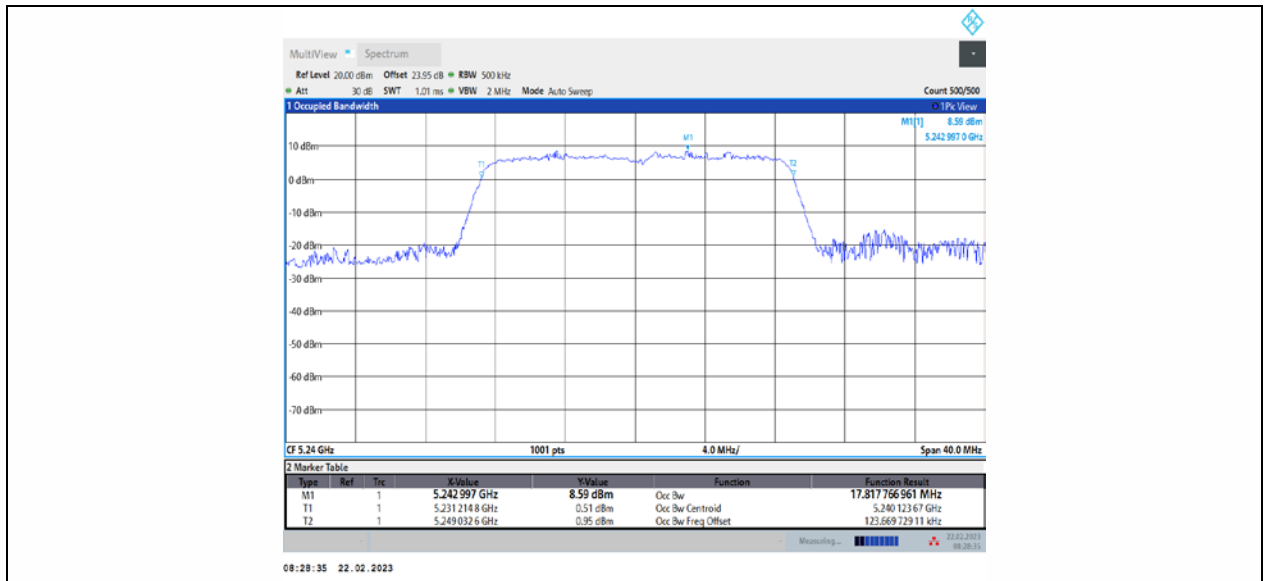

11N20MIMO_Ant2_5240

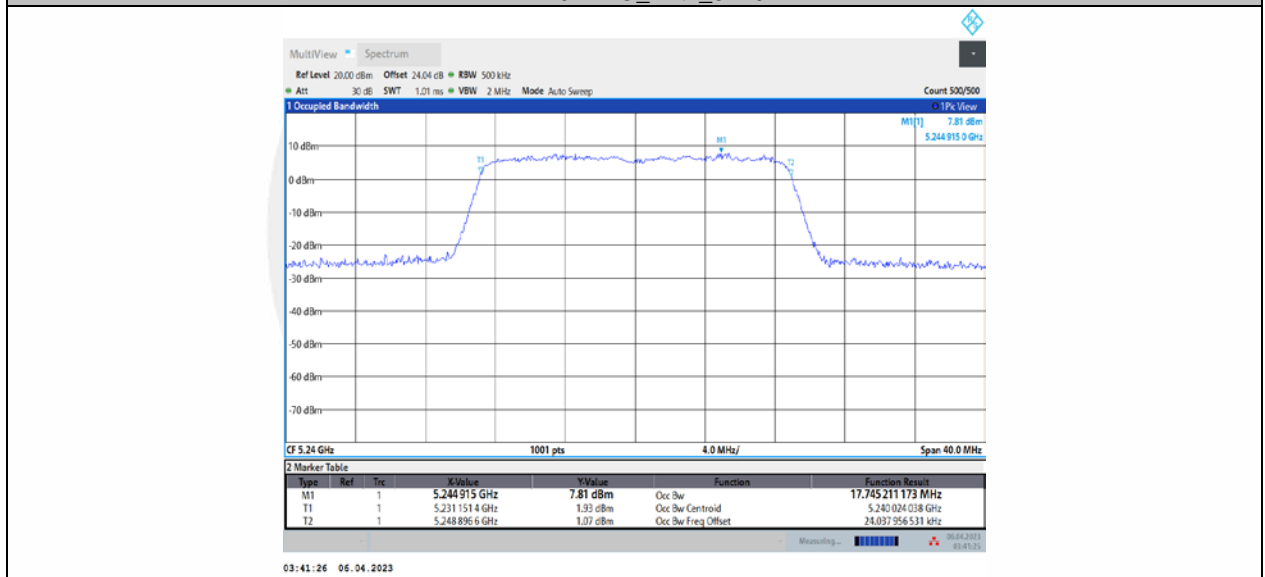

11N20MIMO_Ant1_5745

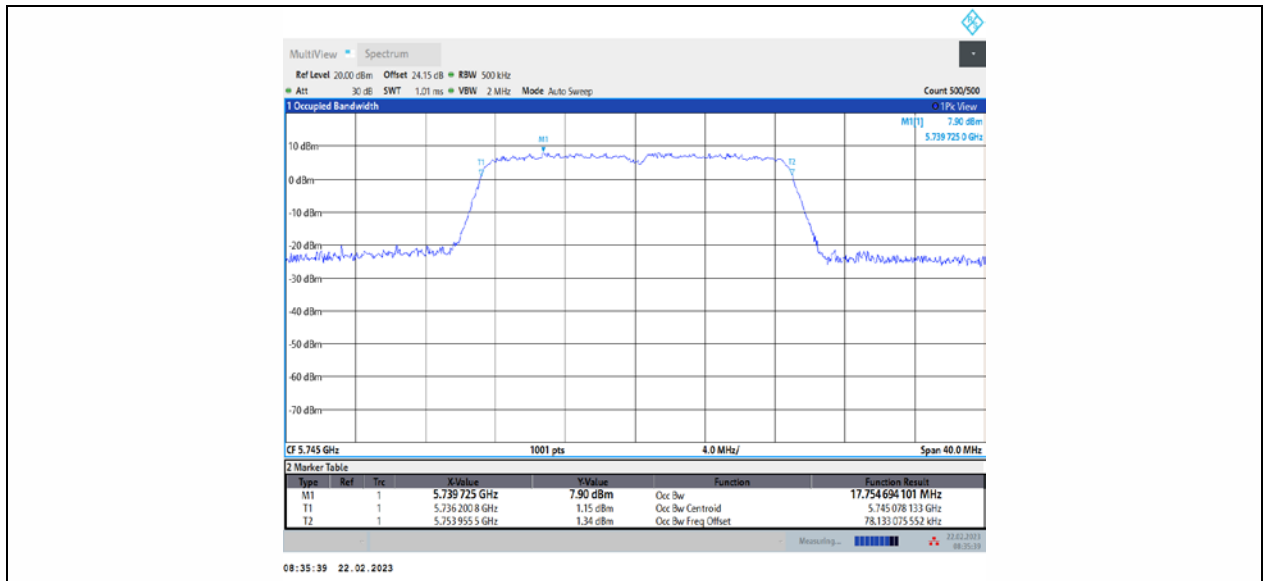

11N20MIMO_Ant2_5745

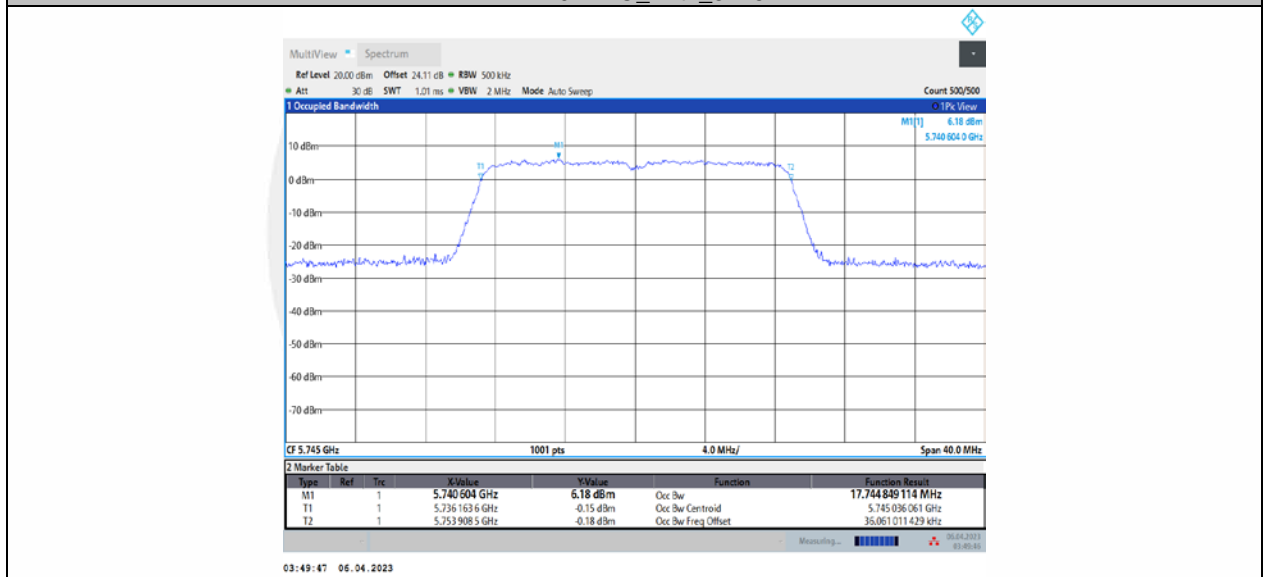

11N20MIMO_Ant1_5785

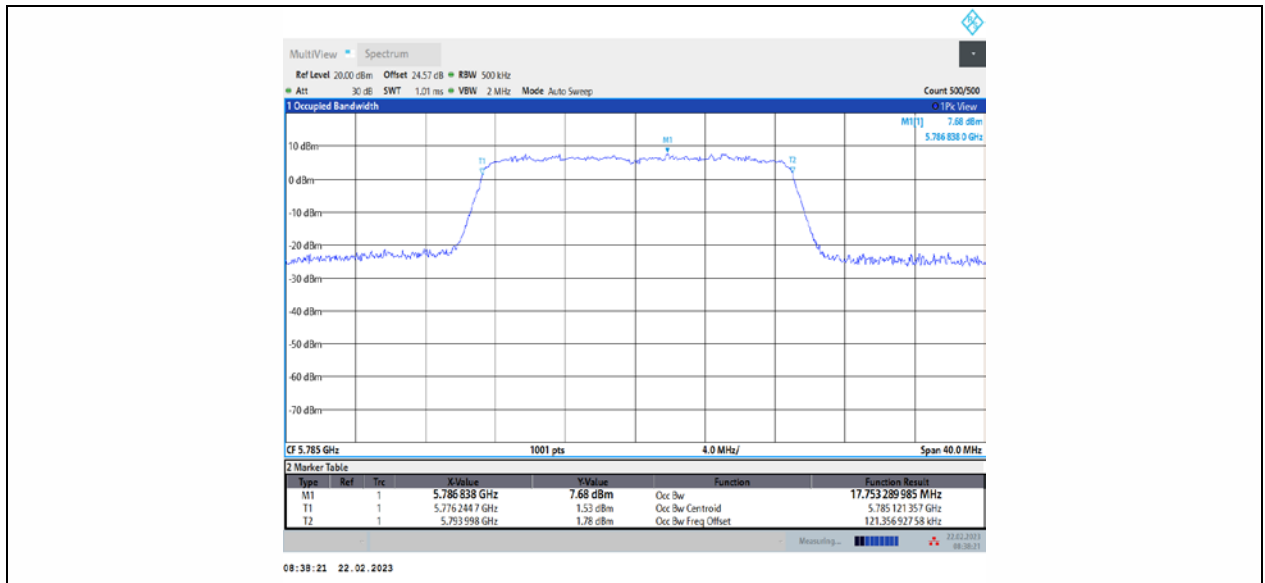

11N20MIMO_Ant2_5785

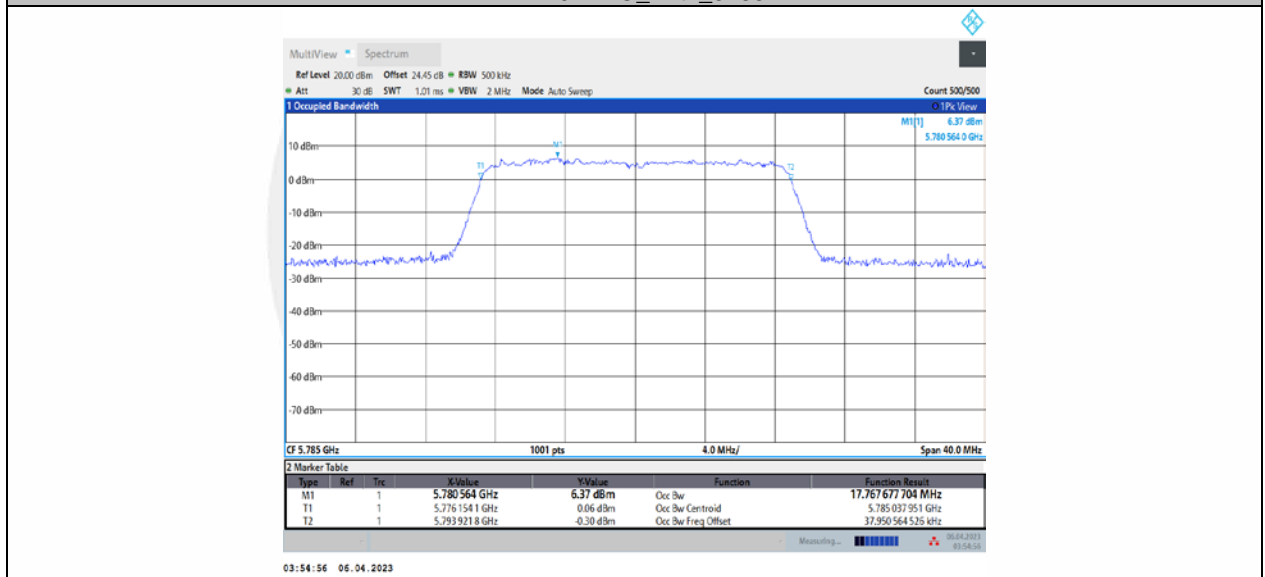

11N20MIMO_Ant1_5805

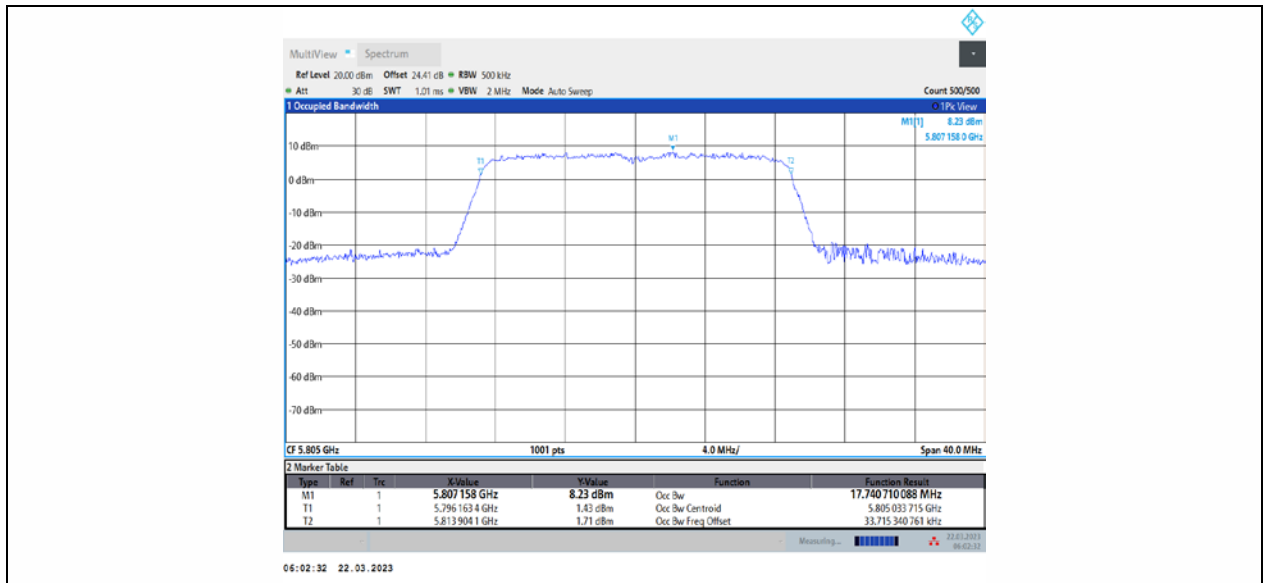

11N20MIMO_Ant2_5805

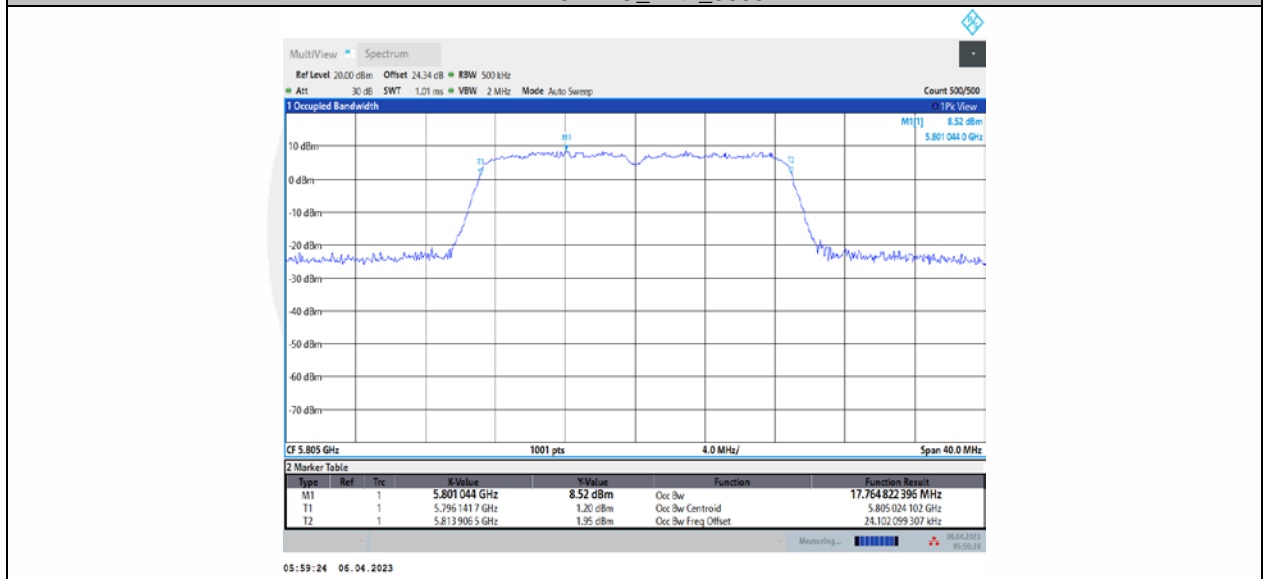

TestMode	Antenna	Frequency[MHz]	6db EBW[MHz]	FL[MHz]	FH[MHz]	Limit[MHz]	Verdict
11A	Ant1	5745	16.32	5736.88	5753.20	0.5	PASS
	Ant2	5745	16.32	5736.84	5753.16	0.5	PASS
	Ant1	5785	16.32	5776.96	5793.28	0.5	PASS
	Ant2	5785	16.32	5776.88	5793.20	0.5	PASS
	Ant1	5805	16.32	5796.84	5813.16	0.5	PASS
	Ant2	5805	16.32	5796.84	5813.16	0.5	PASS
11N20MIMO	Ant1	5745	17.56	5736.28	5753.84	0.5	PASS
	Ant2	5745	17.52	5736.24	5753.76	0.5	PASS
	Ant1	5785	17.56	5776.32	5793.88	0.5	PASS
	Ant2	5785	17.52	5776.24	5793.76	0.5	PASS
	Ant1	5805	17.56	5796.24	5813.80	0.5	PASS
	Ant2	5805	17.56	5796.24	5813.80	0.5	PASS



11A_Ant1_5745

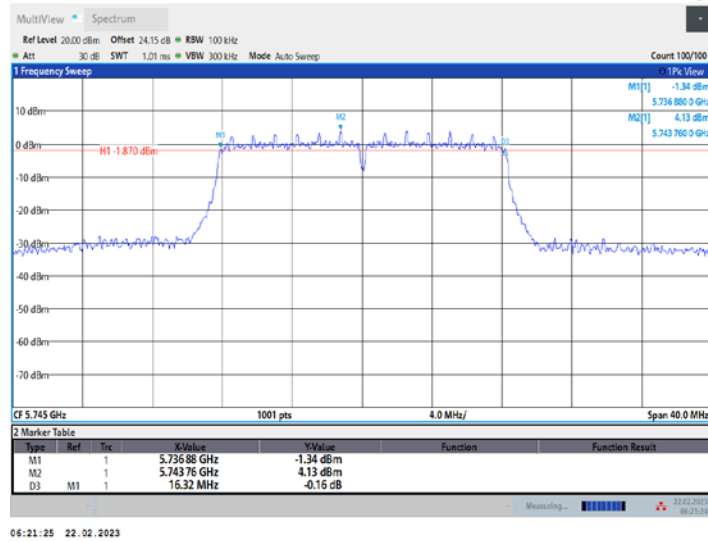

11A_Ant2_5745

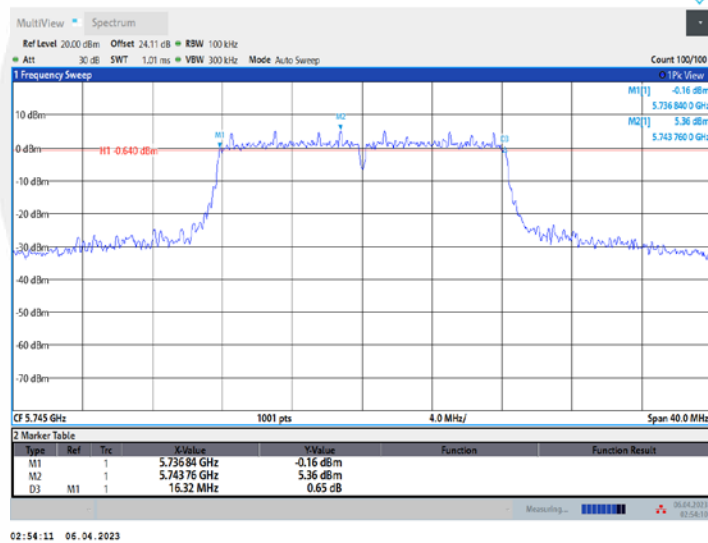

11A_Ant1_5785

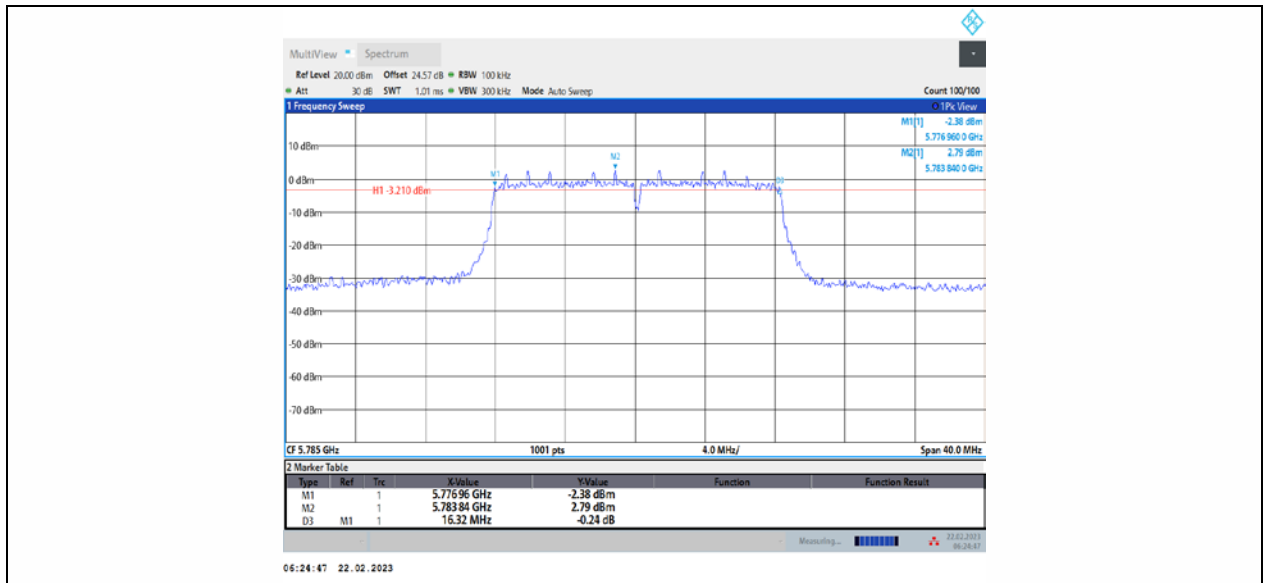

11A_Ant2_5785

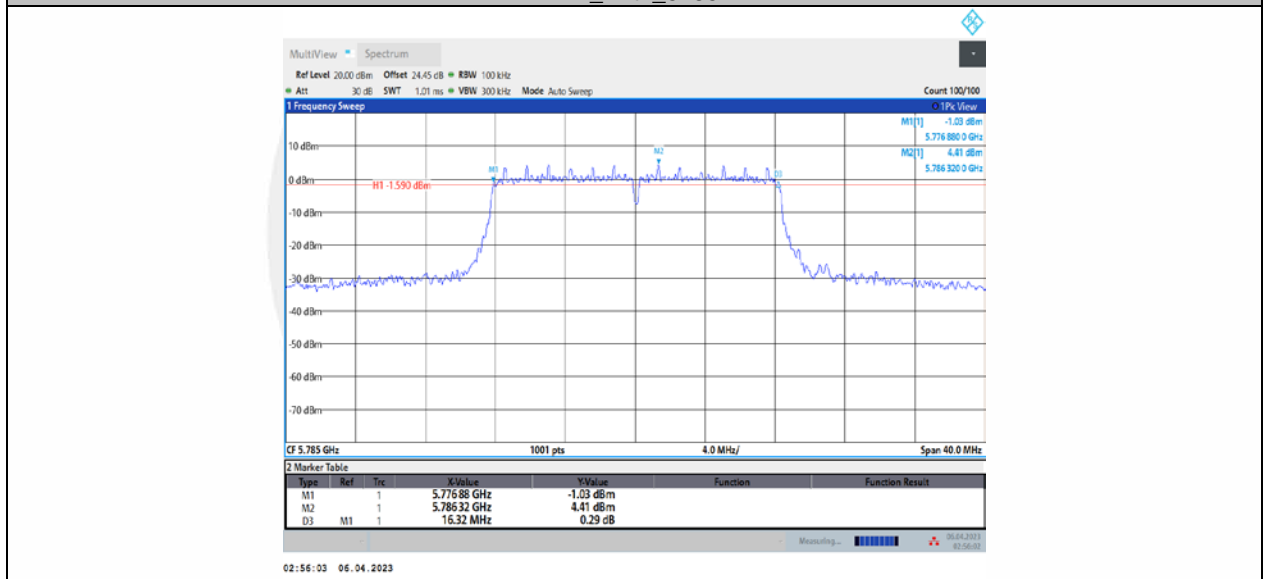

11A_Ant1_5805

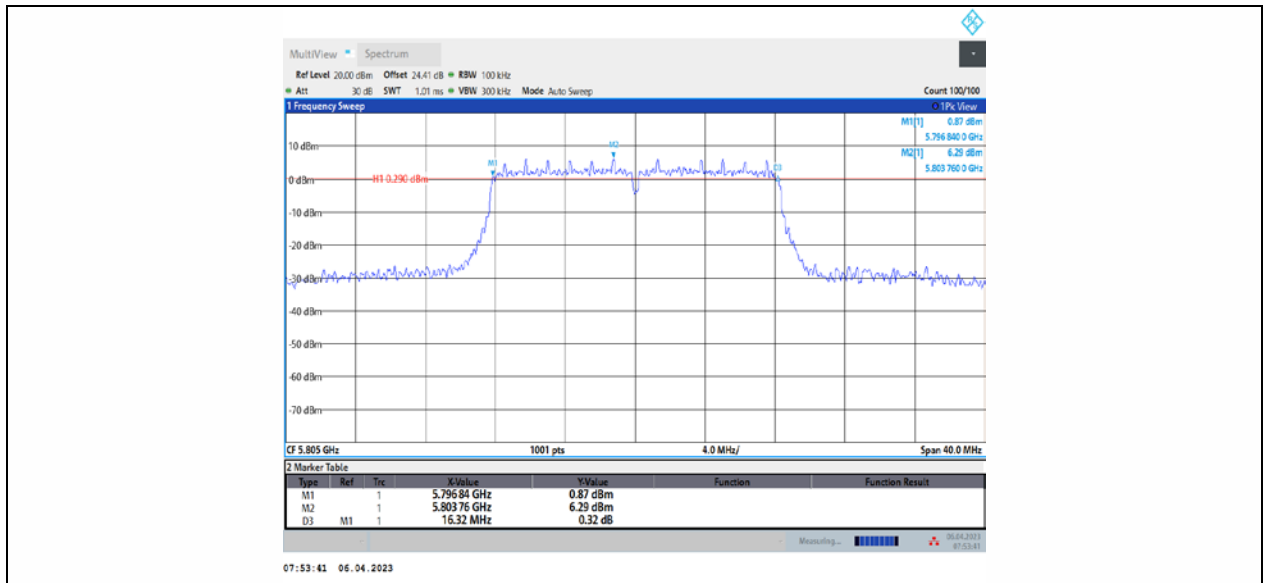

11A_Ant2_5805

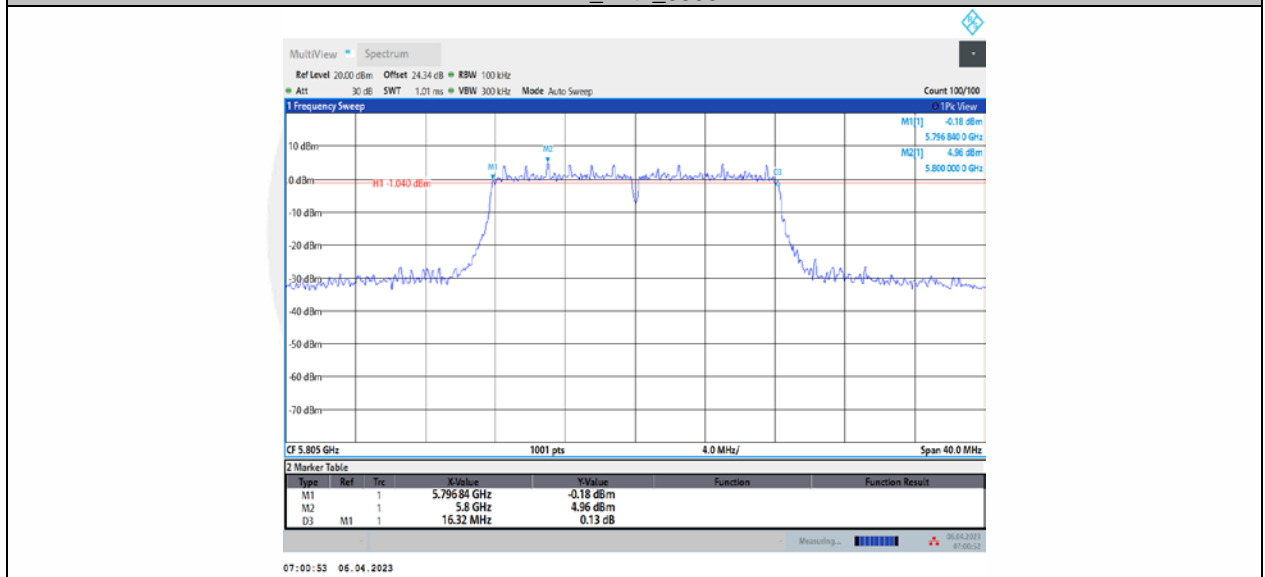

11N20MIMO_Ant1_5745

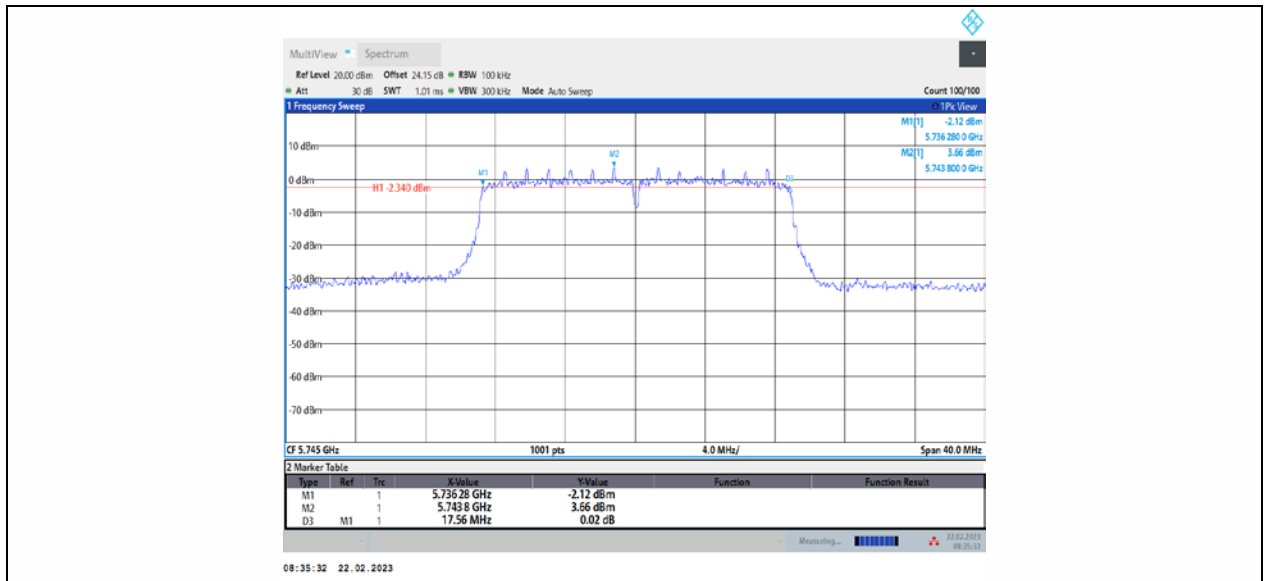

11N20MIMO_Ant2_5745

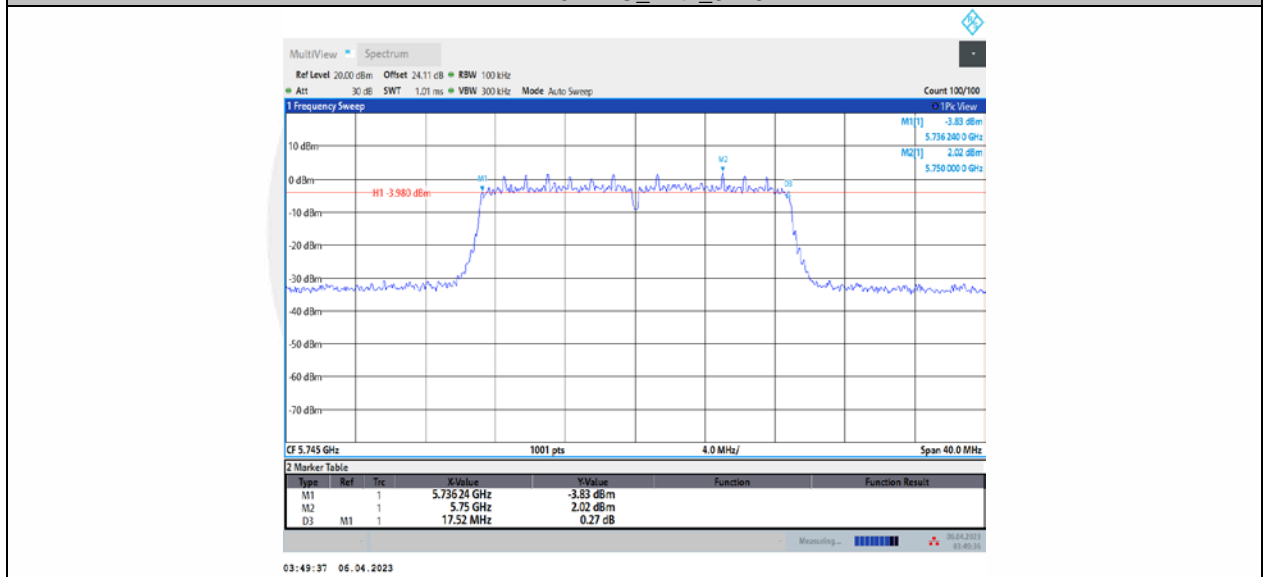

11N20MIMO_Ant1_5785

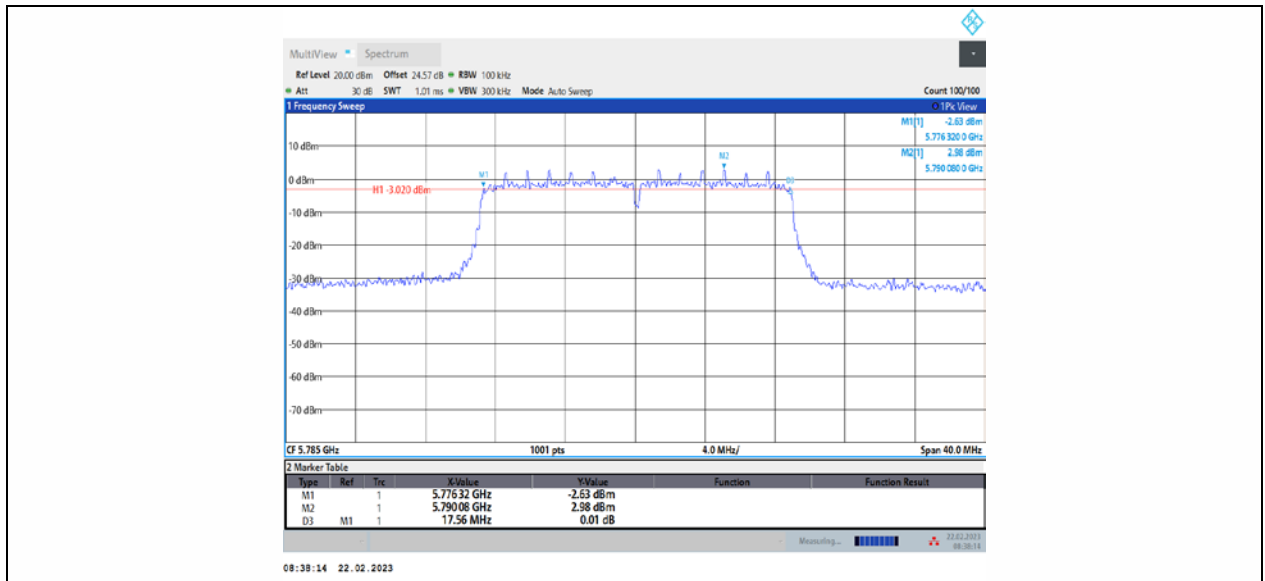

11N20MIMO_Ant2_5785

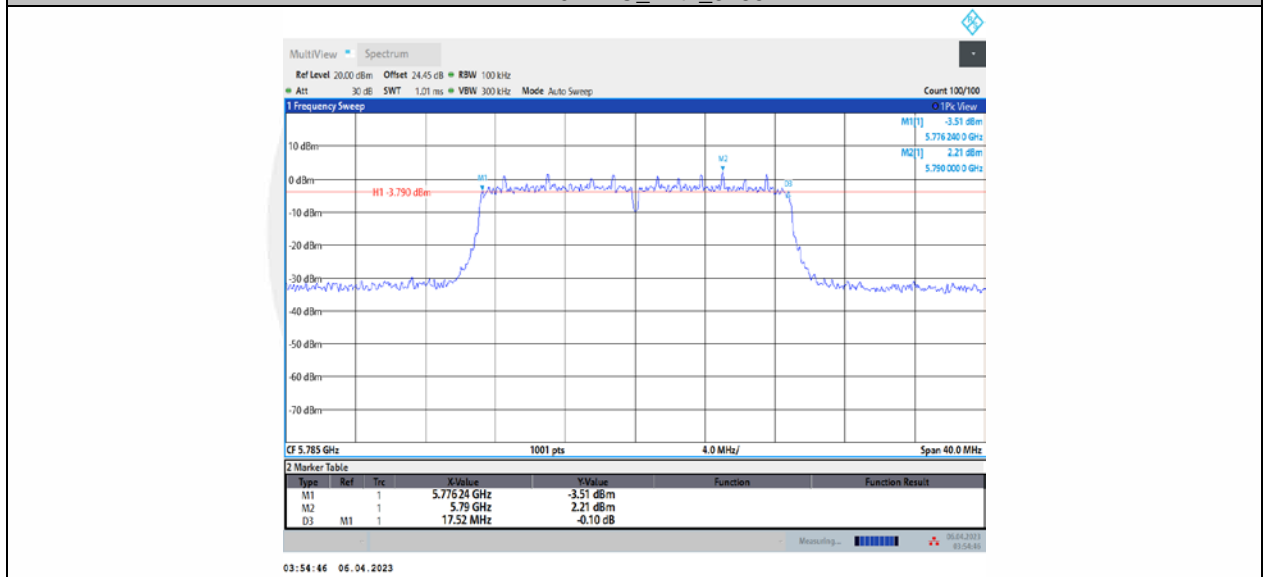

11N20MIMO_Ant1_5805

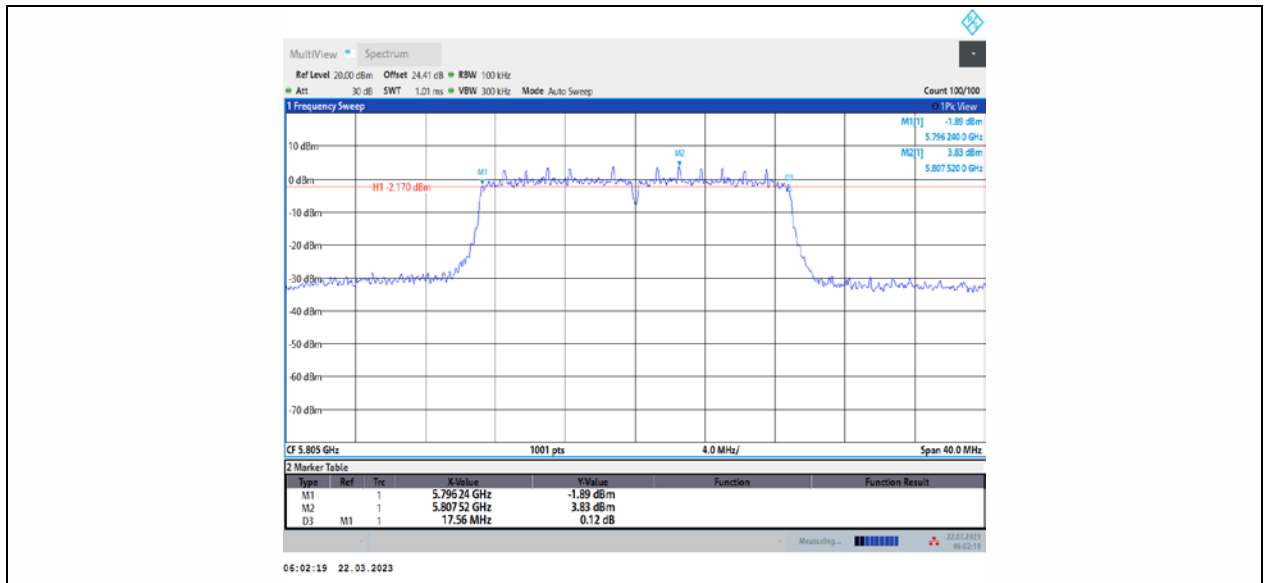

11N20MIMO_Ant2_5805

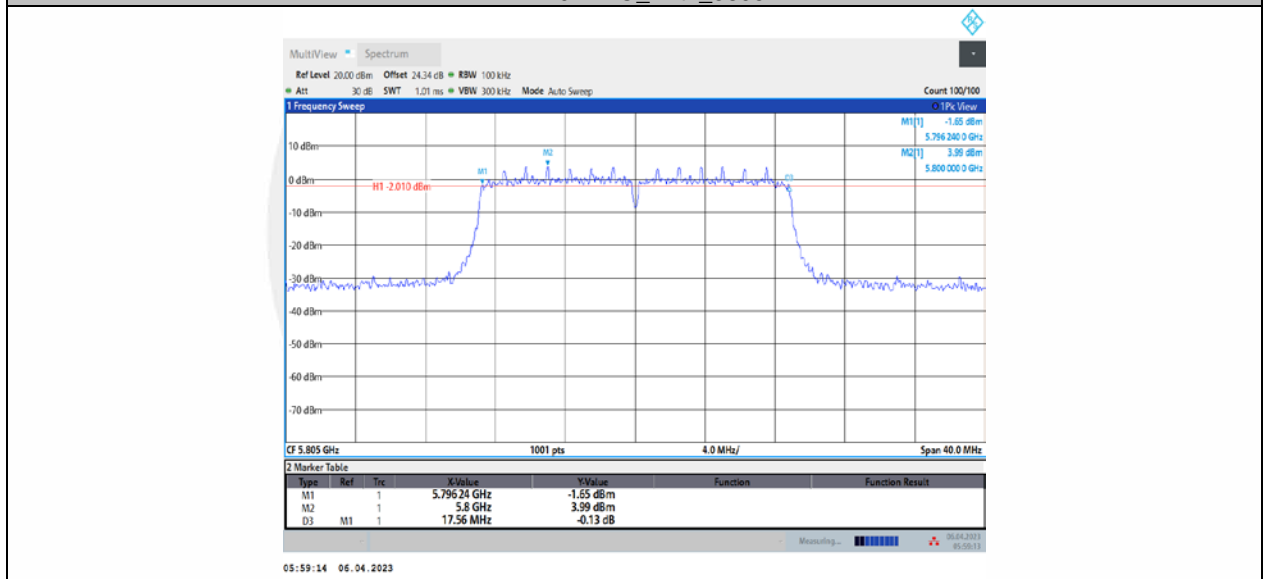

8.2 MAXIMUM CONDUCTED OUTPUT POWER

8.2.1 Applicable Standard

According to FCC Part 15.407(a)(1) for UNII Band I
According to FCC Part 15.407(a)(2) for UNII Band II-A and UNII Band II-C
According to FCC Part 15.407(a)(3) for UNII Band III
According to 789033 D02 Section II(E)

8.2.2 Conformance Limit

■ For the band 5.15-5.25 GHz,

(a) (1) (i) For an outdoor access point operating in the band 5.15-5.25 GHz, the maximum conducted output power over the frequency band of operation shall not exceed 1 W provided the maximum antenna gain does not exceed 6 dBi. In addition, the maximum power spectral density shall not exceed 17 dBm in any 1 megahertz band. If transmitting antennas of directional gain greater than 6 dBi are used, both the maximum conducted output power and the maximum power spectral density shall be reduced by the amount in dB that the directional gain of the antenna exceeds 6 dBi. The maximum e.i.r.p. at any elevation angle above 30 degrees as measured from the horizon must not exceed 125 mW (21 dBm).

(a) (1) (ii) For an indoor access point operating in the band 5.15-5.25 GHz, the maximum conducted output power over the frequency band of operation shall not exceed 1 W provided the maximum antenna gain does not exceed 6 dBi. In addition, the maximum power spectral density shall not exceed 17 dBm in any 1 megahertz band. If transmitting antennas of directional gain greater than 6 dBi are used, both the maximum conducted output power and the maximum power spectral density shall be reduced by the amount in dB that the directional gain of the antenna exceeds 6 dBi.

(a) (1) (iii) For fixed point-to-point access points operating in the band 5.15-5.25 GHz, the maximum conducted output power over the frequency band of operation shall not exceed 1 W. In addition, the maximum power spectral density shall not exceed 17 dBm in any 1 megahertz band. Fixed point-to-point U-NII devices may employ antennas with directional gain up to 23 dBi without any corresponding reduction in the maximum conducted output power or maximum power spectral density. For fixed point-to-point transmitters that employ a directional antenna gain greater than 23 dBi, a 1 dB reduction in maximum conducted output power and maximum power spectral density is required for each 1 dB of antenna gain in excess of 23 dBi. Fixed, point-to-point operations exclude the use of point-to-multipoint systems, omnidirectional applications, and multiple collocated transmitters transmitting the same information. The operator of the U-NII device, or if the equipment is professionally installed, the installer, is responsible for ensuring that systems employing high gain directional antennas are used exclusively for fixed, point-to-point operations.

(a) (1) (iv) For client devices in the 5.15-5.25 GHz band, the maximum conducted output power over the frequency band of operation shall not exceed 250 mW provided the maximum antenna gain does not exceed 6 dBi. In addition, the maximum power spectral density shall not exceed 11 dBm in any 1 megahertz band. If transmitting antennas of directional gain greater than 6 dBi are used, both the maximum conducted output power and the maximum power spectral density shall be reduced by the amount in dB that the directional gain of the antenna exceeds 6 dBi.

■ For the 5.25-5.35 GHz and 5.47-5.725 GHz bands

(a) (2) The maximum conducted output power over the frequency bands of operation shall not exceed the lesser of 250 mW or $11 \text{ dBm} + 10 \log B$, where B is the 26 dB emission bandwidth in megahertz. In addition, the maximum power spectral density shall not exceed 11 dBm in any 1 megahertz band. If transmitting antennas of directional gain greater than 6 dBi are used, both the maximum conducted output power and the maximum power spectral density shall be reduced by the amount in dB that the directional gain of the antenna exceeds 6 dBi.

■ For the band 5.725-5.85 GHz

(a) (3) for the band 5.725-5.85 GHz, the maximum conducted output power over the frequency band of operation shall not exceed 1 W. In addition, the maximum power spectral density shall not exceed 30

dBm in any 500-kHz band. If transmitting antennas of directional gain greater than 6 dBi are used, both the maximum conducted output power and the maximum power spectral density shall be reduced by the amount in dB that the directional gain of the antenna exceeds 6 dBi. However, fixed point-to-point U-NII devices operating in this band may employ transmitting antennas with directional gain greater than 6 dBi without any corresponding reduction in transmitter conducted power. Fixed, point-to-point operations exclude the use of point-to-multipoint systems, omnidirectional applications, and multiple collocated transmitters transmitting the same information. The operator of the U-NII device, or if the equipment is professionally installed, the installer, is responsible for ensuring that systems employing high gain directional antennas are used exclusively for fixed, point-to-point operations

8.2.3 Test Configuration

Test according to clause 6.1 radio frequency test setup

8.2.4 Test Procedure

The maximum average conducted output power can be measured using Method PM-G (Measurement using a gated RF average power meter):

Measurements may be performed using a wideband gated RF power meter provided that the gate parameters are adjusted such that the power is measured only when the EUT is transmitting at its maximum power control level. Since the measurement is made only during the ON time of the transmitter, no duty cycle correction factor is required.

- a. The Transmitter output (antenna port) was connected to the power meter.
- b. Turn on the EUT and power meter and then record the power value.
- c. Repeat above procedures on all channels needed to be tested.

8.2.5 Test Results

TestMode	Antenna	Frequency[MHz]	TransmissionDuration [ms]	Transmission Period [ms]	Duty Cycle [%]
11A	Ant1	5180	2.07	2.71	76.38
	Ant2	5180	2.07	2.24	92.41
	Ant1	5200	2.07	2.28	90.79
	Ant2	5200	2.06	2.25	91.56
	Ant1	5240	2.06	2.29	89.96
	Ant2	5240	2.06	2.26	91.15
	Ant1	5745	2.06	2.25	91.56
	Ant2	5745	2.06	2.28	90.35
	Ant1	5785	2.06	2.25	91.56
	Ant2	5785	2.06	2.24	91.96
	Ant1	5805	2.07	2.30	90.00
	Ant2	5805	2.06	2.29	89.96
11N20MIMO	Ant1	5180	1.92	2.10	91.43
	Ant2	5180	1.92	2.14	89.72
	Ant1	5200	1.92	2.17	88.48
	Ant2	5200	1.92	2.17	88.48
	Ant1	5240	1.92	2.14	89.72
	Ant2	5240	1.92	2.18	88.07
	Ant1	5745	1.92	2.18	88.07
	Ant2	5745	1.92	2.12	90.57
	Ant1	5785	1.92	2.17	88.48
	Ant2	5785	2.07	2.27	91.19
	Ant1	5805	1.92	2.14	89.72
	Ant2	5805	1.92	2.15	89.30

11A_Ant1_5180

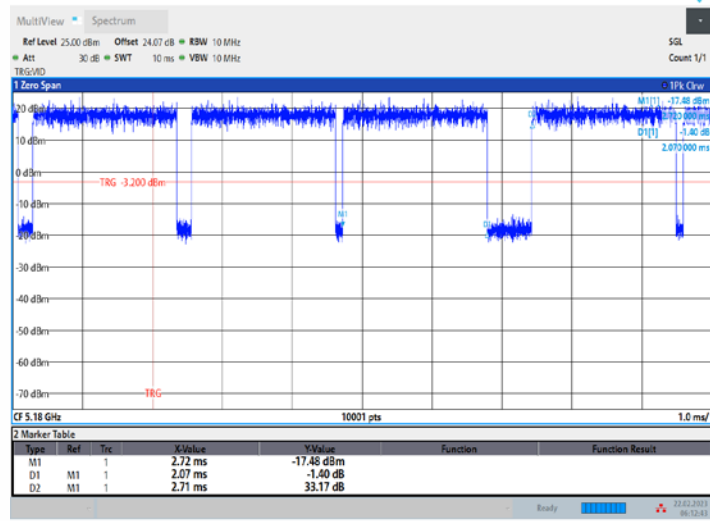

06:12:44 22.02.2023

11A_Ant2_5180

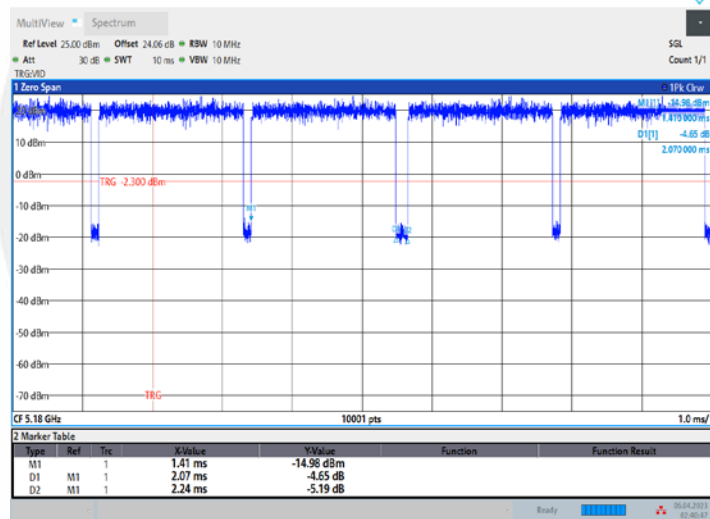

02:40:47 06.04.2023

11A_Ant1_5200

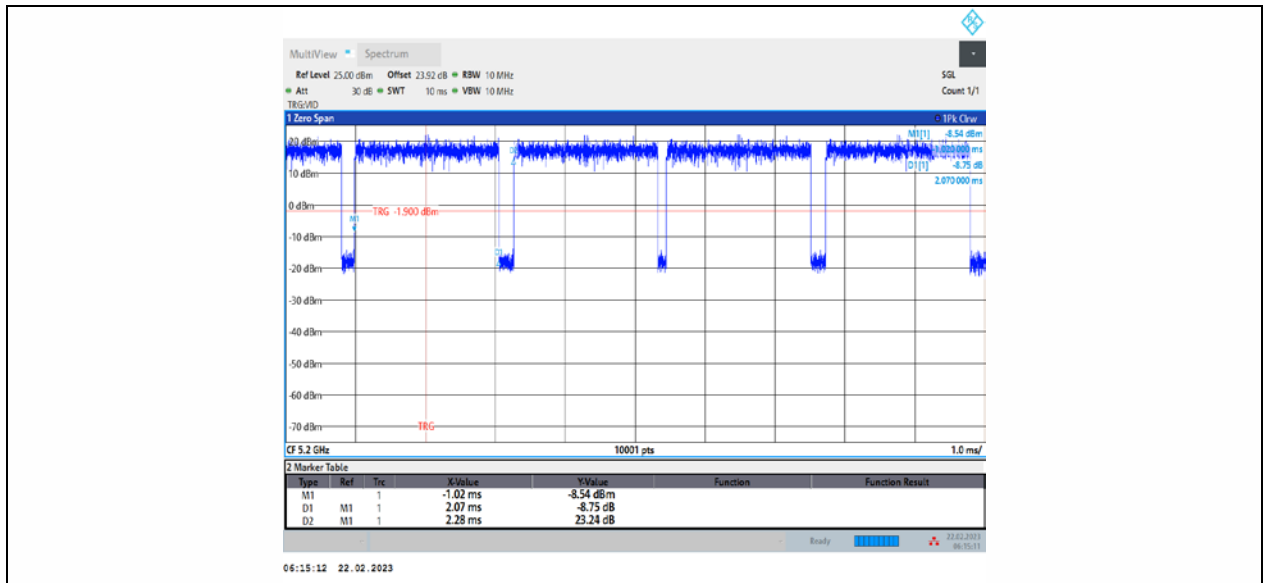

11A_Ant2_5200

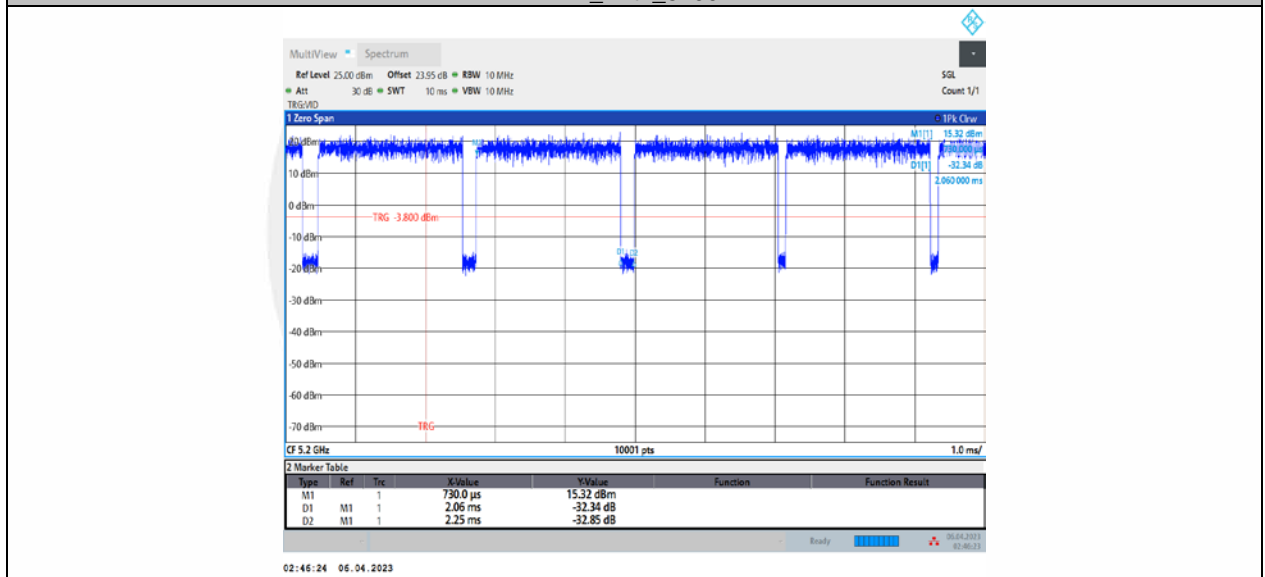

11A_Ant1_5240

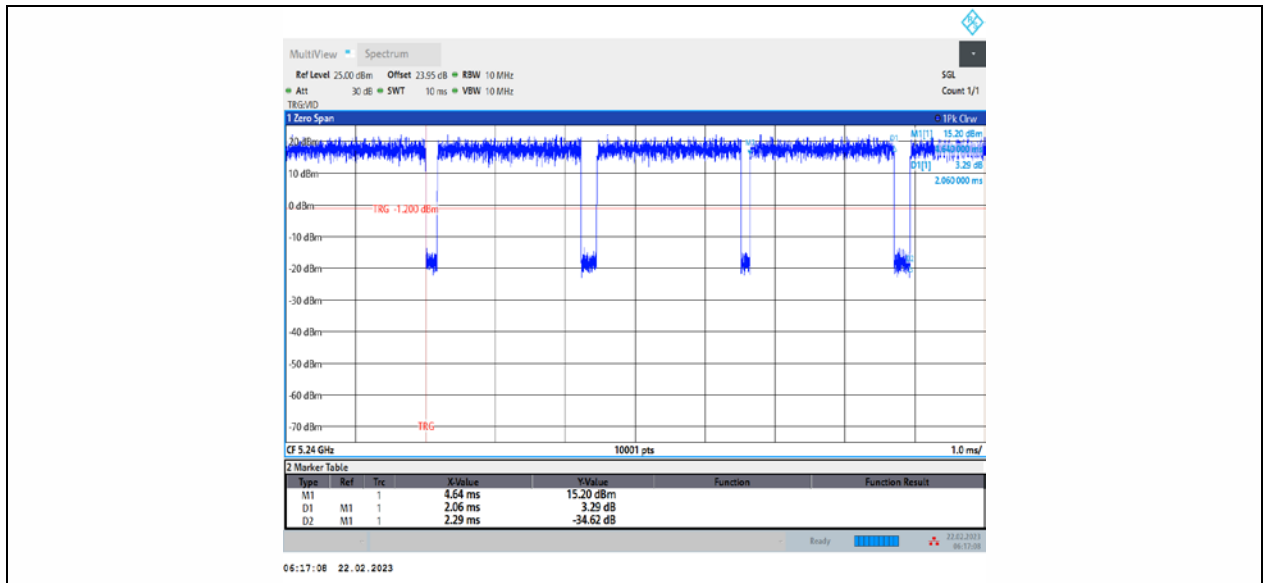

11A_Ant2_5240

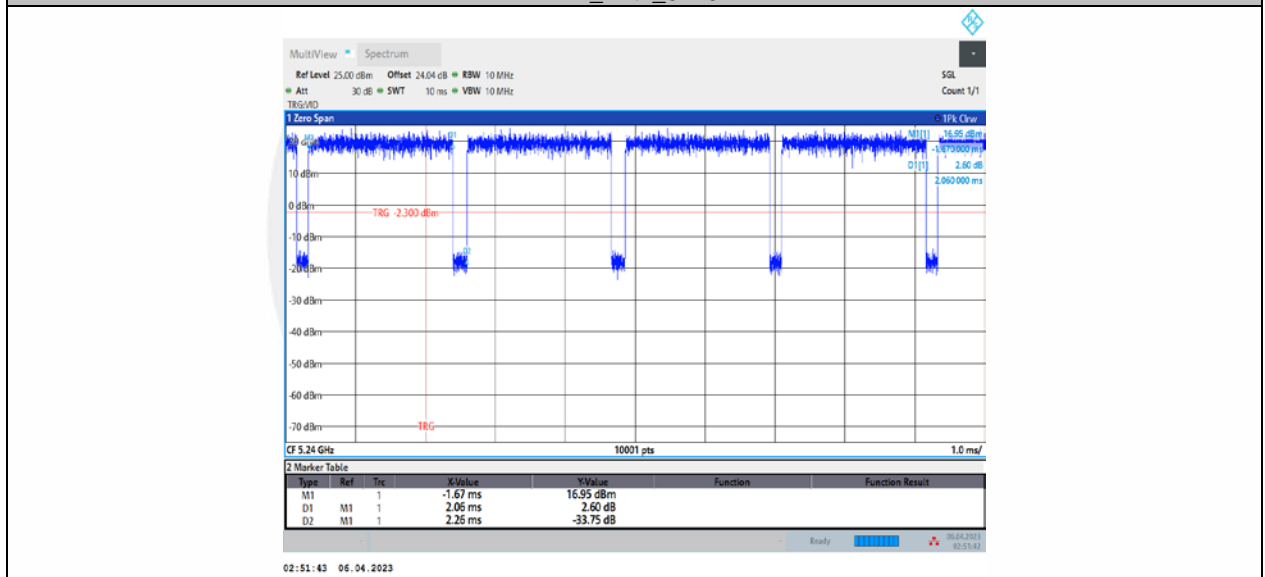

11A_Ant1_5745

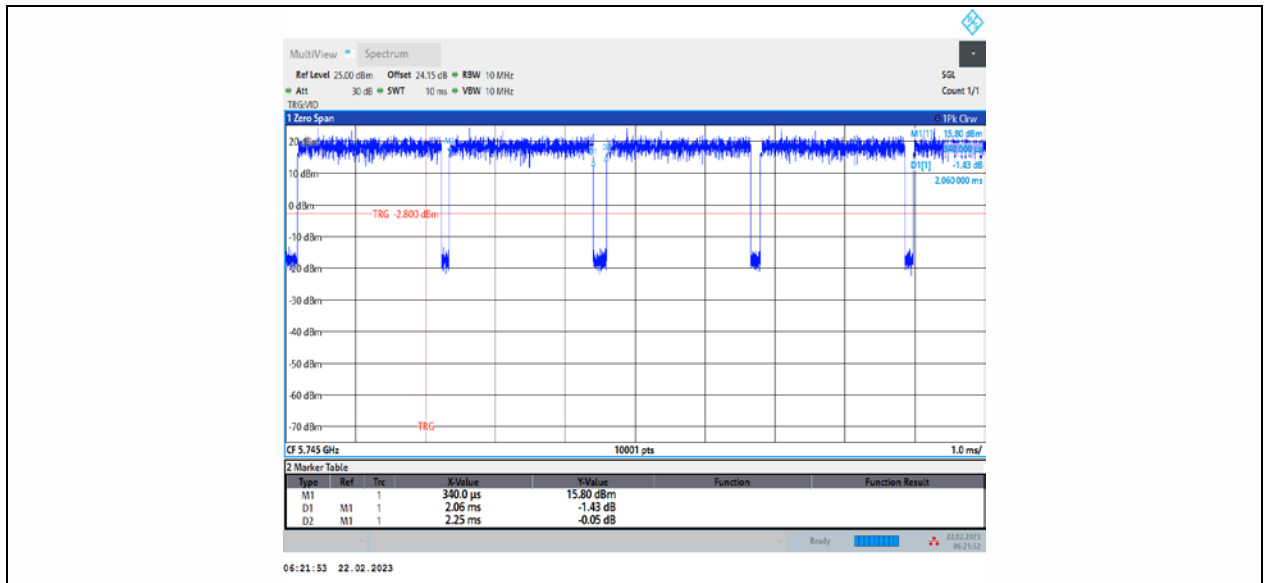

11A_Ant2_5745

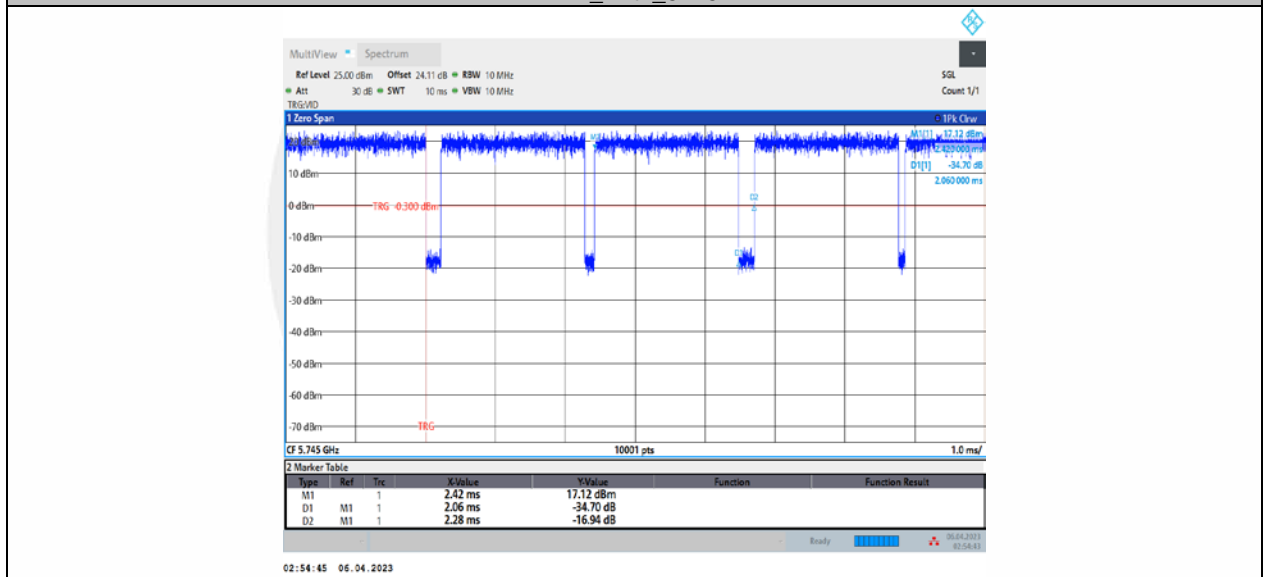

11A_Ant1_5785

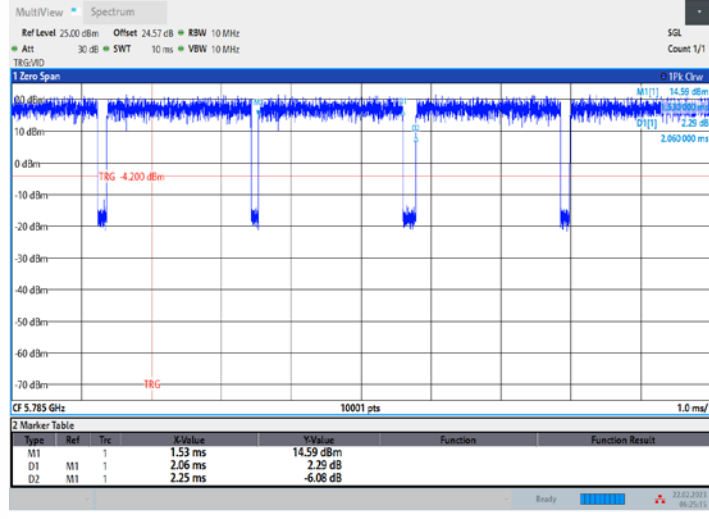

06:25:15 22. 02. 2023

11A_Ant2_5785

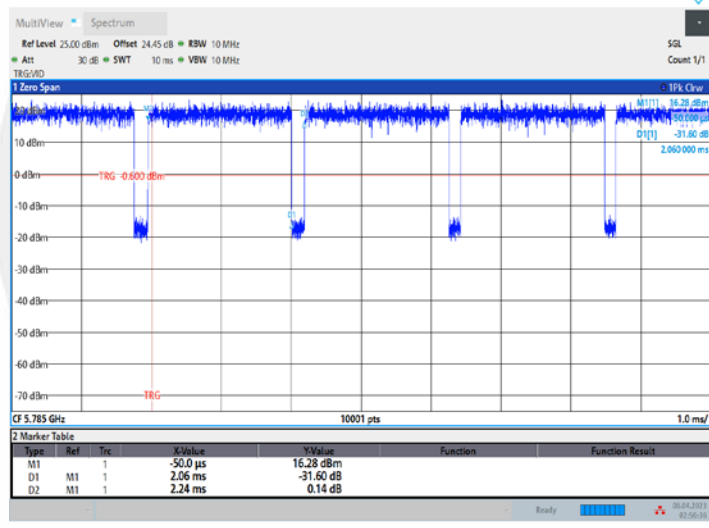

02:56:37 05. 04. 2023

11A_Ant1_5805

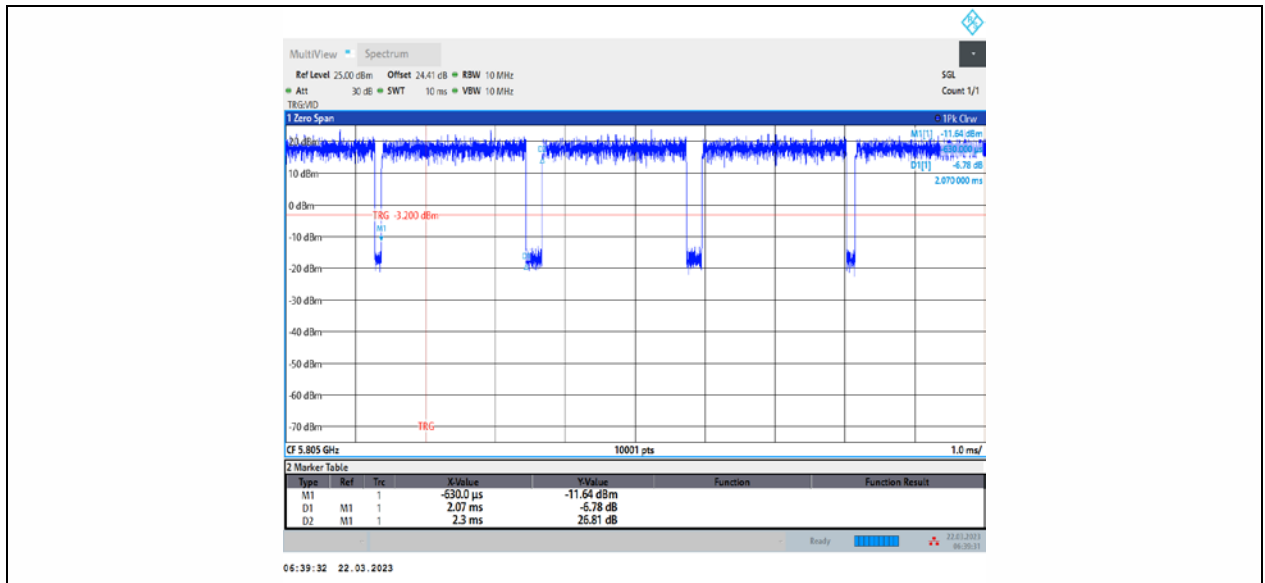

11A_Ant2_5805

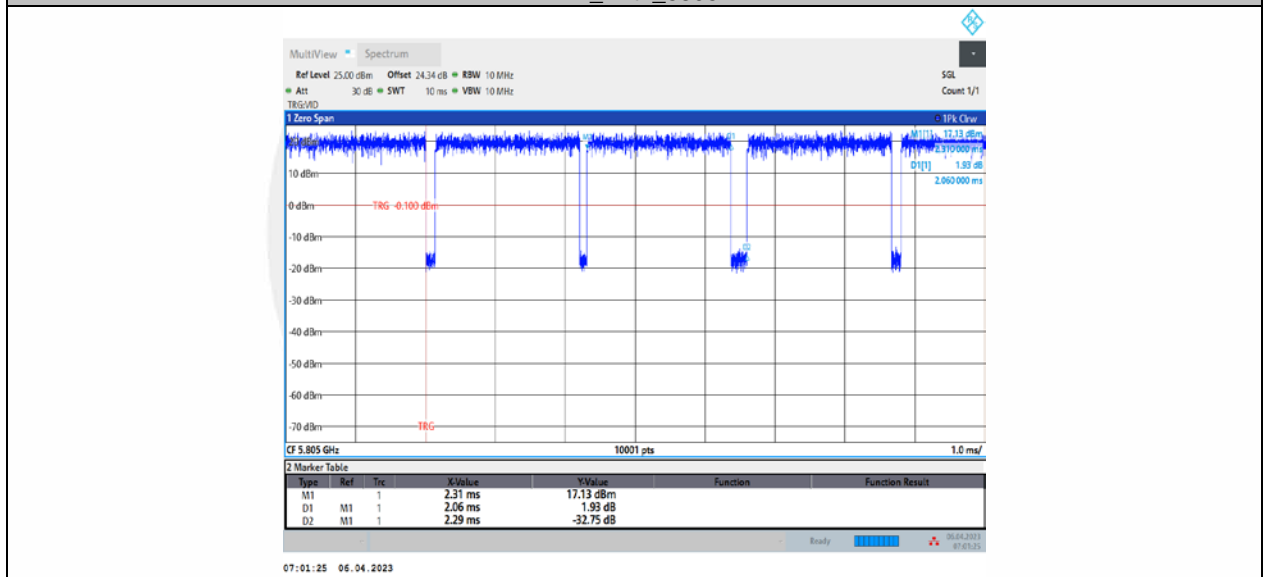

11N20MIMO_Ant1_5180

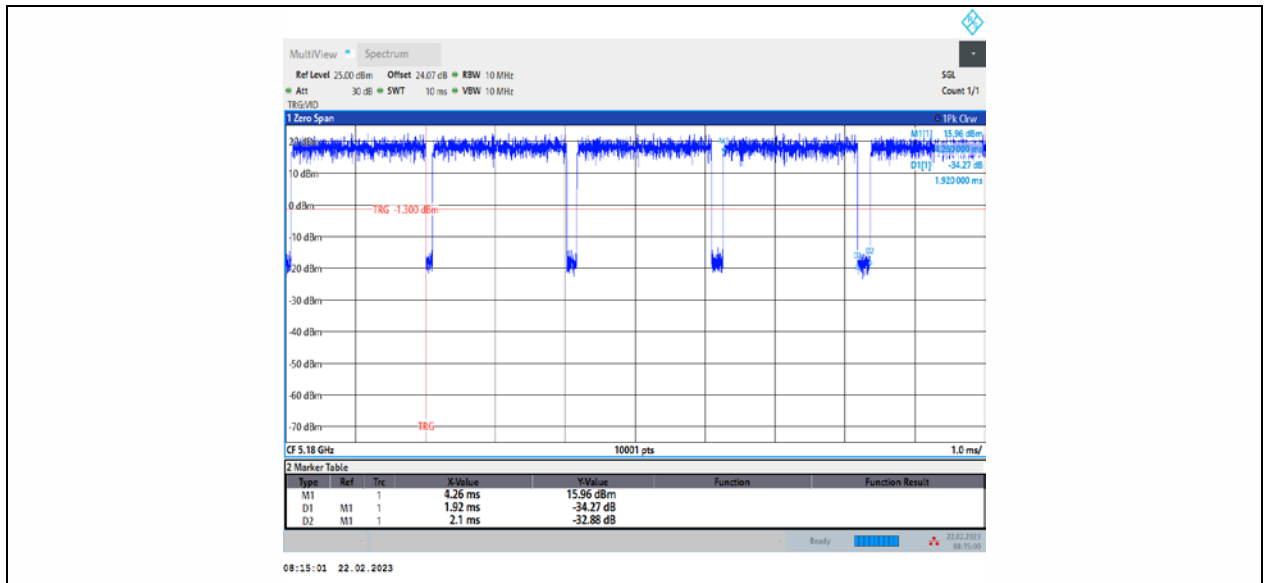

11N20MIMO_Ant2_5180

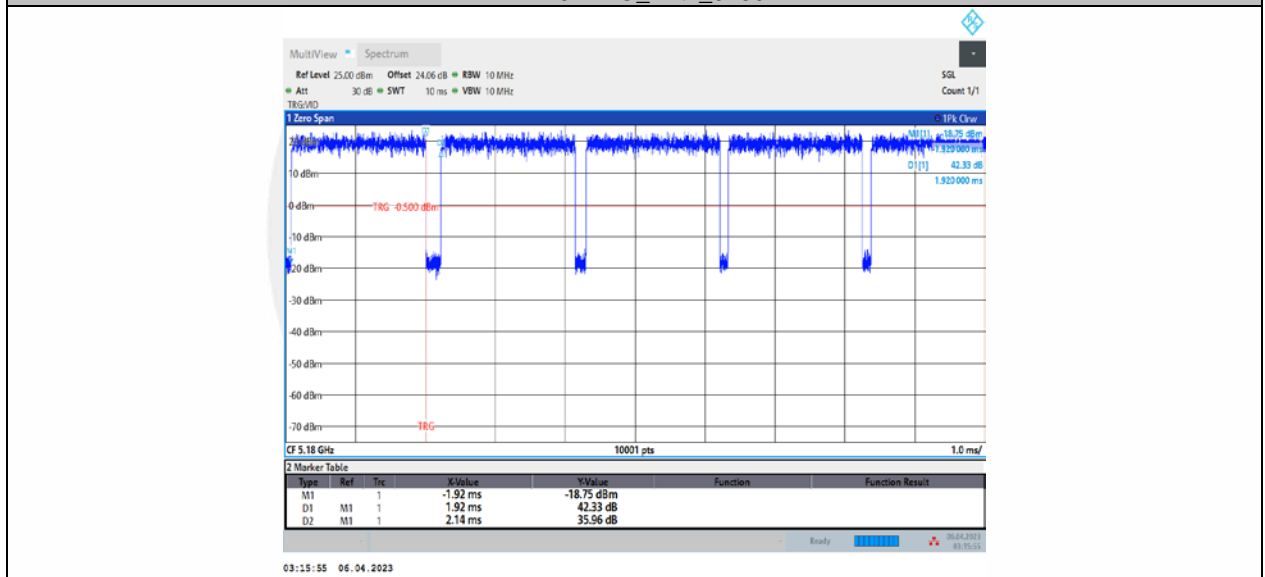

11N20MIMO_Ant1_5200

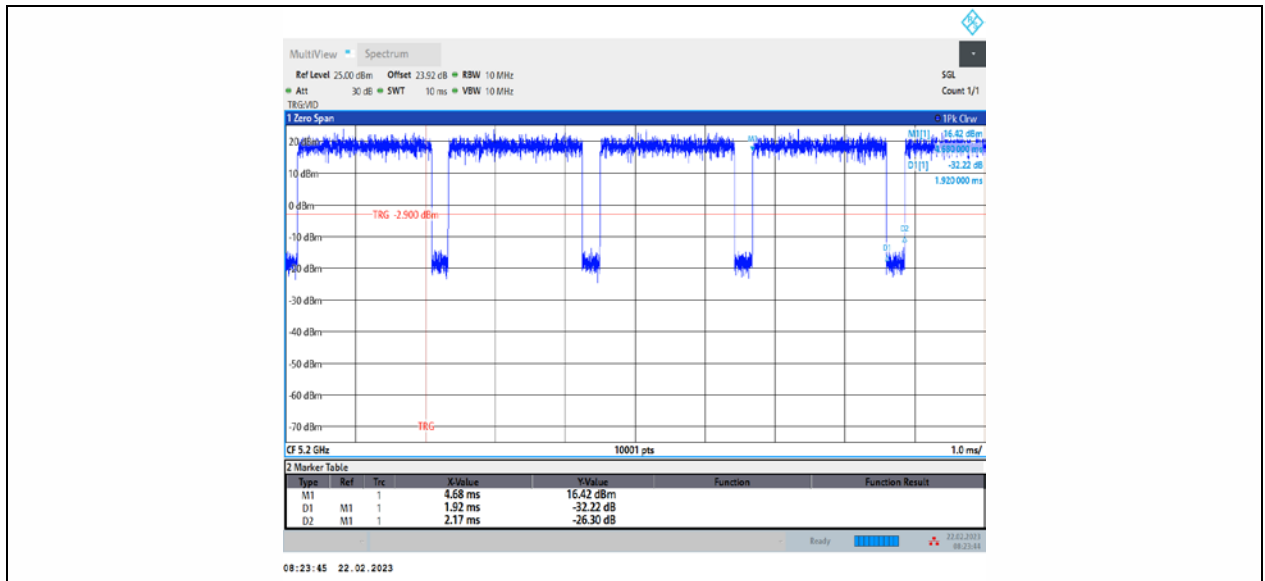

11N20MIMO_Ant2_5200

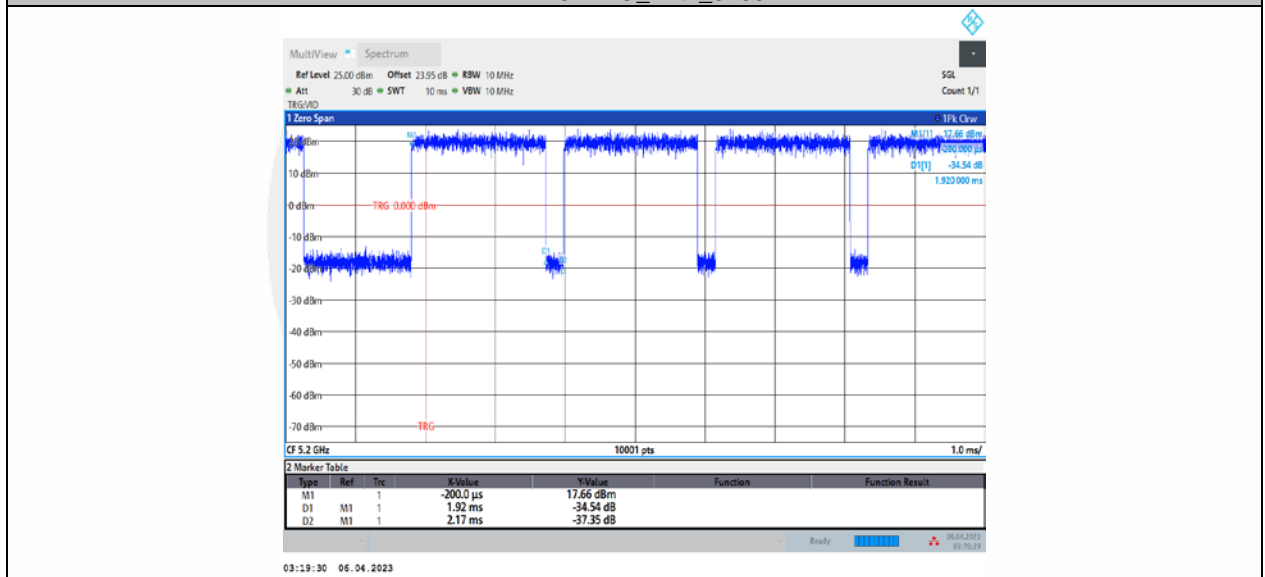

11N20MIMO_Ant1_5240

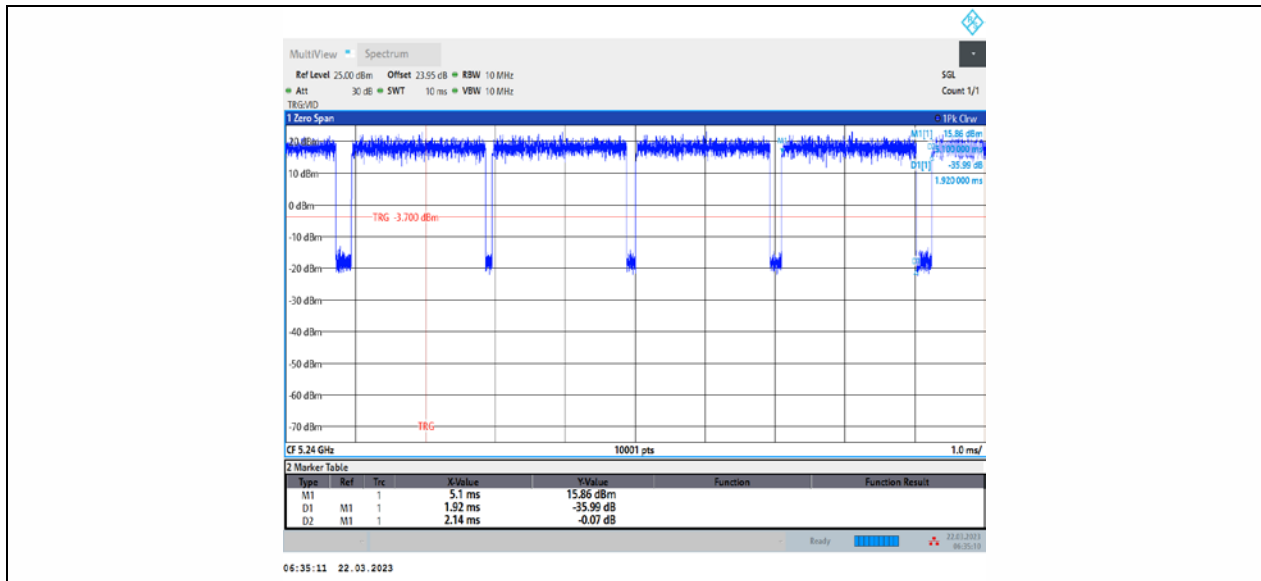

11N20MIMO_Ant2_5240

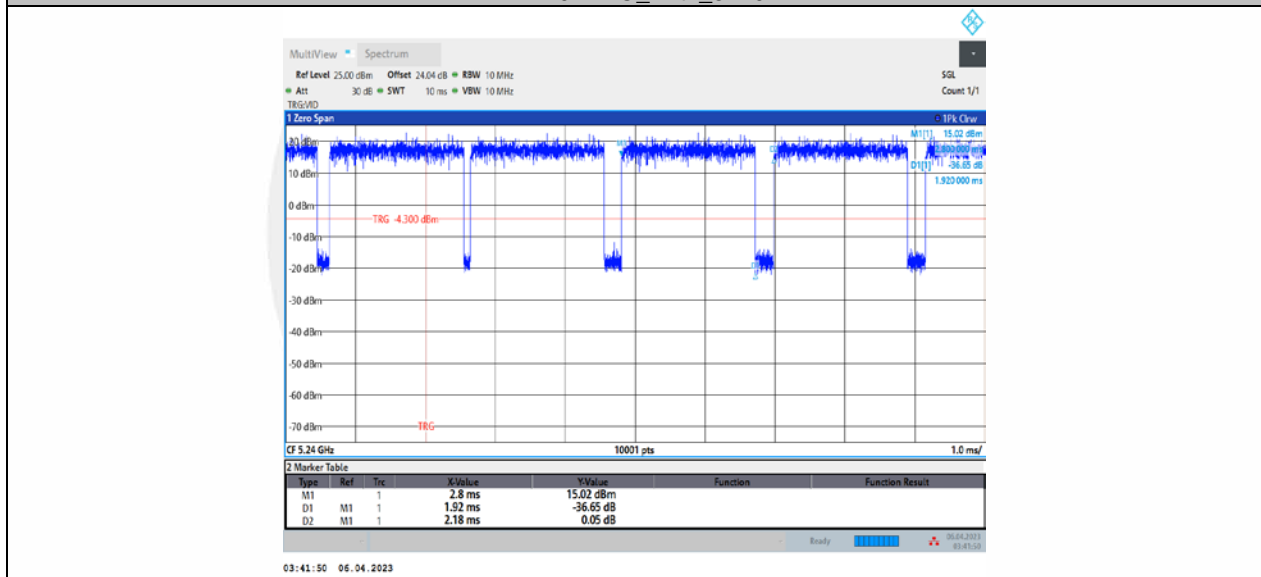

11N20MIMO_Ant1_5745

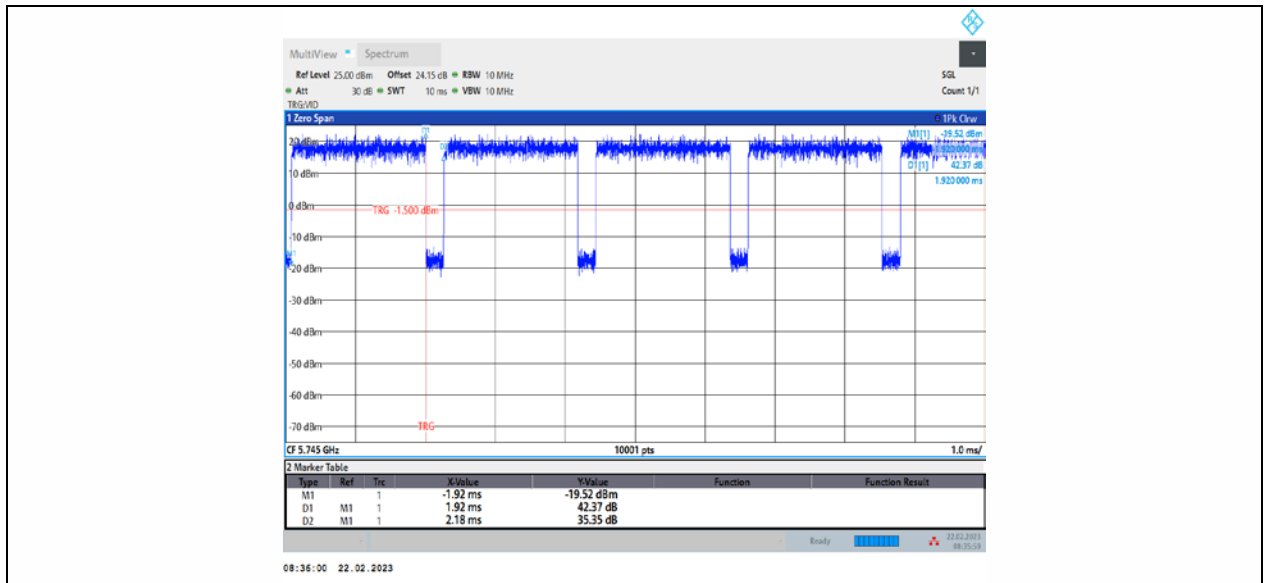

11N20MIMO_Ant2_5745

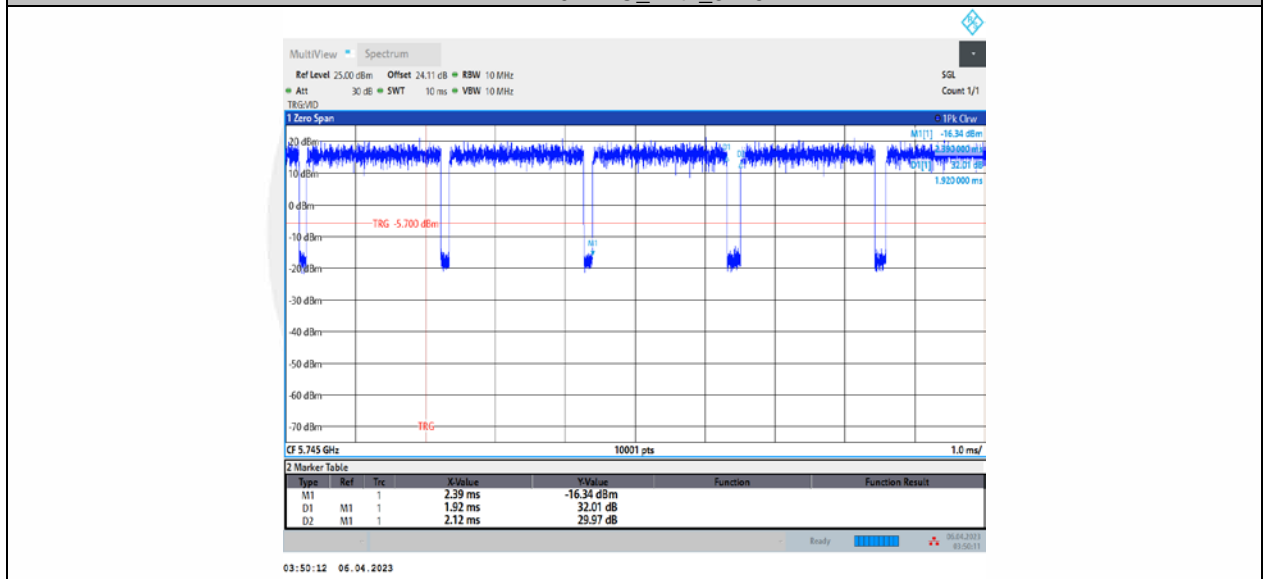

11N20MIMO_Ant1_5785