

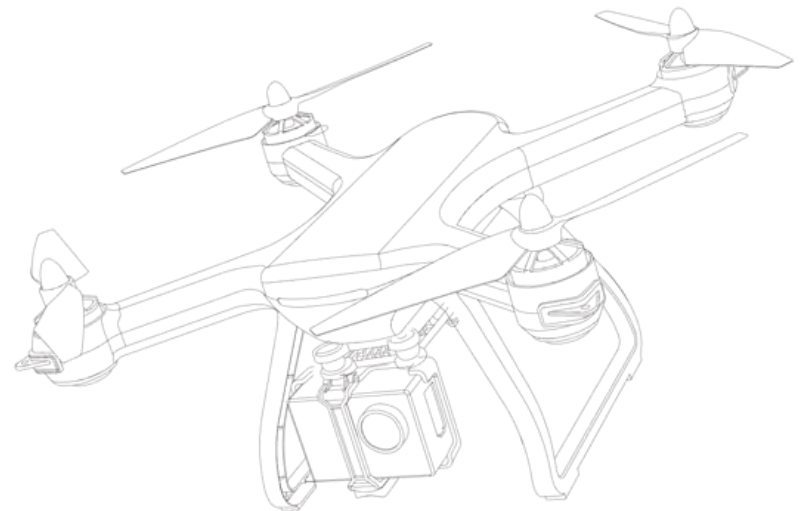

Instructions For Use

V 1.1

16+
age



Ophelia (HS700)



usa@holystone.com (USA)
ca@holystone.com (CA)

eu@holystone.com (EU)
jp@holystone.com (JP)



1(855) 888-6699

www.holystone.com

Contents

1.0 Disclaimer&Warning	1
2.0 Safety Guidelines	1
3.0 Maintenance	5
4.0 Package Contents	6
5.0 Installation	
5.1 Phone Holder	7
5.2 Camera	7
5.3 Landing Gear	8
5.4 Propellers	9
6.0 Drone's Details	9
7.0 Transmitter Details	10
8.0 Charging	13
9.0 Operation Guide	
9.1 Download APP	14
9.2 Transmitter's Battery	14
9.3 Drone's Battery	15
9.4 Paring	16
9.5 Initialization Detection	16
9.6 Calibrate the Gyro	17
9.7 Compass Calibration	17
9.8 Using the Application	18
9.9 Unlock	19
9.10 One Key Takeoff/Landing	20
9.11 Flight Control	20
10.0 Functions Details	
10.1 Transmitter Calibration	21
10.2 Headless Mode	22
10.3 Return to Home	23
11.0 Specifications	26
12.0 Trouble Shooting	27
13.0 General Information	28

1.0 DISCLAIMER & WARNING

1. Please read this Disclaimer & Warning and Safety Guidelines carefully before using our product. This product is not recommended for people under the age of 16. By using this product, you hereby agree to this disclaimer and signify that you have read it fully. You agree that you are responsible for your own conduct and any damaged caused while using this product, and its consequences. You agree to use this product only for purposes that are proper and in accordance with local regulations, terms and all applicable polices and guidelines Holy Stone may make available.

2. When using this product, please be sure to strictly abide by the specification requirements and safety guidelines stated in this document. Any personal injury property damage, legal disputes and all other adverse events caused by the violation of the safety instructions or due to any other factor, WILL NOT be Holy Stone's responsibility.

2.0 SAFETY GUIDELINES

2.1 Check Before Use:

① This product is not a toy, but it is a high precision drone that integrates various electronic stability and control mechanisms. Please be sure to setup this drone carefully and correctly to ensure safe, accident-free operation.

② Please be sure that the batteries of the drone and transmitter are clean, undamaged.

③ Please be sure that all the propellers are undamaged and are installed in the right orientation.

④ Please do a thorough check of the product before each use. Check for firmness of the parts, any signs of cracks and wear of the propeller, battery power and effectiveness of the indicator, etc. If after doing a complete check any issues is found, please refrain from using the product until the issue has been taken care for.

2.2 Flight Environment:



Avoid flying over or near obstacles, crowds, high voltage power lines, trees, airport or bodies of water.

DO NOT fly near strong electromagnetic sources such as power lines and base stations as it may affect the onboard compass.



Don't use this drone in adverse weather conditions such as rain, snow, fog, and wind.

2.3 Operations Requirements :

- ① Please don't use this product to follow any moving vehicles .
- ② During the flight, only turn off the motor in case of an emergency.
- ③ Please flight the drone back to you as soon as possible when the battery is running low.
- ④ This product should not be used while drinking alcohol, if you are feeling fatigued, taking medicine, or feeling any physical discomfort.
- ⑤ Beware of the noise volume the drone produces. Keep your distance to avoid ear damage.



- ⑥ **Stay away from the rotating propellers and motors.**
- ⑦ **Don't fly in the No-Fly Zone.**

2.4 Use of Battery:

- ① Please ensure batteries are fitted in the correct orientation as shown in the instruction manual.
- ② Avoid short circuits by fitting the batteries incorrectly, and do not crush or squeeze the batteries as this could carry the risk of an explosion.
- ③ Do not mix new and old batteries as this can lead to a poor performance of the product.
- ④ Dispose used batteries carefully, do not litter.
- ⑤ Please keep dead batteries away from heat and fire.
- ⑥ If the device is not going to be used for an extended period of time, remove batteries to prevent potential damage from battery leakage.

- ⑥ If the device is not going to be used for an extended period of time, remove batteries to prevent potential damage from battery leakage.
- ⑦ It is recommended to only use the USB charging cable that comes with the drone to charge the battery.
- ⑧ Don't connect the battery directly to wall outlets or car cigarette-lighter sockets.
- ⑨ Don't attempt to disassemble or modify the battery in any way.
- ⑩ Don't use the battery if it gives off an odor, generates heat, becomes discolored or deformed, or appears abnormal in any way. If the battery is in use or being charged, remove it from the device or charger immediately and discontinue use.
- ⑪ Don't pierce the battery casing with a nail or other sharp object, break it open with a hammer, or step on it!
- ⑫ Always charge the batteries in a fireproof container and away from combustible material. Don't charge on surfaces that can catch fire-this includes: wood, cloth, carpet, or in the application's device.
- ⑬ Don't immerse the battery in water or allow it to get wet.
- ⑭ Don't solder battery terminal directly.
- ⑮ Keep battery out of reach of children or pets.
- ⑯ Don't short-circuit the battery by connecting wires or other metal object to the positive(+) and negative(-) terminals.



Li-Po Battery Disposal & Recycling

Waste Lithium-polymer batteries must not be placed with household trash. Please contact local environmental or waste agency or the waste agency or the supplier of your model or your nearest Li-Po battery recycling center.



3.0 MAINTENANCE

- ① Clean the product after each use with a clean, soft cloth.
- ② Avoid prolonged exposure to direct sunlight and avoid buildup of heat on the drone.
- ③ This device is not waterproof and must not be submerged in water under any circumstance. Failure to maintain the device completely dry will result in the failure of the unit.
- ④ Check the charging plug and other accessories for signs of damage frequently. If any part of the device is damaged, refrain from flying until maintenance can be carried out.

4.0 PACKAGE CONTENTS

No.	Part Name	Picture	Quantity
1	Drone		1
2	Transmitter		1
3	Camera And USB Data Cable		1
4	Camera Holder		1
5	Phone Holder		1
6	Drone Battery		1
7	Propellers		8
8	Landing Gear		2
9	Charge Transfer Box		1
10	Balance Charger		1
11	USB Charging Cables		1
12	Screwdriver		1
13	Propeller Spanner		1
14	Camera Mat		1
15	Battery charging Bag		1
16	TF Card (installed in the camera)		1

5.0 INSTALLATION

5.1 Phone Holder

① As shown on (Pic 1), install the phone holder to the transmitter.

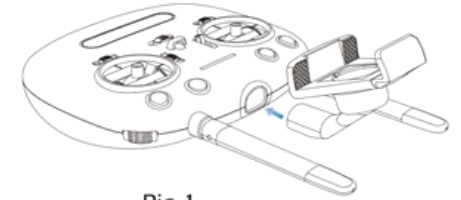

Pic 1

② Press the buckle on the phone holder to take it out. (Pic 2)

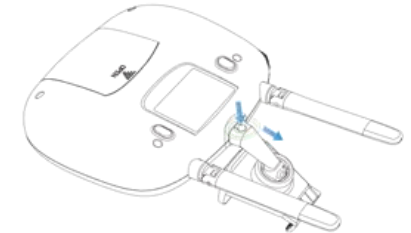

Pic 2

5.2 Camera

① Attach the camera mat to the camera holder; (Pic 3)

② Connect the USB data cable to the camera; (Pic 4)

③ Install the camera to camera holder, and lock it; (Pic 5)

④ Install the camera holder to the drone, and connect the USB data cable to the drone and lock it. (Pic 6)

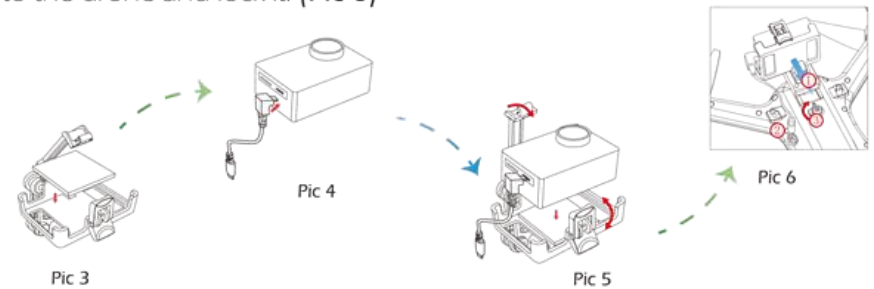

Pic 3

Pic 4

Pic 5

Pic 6

5.3 Landing Gear

① Make the "A" side of the landing gear aim at the "A" hole on the drone; (Pic 7)

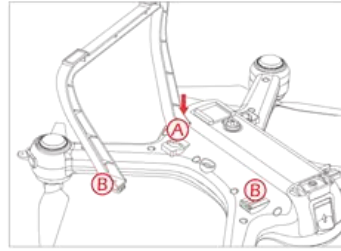

Pic 7

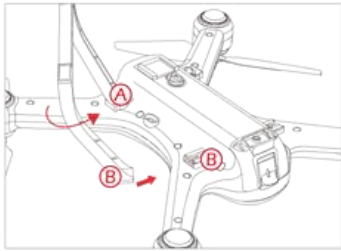

Pic 8

② Rotate the landing gear inward, then push the "B" side of landing gear to the "B" hole on the drone to complete installation. (Pic 8)

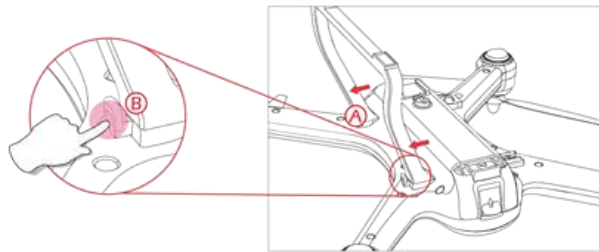

Pic 9

③ Press the buckle on the side of the landing gear, then can take it out. (Pic 9)

5.4 Propellers

① **Installation:** Install the propeller on the motor shaft according to the "A/B" corresponding position, and rotate to tighten the propeller according to the "Lock" icon on the propeller. (Pic 10)

② **Demolition Removal:** Fix the brushless motor with propeller spanner and rotating it according the "unlock" icon on the propeller to take it out. (Pic 11)

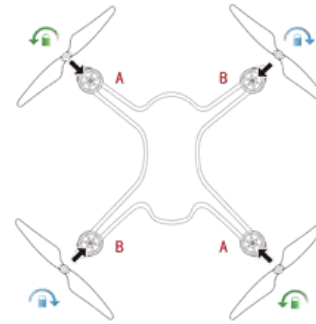

Pic 10

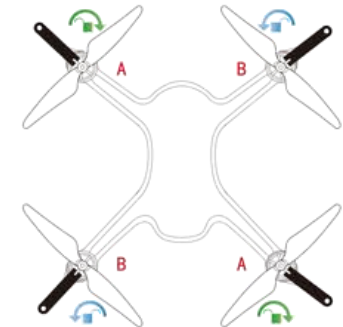

Pic 11

6.0 DRONE'S DETAILS

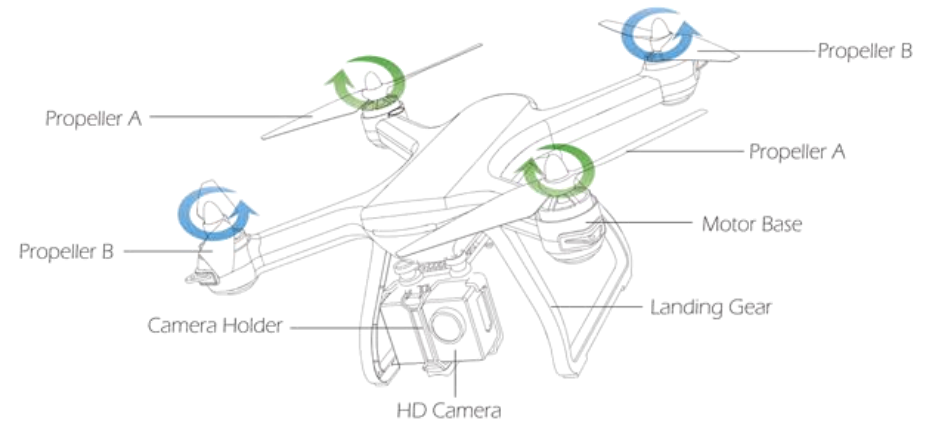

7.0 TRANSMITTER DETAILS

7.1 Transmitter Functions:

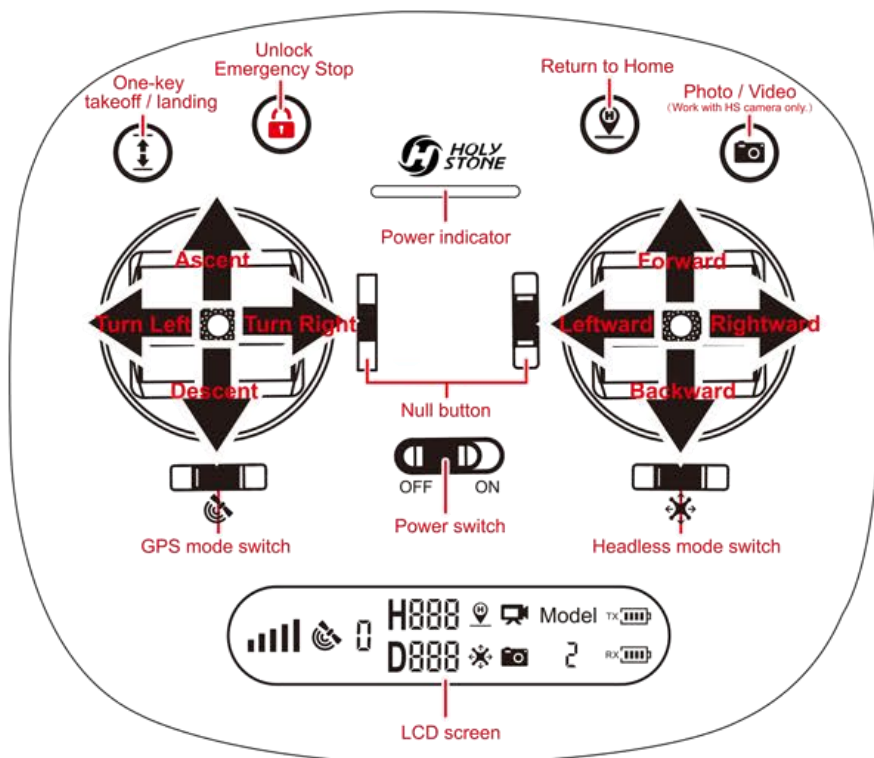

One-key take off / landing: One button take off, one button landing.

Unlock/Emergency Stop:

Click "🔒", the motors rotate and the drone is unlocked.

Hold the button 3 seconds for emergency stop.

Return to Home: The Return to Home function brings the drone back to the last recorded Home Point.

Photo / Video:

Click "📷" to take photo, hold the button for 2 seconds to enter the video.

GPS mode switch:

Slide the button to "A", the drone exits the GPS Mode;

Slide the button to "B", the drone turns on the GPS Mode.

Headless mode switch::

Slide the button to "A" to exits the Headless Mode;

Slide the button to "B" to enter the Headless Mode.

7.2 LCD Screen Functions:



	Signal Strength		Headless Mode
	GPS Mode		Video
	Satellite Number		Photo
	Altitude (Meter)		Transmitter Throttle Mode
	Distance(Meter)		Transmitter Battery Level
	One Key Return		Drone Battery Level

7.3 Mode Switch:

7.3.1 MODE 2 (Left hand throttle MODE 2 will be default setting)

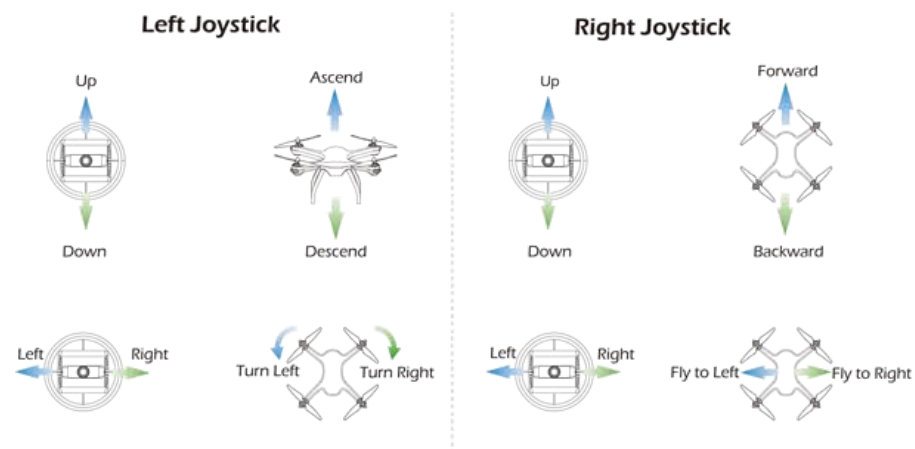

7.3.2 MODE 1

- ① Hold down the “” and then turn on the power switch;
- ② Press the “” button 3 seconds to enter MODE 1.

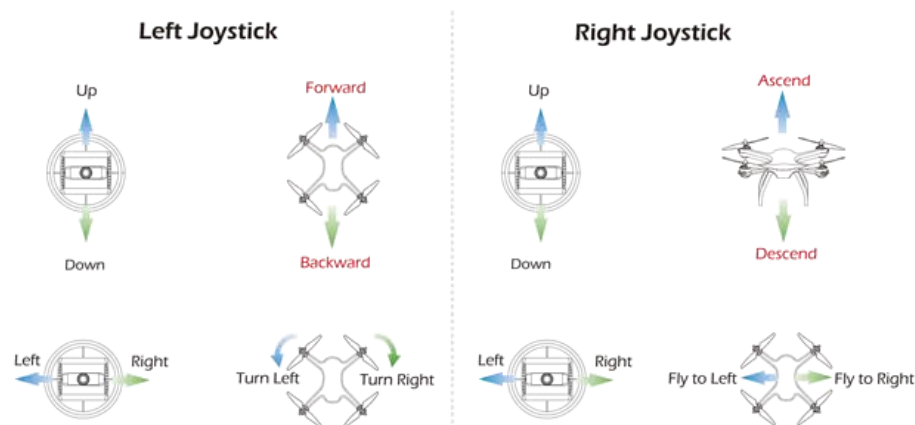

8.0 Charging

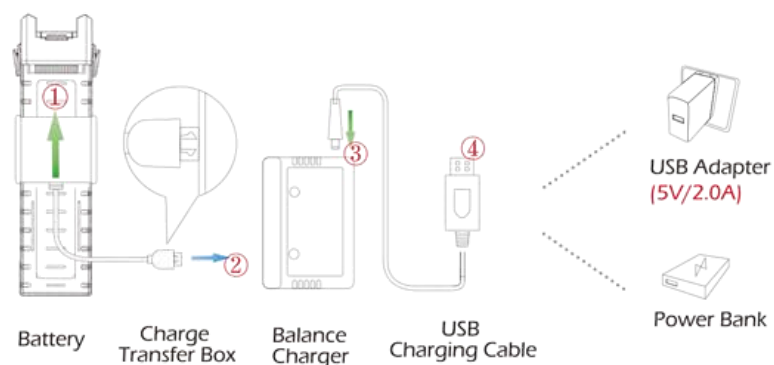

- ① Connect the Battery, Charge Transfer Box, Balance Charger and USB Charging Cable.
- ② Connect the USB Charging Cable to Power Bank or a USB Adapter (5V/2.0A) for charge.



- When the battery is charging, the green light will flash slowly and the red light will be on.
- When the battery is fully charged, the green light and red light will be on.
- Before charging, please check the contents of the “**Use of Battery**” section of the “**Safety Guidelines**” carefully!
- Please insert the plug in the correct way. If it is inserted in reverse, the red light will be on, the green light flash quickly, the battery will not be able to be charged.



9.0 OPERATION GUIDE

All of the following operations on this manual under MODE 2.

9.1 Download APP



iOS



Android APP on Google play

Connect to the App Store™ or Google™ Play and download the “Ophelia GPS” application for free.

9.2 Transmitter's Battery

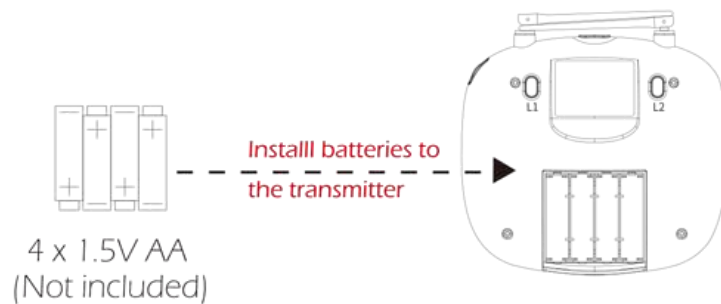

! Always pay close attention to battery polarity when installing the batteries to make sure they are fitted correctly.

9.3 Drone's Battery

Installation:

Insert battery into drone. Make sure that you hear a click sound indicating the battery is firmly installed.

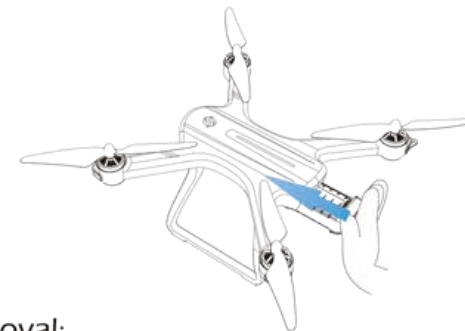

Battery Removal:

Press the buckle on the back of the battery while pulling backwards to remove the battery.

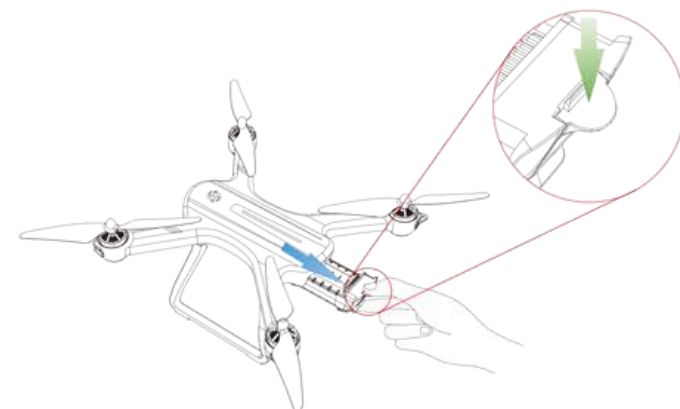

9.4 Pairing

① Hold the “” button and slide the power switch to the right to power on the transmitter.

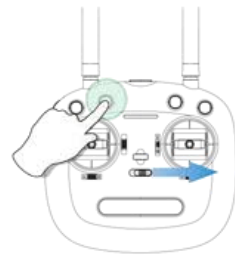

② Install the battery and place the drone on a level surface with the head forward.

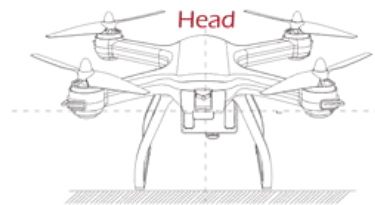

③ The “” icon on the transmitter LCD screen is full, it means that the drone has pairing with the transmitter successfully.

9.5 Initialization Detection

Place the drone on the level surface and enters the “Initialization Detection”. At this point, the yellow, green and red LED lights of the drone will flicker alternately for about 7 seconds to complete the initial detection. At this time, the front and back yellow LED lights of the drone will flicker alternately.

9.6 Calibrate the Gyro

Push both of the joysticks down to the bottom left. the green LED light will flash. Once the front and back yellow LED lights of the drone flicker alternately, it means the calibration is completed.

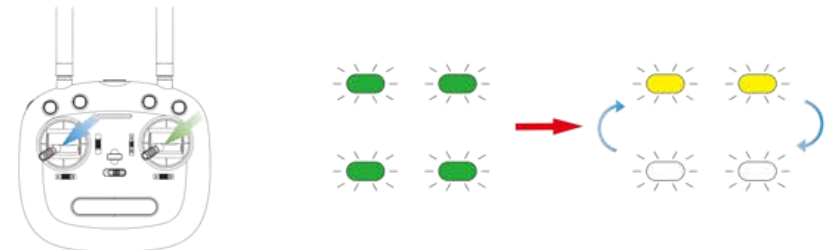

9.7 Compass Calibration

① Hold the drone horizontally and rotate the drone for about 3 circles. And the **Green** LED lights of the drone will keep blink. (Pic 1)

② Hold the drone vertically and rotate the drone for about 3 circles. The front **Red** lights and the rear **Yellow** light will turn to solid. (Pic 2)

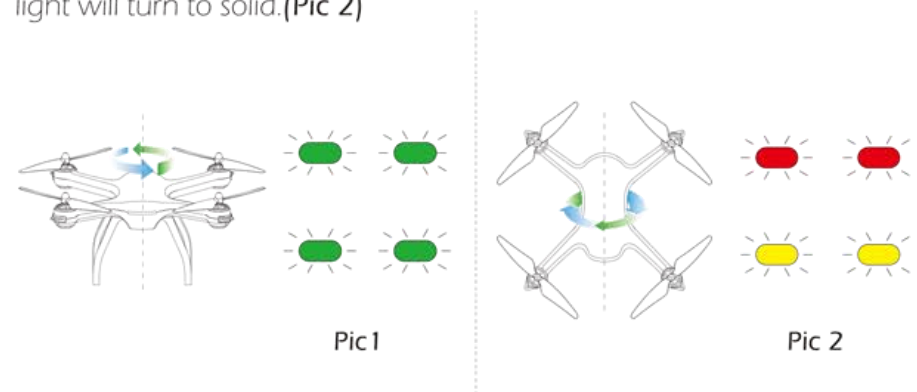

9.8 Using the Application

Connect your smart phone to the Wi-Fi of the Drone and check the drone's status on the "Ophelia GPS" App.

- ① On your smartphone, launch a search of the available Wi-Fi networks:
 - ② Select the Wi-Fi network: HolyStoneFPV_*****
 - ③ Wait for your smartphone connect to the Wi-Fi network of the drone. This connection is generally represented by the Wi-Fi logo appearing on your smartphone's screen.
 - ④ Enter the Ophelia GPS application.
- > The connection between your smartphone and the Drone is established automatically.

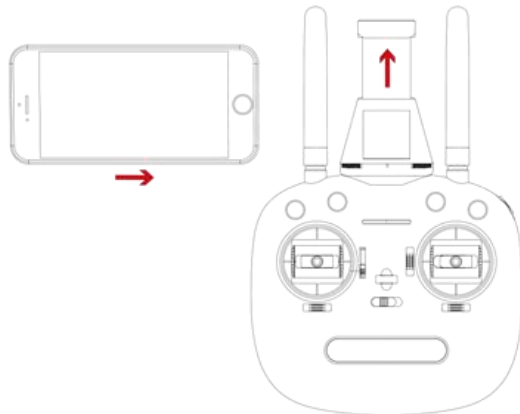

(Open the phone holder and put the phone.)

9.9 Unlock

9.9.1 Unlock the drone:

After the Compass calibration is completed, unlock the drone to fly.

Method 1: Press the Unlock button (Pic 1). The motors rotate and the drone is unlocked.

Method 2: Push the left stick to lower right corner and the right stick to the lower left corner at the same time (Pic 2) to unlock the drone.



Pic 1



Pic 2

⚠ Tips:

After unlock the drone, the motor will automatically stop rotating if you didn't fly the drone within 10 seconds.

9.9.2 Lock the drone:

After the drone lands on the ground, pull down the throttle stick to the bottom position and keep for 3 seconds, the motor will stop immediately. And the drone is locked.

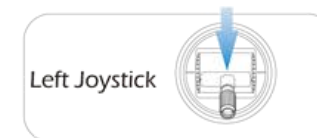

9.10 One Key Takeoff/Landing

- ① After drone unlocked, press the One Key Takeoff/ Landing button, the drone will automatically takeoff and hover at about 7~11 feet altitude.
- ② When the drone is flying, press the One Key Takeoff/ Landing button again, the drone will automatically land on the ground.



9.11 Flight Control

Control the flight by using joysticks.

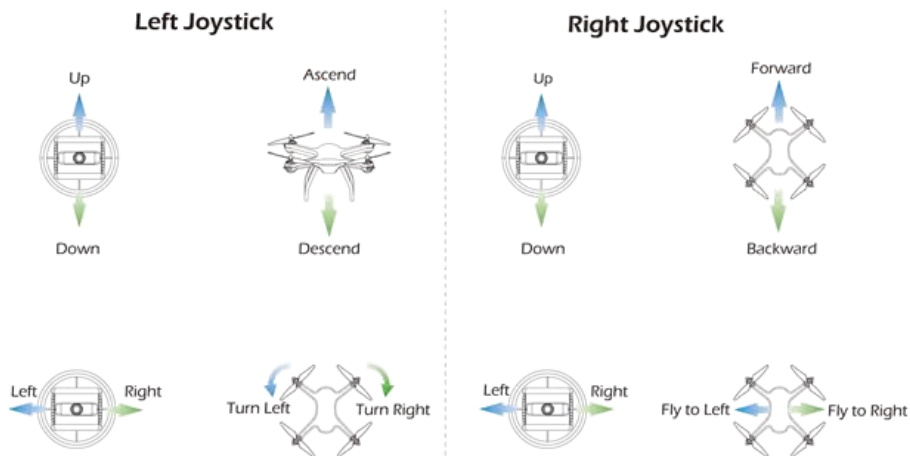

10.0 FUNCTIONS DETAILS

10.1 Transmitter Calibration

- Control sticks calibration has been completed by default. It is not necessary to calibrate the control stick unless pilot has felt abnormal stick travel.
- Please do not power on your drone when calibrate the control stick for the remote controller.

- ① Hold down the “” button while turn on the transmitter; (Pic 1)

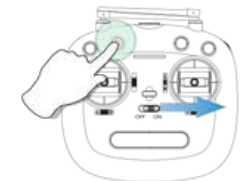

Pic 1

- ② Press “” for 3 seconds, the transmitter send out 3 beeps; (Pic 2)



Pic 2

- ③ Maximum rotate both of left and right joysticks to any direction for 2 circles; (Pic 3)



Pic 3

- ④ Press “” for 3 seconds, the transmitter send out 3 beeps again, it means that Transmitter Calibration is completed. (Pic 4)



Pic 4

10.2 Headless Mode

- ① Slide the Headless Mode button to "B" to enter the Headless Mode.
- ② Slide the Headless Mode button to "A" to exit the Headless Mode.

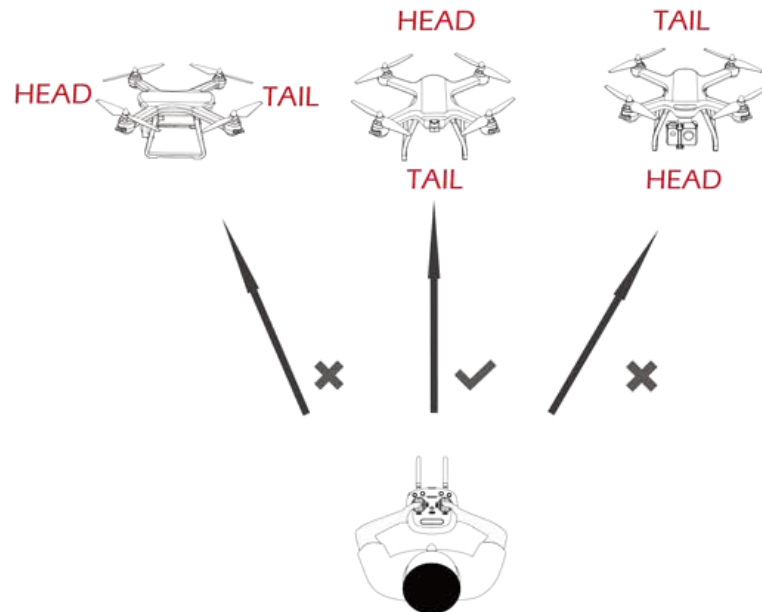

Please make sure the pilot to stay in the same orientation as the drone head faces when the drone take off.

Under Headless Mode, the forward direction is the direction that the head of drone faces when the drone take off.

In order to make sure the pilot can tell drone's direction, we recommend that pilots to stay in the same orientation as the drone head faces when the drone take off. If so, when the pilot pushes the direction joystick forward/ backward, the drone will fly forward/ backward toward him/ her. If the pilot move the right stick left/ right, the drone will move left/ right relative to the pilot.

10.3 Return to Home(RTH)

The Return to Home function brings the drone back to the last recorded Home Point.

The Home Point is the location at which the drone takes off. Or during flight, the GPS receives more than 7 stars for the first time, the current position of the drone will be recorded as the Home Point.

10.3.1 Smart RTH



Return to Home

If the GPS signal is available (more than 7 satellites is presented) and the home point is recorded previously, press the "Return to Home" button on the transmitter, the drone will fly back to the home point.

Exit the RTH mode by pressing the "Return to Home" button or push the Throttle Joystick .

10.3.2 Low Voltage RTH

① When the drone's rear lights flash slowly, the "  " symbol is displayed on the screen of the transmitter. At this moment, as long as the drone flying altitude is over 98 feet or the flying distance is over 492 feet, the first Low Voltage RTH will be triggered, and the drone will automatically return and hover 98 feet above the Home Point. At the same time, the drone will exit the Low Voltage RTH automatically.

At this time, the pilot can re-control the drone within a range of 98 feet high and 328 feet.

② When the drone's rear lights flash quickly, the "  " symbol is displayed on the screen of the transmitter. At this moment, the transmitter sounds "Di..., Di...". At this moment, the second Low Voltage RTH will be triggered, as long as the drone flying altitude is over 49 feet or the flying distance is over 49 feet, the drone will automatically fly back to the Home Point.

10.3.3 Failsafe RTH

If the GPS signal is available (**At least 7 satellites**) and the home point is recorded previously. Failsafe Return will be triggered if the transmitter signal is lost for more than 6 seconds. The drone will automatically start the return procedure and it will fly back to the last recorded Home Point. You can exit "Failsafe RTH" mode by press the "Return to Home button or push the Left Joystick if the transmitter signal is recovered.



During the Failsafe Return procedure, the drone can not avoid obstacles.

The drone cannot Return-to-Home if the GPS signal is weak (satellites number is less than 7).

If there is no GPS signal and transmitter signal lost for more than 6 seconds, the drone will not Return-to-Home but descend slowly until land to the ground and lock the drone.

11.0 SPECIFICATIONS

DRONE

Model: HS700

Weight: 608 g

Flight Time: 20 minutes

Motor Model: 2204 1500KV

Operating Temperature Range: 32° to 104°F

Dimensions: 220 x 220 x 155mm

CAMERA

Video Recording Modes: HD1920×1080p

Photo: JPEG

Video: AVI

MAX Supported TF Cards: 32 GB (Not included)

Operating Temperature Range: 32° to 104°F

TRANSMITTER

Operating Frequency: 2.4GHz

MAX Transmission Distance: 3280 feet

Operating Temperature Range: 32° to 104°F

Battery: 4× 1.5V AA batteries

USB CHARGING CABLE

Voltage: 5 V

Rated Power: ≤10 W

DRONE BATTERY

Capacity: 2800 mAh

Voltage: 7.4 V

Battery Type: Li-po

Energy: 20.72 Wh

Net Weight: ≤149g

Charging power: 5~10W

Charging Temperature Range: 41° to 104°F (5° to 40°C)

Charging Time: 5~7 Hour

12.0 TROUBLE SHOOTING

No.	Problem	Solution
1	When the drone is powered on, the indicator light keeps flashing rapidly.	The drone is in the gyroscope calibration state. Please place the drone on an flat and level surface.
2	The drone cannot hover after takeoff and tilts to one side.	Place the drone on a flat, level surface and repeat the gyro calibration.
3	The drone vibrated in flight.	Deformed propeller, replace the new propeller.
4	The drone could not be unlocked and the rear light flashed.	The drone battery voltage is too low. Please fully charge the battery.

13.0 GENERAL INFORMATION

FCC Notice:

This device complies with Part 15 of the FCC Rules.

Operation is subject to the following two conditions:

- (1) This device may not cause harmful interference.
- (2) This device must accept any interference received, including interference that may cause undesired operation.

NOTE: This equipment has been tested and found to comply with the limits for a Class B digital device, pursuant to Part 15 of the FCC Rules. These limits are designed to provide reasonable protection against harmful interference in a residential installation. This equipment generates uses and can radiate radio frequency energy and, if not installed and used in accordance with the instructions, may cause harmful interference to radio communications. However, there is no guarantee that interference will not occur in a particular installation. If this equipment does cause harmful interference to radio or television reception, which can be determined by turning the equipment off and on, the user is encouraged to try to correct the interference by one or more of the following measures:

- Reorient or re'ocate the receiving antenna.
- Increase the separation between the equipment and receiver.
- Connect the equipment into an outlet on a circuit different from that to which the receiver is connected.
- Consult the dealer or an experienced radio/TV technician for help.

WARNING: Changes or modifications not expressly approved by the party responsible for compliance could void the user's authority to operate the equipment.

RF Exposure

The equipment complies with FCC radiation exposure limits set forth for an uncontrolled environment. This equipment should be installed and operated with minimum distance 20cm between the radiator & your body.

HOW TO RECYCLE THIS PRODUCT

This symbol on the product or its documentation indicates that it must not be disposed of with household waste.

Uncontrolled waste disposal may harm the environment or human health. Please separate your device from other types of waste to recycle it responsibly.

This will help to foster the sustainable re-use of material resources.

We invite you to contact your retailer or inquire at your local town hall to find out where and how the drone can be recycled.



BATTERY WARNING:

1. Failure to follow all the instructions may result in serious injury, irreparable damage to the battery and may cause a fire, smoke or explosion.
2. Always check the battery's condition before charging or using it.
3. Replace the battery if it has been dropped, or in case of odour, overheating, discolouration, deformation or leakage.
4. Never use anything other than the approval LiPo charger the battery. Always use a balancing charger for LiPo cells or a LiPo cell balancer. It is recommended that you do not to use any other charger than the one provided with the product.
5. The battery temperature must never exceed 60°C (140°F) otherwise the battery could be damaged or ignite.
6. Never charger on a flammable surface, near flammable products or inside a vehicle (preferably place the battery in a non-flammable and nonconductive container).
7. Never leave the battery unattended during the charging process. Never disassemble or modify the housing's wiring, or puncture the cells. Always ensure that the charger output voltage corresponds to the voltage of the battery. Do not short circuit the batteries.
8. Never expose the LiPo battery to moisture or direct sunlight, or store it in a place where temperatures could exceed 60°C(car in the sun, for example).
9. Always keep it out of reach of children.
10. Improper battery use may result in a fire, explosion or other hazard.
11. Non-rechargeable batteries are not to be recharged. Rechargeable batteries are only to be charged under adult supervision.
12. Different types of batteries or new and used batteries are not to be mixed.

13. Batteries are to be inserted with the correct polarity.
14. The supply terminals are not to be short-circuited. Regular examination of transformer or battery charger for any damage to their cord, plug, enclosure and other parts and they must not be used until the damage has been repaired.
15. The packaging has to be kept since it contains important information.
16. The toy is only to be connected to Class II equipment bearing the symbol. 

EU RF Power(EIRP): 10dBm (2413MHz ~ 2461 MHz)

Caution

1. The max operating of the EUT is 45°C. and shouldn't be lower than -10°C.
2. The device complies with RF specifications when the device used at 0mm from your body.
3. Declaration of Conformity.

We, Xiamen Huoshiquan Import & Export CO., LTD hereby, declare that the essential requirements compliance with the Directive 2014/53/EU, the RoHS Directive 2011/65/EU and Safety Directive 2009/48/EC have been fully fulfilled on our product with indication below:

Product Name: REMOTE CONTROL MODEL/RADIO CONTROLLED
Model/Mark : HS700/HOLYSTONE

The Statement of compliance is available at the following address:
<http://www.holystone.com/docs/HS700EUDOC.pdf>
This product can be used across EU member states.

MANUFACTURER INFORMATION

Manufactured by
Xiamen Huoshiquan Import & Export CO., LTD
Room 703, No. 813-2 Xiahe Road, Siming District, XIAMEN, China
+1 (855) 888-6699



Made in China

changes or modifications not expressly approved by the party responsible for compliance could void the user's authority to operate the equipment.

This equipment has been tested and found to comply with the limits for a Class B digital device, pursuant to Part 15 of the FCC Rules. These limits are designed to provide reasonable protection against harmful interference in a residential installation. This equipment generates, uses and can radiate radio frequency energy and, if not installed and used in accordance with the instructions, may cause harmful interference to radio communications. However, there is no guarantee that interference will not occur in a particular installation.

If this equipment does cause harmful interference to radio or television reception, which can be determined by turning the equipment off and on, the user is encouraged to try to correct the interference by one or more of the following measures:

- Reorient or relocate the receiving antenna.
- Increase the separation between the equipment and receiver.
- Connect the equipment into an outlet on a circuit different from that to which the receiver is connected.
- Consult the dealer or an experienced radio/TV technician for help.

This equipment complies with FCC radiation exposure limits set forth for an uncontrolled environment. This equipment should be installed and operated with minimum distance 20cm between the radiator and your body. This transmitter must not be co-located or operating in conjunction with any other antenna or transmitter.