

# *Holyton*

14<sup>+</sup>  
age

## Instructions For Use

V1.0

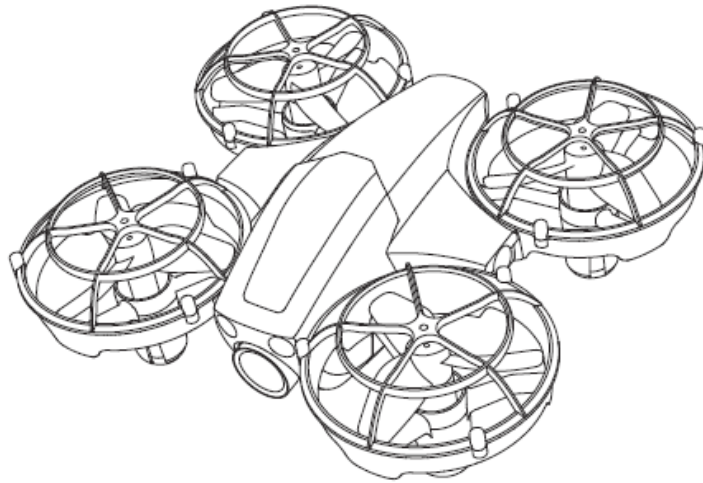

HS330



[holyton@foxmail.com](mailto:holyton@foxmail.com) (USA)

[holyton\\_ca@foxmail.com](mailto:holyton_ca@foxmail.com) (CA)

[holyton\\_jp@foxmail.com](mailto:holyton_jp@foxmail.com) (JP)

[holyton\\_eu@foxmail.com](mailto:holyton_eu@foxmail.com) (EU)

## Contents

1.0 Disclaimer&Warning .....	01
2.0 Safety Guidelines .....	01
3.0 Maintenance .....	05
4.0 Package Contents .....	06
5.0 Drone's Details .....	07
6.0 Transmitter Details .....	08
7.0 Joystick Mode .....	09
8.0 Installation	
Drone's Battery .....	10
9.0 Charging .....	11
10.0 Sensor Mode Operation Guide	
Throw & Go .....	12
Auto-Rotating .....	13
Flip & Rolling .....	13
Circle Fly .....	14
11.0 Remote Control Operation Guide	
Pairing .....	15
Calibrating the Gyro .....	16
One Key Takeoff / Landing .....	16
12.0 Functions Details	
Speed Switch .....	17
Emergency Stop .....	17
Obstacle Avoidance Mode .....	18
360° Flip .....	19
Headless Mode .....	20
13.0 Specifications .....	21
14.0 Contact Us .....	22
15.0 General Information .....	23

## **1.0 DISCLAIMER & WARNING**

1. Please read this Disclaimer & Warning and Safety Guidelines carefully before using our product. This product is not recommended for people under the age of 14. By using this product, you hereby agree to this disclaimer and signify that you have read it fully. You agree that you are responsible for your own conduct and any damaged caused while using this product, and its consequences . You agree to use this product only for purposes that are proper and in accordance with local regulations, terms and all applicable polices and guidelines Holyton may make available.
2. When using this product, please be sure to strictly abide by the specification requirements and safety guidelines stated in this document. Any personal injury property damage, legal disputes and all other adverse events caused by the violation of the safety instructions or due to any other factor, WILL NOT be Holyton's responsibility.

## **2.0 SAFETY GUIDELINES**

### **2.1 Check Before Use:**

- ① This product is a high precision drone that integrates various electronic stability and control mechanisms. Please be sure to setup this drone carefully and correctly to ensure safe, accident-free operation.
- ② Please be sure that the batteries of the drone and transmitter are clean, undamaged and, fully charged.
- ③ Please be sure that all the propellers are undamaged and are installed in the correct orientation.

④ Please do a thorough check of the product before each use. Inspect the integrity of the parts, any signs of cracks and wear of the propeller, battery power and effectiveness of the indicator, etc. If after doing a complete check any issues are found, please refrain from using the product until the issue has been resolved.

**2.2 Flight Environment:**



Avoid flying over or near obstacles, crowds, high voltage power lines, trees, airport or bodies of water.

DO NOT fly near strong electromagnetic sources such as power lines and base stations as it may affect the onboard compass.



Don't use this drone in adverse weather conditions such as rain, snow, fog, and wind.

### **2.3 Operation Requirements :**

- ① Please don't use this product to follow any moving vehicles .
- ② During the flight, only turn off the motor in case of an emergency.
- ③ As battery becomes low return the drone back to your starting point.
- ④ This product should not be used while drinking alcohol, if you are feeling fatigued, taking medicine, or feeling any physical discomfort.
- ⑤ Beware of the noise volume the drone produces. Keep your distance to avoid ear damage.



**⑥ Stay away from the rotating propellers and motors.**

**⑦ Don't fly in the No-Fly Zone.**

### **2.4 Use of Battery:**

- ① Please ensure batteries are fitted in the correct orientation as shown in the instruction manual.
- ② Avoid short circuits by fitting the batteries correctly, and do not crush or squeeze the batteries as this could carry the risk of an explosion.
- ③ Do not mix new and old batteries as this can lead to a poor performance of the product.
- ④ Dispose used batteries carefully, do not litter.
- ⑤ Please keep dead batteries away from heat and fire.
- ⑥ If the device is not going to be used for an extended period of time, remove batteries to prevent potential damage from battery leakage.









- ⑦ It is recommended to only use the USB charging cable that comes with the drone to charge the battery.
- ⑧ Don't connect the battery directly to wall outlets or car cigarette-lighter sockets.
- ⑨ Don't attempt to disassemble or modify the battery in any way.
- ⑩ Don't use the battery if it gives off an odor, generates heat, becomes discolored or deformed, or appears abnormal in any way. If the battery is in use or being charged, remove it from the device or charger immediately and discontinue use.
- ⑪ Don't pierce the battery casing with a nail or other sharp object, break it open with a hammer, or step on it!
- ⑫ Always charge the batteries in a fireproof container and away from combustible materials. Don't charge on surfaces that can catch fire. This includes: wood, cloth, carpet, or in the application's device.
- ⑬ Don't immerse the battery in water or allow it to get wet.
- ⑭ Don't solder battery terminal directly.
- ⑮ Keep battery out of reach of children or pets.
- ⑯ Don't short-circuit the battery by connecting wires or other metal object to the positive(+) and negative(-) terminals.



### **3.0 MAINTENANCE**

- ① Clean the product after each use with a clean, soft cloth.
- ② Avoid prolonged exposure to direct sunlight and avoid buildup of heat on the drone.
- ③ This device is not waterproof and must not be submerged in water under any circumstance. Failure to maintain the device completely dry will result in the failure of the unit.
- ④ Check the charging plug and other accessories for signs of damage frequently. If any part of the device is damaged, refrain from flying until maintenance can be carried out.

#### 4.0 PACKAGE CONTENTS

 ×1	 ×1	 ×3
Drone	Transmitter	Drone Battery
 ×2	 ×4	 ×1
USB Charging Cable	Propellers	Propeller Screwdriver
 ×1	 ×1	
Screwdriver	Instructions For Use	



## 5.0 DRONE'S DETAILS

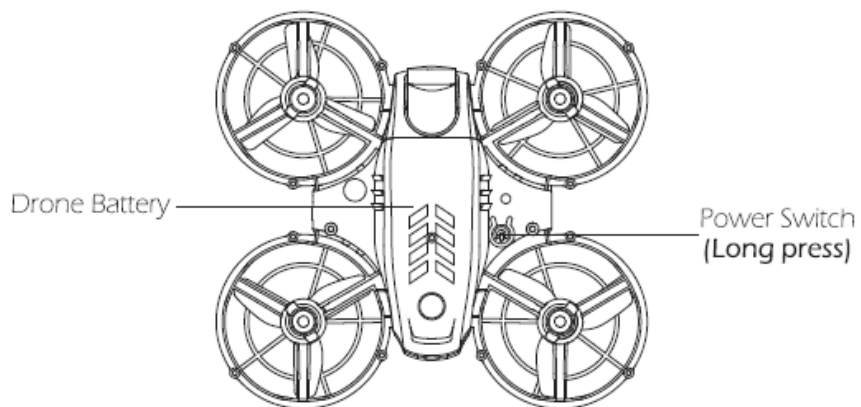
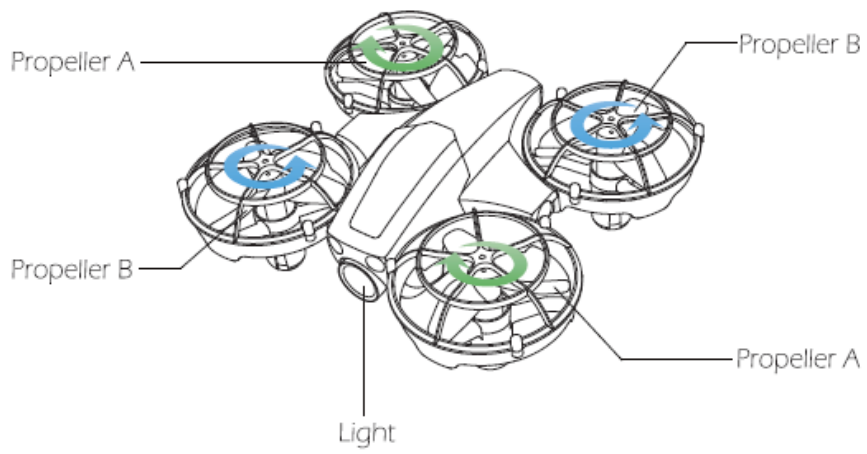

## 6.0 TRANSMITTER DETAILS

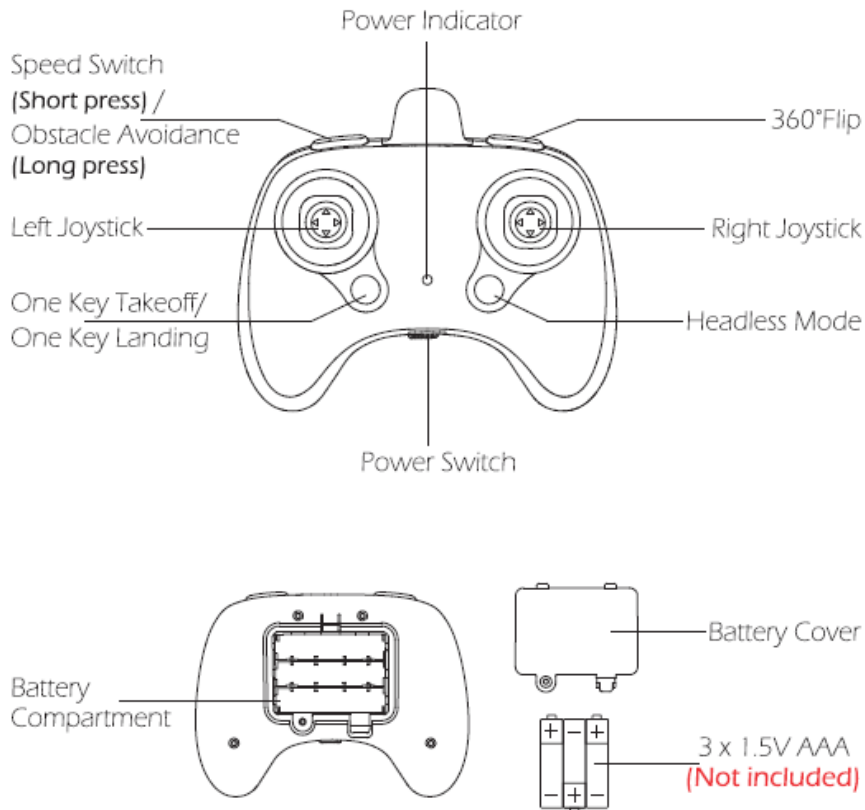

Open the battery cover on the back of the transmitter, insert the three AAA batteries **(Not included)** into the battery compartment, and close the battery cover to complete the installation.

**⚠** When installing the battery, please pay attention to the positive and negative polarity of the battery to ensure the correct installation of the battery.

## 7.0 JOYSTICK MODE

### 7.1 MODE 2 (Default Setting)

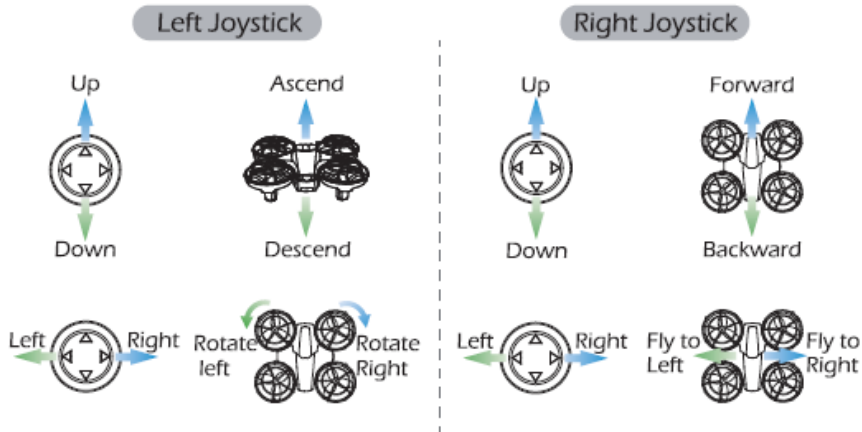

### 7.2 MODE 1

To enter MODE 1, turn on the transmitter while holding the “One Key Takeoff/ Landing” button. (Please do not release the “One Key Takeoff/ Landing” button until the transmitter is powered on.)

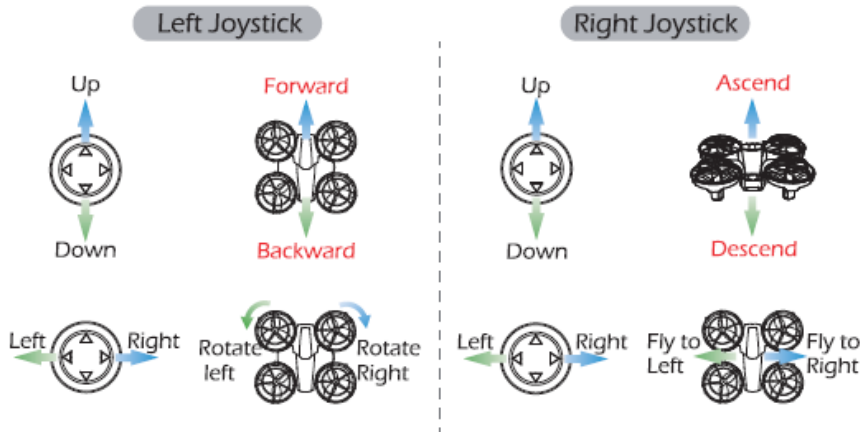

## 8.0 INSTALLATION

### 8.1 Drone's Battery

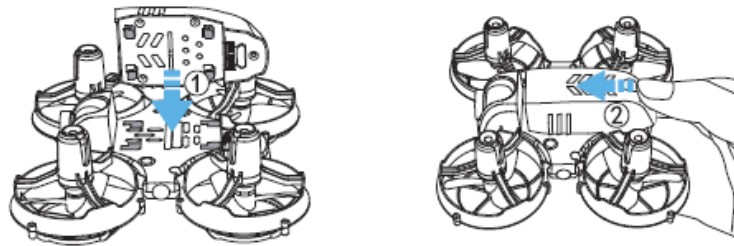

**Installation:** As shown in the figure above, install the battery to the buckle on the back of the drone and push it forward. When you hear a click, the battery is installed. Please make sure the battery is securely installed.

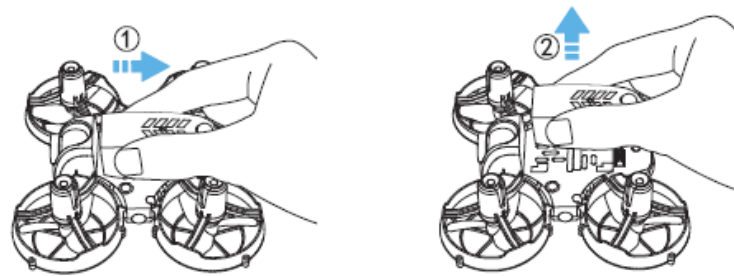

**Removal:** As shown in the figure above, hold down the two sides of the battery and pull it back, then remove the battery upwards.

## 9.0 CHARGING

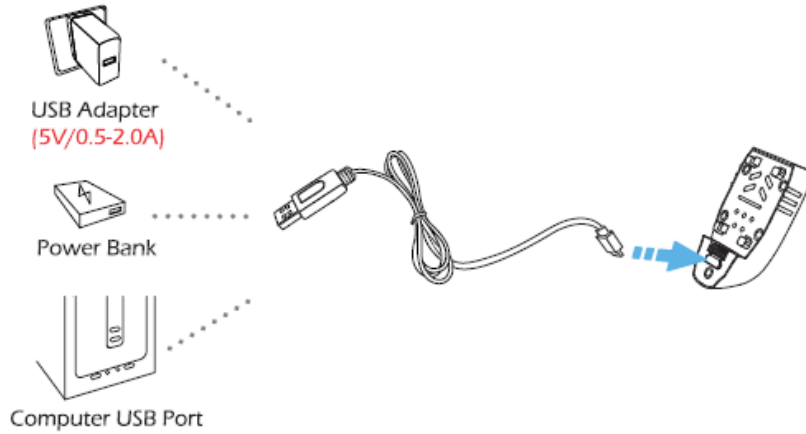

- 1) When the drone battery runs low, the indicator lights on the drone will blink slowly. The drone will land automatically after about 90 seconds.
- 2) Remove the battery and connect the USB charging cable to the battery charging interface.
- 3) Plug the USB charging cable into a USB charging port on the computer, power bank or USB adapter (5V / 0.5 to 2.0A ).
- 4) The red indicator light on the USB charging cable will turn off when the battery is charging, and will turn on when the battery is fully charged.
- 5) Charging time: about 40 minutes.

**!** Before charging, please check the contents of the “ Use of Battery” section of the “ Safety Guidelines” carefully!

This drone has two control modes, namely "Sensor Mode" and "Remote Control Mode". The following will introduce how to operate the drone in two different modes.

## 10.0 SENSOR MODE OPERATION GUIDE

### 10.1 Throw & Go

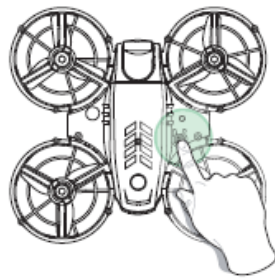

① Long press the Power Switch to turn on the drone.

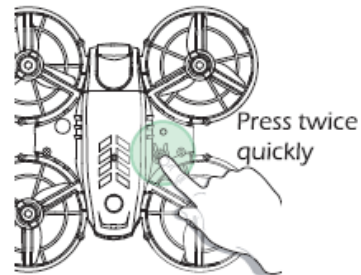

② Press the power button twice quickly to calibrate the gyroscope, and the indicator lights will flash quickly.

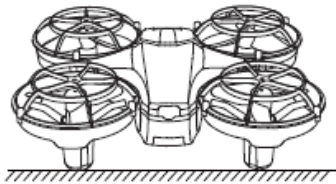

③ Place the drone on a flat and level surface and wait for the indicator lights to turn flash slowly.

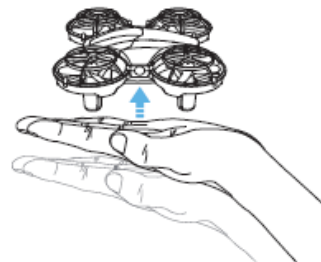

④ Pick up the drone and lay it flat on your palm. Gently toss the drone into air, and it will hover in place.

**Attention:**

Every time you turn on the drone for the first flight, you need to place it on a flat and level surface and wait for the indicator lights to turn flash slowly.

### 10.2 Auto-Rotating

① Place your hands close to the sensors at the HEAD and the TAIL of the drone at the same time for sensing.



② Place your palm quickly under the drone for sensing, at this time the drone will begin to perform high-speed rotation in place. When the palm moves away, the rotation will stop.

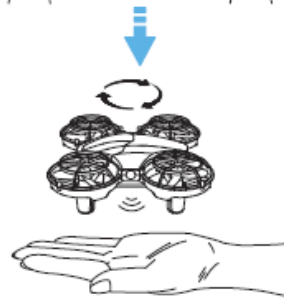

---

### 10.3 Flip & Rolling

① Place your hands close to the sensors on the LEFT and RIGHT sides of the drone at the same time for sensing.

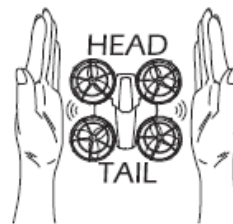

② The drone will roll once in the direction of the head.

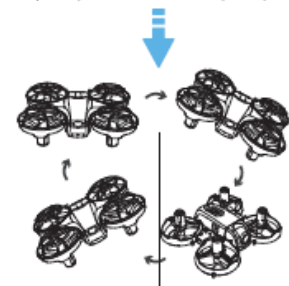

### 10.4 Circle Fly

① Place your hands close to the HEAD and the TAIL of the drone at the same time for sensing.



② Place one of your palms close to either side of the drone for sensing (either side of the fuselage front / rear / left / right is acceptable).



③ The drone will begin to perform the Circle Fly function, and exit automatically after a circle.

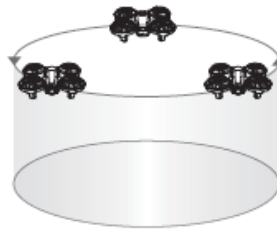



## 11.0 REMOTE CONTROL OPERATION GUIDE

All of the following operations on this manual takes MODE 2 for example.

### 11.1 Pairing

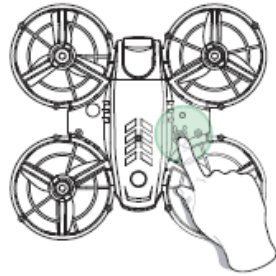

① Long press the Power Switch to turn on the drone.

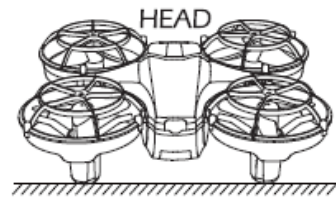

② Place the drone on a flat and level surface with the head forward and the tail towards the pilot.



③ As shown in the picture, turn on the transmitter, it will beep 2 times.



④ Push the throttle joystick up then down to pair the drone with the transmitter. The indicator lights on the drone will turn solid if the drone is paired successfully.

**Tips:** The pairing operation can also be performed when the drone is in the Sensor Mode, then the drone enters the Remote Control Mode from the Sensor Mode.

## 11.2 Calibrating the Gyro



Simultaneously push the left joystick and the right joystick to the bottom left corner to calibrate the gyro. The indicator lights on the drone will blink quickly and turn solid that indicates the calibration is completed.

**Tips:** To ensure a stable flight, we suggest that the pilot calibrates the gyro every time after pairing the drone and after a crash.

## 11.3 One Key Takeoff / Landing

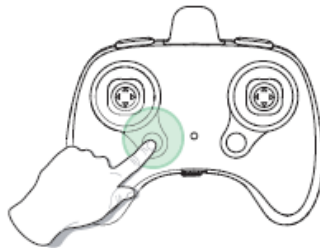

After pairing/ calibration, press the “One Key Takeoff / Landing” button, the drone will automatically take off and hover at 5 feet altitude. At this time, you can control this drone by using the joysticks.

Press the “One Key Takeoff / Landing” button again, the drone will land on the ground by itself .

## 12.0 FUNCTIONS DETAILS

### 12.1 Speed Switch

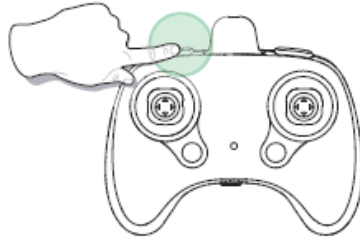

This drone comes with 3 speed modes (Low/ Medium/ High). Press the Speed Switch button to switch the speed. "Di" indicates Low Speed. "Di Di" indicates Medium Speed and "Di Di Di" indicates High Speed.

*(The Low Speed is default speed mode.)*

### 12.2 Emergency Stop

**⚠** The Emergency Stop function can be only used in case of emergency during the flight to avoid any of damage or injury.

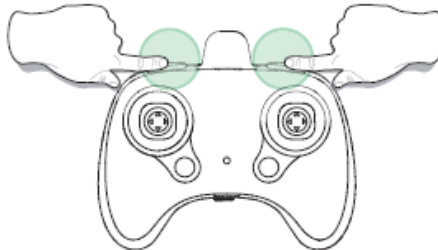

Press the upper left and upper right button of the transmitter at the same time, the motors will stop immediately.

### 12.3 Obstacle Avoidance Mode

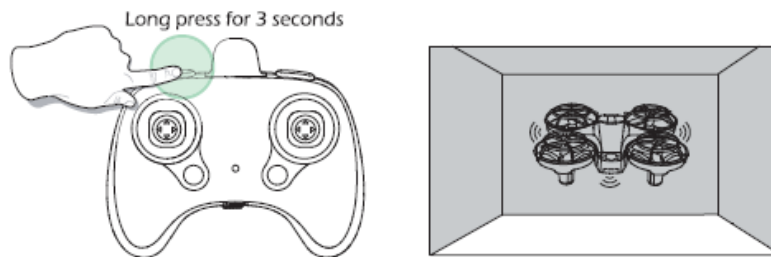

Press and hold the Obstacle Avoidance Mode button for about 3 seconds to enter the Obstacle Avoidance Mode. The transmitter will make a long beep, and the indicator lights on the drone will flash intermittently. In Obstacle Avoidance Mode, the drone will automatically avoid obstacles. And long press the same button again to exit the Obstacle Avoidance Mode.

#### **Tips:**

- The Obstacle Avoidance Mode works best with Headless Mode.
- For objects with a pure white surface, the drone has the best obstacle avoidance effect. The distance of obstacle avoidance is 50cm to 80cm.



The precision and distance of the Obstacle Avoidance Mode is easily affected by the light strength and color of the surface. Be cautious to operate the drone in the following situation:

1. Near monochrome surfaces, like pure black.
2. Close to strong light reflective surfaces or surfaces prone to reflection.
3. Close to water or transparent object surfaces.
4. Close to moving object surfaces (such as crowds, swaying juggles and glass).
5. In an area where light changes dramatically and rapidly.
6. Close to extremely dark ( $\text{lux} < 10$ ) or extremely bright ( $\text{lux} > 10,000$ ) surfaces.

## 12.4 360° Flip

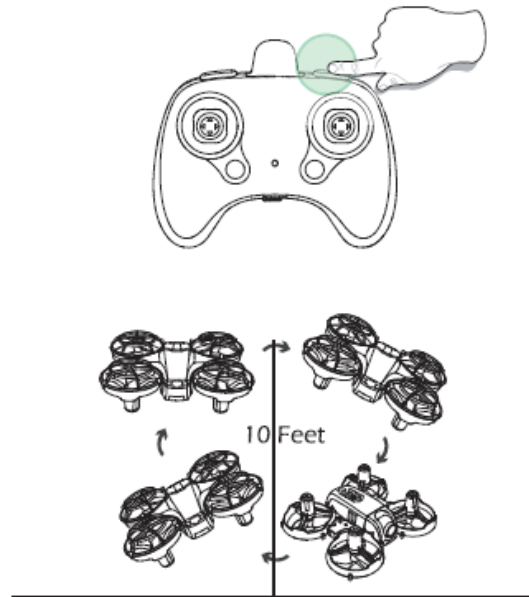

When you get familiar with all the functions of the drone, you can try this amazing flip mode. When you fly the drone at least 10 feet, press the 360° Flip button on the transmitter, then push the right joystick Forward/ Backward or Left/ Right, and the drone will do a flip towards the corresponding direction.

If you are in MODE 1, push the right joystick Left/ Right or push the left joystick Forward/ Backward, and the drone will do a flip towards the corresponding direction.

**Tips:** This function will perform better when the battery is fully charged.

## 12.5 Headless Mode

1. After pairing/ calibration, or during the flight of the drone, press the Headless Mode button on the transmitter. The indicator lights on the drone start to flash continuously, and the transmitter will beep constantly to indicate that drone is in Headless Mode.

2. Press the Headless Mode button again, and you will hear one beep, the indicator lights on the drone will be solid which indicates the drone exits the Headless Mode.

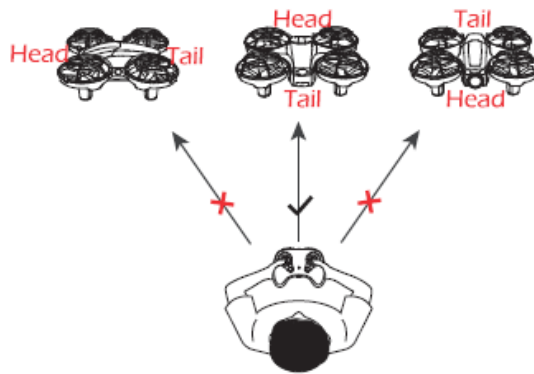

Please make the pilot stays facing the same direction as the direction that the head of the drone faces at take-off.

Under Headless Mode, the forward direction is the direction that the head of drone faces when the drone takes off. In order to make sure the pilot can tell drone's direction, we recommend that pilots to stay in the same orientation as the drone head faces when the drone takes off. If so, when the pilot pushes the direction joystick forward, the drone will fly forward. If the pilot pushes the direction joystick backward, the drone will fly towards him/her. If the pilot move the right stick left / right, the drone will move left/ right relative to you. It is very important that the pilot stay in the same orientation as the drone head faces when the drone takes off.

## **13.0 SPECIFICATIONS**

- **DRONE**

Model: HS330

Weight: 33g/ 1.2oz

Flight Time: about 7 minutes (per battery)

Motor Model: 615

Operating Temperature Range: 32° to 104°F (0° to 40°C)

Dimensions: 82 x 90 x 27 mm

- **DRONE BATTERY**

Capacity: 300mAh

Voltage: 3.7 V

Battery Type: Li-Po Battery

Charging Temperature Range: 41° to 104°F (5° to 40°C)

Charging Time: 40 minutes (depends on charging power and remaining battery power)

- **TRANSMITTER**

Operating Frequency: 2.4 GHz

Transmission Distance: 164~262 feet / 50~80m (outdoors and unobstructed)

Operating Temperature Range: 32° to 104°F (0° to 40°C)

Battery: 1.5V AAA Battery (not included)

- **USB CHARGING CABLE**

Voltage: 5 V

Rated Power: ≤10 W

## **14.0 CONTACT US**

Please do not hesitate to contact us if you need further support.

- ✉ [holyton@foxmail.com](mailto:holyton@foxmail.com) (USA)
- [holyton\\_ca@foxmail.com](mailto:holyton_ca@foxmail.com) (CA)
- [holyton\\_jp@foxmail.com](mailto:holyton_jp@foxmail.com) (JP)
- [holyton\\_eu@foxmail.com](mailto:holyton_eu@foxmail.com) (EU)



## **15.0 GENERAL INFORMATION**

FCC Notice:

This device complies with Part 15 of the FCC Rules.

Operation is subject to the following two conditions:

- (1) This device may not cause harmful interference.
- (2) This device must accept any interference received, including interference that may cause undesired operation.

NOTE: This equipment has been tested and found to comply with the limits for a Class B digital device, pursuant to Part 15 of the FCC Rules. These limits are designed to provide reasonable protection against harmful interference in a residential installation. This equipment generates uses and can radiate radio frequency energy and, if not installed and used in accordance with the instructions, may cause harmful interference to radio communications. However, there is no guarantee that interference will not occur in a particular installation. If this equipment does cause harmful interference to radio or television reception, which can be determined by turning the equipment off and on, the user is encouraged to try to correct the interference by one or more of the following measures:

- Reorient or relocate the receiving antenna.
- Increase the separation between the equipment and receiver.
- Connect the equipment into an outlet on a circuit different from that to which the receiver is connected.
- Consult the dealer or an experienced radio/TV technician for help.

WARNING: Changes or modifications not expressly approved by the party responsible for compliance could void the user's authority to operate the equipment.

RF Exposure

The equipment complies with FCC radiation exposure limits set forth for an uncontrolled environment. This device should be installed and operated with minimum distance 20cm between the radiator & your body.

IC Notice:

This device complies with Canada Industry licence-exempt RSS standard(s).

Operation is subject to the following two conditions:

- (1) this device may not cause interference; and
- (2) this device must accept any interference. Including interference that may cause undesired operation of the device.

CAN ICES-3 (B)

Avis d'Industrie Canada

Le présent appareil est conforme aux CNR d'industrie Canada applicables aux appareils radio exempts de licence. L'exploitation est autorisée aux deux conditions suivantes:

- 1) l'appareil ne doit pas produire de brouillage; et
  - 2) l'utilisateur de l'appareil doit accepter le brouillage radioélectrique subi même si le brouillage est susceptible d'en compromettre le fonctionnement.
- Cet appareil numérique de la classe B est conforme à la norme NMB-003 du Canada.

CAN NMB-3 (B)

RF Exposure

Radiation Exposure Statement:

This equipment complies with IC radiation exposure limits set forth for an uncontrolled environment. This equipment should be installed and operated with minimum distance 20cm between the radiator & your body.

Déclaration d'exposition aux radiations:

Cet équipement est conforme aux limites d'exposition aux rayonnements IC établies pour un environnement non contrôlé. Cet équipement doit être installé et utilisé avec un minimum de 20 cm de distance entre la source de rayonnement et votre corps.

### HOW TO RECYCLE THIS PRODUCT

This symbol on the product or its documentation indicates that it must not be disposed of with household waste.

Uncontrolled waste disposal may harm the environment or human health. Please separate your device from other types of waste to recycle it responsibly.

This will help to foster the sustainable re-use of material resources.

We invite you to contact your retailer or inquire at your local town hall to find out where and how the drone can be recycled.



### BATTERY WARNING:

1. Failure to follow all the instructions may result in serious injury, irreparable damage to the battery and may cause a fire, smoke or explosion.
2. Always check the battery's condition before charging or using it.
3. Replace the battery if it has been dropped, or in case of odour, overheating, discolouration, deformation or leakage.
4. Never use anything other than the approval LiPo charger the battery. Always use a balancing charger for LiPo cells or a LiPo cell balancer. It is recommended that you do not to use any other charger than the one provided with the product.
5. The battery temperature must never exceed 60°C(140°F) otherwise the battery could be damaged or ignite.

6. Never charge on a flammable surface, near flammable products or inside a vehicle (preferably place the battery in a non-flammable and nonconductive container).
7. Never leave the battery unattended during the charging process. Never disassemble or modify the housing's wiring, or puncture the cells. Always ensure that the charger output voltage corresponds to the voltage of the battery. Do not short circuit the batteries.
8. Never expose the LiPo battery to moisture or direct sunlight, or store it in a place where temperatures could exceed 60°C (car in the sun, for example).
9. Always keep it out of reach of children.
10. Improper battery use may result in a fire, explosion or other hazard.
11. Non-rechargeable batteries are not to be recharged. Rechargeable batteries are only to be charged under adult supervision.
12. Different types of batteries or new and used batteries are not to be mixed.
13. Batteries are to be inserted with the correct polarity.
14. The supply terminals are not to be short-circuited. Regular examination of transformer or battery charger for any damage to their cord, plug, enclosure and other parts and they must not be used until the damage has been repaired.
15. The packaging has to be kept since it contains important information.
16. The toy is only to be connected to Class II equipment bearing the symbol. 

## ***Holyton***

---

EU RF Power(EIRP): 22.75dBm (2404MHz ~ 2480 MHz)

### **Caution**

- 1.The max operating of the EUT is 45°C. and shouldn't be lower than -10°C.
- 2.The device complies with RF specifications when the device used at 0mm form your body.
- 3.Declaration of Conformity.

We, Xiamen Huoshiquan Import & Export CO., LTD hereby, declare that the essential requirements compliance with the Directive 2014/53/EU, the RoHS Directive 2011/65/EU and Safety Directive 2009/48/EC have been fully fulfilled on our product with indication below:

Product Name: Remote control four axis series

Model/Mark : HS330/Holyton

The Statement of compliance is available at the following address:

[http://www.holystone.com/docs/HS330\\_EU\\_DOC.pdf](http://www.holystone.com/docs/HS330_EU_DOC.pdf)

This product can be used across EU member states.

### **MANUFACTURER INFORMATION**

Manufactured by

Xiamen Huoshiquan Import & Export CO., LTD

Room 703,No. 813-2 Xiahe Road, Siming District, XIAMEN, China

+1(855) 888-6699



**Made in China**