

Dongguan Lixinwei Electronics Co., Ltd
Antenna Specification for Approval

Customer Name: Yuyuan

Address: _____

Product Name: 2.4G antenna

Part NO. : C113H-BT450-120

Write By: Zhou Min

Issued Date: 2022-7-5

Customer:

R&D Dept	usiness Dept	Approved By

Supplier

R&D Dept	Engineer Dept	Approval
Ni Sheng	Zhang Ming	xiong

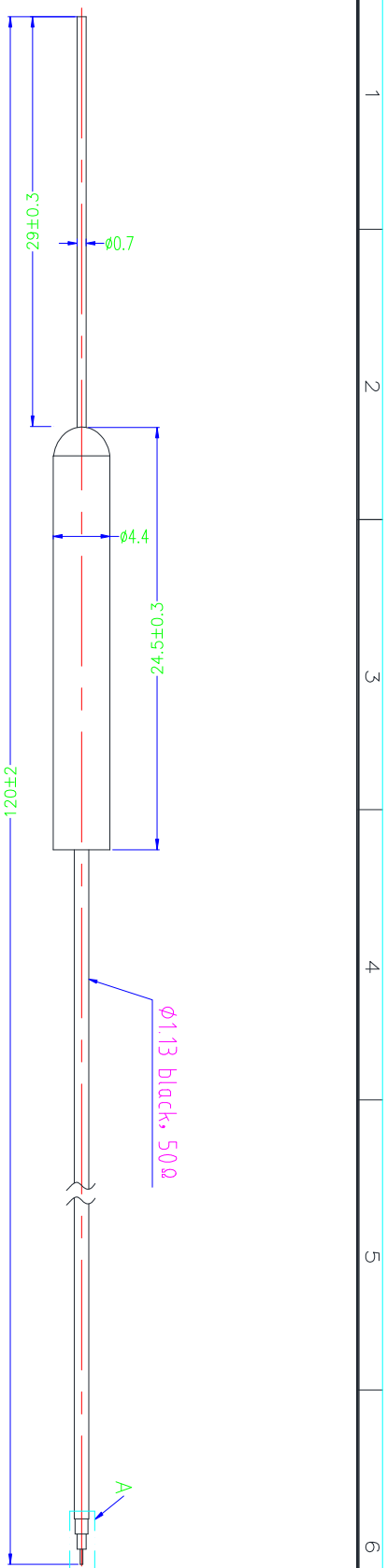

description:
 1. frequency range: 2.4GHz-2.5GHz;
 2. Power gain: 2.98dBi.

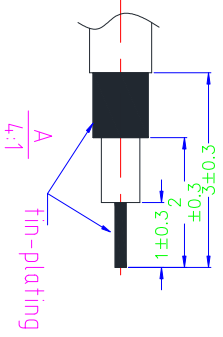

TITLE: 2.4G antenna		MATERIAL: _____		FINISH: _____	
PART/NO.: C113H-BT450-120		TOLERANCE ??		ANGULAR??	
UNIT IN	SCALE:	L < 30	± 0.10	XXX	± 0.1°
mm	??	30 < L < 100	± 0.15	XX	± 0.2°
	DATE	L > 100	± 0.20	UNLESS	OTHERWISE SPECIFIED
DRAWING	DATE	CHECKING	DATE	REV	01
	21-06-25				

Dongguan Lixinwei Electronics Co., Ltd

Product Specification

A. Electrical Characteristics

Frequency 2400MHz ~2500MHz

VSWR <2.0

Efficiency >77%

Impedance 50 Ohm

Polarization Line

Gain 2.98DBi

B. Material & Mechanical Characteristics

Material of Radiator Cu

Cable Type 1.13 black

Connector Type : NO

Dimension

C. Environmental

Operation Temperature - 30 °C ~ + 80 °C

Storage Temperature - 30 °C ~ + 85 °C

Test Equipment & Conditions

1. Network Analyzers :

Agilent 8753D 5071B

2. Communications Test Set:

Agilent E5515C

3. 3D Chamber Test System

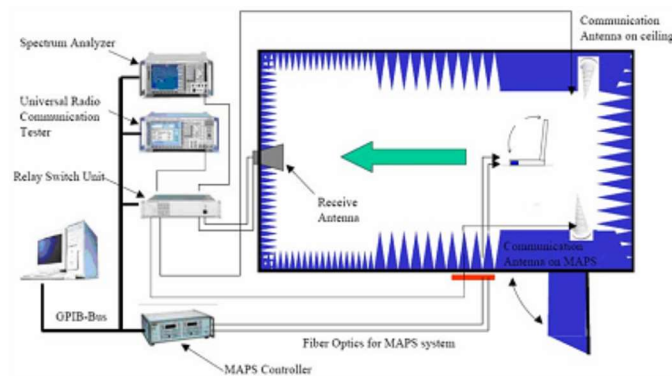

(Testing by 3D anechoic chamber)

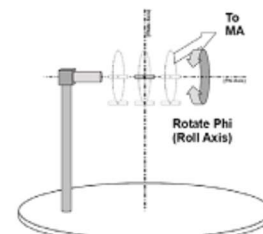

Phi axis test

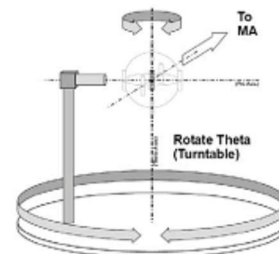

Theta axis test

Efficiency & Gain

Freq (MHz)	Effi (%)	Gain (dBi)
2400	73.92	2.42
2410	74.83	2.85
2420	74.64	2.83
2430	76.56	2.98
2440	66.64	2.52
2450	72.12	2.71
2460	71.91	2.83
2470	72.96	2.78
2480	72.39	2.86
2490	68.38	2.71
2500	67.47	2.29

S11

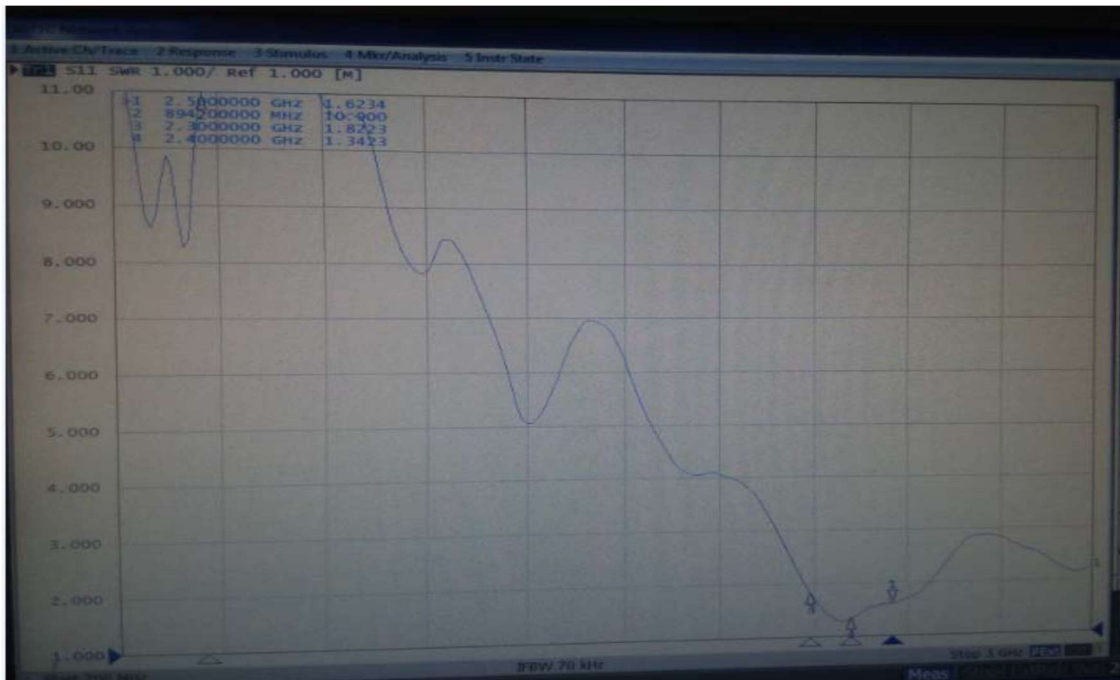

Radiation Pattern:

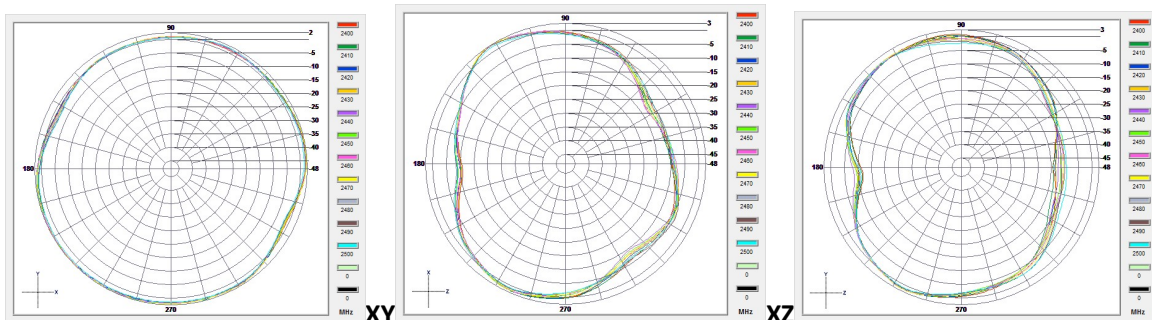

YZ

2400 2410 2420 2430 2440 2450 2460 2470 2480 2490 2500

