

Tip: Safe to Fly (GPS)

The Default GPS Mode is BEGINNER MODE, Under BEGINNER MODE:

1. Flight Distance is limited between 0-30 M/0-98.4 Feet.
2. Flight Altitude is limited between 0-30 M/0-98.4 Feet.
3. RTH Altitude is under 25 M/82 Feet.

You only can Turn-off the BEGINNER MODE to modify the parameters in the APP on your phone after you complete the Compass Calibration operations.



Flight Setting
On APP

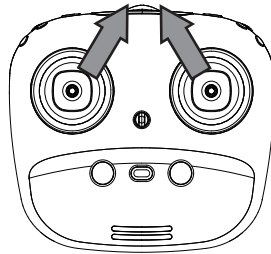

2. Compass Calibration

① Compass Calibration Part 1

- Push Joysticks at 1 & 11 o'clock positions as shown by the picture above.
- Lights rapidly alter between Purple (Back) and Pink (Front) .
- App Drone Status: "Compass calibration".

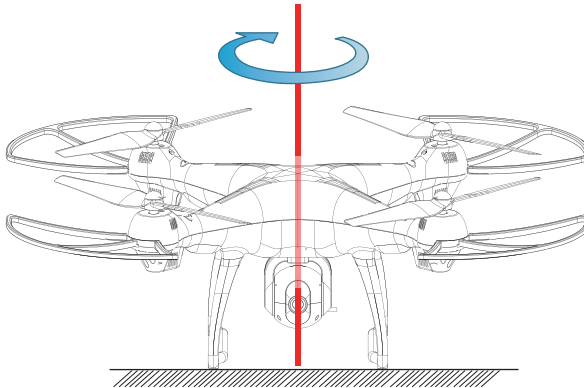

② Compass Calibration Part 2

- Hold the drone horizontally; turn your body 360 degrees and the back lights will turn solid purple.

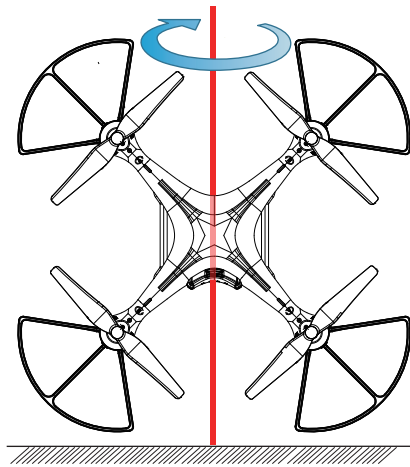

③ Compass Calibration Part 3

—Hold the drone vertically and camera is facing the ground; spin your body 360 degrees. The front Pink lights and the rear Purple light will turn to solid.

Compass only need to calibrate when first fly the drone in a new area.

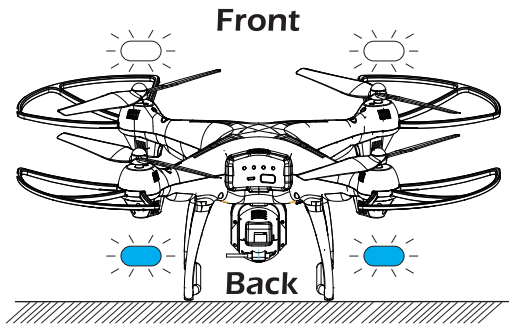

3. GPS Searching (DO NOT use GPS Mode indoor)

- Place the Drone on a flat and dry surface and in an unobstructed and lit area.
- LED Flight Indicators will turn to blink Blue (Back) and White (Front). This means the drone is Searching the GPS Signal.

This process can take a few minutes. App Drone Status: "Waiting for GPS signal".

Once the lights have turned all solid, GPS Mode is Ready(Drone can only take off when it is connected to GPS successfully).

- Blue (back) and white (front) lights are all solid (no blinking).
- App Drone Status: "Ready to fly".

ATTENTION:

- ① If the LED Flight Indicators keep blinking quickly, it indicates drone is searching for GPS signals.
- ② If the drone keep blinking quickly after a few minutes, it indicates that the process has FAILED. Please taking the drone a meter or so from the ground, and repeat all the Compass Calibration operations until the process is successful.
- ③ If you fly indoors, please hold  button for 3 second to exit GPS Mode, and the LED lights will blink slowly. you can fly this drone when you complete the Compass Calibration operations if you exit GPS mode.

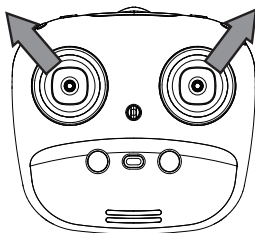

4. Recalibrate Gyroscope

- Push the Joysticks at 11 & 1 o'clock positions as shown by the picture above.
- Lights will blink rapidly in both Blue (Back) and White (Front).
- App Drone Status: "Gyroscope is being calibrated" → "Gyroscope okay".

Note: You can also calibrate the Drone if it does not stay on course correctly.

5. Using the Application

Connect your smart phone to the Wi-Fi of the Drone (Take this step when you finish pairing the drone) and check the drone's status on the "HS GPS PRO" App.

- ① Power on the Drone.
- ② On your smartphone, launch a search of the available Wi-Fi networks:
if you are using an iPhone or an iPad, select Settings>Wi-Fi;
if you are using an Android smartphone, select Settings > Wireless and networks >Wi-Fi.
- ③ Select the Wi-Fi network: **HolyStoneFPV_xxxxx**
- ④ Wait for your smartphone connect to the Wi-Fi network of the drone.
This connection is generally represented by the Wi-Fi logo appearing on your smartphone's screen.
- ⑤ Enter the **HS GPS PRO** application.

> The connection between your smartphone and the Drone is established automatically.

APP Functions

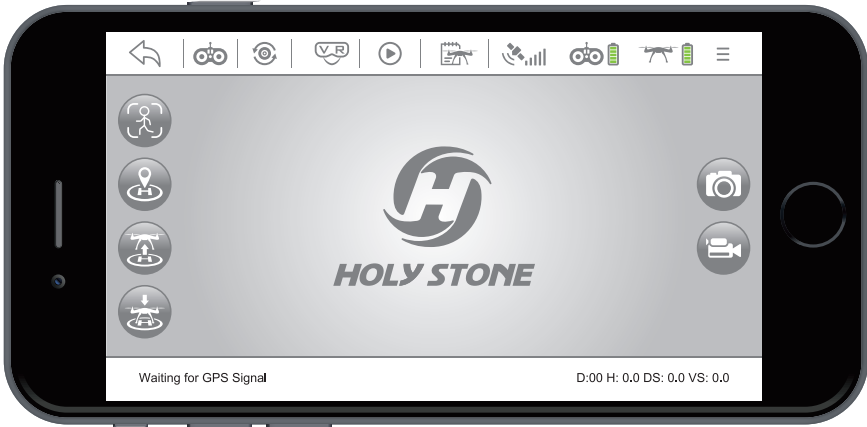

 Back to Main Menu

 Controls ON/OFF

 Flip Screen

 GPS Signal

 Transmitter Battery

 VR Split Screen

 Media Gallery

 Flight Record

 Flight Setting

 Drone Battery

 Follow Me

 Auto Take-off

 Take Photo

 Return Home

 Auto Land

 Take Video

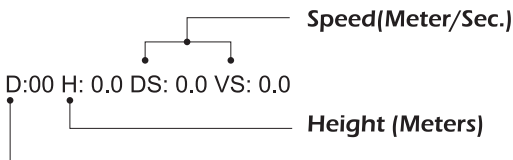

Waiting for GPS Signal

Drone Status

Take-off/Landing/Emergency Stop

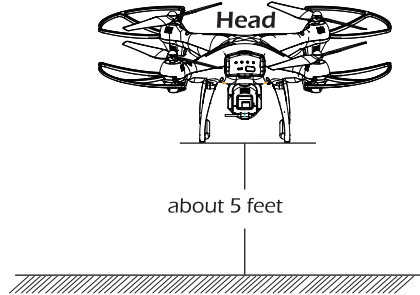
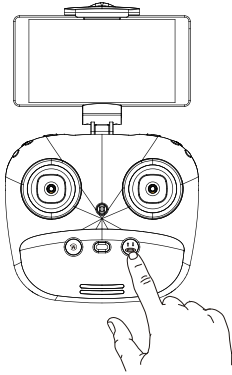

! Rotating propellers can be dangerous. Do not start the motors when there are people nearby.

Press , the propellers will spin and the drone will take off at an altitude of about 5 feet. *(Always keep the head of drone facing forward).*

Press  again, the drone will land automatically. Remember to always keep your hands on the transmitter as long as the motors are spinning.

!  **Hold 2 secs for EMERGENCY STOP.**

Only stop motors mid-flight in an emergency. Doing so can reduce the risk of damage or injury.

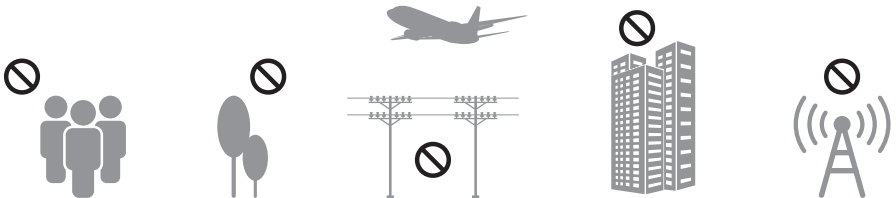

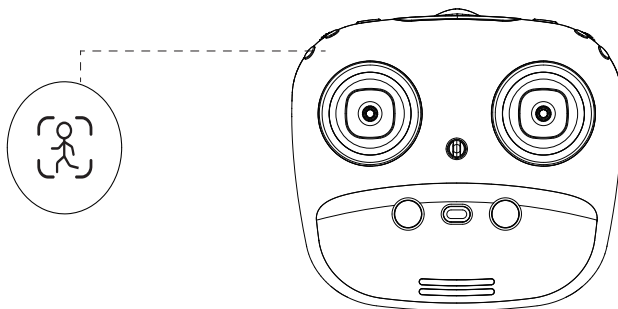

Follow Me



When the Follow Me function is activated, the drone will follow the GPS in your smartphone to follow you wherever you go.

Follow Me Mode:



1. Set drone at least 10 feet high and 100 feet distance position.
2. Click the  on the transmitter or app interface .
3. Wait for the HS GPS PRO app Drone Status to display “Follow Me ready” — the drone will now follow the phone’s coordinates.
4. To exit Follow Me mode, simply click the  on the transmitter or app interface again.

Common Issues :

Follow Me mode would be hard to activated if the phone’s GPS signal is too weak, this could be due to the signal loss from surrounding buildings, trees, or congestion from too many mobile phones in the area.

- * Use in an open area and be mindful of your surroundings. The drone is NOT equipped with obstacle avoidance.

Trim under NO GPS Mode

If the drone flies under NO GPS Mode, you can trim the drone to obtain a more balanced flight. Press  for 3 seconds, and you will enter the trim mode. Push the direction stick to the opposite side that the drone drifts to rebalance the drone. For example, if the drone drifts to the left, push the direction stick to the right to make the drone more balanced. Press  again to exit the Trim Mode.

Return-to-Home (RTH)

The Return to Home (RTH) function brings the drone back to the last recorded Take Off Point. **This function can only be achieved in GPS mode.** There are three types of RTH:

Smart RTH / Low-Battery RTH / Failsafe RTH.

1. Smart Return To Home

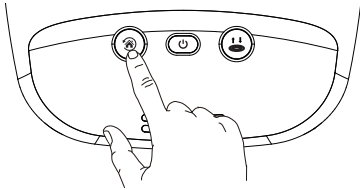

RTH Button



The app's RTH Button

Press the Return to Home Button on your Transmitter or tap on the App of your smart phone, and the transmitter will start beeping. Your drone will return to the TAKE OFF Point. Press the button again to stop RTH procedure. Push the throttle joystick down to land the drone on a safe area.

2. Low-Battery RTH

Low-Battery RTH is triggered when the Flight Battery level is low. When Low-Battery RTH is activated, the drone will fly back to where you are from about 100 feet, and you can still control your drone. Push the throttle down to land the drone in a safe area. When the power of drone is completely empty, drone will return to the TAKE OFF point where you set.

3. Failsafe RTH

Drone will enter Return to Home Mode if the signal between the drone and the transmitter is lost. The drone will fly back to where you are from about 100 feet, and the drone will rebind to the transmitter by itself. When the drone flies back into your view, you can control it again.



WARNING:

This drone is NOT equipped with obstacle-avoidance.

Headless Mode

Hold the  on the transmitter for 3 secs to exit GPS MODE.

Press the  on the transmitter to enter Headless Mode.

Press the  again to exit Headless Mode.

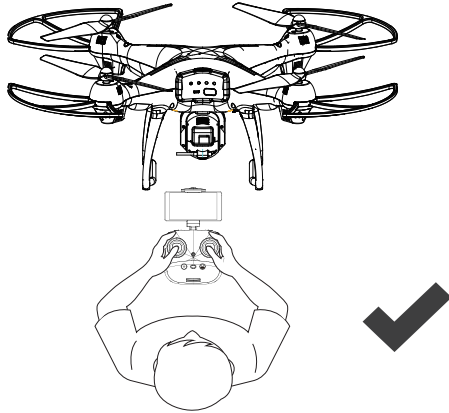

The control direction when the drone is paired.



Don't turn your direction.



Don't turn your direction.

Under Headless Mode, the forward direction is where the direction of the pilot faces when the pilot pairs the drone with the transmitter. If the pilot pushes the direction joystick forward, the drone will fly forward. If the pilot pushes the direction joystick backward, the drone will flight towards him/her. If the pilot moves the right stick left or right, then the drone will also move left or right relative to you. It is very important that the pilot does not change positions or the direction he or she is facing because this will cause confusion to the drone.

Camera Functions

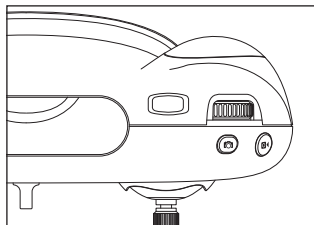





Take Photo



Take Video

ICON on APP

Press  on the Transmitter or tap  on APP, the red indicator on camera will flash once, indicating the camera has taken a photo.

Press  on the Transmitter or tap  on APP, the red indicator will keep flashing, indicating the camera is capturing a video. Press  again to save the video.

Do not take photo when shooting a video.

NOTE: When using the HS-GPS PRO app, the original photos and videos will be compressed and saved to the smart phone.

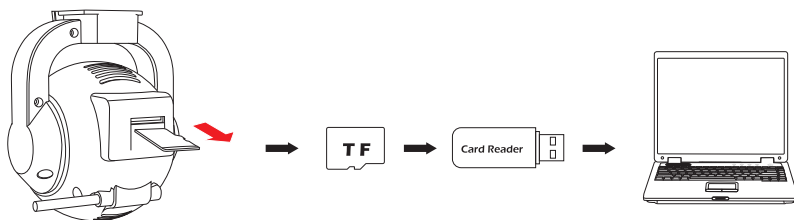

The Original images and videos are saved in the TF card.

Press the TF card slightly to take it out, then insert the card into the card reader and insert it into the USB outlet of a computer to read the data from TF card.

The images can be also viewed in the App.

Replace the Landing Gear

- 1) Letter "L" and "R" is printed on each side of a landing gear shell. "L" is the mark of the left landing gear as "R" is for the right landing gear.
- 2) There are two locks on the bottom; Press and hold down the lock, and pull the lock-side landing gear out.

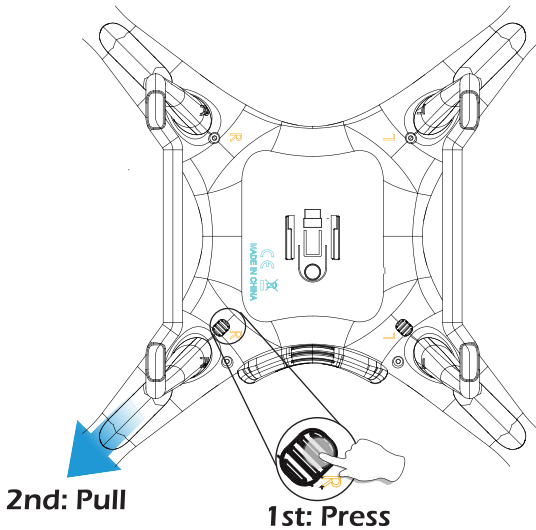

- 3) Rotate landing gears outside at angle of about 90 degrees to take the landing gear out.

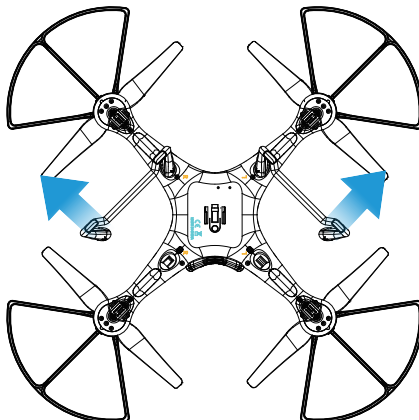

Specifications

● Drone

MODEL: HS100

Weight (Including Battery) : 700 g / 24.7 oz

Flight Time: 12-15 minutes

WIFI Distance: 492 feet/150m (Outdoor and Unobstructed)

Motor Model: 180

Hovering: Enabled

Operating Temperature Range : 32° to 104° F (0° to 40° C)

Satellite Systems GPS / GLONASS

Dimensions: 500*500*175mm

● Gimbal

Controllable Range: Pitch: -90° to 0°

● Camera

Lens: FOV 120°/2.0

Still Photography Modes: Single shot

Video Recording Modes: HD1280*720 P

Photo: JPEG

Video: AVI

Supported SD Cards: TF Card 8GB included

Operating Temperature: 32° to 104° F (0° to 40° C)

● APP / Live View

Mobile App: HS GPS PRO

Live View Working Frequency: 2.4 GHz ISM

Live View Quality: 720P @ 20fps

Latency: Low Latency Video (depend on conditions and mobile device)

Required Operating Systems: iOS 8.0 or later / Android 4.4.0 or later

Recommended Devices: 4.7" to 5.5" Smart phones

● Transmitter

Operating Frequency: 2.4GHz

Max transmission distance: 1640 feet/500m (Outdoor and Unobstructed)

Battery: 300 mAh / Lipo

Operating Voltage: 3.7V

Mobile Device Holder: 4.7" to 5.5" Smart Phones

Operating Temperature: 32° to 104° F (0° to 40° C)

● Flight Battery

Capacity: 2500 mAh

Voltage: 7.4V

Battery Type: LiPo

Energy: 18.5Wh

Net Weight: 175 g / 6.1oz

Max Charging Power: 5-10W

Max Charging Time: 3-6 hours (Depending on Charging Power)

Charging Temperature Range: 14° to 104° F (-10° to 40° C)

● USB Cable

Voltage: 5V

Rated Power: ≤10 W

Common Problems and Solutions

| THE PROBLEMS | REASONS | SOLUTIONS |
|--|---|---|
| Drone flashes and don't respond to the transmitter during operation. | <ol style="list-style-type: none">1. Transmitter is not synced to the drone.2. Insufficient battery power. | <ol style="list-style-type: none">1. Refer to the Manual and re-sync the drone.2. Recharge the battery. |
| The propellers spin, but the drone cannot take-off. | <ol style="list-style-type: none">1. Insufficient battery power.2. The propellers are installed in wrong orientation.3. The propellers are distorted. | <ol style="list-style-type: none">1. Recharge the battery.2. Install the propellers in right orientation.3. Replace the propellers. |
| The drone shakes heavily. | The propellers are distorted. | Replace the propellers. |
| Drone cannot stay balanced in flight. | <ol style="list-style-type: none">1. The propellers are distorted.2. The motor doesn't work properly. | <ol style="list-style-type: none">1. Replace the propellers.2. Replace the motor. |
| Drone is unstable after crashing. | Four-axis acceleration sensor loses it's balance after crashing. | Restart and re-calibrate the drone. |

For more further technical support, please do not hesitate to contact us via Email or Hot Line Phone Call.

usa@holystone.com (America)

ca@holystone.com (Canada)

eu@holystone.com (Europe)

jp@holystone.com (Japan)

 +1(855) 888-6699

General Information

FCC Notice:

This device complies with Part 15 of the FCC Rules.

Operation is subject to the following two conditions:

(1) This device may not cause harmful interference.

(2) This device must accept any interference received, including interference that may cause undesired operation.

NOTE: This equipment has been tested and found to comply with the limits for a Class B digital device, pursuant to Part 15 of the FCC Rules. These limits are designed to provide reasonable protection against harmful interference in a residential installation. This equipment generates uses and can radiate radio frequency energy and, if not installed and used in accordance with the instructions, may cause harmful interference to radio communications. However, there is no guarantee that interference will not occur in a particular installation. If this equipment does cause harmful interference to radio or television reception, which can be determined by turning the equipment off and on, the user is encouraged to try to correct the interference by one or more of the following measures:

- Reorient or relocate the receiving antenna.
- Increase the separation between the equipment and receiver.
- Connect the equipment into an outlet on a circuit different from that to which the receiver is connected.
- Consult the dealer or an experienced radio/TV technician for help.

WARNING: Changes or modifications not expressly approved by the party responsible for compliance could void the user's authority to operate the equipment.

RF Exposure

The equipment complies with FCC radiation exposure limits set forth for an uncontrolled environment. This device should be installed and operated with minimum distance 20cm between the radiator & your body.

IC Notice:

This device complies with Canada Industry licence-exempt RSS standard(s).

Operation is subject to the following two conditions:

- (1) this device may not cause interference; and
- (2) this device must accept any interference. Including interference that may cause undesired operation of the device.

CAN ICES-3 (B)

Avis d'Industrie Canada

Le présent appareil est conforme aux CNR d'industrie Canada applicables aux appareils radio exempts de licence. L'exploitation est autorisée aux deux conditions suivantes:

- 1) l'appareil ne doit pas produire de brouillage; et
 - 2) l'utilisateur de l'appareil doit accepter le brouillage radioélectrique subi même si le brouillage est susceptible d'en compromettre le fonctionnement.
- Cet appareil numérique de la classe B est conforme à la norme NMB-003 du Canada.

CAN NMB-3 (B)

RF Exposure

Radiation Exposure Statement:

This equipment complies with IC radiation exposure limits set forth for an uncontrolled environment. This equipment should be installed and operated with minimum distance 20cm between the radiator & your body.

Déclaration d'exposition aux radiations:

Cet équipement est conforme aux limites d'exposition aux rayonnements IC établies pour un environnement non contrôlé. Cet équipement doit être installé et utilisé avec un minimum de 20 cm de distance entre la source de rayonnement et votre corps.

HOW TO RECYCLE THIS PRODUCT

This symbol on the product or its documentation indicates that it must not be disposed of with household waste.

Uncontrolled waste disposal may harm the environment or human health.

Please separate your device from other types of waste to recycle it responsibly.

This will help to foster the sustainable re-use of material resources.



We invite you to contact your retailer or inquire at your local town hall to find out where and how the drone can be recycled.

BATTERY WARNING:

- 1.Failure to follow all the instructions may result in serious injury, irreparable damage to the battery and may cause a fire, smoke or explosion.
- 2.Always check the battery's condition before charging or using it.
- 3.Replace the battery if it has been dropped, or in case of odour, overheating, discolouration, deformation or leakage.
- 4.Never use anything other than the approval LiPo charger the battery. Always use a balancing charger for LiPo cells or a LiPo cell balancer. It is recommended that you do not to use any other charger than the one provided with the product.
- 5.The battery temperature must never exceed 60°C(140°F) otherwise the battery could be damaged or ignite.
- 6.Never charger on a flammable surface, near flammable products or inside a vehicle (preferably place the battery in a non-flammable and non-conductive container).
- 7.Never leave the battery unattended during the charging process. Never disassemble or modify the housing's wiring, or puncture the cells. Always ensure that the charger output voltage corresponds to the voltage of the battery. Do not short circuit the batteries.
8. Never expose the LiPo battery to moisture or direct sunlight, or store it in a place where temperatures could exceed 60°C(car in the sun, for example).
- 9.Always keep it out of reach of children.
- 10.Improper battery use may result in a fire, explosion or other hazard.

11. Non-rechargeable batteries are not to be recharged. Rechargeable batteries are only to be charged under adult supervision.
12. Different types of batteries or new and used batteries are not to be mixed.
13. Batteries are to be inserted with the correct polarity.
14. The supply terminals are not to be short-circuited. Regular examination of transformer or battery charger for any damage to their cord, plug, enclosure and other parts and they must not be used until the damage has been repaired.
15. The packaging has to be kept since it contains important information.
16. The toy is only to be connected to Class II equipment bearing the symbol.



FAA REGISTRATION: PLEASE FOLLOW ALL FEDERAL, STATE AND LOCAL FAA LAWS. YOU MAY BE REQUIRED TO REGISTER YOURSELF AND YOUR DRONE WITH THE FAA MORE INFO CAN BE FOUND AT: [HTTPS://WWW.FAA.GOV/UAS/GETTING STARTED/](https://www.faa.gov/uas/getting-started/)

After receiving the certificate of registration, you must mark your **unique FAA registration number** on the Drone by any means, such as permanent marker, label, engraving. This number must be readily accessible and maintained in a condition that is readable and legible upon close visual inspection

WARNING: Do **NOT** fly drone near airports or any other un-authorized areas. Follow all rules for Federal Aviation Administration (FAA) regulation summary for Small Unmanned Aircraft Systems (sUAS).

Read: Academy of Model Aeronautics (AMA) Know Before You Fly important information brochure



Made in China