

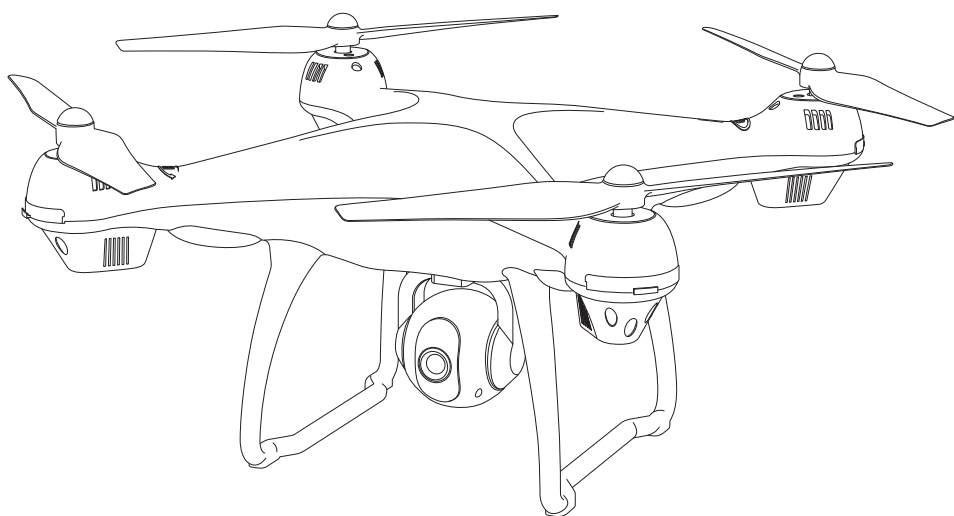

16<sup>+</sup>  
age

# INSTRUCTIONS FOR USE

## HS100 (GPS)



usa@holystone.com (America)

ca@holystone.com (Canada)

eu@holystone.com (Europe)

jp@holystone.com (Japan)



+1(855) 888-6699

[www.holystone.com](http://www.holystone.com)

# Table of Contents

Preface .....	1
Warnings .....	2
Maintenance .....	3
Package Contents .....	4
Drone and Battery .....	6
Assemble the Propeller.....	7
Assemble the Propeller Guard .....	8
Assemble the Camera .....	9
Transmitter Functions .....	10
Fly Safety .....	13
Download the Application .....	15
Charging the Battery .....	15
Flight .....	16
Compass Calibration .....	17
Recalibrate Gyroscope .....	19
APP Functions .....	20
Take-off .....	21
Landing/Emergency Stop .....	21
Follow Me .....	22
Return to Home .....	23
Headless Mode .....	24
Camera Functions .....	25
Replace the Landing Gear .....	26
Specifications .....	27
Trouble Shooting .....	29
Contact Us .....	29
General Information .....	30

To make your experience with this drone as straightforward and convenient as possible, please read this Instructions For Use carefully before operating. Also make sure you Keep it safe for future reference and to kensure safe and enjoyable use of your drone.

## Important Statement

1. This product is not a toy, but a high precision drone that integrates various electronic stability and control mechanisms. This drone requires a correct assembly and setup to ensure a safe and accident free operation. This equipment should always be operated in a safe and controlled manner. Incorrect or dangerous operations may cause damages to the device, property, or cause serious injury to those in the vicinity.
2. This product is suitable for experienced drone pilots over 16 years of age.
3. If you are experiencing difficulties on any aspect of the product, operation or maintenance, please contact your local sales agent or contact customer support here at Holy Stone.

## Safety Guidelines

This product has a flying camera that offers easy, controllable flight when in good working order conditions, however, there is also a significant risk to property or people if flown irresponsibly or within confined spaces. Incorrect assembly or poor control by inexperienced pilots can result in damage to property or harm to people. Be fully aware of your surroundings when flying and always maintain complete control of the vehicle.

### 1. Keep Your Distance.

- a. Always fly in locations that are cleared of obstructions such as buildings, poles, electrical wires, trees and so on.
- b. Never fly above or near people.

### 2. Do not fly in adverse weather conditions.

- a. Keep clear of moisture, fog, ice and excessive wind.
- b. Oly fly in good weather conditions .

### 3. Use and maintain the product according to the Instructions For Use.

- a. Operate this device legally in accordance with instructions provided and with local laws and regulations.
- b. Always use original parts made by Holy Stone for maintenance and repair.

### 4. Do not operate the device alone.

- a. If you are a new pilot, seek assistance from an experienced drone pilot as you learn.
- b. Have others around to help you fly.

### 5. Safety First every time.

- a. Always operate the drone within your limits as a pilot. If you are ill, disoriented, or unsure of how to effectively fly the drone, please seek help to avoid accidents.

### 6. Keep clear of spinning parts.

- a. During operation, the rotors revolve extremely quickly, please avoid contact with the propellers and ensure that foreign objects are kept clear of all moving parts.

### 7. Avoid exposure to excessive heat.

- a. Due to the numerous material types used in construction, this drone is not suitable when exposed to heat. Please keep your device away from heat sources and avoid prolonged exposure to direct sunlight. High temperatures can distort the structure of the device, Please check for any damages before flight.

## <WARNINGS>

1. The information within this package is important for the safe operation and maintenance of your drone. Please keep it safe for future reference.
2. You accept sole responsibilities for any injury, loss or damage that result from your operation of the device.
3. Always follow the instructions when assembling or operating the drone. Always keep at least 6 feet between the user and viewers from the model to avoid risk of injury. Pay attention to the device at all times while in flight.
4. Neither Holy Stone nor any distributors or agents accept any responsibility for loss, injury or damage caused by incorrect operation of the drone.
5. This drone is not suitable for children under the age of 16. Younger pilots should always operate the drone under adult supervision.
6. Please make sure assembly instructions are followed correctly to ensure proper operation and performance of your drone.
7. This product contains many small parts. To avoid choking hazards, please keep this drone and all its components out of children's reach.
8. You must not, under any circumstances, fly this drone over open water or near any public road due to increased the risk of accidents..
9. Keep all packaging materials away from children and dispose them safely.
10. The internals of the drone are not user serviceable, please do not attempt to disassemble this drone or replace any part of the drone, to avoid malfunctions during flight.
11. Please ensure batteries are fitted in the correct orientation shown in these instructions.
12. You can access the transmitter battery compartment by unscrewing the screws on the battery cover. Always put on the battery cover and tighten the screws securely before use.
13. Only use the charger provided with your drone for safety reasons.
14. The charger is not a toy.
15. Dispose used batteries carefully, do not litter.
16. The power socket must not be removed from the drone. Do not attempt to short-circuit the connection socket.
17. When disposing batteries, do not throw them in fire or leave them to decompose. Keep clear of heat sources and high temperatures at all time.
18. If the device is not going to be used for an extended period, remove batteries to prevent potential damage from battery leakage.
19. Care should be taken to keep your drone away from sources of magnetic interference of other electrical equipment to prevent signal issues during operation.
20. Keep clear of rotating parts and be aware of loose clothing that could become entangled in the rotors causing injury.
21. Be aware of the noise volume the drone produces. Keep your distance to avoid ear damage.
22. The charger socket uses a mini USB 5V connection.
23. Always use the product in compliance with local aviation rules and comply with local authorities should they require you to refrain from operating at any time.

## <MAINTENANCE>

1. Clean the product after each use with a clean and soft cloth.
2. Avoid prolonged exposure to direct sunlight and heat buildup in the drone.
3. This device is not waterproof and must not be submerged in water under any circumstance. Failure to maintain the device completely dry will result in the failure of the unit.
4. Frequently check the charging plug and other accessories for signs of damage. If any part of the device is damaged refrain from flying until maintenance is carried out .

# Package Contents

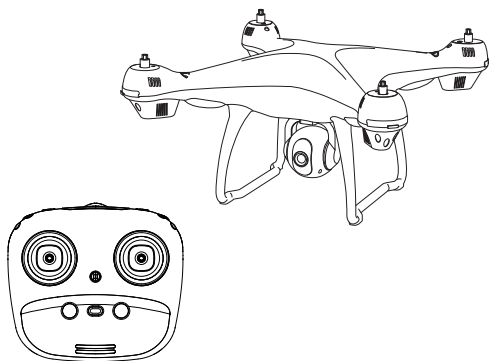

**HS100 DRONE with Camera**

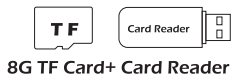

**8G TF Card+ Card Reader**

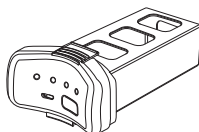

**Battery x 1**



**Propeller X 8**

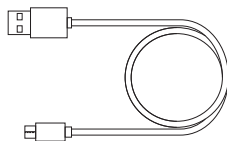

**USB Charging Cable**



**Landing Gear  
X 2**



**Screw driver X 2**

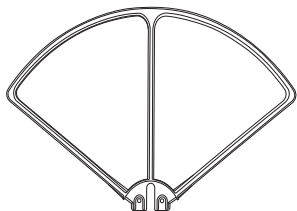

**Propeller Guard X 6**



**Screw X 20**



**Cap X 8**

# Drone

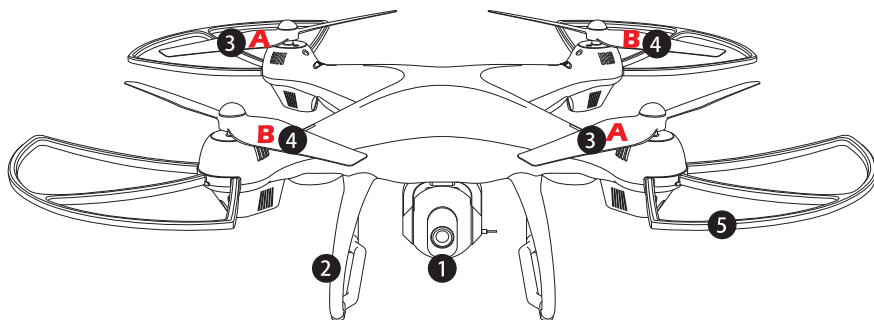

1. HD Camera  
2. Landing Gear

3. Propeller "A"  
4. Propeller "B"

5. Propeller Guard

---

## Battery of Drone

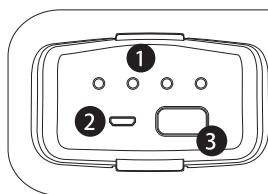
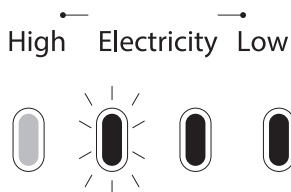
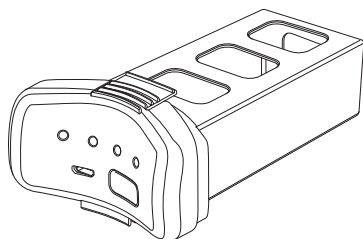

1. Battery Level Indicators  
2. Micro USB Charging Port  
3. Power Switch

Press the Power Switch shortly to turn on; hold the Power Switch for 2 seconds to turn off.

### Tip:

Once the battery is low, please fly the drone back as soon as possible. Otherwise, it may cause the drone loss.

# Parts Details

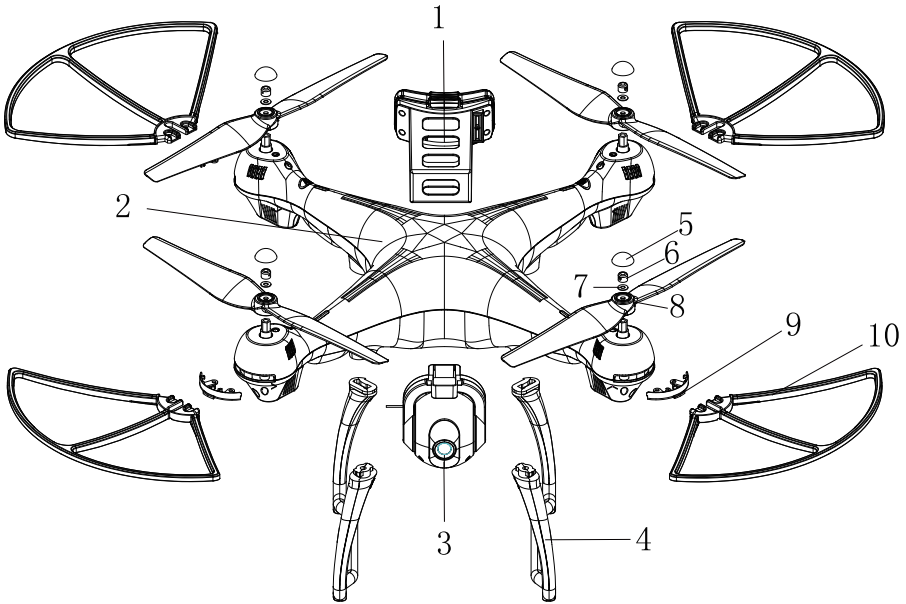

1. Battery	6. Fixed Ring
2. Body Frame	7. Spacer Ring
3. Camera	8. Propeller
4. Landing Gear	9. Dust Cover
5. Cap	10. Propeller Guard



# Assemble the Propeller

Please note that the letter “A ” or “ B ” is printed on each propeller. Make sure all the propellers are attached in the correct motor position.

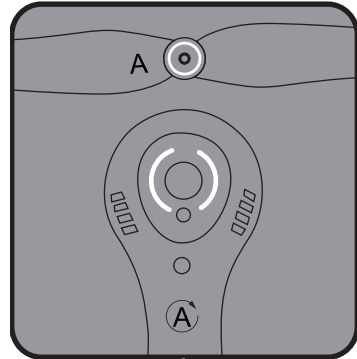
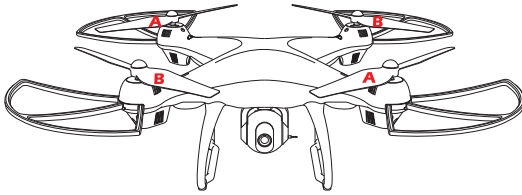

Attach the propellers with the ring mark to the motor cover with ring marks.

## Replace and Attach the Propellers

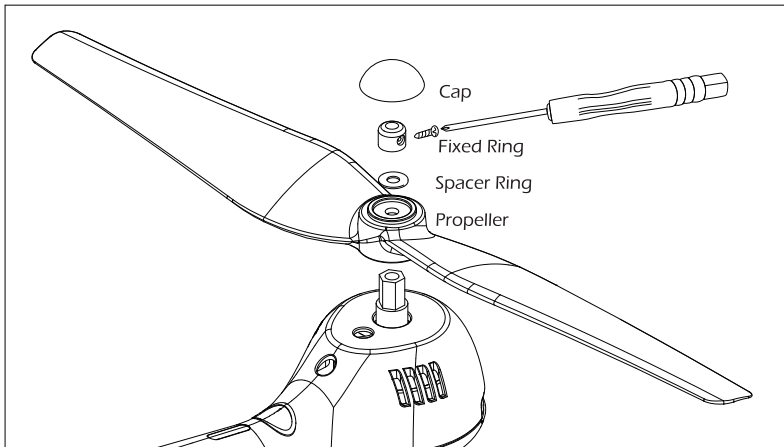

1. Remove Propeller Cap.
2. Unscrew the small screw.
3. Pull out the Fixed Ring and Spacer Ring, then pull out the propeller.
4. Attach the correct propeller.

# Assemble the Propeller Guard

To prevent accidents or injuries, we suggest the pilot to install the propeller guards.

- 1) Take out the Dust Cover from the motor cover.
- 2) Attach the Propeller Guard to the motor cover.

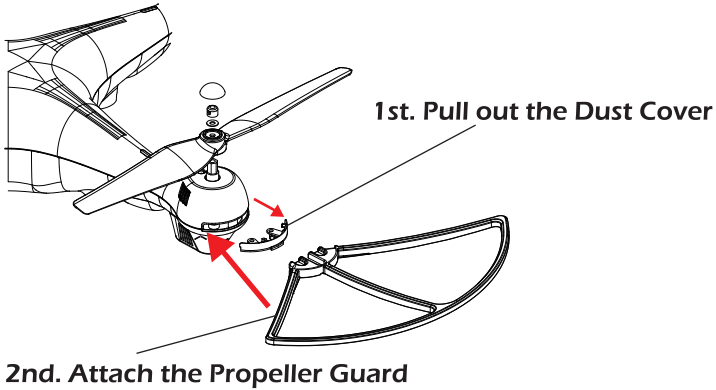

- 3) Tighten the screws under the motor cover.

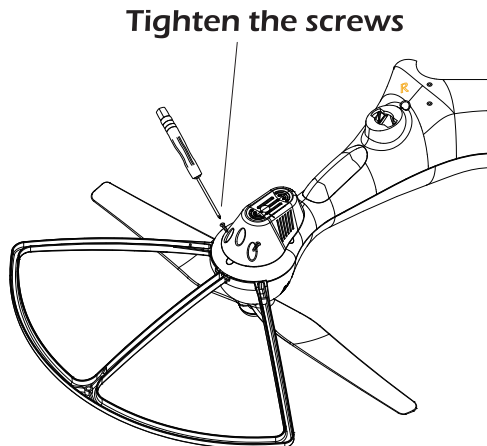

# Assemble the Camera

- 1) Plug the camera wires accordingly into the connection ports on the bottom of the drone. (Smaller wire should be connected to smaller ports while the Bigger wire connects to bigger port **Pic.1**. Wire connector has two sides A/B **Pic.2**, A side of the smaller interface faces the drone's Head and A side of Bigger interface faces the drone's Tail direction.
- 2) Push the camera into the camera installation track on the bottom of the drone.
- 3) Remove camera by pressing the camera lock **pic.3** on the bottom of the drone, and push the camera out to disconnect the camera wire from the port.

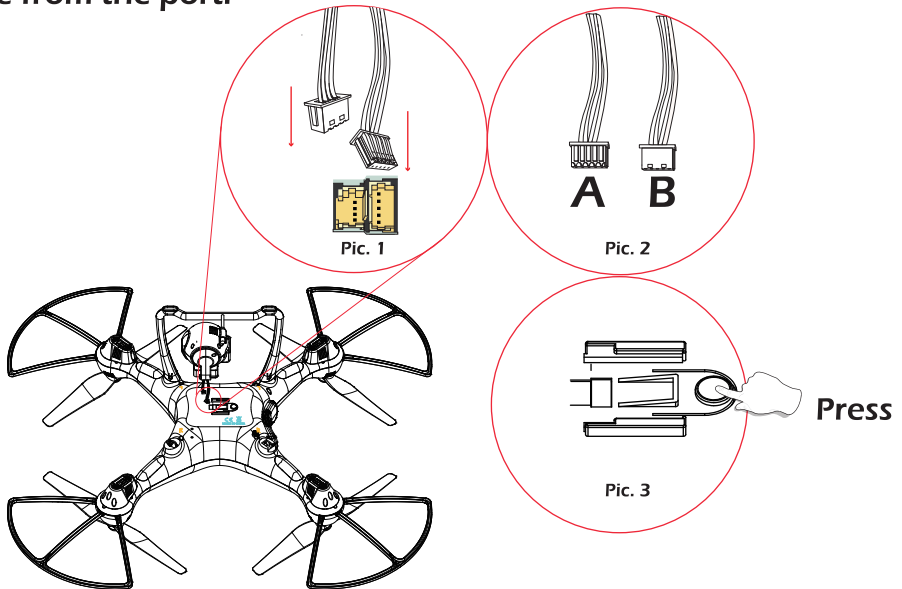

- 4) Insert the TF Card into Camera port

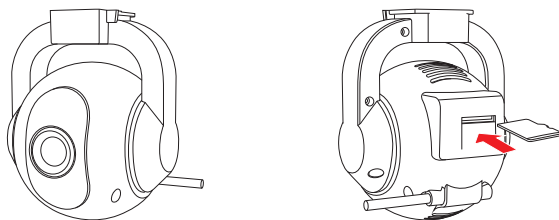

# Transmitter Functions

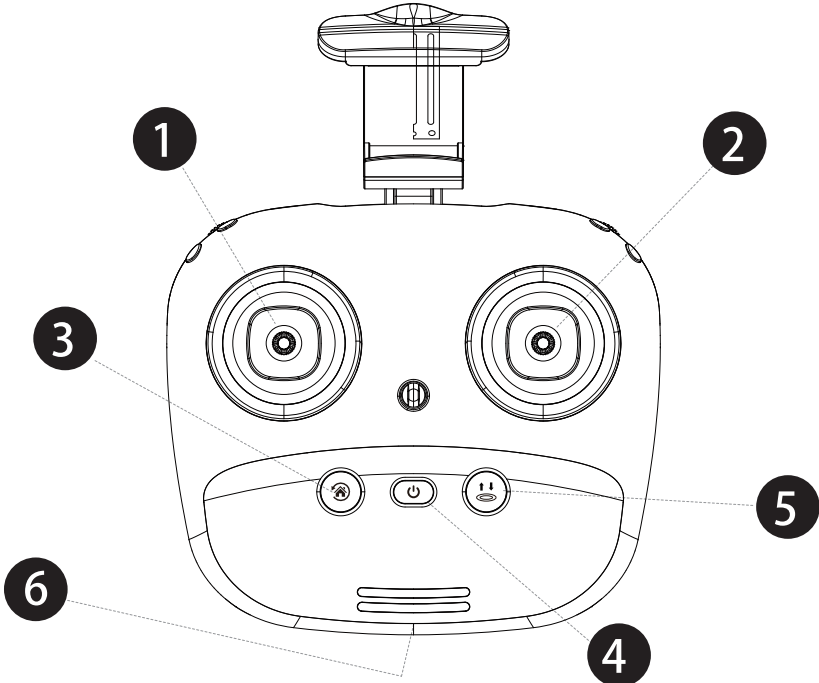

## 1 Throttle Joystick.

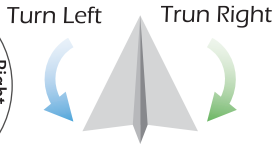
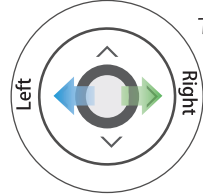
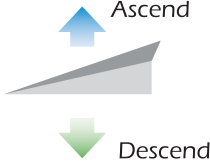
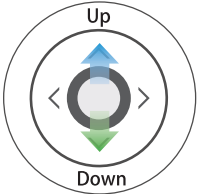

## 2 Direction Joystick.

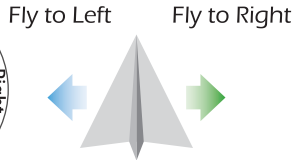
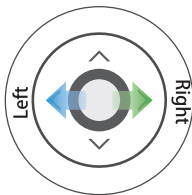
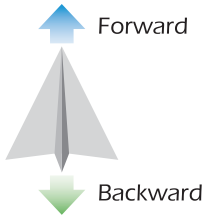
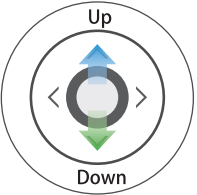

### 3 Return To Home(RTH)



Smart RTH: Press this button and the drone will return to the vertical position of the TAKE OFF point which you set, then, land by itself slowly.

**(This function can only work in GPS mode.)**

### 4 Power Button.



Press the Power Button shortly to turn on;  
Hold the Power Button for 2 seconds to turn off.

### 5 One Button Take-off, One Button Landing,

**Hold 2 secs for EMERGENCY STOP.**

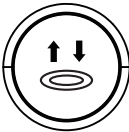

### 6 Micro USB Charging port.

Charge the Transmitter when transmitter's battery level is low.  
Connect the USB port to computer or smartphone adapter  
with OUTPUT: DC 5V  $\overline{\text{---}}$  1A

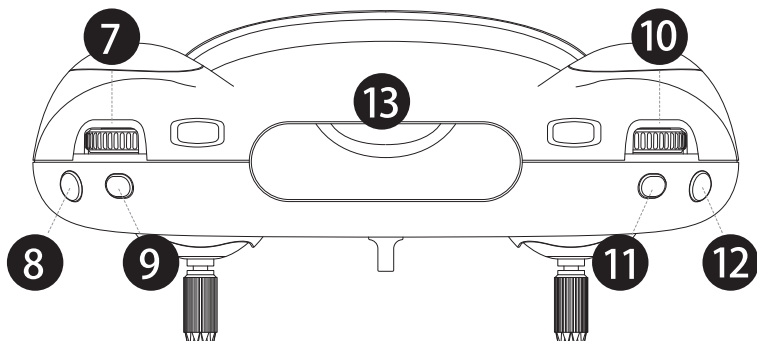

7. Dial to the right to accelerate; Dial to the left to decelerate.

8. Click  to enter Follow-me mode; Click again to cancel the follow-me mode. (For more details, please check page22#)

Hold this button for 3 secs to enter Trim mode. Click again to cancel Trim mode.

**Note: No need to trim under the GPS Mode.**

9. Click  to switch headless/normal mode.

**Hold the button for 3 seconds to exit the GPS MODE.**

(For more details, please check page24#)

10. Gimbal Dial: Dial left/right to adjust the camera tilt up/down.

11. Click  to take photo.

12. Click  to take video; Click again to save the video .

**(Don't take photo while taking video, otherwise it will disturb the Video process.)**

13. Phone Holder : Fits on all phones up to 7.5 cm wide.

14. Status LED

15. Speed

16. Photo/Video

17. RTH

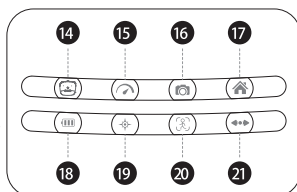

18. Charging Indicator Light

19. Headless Mode

20. Follow-me

21. Trim LED

# Fly Safety



+



+



+



Fly in Open Areas

Strong GPS Signal

Maintain Line of Sight

Fly Below 400 feet (120 m)

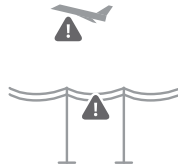

Avoid flying over or near obstacles, crowds, high voltage power lines, trees, airports, and bodies of water.

DO NOT fly near strong electromagnetic sources such as power lines and base stations as it may affect the onboard compass.



DO NOT use the drone in adverse weather conditions such as rain, snow, fog and wind speeds exceeding 10 m/s or 22 mph.

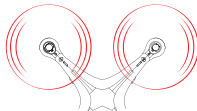

No Fly Zone

Stay away from the rotating propellers and motors.



**It's important to understand basic flight guidelines, for the safety of both you and those around you. Don't forget to read the Safety Guidelines before flight.**

# Fly Safety

- 1. Fly in Open Areas:** Always fly in locations that are clear of buildings, trees, power lines, and other obstacles. Do not fly above or near people or animals.
- 2. Maintain Control at All Times:** Even when using autopilot functions such as Auto-Takeoff, Auto-Landing, and Return to Home, always keep your hands on the Transmitter and maintain control of your drone when it is in flight.
- 3. Maintain Line of Sight:** Keep your drone in sight at all times, and avoid flying behind buildings or other obstacles that may block your view.
- 4. Monitor Your Altitude:** For the safety of full-sized drone and other air traffic, always fly at altitudes less than 400 feet (120 meters) above ground level, or in line with your local laws and regulations.

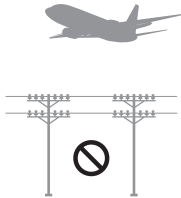



# Preparation

## 1. Download the APP



iOS



Google Play

Connect to the App Store™ or Google Play™ and download the “HS GPS PRO” application for free.

## 2. Check the Battery Level

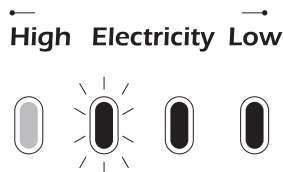
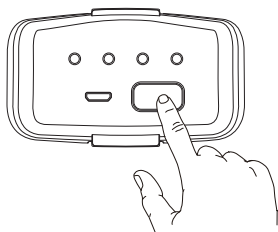

## 3. Charging the Battery and Transmitter

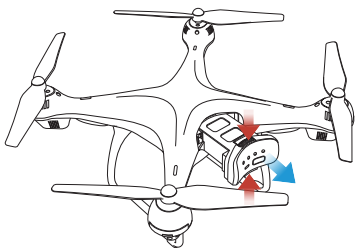

Press the buckle and Pull out the Battery from the drone.

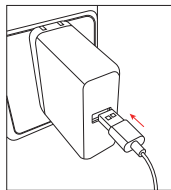

Phone adapter:  
5V  $\equiv$  1A/2A  
(Not included)

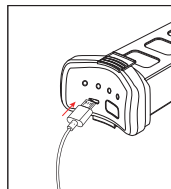

Charging time:  
3 - 6 Hours  
(Depending on  
Charging Power)

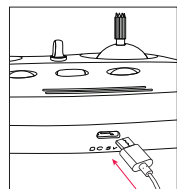

Charging time  
of the transmitter:  
about 1Hour

  $\longrightarrow$    
(Charging) (Fully Charged)

**Tip:** When the transmitter is in low power, the “Status LED” on the transmitter will keep blinking, you need to charge the transmitter this time.

# Flight

Due to the relatively large size of this drone, we only recommend that our customers fly this drone outdoors to avoid damage.

## 1. Pair the Drone

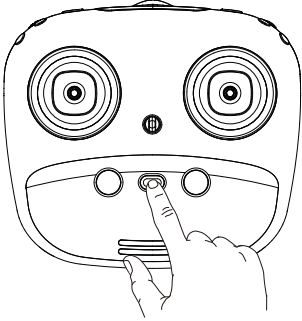

① Power on the Transmitter.

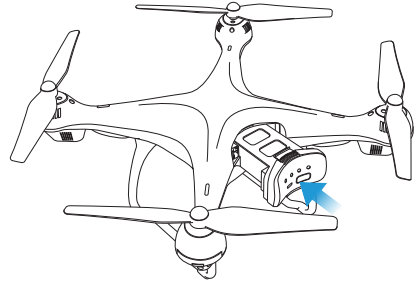

② Plug the Battery into the Drone and Power on the drone.

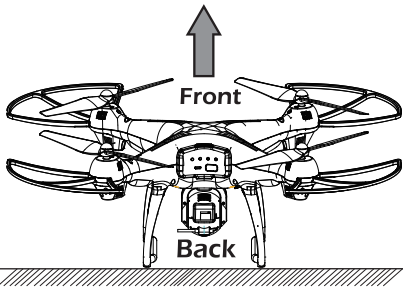

③ Place the Drone on a flat and dry surface and in an unobstructed and light area.

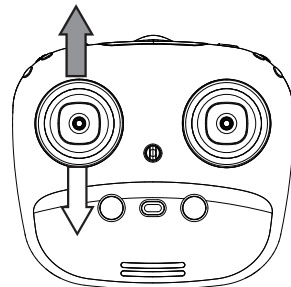

④ Push the left joystick up then down to pair with drone.

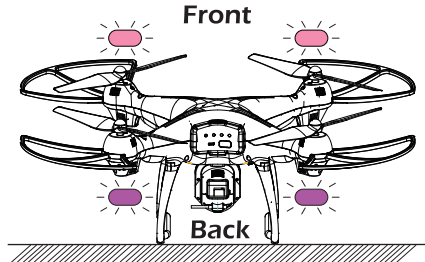

⑤ LED indicators on the drone will blink Purple (Back) and Pink (Front) when the drone is paired successfully.