

# Instruction For Use

**14+**  
age

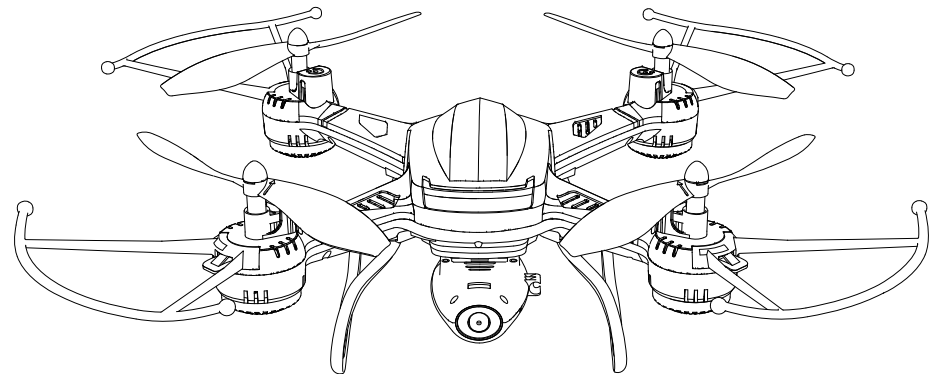

F181G



usa@holystone.com (USA)  
ca@holystone.com (CA)

eu@holystone.com (EU)  
jp@holystone.com (JP)

1(855) 888-6699

# Catalog

1. Preface
2. Warnings .
3. Maintenance
4. Package Contents
5. Drone's Details
6. Transmitter Functions
  - Mode 2
  - Mode 1
7. Installation
  - Propellers
  - Protection Guards
  - Landing Gear
  - Drone's Battery
  - Camera
  - Phone Holder and Display Screen
8. Charge the Lithium Battery
9. Flight Safety Information
10. Flight
  - Pair the Drone
  - Calibrate the Gyro
  - One Key Start/Landing
  - Flight Control
11. Speed Switch
12. Emergency Stop
13. Take Photo/ Record Video
14. Low Battery Warning
15. 360 ° Flip
16. Headless Mode
17. 5.8GHz FPV Real-Time Function
18. Specification
19. Trouble Shooting
20. Contact Us
21. General Information

## < PREFACE >

To make your experience with this drone as straightforward and convenient as possible, please read this Instructions For Use before operating and keep it for the future reference and maintenance.

### **Important Statement:**

1. This product is not a toy, but it is a high precision drone that integrates various electronic stability and control mechanisms. This drone requires careful and correct assembly and setup to ensure safe, accident-free operation. This equipment should be operated in a safe and controlled manner at all times. Incorrect or hazardous operation may cause damage to the device or property, or cause serious injury to those in the vicinity.
2. This product is suitable for experienced drone pilots over 14 years of age.
3. In case of having difficulties on any aspect of the product, operation or maintenance, please contact your local sales agent or contact customer support here at Holy Stone.

### **Safety Guidelines:**

This product is flying camera that offers easy, controllable flight when in good working order, however, there is also a significant risk to property and people if it flies irresponsibly or within confined spaces. Incorrect assembly or poor control by inexperienced pilots can result in damage to property or harm to people in an accident. Be fully aware of your surroundings when flying and always maintain complete control of the vehicle at all times.

#### **1. Keep in Distance:**

- a. Always fly in locations that are clear of any obstructions, such as buildings, poles, electrical wires, trees and so on.
- b. Never fly above or near people and spectators.

#### **2. Do not fly in adverse weather conditions:**

- a. Keep clear of moisture, fog, ice and excessive wind.
- b. Fly in good weather conditions only.

#### **3. Use and maintain the product according to the instructions for use:**

- a. Operate this device legally in accordance with instructions provided and local laws and regulations.
- b. Always use original parts manufactured by Holy Stone for maintenance and repair.

#### **4. Do not operate the device alone.**

- a. If you are a new pilot, please seek assistance from an experienced drone pilot when learning.
- b. Have others around to help you fly at all times.

#### **5. Safety First every time:**

- a. Always operate the drone within your ability as a pilot. If you are ill, disoriented, or unsure of how to effectively fly the drone, please seek help to avoid danger, damage or injury.

#### **6. Keep clear of rotation parts:**

- a. During operation the rotors revolve extremely quickly, please avoid touching the blades and ensure that foreign objects are kept clear of all moving parts.

## 7. Avoid exposure to excessive heat:

a. Due to the numerous material types used in construction, this drone is not suitable for exposure to heat. Please keep your device away from heat sources and avoid prolonged exposure to direct sunlight. High temperatures is capable of distorting the structure of drone and lead to unpredictable consequences.

### <WARNINGS>

1. The information and guidance within this package and instructions for use are important for the safe operation and maintenance of your drone. Please keep it well for future reference.
2. You accept sole responsibility for any injury, loss or damage that result from your operation of the device.
3. Always follow the instructions when assembling or operating the drone. Always keep at least 2 meters between the user or viewers and the model to avoid risk of injury. Pay attention to the device at all times while flying.
4. Neither Holy Stone nor any distributors or agents accepts any responsibility for loss, injury or damage caused by incorrect operation of the drone.
5. This drone is not suitable for children under the age of 14. Younger pilots should always operate the drone under the supervision of an adult.
6. Please ensure assembly instructions are followed correctly to ensure proper operation and performance of your drone.
7. This product contains small parts. To avoid any choking hazard, please keep this drone and all its components out of the reach of children.
8. You must not, under any circumstance, fly this drone over open water or near any public road to avoid risk of accident.
9. Keep all packaging materials away from children and dispose them in a safe manner.
10. The internals of the drone are not user serviceable, please do not attempt to disassemble this drone or replace any part of the drone, to avoid malfunctions during flight.
11. Please ensure batteries are fitted in the correct orientation as shown in these instructions.
12. You can access to the transmitter battery compartment by unscrewing the screws on the battery cover. Inserting batteries to ensure they are in the right orientation. Always put battery cover back and tighten the screw to secure before use.
13. Only use the charger provided with your drone for safety.
14. The charger is not a toy.
15. Always pay close attention to battery polarity when inserting any battery to make sure they are fitted correctly.
16. Use either rechargeable or nonrechargeable "AA" batteries in the transmitter. Do not mix battery types.
17. Use only recommended batteries in the transmitter, please remember that non-rechargeable batteries must not be charged.
18. For rechargeable batteries, always follow manual instructions for use and have adult supervision. Do not leave charging batteries unsupervised and as batteries get hot when charging, avoid any combustible material.

19. Avoid short circuits by fitting the batteries incorrectly, and do not crush or squash batteries as this carries a risk of explosion.

20. Do not mix new and old batteries as this can lead to unpredictable performance.

21. Dispose used batteries carefully, do not litter.

22. The power socket must not be removed from this drone. Do not attempt to short circuit the connection socket.

23. When disposing batteries, do not throw on fires, leave to decomposer. Keep clear of heat sources and high temperatures at all time.

24. If the device is not going to be used for an extended period, remove batteries to prevent potential damage from battery leakage.

25. Care should be taken to keep your drone away from sources of magnetic interference of other electrical equipment to prevent signal issues during operation.

26. Keep clear of rotating parts and beware of loose clothing that could become entangled in the rotors causing injury.

27. Beware of the noise volume the drone produces. Keep your distance to avoid ear damage.

28. The charger socket uses a mini USB 5V connection.

29. Always use the product in compliance with local aviation radio rules and comply with local authorities who require you to refrain from operating at any time.

### <MAINTENANCE>











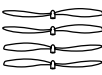

1. Clear the product after each use with a clean, soft cloth.

2. Avoid prolonged exposure to direct sunlight and avoid buildup of heat on the drone.

3. This device is not waterproof and must not be submerged in water under any circumstance. Failure to maintain the device completely dry will result in the failure of the unit.

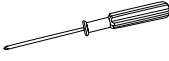
4. Check the charging plug and other accessories for signs of damage frequently. If any part of the device is damaged, refrain from flying until maintenance can be carried out.

< PACKAGE CONTENTS >

No.	Part Name	Picture	Quantity
1	Drone		1
2	Transmitter		1
3	Li-ion Battery <i>(on the fuselage!)</i>		1
4	Additional Propellers		4
5	USB Charging Cables		1
6	4GB TF Card + Card Reader <i>(on the fuselage!)</i>		1
7	Propeller Guard		2
8	Additional Screws		4
9	Camera <i>(on the fuselage!)</i>		1
10	Screwdriver		1
11	Phone Holder		1
12	Display Screen		1
13	Landing Gear		2
14	Instructions For Use		1

< DRONE'S DETAILS >

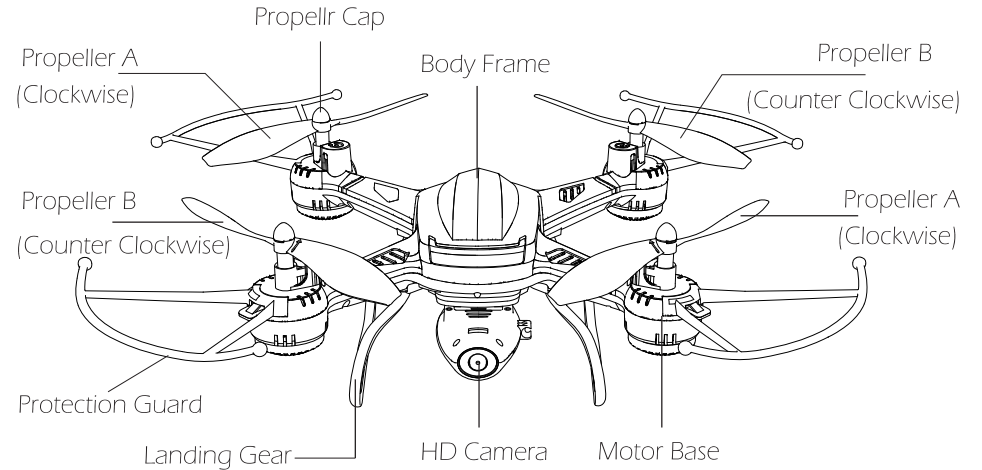

< TRANSMITTER FUNCTIONS >

The transmitter is able to reach its maximum transmission distance at about 328 feet (100 meters) when used in a wide open area with no radio or electronic interference.

Mode 2:

*Left hand throttle MODE 2 will be default setting.*

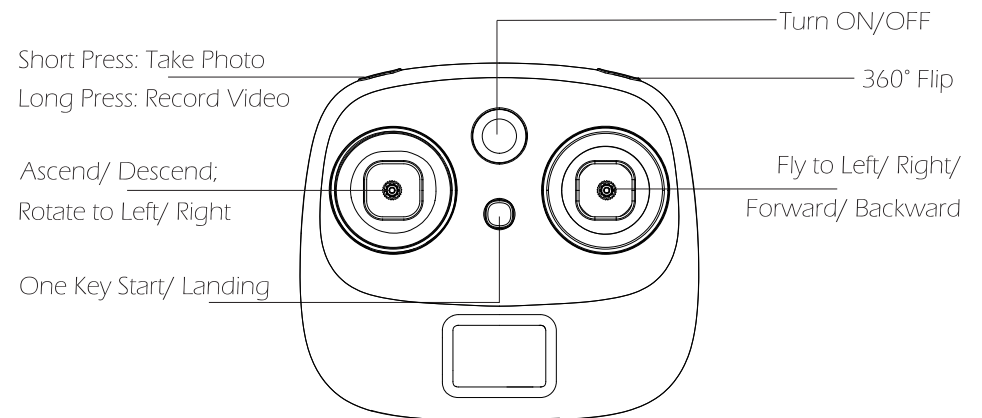

### Mode 1:

To enter MODE 1, turn on the transmitter while holding the "Take Photo" button on the transmitter.

**(Please do not release the "Take Photo" button until the transmitter is powered on.)**

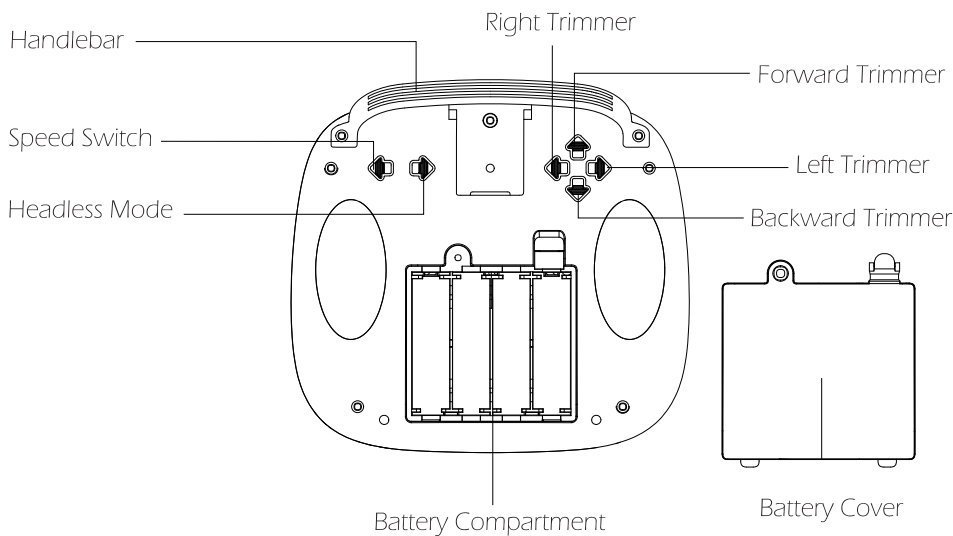
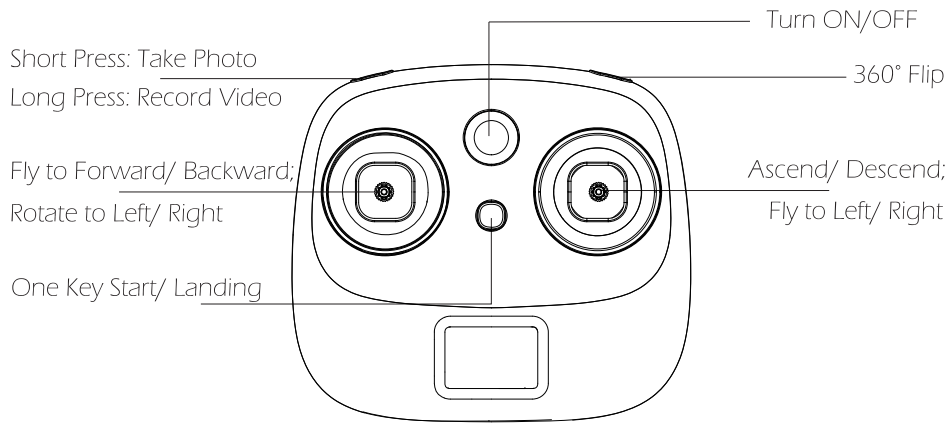

**!** Always pay attention to the battery polarity when install the batteries to make sure they are fitted correctly.

### 1. Propellers:

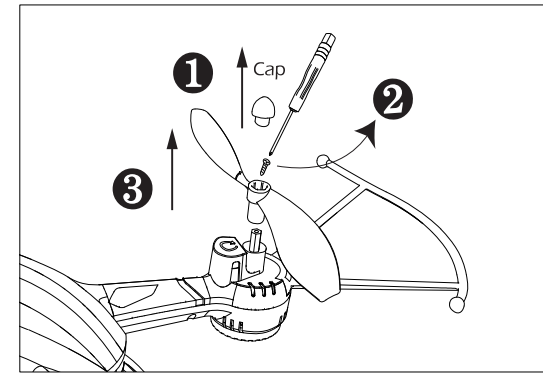

1. Take the Propeller Cap out.
2. Unscrew the small screw on the propeller.
3. Take the propeller out.
4. Attach the new propeller.

**(When installing, pay attention to the letters "A" and "B" printed on the propeller, and make sure that the direction of arrow rotation above the propeller is the same as the arrow direction of rotation on the motor base! )**

### 2. Protection Guards:

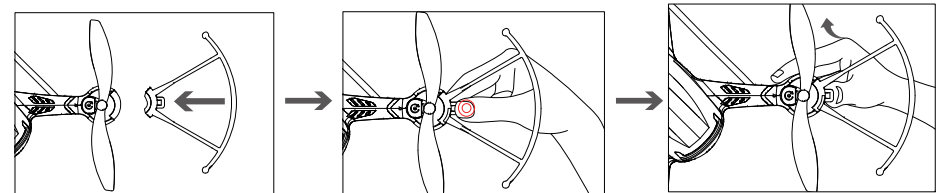

1. Push the Protection Guard onto the motor base.
2. Press the Buckle on the Protection guard down to lock it.
3. Push the Buckle up to unlock Protection Guard.

### 3. Landing Gear:

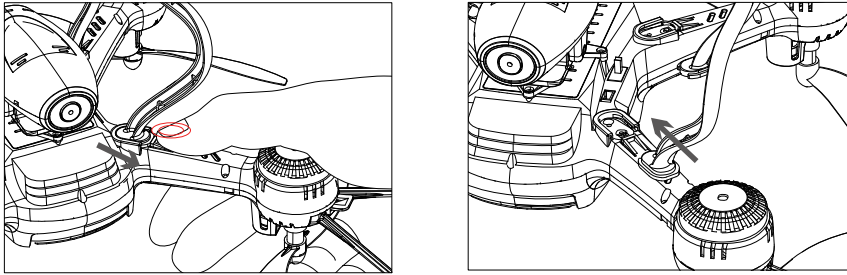

1. According to the above diagrams, press the Landing Gear Lock on the bottom of the drone's wing, and pull the landing gear out at the same time.
2. Push the Landing Gear forward to install it.

### 4. Drone's Battery:

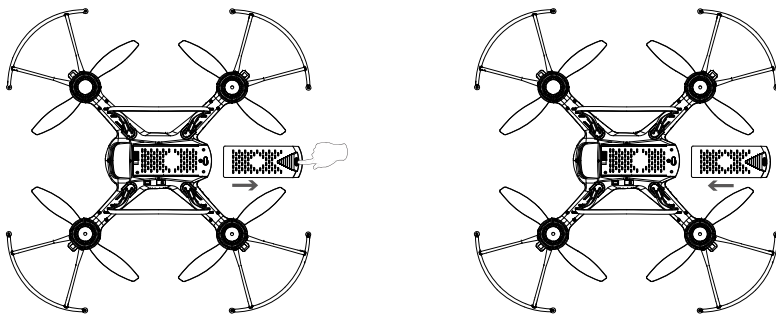

1. According to the above diagrams, press the battery lock on the battery and pull it backward at the same time to take it out.
2. Push the battery forward to the battery compartment to install it.

### 5. Camera:

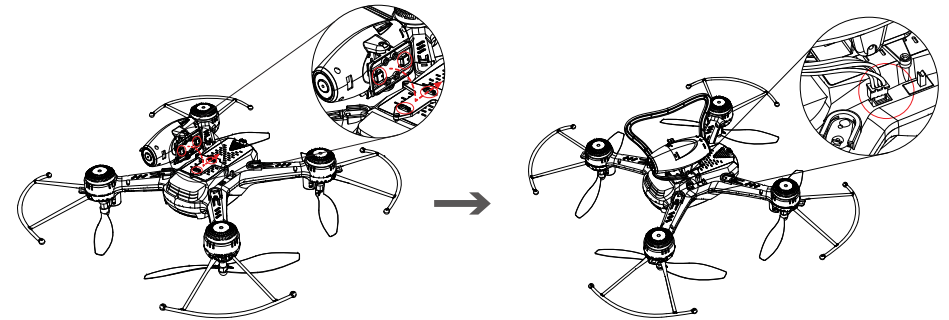

1. According to the above diagrams, install the camera to the camera buckle on the bottom of the drone.
2. Connect the camera wire to the drone.  
*(Pay attention to the connection port on the drone.)*

### 6. Phone Holder and Display Screen:

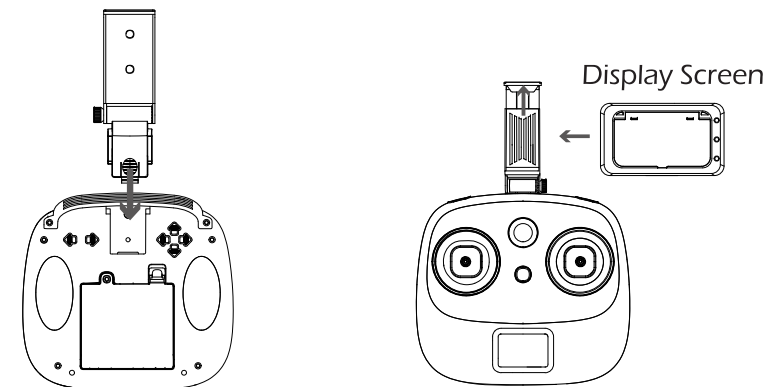

1. According to the above diagrams, install the phone holder to the transmitter.
2. Pull the phone holder up, then, install the Display Screen to the phone holder.

## < CHARGE THE LITHIUM BATTERY >

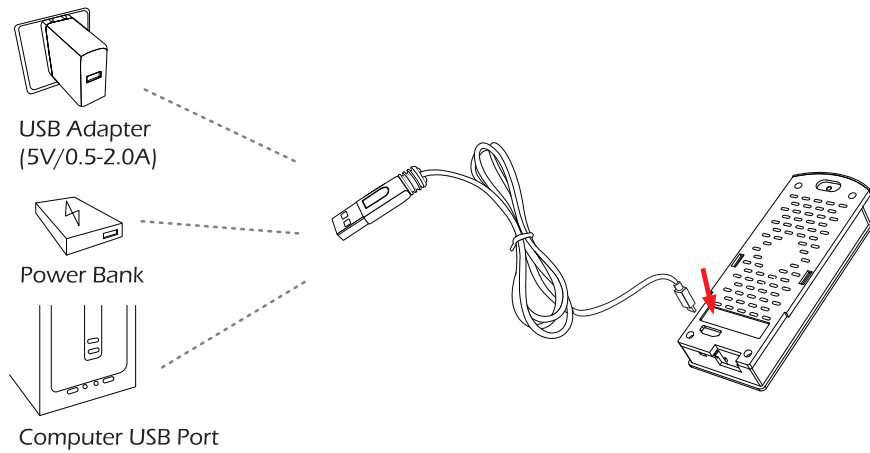

1. Connect the battery with the USB charging cable.
2. Plug the USB charging cable in to a USB charging port on the computer, power bank or USB adapter. (5V/0.5A-2.0A)
3. The red indicator light on the battery will be on when the battery is under charging; and will turn off when the battery is fully charged.
4. Charging time for drone's battery is about: 60-90 minutes.

## CAUTIONS

- 1) Don't use or charge the battery if it shows signs of swelling, punctures, or damage in any way.
- 2) Don't charge the battery directly after use; Allow it to cool down in an open and dry area to avoid overheating.
- 3) During battery is charging, please keep it away from furniture, carpet or anything flammable.
- 4) Don't charge the battery overload (below 5V/2A). Make sure to remove the battery from the charger after charging is complete, never overcharge the battery.
- 5) Be cautious while removing a battery from the charger since it is possible to strip the cords and cause fire. (and ruin the battery)

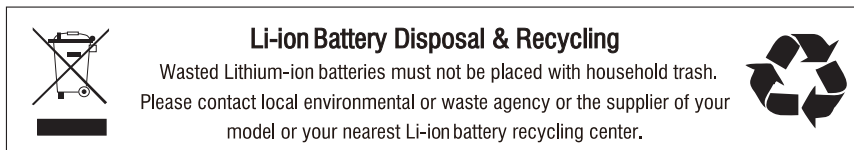

## < FLIGHT SAFETY INFORMATION >

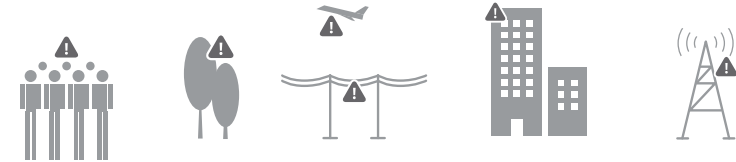

**Avoid flying over or near obstacles, crowds, high voltage power lines, trees, airport or bodies of water.**

**DO NOT fly near strong electromagnetic sources such as power lines and base stations as it may affect the onboard compass.**



**DO NOT use the drone in adverse weather conditions such as rainy, snow, fog and windy.**



**Stay away from the rotating propellers and motors.**



**No Fly Zone**



**Don't forget to read the basic flight and safety guidelines before flight, because it's important to understand the basic flight guidelines.**

- ⚠ • Rotating propellers can be dangerous. Do not start the motors when there are people nearby.
- Always keep your hands on the transmitter so long as the motor is still spinning.

All of the following operations on this manual takes mode 2 for example.

**Pair the Drone:**

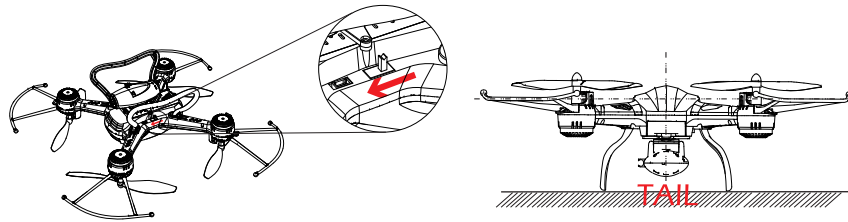

① Push the power button to “ON ” status to turn on the drone. Now the LED indicator lights on the drone will be blinking. Then, place the drone on an flat and level surface with the head faces forward and the tail towards the pilot.

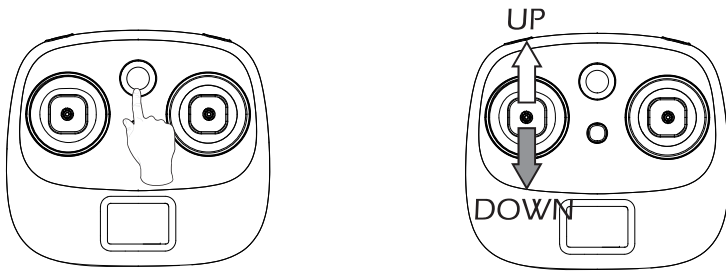

- ② Power on the transmitter. ③ Push the left joystick up then down to pair the drone with the transmitter. The LED indicator lights on the drone will be solid if the drone is paired successfully.

**Calibrate the Gyro:**

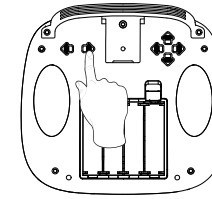

⑤ Long press the Headless Mode button on the back of drone (show as above diagram) to calibrate the gyro. The LED lights on the drone will blink quickly and turn solid. When you hear one beep from the transmitter that indicates the calibration is completed.

**Tips:** To ensure a stable flight, we suggest the pilot calibrate the gyro every time after pairing the drone and after a crash.

**One Key Start/Landing:**

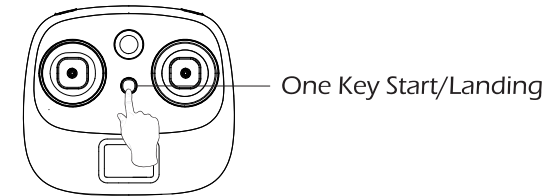

⑥ After Pairing/Calibration, press the One Key Start button, the propellers will start spinning, indicating this drone is ready to fly, and you can control this drone by using the joysticks. Press this One Key Landing button again, the drone will land by itself .

**Flight Control:**



⑦ Throttle(Left) Joystick



< FLIGHT >

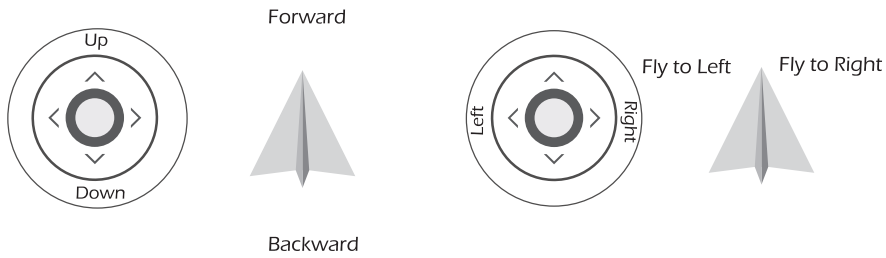

⑧ Direction(Right) Joystick

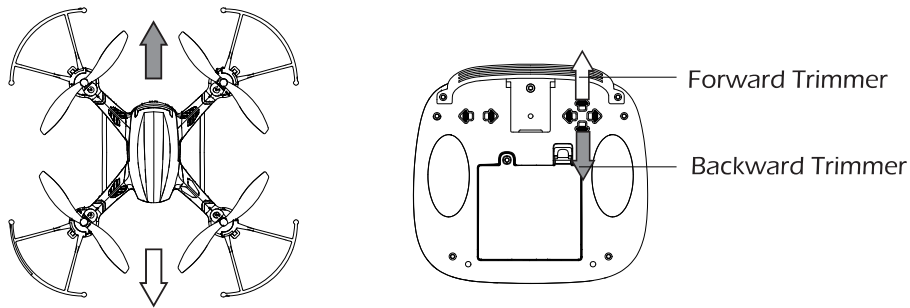

⑨ F/B Sideward Fly Trim : If the drone drifts forward, press the backward trimmer button to rebalance the drone; if the drone drifts backward, press the forward trimmer button to rebalance the drone.

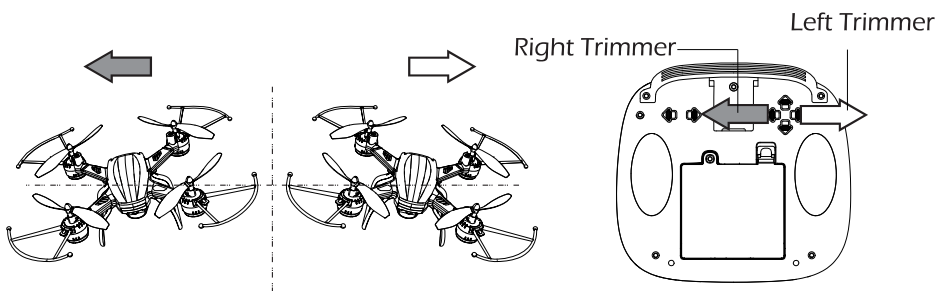

⑩ L/R Sideward Fly Trim : If the drone drifts left, press the right trimmer button to rebalance the drone; if the drone drifts to right, press the left trimmer button to rebalance the drone.

<SPEED SWITCH>

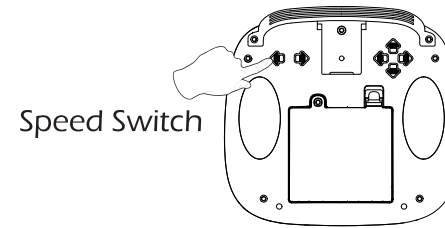

This drone comes with 4 speed levels (Low/Medium/High/Expert). Press the Speed Switch button on the back of transmitter to switch the speed. One beep from the transmitter indicates Low speed, two beeps indicate Medium speed; three beeps indicate High speed; and four beeps indicate Expert speed.

*(The Low Speed is default speed mode.)*

< EMERGENCY STOP >

⚠ Only stop motors mid-flight in emergency situations when doing so can reduce the risk of damage or injury.

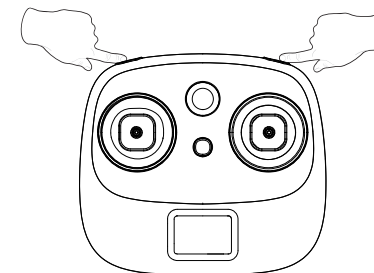

Press the upper left and upper right button of the transmitter at the same time, the motors will stop immediately.

<TAKE PHOTO/ RECORD VIDEO>

Short Press: Take Photo  
Long Press: Record Video

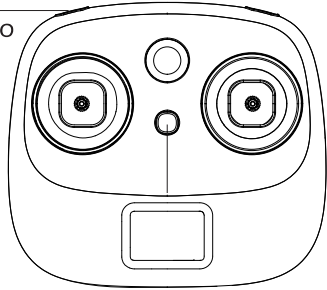

**Take photo:** Press the Upper Left button of the transmitter, one beep from the transmitter will be heard, indicating take a picture.

**Record Video:** Long press the Upper Left button of the transmitter, two beeps from the transmitter will be heard, meaning that the camera starts recording, and press this button again to stop and save video.

**(Please do not take pictures during recording!)**

< LOW BATTERY WARNING >

① When the drone battery runs low, the indicator lights on the drone will start blinking, and the transmitter will constantly beep. When this happens, the pilot should land the drone safely and charge the battery.

② When the transmitter battery runs low, the indicator lights on the transmitter will start blinking and the transmitter will keep beeping. When this happens, the pilot should change the new battery for the transmitter.

< 360° FLIP >

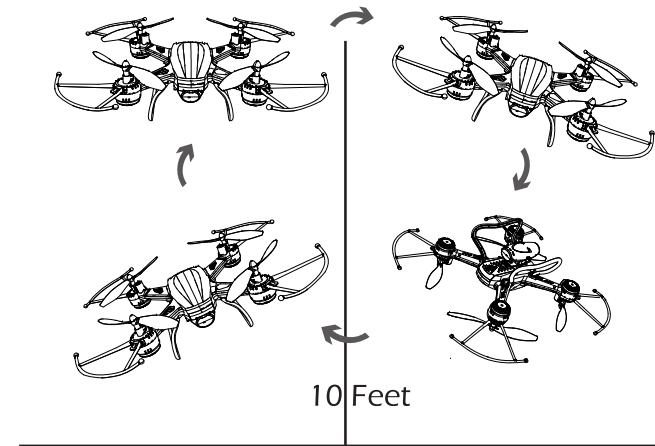
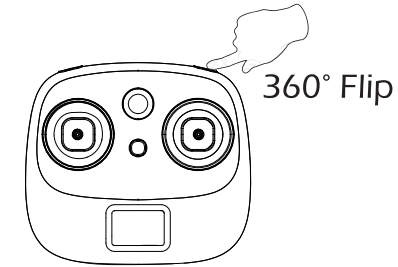

When you get familiar with all the functions of the drone, you can try this amazing flip mode. When you fly the drone at least 10 feet, press the "360° Flip" button on the upper right of the transmitter, then push the Right stick Forward/Backward or Left/Right, and the drone will do a flip towards the corresponding direction.

**Tips:**

This function can perform better when the battery is fully charged.

## < HEADLESS MODE >

1. After Pairing/Calibration, press the Headless Mode button on the bottom of the transmitter. A beep will be heard from the transmitter, and the lights on the drone will keep blinking. It means the drone is in Headless Mode.

2. Press the Headless Mode button again, and you will hear 2 beeps, which indicates the drone exits the Headless Mode.

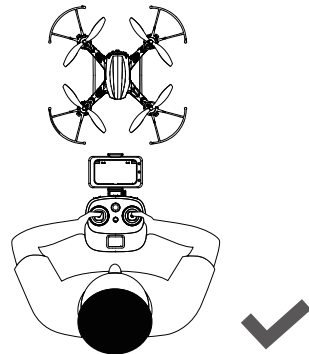

The direction of transmitter when the drone is paired.

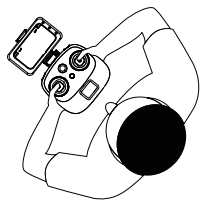

Don't turn your direction

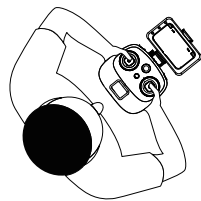

Don't turn your direction

Under Headless Mode, the forward direction is the direction the pilot faces to when the pilot pairs the drone with the transmitter. If the pilot pushes the right joystick forward or backward, the drone will fly forward or backward; If the pilot moves the right joystick left or right, then the drone will also move left or right relative to the pilot.

It is very important that the pilot does not change positions and directions he or she is facing, otherwise, this will cause confusion on the drone.

## < 5.8GHz FPV REAL-TIME FUNCTIONS >

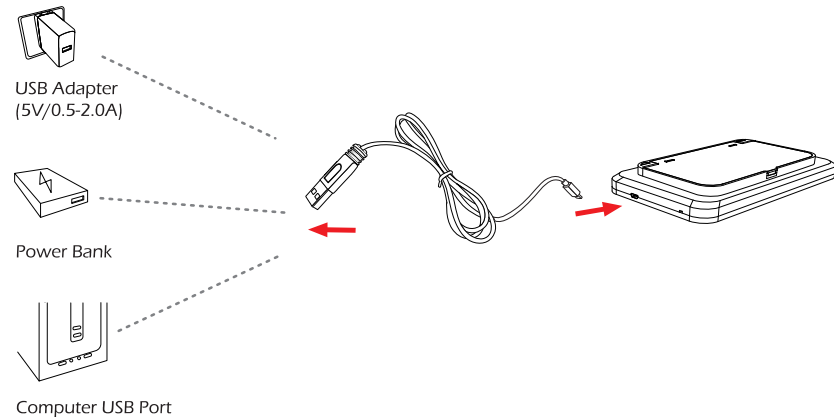

1. Charge the display screen as shown by the diagram above:

- The red indicator light on the display screen will be on when the display screen is under charging; and will turn off when it is fully charged.
- Charging time for display is about: 40 minutes.

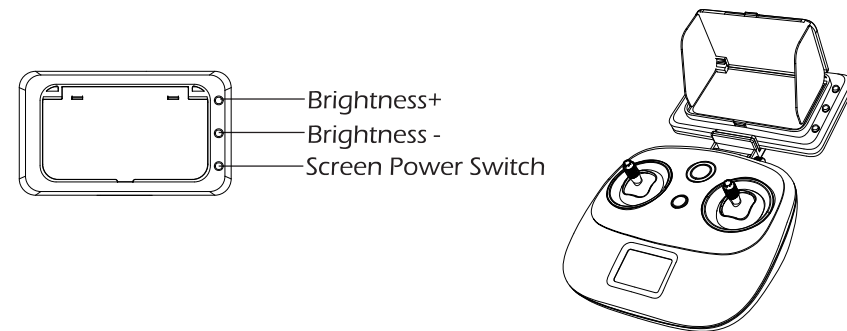

2. This drone comes with 5.8GHz FPV real-time video and image Display Screen. Press the "Screen Power Switch" button to turn on the display screen, the image will be transmitted and displayed on the screen.

3. Press the "Brightness +" or "Brightness -" button on the Display Screen to adjust the brightness of the display.



**Please fly this drone in an open area, and DO NOT fly near strong electromagnetic sources such as power lines and base stations as it may affect the image transmission and quality.**

< SPECIFICATION >

**DRONE**

Model: F181G

Weight: 157.6g

Flight Time: 8~10 minutes

FPV Distance: 328 feet (Outdoor And Unobstructed)

Motor Model: 8620

Operating Temperature Range: 32° to 104°F (0° to 40°C)

Dimensions: 300 x 300 x 105mm

**CAMERA**

Lens: FOV 120° f/2.0

Still Photography Modes : Single Shot

Video Recording Modes: HD1280x720p

Max Video Bitrate: 25 Mbps

Supported File Systems: FAT32

Photo: JPEG

Video: AVI

Supported TF Cards: TF Card 4 GB included

Operating Temperature Range: 32° to 104°F (0° to 40°C)

**TRANSMITTER**

Operating Frequency: 2.4GHz

Transmission Distance: 328 feet (outdoors and unobstructed)

Operating Temperature Range: 32° to 104°F (0° to 40°C)

Battery: 4 x 1.5V AA batteries

< SPECIFICATION >

**FLIGHT BATTERY**

Capacity: 750 mAh

Voltage: 3.7 V

Battery Type: Li-ion

Energy: 2.775 Wh

Net Weight: 29.6g

Charging Temperature Range: 41° to 104°F (5° to 40°C)

Charging Time: 60~90 mins

**USB CHARGING CABLE**

Voltage: 5 V

Rated Power: ≤10 W

< TROUBLE SHOOTING >

THE PROBLEM	REASON	SOLUTION
The indicator lights on the drone are blinking and the drone does not respond to the transmitter.	1. Communication between the drone and transmitter is bad. 2. Battery power is low.	1. Refer to the preparation for flight and pairing again. 2. Charge the battery.
The propellers spin but the drone is unable to take off.	1. The propellers are assembled in wrong orientation. 2. The propellers are distorted.	1. Replace the propellers according to the instruction on page 7. 2. Replace the propellers
The drone shakes hardly.	The propellers are distorted.	Replace the propellers.
The trim buttons fail to keep the drone balanced.	1. The propellers are distorted. 2. Motors doesn't work properly.	1. Replace the propellers. 2. Replace the motor.
The drone becomes out of control after crashes.	Gyro sensor loses its balance after crashing.	Recalibrate the gyro.

Please do not hesitate to contact us if you need further support.



usa@holystone.com (USA) eu@holystone.com (EU)  
ca@holystone.com (CA) jp@holystone.com (JP)

1(855) 888-6699

FCC Notice:

This device complies with Part 15 of the FCC Rules.

Operation is subject to the following two conditions:

- (1) This device may not cause harmful interference.
- (2) This device must accept any interference received, including interference that may cause undesired operation.

NOTE: This equipment has been tested and found to comply with the limits for a Class B digital device, pursuant to Part 15 of the FCC Rules. These limits are designed to provide reasonable protection against harmful interference in a residential installation. This equipment generates uses and can radiate radio frequency energy and, if not installed and used in accordance with the instructions, may cause harmful interference to radio communications. However, there is no guarantee that interference will not occur in a particular installation. If this equipment does cause harmful interference to radio or television reception, which can be determined by turning the equipment off and on, the user is encouraged to try to correct the interference by one or more of the following measures:

- Reorient or relocate the receiving antenna.
- Increase the separation between the equipment and receiver.
- Connect the equipment into an outlet on a circuit different from that to which the receiver is connected.
- Consult the dealer or an experienced radio/TV technician for help.

WARNING: Changes or modifications not expressly approved by the party responsible for compliance could void the user's authority to operate the equipment.

FCC Radiation Exposure Statement:

This equipment complies with FCC radiation exposure limits set forth for an uncontrolled environment .

This transmitter must not be co - located or operating in conjunction with any other antenna or transmitter.

HOW TO RECYCLE THIS PRODUCT

This symbol on the product or its documentation indicates that it must not be disposed of with household waste.

Uncontrolled waste disposal may harm the environment or human health.

Please separate your device from other types of waste to recycle it responsibly.

This will help to foster the sustainable re-use of material resources.

We invite you to contact your retailer or inquire at your local town hall to find out where and how the drone can be recycled.



#### BATTERY WARNING:

1. Failure to follow all the instructions may result in serious injury, irreparable damage to the battery and may cause a fire, smoke or explosion.
2. Always check the battery's condition before charging or using it.
3. Replace the battery if it has been dropped, or in case of odour, overheating, discolouration, deformation or leakage.
4. Never use anything other than the approval LiPo charger the battery. Always use a balancing charger for LiPo cells or a LiPo cell balancer. It is recommended that you do not to use any other charger than the one provided with the product.
5. The battery temperature must never exceed 60°C (140°F) otherwise the battery could be damaged or ignite.
6. Never charger on a flammable surface, near flammable products or inside a vehicle (preferably place the battery in a non-flammable and nonconductive container).
7. Never leave the battery unattended during the charging process. Never disassemble or modify the housing's wiring, or puncture the cells. Always ensure that the charger output voltage corresponds to the voltage of the battery. Do not short circuit the batteries.
8. Never expose the LiPo battery to moisture or direct sunlight, or store it in a place where temperatures could exceed 60°C (car in the sun, for example).
9. Always keep it out of reach of children.
10. Improper battery use may result in a fire, explosion or other hazard.
11. Non-rechargeable batteries are not to be recharged. Rechargeable batteries are only to be charged under adult supervision.
12. Different types of batteries or new and used batteries are not to be mixed.
13. Batteries are to be inserted with the correct polarity.
14. The supply terminals are not to be short-circuited. Regular examination of transformer or battery charger for any damage to their cord, plug, enclosure and other parts and they must not be used until the damage has been repaired.
15. The packaging has to be kept since it contains important information.
16. The toy is only to be connected to Class II equipment bearing the symbol.



#### Caution

1. The max operating of the EUT is 45°C. and shouldn't be lower than -10°C.
2. The device complies with RF specifications when the device used at 0mm from your body.
3. Declaration of Conformity.

We, Xiamen Huoshiquan Import & Export CO., LTD hereby, declare that the essential requirements compliance with the Directive 2014/53/EU, the RoHS Directive 2011/65/EU and Safety Directive 2009/48/EC have been fully fulfilled on our product with indication below.

Product Name: **RC Quadcopter**

Model/Mark : F181G

The Statement of compliance is available at the following address:

<http://www.holystone.com/docs/F181GEUDOC.pdf>

This product can be used across EU member states

#### MANUFACTURER INFORMATION

Manufactured by

Xiamen Huoshiquan Import & Export CO., LTD

Room 703, No. 813-2 Xiahe Road, Siming District, XIAMEN, China

+1 (855) 888-6699



**Made in China**