

Holyton

14+
age

Instructions For Use

V1.0

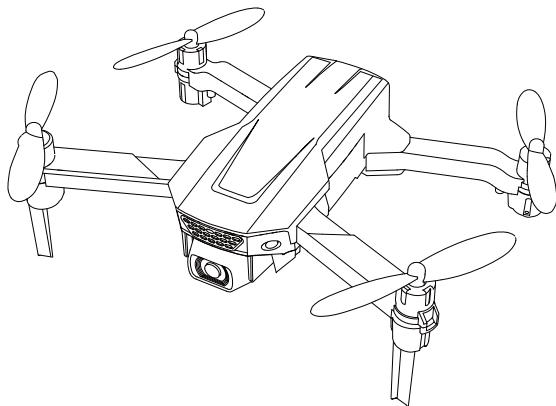

HT25



holyton@foxmail.com (USA)
holyton_ca@foxmail.com (CA)

holyton_jp@foxmail.com (JP)
holyton_eu@foxmail.com (EU)

English

01-31



Contents

1.0 Disclaimer&Warning	01
2.0 Safety Guidelines	01
3.0 Maintenance	05
4.0 Package Contents	06
5.0 Drone Details	07
6.0 Transmitter Details	08
7.0 Joystick Mode	09
8.0 Installation	
Propellers	10
Propeller Guard.....	11
Drone Battery	11
Phone Holder.....	12
9.0 Charging	13
10.0 Operation Guide	
Download APP	14
Connect to Wi-Fi.....	14
Pairing	15
Calibrating the Gyro	16
Unlocking/Locking the Motors	16
Auto Takeoff	17
One Key Landing	18
11.0 Functions Details	
Speed Switch	18
Emergency Stop.....	19
Take Photo/Record Video	19
Trimmer	20
360° Flip	21
Altitude-Hold Function	21
Headless Mode	22
12.0 Specifications	24
13.0 Contact Us	25
14.0 General Information	26

1.0 DISCLAIMER & WARNING

1. Please read this Disclaimer & Warning and Safety Guidelines carefully before using our product. This product is not recommended for people under the age of 14. By using this product, you hereby agree to this disclaimer and signify that you have read it fully. You agree that you are responsible for your own conduct and any damages caused while using this product, and its consequences. You agree to only use this product for its designed purposes and in accordance with local laws, regulations and all applicable policies and guidelines that Holyton may provide.

2. When using this product, please be sure to strictly abide by the specification requirements and safety guidelines stated in this document. Any personal injury, property damage, legal disputes and all other adverse events caused by the violation of any of the safety instructions or due to any other factor, WILL NOT be Holyton's responsibility.

2.0 SAFETY GUIDELINES

2.1 Check Before Use:

- ① This product is a high precision drone that integrates various electronic stability and control mechanisms. Please be sure to configure this drone carefully and correctly to ensure safe, accident-free operation.
- ② Ensure that the batteries of the drone and transmitter are clean, undamaged and fully charged before every use.
- ③ Ensure that all the propellers are undamaged and are installed in the correct orientation.

④ Ensure to do a thorough check of the product before each use. Inspect the integrity of the parts, any signs of cracks and wear of the propeller, battery power and effectiveness of the indicator, etc. If after doing a complete check of the drone any problems are found, please refrain from using it until the problem has been resolved.

2.2 Flight Environment:



+



+



Fly in Open Areas

Maintain Line of Sight

Fly Below
98 feet (30 m)



Avoid flying over or near obstacles, crowds, high voltage power lines, trees, airports or bodies of water.

DO NOT fly near strong electromagnetic sources such as power lines and base stations as it may affect the onboard compass.



DO NOT use this drone in adverse weather conditions such as rain, snow, fog, and wind.

2.3 Operation Requirements

- ① DO NOT use this product to follow any moving vehicles.
- ② During the flight, turn off the motors only in case of an emergency.
- ③ Fly the drone back to you as soon as you are notified that the battery is running low.
- ④ This product should not be used while drinking alcohol or consuming drugs, if you are feeling fatigued, taking medicine, or feeling any physical discomfort.
- ⑤ Be aware of the volume of noise that the drone produces. Please ensure to keep your distance to avoid ear damage.



- ⑥ Stay away from the rotating propellers and motors.

- ⑦ DO NOT fly in any spaces where drones are prohibited. Please respect people's right to privacy by not flying your drone close to others.

2.4 Use of Battery:

- ① Please ensure batteries are fitted in the correct orientation as shown in the instruction manual.
- ② Avoid short circuits by fitting the batteries correctly, and do not crush or squeeze the batteries as this could cause the risk of a fire or explosion.
- ③ DO NOT mix new and old batteries as this can lead to a poor performance of the product.
- ④ Please dispose of used batteries carefully, do not litter and recycle where ever possible.
- ⑤ DO NOT expose dead batteries to heat or fire or they may explode.
- ⑥ If the device is not going to be used for an extended period of time, please remove batteries to prevent potential damage from to the







- ⑦ Only use the USB charging cable that comes with the drone to charge the battery.
- ⑧ DO NOT connect the battery directly to wall outlets or car cigarette -lighter sockets as this will damage your battery as they are a different voltage.
- ⑨ DO NOT attempt to disassemble or modify the battery in any way
- ⑩ DO NOT use the battery if it gives off an odor, generates heat, becomes discolored, deformed or appears abnormal in any way. If any of these situations occur while the battery is in use or being charged, remove it from the device or charger immediately and discontinue use.
- ⑪ DO NOT pierce the battery casing with a nail or any other sharp object, break it open with a hammer, or step on it! Dispose or recycle this battery as it may cause personal injury or damage to your drone.
- ⑫ Always charge the batteries on a fireproof surface and away from combustible materials. DO NOT charge on surfaces that can catch fire. This includes: wood, cloth, carpet, or on the application's device.
- ⑬ DO NOT immerse the battery in water or get it wet.
- ⑭ DO NOT solder battery terminal in any way.
- ⑮ Keep batteries out of reach of children or pets.
- ⑯ DO NOT short-circuit the battery by connecting wires or any other metal object to the positive(+) and negative(-) terminals.

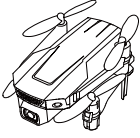

3.0 MAINTENANCE

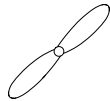
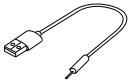
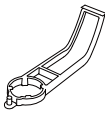
- ① Clean the product after each use with a clean, soft cloth.
- ② Avoid prolonged exposure to direct sunlight and avoid buildup of heat on the drone or batteries.
- ③ This device is not waterproof and must not be submerged or subjected in water under any circumstance. Failure to keep the device completely dry will result in the failure and permanent damage to the unit. Be aware that although it might be dry where you are, droplets of rain or mist from a river or waterfall could be damaging your drone where it is flying.
- ④ Frequently check the charging plug and other accessories for signs of damage. If any part of the device or cables are damaged, avoid use or charging until the device can be serviced.

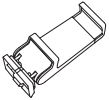
4.0 PACKAGE CONTENTS

 x1	 x1	 x2
Drone	Transmitter	Drone Battery
 x4	 x2	 x4
Spare Propeller	USB Charging Cable	Propeller Guard
 x1	 x1	 x1
Propeller Spanner	Phone Holder	Instructions For Use

5.0 DRONE DETAILS

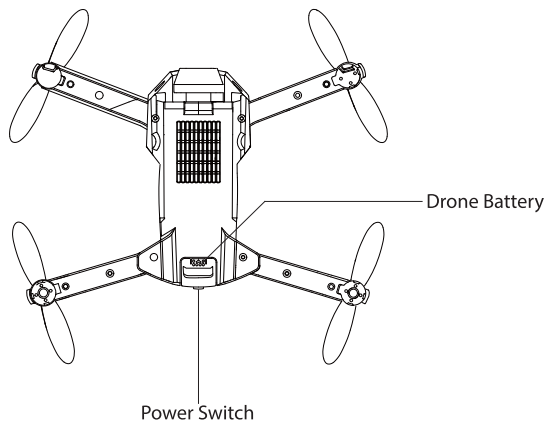
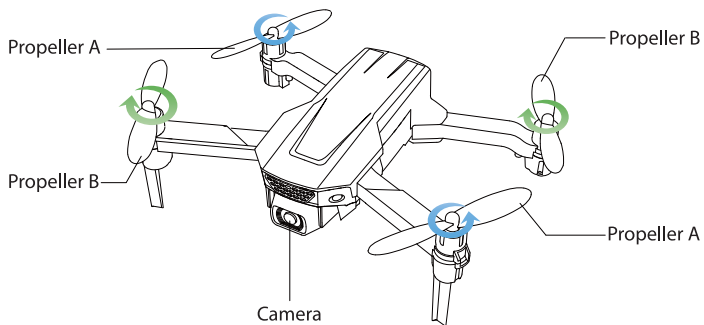

6.0 TRANSMITTER DETAILS

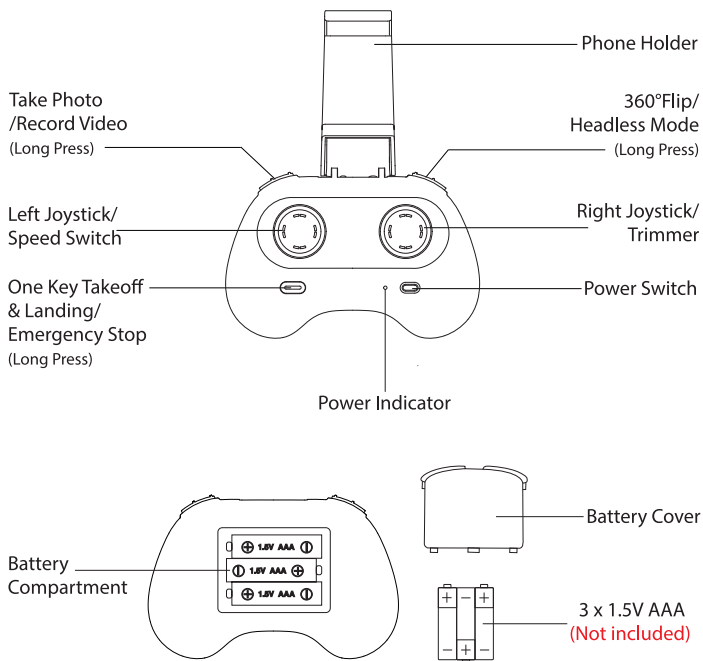

Open the battery cover on the back of the transmitter, insert the three AAA batteries (Not included) into the battery compartment, and close the battery cover to complete the installation.

⚠ When installing the batteries, please pay attention to the positive and negative polarity of the battery to ensure the correct installation of the batteries.

7.0 JOYSTICK MODE

7.1 MODE 2 (Default Setting)

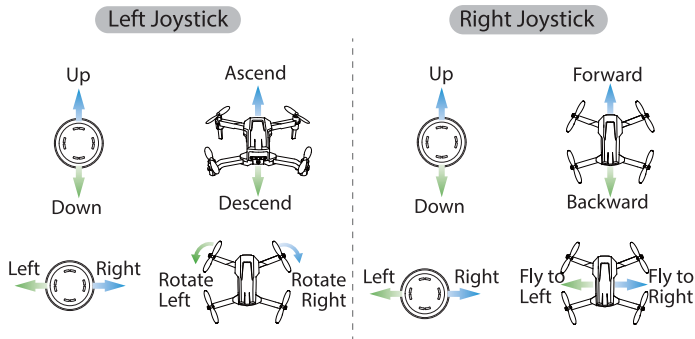

7.2 MODE 1

To enter MODE 1, turn on the transmitter while holding the “Take Photo/Record Video” button. **(Please do not release the “Take Photo/Record Video” button until the transmitter is powered on.)**

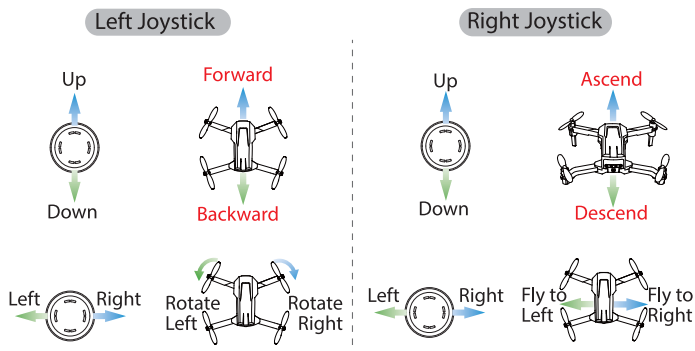

8.0 INSTALLATION

8.1 Propellers

Installation:

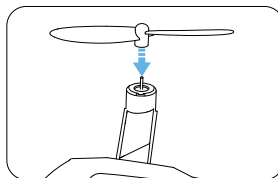
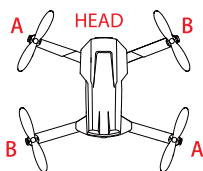

As shown above, install the propeller on the motor shaft according to the “A/B” corresponding position and manually tighten the propeller.

⚠️ The drone will not fly unless the correct propeller is installed on the correct motor shaft.

Be sure to press the propeller manually to ensure that the propeller is installed tightly, otherwise a safety hazard may occur!

Removal:

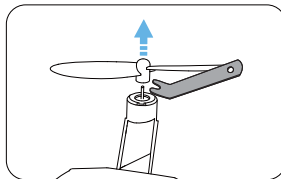

Insert the propeller spanner to the bottom of the propeller, be sure to hold the motor while detaching the propeller.

⚠️ Always detach the propellers using the propellers spanner. Do not remove the propellers by hand as doing so may damage the motors and you may get seriously hurt.

8.2 Propeller Guard

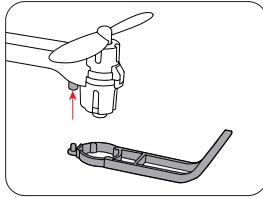

As shown in the picture above, install the propeller guards to the motor base. Make sure that the propeller guards are clamped to the motor base to avoid the unnecessary loss and damage during flight.

8.3 Drone Battery

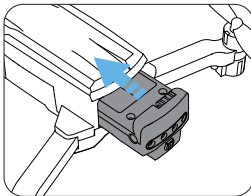

Pic 1

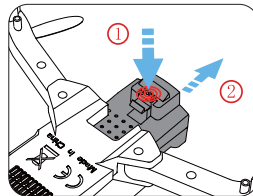

Pic 2

Installation: As shown in Pic 1, push the battery correctly into the drone battery compartment. Make sure the battery is in place to ensure that the battery is jammed in the battery compartment.

Removal: As shown in Pic 2, press the lock on the top of the battery and then pull it back to remove the battery from the fuselage.

8.4 Phone Holder

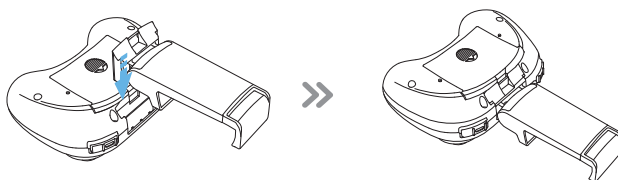

- ① Push the phone holder into the notch on the top of the transmitter.

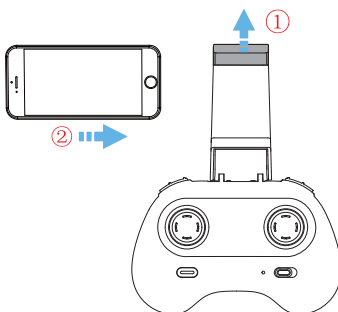

- ② Adjust the phone holder upward or downward according to the size of your mobile phone.

9.0 CHARGING

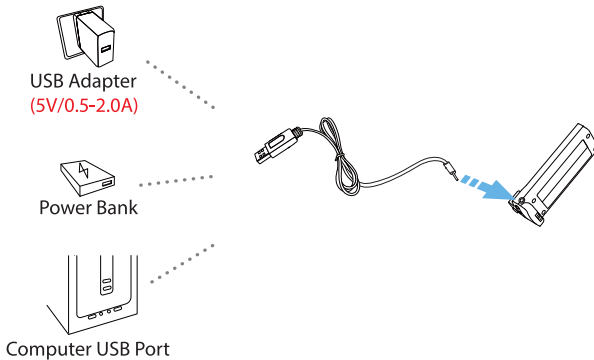

- 1) When the drone battery runs low, the indicator lights on the drone will blink continuously. After about 30 seconds, the drone will land automatically.
- 2) Remove the battery and connect the USB charging cable to the battery charging port.
- 3) Plug the USB charging cable into a USB charging port on the computer, power bank or USB adapter (5V/0.5 to 2.0A).
- 4) The red indicator light on the USB charging cable will turn on when the battery is charging, and will turn off when the battery is fully charged.
- 5) Approximate charging time is about 90~100 minutes.

⚠ Before charging, please read the instruction of the “Use of Battery” section of the “Safety Guidelines” carefully!

10.0 OPERATION GUIDE

10.1 Download APP



iOS



Android APP on Google play

Scan the QR code, corresponding to either App Store™ or Google Play™ Store and download the Drone Planet app for free.

10.2 Connect to Wi-Fi

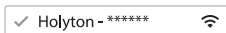

Turn on the drone, and then connect your smart phone to the Wi-Fi network created by the drone. Check the drone's status in the Drone Planet app.

- ① Your smartphone will launch a search of the available Wi-Fi networks:
- ② Select the Wi-Fi network: **Holyton - *******.
- ③ Wait for several seconds until your smartphone connects to the Wi-Fi network of the drone.

This connection is generally represented by the Wi-Fi logo appearing on your smartphone's screen.

- ④ Launch the Drone Planet application.

> The connection between your smartphone and the drone will be established automatically.

All of the following operations on this manual takes MODE 2 for example.

10.3 Pairing

① Long press the Power Switch button to turn on the drone and the indicator light on the drone begins to flash.

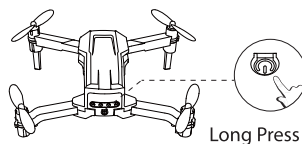

② Place the drone on a flat and level surface with the head forward and the tail facing towards the

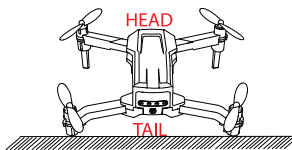

③ Short press the Power Switch button on the transmitter to turn it on.

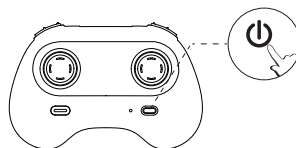

④ Push the left joystick up then down to pair the drone with the transmitter. The indicator lights on the drone and transmitter will turn solid if the drone is paired successfully.

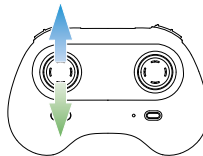

10.4 Calibrating the Gyro

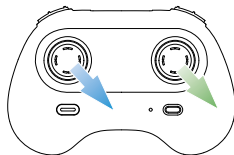

Simultaneously push the left joystick and the right joystick to the bottom right corner to calibrate the gyro. The indicator lights on the drone change from flashing to turn solid, indicating that the calibration is completed.

Tips: To ensure a stable flight, we suggest that the pilot calibrates the gyro every time after pairing the drone and after a crash.

10.5 Unlocking/Locking the Motors

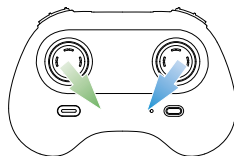

Unlocking the Motors: As the shown above, push the left joystick to the bottom right corner and the right joystick to the bottom left corner at the same time to unlock the motors. The motors will start to spin.

Locking the Motors: As the shown above, repeat this operation, the motors will stop immediately.

10.6 Auto Takeoff

There are two methods to take off the drone.

Method 1:

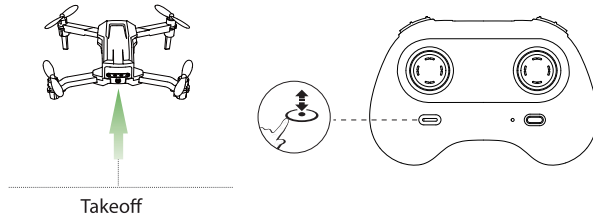

After pairing/calibration, unlock the motors, then press the One Key Takeoff/Landing button, the drone will take off automatically and hover at 5 feet altitude. At this time, you can control this drone by using the joysticks.

Method 2:



After pairing, pick up the drone and lay it flat on your palm. Gently toss the drone into the air, and it will hover in place.

10.7 One Key Landing

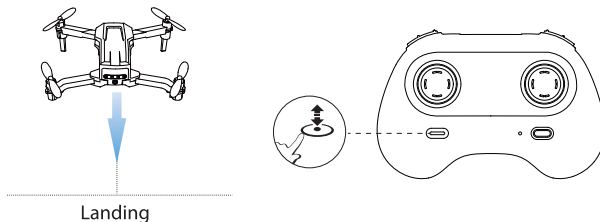

During the flight, press the One Key Takeoff/Landing button, the drone will land on the ground automatically.

11.0 FUNCTIONS DETAILS

11.1 Speed Switch

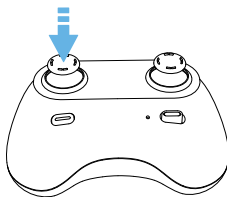

This drone comes with 2 speed modes (Low/High). Press in the Left Joystick to switch the speed. “Di” indicates Low Speed and “Di Di” indicates High Speed.

(The Low Speed is default speed mode.)

11.2 Emergency Stop

⚠️ The Emergency Stop function should only be used in case of emergency during the flight to avoid any of damage or injury.

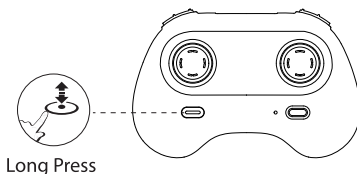

During the flight, long press the One Key Takeoff/Landing button, the motors will stop immediately.

Attention: Be aware that you risk breakage of the drone if it falls a large distance or hits anything at a high rate of speed.

11.3 Take Photo/Record Video

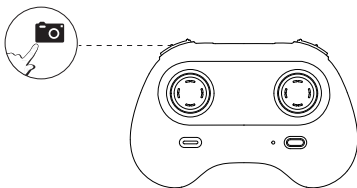

Take Photo: Short press the Take Photo/Record Video button, you can hear a beep from the transmitter, the drone indicator lights flashes once indicating the camera takes a photo.

Record Video: Long press the Take Photo/Record Video button, you can hear two beeps from the transmitter, the drone indicator lights flashes twice indicating the camera is recording the video. You will exit the recording by long press the same button.

11.4 Trimmer

Press in the direction joystick to enter the Trimmer, and press in the direction joystick again can exit the Trimmer.

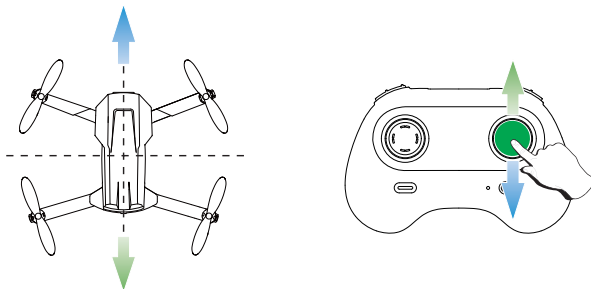

F/B Sideward Fly Trim: To enter the Trimmer, if the drone tends to drift forward, you can push the direction joystick down to re-balance the drone. If the drone tends to drift backward, you can push the direction joystick up to re-balance the drone.

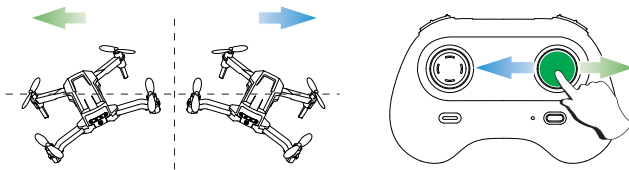

L/R Sideward Fly Trim: To enter the Trimmer, if the drone tends to drift left, you can push the direction joystick right to re-balance the drone. If the drone tends to drift right, you can push the direction joystick left to re-balance the drone.

11.5 360° Flip

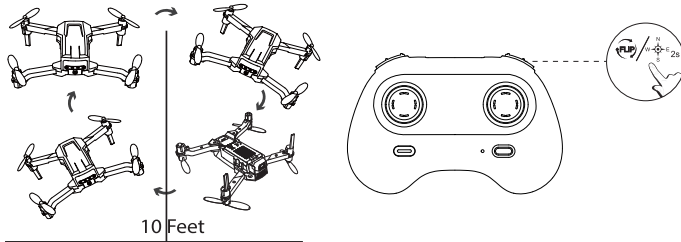

When you get familiar with all the functions of the drone, you can try this amazing flip mode. When you fly the drone at least 10 feet, short press the 360° Flip button on the transmitter, then push the right joystick Forward/Backward or Left/Right, and the drone will do a flip towards the corresponding direction.



This function will perform better when the battery is fully charged.

11.6 Altitude-Hold Function

The drone is designed with altitude-hold function so the drone can maintain its altitude after you release the left joystick. (The left joystick will automatically spring back to the middle)

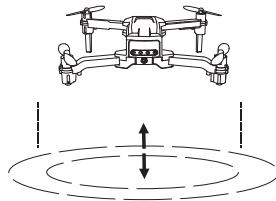

11.7 Headless Mode

⚠ Please familiarize with the Headless Mode function first before using this mode, otherwise it is easy to lose the drone and cause unnecessary loss.

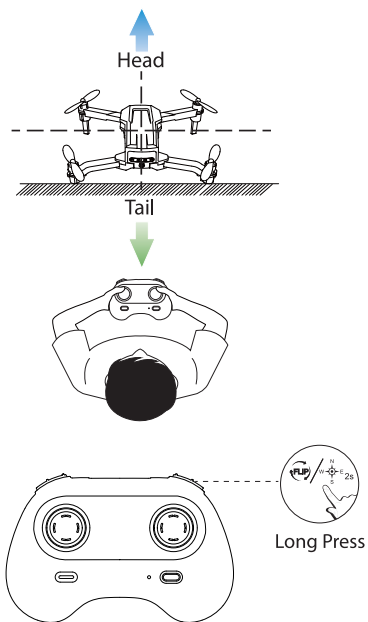

1. After pairing/calibration, long press the Headless Mode button on the transmitter. The transmitter will make a long beep, the indicator lights on the drone continue to flash to indicate that it is in Headless Mode.
2. Long press the Headless Mode button again, and you will hear a long beep from the transmitter, indicating the drone exits the Headless Mode.

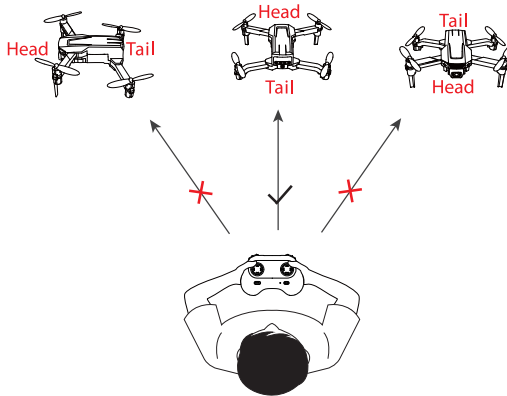

Please make the pilot stays facing the same direction as the direction that the head of the drone faces at take-off.

Under Headless Mode, the forward direction is the direction that the head of drone faces when the drone takes off. In order to make sure the pilot can tell drone's direction, we recommend that the pilot to stay in the same orientation as the drone head faces when the drone takes off. If so, when the pilot pushes the direction joystick forward, the drone will fly forward. If the pilot pushes the direction joystick backward, the drone will fly towards him/her. If the pilot moves the direction joystick left/right, the drone will move left/right relative to you. It is very important that the pilot stays in the same orientation as the drone head faces when the drone takes off.

12.0 SPECIFICATIONS

- DRONE

Model: HT25

Weight: 57g/2.01oz

Max Flight Time: 11 minutes (per battery)

Motor Model: 716

Operating Temperature Range: 32° to 104°F (0° to 40°C)

Size: 88×55×45mm (Folded)

134×126×45mm (Unfolded)

- TRANSMITTER

Operating Frequency: 2456-2480MHz

Max Flight Distance: 98 feet/30m (outdoors and unobstructed)

Operating Temperature Range: 32° to 104°F (0° to 40°C)

Battery: 1.5V AAA Battery (not Included)

- DRONE BATTERY

Capacity: 730mAh

Voltage: 3.85 V

Battery Type: Li-Po Battery

Charging Temperature Range: 41° to 104°F (5° to 40°C)

Charging Time: 90~100minutes (depends on charging power and remaining battery power)

- CAMERA

Operating Frequency: 2.4 GHz

Photo Resolution: 1920×1080P

Video Resolution: 1280×720P

Lens Angle: 60°

Max Transmission Distance: 98 feet/30m

(outdoor and unobstructed)

Live View Quality: 25fps

Photo Formats: JPEG

Video Formats: AVI/MP4

Operating Temperature Range: 32° to 104°F

- USB CHARGER

Voltage: 5 V

Rated Power: ≤10 W

13.0 CONTACT US

Please do not hesitate to contact us if you need further support.

- ✉ holyton@foxmail.com (USA)
- holyton_ca@foxmail.com (CA)
- holyton_jp@foxmail.com (JP)
- holyton_eu@foxmail.com (EU)

14.0 GENERAL INFORMATION

FCC Notice:

This device complies with Part 15 of the FCC Rules.

Operation is subject to the following two conditions:

- (1) This device may not cause harmful interference.
- (2) This device must accept any interference received, including interference that may cause undesired operation.

NOTE: This equipment has been tested and found to comply with the limits for a Class B digital device, pursuant to Part 15 of the FCC Rules. These limits are set to provide reasonable protection against harmful interference in a residential installation. This equipment generates uses and can radiate radio frequency energy. If is not installed and used in accordance with the instructions, it may cause harmful interference to radio communications. However, there is no guarantee that interference will definitely disappear after a particular installation. If this equipment does cause harmful interference to radio or television reception, which can not be determined by turning the equipment off and on, the user is encouraged to try to one or more of the following measures:

- Reorient or relocate the receiving antenna.
- Separation more distance between the equipment and receiver.
- Connect the equipment to an outlet on a circuit different from the receiver.
- Consult the dealer or an experienced radio/TV technician for help.

WARNING: Changes or modifications not expressly approved by the party responsible for compliance could void the user's authority to operate the equipment.

RF Exposure

The equipment complies with FCC radiation exposure limits set forth for an uncontrolled environment. This device should be installed and operated with a minimum distance of 20cm between the radiator & your body.

IC Notice:

This device complies with Canada Industry licence-exempt RSS standard(s).

Operation is subject to the following two conditions:

- (1) this device may not cause interference; and
- (2) this device must accept any interference. Including interference that may cause undesired operation of the device.

CAN ICES-3 (B)

Avis d'Industrie Canada

Le présent appareil est conforme aux CNR d'industrie Canada applicables aux appareils radio exem pts de licence L'exploitation est autorisée aux deux conditions suivantes:

- 1) l'appareil ne doit pas produire de brouillage; et
- 2) l'utilisateur de l'appareil doit accepter brouillage radioélectrique subi meme si le brouillage est susceptible d'encompromettre le fonctionnement. mauvais fonctionnement de l'appareil. Cet appareil numérique de la classe B est conforme à la norme NMB-003 du Canada.

CAN NMB-3 (B)

RF Exposure

Radiation Exposure Statement:

This equipment complies with IC radiation exposure limits set forth for an uncontrolled environment. This equipment should be installed and operated with a minimum distance of 20cm between the radiator & your body.

Déclaration d'exposition aux radiations:

Cet équipement est conforme aux limites d'exposition aux rayonnements IC établies pour un environnement non contrôlé. Cet équipement doit être installé et utilisé avec un minimum de 20 cm de distance entre la source de rayonnement et votre corps.

HOW TO RECYCLE THIS PRODUCT

This symbol on the product or its documentation indicates that it **MUST** not be disposed of together with household waste.

Uncontrolled waste disposal may harm the environment or human health.

Please separate your device from other types of waste of recycling it responsibly.

This will help to foster the sustainable re-use of material resources.

We suggest you contact your retailer, inquire at your local town hall or business store to find out where and how the drone can be recycled.

BATTERY WARNING:



1. Failure to follow **all** the instructions may result in serious injury, irreparable damage to the battery may cause a fire, smoke or explosion as well.

2. Always check the battery's condition before charging or using it.

3. Please replace the battery if the battery is dropped or has any peculiar smell, overheating, discoloration, deformation or leakage happens.
4. Never use anything other than the approved LiPo Charger to charge the battery. Always use a balancing charger for LiPo cells or a LiPo cell balancer. It is recommended that you use the one provided with the product.
5. The battery temperature must never exceed 60°C(140°F) otherwise the battery could be damaged or ignited.
6. Never charge the battery on a flammable surface, near flammable products or inside a vehicle(It is better to place the battery on a non-flammable and non-conductive surface).
7. Never leave the battery unattended during the charging process. Never disassemble or modify the housing's wiring, or puncture the cells. Always ensure that the charger output voltage corresponds to the voltage of the battery. Do not short circuit the batteries.
8. Never expose the Li-Po battery to moisture or direct sunlight, or store it in a place where temperatures could exceed 60°C(car in the sun, for example).
9. Always keep it out of reach of children.
10. Improper battery use may result in a fire, explosion or other hazards.
11. Non-rechargeable batteries are not allowed to be recharged. Rechargeable batteries should be charged under adults' supervision.
12. DO NOT mix different types of batteries including the new and used ones.
13. Batteries MUST be inserted with the correct polarity.
14. The supply terminals MUST not to be short-circuited. Regular examination of transformer or battery charger for any damage to their

15. The packaging has to be kept since it contains important information.

16. The toy is only can be connected to the equipment with symbol Class II.



Caution

1.The max operating of the EUT is 45°C. and shouldn't be lower than -10°C.

2.The device complies with RF specifications when the device used at 0mm from your body.

3.Declaration of Conformity.

We, Xiamen Huoshiquan Import & Export CO.,LTD hereby, declare that the compliance of the essential requirements with the

Directive 2014/53/EU, the RoHS Directive 2011/65/EU and Safety Directive 2009/48/EC have been fully fulfilled on our product with indication below:

Product Name: Remote control four axis series

Model/Mark : HT25/Holyton

The Statement of compliance is available at the following address:

http://www.holystone.com/docs/HT25_EU_DOC.pdf

This product can be used among EU member states.

MANUFACTURER INFORMATION

Manufactured by

Xiamen Huoshiquan Import & Export CO.,LTD.

Room 703, No. 813-2 Xiahe Road, Siming District, XIAMEN, China

+1(855) 888-6699



Made in China