

Holyton

14+
age

Instructions For Use

V3.0

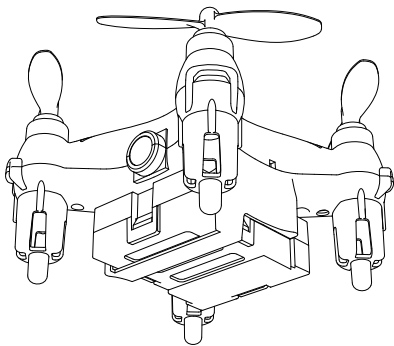

HT02



holyton@foxmail.com (USA)

holyton_jp@foxmail.com (JP)

holyton_ca@foxmail.com (CA)

English

01-26



Contents

1.0 Disclaimer & Warning	01
2.0 Safety Guidelines	01
3.0 Maintenance	05
4.0 Package Contents	06
5.0 Drone Details	07
6.0 Transmitter Details	07
7.0 Joystick Mode	08
8.0 Installation	
Drone Battery	09
Transmitter Battery	09
Propeller.....	10
9.0. Charging	11
10.0 Operation Guide	
Pairing	12
Calibrating the Gyro	13
One Key Takeoff/Landing	13
11.0 Functions Details	
Trimmer	14
Speed Switch	15
Emergency Stop.....	15
360° Flip	16
Headless Mode	17
One Key Return	18
Altitude-hold Function	19
12.0 Specifications	20
13.0 Contact Us	21
14.0 General Information	21

1.0 DISCLAIMER & WARNING

1. Please read this Disclaimer & Warning and Safety Guidelines carefully before using our product. This product is not recommended for people under the age of 14. By using this product, you hereby agree to this disclaimer and signify that you have read it fully. You agree that you are responsible for your own conduct and any damage caused while using this product, and any consequence. You agree to only use this product for its designed purposes and in accordance with the local laws, regulations and all applicable policies and guidelines that Holyton may provide.

2. When using this product, please be sure to strictly abide by the specification requirements and safety guidelines stated in this document. Any personal injury, property damage, legal disputes and all other adverse events caused by the violation of any of the safety instructions or due to any other factor, WILL NOT be Holyton's responsibility.

2.0 SAFETY GUIDELINES

2.1 Check Before Use

- ① This product is a high-precision drone that integrates various electronic stability and control mechanisms. Please be sure to configure this drone carefully and correctly to ensure safe, accident-free operation.
- ② Ensure that the batteries of the drone and transmitter are clean, undamaged, and fully charged before every use.
- ③ Ensure that all the propellers are intact and are installed in the correct orientation.

④ Please perform a thorough check of the product before each use. Inspect the integrity of the parts, any signs of cracks and wear off on the propellers, battery power and effectiveness of the indicator, etc. If there is any problem found after checking the drone, please refrain from using it until the problem is resolved.

2.2 Flight Environment



+



+



Fly in Open Areas

Keep in Sight

**Fly Below
98 feet (30 m)**



Avoid flying over or near obstacles, crowds, high voltage power lines, trees, airports, or bodies of water.

DO NOT fly near strong electromagnetic sources such as power lines and base stations as it may affect the onboard compass.



DO NOT use this drone in adverse weather conditions such as rain, snow, fog, and wind.

2.3 Operation Requirements

- ① DO NOT use this product to follow any moving vehicles.
- ② During the flight, turn off the motors only in case of an emergency.
- ③ When the battery runs low, return the drone back to your starting point.
- ④ DO NOT use this product if you feel tired, take medicine or feel unwell and drink alcohol.
- ⑤ Be aware of the volume of noise that the drone produces. Please ensure to keep your distance to avoid ear damage.



- ⑥ **Stay away from the rotating propellers and motors.**



- ⑦ **DO NOT fly in any spaces where drones are prohibited. Please respect people's right to privacy by not flying your drone close to others.**

2.4 Use of Battery

- ① Please ensure batteries are fitted in the correct orientation as shown in the instruction manual.
- ② Avoid short circuits by fitting the batteries correctly, and do not crush or squeeze the batteries as this could cause the risk of a fire or explosion.
- ③ DO NOT mix new and old batteries as this can lead to poor performance of the product.
- ④ Please dispose of used batteries carefully, do not litter and recycle where ever possible.
- ⑤ DO NOT expose dead batteries to heat or fire or they may explode.
- ⑥ If the device is not going to be used for an extended period of time, please remove batteries to prevent potential damage to the drone from battery leakage.

- ⑦ Only use the USB charging cable that comes with the drone to charge the battery.
- ⑧ DO NOT connect the battery directly to wall outlets or car cigarette -lighter sockets as this will damage your battery since they have different voltages.
- ⑨ DO NOT attempt to disassemble or modify the battery in any way
- ⑩ DO NOT use the battery if it gives off an odor, generates heat, becomes discolored, deformed or appears abnormal in any way. If any of these situations occur while the battery is in use or being charged, remove it from the device or charger immediately and discontinue use.
- ⑪ DO NOT pierce the battery casing with a nail or any other sharp object, break it open with a hammer, or step on it! Dispose or recycle this battery as it may cause personal injury or damage to your drone.
- ⑫ Always charge the batteries on a fireproof surface and away from combustible materials. DO NOT charge on surfaces that can catch fire, which includes: wood, cloth, carpet.
- ⑬ DO NOT immerse the battery in water or get it wet.
- ⑭ DO NOT solder battery terminal in any way.
- ⑮ Keep batteries out of reach of children or pets.
- ⑯ DO NOT short-circuit the battery by connecting wires or any other metal object to the positive(+) and negative(-) terminals.



Li-Po Battery Disposal & Recycling









Waste Lithium-polymer batteries must not be placed with household trash. Please contact local environmental or waste agency or the waste agency or the supplier of your model or your nearest Li-Po battery recycling center.

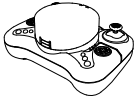

3.0 MAINTENANCE

- ① Clean the drone after each use with a clean, soft cloth.
- ② Avoid prolonged exposure to direct sunlight and avoid buildup of heat on the drone or batteries.
- ③ This device is not waterproof and must not be submerged or subjected to water under any circumstance. Failure to keep the device completely dry will result in failure and permanent damage to the unit. Be aware that although it might be dry where you are, droplets of rain or mist from a river or waterfall could damage your drone where it is flying.
- ④ Frequently check the charging plug and other accessories for signs of damage. If any part of the device or cables are damaged, avoid use or charging until the damaged parts are replaced.

4.0 PACKAGE CONTENTS

 × 1	 × 1	 × 1
Drone	Transmitter	Drone Battery
 × 1	 × 4	 × 2
USB Charging Cable	Propellers	Propeller Guard
 × 1	 × 1	 × 1
Screwdriver	Propeller spanner	Instructions For Use

5.0 DRONE DETAILS

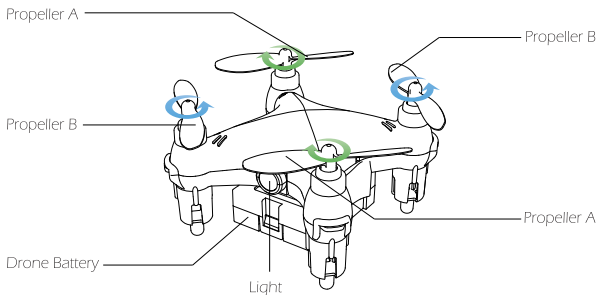

6.0 TRANSMITTER DETAILS

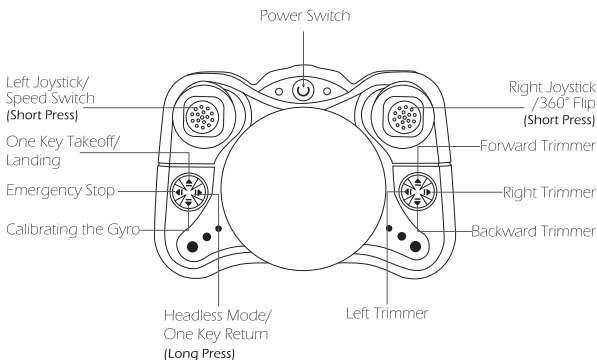

7.0 JOYSTICK MODE

7.1 MODE 2 (Left hand throttle MODE 2 will be default setting.)

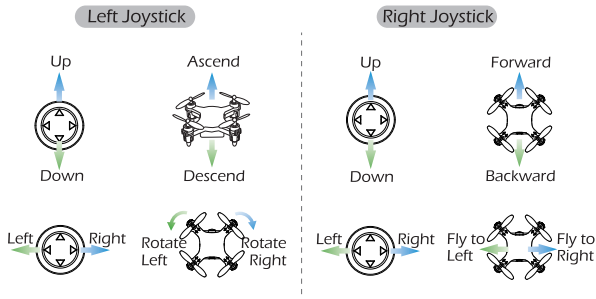

7.2 MODE 1

To enter MODE 1, turn on the transmitter while holding the “Emergency Stop” button. (Please do not release the “Emergency Stop” button until the transmitter is powered on.)

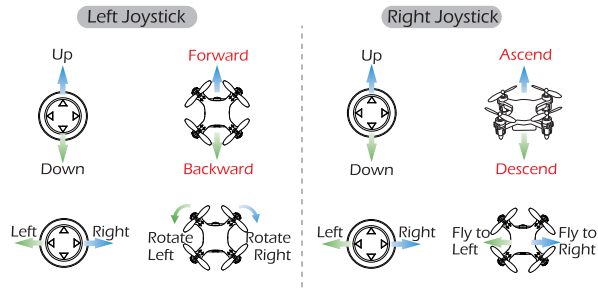

8.0 INSTALLATION

8.1 Drone Battery

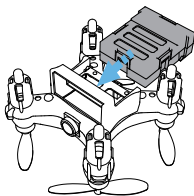

Push the battery into the battery compartment, make sure that you hear a click sound indicating the battery is firmly installed.

8.2 Transmitter Battery

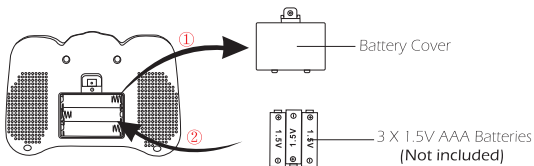

Open the battery cover on the back of the transmitter, insert three AAA batteries (**not included**) into the battery compartment, and close the battery cover and screw closed with the provided screw and screwdriver.

⚠ When installing the batteries, please pay attention to the positive and negative polarity of the battery to ensure the correct installation of the batteries.

8.3 Propeller

Installation:

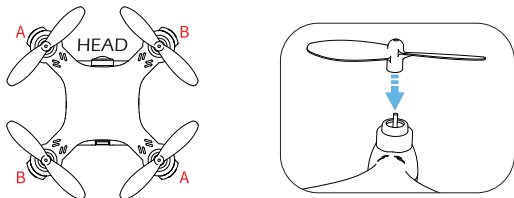

See illustration above. An "A" or "B" is printed on each propeller. Install the propeller to the motor shaft and press it into place.

Attention: The drone will not fly unless the correct propeller is installed on the correct motor shaft.

Removal:

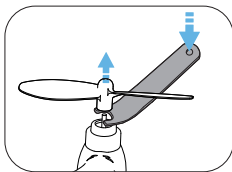

Insert the propeller spanner between the propeller and the motor. Be sure to hold the motor while detaching the propeller.

9.0 CHARGING

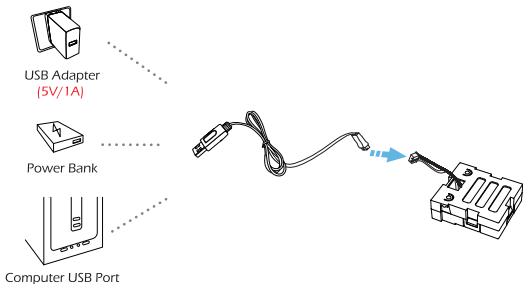

- 1) When the drone battery runs low, the indicator lights on the drone will blink continuously. After about 40 seconds, the drone will land automatically.
- 2) Remove the battery and connect the USB charging cable to the battery charging interface.
- 3) Plug the USB charging cable into a USB charging port on the computer, power bank, or USB adapter (5V/1A).
- 4) The red indicator light on the USB charging cable will turn on when the battery is charging and turn off when the battery is fully charged.
- 5) The approximate charging time is about 30 minutes.

⚠ Before charging, please read the introduction of the “Use of Battery” section of the “Safety Guidelines” carefully!

All of the following operations on this manual uses **MODE 2**.

10.0 OPERATION GUIDE

10.1 Pairing

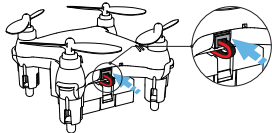

① Connect the battery port access to the fuselage power port.

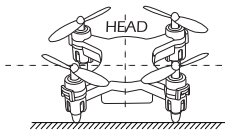

② Place the drone on a flat and level surface with the head forward and the tail towards the pilot.



③ Press and hold the Power Switch button to power on the transmitter.

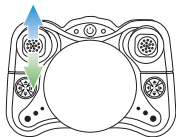

④ Push the Left Joystick up then down to pair the drone with the transmitter. The indicator lights on the drone will turn solid if the drone is paired successfully.

10.2 Calibrating the Gyro

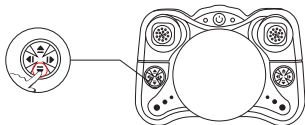

Press the Calibrating the Gyro button to calibrate the gyroscope of the drone, and you will hear a beep. Once the indicator lights start to flash rapidly, the gyroscope is being calibrated. When the lights turn solid, calibration is complete.

Tip: To ensure a stable flight, we suggest that the pilot calibrate the gyro after pairing the drone and after a crash.

10.3 One Key Takeoff/Landing

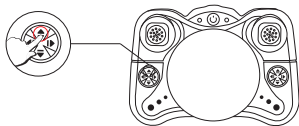

After pairing/calibration, press the One Key Takeoff/Landing button, the drone will automatically take off and hover at 5 feet altitude. At this time, you can control this drone by using the joysticks.

Press the One Key Takeoff/Landing button again, and the drone will land on the ground by itself.

11.0 FUNCTION DETAILS

11.1 Trimmer

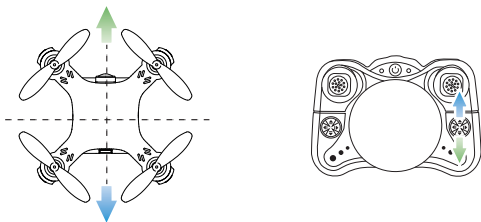

F/B Sideward Fly Trim: If the drone tends to drift forward, press the Backward Trimmer button to re-balance the drone. If the drone tends to drift backward, press the Forward Trimmer button to re-balance the drone.

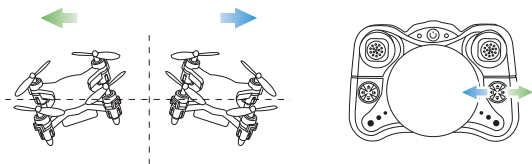

L/R Sideward Fly Trim: If the drone tends to drift to the left, press the Right Trimmer button to re-balance the drone. If the drone tends to drift to the right, press the Left Trimmer button to re-balance the drone.

11.2 Speed Switch

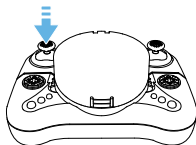

This drone comes with 3 speed modes (Low/Medium/High). Press in the Left Joystick to switch the speed. Increase or decrease one speed at a time. “Di” indicates Low Speed. “Di Di” indicates Medium Speed, and “Di Di Di” indicates High Speed.

(The Low Speed is default speed mode.)

11.3 Emergency Stop

⚠️ The Emergency Stop function should only be used in case of an emergency during the flight to avoid any damage or injury.

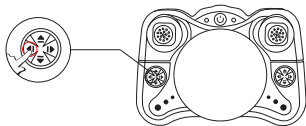

As shown in the figure above, long press the Emergency Stop button for about 2 seconds, the motors will stop immediately.

Attention: Be aware that you risk breakage of the drone if it falls a considerable distance or hits anything at a high rate of speed.

11.4 360° Flip

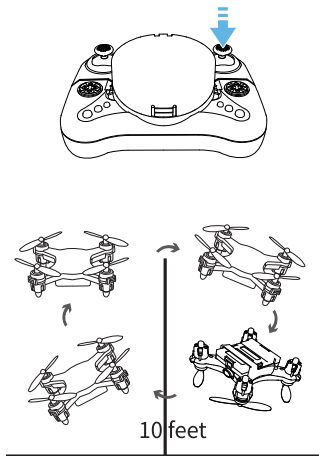

When you get familiar with all the drone's functions, you can try this fantastic flip mode. When you fly the drone at least 10 feet, press in the Right Joystick, then push the Right Joystick Forward/Backward or Left/Right, and the drone will do a flip towards the corresponding direction.

Tip: This function will perform better when the battery is fully charged.

11.5 Headless Mode

1. After pairing/calibration, press the Headless Mode button on the transmitter, and you will hear one beep from the transmitter. The indicator lights on the drone continue to flash to indicate that it is in Headless Mode.
2. Press the Headless Mode button again, the indicator lights on the drone will turn solid, indicating the drone exits the Headless Mode.

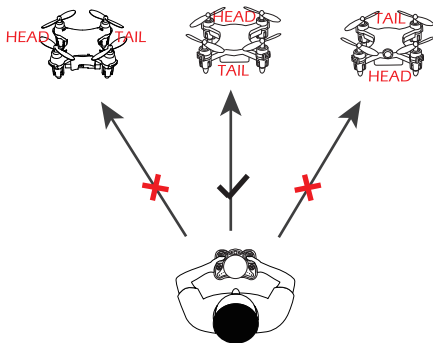

Please make the pilot stays facing the same direction that the drone head faces at takeoff.

While in Headless Mode, pushing the Right Joystick forward will make it fly in the direction that the head of the drone faces when it takes off. To make sure the pilot can tell the drone's direction during the flight, we recommend that pilot stays facing the same direction that the drone head faces at takeoff. Doing so ensures that when the pilot pushes the Right Joystick forward/backward, the drone will fly forward/backward toward them. If the pilot moves the Right Joystick left/right, the drone will move left/right relative to them.

11.6 One Key Return

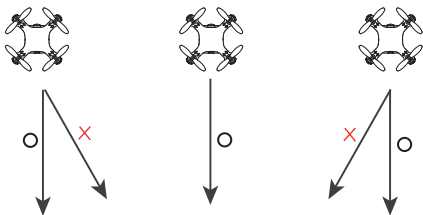

✗ Wrong

○ Right

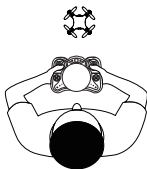

Please make sure the pilot stays in the same orientation as the drone head faces when the drone is pairing.

Long press the One Key Return button, the drone will return in the direction of which the drone's tail faced when paired. The indicator lights on the drone continue to flash to indicate that the drone is under One Key Return Mode. Long press the same button again or push the Right Joystick up or down to exit One Key Return Mode. The indicator lights on the drone will turn solid.

⚠ The drone has NO obstacle avoidance function.

11.7 Altitude-hold Function

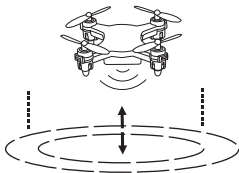

The drone is designed with an altitude-hold function to maintain its altitude after you release the left joystick. (The left joystick will automatically spring back to the middle)

12.0 SPECIFICATIONS

- **DRONE**

Model: HT02

Weight: 19g/0.67oz

Flight Time: 7~8 minutes (per battery)

Motor Model: 612

Operating Temperature Range: 32° to 104°F (0° to 40°C)

Size: 70 x 48 x 35 mm

- **TRANSMITTER**

Operating Frequency: **2456-2480 MHz**

Max Flight Distance: 98 feet/30m (outdoors and unobstructed)

Operating Temperature Range: 32° to 104°F (0° to 40°C)

Battery: 1.5V AAA Battery (not Included)

- **DRONE BATTERY**

Capacity: 220mAh

Voltage: 3.7V

Battery Type: Li-Po Battery

Charging Temperature Range: 14° to 104°F (-10° to 40°C)

Charging Time: 30 minutes (depends on charging power and remaining battery power)

- **USB CHARGING CABLE**

Input: 5V/1A

Rated Power: ≤5W

13.0 CONTACT US

Please do not hesitate to contact us if you need further support.

✉ holyton@foxmail.com (USA)
holyton_ca@foxmail.com (CA)
holyton_jp@foxmail.com (JP)



For online support, please scan
this code with Live Chat.

14.0 GENERAL INFORMATION

FCC Notice:

This device complies with Part 15 of the FCC Rules.

Operation is subject to the following two conditions:

- (1) This device may not cause harmful interference.
- (2) This device must accept any interference received, including interference that may cause undesired operation.

Supplier's Declaration of Conformity**Product Name:** Quadcopter**Model NO:** HT02**Responsible Party:** JL TRADING CO LTD**Responsible Party Address:** 5940 S RAINBOW BLVD STE 400-79525

LAS VEGAS, NV 89118

US Phone Number: 626-766-6284

NOTE: This equipment has been tested and found to comply with the limits for a Class B digital device, pursuant to Part 15 of the FCC Rules. These limits are designed to provide reasonable protection against harmful interference in a residential installation. This equipment generates uses and can radiate radio frequency energy, if not installed and used in accordance with the instructions, it may cause harmful interference to radio communications. However, there is no guarantee that interference will not occur in a particular installation. If this equipment does cause harmful interference to radio or television reception, which can be determined by turning the equipment off and on, the user is encouraged to try to correct the interference by one or more of the following measures:

- Reorient or relocate the receiving antenna.
- Increase the separation between the equipment and receiver.
- Connect the equipment into an outlet on a circuit different from that to which the receiver is connected.
- Consult the dealer or an experienced radio/TV technician for help.

WARNING: Changes or modifications not expressly approved by the party responsible for compliance could void the user's authority to operate the equipment.

RF Exposure

The equipment complies with FCC radiation exposure limits set forth for an uncontrolled environment.

Innovation, Science and Economic Development Canada (ISED)

This device complies with **ISED** licence-exempt RSS standard(s).

Operation is subject to the following two conditions:

- (1) this device may not cause interference; and
- (2) this device must accept any interference. Including interference that may cause undesired operation of the device.

CAN ICES-3 (B)**Avis d'Industrie Canada**

Le présent appareil est conforme aux CNR d'industrie Canada applicables aux appareils radio exempts de licence. L'exploitation est autorisée aux deux conditions suivantes:

- 1) l'appareil ne doit pas produire de brouillage; et
 - 2) l'utilisateur de l'appareil doit accepter le brouillage radioélectrique subi même si le brouillage est susceptible d'en compromettre le fonctionnement.
- Cet appareil numérique de la classe B est conforme à la norme NMB-003 du Canada.

CAN NMB-3 (B)**RF Exposure****Radiation Exposure Statement:**

This equipment complies with **ISED** radiation exposure limits set forth for an uncontrolled environment.

Déclaration d'exposition aux radiations:

Cet équipement est conforme aux limites d'exposition aux rayonnements

ISED établies pour un environnement non contrôlé.

HOW TO RECYCLE THIS PRODUCT

This symbol on the product or its documentation indicates that it must not be disposed of with household waste.

Uncontrolled waste disposal may harm the environment or human health.

Please separate your device from other types of waste and recycle it responsibly.

This will help to foster the sustainable re-use of material resources.

We suggest you contact your retailer, inquire at your local town hall or business store to find out where and how the drone can be recycled.



BATTERY WARNING:

1. Failure to follow all the instructions may result in serious injury, irreparable damage to the battery may cause a fire, smoke or explosion as well.
2. Always check the battery's condition before charging or using it.
3. Replace the battery if it has been dropped, or any odour, overheating, discolouration, deformation or leakage happens.
4. Never use anything other than the approval LiPo charger the battery. Always use a balancing charger for LiPo cells or a LiPo cell balancer. It is recommended that you use the one provided with the product.
5. The battery temperature must never exceed 60°C(140°F) otherwise the battery could be damaged or ignited.

6. Never charge the battery on a flammable surface, near flammable products or inside a vehicle (preferably place the battery on a non-flammable and non conductive surface).
7. Never leave the battery unattended during the charging process. Never disassemble or modify the housing's wiring, or puncture the cells. Always ensure that the charger output voltage corresponds to the voltage of the battery. Do NOT short circuit the batteries.
8. Never expose the Li-Po battery to moisture or direct sunlight, or store it in a place where temperatures could exceed 60°C(car in the sun, for example).
9. Always keep it out of reach of children.
10. Improper battery use may result in a fire, explosion or other hazards.
11. Non-rechargeable batteries are not allowed to be recharged. Rechargeable batteries should be charged under adults' supervision.
12. DO NOT mix different types of batteries including the new and used ones.
13. Batteries MUST be inserted with the correct polarity.
14. The supply terminals MUST not to be short-circuited. Regular examination of transformer or battery charger for any damage to their cords, plugs, enclosures and other parts MUST be done. If there is damage, they must not be used until the damage has been repaired.
15. The packaging has to be kept since it contains important information.
16. This toy should only be connected to Class II equipment bearing the symbol. 

EU RF Power(EIRP): <10 dBm

Caution

1. The max operating of the EUT is 45°C. And shouldn't be lower than -10°C.
2. The device complies with RF specifications when used at 0mm from your body.
3. Declaration of Conformity.

We, Xiamen Huoshiquan Import & Export CO.,LTD hereby, declare that the compliance of the essential requirements with the Directive 2014/53/EU, the RoHS Directive 2011/65/EU and Safety Directive 2009/48/EC have been fully fulfilled on our product with indication below:

Product Name: Remote control four axis series

Model/Mark: HT02/Holyton

The Statement of compliance is available at the following address:

http://www.holystone.com/docs/HT02_EU_DOC.pdf

This product can be used among EU member states.

MANUFACTURER INFORMATION

Manufactured by

Xiamen Huoshiquan Import & Export CO.,LTD.

Address: Unit. 33, Room 806, NO. 2 Huming Road, Siming District,

Xiamen, China

+1(855) 888-6699



Made in China