

► 11.4 GPS Searching (DO NOT use GPS Mode indoors)

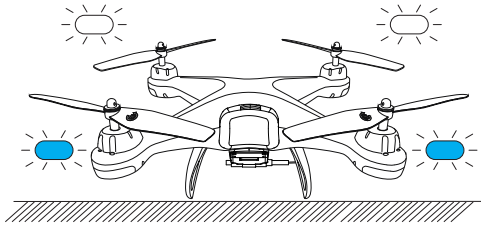

– Place the drone on a flat and dry surface where is unobstructed and lit area.

– The front White indicator light and the rear Blue indicator will flash quickly. This means the drone is searching the GPS Signal.

This process will take about one minute.

When four lights turn solid, GPS Mode is Ready (Only when the drone is connected to GPS successfully can it take off).

– Blue (back) and white (front) lights are all solid (no blinking).

ATTENTION:

① If the LED Flight Indicators keep blinking quickly, it indicates drone is searching for GPS signals.

② If the drone keep blinking quickly after a few minutes, it indicates that the process has FAILED. Please taking the drone one meter or so from the ground, and repeat all the Compass Calibration operations until the process is successful.

③ When flying indoors, please hold  button for 3 seconds to exit GPS Mode, and the LED lights will blink slowly. You can fly this drone when you complete the Compass Calibration operations if you exit GPS mode.

► 11.5 Unlock the Motor

Simultaneously push the left joystick to lower right corner and the right joystick to the lower left corner. The propellers rotate, indicating the drone is unlocked.

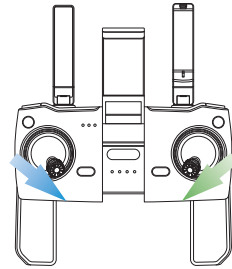

► 11.6 One Key Takeoff/Landing

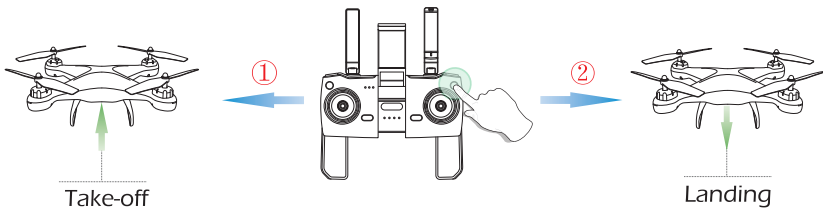









① Press the One Key Takeoff button (), the drone will automatically takeoff and hover at about 5 feet altitude.











② When the drone is flying, press the One Key Landing button (), the drone will automatically land on the ground.

12.0 FUNCTIONS DETAILS

► 12.1 APP Functions

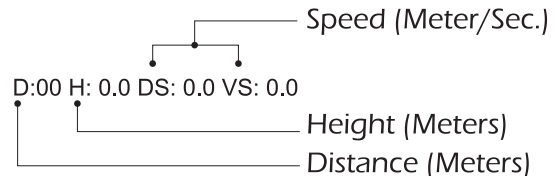

	<p>Return: Returns the main interface.</p>
	<p>Controls ON/OFF</p>
	<p>Tapfly: The drone will fly the path connecting the points on the map set by the operator. <i>(It is recommended to enlarge the map.)</i></p>
	<p>Media Gallery: Photos or video can be viewed.</p>
	<p>Flight Record: Tap to view historical data on flight date, distance, speed and altitude.</p>
	<p>3D VR: Match with VR glasses <i>(Not included)</i> to watch 3D images in real time.</p>
	<p>Flip Screen: Application interface can be 180 ° flip.</p>
	<p>GPS Signal: Displays current GPS signal strength.</p>
	<p>Setting: Tap the icon to enter the setting interface, settings for flight height/distance and return altitude.</p>

	<p>Follow Me: There are two modes of Follow Me Mode and Lock Follow Mode.</p>
	<p>Follow Me Mode: The drone stays at a distance from the operator and following the GPS position of the phone.</p>
	<p>Locked Follow Mode: After locking the following target, the camera is always oriented towards the following target, but the position of the drone remains unchanged. <i>(The following target should not move too fast to avoid following loss.)</i></p>
	<p>Return to Home: The drone will return to the last recorded Take-Off Point.</p>
	<p>Auto Take-off: The drone will take off automatically to a height of 5ft.</p>
	<p>Auto Landing: The drone will land slowly on the ground.</p>
	<p>Take Photo: Tap to take one photo at a time.</p>
	<p>Take Video: Tap once to start recording; tap again to stop recording.</p>
	<p>Sound Recording: The device can record the operator's voice while the camera is recording.</p>
	<p>Transmitter Battery Level: Real-time display of the current remaining battery level of the transmitter.</p>
	<p>Drone Battery Level: Real-time display of the current remaining battery level of the drone.</p>
<p>Waiting for GPS Signal</p> <p>↓</p> <p>Drone Status</p>	 <p>Speed (Meter/Sec.)</p> <p>D:00 H: 0.0 DS: 0.0 VS: 0.0</p> <p>Height (Meters)</p> <p>Distance (Meters)</p>

► 12.2 Beginner's Mode

The Default GPS Mode is Beginner Mode, Under Beginner Mode:

1. Flight Distance is limited between 0~30m/0~98.4feet.
2. Flight Altitude is limited between 0~30m/0~98.4feet.
3. RTH Altitude is under 25m/82feet.

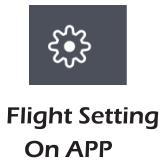

After entering the APP settings page (as shown above) , users can turn off the Beginner Mode to enter the Advanced Mode, and modify the operation parameters.

You only can Turn-off the Beginner Mode to modify the parameters in the APP on your phone after you complete the Compass Calibration operations.

► 12.3 Speed Switch

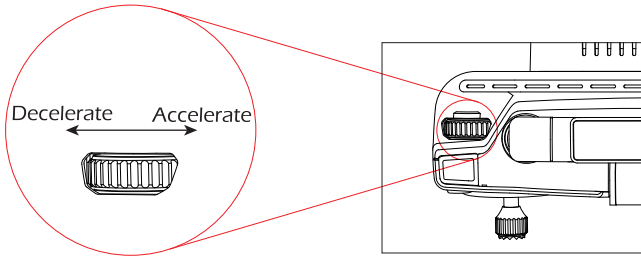

This drone comes with 3 speed modes (Low/Medium/High). Dial the wheel (⊖_{SPEED} ⊕) to the right to accelerate. Dial to the left to decelerate. If the Speed Status Light on the transmitter is turned off, it means the drone is in low speed. If the light is turned on, it means the drone is in medium speed. If the light is blinking, it means the drone is set to high speed. *(Medium Speed is default setting!)*

► 12.4 Emergency Stop

⚠ The Emergency Stop function should only be used in case of emergency during the flight to avoid any damage or injury.

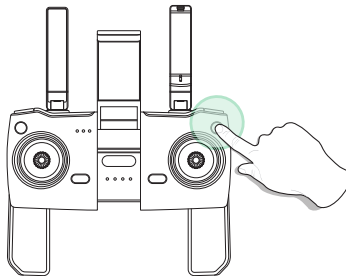

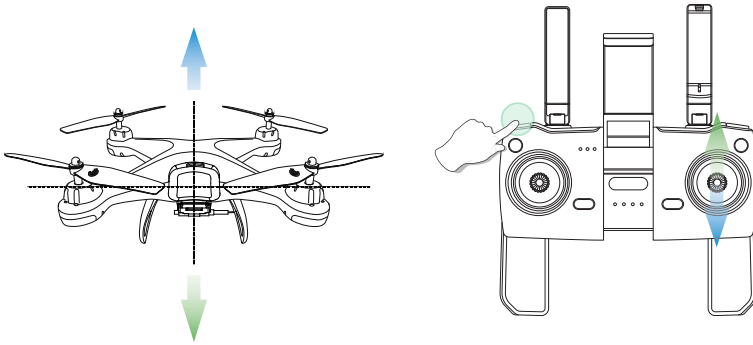

Press and hold One Key Takeoff/Landing button (⬆️⬆️) for 2 secs, the motors will stop immediately and the drone will fall directly.

► 12.5 Trimmer Function (Trim under NO GPS Mode)



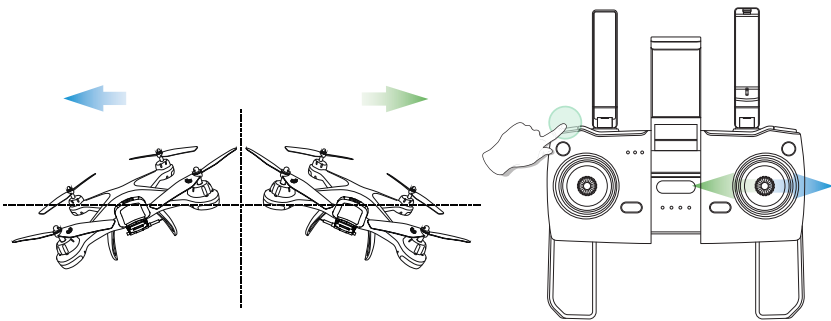

F/B Sideways Drift Trim : If the drone drifts forward, hold down the Trimmer button () and do not release it while pushing the direction joystick down to balance the drone. If the drone drifts backwards, hold down the Trimmer button and do not release it while pushing the direction joystick up to balance the drone.



L/R Sideways Dip Trim : If the drone drifts left, hold down the Trimmer button () and do not release it while pushing the direction joystick right to balance the drone. If the drone drifts right, hold down the Trimmer button and do not release it while pushing the direction joystick left to balance the drone.

► 12.6 Headless Mode

1. Press the Headless Mode button () on the transmitter. A beep will be heard from the transmitter, and the Headless Mode Indicator on the transmitter lights up, indicating that the drone enters Headless Mode.
2. Press the Headless Mode button () again, and you will hear one long beep, the Headless Mode Indicator on the transmitter is off which indicates the drone exits the Headless Mode.

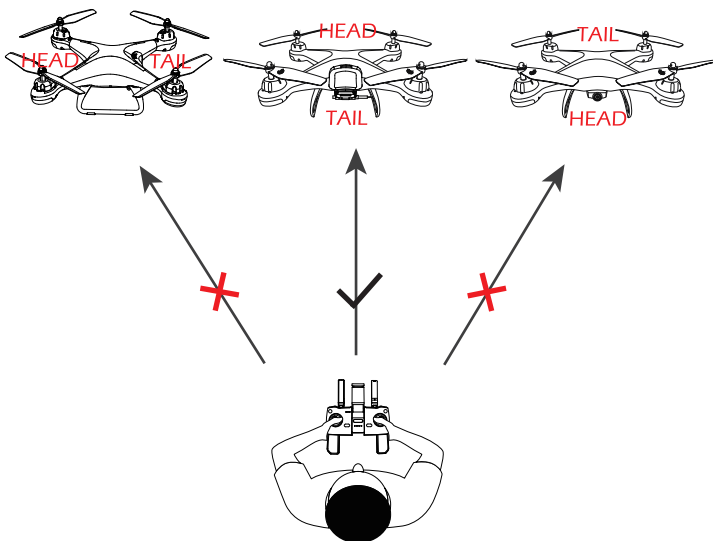

Please make the pilot stays facing the same direction that the drone head faces at take-off.

While in Headless Mode, pushing the direction joystick forward will make it fly in the direction that the head of the drone faces when it takes off. To make sure the pilot can tell drone's direction, during the flight, we recommend that pilot stays facing the same direction that the drone head faces at take-off. By doing so it is ensured that when the pilot pushes the direction joystick forward/backward, the drone will fly forward/backward toward him/her. If the pilot moves the direction joystick left/right, the drone will move left/right relative to the pilot.