



LUKE Arm

User Guide



*Part Number: LU-09012-001
Revision: 1.8
Date: December 05, 2016*

*Manufactured by:
Mobius Bionics
470 Commercial Street
Manchester, NH 03101
www.mobiusbionics.com*

Copyright

Copyright © 2016, Mobius Bionics LLC. All rights reserved.

Mobius Bionics LLC proprietary rights are included herein. This document contains Mobius Bionics confidential information and may not be copied, transferred, or disclosed, except as authorized by Mobius Bionics.

Trademarks

Bluetooth® is a registered trademark of Bluetooth SIG.

Wi-Fi® is a registered trademark of Wi-Fi Alliance.

Contents

About This Guide

How to Use This Guide	11
Conventions	12
Terminology	14
Acronyms	14
Contacting Technical Support	15

Chapter 1

LUKE Arm System

Indications for Use	17
LUKE Arm System	18
Arm Types	19
Shoulder Configuration (SC)	19
Humeral Configuration (HC)	19
Radial Configuration (RC)	19
Batteries and Holster	21
Internal Battery	21
External Battery	22
External Battery Holster	22
Battery Chargers and Charging Dock	23
Charging Pad	24
AC Adapter	24
Charging Dock	25
ACI (Arm Control Interface) Module	26
Input and Output Control Devices	27
IMUs (Inertial Measurement Units)	27
EMG (Surface EMG Electrodes)	27
Pressure Switches	28
Rocker Switches	28
Pressure Transducers	29
Linear Transducers	29
Tactor	30

Chapter 2

Safety

Safety Guidelines - Arm	31
Electromagnetic Interference (EMI) Safety	34
Safety Guidelines - Battery	35

Chapter 3 Arm Types and User Controls

System Battery Types..... 38
 User Controls and Wrist Display..... 38
 Power ON/OFF Button Location..... 39
 Turning the Arm ON and OFF 40
 Wrist Display 40
 Low Battery Icon and Low Battery Alert 41
 System Fault Icon 41
 Arm Mode LED and Grip Select LEDs 42
 Display Button 43
 Displaying the Battery Charge Level..... 43
 Changing the Display Brightness..... 44
 Swapping IMUs..... 44
 IMU LED Status..... 45
 Hand Open Button..... 47
 Orienting The Arm While Pressing The Hand Open Button 48

Chapter 4 Setting Up the Arm

Installing IMUs..... 49
 Installing the IMU to the Shoe Clip 50
 Installing the Shoe Clip to Your Shoe..... 52
 Location and Orientation of the IMUs 53
 Waking a Sleeping IMU..... 53
 Donning (Putting On) the Arm 54

Chapter 5 Using the Arm

Key Concepts..... 56
 Switching vs. Motion 56
 Operating Modes 57
 IMU - Walk Detect..... 58
 IMU - Angle Limit Detect..... 58
 Mode Change Interlock..... 59
 Zeroing the IMUs 59
 Safe Operation of the System 60
 What To Do If the Arm Is Not In Proper Working Order..... 60
 Arm Is Not in Proper Working Order 60
 Unsure When Using the Arm..... 60
 Grasp Release 61
 Doffing the Arm 61
 Safe Motions 62
 Taking It Slow..... 62
 Practicing Safe Operation of the System 63
 Lifting Heavy Objects 63
 Initializing the Arm..... 64
 Re-Initializing the Arm..... 65
 Improper Shutdowns..... 65

Operating Modes and Motions	66
Standby Mode (No Motion)	66
Hand Mode Motions.....	66
Opening or Closing the Hand.....	67
Compound Wrist Motions	67
Rotating the Wrist	69
Selecting a Grip	69
Power Grip (Grip Select LED 1).....	70
Tool Grip (Grip Select LED 2)	71
Fine Pinch Closed Grip (Grip Select LED 3).....	72
Fine Pinch Open Grip (Grip Select LED 4).....	72
Lateral Pinch Grip (Grip Select LED 5).....	73
Chuck Grip (Grip Select LED 6).....	75
Grip Detents	75
Arm Mode Motions	75
SC Arm Motions	76
Elbow Flexion - Extension (HC Arm)	79
Humeral Internal - External Rotation (HC Arm)	80
Doffing (Removing) the Arm	80

Chapter 6 Charging the Batteries

Battery Charging Safety	82
Testing the Internal Battery Charge Level.....	82
Charging the Internal Battery	83
Testing the External Battery Charge Level.....	85
Charging the External Battery	86
Removing the External Battery from the Holster	88
Installing the External Battery in the Holster.....	88
Testing the IMU Battery Charge Level	89
Charging the IMU Battery.....	90

Chapter 7 Maintaining and Troubleshooting the Arm

Maintaining the Arm	93
Removing and Replacing the Fingernails, Finger Covers and Hand Cover ...	94
Removing and Replacing Fingernails	95
Removing and Replacing Finger Covers	96
Removing and Replacing Hand Cover	97
Cleaning the Arm.....	98
Troubleshooting the Arm.....	100
LUKE Arm System Alerts	100
Troubleshooting	101

Appendix A Technical Specifications

Arm Specifications 107
Battery Specifications 112
AC Adapter Specifications 113
Charging Pad Specifications 114
Arm Radio Specifications 115

Appendix B Guidance and Manufacturer's Declaration

Electromagnetic Environment 117
 Electromagnetic Emissions 117
 Electromagnetic Immunity 118
Recommended Separation Distances 121
Essential Performance 122

List of Figures

Figure 1.	Arm Types	20
Figure 2.	Internal Battery	21
Figure 3.	External Battery	22
Figure 4.	External Battery Holster.....	23
Figure 5.	Charging Pad for IMU Battery.....	24
Figure 6.	AC Adapter	24
Figure 7.	Charging Dock	25
Figure 8.	ACI Module	26
Figure 9.	Example Inertial Measurement Unit	27
Figure 10.	Example EMG	27
Figure 11.	Example Pressure Switch	28
Figure 12.	Example Rocker Switch	28
Figure 13.	Example Pressure Transducer	29
Figure 14.	Example Linear Transducer	29
Figure 15.	Example Tactor Output Device.....	30
Figure 16.	Pinch Point Areas	34
Figure 17.	Power Button and LED - SC, HC, and RC Arms With External Battery Only	39
Figure 18.	Power Button and LED - SC and HC Arms with Internal Battery	40
Figure 19.	Wrist Display	41
Figure 20.	Hand Open Button	47
Figure 21.	Attaching the IMU to the Shoe Clip.....	51
Figure 22.	Attaching the Shoe Clip to the Shoe.....	52
Figure 23.	Hand Open Button	61
Figure 24.	Hand Open and Hand Closed	67
Figure 25.	Compound Wrist Motions	68
Figure 26.	Rotating the Wrist	69
Figure 27.	Power Grip.....	70
Figure 28.	Tool Grip	71
Figure 29.	Fine Pinch Closed Grip.....	72
Figure 30.	Fine Pinch Open Grip	72
Figure 31.	Lateral Pinch Grips	74
Figure 32.	Chuck Grip.....	75
Figure 33.	Moving the Hand Up or Down	77
Figure 34.	Moving the Hand Left or Right.....	77
Figure 35.	Moving the Hand Forward or Backward	78
Figure 36.	Voluntary Elbow Positioning (VEP)	79
Figure 37.	Elbow Flexion - Extension	79
Figure 38.	Humeral Internal - External Rotation.....	80
Figure 39.	Internal Battery Charging Port and Status Icon	84
Figure 40.	Testing the External Battery Charge Level.....	85
Figure 41.	External Battery Charging Dock and Status LEDs	87
Figure 42.	Removing and Replacing the External Battery	89
Figure 43.	Charging the IMU Battery.....	90
Figure 44.	Lateral Pinch Grip - Fully Open.....	94
Figure 45.	Removing and Replacing the Fingernails	96

Contents

Figure 46.	Lace - Securing Hand Cover	97
Figure 47.	Removing and Replacing the Finger and Hand Covers	98
Figure 48.	Dimensions of Shoulder Configuration (In Centimeters)	110
Figure 49.	Dimensions of Humeral Configuration (In Centimeters).....	111
Figure 50.	Dimensions of Radial Configuration (In Centimeters)	111

List of Tables

Table 1.	Arm System Icons	12
Table 2.	Text Conventions.....	13
Table 3.	Terminology	14
Table 4.	Acronyms.....	14
Table 5.	Arm and Battery Types	38
Table 6.	Arm Mode and Grip Select LEDs.....	42
Table 7.	Wrist Display Battery Charge Levels	43
Table 8.	IMU LED Status.....	45
Table 9.	Control Types - Switching vs. Motion	56
Table 10.	Arm and Operating Modes.....	57
Table 11.	Hand Mode — Motions	66
Table 12.	Grip Select LEDs	69
Table 13.	Arm Mode — Motions.....	76
Table 14.	Internal Battery Charging Port and Status Icon	84
Table 15.	External Battery Charge Level.....	86
Table 16.	External Battery Charging Dock Status LEDs.....	87
Table 17.	IMU Battery Charging LED Status	91
Table 18.	Troubleshooting - Try This First.....	101
Table 19.	Troubleshooting - Wrist Display and System Faults.....	102
Table 20.	Troubleshooting - Arm Function.....	104
Table 21.	Troubleshooting - Power and Battery Charging.....	105
Table 22.	Arm System Specifications.....	107
Table 23.	Operating Environmental Range.....	107
Table 24.	Transport and Storage Environmental Range.....	108
Table 25.	Service Life Specifications.....	108
Table 26.	Mass of Arm Configurations.....	109
Table 27.	Dimensions of Arm Configurations	109
Table 28.	Battery Charge and Operation Times.....	112
Table 29.	Power Specifications - Internal Battery	112
Table 30.	Power Specifications - External Battery	112
Table 31.	Power Specifications - IMU Battery.....	113
Table 32.	AC Adapter Specifications	113
Table 33.	Charging Pad Specifications.....	114
Table 34.	Arm Radio Specifications.....	115
Table 35.	Guidance and Manufacturer’s Declaration - Electromagnetic Emissions	117
Table 36.	Guidance and Manufacturer’s Declaration - Electromagnetic Immunity.....	118
Table 37.	Recommended Separation Distances (Part I).....	121
Table 38.	Recommended Separation Distances (Part II).....	122

About This Guide

The intent of this guide is to help guide you in the use of the LUKE arm system. Read this guide before using the arm.

NOTICE

This guide is shipped with the LUKE arm system.

How to Use This Guide









To learn about the arm and how to use the arm read the chapters in the table below.

Read	To Learn About...
Chapter 1	Overview — Provides a summary of the arm and arm parts.
Chapter 2	Safety — Provides WARNINGS and CAUTIONS on using the arm and batteries.
Chapter 3	Arm Types and User Controls — Provides information about arm types, batteries, and user controls and displays.
Chapter 4	Setting Up the Arm — Tells you how to install the IMUs and don the arm.
Chapter 5	Using the Arm — Provides information on key concepts as well as how to safely initialize the arm, change operating modes, and command hand and arm motions.
Chapter 6	Charging the Batteries — Provides steps on how to charge all batteries.
Chapter 7	Maintenance and Troubleshooting — Tells you how to maintain the arm as well as troubleshoot problems.

Conventions

Table 1 describes the arm system icons and Table 2 describes text conventions used throughout this guide.

Table 1. Arm System Icons

Icon	Meaning	Description
	Alert	Alerts you to potential injury hazards. Obey all safety messages that follow this symbol to avoid possible injury.
	Information Note	Notice is used to address practices not related to personal injury.
	CAUTION	Cautions indicate a hazardous situation which, if not avoided, could result in minor or moderate injury.
	WARNING	Warnings indicate a hazardous situation which, if not avoided, could result in death or serious injury.
	Read This Guide	Used to instruct you to refer to this guide prior to using the LUKE arm system.
	Electrically Isolated Equipment	Indicates Type BF equipment which is electrically isolated and can safely contact a person's skin without the risk of electric shock.
	Radio Transmitter	Indicates that equipment contains a radio transmitter.
	Disposal of Equipment	Indicates that equipment should not be disposed of in the trash.





Icon	Meaning	Description
	Recycle Equipment	Indicates that equipment should be recycled.
	Use Indoors	Identifies electrical equipment designed for indoor use and should be kept dry.
	Meets Class II Safety Requirements	Identifies equipment that meets the safety requirements specified for Class II equipment according to IEC 61140.
	MR Unsafe	Indicates that equipment is not compatible with magnetic resonance (MRI) environment.

Table 2. Text Conventions

Convention	Appearance in Text	Example
Key concepts and emphasized text	Appear in bold type.	Inertial Measurement Unit
Book titles, directories, pathnames, and filenames	Appear in italic typeface.	<i>LUKE Arm User Guide</i>

Terminology

Table 3 describes the terminology used in this guide to describe the arm, socket, and accessories.

Table 3. Terminology

Term	Description
Arm	Refers to the arm hardware in isolation.
Prosthesis	Refers to the combination of the socket and the arm.
Arm System	Refers to the socket, arm, and all related accessories.

Acronyms

Table 4 lists the acronyms used in this guide.

Table 4. Acronyms

Acronym	Description
ACI	Arm Control Interface — Controls the interface between you and the Master Arm Controller.
EMG	Electromyograph — A sensor that is placed on the skin and senses the activation signal of a muscle.
EMI	Electromagnetic Interference — Interference to the arm’s electronics caused by external electrical sources.
HC	Humeral Configuration — A type of arm.
IMU	Inertial Measurement Unit — A control input that is placed on top of a foot or lower appendage.
LED	Light Emitting Diode — A light that displays a status.
MAC	Master Arm Controller — The main processing unit of the arm.
RC	Radial Configuration — A type of arm.
SC	Shoulder Configuration — A type of arm.
SOC	State of Charge — The battery charge level.
USB	Universal Serial Bus — A standard way for a computer to talk to other devices.
VEP	Voluntary Elbow Positioning — A type of arm motion of the LUKE arm.

Contacting Technical Support

To contact technical support use the following address, web site URL or telephone:

Mobius Bionics

470 Commercial Street

Manchester, NH 03101

www.mobiusbionics.com

603-239-3834

855-MOBIUS1 (855-662-4871)

LUKE Arm System

This chapter provides an overview of the LUKE arm system which includes the socket, arm, batteries, AC Adapter, charging pad, and arm inputs and outputs.

Prior to using the LUKE arm system you must have met with your prosthetist. During the meeting(s) the prosthetist will have performed a number of steps such as:

- design and build a custom socket to attach the arm
- pick the arm configuration and arm parts to best fit your needs
- set up and configure the arm
- allow you to test the arm system in a controlled setting

Once the prosthetist feels that you have met all demands in order to use the arm they will allow you to use the arm. You should clearly understand how the prosthetist has set up your arm prior to using the arm.

Indications for Use

The LUKE arm system consists of a prosthetic arm and accessories which are used by a certified prosthetist to create a full upper extremity prosthesis indicated for individuals, age 18 years and older, who have partial or full upper limb amputations or congenital defects. The device is used to assist in activities of daily living (ADLs).

LUKE Arm System

The LUKE arm system is comprised of a specific arm type and several accessories depending on the arm type. The arm system is described below.

⚠ WARNING

RISK OF DEATH OR SERIOUS HARM

Do not take apart or change the arm or connected parts. This could lead to harm.

NOTICE

Based on your arm's type and setup you may not have some of the following parts.

Note the following concerning the LUKE arm system:

- The arm is internally powered (when under battery power).
- The arm is designated Class II (when plugged into the AC Adapter).
- The arm and all body worn accessories are Type BF applied parts.

NOTICE

The IMUs have an IP57 rating. The other body worn components of the arm system, when installed and covers are in place, have an IP52 rating. The IP rating specifies the strength of the enclosure against solids (such as dust) and liquids. An IP52 rating provides resistance to light rain and fine dust. An IP57 rating provides resistance to fine dust and submersion to depths of 1 m.

Arm Types

Your LUKE arm is one of the three types listed below and shown in [Figure 1](#). Your prosthetist will have chosen the arm type that best fits your needs and set up the arm for the right or left side as well as proper length.

Shoulder Configuration (SC)

This arm type is for those amputees with little or no residual limb or for those amputees with limited movement or other restricting factors in their residual limb.

Humeral Configuration (HC)

This arm type is for those amputees with a residual limb below the shoulder but not including the elbow.

Radial Configuration (RC)

This arm type is the shortest of the three and is for amputees with a residual limb below the elbow.

Figure 1. Arm Types



Shoulder Configuration (SC)



Humeral Configuration (HC)



Radial Configuration (RC)

Batteries and Holster

There are two battery types used to power the arm. Which battery type is used depends on your arm type and how your prosthetist configured the power to the arm. The two batteries are:

Internal Battery

This battery may be used to power the SC and HC arms and is located within the arm's forearm. See [Figure 2](#).

NOTICE

Depending on how your prosthetist configured your arm you may not have an internal battery.

Figure 2. Internal Battery

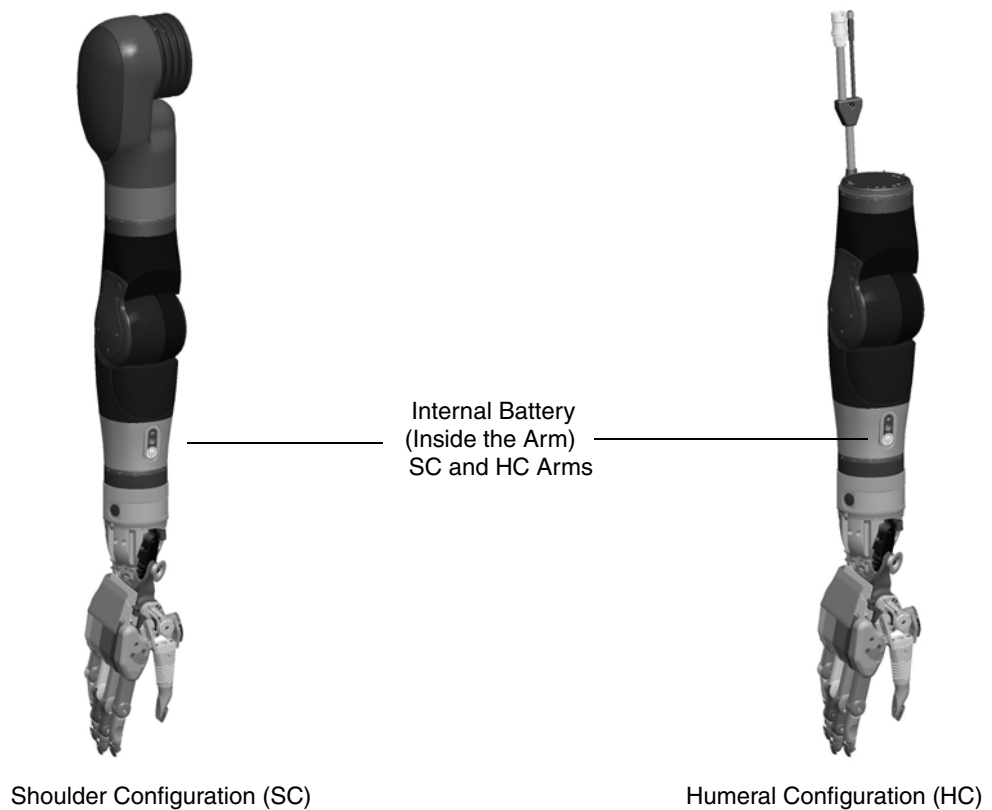

External Battery

This battery, see [Figure 3](#), is normally worn on a belt or in a pocket and is used in one of two ways:

- In SC and HC arms, with an internal battery, it may be used to supplement power to the arm.
- In RC arms and in SC and HC arms, without an internal battery, it is used standalone to power the arm.

The external battery is used with an external battery holster to power the arm. See [External Battery Holster](#) for more information.

Figure 3. External Battery



External Battery Holster

The external battery is mounted in a holster which in turn can be clipped to a belt or worn in a pocket. See [Figure 4](#). The belt clip can be attached to the holster so that the external battery is in either the vertical or horizontal position. There are two versions of the holster; one with an ON/OFF button and power LED and one without. For more information see [Power ON/OFF Button Location](#).

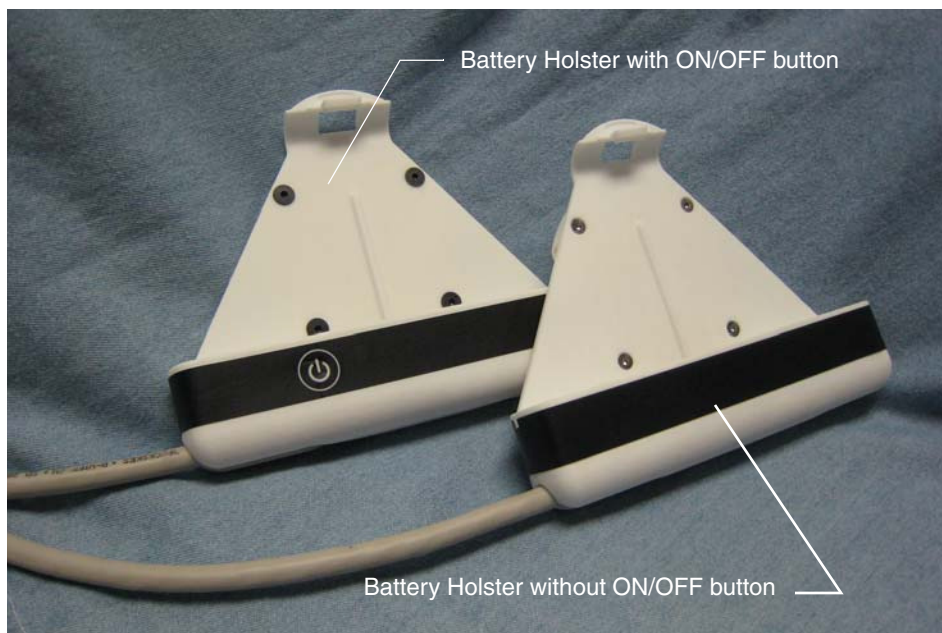
Figure 4. External Battery Holster

Battery Chargers and Charging Dock

There are three components used for charging the batteries: a charging pad, an AC Adapter, and a charging dock. The AC Adapter is used with the charging dock to charge the external battery. To charge an internal battery, the AC Adapter plugs directly into the arm.

Charging Pad

A wireless charging pad is provided in order to charge the IMU battery. [Figure 5](#) shows the charging pad.

Figure 5. Charging Pad for IMU Battery



AC Adapter

The AC Adapter is used with the external battery charging dock and to directly charge the internal battery within the arm. The AC Adapter comes with a line cord for use in your country. [Figure 6](#) shows the AC Adapter.

Figure 6. AC Adapter

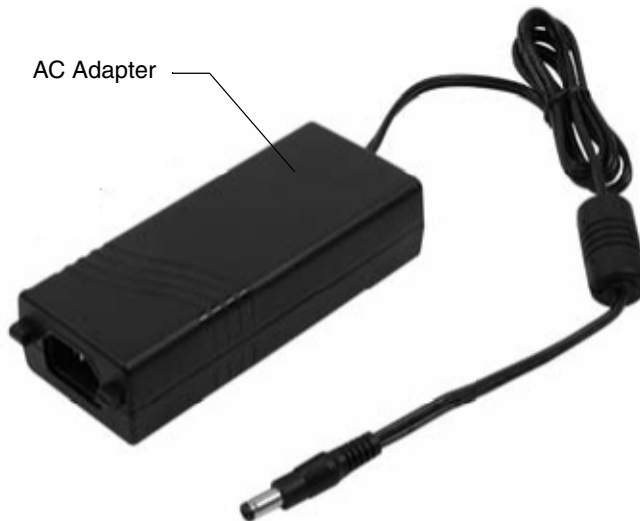

Charging Dock

The charging dock is used to charge the external battery. The charging dock has two slots allowing you to charge two batteries at once and is powered by the AC Adapter. When charging the battery you should remove the battery from its holster and place it in the charging dock. [Figure 7](#) shows the charging dock.

Figure 7. Charging Dock

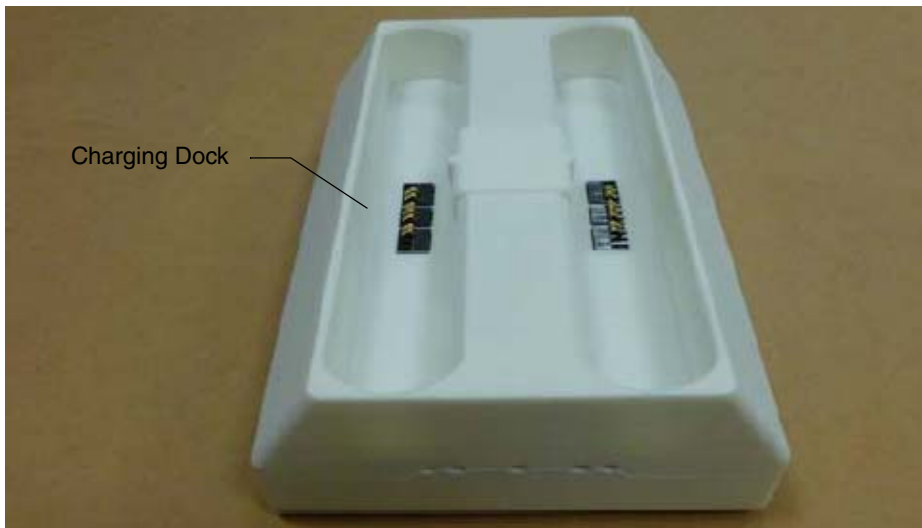

ACI (Arm Control Interface) Module

The ACI Module, see [Figure 8](#), receives signals from user inputs (e.g., surface EMG electrodes and pressure transducers) and sends them to the MAC which in turn controls the arm. The ACI Module provides four user inputs and connects to the arm.

NOTICE

The arm supports up to four IMU/ACI modules at a time in multiple combinations, with a maximum of two IMUs. For example, your prosthetist may configure the arm to support two IMU modules and two wired ACI modules or four wired ACI modules and no IMUs.

Figure 8. ACI Module

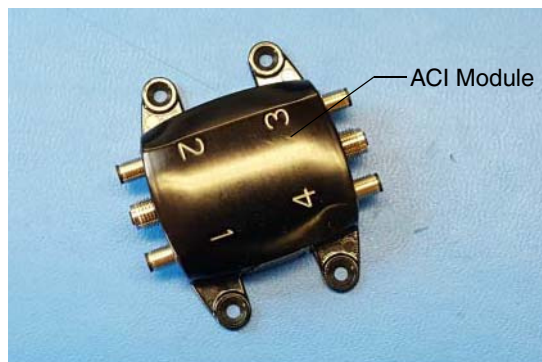

Input and Output Control Devices

The arm uses several input devices and a single output device to control the arm. The following sections describe these devices.

IMUs (Inertial Measurement Units)

IMUs are placed on top of your shoes and command motion or grip selection by having you tilt your foot. See [Figure 9](#). To install the IMUs see [Installing IMUs](#).

Figure 9. Example Inertial Measurement Unit

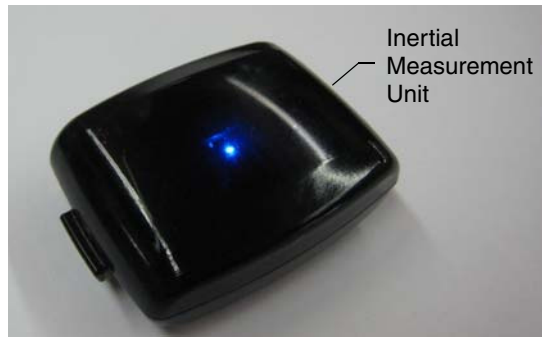

EMG (Surface EMG Electrodes)

EMGs are placed on your skin or embedded into your socket to maintain contact against your skin. EMGs are used to read electrical signals from underlying muscle contractions. EMGs command motion by having you contract the selected muscle. [Figure 10](#) shows an example of a type of EMG.

Figure 10. Example EMG

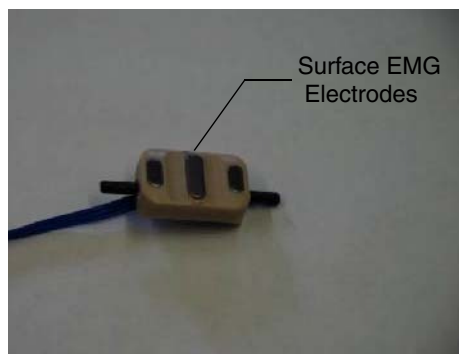

NOTICE

When donning the arm system, static electricity discharge to EMGs can damage them. To minimize the chance of EMG damage, touch any metal on the arm before touching the EMGs. If you think the EMG is not working correctly, see [Troubleshooting the Arm](#).

IMU LED Status

The IMU LED shows the functions of the IMU. Pressing the display button for less than one second causes the IMU battery to blink showing the charge level. [Table 8](#) describes the functions of the IMU LEDs.

Table 8. IMU LED Status

Function	Color	Status	Description
Normal Operation	Blue	One blink every five (5) seconds	IMUs are operating normally and are communicating with the arm.
Walk Detect	Blue	Solid	Indicates walk detect mode. For more information see IMU - Walk Detect and Zeroing the IMUs .
Fault	Amber	Blinking	Indicates a sensor self-test has failed. Try resetting the IMU by removing it from the charging pad, waiting five (5) seconds, and then placing the IMU on the charging pad. If the condition continues contact Technical Support. See Contacting Technical Support .
		Solid	Indicates charging has been paused. The system should recover from this condition. If after 30 minutes charging does not continue, contact Technical Support for service on the charger or the IMU. See Contacting Technical Support .

Table 8. IMU LED Status

Function	Color	Status	Description
Checking Battery Charge Level or Shaking to Wake	Blue	5 blinks every 5 seconds (3 times)	Fully charged (80% to 100%)
		4 blinks every 5 seconds (3 times)	Charge level is dropping (60% to 80%)
		3 blinks every 5 seconds (3 times)	Charge level is dropping (40% to 60%)
		2 blinks every 5 seconds (3 times)	Charge level is dropping (20% to 40%)
		1 blink every 5 seconds (3 times)	Low battery (0% to 20%). See <i>Charging the IMU Battery</i> .
Sleep Mode	Off	No blinks	IMU is in sleep mode. See <i>Waking a Sleeping IMU</i> .
Discharged Battery	Off	No blinks	IMU battery is discharged. See <i>Charging the IMU Battery</i> .
Awake and Waiting	Off	No blinks	IMU is awake and waiting to connect to the arm.

Setting Up the Arm

This chapter provides information on how to set up the arm. Based on how your prosthetist configured your arm, you may need to install some arm parts and then don the arm to ensure proper fit prior to using the arm.

Topics in this chapter include:

- *Installing IMUs*
- *Donning (Putting On) the Arm*

NOTICE

Before installing the arm parts and donning the arm be sure to visually inspect all the arm parts and the arm for any sign of damage. If there is any sign of damage, contact Technical Support. See *Contacting Technical Support*.

Installing IMUs

If your arm's control scheme calls for IMUs with shoe clips, you can install them at this time. There are two steps to installing the IMU:

1. Attaching the IMU to the shoe clip.
2. Attaching the shoe clip to your shoe.

If you need help putting on and taking off the IMUs with shoe clips, have your caregiver available at this time.

NOTICE

The IMUs have an IP57 rating. The IP rating specifies the strength of an enclosure against solids (such as dust) and liquids. An IP57 rating provides resistance to water at depths up to 1 m (39 inches) and resistance to fine dust.

NOTICE

The IMUs will not provide data if dramatically tipped (close to vertical). Be sure to position the IMU as close to level as possible when installing the IMU. If you attach the IMU to your shoe at a severe angle to begin with, the IMU will not provide the full range of motion after zeroing.

Installing the IMU to the Shoe Clip

To install the IMU to the shoe clip see [Figure 21](#) and perform the following steps:

NOTICE

Be sure to install the IMU(s) onto the correct foot as configured by your prosthetist. **DO NOT SWAP THE IMU(s) DURING INSTALLATION.**

1. Slide the tabbed end of the IMU into the open end of the shoe clip.
When installing the IMU onto the shoe clip, please ensure the following:
 - The Front Arrow label on the bottom of the IMU is facing towards your toes.
 - Keep the IMU aligned with the direction of movement. This will prevent any cross talk from occurring.
2. Press down on the IMU until the shoe clip retention tab snaps into the IMU slot. Ensure the IMU is fastened securely to the shoe clip.

NOTICE

- The shoe clip can be put on the shoe either before or after the IMU is installed on the shoe clip.
- You can attach the IMU to the shoe by alternate means (i.e., straps or pockets) as long as it is securely attached.

Figure 21. Attaching the IMU to the Shoe Clip

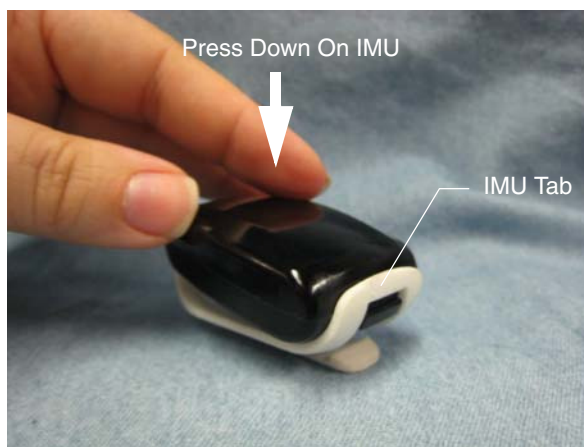
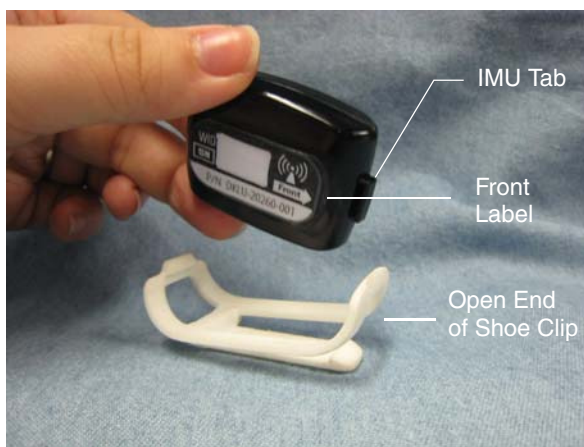

Installing the Shoe Clip to Your Shoe

To install the shoe clip to your shoe see [Figure 22](#) and perform the following steps:

NOTICE

- Note that the shoe clip can be installed onto your shoe with the shoe off your foot or on your foot.
- Once you have installed the shoe clip, the shoe clip can remain on the shoe.

1. Orient the shoe clip so that the open end of the clip is facing towards your toes.
2. Slide the shoe clip under the laces of the shoe (left or right).

When installing the shoe clip to the shoe, please ensure the following:

- The shoe clip passes through at least two of the shoe's laces to ensure the clip is secure and stable.
- The Front Arrow label on the bottom of the IMU is facing towards your toes.

3. Tighten the laces to secure the IMU and shoe clip to the shoe.
4. If you have not already done so put on the shoe.
5. Once you have installed the IMUs you can don (put on) the arm. See [Donning \(Putting On\) the Arm](#).

Figure 22. Attaching the Shoe Clip to the Shoe



Open End of Shoe Clip
NOTE: IMU is shown attached to shoe clip.

NOTICE

The IMUs do not contain an ON/OFF button. An IMU that is awake and set up to communicate with an arm will do so once the arm is powered **ON**. See *Waking a Sleeping IMU* and *Initializing the Arm*.

Location and Orientation of the IMUs

During the configuration process your prosthetist will have located and oriented the IMUs to ensure proper operation of the arm. Be sure to locate and orient the IMUs per your prosthetist's instructions.

Waking a Sleeping IMU

When an IMU has not communicated with the arm for more than 30 minutes, the IMU reverts to a sleep mode to conserve the battery. When in sleep mode the IMU is not listening for arm communication.

As a result, if the IMU is in sleep mode when the arm is turned on, it will not connect with the arm. This results in the Grip Select LEDs sweeping while the arm is trying to find the IMUs. If no IMUs are found, the System Fault Icons on the wrist display blink along with an "IMU Comm Lost" fault code. Shaking your foot with the IMU attached wakes the IMU from sleep mode so that the IMU is ready to communicate with the arm once the arm system is powered up.

An IMU that has been shaken awake is waiting to communicate with the arm. IMUs that are not actively communicating with an arm blink the battery state of charge whenever they are shaken, regardless of whether they are sleeping or not.

NOTICE

If the IMU does not communicate with the arm within five (5) minutes of being shaken awake, the IMU reverts back to sleep mode to conserve the battery.

IMU - Walk Detect

The IMUs are designed to detect rapid foot movements (such as those seen while walking) and not use these movements as arm commands. For example, if you shake your feet the IMUs would detect this as motion other than a normal command. When walk detect is active, the white Arm Mode LED blinks rapidly and the blue IMU LED is solid. Note that when walk detect is active you will not be able to move the arm using the IMUs, however, non-IMU controls will continue to function as configured. If you are concerned about arm movement while walking (or at other times) put the arm in **Standby** mode prior to walking.

When you stop walking and the IMUs come to rest, the arm reverts back to the previous mode (**Arm** or **Hand**) the arm was in prior to entering walk detect and resumes normal operation. This happens automatically when the IMU commands return to zero. If the walk detect LED continues to blink, this indicates that the arm is still receiving a command from one of your inputs. To resolve this issue, make sure your IMUs are positioned correctly, your feet are flat/normal to the ground and you are not activating any other inputs.

If you cannot resume normal operation of the arm and the white Arm Mode LED continues blinking with your feet flat on the ground, the IMU zero point is incorrect and the current signal level is above a set threshold. To fix this issue you need to re-position the IMUs on your feet or zero the IMUs by going into **Standby** mode. See *Zeroing the IMUs*.

IMU - Angle Limit Detect

The IMUs are designed to detect when you exceed the IMUs' angle limit. This occurs when you tip the IMUs more than 45 degrees since the last time the IMUs were zeroed or were out of range. As a result, the white Arm Mode LED on the Wrist Display blinks rapidly informing you of the problem.

If the IMUs exceed 45 degrees, you will not be able to move the arm with the IMUs, however, non-IMU controls will continue to function as designed. To resume normal operation you need to return your foot/feet to the rest or zero position.

If the white Arm Mode LED continues to blink, you need to reposition the IMUs, re-position your feet, or zero the IMUs by going into **Standby** mode. See *Zeroing the IMUs*.

Mode Change Interlock

If you are in the process of switching modes (**Standby** to **Hand** mode or **Hand** to **Arm** mode) and the system detects a command to move, the mode change interlock becomes active. As a result, the white Arm Mode LED on the Wrist Display blinks rapidly informing you of the problem.

You can switch modes when mode change interlock is active, however you will not be able to command the arm. When the IMUs are returned to the zero position or the wired input falls below the activation threshold you will be able to command the arm.

If the problem does not clear automatically and the white Arm Mode LED continues to blink, you need to re-position the IMUs/feet or zero the IMUs by going into **Standby** mode (See *Zeroing the IMUs*) or you need to ensure the wired inputs are not activated.

Zeroing the IMUs

Zeroing the IMUs establishes a neutral position. When you take the arm out of **Standby** mode the system zeros the IMUs by taking a snapshot of the IMU's position and identifies that position as neutral. For example, if you should take the arm out of **Standby** mode while your feet and attached IMUs are in an inclined position the IMUs will be zeroed at that position. If you should then place your feet and IMUs in a different position without zeroing the IMUs the result could be unintended arm motion. To ensure this does not occur re-zero the IMU s by performing the following steps:

1. Using the designated mode input place the arm in the **Standby** mode.
2. Place your feet at the position you want to zero the IMUs (usually feet flat on the ground).
3. Using the designated mode input take the arm out of **Standby** mode.
4. The IMUs are now zeroed for that position and the IMU LED blinks blue once every five (5) seconds.

NOTICE

If you have to continually re-zero the IMUs while not changing the neutral position you should check to ensure the IMUs and shoe clips are securely attached to your shoes.

Charging the IMU Battery

To charge the IMU battery you need to remove the IMU from its shoe mounting clip and place the IMU on the charging pad. Note the following when charging the IMU battery:

NOTICE

- IMUs cannot be charged during use. The prosthesis stops functioning and the System Fault Icon on the wrist display illuminates if this is attempted.
- Do not place any objects on the charging pad other than the IMUs.
- Mobius Bionics suggests that you charge the IMU battery overnight.
- The estimated time to recharge an empty IMU battery to 80% capacity is less than 2.0 hours.
- You can charge up to two IMUs at a time on the charging pad.

See [Figure 43](#) to see how the IMU is placed on the charging pad and [Table 17](#) for a description of the IMU charging status LEDs.

Figure 43. Charging the IMU Battery



Table 17. IMU Battery Charging LED Status

Function	Color	Status	Description
Charging	Blue	Slow Blinking	IMU is performing a self-test.
		Fast Blinking	Battery is charging. NOTE: A fully discharged IMU may need to partially charge before the LED will blink blue. When the IMU is on the charging pad, the charging pad's status LEDs will be blue.
		Solid	Battery is fully charged.
Fault	Amber	Blinking	Indicates a sensor self-test has failed. Try resetting the IMU by removing it from the charging pad, waiting five (5) seconds, and then placing the IMU on the charging pad. If condition continues contact Technical Support. See <i>Contacting Technical Support</i> .
	Amber	Solid	Indicates charging has been paused. The system should recover from this condition. If after 30 minutes charging does not continue, contact Technical Support for service on the charger or the IMU. See <i>Contacting Technical Support</i> .

To charge the IMU battery perform the following steps:

1. Turn **OFF** the arm.
2. Plug the charging pad's AC Adapter into an electrical outlet.
3. Remove the IMU from its shoe mounting clip.
4. Set the IMU on the charging pad circle. (One IMU per circle).

Ensure the IMU is placed on the pad with the LED facing up, so you can view the IMU LEDs.

5. Ensure the charging pad status LEDs are ON when charging the IMUs. See [Figure 43](#).
6. View the status of the IMU battery charge status LEDs. See [Table 17](#).
7. Reattach the IMU to its shoe clip. The IMU is now ready for use.

NOTICE

You **cannot** replace the IMU battery. If there is a problem with the IMU battery, turn the arm power **OFF**, doff the arm, and contact Technical Support. See [Contacting Technical Support](#).

NOTICE

IMUs are awake and waiting for communication from the arm once it is removed from the charging pad. However, the IMU goes into sleep mode if it has not communicated with the arm within 30 minutes. See [Waking a Sleeping IMU](#).

Troubleshooting the Arm

This section provides basic troubleshooting steps to help you find and resolve possible problems that may occur with the arm. It also describes how alerts are generated and indicated to identify possible problems.

NOTICE

If at any time you feel the arm is not in proper working order (e.g., slow to move, hard to control, making odd sounds, etc.) turn the battery power **OFF** and contact Technical Support at once. See *Contacting Technical Support*.

LUKE Arm System Alerts

The arm system generates alerts to indicate possible problems. Many of these alerts are indicated by LEDs. The LED may blink or turn a certain color to indicate the alert. The arm system may also sound a tone to indicate an alert.

All alerts are low priority alarms and technical alarms.

Alerts may be generated when:

- A battery is discharged
- Hardware is damaged

Alerts are generated when:

- Communication with an IMU is lost
- You attempt to charge an IMU when the prosthesis is in operation

To learn more about these alerts see *User Controls and Wrist Display* and *Chapter 6, "Charging the Batteries"*.

Troubleshooting

The following tables provide solutions to solving problems with the arm.

Table 18. Troubleshooting - Try This First

TRY THIS FIRST	These basic tips may help you quickly solve problems with the arm:
	<ol style="list-style-type: none"> 1. Put the arm into Standby Mode. 2. Check and secure the IMUs on your feet. 3. Take the arm out of Standby Mode.
	<ol style="list-style-type: none"> 1. Power the arm off. 2. Shake the IMUs to wake them. Look for the blinking blue LEDs. 3. Make sure all cables are securely connected. 4. Put your feet flat on the ground 5. Power the arm on.

See the tables below to help you in troubleshooting problems with the arm system:

- [Table 19, Troubleshooting - Wrist Display and System Faults](#)
 - Use this table for help when Wrist Display LEDs are on or flashing
- [Table 20, Troubleshooting - Arm Function](#)
 - Use this table for help with moving the arm or changing grips
- [Table 21, Troubleshooting - Power and Battery Charging](#)
 - Use this table for help with powering the arm on and charging batteries

If the solutions in these troubleshooting tables do not solve the problem with the arm, contact Technical Support. See [Contacting Technical Support](#).

Table 19. Troubleshooting - Wrist Display and System Faults



Problem	Cause	Solution
<p>System Fault Icons Blinking Fault Code: 3</p> 	<p>IMU not awake</p>	<ol style="list-style-type: none"> 1. Power the arm off 2. Shake the IMUs to wake them 3. Power the arm on
	<p>IMU battery low</p>	<ol style="list-style-type: none"> 1. Power the arm off 2. Shake the IMU to check the IMU battery charge level and charge if necessary 3. Power the arm on
	<p>Ham radios, walkie talkies, theft detectors, or metal detectors are affecting the arm</p>	<ol style="list-style-type: none"> 1. Power the arm off 2. Move the arm at least 0.5 m (20 inches) away from any ham radios, walkie talkies, theft detectors, or metal detectors 3. Power the arm on
<p>System Fault Icons Blinking Fault Code: 36</p> 	<p>ACI not talking to arm</p>	<ol style="list-style-type: none"> 1. Power the arm off 2. Check and tighten all system cables 3. Power the arm on
<p>System Fault Icons Blinking Fault Codes: 25, 26, 34, 256</p> 	<p>Arm motors warm</p>	<ol style="list-style-type: none"> 1. Power the arm off 2. Move to a cooler location if possible 3. Wait 15 minutes 4. Power the arm on
<p>System Fault Icons Blinking Fault Code Not Listed</p>		<p>Contact Technical Support. See <i>Contacting Technical Support</i>.</p>

Table 19. Troubleshooting - Wrist Display and System Faults



Problem	Cause	Solution
<p>Low Battery Icon On</p> 	<p>Battery is low</p>	<p>Replace the external battery in the holster with a fully charged battery.</p> <p>Plug the AC Adapter into the forearm charging port</p>
	<p>External battery not connected</p>	<ol style="list-style-type: none"> 1. Check that the external battery is properly seated in the holster 2. Check and tighten the cables between the arm and the holster
<p>Grip Select LEDs Sweeping</p> 	<p>IMU not talking to arm</p>	<p>Shake the IMUs to wake them</p>
	<p>IMU battery is low</p>	<p>Charge the IMUs</p>
	<p>Ham radios, walkie talkies, theft detectors, or metal detectors are affecting the arm</p>	<p>Move the arm at least 0.5 m (20 inches) away from any ham radios, walkie talkies, theft detectors, or metal detectors</p>
<p>Arm Mode LED Blinking</p> 	<p>Walk Detect</p>	<ol style="list-style-type: none"> 1. Stop walking 2. Put your feet flat on the ground 3. Check that the Arm Mode LED has stopped blinking
	<p>IMU tilted too far</p>	<ol style="list-style-type: none"> 1. Put the arm into Standby Mode 2. Check and secure the IMUs on your feet 3. Put your feet flat on the ground 4. Take the arm out of Standby Mode
	<p>Input device not working</p>	<p>Contact Technical Support. See <i>Contacting Technical Support</i>.</p>

Table 20. Troubleshooting - Arm Function

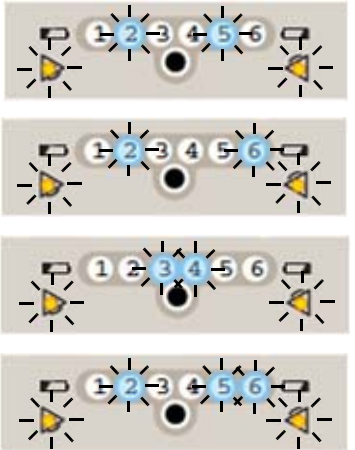
Problem	Cause	Solution
Arm moving without command	IMU zero position changed	<ol style="list-style-type: none"> 1. Put the arm into Standby Mode 2. Check and secure the IMUs on your feet. 3. Put your feet flat on the ground 4. Take the arm out of Standby Mode
	Sweat near EMGs	<ol style="list-style-type: none"> 1. Put the arm into Standby Mode 2. Wipe the sweat from the EMG electrode and skin with a dry cloth 3. Take the arm out of Standby Mode
	Ham radios or walkie talkies are affecting the arm	<ol style="list-style-type: none"> 1. Put the arm into Standby Mode 2. Move the arm at least 0.5 m (20 inches) away from any ham radios or walkie talkies 3. Take the arm out of Standby Mode
Arm not moving	Arm is in Standby Mode	Put the arm into Hand Mode
	Arm is off	<ol style="list-style-type: none"> 1. Shake the IMUs to wake them 2. Power the arm on
	Arm is faulted	See Table 19, Troubleshooting - Wrist Display and System Faults .
	Input device not connected	<ol style="list-style-type: none"> 1. Power the arm off 2. Check and tighten all connections at the ACI 3. Power the arm on
Cannot change Modes	Input device not connected	<ol style="list-style-type: none"> 1. Power the arm off 2. Check and tighten all connections at the ACI 3. Power the arm on
	Input device not working	Contact Technical Support. See Contacting Technical Support .
Cannot change grips	Hand is not fully open	<ol style="list-style-type: none"> 1. Put the arm into Hand Mode 2. Fully open the hand 3. Change grips
	Input device not working	Contact Technical Support. See Contacting Technical Support .

Table 21. Troubleshooting - Power and Battery Charging

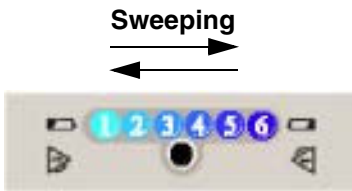

Problem	Cause	Solution
Arm does not power on	Internal battery too low	<ol style="list-style-type: none"> 1. Plug the AC Adapter into the forearm charging port 2. The charging status icon first blinks yellow for a few minutes. Wait until the charging status icon blinks blue. 3. Power the arm on
	External battery too low	<ol style="list-style-type: none"> 1. Replace the external battery in the holster with a fully charged one 2. Power the arm on
	External battery not connected	<ol style="list-style-type: none"> 1. Check that the external battery is properly seated in the holster 2. Check and tighten the cables between the arm and the holster 3. Power the arm on
Internal Battery Charging		
Charging Status Icon Blinking Yellow 	Internal battery charging paused	<ol style="list-style-type: none"> 1. Move the arm to a cooler location 2. Wait up to 2 hours. You can keep the arm on and the AC adapter connected while waiting. 3. Charging should continue on its own. If it does not, contact Technical Support. See <i>Contacting Technical Support</i>.
Charging Status Icon On Solid Yellow 	Internal battery charging fault	Contact Technical Support. See <i>Contacting Technical Support</i> .

Table 21. Troubleshooting - Power and Battery Charging

Problem	Cause	Solution
External Battery Charging		
Charging Dock Fault Status Blinking Yellow	Charging paused	<ol style="list-style-type: none"> 1. Wait up to 2 hours. You can keep the charging dock on and the battery in the charging dock while waiting. 2. Charging should continue on its own. If it does not, contact Technical Support. See <i>Contacting Technical Support</i>.
Charging Dock Fault Status On Solid Yellow	Charging fault	Contact Technical Support. See <i>Contacting Technical Support</i> .
IMU Charging		
IMU Yellow LED On Solid	Charging paused	<ol style="list-style-type: none"> 1. Wait up to 30 minutes. You can keep the charging pad on and the IMU on the charging pad while waiting. 2. Charging should continue on its own. If it does not, contact Technical Support. See <i>Contacting Technical Support</i>.
IMU Yellow LED Blinking	Self test failure	<ol style="list-style-type: none"> 1. Remove the IMU from the charging pad 2. Wait 5 seconds 3. Place the IMU on the charging pad 4. If the error persists, contact Technical Support. See <i>Contacting Technical Support</i>.
IMU LED off	IMU not talking to charging pad	<ol style="list-style-type: none"> 1. Clean the top of the charging pad. 2. Clean the bottom of the IMU. 3. Place the IMU, LED side up, on the charging pad's center circle.

If the solutions in these troubleshooting tables do not solve the problem with the arm, contact Technical Support. See *Contacting Technical Support*.

Technical Specifications

This appendix provides technical specifications for the LUKE arm, battery, AC Adapter and charging pad.

Arm Specifications

Table 22. Arm System Specifications

Parameter	Range/Explanation
Compliance	The LUKE arm system complies with IEC 60601-1:2005
Power Type	The arm is internally powered when under battery power
Designation	The arm is designated Class II when plugged into the AC Adapter
Parts Type	The arm and all body worn accessories are Type BF applied parts

Table 23. Operating Environmental Range

Parameter	Range/Explanation
Operating Temperature	<ul style="list-style-type: none"> 10 °C to 40 °C (50 °F to 104 °F) with no degradation in performance -10 °C to 50 °C (14 °F to 122 °F) with reduced arm speed and/or load capacity
Humidity	15% to 93% (non-condensing)
Pressure	700 hPa to 1060 hPa
Arm and body worn Mobius Bionics supplied accessories IP rating	IP52

Table 23. Operating Environmental Range (Continued)

Parameter	Range/Explanation
IMU IP Rating	IP57

NOTICE

When using the arm continuously in a hot environment (40°C, 104°F) and while charging the internal battery, portions of the forearm and upper arm (if applicable) could reach temperatures of 54°C - 57°C (130°F - 135°F), when evaluated as directed in IEC60601-1: 2005-12.

Table 24. Transport and Storage Environmental Range

Parameter	Range
Storage Temperature (excluding battery)	-25 °C to 70 °C (-13 °F to 158 °F)
Humidity	15% to 93% (non-condensing)
Pressure	700 hPa to 1060 hPa

Table 25. Service Life Specifications

Part	Service Life
Arm	Expected to function for up to three (3) years with an 18 month service interval
Internal and External Batteries	Expected to provide at least 80% of new capacity for up to a year of typical use
IMU Battery	Expected runtime is at least 18 hours for up to a year of use
AC Adapter and Charging Pad	Expected to function for up to three (3) years
External Battery Holster and External Battery Charging Dock	Expected to function for up to three (3) years
ACI and Cables	Expected to function for up to three (3) years

Table 26. Mass of Arm Configurations

Arm Configuration	Mass
Shoulder Configuration (SC)	4.7 kg
Humeral Configuration (HC)	3.4 kg
Radial Configuration (RC)	1.4 kg

Table 27. Dimensions of Arm Configurations

Arm Configuration	Dimensions
Shoulder Configuration (SC)	See Figure 48
Humeral Configuration (HC)	See Figure 49
Radial Configuration (RC)	See Figure 50

Figure 48. Dimensions of Shoulder Configuration (In Centimeters)

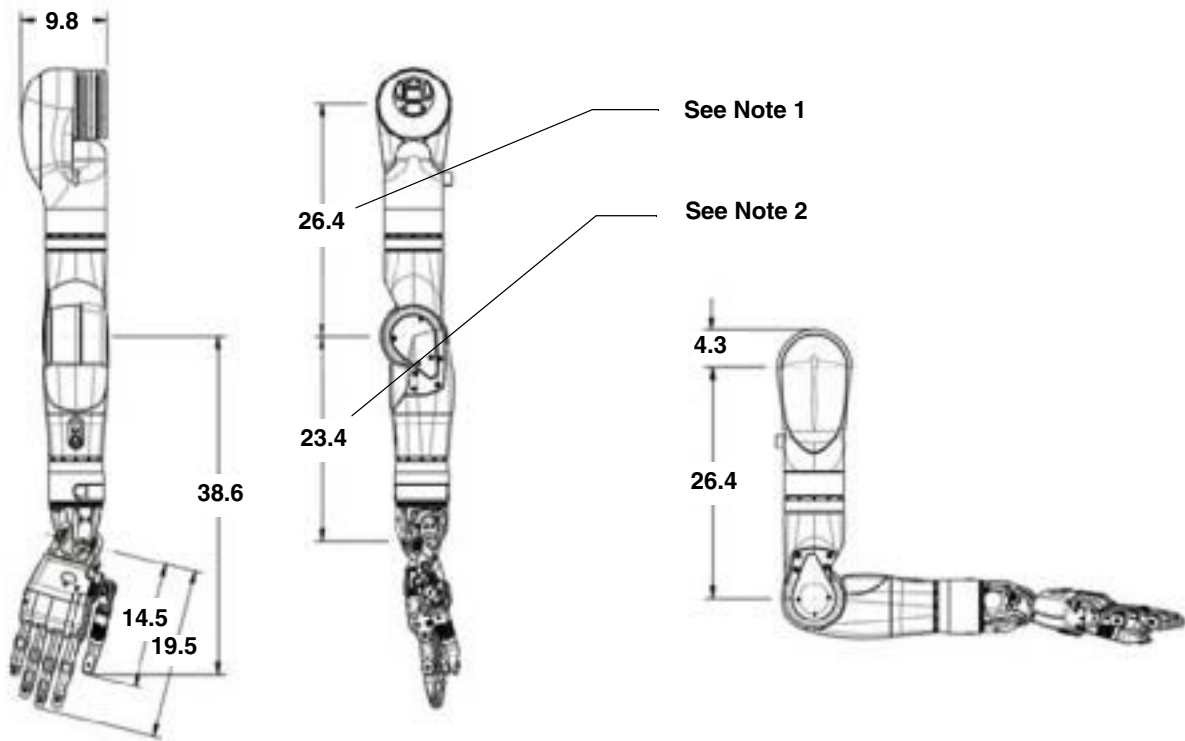

- **NOTE 1:** Upper arm length configurations in 1 cm increments from 26.4 to 31.4 cm. See *Arm Types*.
- **NOTE 2:** Forearm length configurations in 1 cm increments from 23.4 cm to 27.4 cm. See *Arm Types*

Figure 49. Dimensions of Humeral Configuration (In Centimeters)

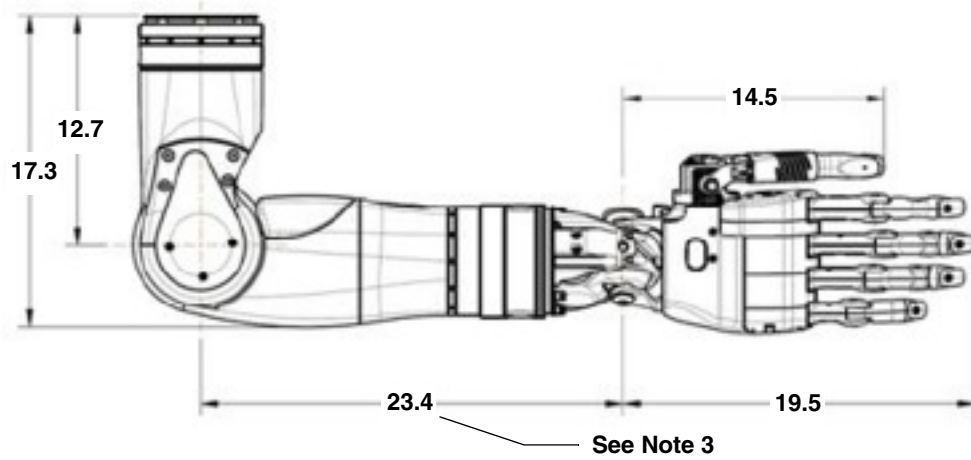

- **NOTE 3:** Forearm length configurations in 1 cm increments from 23.4 cm to 27.4 cm. See *Arm Types*.

Figure 50. Dimensions of Radial Configuration (In Centimeters)

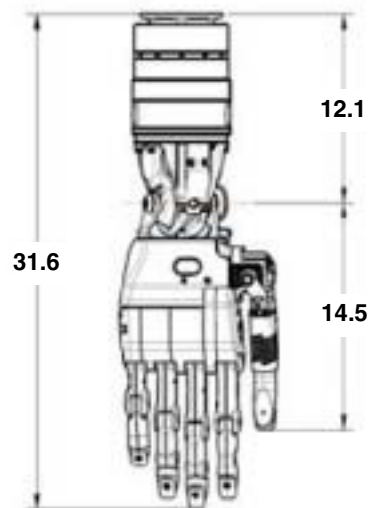

Battery Specifications

Table 28. Battery Charge and Operation Times

Arm System Configuration	Battery Type	One (1) Hour Charge Operation Time ¹	Full Charge ² Operation Time ¹
SC/HC	Internal Battery	One (1) Hour	Two (2) Hours
SC/HC	External Battery	Two (2) Hours	Five (5) Hours
RC	External Battery	Four (4) Hours	Ten (10) Hours
IMU	Not Applicable	Not Applicable	One (1) Day

NOTES:

- Actual use time may vary from stated figures based on use patterns, battery age, and arm configuration. Contact Technical Support for additional information. See [Contacting Technical Support](#).
- See [Chapter 6, "Charging the Batteries"](#) for charging time.

Table 29. Power Specifications - Internal Battery

Parameter	Range/Explanation
Battery Type	Lithium-Ion
Capacity	30 Watt-Hours
Charging time (approximate)	80% capacity in less than 2.0 hours
Storage Life	Three (3) months without recharging
Storage Temperature	Short Term (24 Hours Maximum): -25°C to 70°C (-13°F to 158°F) Long Term: -10°C to 50°C (14°F to 122°F)

Table 30. Power Specifications - External Battery

Parameter	Range/Explanation
Battery Type	Lithium-Ion
Capacity	74 Watt-Hours
Charging time (approximate)	80% capacity in less than 2.0 hours
Storage Life	Three (3) months without recharging

Table 30. Power Specifications - External Battery (Continued)

Parameter	Range/Explanation
Storage Temperature	Short Term (24 Hours Maximum): -25 °C to 70 °C (-13 °F to 158 °F) Long Term: -10 °C to 50 °C (14 °F to 122 °F)

Table 31. Power Specifications - IMU Battery

Parameter	Range/Explanation
Battery Type	Lithium-Polymer
Capacity	190 mAh
Charging time (approximation)	80% capacity in less than two (2.0) hours
Storage Life	Three (3) months without recharging
Storage Temperature	Short Term (24 Hours Maximum): -25 °C to 70 °C (-13 °F to 158 °F) Long Term: -10 °C to 50 °C (14 °F to 122 °F)

AC Adapter Specifications

Table 32. AC Adapter Specifications

Parameter	Range/Explanation
Input Voltage	100 VAC - 240 VAC
Input Frequency	50/60 Hz
Input Current	1.5 Amps
Operating Temperature	0 °C to +70 °C (32 °F to 158 °F)
Operating Humidity	10% to 95% RH, non-condensing
Storage Temperature	-40 °C to +80 °C (-40 °F to 176 °F)

Charging Pad Specifications

Table 33. Charging Pad Specifications

Parameter	Range/Explanation
Input Voltage	100 VAC - 240 VAC
Input Frequency	50/60 Hz
Current Rating	1 Amp Maximum
Transmit Frequency Range	100 kHz - 205 kHz
Transmit Power	<5 W
Protocol	Qi version 1.1, Wireless Power Consortium
Effective Range	10 mm or less
Wireless Security	Qi version 1.1
Quality of Service Provisions	<p>Any debris or clutter between the bottom of the IMU and the Charging Pad may prevent IMU charging. Any increase in the distance between the IMU and Charging Pad will increase communication interference. This interference, however, will not cause any incorrect data to be sent and will not cause any harm to the LUKE arm system.</p> <p>Loss or corruption of data between the IMU and Charging Pad for more than 2 seconds can result in the interruption of charging.</p> <p>In these cases, communication problems can usually be resolved by ensuring the top of the Charging Pad is clean and clear of clutter, the IMU is clean and its label is free of wrinkles, and that IMUs are placed label side down and placed as close as possible to the center of the charging pad targets.</p>

Arm Radio Specifications

Table 34. Arm Radio Specifications

Parameter	Range/Explanation
Transmit and Receive Frequency Range	2.4 - 2.5 GHz
Effective Radiated Power	<10 mW
Modulation	Direct Sequence Spread Spectrum per IEEE 802.15.4-2006
Protocol	Proprietary Frequency Hopping Communication Protocol
FCC Compliance	<p>This device complies with part 15 of the FCC Rules. Operation is subject to the following two conditions: (1) This device may not cause harmful interference, and (2) this device must accept any interference received, including interference that may cause undesired operation.</p> <p>Pursuant to FCC 15.21 of the FCC rules, changes not expressly approved by Mobius Bionics might cause harmful interference and void the FCC authorization to operate this product.</p> <p>This product complies with FCC OET Bulletin 65 radiation exposure limits set forth for an uncontrolled environment.</p>
Effective Range (Arm/IMU)	3 m or less
Effective Range (Arm/Dongle)	1 m or less
Wireless Security	Proprietary Frequency Hopping Communication Protocol

Table 34. Arm Radio Specifications (Continued)

Parameter	Range/Explanation
Quality of Service Provisions	<p>Interruption or corruption of communication between the Arm and IMUs can lead to interruptions in arm motion. Interruption of communication for more than 2 seconds may lead to the system reverting to Standby mode. Interruption of communication for more than 8 seconds results in the system declaring a fault.</p> <p>Common consumer electronic devices that transmit in the same frequency band used by the LUKE arm system may prevent the Arm and IMUs from communicating. Microwave ovens, Bluetooth® devices, Wi-Fi® networks and 2.4 GHz cordless phones, when transmitting or receiving, can cause interruption of communication between the Arm and IMUs. During testing, the LUKE arm system experienced occasional communication interruptions in the presence of Bluetooth mice. It is likely that other devices operating in similar frequency ranges can have a similar effect. This interference, however, will not cause any incorrect data to be sent and will not cause any harm to the LUKE arm system.</p> <p>Some metal detectors and anti-theft detection systems at store exits transmit in the same frequency band used by the LUKE arm system. These devices can cause interruption of communication between the Arm and IMUs. Again, this interference will not cause any incorrect data to be sent and will not cause any harm to the LUKE arm system.</p> <p>In each of these cases, communication problems can usually be resolved by turning off or moving away from other RF transmitting devices.</p>

Guidance and Manufacturer's Declaration

This Appendix details information on the electromagnetic environment and recommended spacing between portable and mobile RF communications equipment (transmitters) and the LUKE arm system.

Electromagnetic Environment

The LUKE arm system is intended for use in the electromagnetic environment specified in [Table 35](#) and [Table 36](#). The user of the LUKE arm system should assure that it is used in such an environment.

Electromagnetic Emissions

Table 35. Guidance and Manufacturer's Declaration - Electromagnetic Emissions

Emissions Test	Compliance	Electromagnetic Environment - Guidance
RF emissions CISPR 11	Group 1	The LUKE arm system uses RF energy only for its internal function. Therefore, its RF emissions are very low and are not likely to cause any interference in nearby electronic equipment.
RF emissions CISPR 11	Class B	The LUKE arm system is suitable for use in all establishments, including domestic establishments and those directly connected to the public low voltage power supply network that supplies buildings used for domestic purposes.

Electromagnetic Immunity

Table 36. Guidance and Manufacturer's Declaration - Electromagnetic Immunity

Immunity Test	IEC 60601 Test Level	Compliance Level	Electromagnetic Environment - Guidance
Electrostatic discharge (ESD) IEC 61000-4-2	+/- 6 kV contact +/- 8 kV air	+/- 6 kV contact +/- 8 kV air	Floors should be wood, concrete or ceramic tile. If floors are covered with synthetic material, the relative humidity should be at least 30%.
Electrical fast transient/burst IEC 61000-4-4	+/- 2 kV for power supply lines +/- 1 kV for input/output lines	+/- 2 kV for power supply lines +/- 1 kV for input/output lines	Mains power quality should be that of a typical commercial or hospital environment.
Surge IEC 61000-4-5	+/- 1 kV line(s) to line(s) +/- 2 kV line(s) to earth	+/- 1 kV line(s) to line(s) +/- 2 kV line(s) to earth	Mains power quality should be that of a typical commercial or hospital environment.
Voltage dips, short interruptions and voltage variations on power supply input lines IEC 61000-4-11	<5% U_T (>95% dip in U_T) for 0,5 cycle 40% U_T (60% dip in U_T) for 5 cycles 70% U_T (30% dip in U_T) for 25 cycles <5% U_T (>95% dip in U_T) for 5 s	<5% U_T (>95% dip in U_T) for 0,5 cycle 40% U_T (60% dip in U_T) for 5 cycles 70% U_T (30% dip in U_T) for 25 cycles <5% U_T (>95% dip in U_T) for 5 s	Mains power quality should be that of a typical commercial or hospital environment. If the user of the LUKE arm system requires continued operation during power mains interruptions, it is recommended that the LUKE arm system be powered from an uninterruptible power supply or a battery.
Power frequency (50/60 Hz) magnetic field IEC 61000-4-8	3 A/m	3 A/m	Power frequency magnetic fields should be at levels characteristic of a typical location in a typical commercial or hospital environment.
NOTE: U_T is the a.c. mains voltage prior to application of the test level.			

Table 36. Guidance and Manufacturer’s Declaration - Electromagnetic Immunity

Immunity Test	IEC 60601 Test Level	Compliance Level	Electromagnetic Environment - Guidance
Conducted RF IEC 61000-4-6	3 Vrms 150 kHz to 80 MHz	3 Vrms 150 kHz to 80 MHz	Portable and mobile RF communications equipment should be used no closer to any part of the LUKE arm system, including cables, than the recommended separation distance calculated from the equation applicable to the frequency of the transmitter. Recommended Separation Distance: $d = 1.2\sqrt{P}$
Radiated RF IEC 61000-4-3 (continued on next page)	3 V/m 80 MHz to 2.5 GHz	10 V/m 26 MHz to 80 MHz	$d = 0.35\sqrt{P}$
		3 V/m 80 MHz to 460 MHz	$d = 1.2\sqrt{P}$
		10 V/m 460 MHz to 470 MHz	$d = 0.35\sqrt{P}$
		3 V/m 470 MHz to 690 MHz	$d = 1.2\sqrt{P}$
		20 V/m 690 MHz to 800MHz	$d = 0.18\sqrt{P}$
		20 V/m 800MHz to 965 MHz (continued on next page)	$d = 0.35\sqrt{P}$ where P is the maximum output power rating of the transmitter in watts (W) according to the transmitter manufacturer and d is the recommended separation distance in meters (m).

Table 36. Guidance and Manufacturer's Declaration - Electromagnetic Immunity

Immunity Test	IEC 60601 Test Level	Compliance Level	Electromagnetic Environment - Guidance
Radiated RF IEC 61000-4-3 (continued)	3 V/m 80 MHz to 2.5 GHz	3 V/m 965MHz to 1.39 GHz 20 V/m 1.39 GHz to 6.0 GHz	$d = 2.3\sqrt{P}$ $d = 0.35\sqrt{P}$ Field strengths from fixed RF transmitters, as determined by an electromagnetic site survey ^a should be less than the compliance level in each frequency range. ^b Interference may occur in the vicinity of equipment marked with the following symbol: 
Magnetic Fields generated by: <ul style="list-style-type: none"> • Metal Detectors • EAS Systems and Tag Deactivators (No Standard Applied)	N/A	0.1 kHz - 3.5 kHz 300 A/m 10 kHz - 60 kHz 50 A/m 50 kHz - 150 kHz 30 A/m	No special precautions required.
<p>NOTE 1: At 80 MHz, 460 MHz, 470 MHz, 690 MHz, 800 MHz, 965 MHz, and 1.39 GHz, the higher frequency range applies.</p> <p>NOTE 2: These guidelines may not apply in all situations. Electromagnetic propagation is affected by absorption and reflection from structures, objects and people.</p>			
<p>^a Field strengths from fixed transmitters, such as base stations for radio (cellular/cordless) telephones and land mobile radios, amateur radio, AM and FM radio broadcast and TV broadcast cannot be predicted theoretically with accuracy. To assess the electromagnetic environment due to fixed RF transmitters, an electromagnetic site survey should be considered. If the measured field strength in the location in which the LUKE arm system is used exceeds the applicable RF compliance level above, the LUKE arm system should be observed to verify normal operation. If abnormal performance is observed, additional measures may be necessary, such as re-orienting or relocating the LUKE arm system.</p> <p>^b Over the frequency range 150 kHz to 80 MHz, field strengths should be less than 3 V/m.</p>			

Recommended Separation Distances

The LUKE arm system is intended for use in an electromagnetic environment in which radiated RF disturbances are controlled. The user of the LUKE arm system can help prevent electromagnetic interference by maintaining a minimum distance between portable and mobile RF communications equipment (transmitters) and the LUKE arm system as recommended below, according to the maximum output power of the communications equipment.

Table 37 and Table 38 defines the recommended separation distances between portable and mobile RF communications equipment and the LUKE arm system.

Table 37. Recommended Separation Distances (Part I)

Rated Maximum Output Power of Transmitter W	Separation Distance According to Frequency of Transmitter <i>m</i>				
	150 kHz - 80 MHz $d = 1.2\sqrt{P}$	26 MHz - 80 MHz $d = 0.35\sqrt{P}$	80 MHz - 460 MHz $d = 1.2\sqrt{P}$	460 MHz - 470 MHz $d = 0.35\sqrt{P}$	470 MHz - 690 MHz $d = 1.2\sqrt{P}$
0.01	0.12	0.035	0.12	0.035	0.12
0.1	0.37	0.11	0.37	0.11	0.37
1	1.2	0.35	1.2	0.35	1.2
10	3.7	1.1	3.7	1.1	3.7
100	12	3.5	12	3.5	12

For transmitters rated at a maximum output power not listed above, the recommended separation distance d in meters (m) can be estimated using the equation applicable to the frequency of the transmitter, where P is the maximum output power rating of the transmitter in watts (W) according to the transmitter manufacturer.

NOTE 1: At 80 MHz, 460 MHz, 470 MHz, 690 MHz, 800 MHz, 965 MHz, and 1.39 GHz, the separation distance for the higher frequency range applies.

NOTE 2: These guidelines may not apply in all situations. Electromagnetic propagation is affected by absorption and reflection from structures, objects and people.

Table 38. Recommended Separation Distances (Part II)

Rated Maximum Output Power of Transmitter <i>W</i>	Separation Distance According to Frequency of Transmitter <i>m</i>			
	690 MHz - 800 MHz $d = 0.18\sqrt{P}$	800 MHz - 965 MHz $d = 0.35\sqrt{P}$	965 MHz - 1.390 GHz $d = 2.3\sqrt{P}$	1.390 GHz - 6.0 GHz $d = 0.35\sqrt{P}$
0.01	0.018	0.035	0.23	0.035
0.1	0.055	0.11	0.74	0.11
1	0.18	0.35	2.3	0.35
10	0.55	1.1	7.4	1.1
100	1.8	3.5	23	3.5

For transmitters rated at a maximum output power not listed above, the recommended separation distance *d* in meters (m) can be estimated using the equation applicable to the frequency of the transmitter, where *P* is the maximum output power rating of the transmitter in watts (W) according to the transmitter manufacturer.

NOTE 1: At 80 MHz, 460 MHz, 470 MHz, 690 MHz, 800 MHz, 965 MHz, and 1.39 GHz, the separation distance for the higher frequency range applies.

NOTE 2: These guidelines may not apply in all situations. Electromagnetic propagation is affected by absorption and reflection from structures, objects and people.

Essential Performance

The following items are the Essential Performance of the LUKE arm system.

The LUKE arm system:

- is able to safely power on and off.
- enters Standby mode at power on.
- hand open button operates normally.
- gross motor movements are slowed within the slowdown region.
- low battery alert operates normally.



LUKE Arm

Prosthetist Reference Guide



*Part Number: LU-09015-001
Revision: 1.5
Date: December 05, 2016*

*Manufactured by:
Mobius Bionics
470 Commercial Street
Manchester, NH 03101
www.mobiusbionics.com*

Copyright

Copyright © 2016. Mobius Bionics LLC. All rights reserved.

Mobius Bionics LLC. (Mobius) proprietary rights are included herein. This document contains Mobius confidential information and may not be copied, transferred, or disclosed except as authorized by Mobius.

Trademarks

Bluetooth® is a registered trademark of Bluetooth SIG.

Wi-Fi® is a registered trademark of Wi-Fi Alliance.

Windows® is a registered trademark of Microsoft Corporation.

Contents

About This Guide

Intended Audience	17
How to Use This Guide	18
Conventions	20
Terminology	22
Acronyms	23
Contacting Technical Support	24

Chapter 1

Overview

The Client	27
Indications For Use.....	28
Contraindications For Use.....	28
LUKE Arm System	29
Arm Configurations	30
Shoulder Configuration (SC)	30
Humeral Configuration (HC).....	30
Radial Configuration (RC).....	30
Batteries	32
Internal Battery	32
External Battery	33
External Battery Holster.....	34
Battery Chargers and Charging Dock.....	35
AC Adapter	35
Charging Pad.....	36
Charging Dock.....	36
ACI (Arm Control Interface) Modules	37
Input/Output Control Devices	38
The Fitting Arm	38

Chapter 2

Safety

Safety Guidelines - Arm.....	39
Electromagnetic Interference (EMI) Safety.....	45
Safety Guidelines - Battery.....	45

Chapter 3

User Inputs/Outputs and the Control Scheme

Arm Controls — Switching vs. Motion.....	47
User Inputs.....	48
IMUs (Inertial Measurement Units)	48
Description	48
Places Used	49
Arm Controls	49
How They Are Used	49
Restrictions	49
EMG - Electromyography (Surface EMG Electrodes)	50
Description	50

Places Used	50
Arm Controls	50
How They Are Used	50
Restrictions	50
Pressure Switches.....	51
Description	51
Places Used	51
Arm Controls	51
How They Are Used	51
Restrictions	51
Rocker Switches.....	52
Description	52
Places Used	52
Arm Controls	52
How They Are Used	52
Restrictions	52
Pressure Transducers.....	53
Description	53
Places Used	53
Arm Controls	53
How They Are Used	53
Restrictions	53
Linear Transducers.....	54
Description	54
Places Used	54
Control Types	54
How They Are Used	54
Restrictions	54
User Output - Tactor.....	55

Chapter 4 Battery Types and User Controls

System Battery Types.....	57
User Controls and Wrist Display.....	59
Power ON/OFF Button Location.....	59
Turning the Arm ON and OFF	61
Wrist Display	61
Low Battery Icon and Low Battery Alert	62
System Fault Icon	62
Arm Mode LED and Grip Select LEDs	63
Display Button	64
Displaying the Battery Charge Level.....	64
Changing the Display Brightness.....	65
Swapping IMUs.....	65
IMU LED Status.....	66
Hand Open Button.....	68
Orienting The Arm While Pressing The Hand Open Button	69
Arm System and Wrist Display Button Durability.....	70

Chapter 5	Arm System Installation and Setup	
	Installation and Setup Overview.....	73
Chapter 6	Fabricating the Socket System and Mounting the Arm	
	The Fitting Arm.....	76
	Adjusting the Fitting Arm.....	77
	Modifying the Fitting Arm for a Specific Configuration.....	78
	Socket System and Arm Mounting Overview.....	79
	Mounting the Arm.....	80
	Mounting Point of View.....	80
	Mounting the RC (Radial Configuration) Arm.....	81
	Installing and Connecting the RC Cable.....	84
	Tightening the Cable Connections to the Radial Interface Box.....	88
	Mounting the RC Arm.....	89
	Mounting the HC (Humeral Configuration) Arm.....	91
	Mounting the HC Cable.....	94
	Mounting the SC (Shoulder Configuration) Arm.....	96
	SC Bend Bracket Mounting.....	96
	Attaching the Fitting Arm.....	101
	Laminating the SC Socket Adapter.....	102
	Mounting the SC Arm.....	103
	Sealing of the Shoulder Bellows.....	103
	Attaching the SC Arm.....	104
	Configuring the Shoulder’s Neutral Position.....	106
	Mounting the SC Cable.....	106
Chapter 7	Installing/Connecting ACI Modules and User Inputs	
	ACI (Arm Control Interface) Module Overview.....	108
	Locating ACI Modules.....	108
	Mounting the ACI Module.....	108
	Screwing the Module to the Socket.....	108
	Laminating the ACI Module to the Socket.....	108
	Attaching the Module Using Hook and Loop Fasteners.....	109
	Attaching the Module Using Mounting Loops.....	109
	Connecting the ACI Module, User Inputs and Tactor.....	109
	Connecting the Power and Communications Line.....	110
	Connecting User Inputs.....	111
	Connecting User Inputs - Surface EMG Electrodes.....	112
	Connecting the Tactor.....	113
	Tightening the Cable Connections to the ACI.....	114
	Securing the ACI Cables.....	115
	Assigning an ACI Module ID.....	115
Chapter 8	Installing IMUs	
	Installing the IMU in the Shoe Clip.....	118
	Installing the IMU/Shoe Clip on the Client’s Shoe.....	120
	Waking a Sleeping IMU.....	121

Chapter 9	Installing, Connecting, and Charging the System Batteries	
	Battery Charging Safety	124
	Connecting the External Battery Holster to the Arm	125
	Disconnecting the External Battery Extension Cable.....	126
	Testing and Charging the Batteries.....	126
	Testing the Internal Battery Charge Level.....	127
	Charging the Internal Battery	127
	Testing the External Battery Charge Level.....	129
	Charging the External Battery	130
	Removing the External Battery from the Holster	133
	Installing the External Battery in the Holster.....	133
	Testing the IMU Battery Charge Level	134
	Charging the IMU Battery.....	134
Chapter 10	Key Concepts and Operating Modes	
	Motion vs. Switching.....	139
	Operating Modes	140
	IMU - Walk Detect.....	141
	IMU - Angle Limit Detect.....	141
	Mode Change Interlock.....	142
	Zeroing the IMUs	142
	Operating Modes and Motions	143
	Standby Mode (No Motion)	143
	Hand Mode Motions.....	143
	Opening or Closing the Hand.....	144
	Compound Wrist Motions	144
	Rotating the Wrist	146
	Selecting a Grip	146
	Power Grip (Grip Select LED 1).....	147
	Tool Grip (Grip Select LED 2)	148
	Fine Pinch Closed Grip (Grip Select LED 3).....	149
	Fine Pinch Open Grip (Grip Select LED 4).....	149
	Lateral Pinch Grip (Grip Select LED 5).....	150
	Chuck Grip (Grip Select LED 6).....	152
	Grip Detents	152
	Arm Mode Motions.....	153
	SC Arm Motions.....	153
	Moving the Hand Up or Down (SC Arm).....	154
	Moving the Hand Left or Right (SC Arm).....	154
	Moving the Hand Forward or Backward (SC Arm).....	155
	Voluntary Elbow Positioning - Medial/Lateral (SC Arm)	155
	HC Arm Motions	156
	Elbow Flexion - Extension (HC Arm).....	156
	Humeral Internal - External Rotation (HC Arm).....	157
Chapter 11	Configuring the Arm Using the Prosthetist Interface	
	Installing the Prosthetist Interface	159
	Installing the Prosthetist Interface Software.....	159
	Installing the FTDI (Windows) Drivers.....	161

If Connected to the Internet.....	161
If NOT Connected to the Internet	162
Opening the Prosthetist Interface	166
Navigating The Prosthetist Interface.....	167
Arm PI Menus.....	167
Settings Menu	167
Configuration Menu.....	169
Configuration Steps and Dynamic Configuration Screen	173
Update Arm	173
Save Configuration to File.....	174
Virtual Reality Environment.....	175
View Input Signals.....	175
Status.....	176
Arm Illustration	176
Tool Tips.....	177
Using the Prosthetist Interface.....	177
STEP 1: Discover and Select Master Arm Controller (MAC).....	178
Discovering and Selecting the MAC	179
STEP 2: Client Configuration.....	179
Initial Configuration	179
Existing Configurations	180
Create a New Configuration.....	181
Select the Arm Assembly	182
Zero the Shoulder (if fitting an SC arm)	182
Clear the Arm Configuration.....	183
Read the Current Configuration from the Arm.....	184
Load a Configuration from File.....	185
STEP 3: Configure ACI Modules	185
Wired ACIs	187
Wireless IMUs	187
Configuring a New ACI for the First Time.....	187
Understanding Thresholds and Gains.....	190
Thresholds.....	190
Gains	190
Setting Joint or Motion Speed Limits.....	190
Input Gains.....	191
Input Thresholds	191
Output Gains	191
Step 4: Configure Inputs	192
Step 5: Configure Arm Actions	196
Selecting and Activating an Action.....	199
Configuration Screens - Arm Actions	199
Tool Tips and Keyboard Shortcuts.....	202
What's Next	202

Chapter 12 Virtual Reality Environment and Viewing Input Signals

Using the Virtual Reality Environment.....	203
Controlling the VRE Image	207
Viewing Input Signals.....	208
Troubleshooting Connection Problems.....	208
What's Next	208

Chapter 13	Using the Arm	
	Safe Operation of the System	211
	What To Do If the Arm Is Not In Proper Working Order.....	211
	Arm Is Not in Proper Working Order	212
	Unsure When Using the Arm.....	212
	Releasing the Hand/Arm Using the Hand Open Button.....	212
	Doffing the Arm	213
	Safe Motions	213
	Taking It Slow.....	214
	Practicing Safe Operation of the System	214
	Carrying Heavy Objects	215
	Initializing the Arm.....	215
	Re-Initializing the Arm.....	216
	Improper Shutdowns.....	216
	LUKE Arm User Guide.....	217
	What's Next	217
Chapter 14	Maintaining and Troubleshooting the Arm	
	Maintaining the Arm	219
	Removing and Replacing the Fingernails, Finger Covers and Hand Cover .	220
	Removing and Replacing Fingernails	221
	Removing and Replacing Finger Covers	222
	Removing and Replacing Hand Cover	222
	Cleaning the Arm.....	224
	Troubleshooting the Arm.....	225
	LUKE Arm System Alerts	225
	Troubleshooting	226
Appendix A	Prosthetist Checklist	
Appendix B	Technical Specifications	
	Arm Specifications.....	241
	Battery Specifications.....	245
	AC Adapter Specifications.....	247
	Charging Pad Specifications.....	248
	Arm Radio Specifications.....	249
Appendix C	Manufacturers and Part Numbers	
	LUKE Arms	251
	Hand and Finger Covers.....	252
	General Accessories	253
	User Inputs.....	254
	Optional Accessories.....	254
	External Cables.....	255
	Socket Fabrication Components.....	256

Appendix D Guidance and Manufacturer’s Declaration

- Electromagnetic Environment..... 257
 - Electromagnetic Emissions 257
 - Electromagnetic Immunity..... 258
- Recommended Separation Distances 261
- Essential Performance 262

List of Figures

Figure 1.	Arm Configurations.....	31
Figure 2.	Internal Battery/Power Interface Location	32
Figure 3.	External Battery	33
Figure 4.	External Battery Holster.....	34
Figure 5.	AC Adapter	35
Figure 6.	Wireless Charging Pad for IMU Battery	36
Figure 7.	Charging Dock	36
Figure 8.	ACI Module	37
Figure 9.	Pinch Point Areas	44
Figure 10.	Inertial Measurement Unit.....	48
Figure 11.	Example Surface EMG Electrode	50
Figure 12.	Pressure Switches	51
Figure 13.	Rocker Switches	52
Figure 14.	Pressure Transducer	53
Figure 15.	Linear Transducer	54
Figure 16.	Tactor.....	55
Figure 17.	Power Button and LED - SC, HC, and RC Arms With External Battery Only	59
Figure 18.	Power Button and LED - SC and HC Arms with Internal Battery	60
Figure 19.	Wrist Display	61
Figure 20.	Hand Open Button	68
Figure 21.	Arm and Wrist Display Button Durability	70
Figure 22.	Fitting Arm.....	76
Figure 23.	Adjusting the Fitting Arm for Range of Motion	77
Figure 24.	Modifying the Fitting Arm for a Specific Configuration	78
Figure 25.	Point of View - Mounting the Arm.....	80
Figure 26.	RC Socket Adapter	81
Figure 27.	R-TOP and L-TOP Mounting Reference Points and Cable Exit Port	82
Figure 28.	Left Hand RC Arm in Neutral Supination/Pronation Position	82
Figure 29.	Orientation of Socket Adapter for Right Hand Arm or Left Hand Arm Mounting	83
Figure 30.	RC Cable	84
Figure 31.	Inserting the RC Cable Connector Through the Cable Exit Port .	85
Figure 32.	Positioning the RC Cable Within the Socket Adapter	85
Figure 33.	Aligning the Raised Lip of the Over-Mold.....	86
Figure 34.	Inserting the Over-Mold Into Place.....	86
Figure 35.	Properly Seated Over-Mold	87
Figure 36.	Installing and Connecting the Cables to Radial Interface Box.....	88
Figure 37.	Tightening the Cable Connections to the Radial Interface Box ...	88
Figure 38.	Identifying the Long Reference Mounting Pin - RC Arm	89
Figure 39.	RC Arm Attached to Socket Adapter	90
Figure 40.	HC Socket Adapter.....	91
Figure 41.	FRONT Mounting Reference Point - HC Socket Adapter.....	92
Figure 42.	Identifying the Mounting Pins - HC Arm	93
Figure 43.	HC Arm Attached to Socket Adapter.....	94

Figure 44.	Mounting the HC Cable.....	95
Figure 45.	SC Bend Bracket	96
Figure 46.	Attaching the Socket Adapter to the Bend Bracket.....	97
Figure 47.	Attaching the Form Shoulder to the Bend Bracket	98
Figure 48.	Aligning the Bend Bracket Perpendicular to Ground.....	98
Figure 49.	Aligning the Shoulder Flex Axis of Rotation.....	99
Figure 50.	Shoulder Flexion Alignment Correction Indexing	99
Figure 51.	Removing Excess Bend Bracket Legs.....	100
Figure 52.	Example Fitting Arm - Hand to Mouth Alignment	101
Figure 53.	Finished Laminated SC Socket Adapter	102
Figure 54.	Sealing of the Shoulder Bellows.....	103
Figure 55.	SC Arm Notch Orientation	104
Figure 56.	Attaching the SC Arm.....	105
Figure 57.	SC Arm Attached to Socket.....	105
Figure 58.	Mounting the SC Cable	106
Figure 59.	ACI Module - Power and Communications Line Connectors	110
Figure 60.	ACI Module - User Input Connectors	111
Figure 61.	Example - Connecting the Pressure Transducer to the ACI Module	112
Figure 62.	EMG - Proper Alignment of Ribbon Cable To Electrode	112
Figure 63.	Connecting the Tactor to the ACI Module	113
Figure 64.	Tightening the Cable Connections to the ACI.....	114
Figure 65.	Attaching the IMU to the Shoe Clip.....	119
Figure 66.	Attaching the IMU/Shoe Clip to the Client's Shoe	120
Figure 67.	Connecting the External Battery to the Arm Cable.....	125
Figure 68.	Disconnecting the External Battery Extension Cable	126
Figure 69.	Internal Battery Charging Port and Status Icon	128
Figure 70.	Testing the External Battery Charge Level.....	129
Figure 71.	External Battery Charging Dock and Status LEDs	131
Figure 72.	Removing and Replacing the External Battery	133
Figure 73.	Charging the IMU Battery.....	135
Figure 74.	Hand Open and Hand Closed	144
Figure 75.	Compound Wrist Motions	145
Figure 76.	Rotating the Wrist.....	146
Figure 77.	Power Grip.....	147
Figure 78.	Tool Grip	148
Figure 79.	Fine Pinch Closed Grip.....	149
Figure 80.	Fine Pinch Open Grip	149
Figure 81.	Lateral Pinch Grip.....	151
Figure 82.	Chuck Grip.....	152
Figure 83.	Moving the Hand Up or Down	154
Figure 84.	Moving the Hand Left or Right.....	154
Figure 85.	Moving the Hand Forward or Backward	155
Figure 86.	Voluntary Elbow Positioning (VEP)	156
Figure 87.	Elbow Flexion - Extension	156
Figure 88.	Humeral Internal - External Rotation.....	157
Figure 89.	Welcome to the ARM PI Setup Wizard.....	160
Figure 90.	Select Installation Folder Screen	160
Figure 91.	Installing Device Driver Software	161
Figure 92.	Your Device Is Ready To Use.....	161

Figure 93.	Device Driver Installation Status.....	162
Figure 94.	Device Driver Software Not Successfully Installed	162
Figure 95.	Details - Device Driver Software Not Successfully Installed	163
Figure 96.	Update Driver Software	163
Figure 97.	Browse for Folder	164
Figure 98.	Update Driver Software - Unknown Device	164
Figure 99.	Successful Driver Update	165
Figure 100.	Prosthetist Interface Main/Welcome Screen	166
Figure 101.	Arm PI Menus	167
Figure 102.	Power Save Mode	168
Figure 103.	Real Time Clock	168
Figure 104.	Print Summary Example	169
Figure 105.	Print IMU Actions	170
Figure 106.	Event Logs Example.....	171
Figure 107.	Usage Stats Example.....	172
Figure 108.	Configuration Steps and Configuration Screen	173
Figure 109.	Save Configuration to File.....	174
Figure 110.	Power Cycle the Arm	174
Figure 111.	Status	176
Figure 112.	Arm Illustration	176
Figure 113.	Example - Tool Tip	177
Figure 114.	Step 1: Discover and Select MAC.....	178
Figure 115.	Step 2 - Client Configuration	180
Figure 116.	Configuring the Shoulder's Neutral Position.....	183
Figure 117.	Change to Current Configuration	183
Figure 118.	Save Config to File.....	184
Figure 119.	Saved Client Configuration Files.....	185
Figure 120.	Write Configuration to Arm	185
Figure 121.	Step 3: Configure ACI Modules.....	186
Figure 122.	Configure Wired ACI Module ID.....	188
Figure 123.	Successful Assignment of Wired ACI Device	188
Figure 124.	Power Cycle the Arm	189
Figure 125.	Step 4: Configure Inputs.....	192
Figure 126.	Activate/Zero IMUs.....	194
Figure 127.	Step 5: Configure Arm Actions (SC Arm Shown).....	196
Figure 128.	Example Configure Action Screen - Toggle Grip Select	200
Figure 129.	Example - Tool Tip	202
Figure 130.	Virtual Reality Environment and View Input Signals Buttons	204
Figure 131.	Virtual Reality Environment.....	205
Figure 132.	View Input Signals	208
Figure 133.	Hand Open Button	213
Figure 134.	Lateral Pinch Grip - Fully Open.....	220
Figure 135.	Removing and Replacing the Fingernails	221
Figure 136.	Lace - Securing Hand Cover	223
Figure 137.	Removing and Replacing the Finger and Hand Covers	224
Figure 138.	Dimensions of Shoulder Configuration (In Centimeters)	244
Figure 139.	Dimensions of Humeral Configuration (In Centimeters).....	244
Figure 140.	Dimensions of Radial Configuration (In Centimeters)	245

List of Tables

Table 1.	Arm System Icons	20
Table 2.	Text Conventions.....	21
Table 3.	Terminology	22
Table 4.	Acronyms.....	23
Table 5.	Arm Controls.....	47
Table 6.	Arm Configurations and Batteries.....	58
Table 7.	Arm Mode and Grip Select LEDs.....	63
Table 8.	Wrist Display Battery Charge Levels	64
Table 9.	IMU LED Status.....	66
Table 10.	LUKE Arm System Installation and Setup Overview	74
Table 11.	ACI Connection Types	109
Table 12.	Internal Battery Charging Port and Status Icon	128
Table 13.	External Battery Charge Level.....	130
Table 14.	External Battery Charging Dock Status LEDs.....	131
Table 15.	IMU Battery Charging Status LEDs.....	135
Table 16.	Control Types - Switching vs. Motion	139
Table 17.	Arm and Operating Modes.....	140
Table 18.	Hand Mode — Motions	143
Table 19.	Grip Select LEDs	146
Table 20.	Arm Mode — Motions.....	153
Table 21.	Step 1: Discover and Select MAC - Fields and Buttons	179
Table 22.	Step 2: Client Configuration - Fields and Buttons.....	180
Table 23.	Arm Control Interface - Fields and Buttons	186
Table 24.	IMU Setup - Fields and Buttons	193
Table 25.	Configurable Arm Actions.....	197
Table 26.	Configure Actions Settings Glossary	200
Table 27.	Virtual Reality Settings.....	205
Table 28.	VRE Image Control Keys	207
Table 29.	Troubleshooting - Try This First.....	226
Table 30.	Troubleshooting - Wrist Display and System Faults	227
Table 31.	Troubleshooting - Arm Function	231
Table 32.	Troubleshooting - Power and Battery Charging	232
Table 33.	Troubleshooting - Arm and PI Computer Communication ..	234
Table 34.	Arm System Specifications.....	241
Table 35.	Operating Environmental Range.....	242
Table 36.	Transport and Storage Environmental Range.....	242
Table 37.	Service Life Specifications.....	243
Table 38.	Mass of Arm Configurations.....	243
Table 39.	Dimensions of Arm Configurations	243
Table 40.	Battery Charge and Operation Times.....	245
Table 41.	Power Specifications - Internal Battery	246
Table 42.	Power Specifications - External Battery	246
Table 43.	Power Specifications - IMU Battery.....	246
Table 44.	AC Adapter Specifications	247
Table 45.	Charging Pad Specifications.....	248
Table 46.	Arm Radio Specifications.....	249
Table 47.	LUKE Arm Manufacturers and Part Numbers	251

Contents

Table 48.	Hand and Finger Cover Manufacturers and Part Numbers.....	252
Table 49.	General Accessories Manufacturers and Part Numbers.....	253
Table 50.	User Inputs Manufacturers and Part Numbers	254
Table 51.	Optional Accessories Manufacturers and Part Numbers	254
Table 52.	External Cable Manufacturers, Part Numbers, and Maximum Length.....	255
Table 53.	Socket Fabrication Components	256
Table 54.	Guidance and Manufacturer's Declaration - Electromagnetic Emissions	257
Table 55.	Guidance and Manufacturer's Declaration - Electromagnetic Immunity.....	258
Table 56.	Recommended Separation Distances (Part I).....	261
Table 57.	Recommended Separation Distances (Part II)	262

About This Guide

This guide provides setup and configuration information for the LUKE arm and system components. This information includes step by step procedures on how to install, set up, and configure the arm as well as the system components. Also included is conceptual and operational information on the arm and system components which you and your client need to understand prior to setting up the arm and configuring the arm.

NOTICE

This guide is shipped with the LUKE arm system.

Intended Audience

This guide is intended for prosthetists who will be setting up and configuring the arm to ensure safe and effective use of the arm. Read this guide carefully and be sure to follow all directions. At the end of this guide, there is a checklist. See [Appendix A, "Prosthetist Checklist"](#). Prior to sending the client home with the LUKE arm system, complete this checklist to ensure the client is able to operate the arm appropriately.

How to Use This Guide

The following table summarizes the information in this guide.









Read	To Learn About...
<i>Section I — Arm System Overview</i>	
Chapter 1, “Overview”	Overview — Provides introductory information about the client needs as they relate to the LUKE arm and system components used to fit, set up, and configure the arm.
Chapter 2, “Safety”	Safety — Provides all safety WARNINGS , CAUTIONS , and notices you and your client must read prior to setting up and configuring the arm and system components.
Chapter 3, “User Inputs/Outputs and the Control Scheme”	Determining the Control Scheme — Provides information on the types of user inputs which you will use to determine the arm’s control scheme.
Chapter 4, “Battery Types and User Controls”	Arm Configurations — Provides information on the battery types used in specific arm configurations as well as information on the display and buttons used to control the arm.
<i>Section II — Mounting and Setting Up the Arm System</i>	
Chapter 5, “Arm System Installation and Setup”	Setting Up the LUKE Arm — Provides high-level steps you need to perform to install and set up the LUKE arm. These high-level steps are cross-referenced to specific chapters where detailed information is provided.
Chapter 6, “Fabricating the Socket System and Mounting the Arm”	Fabricating the Socket and Harness — Provides information about fabricating and building the socket as well as how to attach the arm types to the socket.
Chapter 7, “Installing/Connecting ACI Modules and User Inputs”	Installing and Connecting ACI Modules — Provides information on installing and connecting ACI Modules.
Chapter 8, “Installing IMUs”	Installing and Connecting the User Inputs — Provides information on connecting the user inputs to the ACI Modules.
Chapter 9, “Installing, Connecting, and Charging the System Batteries”	Selecting the Battery — Provides information on selecting the battery that will be used to power the arm.
<i>Section III — Configuring the Arm</i>	
Chapter 10, “Key Concepts and Operating Modes”	Understanding Arm Concepts — Provides conceptual and operational information about the arm.
Chapter 11, “Configuring the Arm Using the Prosthetist Interface”	Configuring the Arm Using Prosthetist Interface — Provides information on using the Prosthetist User Interface software to configure the arm.

Read	To Learn About...
Chapter 12, “Virtual Reality Environment and Viewing Input Signals”	Virtual Reality Environment and Viewing Input Signals — Provides information on checking the arm configuration using the Virtual Reality Environment.
<i>Section IV — Using and Maintaining the Arm</i>	
Chapter 13, “Using the Arm”	Using the Arm — Provides information on how to use the arm in a safe manner. Also provides information on what to do if the arm is not working properly.
Chapter 14, “Maintaining and Troubleshooting the Arm”	Maintaining and Troubleshooting the Arm — Provides information on how to maintain the arm and perform basic troubleshooting steps to diagnose problems with the LUKE arm system.
<i>Section V— Appendices</i>	
Appendix A, “Prosthetist Checklist”	Prosthetist Checklist — Provides a checklist of items to review before allowing the client to use and take home the arm.
Appendix B, “Technical Specifications.”	Technical Specifications — Provides technical specifications for the arm and batteries.
Appendix C, “Manufacturers and Part Numbers”	Manufacturers and Part Numbers — Provides a list of manufacturers and part numbers for specific arm system parts.
Appendix D, “Guidance and Manufacturer’s Declaration”	Guidance and Manufacturers Declaration — Provides information on the electromagnetic environment and recommended spacing between portable and mobile RF communications equipment (transmitters) and the LUKE arm system.

Conventions

Table 1 describes the Arm System icons and Table 2 describes text conventions used throughout this guide.

Table 1. Arm System Icons

Icon	Meaning	Description
	Alert	Alerts you and your client to potential injury hazards. Obey all safety messages that follow this symbol to avoid possible injury.
	Information Note	Notice is used to address practices not related to personal injury.
	CAUTION	Cautions indicate a hazardous situation which, if not avoided, could result in minor or moderate injury.
	WARNING	Warnings indicate a hazardous situation which, if not avoided, could result in death or serious injury.
	Read This Guide	Instructs you to refer to this guide prior to using the LUKE arm system.
	Electrically Isolated Equipment	Indicates Type BF equipment which is electrically isolated and can safely contact a person's skin without the risk of electric shock.
	Radio Transmitter	Indicates that equipment contains a radio transmitter.
	Disposal of Equipment	Indicates that equipment should not be disposed of in the trash.





Icon	Meaning	Description
	Recycle Equipment	Indicates that equipment should be recycled.
	Use Indoors	Identifies electrical equipment designed for indoor use and should be kept dry.
	Meets Class II Safety Requirements	Identifies equipment that meets the safety requirements specified for Class II equipment according to IEC 61140.
	MR Unsafe	Indicates that equipment is not compatible with magnetic resonance (MRI) environment.

Table 2. Text Conventions

Convention	Appearance in Text	Example
Key concepts and emphasized text	Appear in bold type	Inertial Measurement Unit
User input	Appears in bold courier typeface	user input
Screen display (Information that appears on your monitor)	Appears in courier typeface	screen display
Book titles, directories, pathnames, and filenames	Appear in italic typeface	<i>LUKE Arm Prosthetist Reference Guide</i>

Terminology

The terminology used in this guide to describe the arm, socket, and accessories is described in [Table 3](#).

Table 3. Terminology

Term	Description
Arm	Refers to the prosthetic arm only (no socket or accessories).
Prosthesis	Refers to the combination of the socket and the arm.
Arm System	Refers to the socket, arm, and all related accessories.

Acronyms

See [Table 4](#) for a list of acronyms used in this guide.

Table 4. Acronyms

Acronym	Description
ACI	Arm Control Interface — Connects client input devices to the arm.
EMG	Electromyograph — A surface EMG electrode is a sensor placed on the skin that senses the activation signal of a muscle.
EMI	Electromagnetic Interference — Interference to the arm's electronics caused by external electrical sources.
HC	Humeral Configuration— A type of arm configuration.
IMU	Inertial Measurement Unit — A control input that is placed on top of the client's foot or lower appendage.
LED	Light Emitting Diode — A light that displays a status.
MAC	Master Arm Controller — The main processing unit of the LUKE arm.
PI	Prosthetist Interface — The user interface software used to configure a new arm or adjust the client's current configuration.
RC	Radial Configuration — A type of arm configuration.
USB	Universal Serial Bus — A standard way for a computer to talk to other devices.
VEP	Voluntary Elbow Positioning — A type of arm motion of the LUKE arm.
SC	Shoulder Configuration — A type of arm configuration.
VRE	Virtual Reality Environment — Allows the client to practice using the arm with the selected control scheme.

Contacting Technical Support

To contact technical support use the following address, web site URL or telephone:

Mobius Bionics

470 Commercial Street

Manchester, NH 03101

www.mobiusbionics.com

603-239-3834

855-MOBIUS1 (855-662-4871)

Section I — Arm System Overview

This section provides an overview of the LUKE arm and system components. It defines all safety guidelines that you and your client must follow while setting up and configuring the arm. It provides information on user inputs and how you will use these inputs to determine the client's control scheme used to control the arm. It also provides information on the correlation between the arm configurations and system components which you need to understand prior to setting up and configuring the arm.

Chapters in this section include:

- **Chapter 1, "Overview"**
- **Chapter 2, "Safety"**
- **Chapter 3, "User Inputs/Outputs and the Control Scheme"**
- **Chapter 4, "Battery Types and User Controls"**

Overview

This chapter provides an overview defining the client needs as they relate to the LUKE arm and system components in order to fit, set up, and configure the arm.

Topics in this chapter include:

- *The Client*
- *LUKE Arm System*

The Client

The first and foremost task in fitting, setting up, and configuring the arm is to meet with the client and determine their needs as they relate to the LUKE arm. As each client is different, you need to work with them to determine the appropriate arm configuration and system components that best fit them. You need to determine their physical and mental abilities as they relate to controlling and using the arm.

Once you have determined the arm configuration and system components, you then need to examine the client and determine the type of socket and harness needed to securely attach the arm to them.

Once you have determined the arm configuration and fabricated the socket and harness, you need to determine the input control scheme for the client. Again, as each client is different you need to work with them to determine the types of user inputs they can use in the control scheme in order to control the arm.

Finally, you and/or a therapist should evaluate the strength and range of motion of the client as related to their prosthetic arm treatment and, if indicated, prescribe a home exercise program to address any limitations prior to the client engaging in active use of the prosthesis. This program could include exercises to strengthen the shoulder muscles including the rotator cuff, and the muscles of the upper arm if indicated. It is suggested that the client advance their activities with the LUKE arm on a gradual basis to minimize muscle soreness associated with using their new prosthesis.

This initial meeting with the client to clearly define their physical and mental ability, the arm configuration, socket type and harness, user inputs, and to evaluate their strength and range of motion is a critical first step in the setup and configuration of the arm.

Indications For Use

The LUKE arm system consists of a prosthetic arm and accessories which are used by a certified prosthetist to create a full upper extremity prosthesis indicated for individuals, age 18 years and older, who have partial or full upper limb amputations or congenital defects. The device is used to assist in activities of daily living (ADLs).

Contraindications For Use

The LUKE arm system may only be fit by an accredited prosthetist experienced in the setup and configuration of powered prostheses.

The following list of contraindications is included to provide guidelines for client evaluation/consideration. With clients having one or more of the conditions listed below, further evaluation/consideration may be required. The client's healthcare providers should provide the final decision as to whether the client is suitable to use the prosthesis. Some clients may require more extended training or a longer period of time to adapt to using the device.

Areas to consider in the evaluation of prosthesis suitability or which may require special consideration during the fitting of an arm system for a specific client include:

- Skin conditions of their residuum such as burns, poor skin coverage, and severe contractures that prevent current or prior wearing of a prosthetic arm.
- Significant peripheral neuropathy, uncontrolled diabetes, inadequate extremity sensory perception, severe phantom pain or a history of skin ulcers.
- Significant comorbidities which in the opinion of the clinician would interfere with the client's ability to control the prosthesis.
- Severe circulatory problems including peripheral vascular disease and pitting edema.
- Clients undergoing chronic renal dialysis with co-morbidities associated with skin changes and poor wound healing deficits.
- Communication deficits, neurocognitive deficits, or mental health problems that would limit their ability to properly learn and control the prosthesis.
- Significant uncorrectable visual deficits that would impair the ability to see prosthesis movement, its controls or its indicators.

Do not fit this system for a client unable to properly interpret your instructions or the *LUKE Arm User Guide*. In addition, the anatomy of the individual's residuum may impact the suitability of the prosthesis, including excessive length – elbow disarticulation, wrist disarticulation and partial hand amputations, or inadequate residual limb length deficits may require further evaluation or special consideration.

LUKE Arm System

The LUKE arm is an upper-extremity prosthesis that accommodates Transradial through interscapulothoracic (including Shoulder Disarticulation and short Transhumeral) amputees. The arm provides a wide range of degrees of freedom and several control options for controlling arm movement.

The LUKE arm is available in several different configurations and the system components used to support the arm are dependent on the arm's configuration. One LUKE arm system may be used at a time by an individual.

For each arm that is to be fit on a client Mobius Bionics offers all the materials, aside from 3rd party supplied input sensors, to configure the arm system. Materials that are typically used to fabricate sockets and fit conventional prosthetics are not supplied by Mobius Bionics.

Depending on the client's arm configuration you will need to order certain components from Mobius Bionics. Prior to setting up and configuring the arm you should review and understand the components available from Mobius Bionics.

WARNING

RISK OF DEATH OR SERIOUS HARM

Do not disassemble or modify any of the provided modules. Do not connect any type of sensor not described in this guide without authorization of the manufacturer. Please connect and configure the LUKE arm system per instructions. Failure to do so could lead to injury.

The LUKE arm configurations and system components are described in the following sections.

- *Arm Configurations*
- *Batteries*
- *External Battery Holster*
- *Battery Chargers and Charging Dock*
- *ACI (Arm Control Interface) Modules*
- *Input/Output Control Devices*
- *The Fitting Arm*

Arm Configurations

The arm is available in the three configurations listed below and shown in [Figure 1](#). Once you have determined which arm configuration best fits your client's needs, you need to specify if the arm is for the right or left side and the proper length as well as which battery type will power the arm. For more information on arm configurations and battery type used to power the arm see [System Battery Types](#).

Shoulder Configuration (SC)

This arm is configured for those amputees with little or no residual limb or for those amputees with limited movement or other restricting factors in their residual limb. In most instances this arm configuration is powered by an internal battery located inside the forearm of the arm and with an external battery used to supplement power.

Humeral Configuration (HC)

This arm is configured for those amputees with a residual limb below the shoulder but not including the elbow. In most instances this arm configuration is powered by an internal battery located inside the forearm of the arm and with an external battery used to supplement power.

Radial Configuration (RC)

The radial configuration is the shortest of the three configurations and is for amputees with a residual limb below the elbow. Radial arm configurations are powered by the external battery.

Figure 1. Arm Configurations



Shoulder Configuration (SC)



Humeral Configuration (HC)



Radial Configuration (RC)

User Inputs/Outputs and the Control Scheme

Prior to setting up and configuring the arm you need to determine which types of user inputs the client can and will use to control the arm. To determine this control scheme, you and the client need to decide which types of inputs the client can physically operate in order to manage arm controls. This section provides information on the arm controls as well as the types of user inputs used to control the arm.

Topics in this chapter include:

- *Arm Controls — Switching vs. Motion*
- *User Inputs*
- *User Output - Tactor*

Arm Controls — Switching vs. Motion

User inputs are used to select the two arm controls, **switching** and **motion**. You need to identify and configure a specific user input to control **switching** of arm operating modes while configuring the remaining user inputs to control hand and arm **motion**.

Table 5 lists the arm controls and provides a description of the control.

Table 5. Arm Controls

Arm Controls	Description
Switching	A user input used to change or toggle through the operating modes: Standby mode, Hand mode, and Arm mode (if available).
Motion	A user input used to vary the speed and position of a joint or series of joints within the hand and arm.

User Inputs

Listed below are the user inputs used to control the arm. Following the list is a description of each of the inputs, a description of how they are used, and any restrictions when using the inputs.

- *IMUs (Inertial Measurement Units)*
- *EMG - Electromyography (Surface EMG Electrodes)*
- *Pressure Switches*
- *Rocker Switches*
- *Pressure Transducers*
- *Linear Transducers*

IMUs (Inertial Measurement Units)

Description

IMUs command motion by having the client tilt their foot to control the configured arm motions. See [Figure 10](#).

NOTICE

The IMUs have an IP57 rating. The IP rating specifies the strength of an enclosure against solids (such as dust) and liquids. An IP57 rating provides resistance to water at depths up to 1 m (39 inches) and resistance to fine dust.

Figure 10. Inertial Measurement Unit



Places Used

Inertial Measurement Units (IMUs) are installed on top of client's shoes using a shoe clip or custom fabricated strap or pocket. For detailed information on installing and setting up the IMUs see [Chapter 8, "Installing IMUs"](#).

Arm Controls

IMUs are used to control arm motion and certain switching functions other than mode select. See [Restrictions](#) below.

How They Are Used

If you intend to use IMUs, the first task you need to perform is to examine the client's feet and decide if they can be used for viable control inputs. The client has to have the physical mobility to move their feet with enough dexterity to operate the IMU.

The IMU designated for motion controls uses all four directions: anterior (toe), posterior (heel), medial (inside), and lateral (outside). You and the client determine which of these four motions are used to perform a specific arm motion. You configure this using the Prosthetist Interface (PI). When configuring the IMUs using the Prosthetist Interface you can adjust the output gains to vary the speed of the arm's motion.

The Prosthetist Interface allows you to configure up to two (2) sets of IMUs. The client is able to switch between sets. This is useful when an IMU battery runs low; the client can switch to the second set of IMUs while charging the first set. For instructions on switching between IMUs, see [Swapping IMUs](#).

NOTICE

The arm supports up to four IMU/ACI modules at a time in multiple combinations, with a maximum of 2 IMUs. For example, you may set up and configure the arm to support two IMU modules and two wired ACI modules or four wired ACI modules and no IMUs.

Up to two pairs of IMUs can be assigned to an arm system, however only one pair may be used at a time. See [Swapping IMUs](#) for more information about switching between pairs of IMUs.

Restrictions

The IMUs CANNOT be used to control Switching (Mode Select) of the arm. The system will not allow Mode Select to be assigned to an IMU input. This is to eliminate the risk that the client can activate or deactivate the arm inadvertently through the simple act of walking.

Installing IMUs

Once the ACI Modules have been installed and connected you can then install the IMUs. The IMUs can be installed on a client's shoe or lower appendage using either the shoe clips or an alternate means such as custom straps or pockets in the shoe.

There are two steps to install the IMUs on a shoe: attaching the shoe clip to the client's shoe and attaching the IMU to the shoe clip. If your client needs help putting on and taking off the IMUs/shoe clips have the person who is providing the help available at this time. IMUs can be installed on a lower appendage by alternate means, as long as they are securely attached. If you create a label to indicate which IMU your client uses on the left or right side or to designate IMU sets, avoid covering the LED on the IMU.

NOTICE

The IMUs will not provide data if tipped more than 83 degrees. Be sure to position the IMU as close to level as possible when installing the IMU. If you mount the IMU at an angle of more than 38 degrees to begin, the IMU will not provide the full range of +/- 45 degrees after zeroing because they are out of range when they reach the 83 degree limit. See *IMU - Angle Limit Detect*.

Note that IMUs connect to the arm through a wireless connection. This wireless connection is configured through software using the Prosthetists Interface. See [Chapter 11, "Configuring the Arm Using the Prosthetist Interface"](#).

Topics in this chapter include:

- *Installing the IMU in the Shoe Clip*
- *Installing the IMU/Shoe Clip on the Client's Shoe*

Installing the IMU in the Shoe Clip

To install the IMU in the shoe clip, see [Figure 65](#) and perform the following steps:

1. Slide the tabbed end of the IMU into the open end of the shoe clip.
2. Press down on the IMU until the shoe clip retention tab snaps into the IMU slot. Ensure the IMU is fastened securely to the shoe clip.

NOTICE

- The shoe clip can be put on the shoe either before or after the IMU is installed in the shoe clip.
- You can attach the IMU by alternate means (straps/pocket/etc.) as long as it is securely attached.

Figure 65. Attaching the IMU to the Shoe Clip

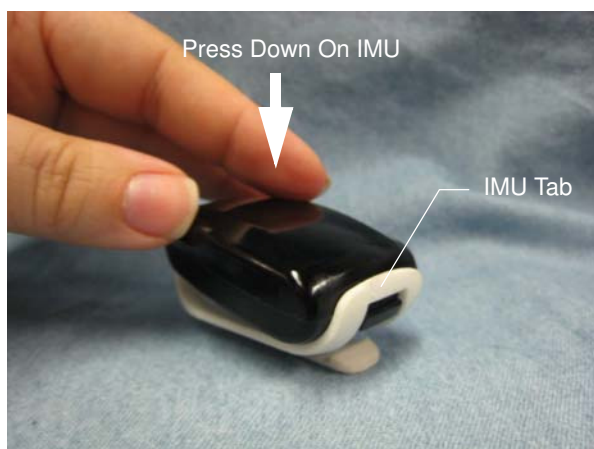
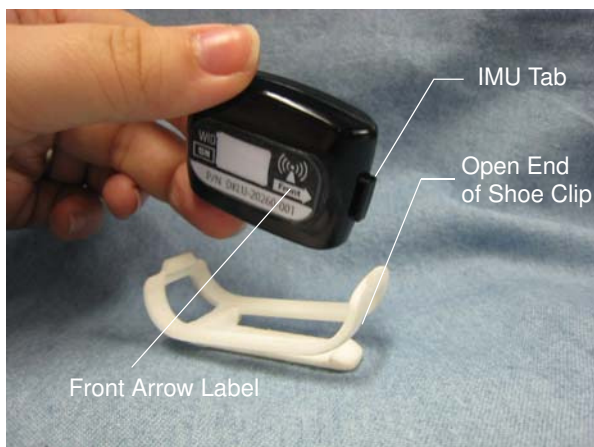

Installing the IMU/Shoe Clip on the Client's Shoe

To install the shoe clip on client's shoe, see [Figure 66](#) and perform the following steps:

NOTICE

- Note that the shoe clip can be installed onto the shoe with the shoe on or off the client's foot.
- Once the shoe clip is installed, the shoe clip can remain on the shoe.
- If the IMU is in the clip, make sure to attach the clip and IMU to the correct foot per the client's configuration.

1. Orient the shoe clip so that the open end of the clip is facing towards the client's toes.
2. Slide the shoe clip under the laces of the shoe.

When installing the shoe clip to the shoe, please ensure the following:

- The shoe clip passes through at least two of the shoe's laces to ensure the clip is secure and stable.
- The Front Arrow label on the bottom of the IMU is facing towards the client's toes. See [Figure 65](#).

3. Tighten the laces to secure the IMU and shoe clip to the shoe.
4. If the client has not already done so, have them put on the shoe.

Figure 66. Attaching the IMU/Shoe Clip to the Client's Shoe



Open End of Shoe Clip
NOTE: IMU is Shown Attached to Shoe Clip.

NOTICE

The wireless IMUs do not contain an ON/OFF button. An IMU that is awake and set up to communicate with an arm will do so once the arm is powered **ON**. See *Waking a Sleeping IMU* and *Initializing the Arm*.

Waking a Sleeping IMU

When an IMU has not communicated with the arm for more than 30 minutes, the IMU reverts to a sleep mode to conserve the battery. When in sleep mode the IMU is not listening for arm communication.

As a result, if the IMU is in sleep mode when the arm is turned on, it will not connect with the arm. This results in a sweeping pattern on the Grip Select LEDs while the arm tries to connect with the IMUs. If the arm doesn't connect with the IMUs after about 10 seconds, an "IMU Comm Lost" fault will occur. Having the client shake their foot with the IMU attached wakes the IMU from sleep mode so that the IMU is ready to communicate with the arm once the arm system is powered on. See *Swapping IMUs* for details on switching between sets of IMUs or *Troubleshooting the Arm* for troubleshooting information.

An IMU that has been shaken awake is waiting to communicate with the arm. IMUs that are not actively communicating with an arm blink the battery state of charge LED whenever they are shaken, regardless of whether they are sleeping or not.

NOTICE

After shaking the IMU awake if it does not communicate with the arm within five (5) minutes the IMU reverts back to sleep mode to conserve the battery charge.

Configuring the Arm Using the Prosthetist Interface

The Prosthetist Interface (PI) is a graphical user interface used to configure the LUKE arm. This user interface allows you to collect and display real-time data from the arm and stores this data as specific arm configurations. The Prosthetist Interface obtains this information by communicating with the arm's MAC (Master Arm Controller) via a wireless connection.

Installing the Prosthetist Interface

The Prosthetist Interface (PI) software is provided on several types of media. The first time you want to use the Prosthetist Interface on your computer, you need to install the PI software and FTDI (Windows) drivers onto the computer.

NOTICE

If the Prosthetist Interface has already been installed on this PC, you must uninstall the program prior to reinstallation.

Click Start ->Programs and Features ->Select "Arm PI" ->Choose uninstall

Installing the Prosthetist Interface Software

To install the PI software perform the following steps:

NOTICE

The system requirements for the computer are as follows:

- Windows® 7
- USB 2.0 Capability

1. Insert the PI media onto your computer.
2. Open the drive where the Arm PI Install resides.

3. Double-click the Arm PI setup file.

The Welcome to the Arm PI Setup Wizard window opens. See [Figure 89](#).

Figure 89. Welcome to the ARM PI Setup Wizard

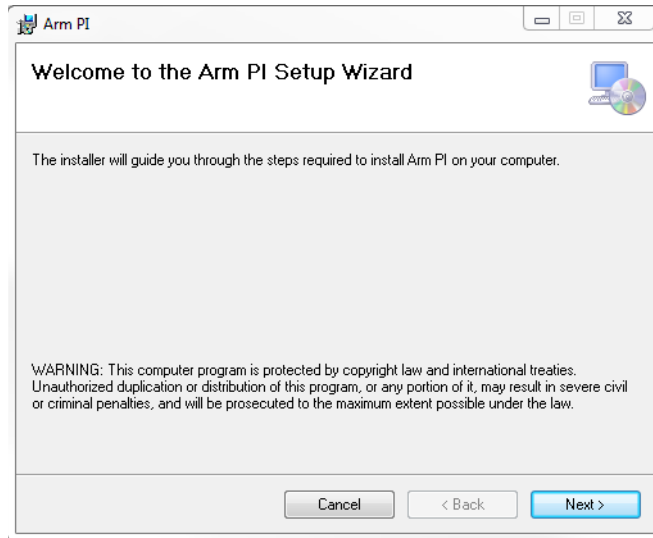

4. Click **Next**.

The Select Installation Folder screen appears. See [Figure 90](#).

Figure 90. Select Installation Folder Screen

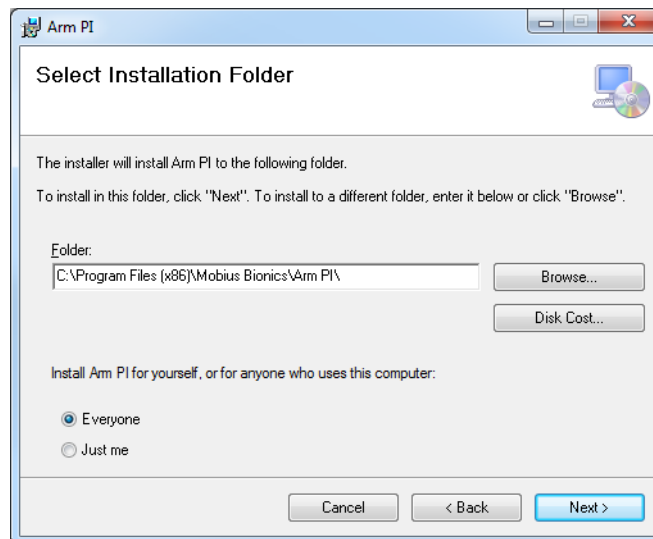

5. You can choose to install the Arm PI in the default directory or browse to a directory of your choice.

6. Click **Next** twice.

The Arm PI is installed.

7. Once the Arm PI installation is complete, click the **Close** button.

8. Next, install the FTDI (Windows) drivers. See *Installing the FTDI (Windows) Drivers*.

Installing the FTDI (Windows) Drivers

The following sections provide information on how to install the FTDI (Windows) drivers depending if the computer is connected to or **not** connected to the internet.

If Connected to the Internet

When inserting the Mobius Bionics supplied PC dongle into the computer for the first time, the driver software automatically starts installing. To install the driver software, when connected to the internet, perform the following steps:

1. Insert the PC dongle into a USB port on your computer.

Two pop-ups will appear in the following order on the bottom right of the desktop:

- a. Installing device driver software. See *Figure 91*.

Figure 91. Installing Device Driver Software

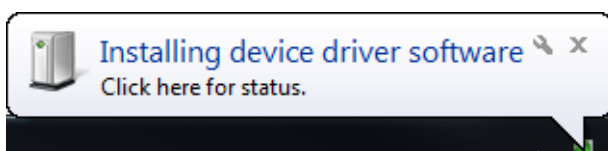

- b. Your device is ready to use. See *Figure 92*.

Figure 92. Your Device Is Ready To Use

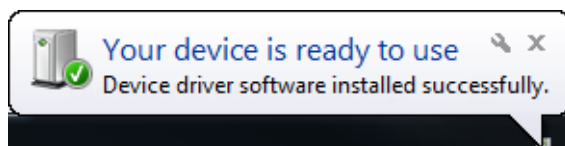

NOTICE

For details on the status of the installation, click on either of the pop-ups (shown in Figures 90 and 91) to make the Driver Software Installation window appear. See *Figure 93*.

Figure 93. Device Driver Installation Status

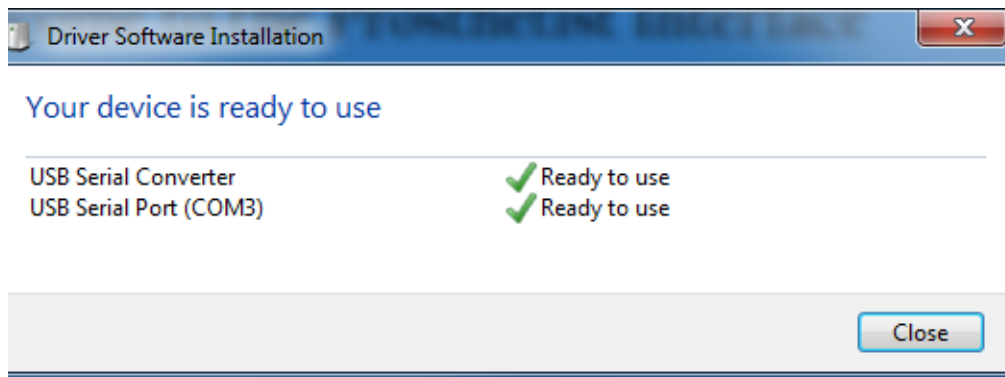

2. Once the device software installation is complete, restart your computer if instructed to do so.

The Prosthetist Interface and drivers are now installed on your computer and an Arm PI Icon is displayed on the desktop. You can now begin to use the Prosthetist Interface. See *Opening the Prosthetist Interface*.

If NOT Connected to the Internet

If the computer is not connected to the internet, you need to manually link the FTDI (Windows) drivers (Serial Converter and Serial Port) that were installed during the installation of the PI. To link to the drivers, perform the following steps:

1. Insert the Mobius Bionics supplied PC dongle into a USB port on the computer.
A pop-up appears notifying you that the Device driver software was not successfully installed. See *Figure 94*.

Figure 94. Device Driver Software Not Successfully Installed

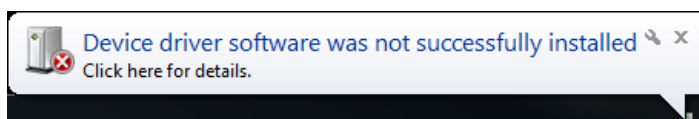

NOTICE

For details on the status of the installation, click on the pop-up (shown in Figure 93) to make the Driver Software Installation window appear. See *Figure 95*.

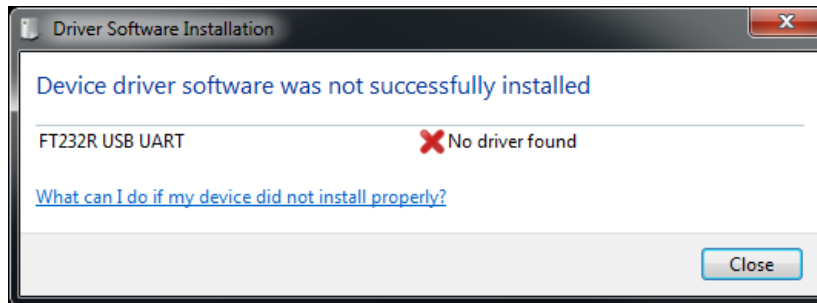
Figure 95. Details - Device Driver Software Not Successfully Installed

2. Click Start ->Device Manager.
3. Under Other Devices, right click on the **Unknown Device** icon and choose **Update Driver Software**.

The Update Driver Software window appears. See [Figure 96](#).

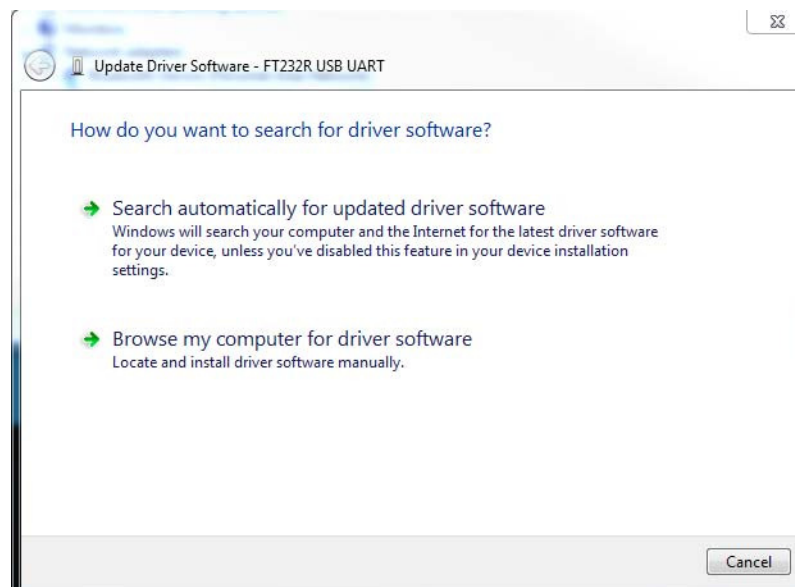
Figure 96. Update Driver Software

4. Click **Browse my computer for driver software**.

The Browse For Folder window appears. See [Figure 97](#).

Figure 97. Browse for Folder

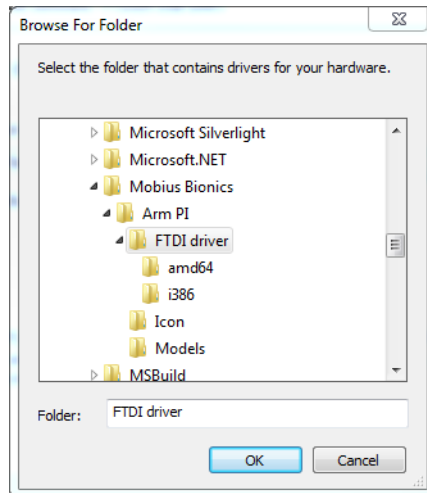

5. Navigate to C:\Program Files(x86)\Mobius Bionics\Arm PI.
6. Select **FTDI driver** and click **OK**.

The Update Driver Software - Unknown Device window appears. See [Figure 98](#).

Figure 98. Update Driver Software - Unknown Device

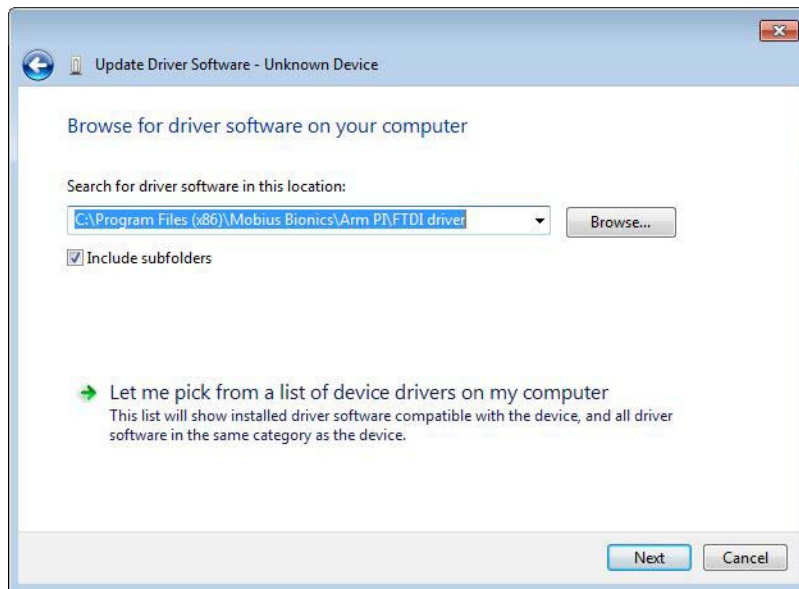

7. Verify that **Include subfolders** is checked.
8. Click **Next**.

A message appears stating Windows has successfully updated your driver software. See [Figure 99](#).

NOTICE

For the driver software update to take effect you need to restart your computer.

Figure 99. Successful Driver Update

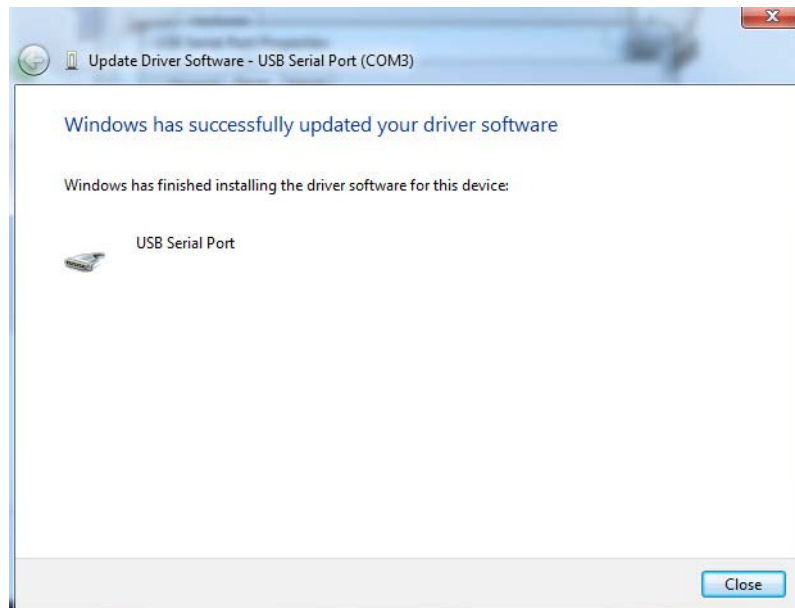

9. Click **Close**.

10. Repeat Steps 2 through 9 if:

Depending on the Microsoft updater configuration of the PC, the device may first install the "USB Serial Converter" and read as "USB Serial Port" under "**Other Devices**".

Repeat Steps 2 through 9 so the "USB Serial Port" appears as "USB Serial Port (COM#)" under "**PORTS**" in the device manager.

The Prosthetist Interface and drivers are now installed on your computer and an Arm PI icon is displayed on the desktop. You can now begin to use the Prosthetist Interface. See *Opening the Prosthetist Interface*.

Opening the Prosthetist Interface

1. Insert the PC Dongle into a USB port of your computer (if there isn't one already there).
2. Double click the Arm PI icon.

The PI Welcome screen appears. See [Figure 100](#).

Figure 100. Prosthetist Interface Main/Welcome Screen

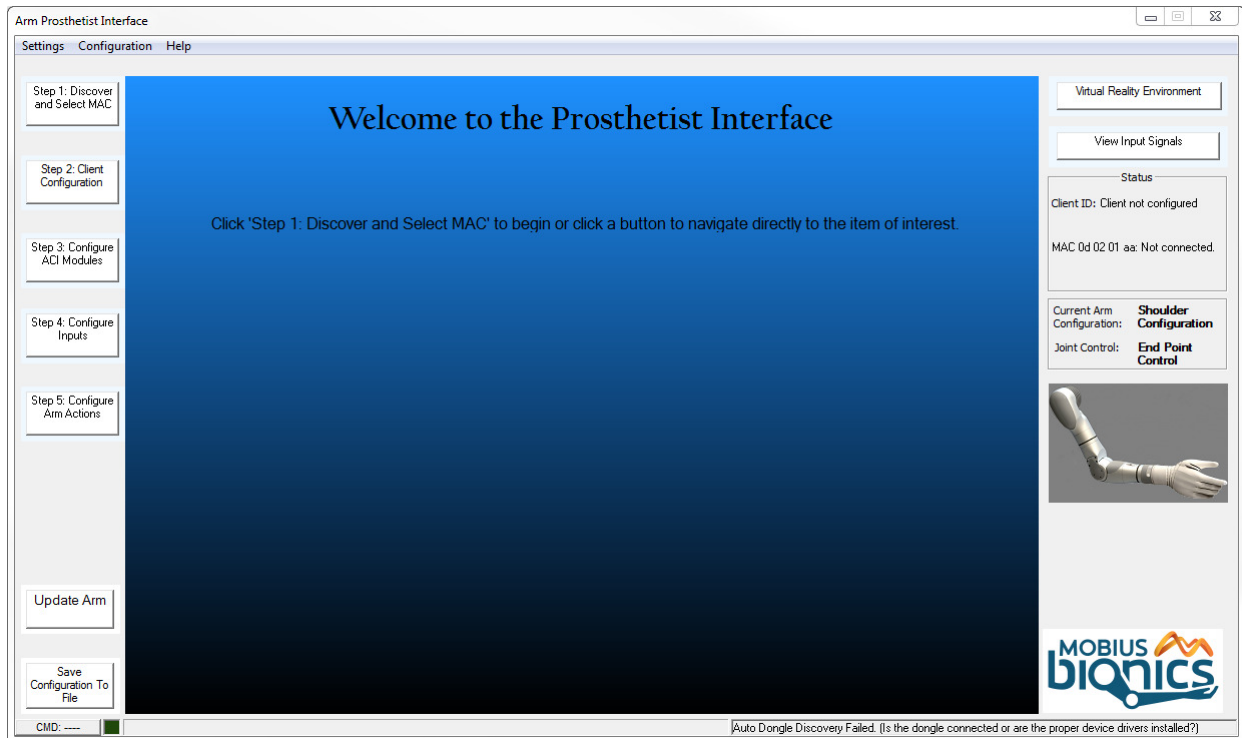

Navigating The Prosthetist Interface

The Prosthetist Interface (PI) contains PI menus, several buttons, and a configuration screen used to configure the arm. These items are described in the following sections.

Arm PI Menus

The PI menu has three drop down selections which allow you to change settings, view and print the configuration summary as well as events and statistics, and view the version of the PI.

Figure 101. Arm PI Menus

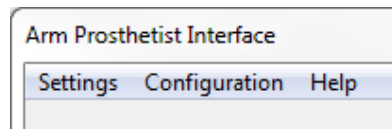

Settings Menu

The Settings drop down menu contains three selections:

- *Change Settings*
- *Power Save Mode*
- *Real Time Clock*

Change Settings

Change Settings allows you to manually change the Command Port and Data Port settings, if necessary. Note that the Command Port and Data Port are automatically detected during installation of the PI.

Power Save Mode

Power Save Mode configures the arm to engage the brakes when the arm stops moving. Engaging the brakes saves battery power by not running the motors. Power Save Mode is not used for RC arms. The Power Save Mode value is not cleared or saved with the PI arm configuration.

You can set the delay, in seconds, between when the arm stops moving and when the brakes engage. With a delay of zero (0) seconds, Power Save Mode is turned **OFF**. When Power Save Mode is **OFF**, the brakes are disengaged and the motors are on whenever the arm is on.

To set the Power Save Mode perform the following steps:

1. From the **Settings** menu select **Power Save Mode**.
The Power Save Mode screen opens. See [Figure 102](#).

Figure 102. Power Save Mode

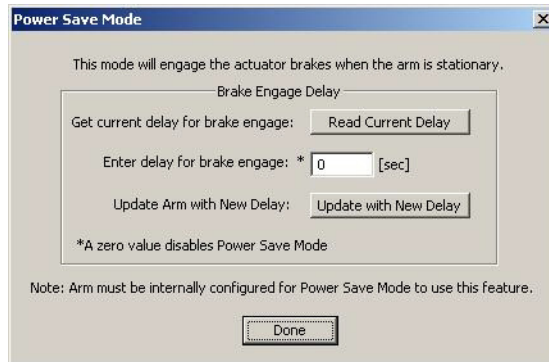

2. Enter the new delay value (in seconds), and click **Update Arm with New Delay**.
3. Click **Done**.

Real Time Clock

Selecting the Real Time Clock function sends the computer's clock settings to the arm system. This sets the arm's clock. The arm's clock is set at the factory. The arm's clock is used to put a time stamp on the event log.

The factory sets the arm's clock to Eastern time, and the clock does not automatically adjust for daylight savings time.

To get or set the Real Time Clock perform the following steps:

1. From the **Settings** menu select **Real Time Clock**.
The Real Time Clock screen opens. See [Figure 103](#).

Figure 103. Real Time Clock

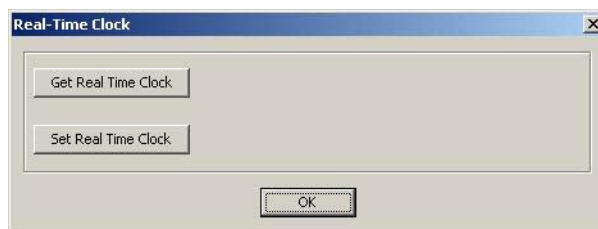

2. To get the arm's current clock setting, click **Get Real Time Clock**.
3. To send the computer's clock settings to the arm, click **Set Real Time Clock**.
4. Click **OK**.

Configuration Menu

The Configuration drop down menu contains four selections.

- *Print Summary*
- *Print IMU Actions*
- *View Events*
- *View Usage Stats*

Print Summary

Print Summary allows you to view and print a summary of the arm configuration. To view or print the arm configuration summary perform the following steps:

1. From the **Configuration** menu select **Print Summary**.

The Print Summary screen opens. See [Figure 104](#).

Figure 104. Print Summary Example

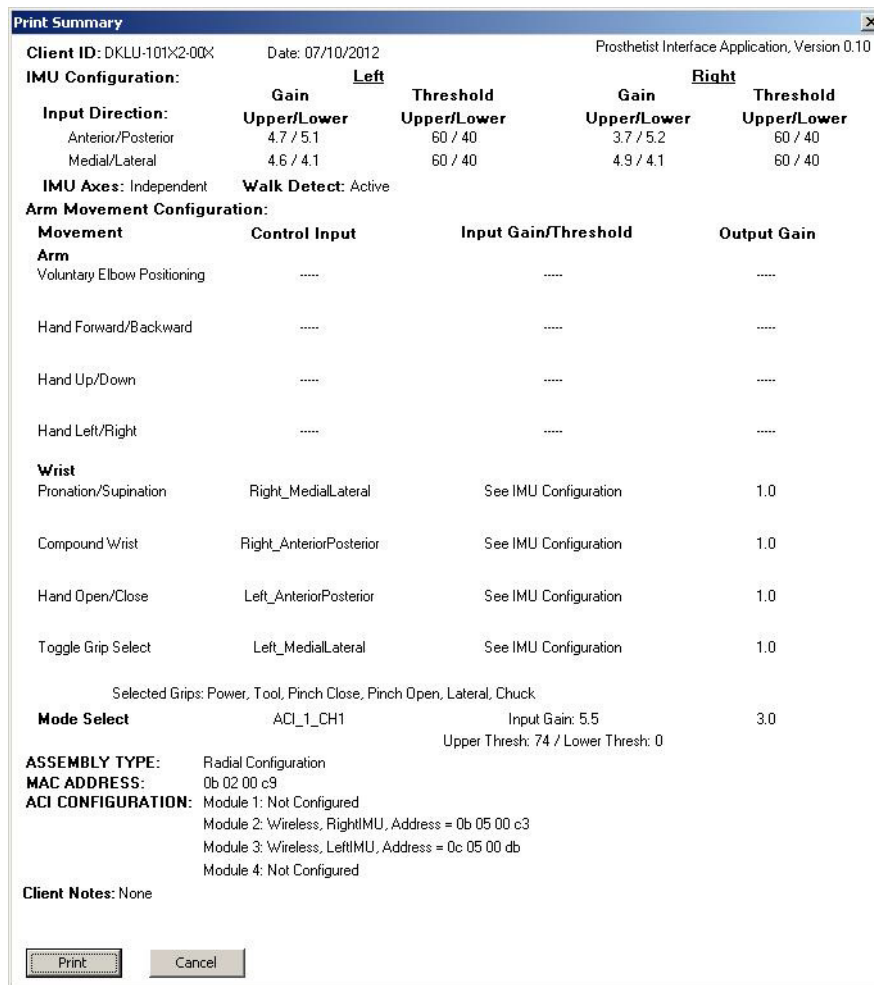

2. To print the summary configuration click **Print**.

The Print dialog box opens.

3. Select the appropriate printer from the drop down list.
4. Click **OK**.

Print IMU Actions

After configuring the IMUs to perform certain arm actions, use the Print IMU Actions function to print out a single sheet reference card for the client. The card will show both IMUs and which actions they perform. The arrow points to the direction in which the client tilts their foot.

To view or print the IMU configuration perform the following steps:

1. From the **Configuration** menu select **Print IMU Actions**.

The Print IMU Actions screen opens. See [Figure 105](#).

Figure 105. Print IMU Actions

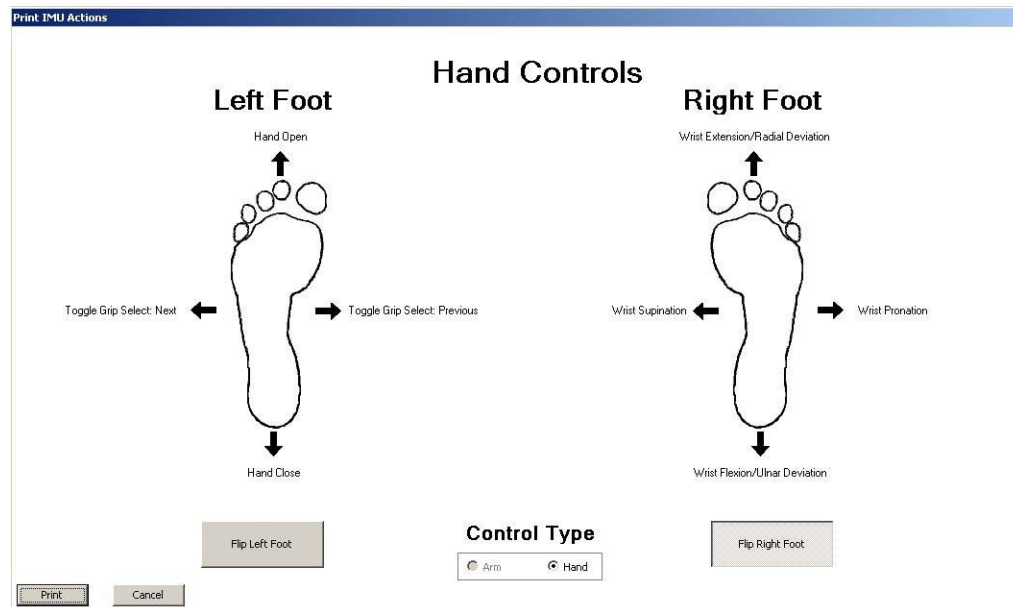

2. To print the IMU Actions click **Print**.

The Print dialog box opens.

3. Select the appropriate printer from the drop down list.
4. Click **OK**.

View Events

View Events allows you to view a list of events that have occurred within the arm. Events include faults that have occurred and can be used for troubleshooting. See *LUKE Arm System Alerts* for more information.

To view events perform the following steps:

1. From the **Configuration** menu select **View Events**.

The **Event Logs** screen opens. See *Figure 106*.

Figure 106. Event Logs Example

Date	Time	Type	Event Number	Event Data	Details
08/30/2013	12:35:47:975	Event	621	0	ShutDown
08/30/2013	12:35:53:000	Event	513	0	Startup

2. View events as needed to aid in troubleshooting.
3. To save the Event Logs to a file click **Save Events**.
4. When done viewing the Event Logs click **Done**.

View Usage Stats

View Usage Stats allows you to view a list of arm usage statistics. To view statistics perform the following steps:

1. From the **Configuration** menu select **View Usage Stats**.

The **Usage Statistics** screen opens. See [Figure 107](#).

Figure 107. Usage Stats Example

Stat Name	Usage	Units
Secondary Battery Voltage >14.75 To 15.5 Volts	0	min
Secondary Battery Voltage >15.5 Volts	4.050000668	min
Secondary Battery Capacity 0 to 20 Pct	0	min
Secondary Battery Capacity 21 to 40 Pct	0	min
Secondary Battery Capacity 41 to 60 Pct	0	min
Secondary Battery Capacity 61 to 80 Pct	0	min
Secondary Battery Capacity 81 to 100 Pct	4.050000668	min
Secondary Battery Temperature <20 Deg C	0	min
Secondary Battery Temperature >20 To 25 Deg C	3.250000477	min
Secondary Battery Temperature >25 To 30 Deg C	0.8000001311	min
Secondary Battery Temperature >30 To 35 Deg C	0	min
Secondary Battery Temperature >35 To 40 Deg C	0	min
Secondary Battery Temperature >40 Deg C	0	min
Index Finger Compliance 0 to 400	0	min
Index Finger Compliance 401 to 800	0	min
Index Finger Compliance 801 to 1200	0	min
Index Finger Compliance 1201 to 1600	0	min
Index Finger Compliance 1601 to 2000	0	min
Index Finger Compliance 2001 to 2400	4.056667805	min
Index Finger Compliance 2401 to 2800	0	min
Index Finger Compliance 2801 to 3200	0	min
Index Finger Compliance 3201 to 3600	0	min
Index Finger Compliance >3600	0	min
Thumb1 Compliance 0 to 400	0	min
Thumb1 Compliance 401 to 800	0	min
Thumb1 Compliance 801 to 1200	0	min
Thumb1 Compliance 1201 to 1600	0	min
Thumb1 Compliance 1601 to 2000	4.150001049	min
Thumb1 Compliance 2001 to 2400	0	min
Thumb1 Compliance 2401 to 2800	0	min
Thumb1 Compliance 2801 to 3200	0	min
Thumb1 Compliance 3201 to 3600	0	min
Thumb1 Compliance >3600	0	min
Thumb2 Compliance 0 to 400	0	min
Thumb2 Compliance 401 to 800	0	min
Thumb2 Compliance 801 to 1200	0	min
Thumb2 Compliance 1201 to 1600	0	min
Thumb2 Compliance 1601 to 2000	4.158334255	min
Thumb2 Compliance 2001 to 2400	0	min
Thumb2 Compliance 2401 to 2800	0	min
Thumb2 Compliance 2801 to 3200	0	min
Thumb2 Compliance 3201 to 3600	0	min
Thumb2 Compliance >3600	0	min

2. View the usage statistics as needed.
3. To save the Usage Stats to a file click **Save Stats**.
4. When done viewing the statistics click **Done**.

Help Menu

The **Help** drop down menu contains one selection: **About**. Selecting **About** opens the **About PI** dialog box which provides the PI version and copyright information.

Configuration Steps and Dynamic Configuration Screen

The PI contains five configuration steps located to the left of the Dynamic Configuration screen. Clicking on any of the steps opens the configuration screen for that step. If you are performing the initial configuration of the arm these five steps should be performed in sequential order. If you are changing an existing configuration you can click on the specific step you need to change.

Figure 108. Configuration Steps and Configuration Screen

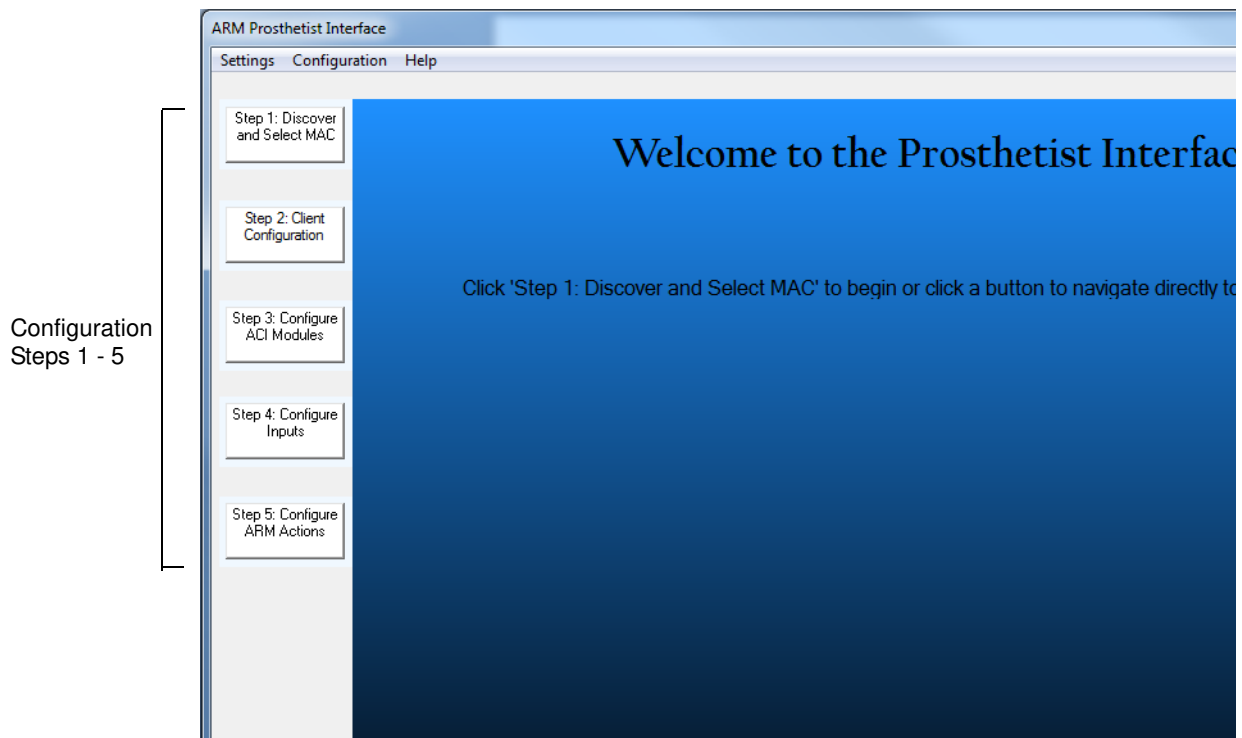

Update Arm

When you use the PI to make changes to a client configuration, at first these changes are only made on the computer. Clicking on the **Update Arm** button sends the client configuration information from PI to the arm. As you make changes to a client configuration in the PI, the **Update Arm** button pulses blue to notify you that the configuration needs to be sent to the arm. When updating the arm, you have the option to save the configuration to a file.

To update the arm with the client configuration from PI and save the configuration to a file, perform the following steps:

1. Click the **Update Arm** button.

The **Save Configuration to File** dialog box opens. See [Figure 109](#).

Figure 109. Save Configuration to File

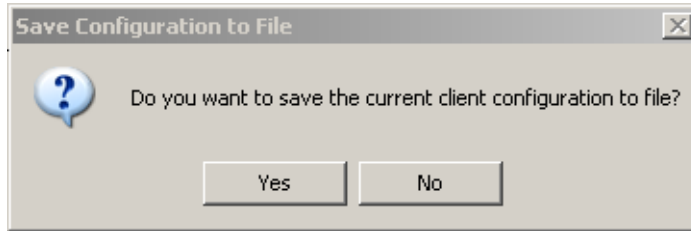

2. To update the arm and save the configuration changes to a file click **Yes**. If you click **No** to save the current configuration to file, the configuration file will still be sent to the arm.

NOTICE

IMPORTANT: Changes made to configuration settings in PI are not sent to the arm until you click the Update Arm button.

3. If prompted, power cycle the arm. See [Figure 110](#).

Figure 110. Power Cycle the Arm

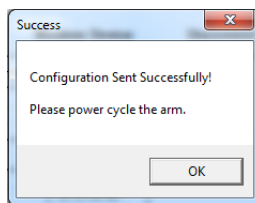

NOTICE

Power cycling is only needed after changes are made to the ACI module configuration. See [STEP 3: Configure ACI Modules](#).

Save Configuration to File

Clicking the Save Configuration to File button at any time saves the client configuration to a file. Saving the configuration to a file does not update the arm. For information on sending a client configuration from the PI to the arm, see [Update Arm](#).

To save the client configuration to a file on the computer, perform the following steps:

1. Click the **Save Configuration to File** button.

The Save As dialog box opens.

2. Navigate to the directory where you want to save the file.

NOTICE

When you save the configuration to a file, a default file name appears in the File name box. This suggested file name is based on the Client ID and the current date and time. You can use this default file name or change it to one of your choosing.

3. Accept the default file name or enter your own file name.
4. Click **Save** to save the file.

Virtual Reality Environment

Clicking on the **Virtual Reality Environment** button opens the Virtual Reality Environment screen. For information on using the Virtual Reality Environment see [Chapter 12, "Virtual Reality Environment and Viewing Input Signals"](#).

View Input Signals

Clicking on the **View Input Signals** button opens the Preview Live Dialog screen. For information on viewing input signals see [Chapter 12, "Virtual Reality Environment and Viewing Input Signals"](#).

Status

The configuration status is displayed in the Status box to the right of the Configuration pane. See [Figure 111](#). As you configure the arm the status information changes. The following status information is displayed:

- Client ID — The current client’s identification.
- MAC — The wireless address of the arm currently connected to the PI.
- Current Arm Configuration — The current selected arm configuration.
- Joint Control — The type of control being used to control motion.

Figure 111. Status

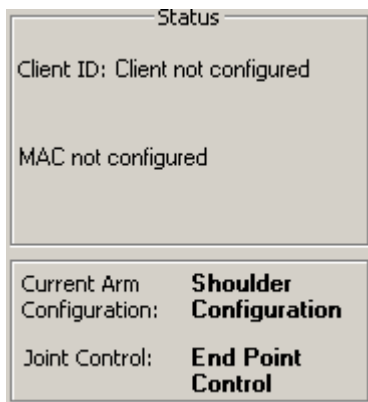

Arm Illustration

The arm illustration to the right of the configuration pane changes depending on the arm assembly selected in the Client Configuration screen. See [Figure 112](#). Note that a right handed arm is always shown regardless of the handedness of the arm system. The possible illustrations are:

- Shoulder Configuration
- Humeral Configuration
- Radial Configuration

Figure 112. Arm Illustration

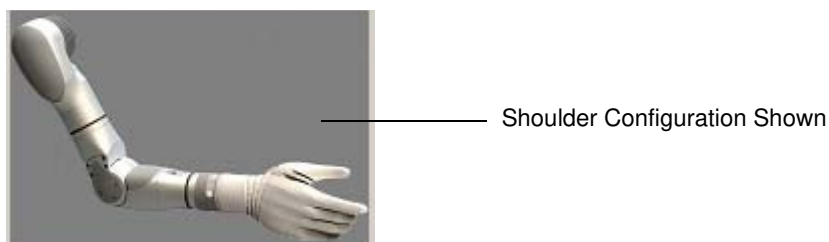

Tool Tips

As you scroll over specific areas within the configuration screens tool tips will pop up. These tips provide helpful information on configuring the arm. See [Figure 113](#) for a tool tip example.

Figure 113. Example - Tool Tip

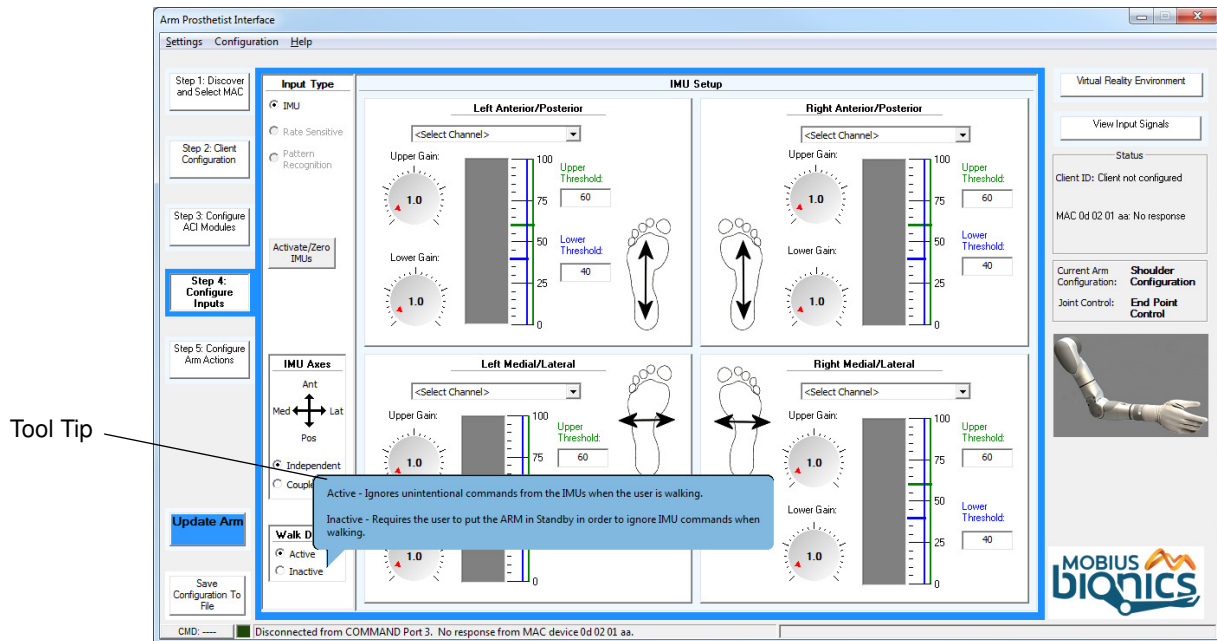

Using the Prosthetist Interface

The Prosthetist Interface (PI) graphical user interface provides step by step procedures for configuring the arm. Initially, you need to sequentially perform all five steps to configure the arm. After the initial configuration you can access any of the steps in order to change the arm's configuration. Once you have configured the arm you and the client can then test the arm's configuration using the Virtual Reality Environment prior to actually moving the arm. Then you can move on to controlling the arm directly.

The five configuration steps are described in the following sections.

STEP 1: Discover and Select Master Arm Controller (MAC)

The first step in configuring the arm is to discover and select the MAC. The MAC is the main computer in an arm system. It has the wireless radio that communicates to the PI through the PC dongle. Step 1: Discover and Select MAC in the configuration process opens the Discover and Select Master Arm Controller (MAC) screen. This screen allows you to discover all Master Arm Controllers in the area and select the MAC for your client's arm. The arm must be **ON** for the MAC to be discovered by the PI. See [Figure 114](#).

NOTICE

- Ensure the PC dongle is inserted into a USB port on your computer before opening the Prosthetist Interface
- Ensure the arm is **ON** before discovering and selecting the Master Arm Controller

To open the Discover and Select Master Arm Controller (MAC) screen, click the **Step 1: Discover and Select MAC** button from the PI main screen. See [Figure 114](#) and [Table 21](#) for more information.

Figure 114. Step 1: Discover and Select MAC

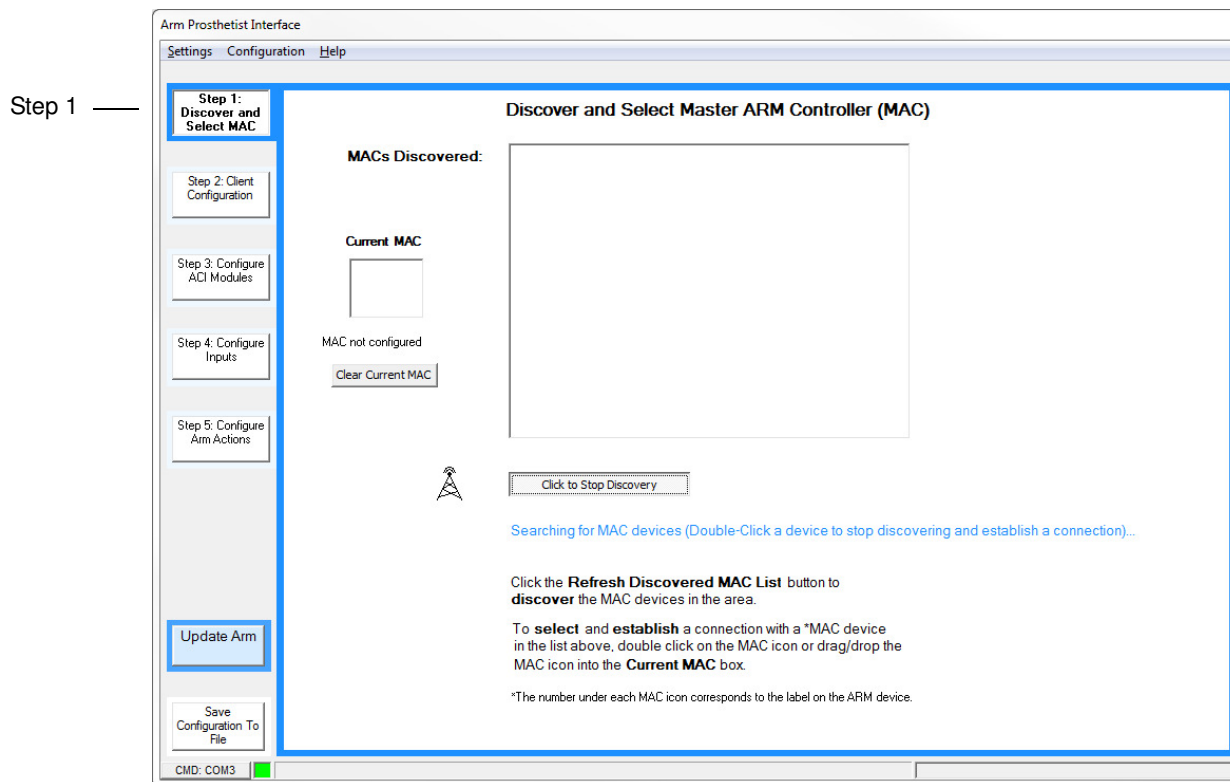

Table 21. Step 1: Discover and Select MAC - Fields and Buttons

Field/Button	Description
MACs Discovered	A list of Master Arm Controllers discovered when you click the Refresh Discovered MAC List button.
Current MAC box	The MAC currently selected. This selection is saved and appears the next time the PI is opened.
Clear Current MAC	Disconnects the MAC from the system.
Refresh Discovered MAC List	Discovers all MACs within the area.

Discovering and Selecting the MAC

To discover and select the MAC for your client's arm, perform the following steps:

1. Click **Refresh Discovered MAC List** to discover the MACs within the area. The **MACs Discovered** box is populated with the discovered MACs.
2. Locate the serial number label on the wrist and read the arm's MAC address.
3. If a MAC icon already exists in the **Current MAC** box from a previous connection, click clear current MAC to clear the box.
4. To select and establish a connection with the MAC for your client's arm, either double click on the MAC icon or drag and drop the MAC icon into the **Current MAC** box.

STEP 2: Client Configuration

The next step in configuring the arm is to create and save a new client configuration file or load a previously saved client configuration file. You will also need to select the arm assembly to be used by the client. Step 2 also allows you to read a client's configuration file directly from the arm or clear the current loaded configuration.

The **Client Configuration** screen allows you to configure the following parameters:

Initial Configuration

When completing an initial configuration set the following parameters:

- *Create a New Configuration*
- *Select the Arm Assembly*
- *Zero the Shoulder (if fitting an SC arm)*

Existing Configurations

When working with existing configurations the following parameters are available:

- *Clear the Arm Configuration*
- *Read the Current Configuration from the Arm*
- *Load a Configuration from File*

To open the Client Configuration screen, click the **Step 2: Client Configuration** button from the PI main screen. See [Figure 115](#) and [Table 22](#) for more information.

Figure 115. Step 2 - Client Configuration

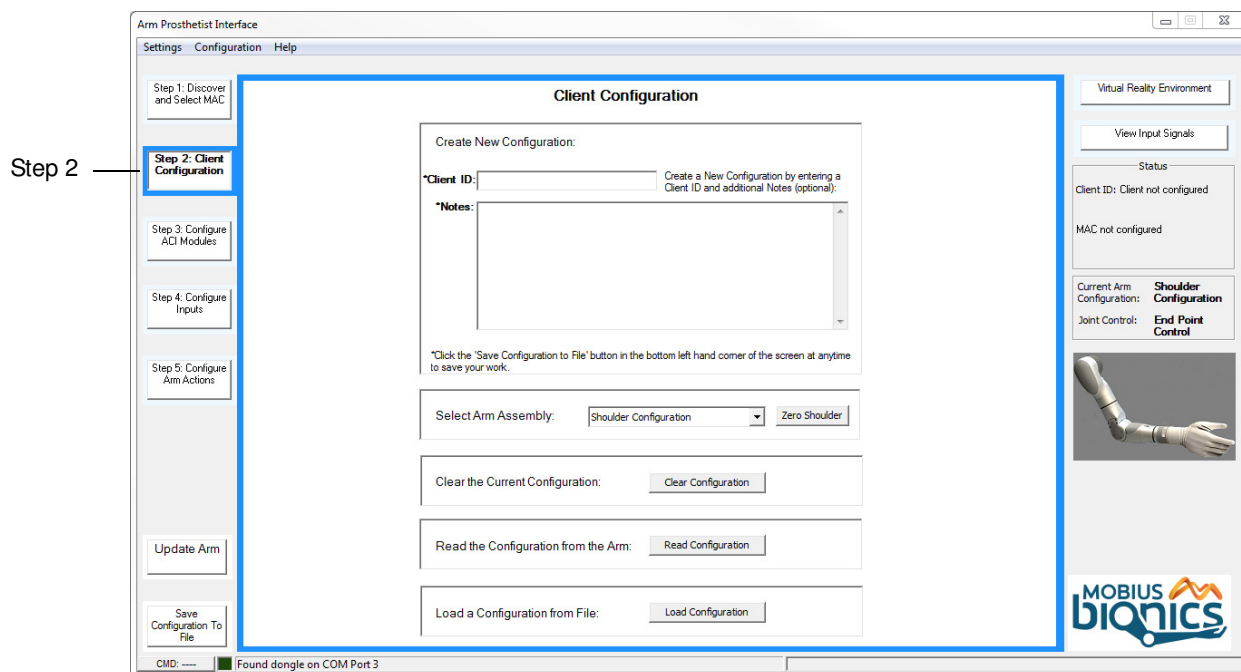

Table 22. Step 2: Client Configuration - Fields and Buttons

Field/Button	Description
Create New Configuration:	<ul style="list-style-type: none"> • Client ID: The personal identification of the client. The client ID can be up to 32 characters long. • Notes: Allows you to attach any related notes to the client's configuration file.
Select Arm Assembly:	A drop down list that allows you to select the client's arm configuration.
Zero Shoulder	Configures the shoulder's neutral position.

Table 22. Step 2: Client Configuration - Fields and Buttons

Field/Button	Description
Clear the Current Configuration:	Clears the configuration from the PI environment. NOTE: Clearing the configuration from the PI environment does not clear the configuration from the arm.
Read the Configuration from the Arm:	Click the Read Configuration button to read the current configuration loaded on the arm.
Load a Configuration from File:	Click the Load Configuration button to load a previously saved client configuration file. NOTE: Loading a configuration into the PI environment with this command does not load the configuration onto the arm.

Create a New Configuration

To create a new configuration perform the following steps:

1. In the **Client ID** field, enter in the client's identification.

The Client ID can contain up to 32 characters. The following characters can't be used:

/ \ : * ? " < > |

NOTICE

It is recommended that the Client ID field not contain any personal information (e.g., name, initials). When entering any information into a configuration file, refer to the HIPAA (Health Insurance Portability and Accountability Act) guidelines about confidentiality. See <http://www.hhs.gov/ocr/privacy>.

2. In the **Notes** field, enter any information you would like to relate to the client's configuration file.

Select the Arm Assembly

From the **Select Arm Assembly** drop down list, select the correct arm configuration for the client.

The possible values are:

- Shoulder Configuration
- Humeral Configuration
- Radial Configuration

When you select an arm assembly, a picture of the arm's configuration is displayed in the arm illustration box on the PI main screen each time the client file is opened.

Zero the Shoulder (if fitting an SC arm)

After initially mounting the SC arm to the socket, see *Mounting the SC Arm*, you must configure the shoulder to the neutral position.

To zero the shoulder or configure the arm's neutral position, perform the following steps:

1. Have the client don the Arm System and stand up straight.
2. Click the **Zero Shoulder** button.

The Configure the Shoulder's Neutral Position screen opens. See *Figure 116*.

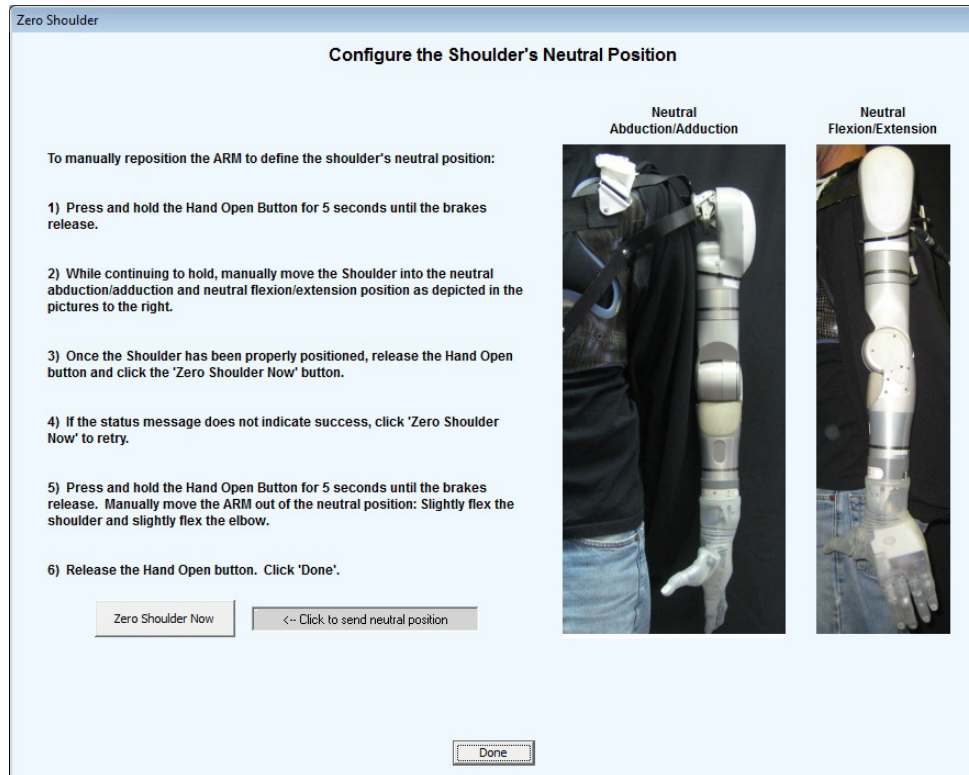
Figure 116. Configuring the Shoulder's Neutral Position

3. Follow the step by step instructions in this screen to zero the shoulder.
4. If completing an initial configuration, you can continue to *STEP 3: Configure ACI Modules*.

Clear the Arm Configuration

To clear the arm configuration perform the following steps:

1. Click the **Clear Configuration** button.

The OK to lose changes to current configuration screen opens. See [Figure 117](#).

Figure 117. Change to Current Configuration

2. Click **OK** to lose changes to current configuration.

NOTICE

Note that at this point, the configuration is cleared from the computer only and is not cleared from the arm. Update Arm must be performed to send the cleared configuration to the arm. Once the configuration is cleared from the arm, the arm will not operate until a new configuration is loaded.

3. Click **Update Arm** to load a cleared, blank configuration to the arm.

The Save Configuration to File screen opens. See [Figure 118](#).

Figure 118. Save Config to File

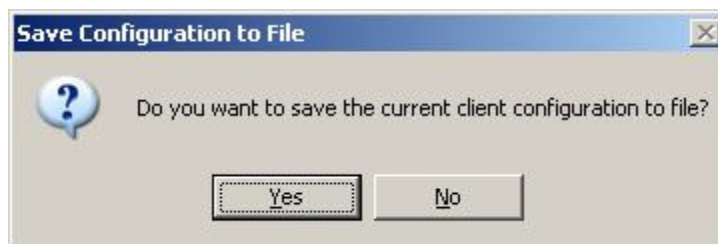

4. Click **Yes** if you would like to save a copy of the cleared, blank configuration for future reference.
5. Click **No** to continue to update the arm without saving a copy of the configuration.
6. Power cycle the arm. See [Re-Initializing the Arm](#).

Read the Current Configuration from the Arm

To read the current arm configuration perform the following steps:

1. Click the **Read Configuration** button.

The current arm configuration is read to the system.

Load a Configuration from File

To load a saved client arm configuration perform the following steps:

1. Click the **Load Configuration** button.

The directory of the saved configuration files opens. See [Figure 119](#).

Figure 119. Saved Client Configuration Files

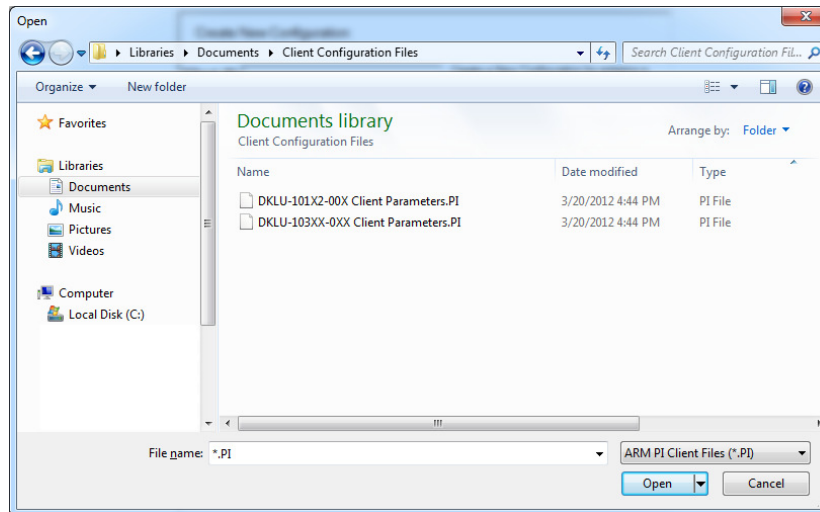

2. Double click the client configuration file you want to load.

The **Write Configuration to Arm** dialog box opens asking if you want to update the arm with the current configuration. See [Figure 120](#).

Figure 120. Write Configuration to Arm

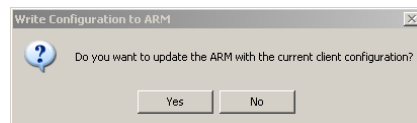

3. Click **Yes** to update the arm with the selected configuration.

STEP 3: Configure ACI Modules

Step 3 in the configuration process is to configure the ACI Modules. In the Main PI screen click **Step 3: Configure ACI Modules** to open the Configure Arm Control Interface (ACI) Modules. You can configure up to four ACI Modules per arm.

To configure the ACI Modules perform the following steps:

1. In the PI main screen click the **Step 3: Configure ACI Modules** button.

The **Configure Arm Controller Interface (ACI) Modules** configuration screen opens. See [Figure 121](#) and [Table 23](#) for more information.

Figure 121. Step 3: Configure ACI Modules

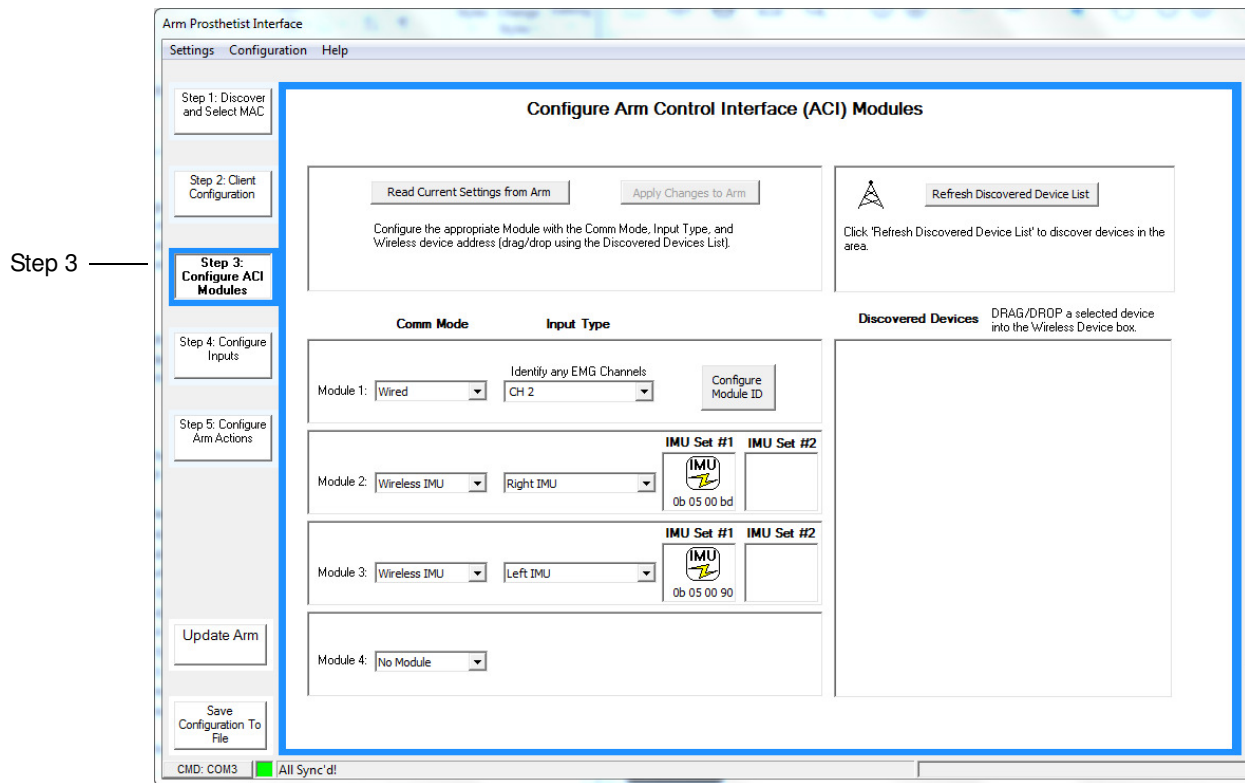

Table 23. Arm Control Interface - Fields and Buttons

Fields/Buttons	Description
Read Current Settings from Arm	Reads the current ACI configuration from the arm.
Apply Changes to Arm	Applies configuration changes to the arm.
Comm Mode (Module 1 - 4)	The Communications Mode used by the ACI Module. The possible values are: <ul style="list-style-type: none"> No Module Wireless IMU Wired
Input Type (Wireless IMU)	The types of wireless inputs used to control the arm. The possible values are: <ul style="list-style-type: none"> None Right IMU Left IMU

Table 23. Arm Control Interface - Fields and Buttons

Fields/Buttons	Description
Input Type (Wired)	This field is used to identify which inputs on an ACI are EMG sensors. The possible values are: <ul style="list-style-type: none"> • None • CH 1 • CH 2 • CH 3 • CH 4
Refresh Discovered Device List	Updates the list of discovered devices.
Discovered Devices	Displays list of discovered devices.

Wired ACIs

- If configuring a wired ACI Module, select **Wired** from the **Comm Mode** drop down menu. The Module number (1-4) will be the Module ID assigned to the wired ACI device.
- Identify any EMG Channels from the **Input Type** drop down list.
Configuring wired ACI modules unlocks EMG specific configuration options.

Wireless IMUs

- If configuring a wireless IMU, select **Wireless IMU** from the **Comm Mode** drop down menu and right or left IMU from the **Input Type** drop down menu.
- Click the **Refresh Discovered Device List** button to search for wireless IMUs.
- Drag and drop the selected device from the Discovered Devices list into the appropriate “Set #1” or “Set #2” **Wireless Device** box.

NOTICE

If configuring the system to have two sets of IMUs, be sure to clearly label each set of IMUs for the client.

Configuring a New ACI for the First Time

To configure a new ACI perform the following steps:

NOTICE

Assigning an ACI Module ID is only required if more than one ACI Module is being used. Note that all ACI Modules are shipped with a default ID of 1. In almost every case, the ACI should be assigned to Module 1 in Step 3.

1. Click the **Configure Module ID** button.

The Configure Wired ACI Module ID configuration screen opens. See [Figure 122](#).

Figure 122. Configure Wired ACI Module ID

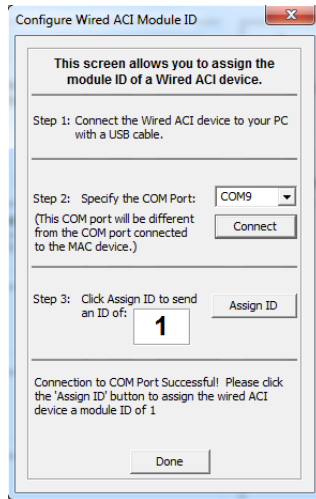

2. To assign the Module ID to the wired ACI device, first remove the label on the ACI covering the USB port, then connect the wired ACI device to your computer using a USB cable.
3. Click **Connect** to automatically detect and specify the COM port associated with the connected ACI.
4. Click the Assign ID button.

The Configure Wired ACI Module screen will state you have successfully assigned the wired ACI device an ID. This ID will automatically match the Module number you have already assigned the ACI in Step 3. See [Figure 123](#).

Figure 123. Successful Assignment of Wired ACI Device

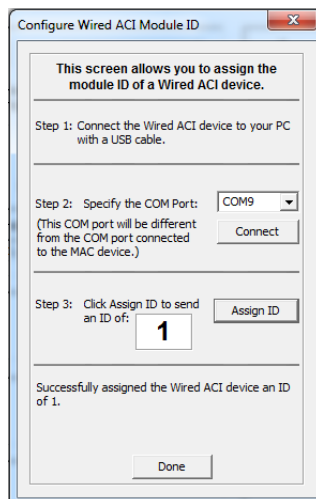

5. Click **Done**.

NOTICE

Once you have completed configuring the ACI module ID you need to ensure the USB port on the ACI is covered. Locate the label that covers the port in the materials kit and apply the label over the port. Covering the port is required to maintain the IP52 rating for the arm system.

Saving the ACI Configuration

To save the ACI configuration perform the following steps:

1. After completing ACI assignments click the **Apply Changes to Arm** button which will be illuminated in blue.

You will be prompted to power cycle the hardware. See [Figure 124](#).

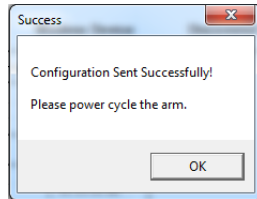
Figure 124. Power Cycle the Arm

2. Turn **OFF** the arm by pressing the ON/OFF button.
The power LED, next to the ON/OFF button, is turned **OFF** when power is off.
3. Turn **ON** the arm by pressing the ON/OFF button and holding it down until the power LED next to the ON/OFF button lights blue.
4. Click **OK**.

Understanding Thresholds and Gains

Thresholds and gains are two terms used in configuring the arm. These terms are described below.

Thresholds

A threshold is the signal level which specifies the point at which the signal commanded by the client is translated into motion or switching command by the arm. Upper and Lower Thresholds in the PI are represented by a pair of horizontal bars on the vertical scale in the configuration screen.

Gains

Gain is the amplification or scaling factor of the input signal. Gain is calculated as the ratio of output over input. When you adjust the gain using the gain dial, you are changing how the arm responds to a user input signal.

Setting Joint or Motion Speed Limits

When setting joint or motion speed limits you need to note the following:

- Mobius Bionics recommends that clients **NOT** watch the Prosthetist Interface configuration screens while configuring the arm. Allowing the client to watch the screens prompts them to respond to the signal level intensity by visual response. This can interfere with the clients response of inputs to outputs and affect their comfortable exertion levels.
- Reassess the configuration based on client comfort throughout the configuration process.

Input Gains

When setting Input Gains note the following:

- Mobius Bionics recommends an IMU range of motion of +/- 35 degrees from zero reference. Note that any client inputs above 45 degrees will be ignored.
- Set input gains based on comfortable exertion levels.
- The input gains should be adjusted so that the client can reach 100% input signal at comfortable exertion levels.

NOTICE

Performing the steps above for Input Gains caps the maximum input signal at these exertion levels.

Input Thresholds

When setting Input Thresholds note the following:

- Start with an input threshold setting of 15 to 20 above the resting signal level when the axes are configured independent or coupled.
- Only decrease these settings as the client develops proficiency in using the arm.

Output Gains

The output signal level represents a fraction of the maximum joint speed the client is allowed to use. The output gain is the final control you should use to define the output speed.

When setting Output Gains note the following:

- Adjust the output gains so that the output signal at the client's comfortable maximum exertion level produces the desired joint or motion output speed.
- Mobius Bionics recommends starting with an output signal level of 30 to 50%.
- Only increase these settings as the client develops proficiency in using the arm.

Step 4: Configure Inputs

To configure the IMUs you must select the Activation Channel and set the Thresholds and Gains for the left IMU anterior/posterior, left IMU medial/lateral, right IMU anterior/posterior, and right IMU medial/lateral. If you have configured the client's system to have two sets of IMUs, these settings will apply to both sets.

NOTICE

Prior to configuring the inputs you need to verify that the input signals are functioning properly by viewing the View Input Signals screen. See [Viewing Input Signals](#).

To configure the IMUs perform the following steps:

1. In the PI main screen click the **Step 4: Configure IMUs** button.
The IMU Setup screen opens. See [Figure 125](#) and [Table 24](#) for more information.

Figure 125. Step 4: Configure Inputs

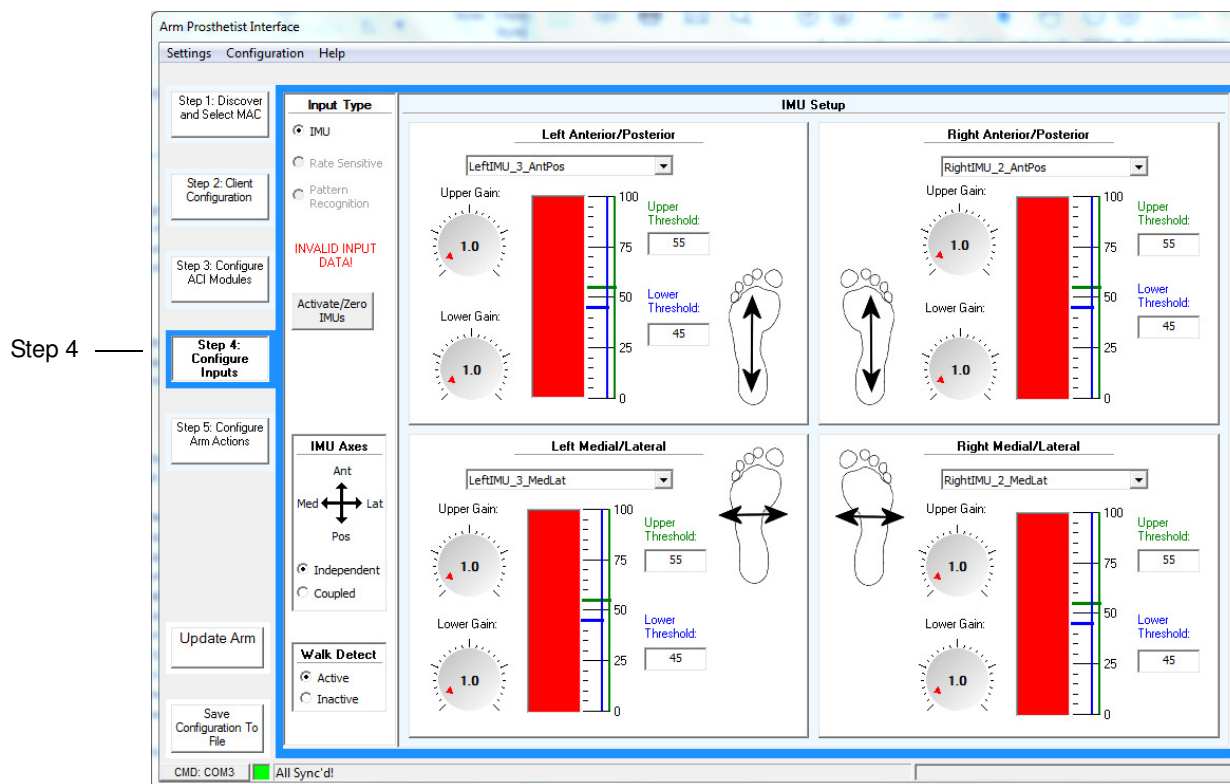

NOTICE

The full red bar, as shown in [Figure 125](#), is an indication that the IMUs have not been zeroed. After zeroing the IMUs the red bar will be displayed as shown in [Figure 126](#).

Table 24. IMU Setup - Fields and Buttons

Fields/Buttons	Description
Input Type	The type of input used to control the arm. The selections on the screen are: <ul style="list-style-type: none"> • IMU • Rate Sensitive • Pattern Recognition NOTE: Selections that are not available are grayed out.
Activate/Zero IMUs	Activates and zeros the IMUs.
Independent	Allows output of only the intended command axes with the greater signal intensity on an IMU.
Coupled	Allows for simultaneous output of both axes of an IMU.
Walk Detect	Enables (active) or disables (inactive) walk detect. Walk detect ignores commands from the IMU when the client is walking.

2. Select the corresponding motion for the correct IMU as indicated in the IMU Setup screen.
The input level should hover or “zero” somewhere around the midpoint of the scale. If it does not, perform the following to “re-zero” the IMUs:
 - a. Have the client stand with the IMUs in the desired zero position (usually feet flat on the floor).
 - b. Press the **Activate/Zero IMUs** button. See [Figure 126](#).

Figure 126. Activate/Zero IMUs

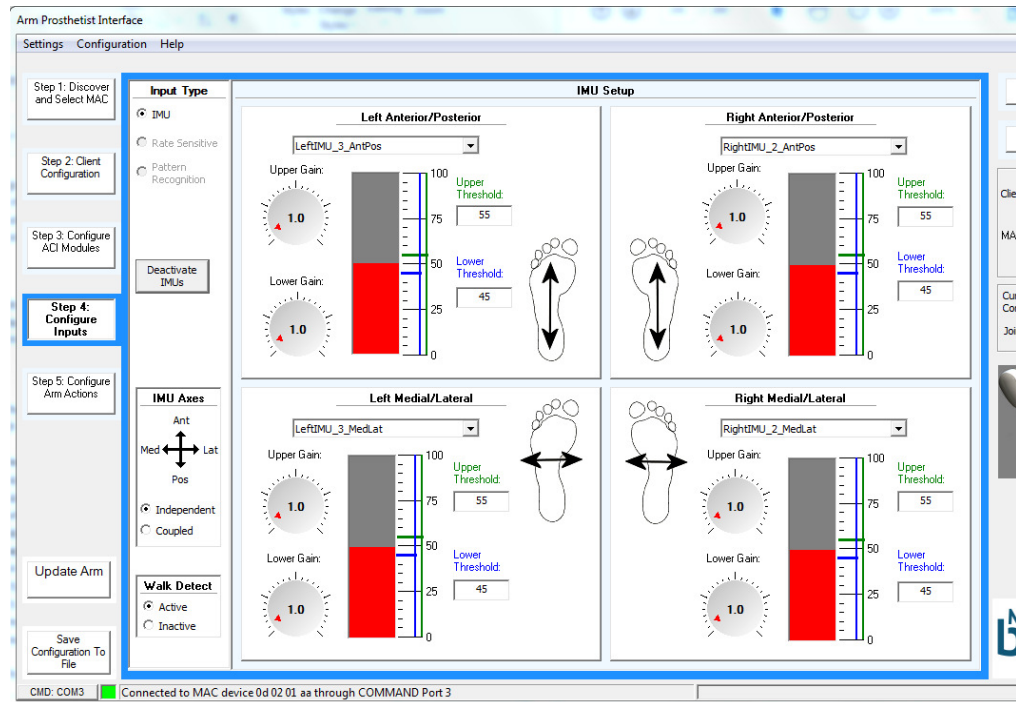

NOTICE

The client should be standing during IMU configuration as there is less freedom of movement when the client is bearing weight on their feet.

3. Communicate and demonstrate to your client that the IMUs, mounted on each foot, function by measuring the pitch (anterior/posterior movements) and roll (medial/lateral movements) of the client's foot.
4. Configure the Upper and Lower Gains for the Left IMU.

Adjust the Upper and Lower Gain dials so that full signal is displayed on the bar graph when the client pitches and rolls the IMU at a comfortable maximum position.

5. Configure the Thresholds for the left IMU.

Start with an input threshold setting of 15 to 20 above the resting signal level and the IMU axes configured to coupled.

When configuring Thresholds in a coupled configuration the goal is to set thresholds to prevent unintended crosstalk of pitch and roll commands while making the activation range as symmetrical as possible in the coupled movement directions (anterior/posterior and medial/lateral). This is accomplished by:

- a. Setting the Anterior and Posterior Thresholds such that Medial and Lateral movements do not cause the Anterior/Posterior signal level to cross the thresholds and cause unintended motions.

Step 5: Configure Arm Actions

Configuring Arm Actions allows you to configure arm and hand control and well as selected grips.

To configure the arm actions perform the following steps:

1. In the PI main screen click the **Step 5: Configure Arm Actions** button.
The Arm Action screen opens. The Arm Action screen changes based on the type of arm configuration (RC, HC, SC) selected in Step 2. See [Figure 127](#) and [Table 25](#) for more information.

NOTICE

Note that the Arm Action screen will change based upon the type of arm configuration selected in **Step 2**.

Figure 127. Step 5: Configure Arm Actions (SC Arm Shown)

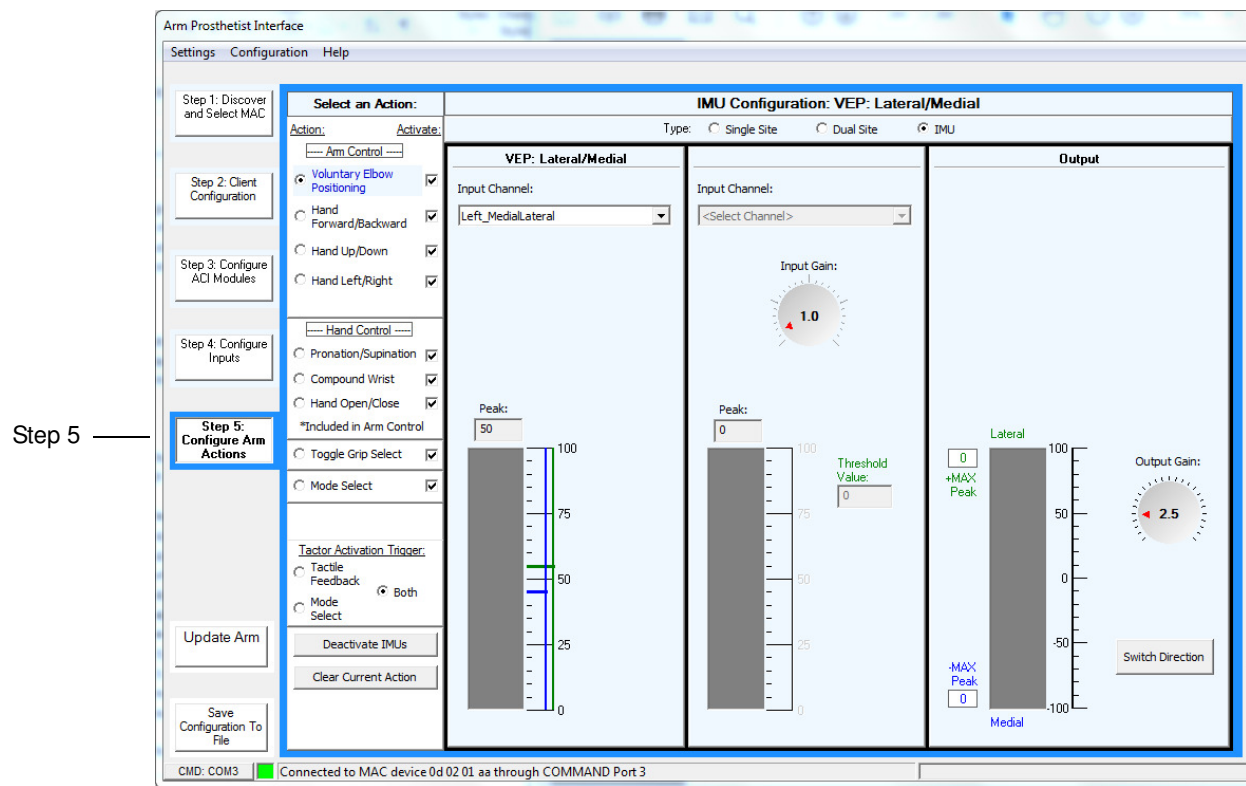

Table 25. Configurable Arm Actions

Control	Action	Description
Arm Control (SC Arm Only)	Voluntary Elbow Positioning	Configures the medial/lateral positioning of the elbow. This moves the elbow in space medially towards the center of the client's body or laterally away from the client's body by rotating the elbow about an axis. This axis is between the shoulder and the current hand position.
	Hand Forward/Backward	Configures moving the hand forward or backward.
	Hand Up/Down	Configures moving the hand up or down.
	Hand Left/Right	Configures moving the hand left or right.
Arm Control (HC Arm Only)	Humeral Rotation	Configures moving the humeral rotator.
	Elbow Flexion/Extension	Configures moving the elbow.
Hand Control	Pronation/Supination	Configures the rotation of the wrist. Pronation is the internal rotation resulting in the palm moving posteriorly or down. Supination is the external rotation resulting in the palm moving anteriorly or up.
	Compound Wrist	Configures the wrist flexion, wrist extension, ulnar deviation, and radial deviation of the wrist.
	Hand Open/Close	Configures the opening and closing of the hand.
	Include in Arm Control	Allows you to configure up to three hand actions to be performed in Arm control.

Table 25. Configurable Arm Actions

Control	Action	Description
Toggle Grip Select	Selectable Grip — Activates one or more grips from the Selectable Grips configuration box.	<p>Toggled Grips = Allows you to select a grip by inserting a check next to the grip.</p> <p>The possible grips are:</p> <ul style="list-style-type: none"> • 1 = Power Grip • 2 = Tool Grip • 3 = Fine Pinch Grip Closed • 4 = Fine Pinch Grip Open • 5 = Lateral Pinch Grip • 6 = Chuck Grip
Mode Select	Delay — Sets the delay for the mode select from the Delay configuration box	<p>Turn Off Delay = The amount of time, in seconds, the client needs to hold a command in order to put the arm into Standby mode.</p> <p>InterActivation Delay = The amount of time between commands before the next command is recognized.</p>
Tactor Activation Trigger	Tactile Feedback	Provides feedback as to how much pressure is applied through the arm's fingers.
	Mode Select	Provides a pulsed feedback when changing arm modes.
	Both	Provides both tactile feedback and mode select feedback to the client.
Activate/Zero IMUs	Activates/Deactivates and Zeros IMUs	Clicking this button activates the IMU and resets the IMU to the neutral or zero position. When you activate the IMU, this button changes to Deactivate.
Clear Current Action	NA	Erases the settings for the current selected action.

Selecting and Activating an Action

To select, configure, and activate an action perform the following steps:

1. Select the action you want to configure.
When you click the action the dynamic configuration screen changes for that action.
2. Configure the action using the dynamic configuration screen.
3. Once you have configured the action, activate the action by clicking the **Activate** check box next to the action and click the **Update Arm** button.
If the Activate check box is already checked, do not click it again. This will deactivate the action.

NOTICE

Note that when you un-click the Activate check box the action is not deleted, it is just deactivated. To activate the action, click the Activate check box next to the action.

Configuration Screens - Arm Actions

When you click the **Configure Action** button the configuration screen for the selected arm action is displayed. The configuration screen sets the threshold and gain and is similar to the process performed in **STEP 4**. See [Figure 128](#) and [Table 26](#) for more information.

NOTICE

You may need to work through the configuration process with the client a couple of times to let them experiment with different configurations until they settle on one setup that is intuitive and is most easily controlled.

NOTICE

When you select an IMU for a particular action, changing the input gains and thresholds requires returning to the IMU configuration. See [Step 4: Configure Inputs](#). If, after configuring the action, the arm moves due to crosstalk of the pitch and roll commands, the thresholds should be increased until the unintended motion stops.

Figure 128. Example Configure Action Screen - Toggle Grip Select

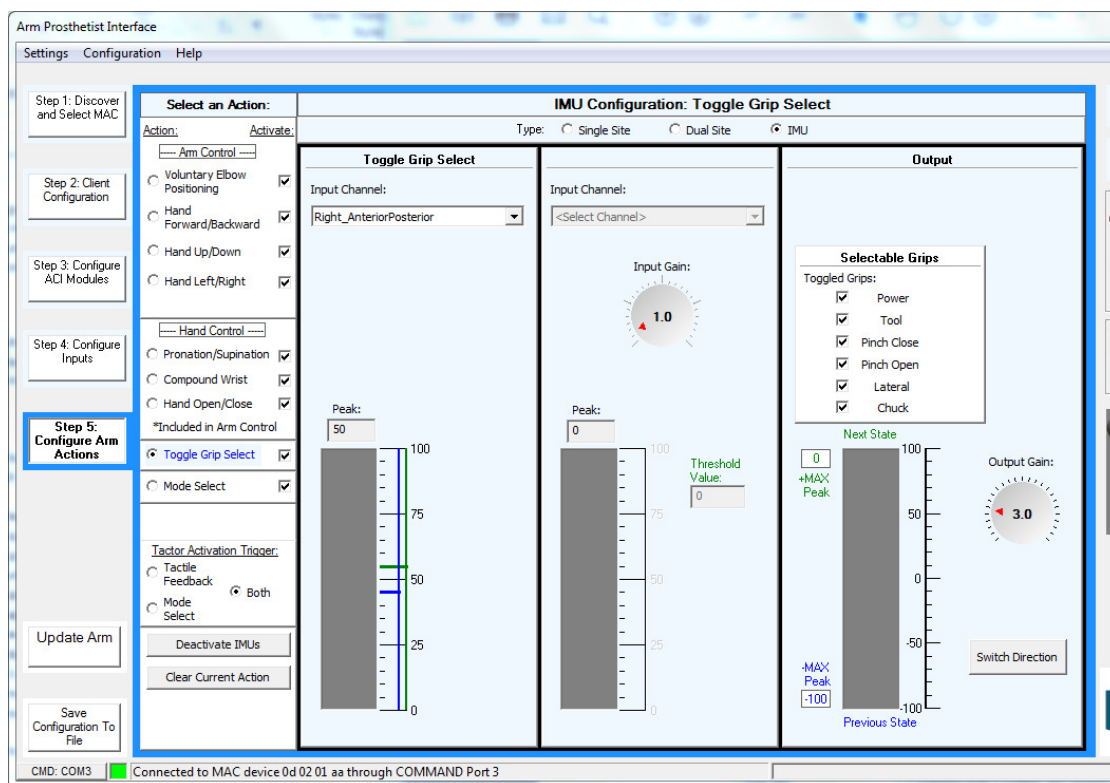

NOTICE If you remove a grip in Toggle Grip Select while that grip is currently selected, that grip will remain selected until you toggle out of the grip.

Table 26. Configure Actions Settings Glossary

Setting	Description
Single Site	Configures both positive and negative direction motion in a joint with a single channel that provides for both positive and negative signal levels, such as a linear transducer.
Dual Site	Configures both a positive and negative direction motion in a joint using two separate channels each with unique gains and thresholds.
IMU	Configures an existing IMU channel for both the positive and negative direction motion in a joint.
Input Channel	An input signal source, connected to a specific type of sensor the client uses to signal control intent.

Table 26. Configure Actions Settings Glossary

Setting	Description
Input Gain	For Single Site and Dual Site inputs, this should be adjusted so that the client can reach 100% input signal at a comfortable exertion level.
Threshold Value	Input signals below this level are ignored by the system.
Select Activation Mode (Single Site only)	This parameter selects how the system reacts to command signals when the system transitions from Standby to Hand or Arm (if applicable) modes. The Active Zero option allows you to set a “zero” point at a selected level of the input signal. Changes relative to the “zero” of the input signal are treated as command inputs. The Conventional option turns off this feature in single site inputs. Active Zero is built into IMU input functions, and can be selected for Single Site inputs, but not Dual Site inputs. Note that the Active Zero function of the IMUs cannot be shut off.
Output Gain	Allows you to increase or decrease the amount of output gain in order to achieve an ideal response after you have properly set up the input gains. This effectively sets the velocity response of the joint being configured.
Switch Direction	Allows you to change the direction of movement that occurs when an input is active.
Velocity Control	Allows you to configure the controls in velocity mode where the velocity of the joint is controlled based on how hard the client presses on the sensor. This control is similar to using a joystick.
Position Control	Allows you to configure the controls in position mode where the joint is controlled to a desired position commanded by the client. This control is similar to using a mouse or a touchpad.

Go to each appropriate Action and configure settings according to what the client wants (the process is similar to the steps used in **Step 4**). You may go through this process a couple of times to let the client experiment with different configurations until they settle on one setup that is intuitive to them and is most easily controlled.

Tool Tips and Keyboard Shortcuts

As you scroll over specific areas within the configuration screens tool tips will pop up. These tips provide helpful information on configuring the arm. See [Figure 113](#) for a tool tip example. When you scroll over the VRE Image Control keys a tool tip pops up providing you with the keyboard shortcut for that movement.

Figure 129. Example - Tool Tip

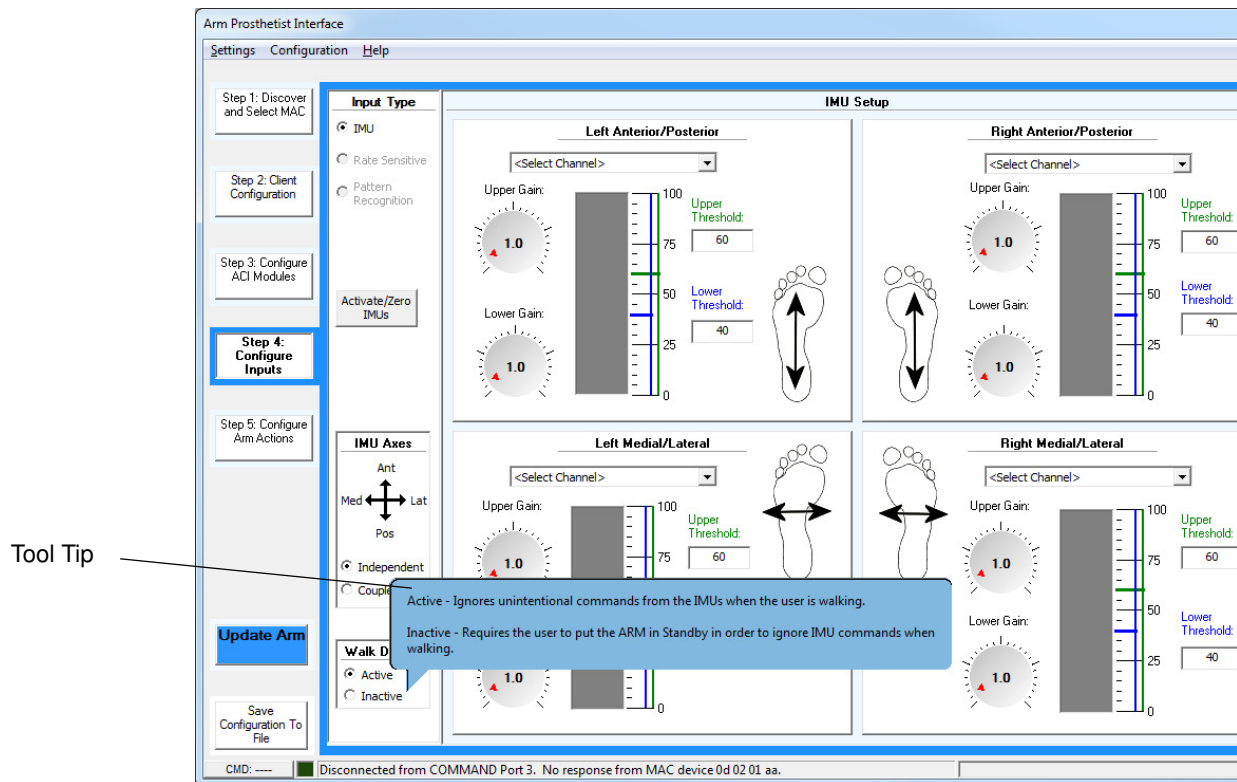

What's Next

The next step is to check and confirm the arm's configuration using the Virtual Reality Environment (VRE) and View Input Signals. The VRE allows the client to practice moving the arm using the selected control scheme. The View Input Signals allows you to view channel signals. For detailed information on the Virtual Reality Environment and View Input Signals see [Chapter 12, "Virtual Reality Environment and Viewing Input Signals"](#).

Troubleshooting

The following tables provide solutions to solving problems with the arm.

Table 29. Troubleshooting - Try This First

TRY THIS FIRST	These basic tips may help you quickly solve problems with the arm:
	<ol style="list-style-type: none"> 1. Put the arm into Standby Mode. 2. Check and secure the IMUs on your feet. 3. Take the arm out of Standby Mode.
	<ol style="list-style-type: none"> 1. Power the arm off. 2. Shake the IMUs to wake them. Look for the blinking blue LEDs. 3. Make sure all cables are securely connected. 4. Put your feet flat on the ground 5. Power the arm on.

See the tables below to help you in troubleshooting problems with the Arm System:

- [Table 30, Troubleshooting - Wrist Display and System Faults](#)
 - Use this table for help when Wrist Display LEDs are on or flashing
- [Table 31, Troubleshooting - Arm Function](#)
 - Use this table for help with moving the arm or changing grips
- [Table 32, Troubleshooting - Power and Battery Charging](#)
 - Use this table for help with powering the arm on and charging batteries
- [Table 33, Troubleshooting - Arm and PI Computer Communication](#)
 - Use this table for help with arm to PI computer communication problems

If the solutions in these troubleshooting tables do not solve the problem with the arm, contact Technical Support. See [Contacting Technical Support](#).

Table 30. Troubleshooting - Wrist Display and System Faults



Problem	Cause	Solution
System Fault Icons Blinking Fault Code: 3 	IMU not awake	<ol style="list-style-type: none"> 1. Power the arm off 2. Shake the IMUs to wake them 3. Power the arm on
	IMU battery low	<ol style="list-style-type: none"> 1. Power the arm off 2. Shake the IMU to check the IMU battery charge level and charge if necessary 3. Power the arm on
	Arm trying to talk to wrong set of IMUs (if two sets are configured)	<ol style="list-style-type: none"> 1. Power the arm off 2. Shake both sets of IMUs to wake them 3. Power the arm on 4. If no fault, the arm is talking to the IMUs that are blinking blue
	Ham radios, walkie talkies, theft detectors, or metal detectors are affecting the arm	<ol style="list-style-type: none"> 1. Power the arm off 2. Move the arm at least 0.5 m (20 inches) away from any ham radios, walkie talkies, theft detectors, or metal detectors 3. Power the arm on
System Fault Icons Blinking Fault Code: 36 	ACI not talking to arm	<ol style="list-style-type: none"> 1. Power the arm off 2. Check and tighten all system cables, and replace any damaged cables 3. Power the arm on
	ACI failure	<ol style="list-style-type: none"> 1. Power the arm off 2. Replace the ACI 3. Power the arm on and set the ACI module ID if necessary
	Tactor failure	<ol style="list-style-type: none"> 1. Power the arm off 2. Replace the Tactor 3. Power the arm on

Table 30. Troubleshooting - Wrist Display and System Faults

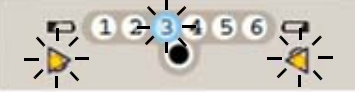

Problem	Cause	Solution
<p>System Fault Icons Blinking Fault Codes: 6, 456</p> 	<p>Client configuration invalid</p>	<ol style="list-style-type: none"> 1. Load a configuration from a file into PI 2. Update the arm 3. Power the arm off 4. Power the arm on
<p>System Fault Icons Blinking Fault Codes: 25, 26, 34, 256</p> 	<p>Arm motors warm</p>	<ol style="list-style-type: none"> 1. Power the arm off 2. Move to a cooler location if possible 3. Wait 15 minutes 4. Power the arm on
<p>System Fault Icons Blinking Fault Code: 2346</p> 	<p>Shoulder mount angles invalid</p>	<p>Zero the shoulder. See <i>Zero the Shoulder (if fitting an SC arm)</i>.</p>
<p>System Fault Icons Blinking Fault Code Not Listed</p>		<p>Contact Technical Support. See <i>Contacting Technical Support</i>.</p>

Table 30. Troubleshooting - Wrist Display and System Faults

Problem	Cause	Solution
<p>Low Battery Icon On</p> 	<p>Battery is low</p>	<ol style="list-style-type: none"> 1. Replace the external battery in the holster with a fully charged battery. 2. Plug the AC Adapter into the forearm charging port
	<p>External battery not connected</p>	<ol style="list-style-type: none"> 1. Check that the external battery is properly seated in the holster 2. Check and tighten the cables between the arm and the holster, and replace any damaged cables if necessary
<p>Grip Select LEDs Sweeping</p> 	<p>IMU not talking to arm</p>	<p>Shake the IMUs to wake them</p>
	<p>IMU battery is low</p>	<p>Charge the IMUs</p>
	<p>Arm trying to talk to wrong set of IMUs (if two sets are configured)</p>	<p>While the LEDs are still sweeping, press the wrist display button</p>
	<p>Ham radios, walkie talkies, theft detectors, or metal detectors are affecting the arm</p>	<p>Move the arm at least 0.5 m (20 inches) away from any ham radios, walkie talkies, theft detectors, or metal detectors</p>

Table 30. Troubleshooting - Wrist Display and System Faults

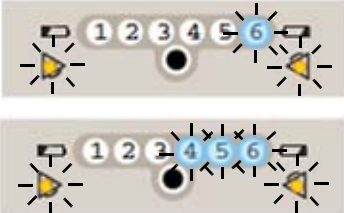
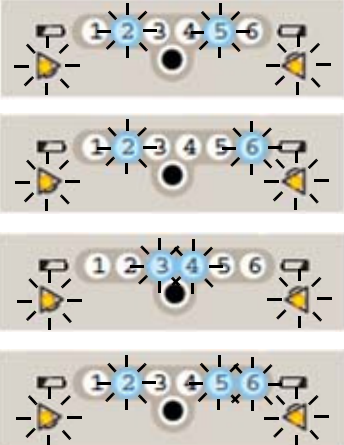
Problem	Cause	Solution
Arm Mode LED Blinking 	Walk Detect	<ol style="list-style-type: none"> 1. Stop walking 2. Put your feet flat on the ground 3. Check that the Arm Mode LED has stopped blinking
	IMU tilted too far	<ol style="list-style-type: none"> 1. Put the arm into Standby Mode 2. Check and secure the IMUs on your feet 3. Put your feet flat on the ground 4. Take the arm out of Standby Mode
	Thresholds or gains need adjustment	<ol style="list-style-type: none"> 1. Put the arm into Standby Mode 2. Ask the client to be at a resting position 3. Use PI to check that all non-IMU inputs are below the threshold 4. Adjust the input device thresholds or gains as necessary 5. Update the arm 6. Take the arm out of Standby Mode
	Input device not working	<ol style="list-style-type: none"> 1. Power the arm off 2. Replace the input device 3. Power the arm on 4. Use PI to check the thresholds and gains for the new input device and adjust if necessary

Table 31. Troubleshooting - Arm Function

Problem	Cause	Solution
Arm moving without command	IMU zero position changed	<ol style="list-style-type: none"> 1. Put the arm into Standby Mode 2. Check and secure the IMUs on your feet. 3. Put your feet flat on the ground 4. Take the arm out of Standby Mode
	Sweat near EMGs	<ol style="list-style-type: none"> 1. Put the arm into Standby Mode 2. Wipe the sweat from the EMG electrode and skin with a dry cloth 3. Take the arm out of Standby Mode
	Ham radios or walkie talkies are affecting the arm	<ol style="list-style-type: none"> 1. Put the arm into Standby Mode 2. Move the arm at least 0.5 m (20 inches) away from any ham radios or walkie talkies 3. Take the arm out of Standby Mode
Arm not moving	Arm is in Standby Mode	Put the arm into Hand Mode
	Arm is off	<ol style="list-style-type: none"> 1. Shake the IMUs to wake them 2. Power the arm on
	Arm is faulted	See Table 30, Troubleshooting - Wrist Display and System Faults .
	Input device not connected	<ol style="list-style-type: none"> 1. Power the arm off 2. Check and tighten all connections at the ACI 3. Power the arm on
Cannot change Modes	Input device not connected	<ol style="list-style-type: none"> 1. Power the arm off 2. Check and tighten all connections at the ACI 3. Power the arm on
	Input device not working	<ol style="list-style-type: none"> 1. Power the arm off 2. Replace the input device 3. Power the arm on 4. Use PI to check the thresholds and gains for the new input device and adjust if necessary

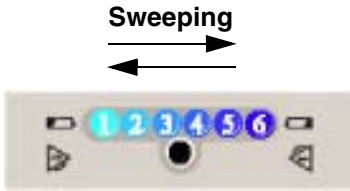
Table 31. Troubleshooting - Arm Function

Problem	Cause	Solution
Cannot change grips	Hand is not fully open	<ol style="list-style-type: none"> 1. Put the arm into Hand Mode 2. Fully open the hand 3. Change grips
	Input device not working	<ol style="list-style-type: none"> 1. Power the arm off 2. Replace the input device 3. Power the arm on 4. Use PI to check the thresholds and gains for the new input device and adjust if necessary

Table 32. Troubleshooting - Power and Battery Charging



Problem	Cause	Solution
Arm does not power on	Internal battery too low	<ol style="list-style-type: none"> 1. Plug the AC Adapter into the forearm charging port 2. The charging status icon first blinks yellow for a few minutes. Wait until the charging status icon blinks blue. 3. Power the arm on
	External battery too low	<ol style="list-style-type: none"> 1. Replace the external battery in the holster with a fully charged one 2. Power the arm on
	External battery not connected	<ol style="list-style-type: none"> 1. Check that the external battery is properly seated in the holster 2. Check and tighten the cables between the arm and the holster 3. Power the arm on
Internal Battery Charging		
Charging Status Icon Blinking Yellow 	Internal battery charging paused	<ol style="list-style-type: none"> 1. Move the arm to a cooler location 2. Wait up to 2 hours. You can keep the arm on and the AC adapter connected while waiting. 3. Charging should continue on its own. If it does not, contact Technical Support. See <i>Contacting Technical Support</i>.

Table 32. Troubleshooting - Power and Battery Charging

Problem	Cause	Solution
Charging Status Icon On Solid Yellow 	Internal battery charging fault	Contact Technical Support. See <i>Contacting Technical Support</i> .
	AC adapter failure	Replace AC adapter
External Battery Charging		
Charging Dock Fault Status Blinking Yellow	Charging paused	<ol style="list-style-type: none"> 1. Wait up to 2 hours. You can keep the charging dock on and the battery in the charging dock while waiting. 2. Charging should continue on its own. If it does not, contact Technical Support. See <i>Contacting Technical Support</i>.
Charging Dock Fault Status On Solid Yellow	Charging fault	Contact Technical Support. See <i>Contacting Technical Support</i> .
IMU Charging		
IMU Yellow LED On Solid	Charging paused	<ol style="list-style-type: none"> 1. Wait up to 30 minutes. You can keep the charging pad on and the IMU on the charging pad while waiting. 2. Charging should continue on its own. If it does not, contact Technical Support. See <i>Contacting Technical Support</i>.
IMU Yellow LED Blinking	Self test failure	<ol style="list-style-type: none"> 1. Remove the IMU from the charging pad 2. Wait 5 seconds 3. Place the IMU on the charging pad 4. If the error persists, contact Technical Support. See <i>Contacting Technical Support</i>.
IMU LED off	IMU not talking to charging pad	<ol style="list-style-type: none"> 1. Clean the top of the charging pad. 2. Clean the bottom of the IMU. 3. Place the IMU, LED side up, on the charging pad's center circle.

If the solutions in these troubleshooting tables do not solve the problem with the arm, contact Technical Support. See *Contacting Technical Support*.

Table 33. Troubleshooting - Arm and PI Computer Communication

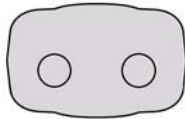
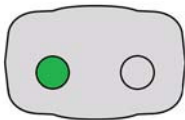
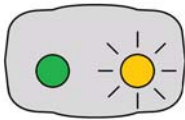
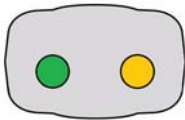
Problem	Cause	Solution
PI can't connect to arm and no LEDs on PC dongle 	Dongle failure	<ol style="list-style-type: none"> 1. Close the PI application 2. Remove the PC dongle from the USB port 3. Insert the PC dongle into the USB port 4. If no LEDs on PC dongle, replace the PC dongle 5. Open the PI application 6. Discover and select MAC
PI can't connect to arm and <ul style="list-style-type: none"> • PC dongle green LED on solid • PC dongle yellow LED off 	Dongle communication failure	<ol style="list-style-type: none"> 1. Close the PI application 2. Remove the PC dongle from the USB port 3. Insert the PC dongle into the USB port 4. Open the PI application 5. Discover and select MAC
PI can't connect to arm and <ul style="list-style-type: none"> • PC dongle green LED on solid • PC dongle yellow LED flashing 	Dongle communication failure	<ol style="list-style-type: none"> 1. Close the PI application 2. Remove the PC dongle from the USB port 3. Insert the PC dongle into the USB port 4. Open the PI application 5. Discover and select MAC
PI can't connect to arm and <ul style="list-style-type: none"> • PC dongle green LED on solid • PC dongle yellow LED on solid 	Dongle communication failure	<ol style="list-style-type: none"> 1. Close the PI application 2. Remove the PC dongle from the USB port 3. Insert the PC dongle into the USB port 4. Open the PI application 5. Discover and select MAC

Technical Specifications

This appendix provides technical specifications for the LUKE arm, battery, AC Adapter and charging pad.

Topics in this Appendix include:

- *Arm Specifications*
- *Battery Specifications*
- *AC Adapter Specifications*
- *Charging Pad Specifications*
- *Arm Radio Specifications*

Arm Specifications

Table 34. Arm System Specifications

Parameter	Explanation
Compliance	The LUKE arm system complies with IEC 60601-1:2005
Power Type	The arm is internally powered when under battery power
Designation	The arm is designated Class II when plugged into the AC Adapter
Parts Type	The arm and all body worn accessories are Type BF applied parts

Table 35. Operating Environmental Range

Parameter	Range
Operating Temperature	<ul style="list-style-type: none"> • 10 °C to 40 °C (50 °F to 104 °F) with no degradation in performance • -10 °C to 50 °C (14 °F to 122 °F) with reduced arm speed and/or load capacity
Humidity	15% to 93% (non-condensing)
Pressure	700 hPa to 1060 hPa
Arm and body worn Mobius Bionics supplied accessories IP rating	IP52
IMU IP Rating	IP57

NOTICE

When using the arm continuously in a hot environment (40 °C, 104 °F) and while charging the internal battery, portions of the forearm and upper arm (if applicable) could reach temperatures of 54 °C - 57 °C (130 °F - 135 °F), when evaluated as directed in IEC 60601-1: 2005-12.

Table 36. Transport and Storage Environmental Range

Parameter	Range
Storage Temperature (excluding battery)	-25 °C to 70 °C (-13 °F to 158 °F)
Humidity	15% to 93% (non-condensing)
Pressure	700 hPa to 1060 hPa

Table 37. Service Life Specifications

Part	Service Life
Arm	Expected to function for up to three (3) years with an 18 month service interval
Internal and External Batteries	Expected to provide at least 80% of new capacity for up to a year of typical use
IMU Battery	Expected runtime is at least 18 hours for up to a year of use
AC Adapter and Charging Pad	Expected to function for up to three (3) years
External Battery Holster and External Battery Charging Dock	Expected to function for up to three (3) years
ACI and Cables	Expected to function for up to three (3) years

Table 38. Mass of Arm Configurations

Arm Configuration	Mass
Shoulder Configuration (SC)	4.7 kg
Humeral Configuration (HC)	3.4kg
Radial Configuration (RC)	1.4 kg

Table 39. Dimensions of Arm Configurations

Arm Configuration	Dimensions
Shoulder Configuration (SC)	See Figure 138
Humeral Configuration (HC)	See Figure 139
Radial Configuration (RC)	See Figure 140

Figure 138. Dimensions of Shoulder Configuration (In Centimeters)

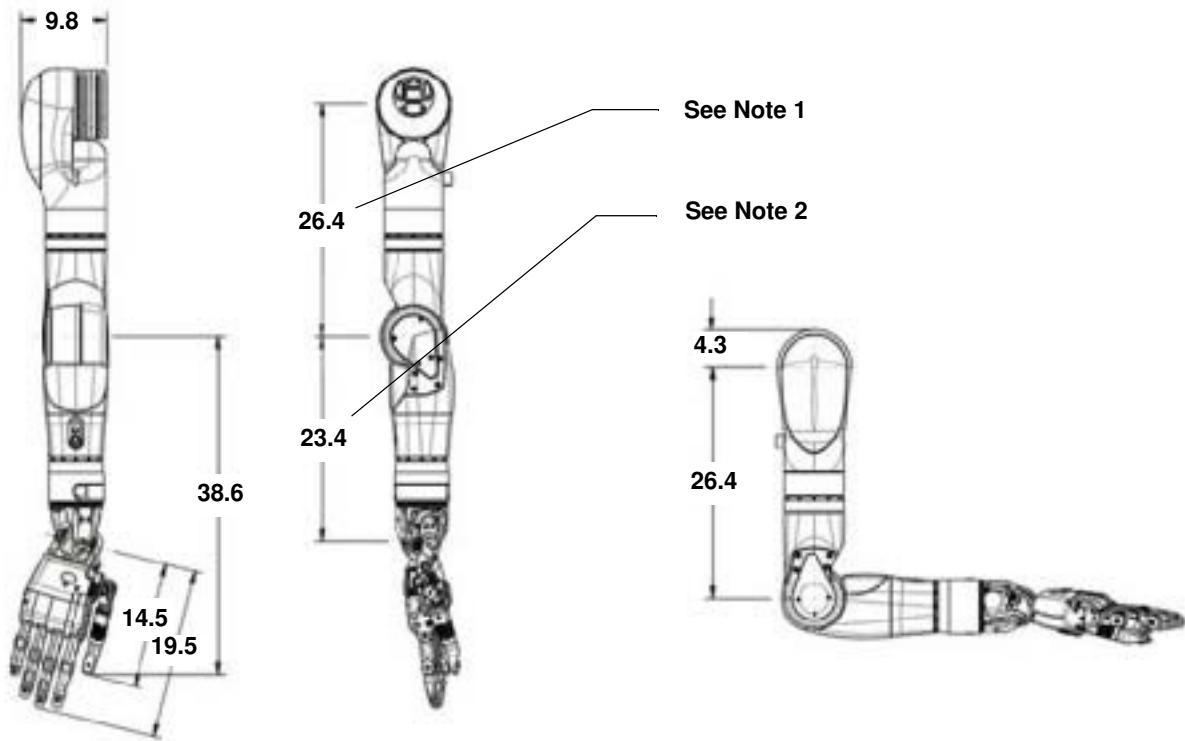

- **Note 1:** Upper arm length configurations in 1 cm increments from 26.4 cm to 31.4 cm. See *Arm Configurations*.
- **Note 2:** Forearm length configurations in 1 cm increments from 23.4 cm to 27.4 cm. See *Arm Configurations*.

Figure 139. Dimensions of Humeral Configuration (In Centimeters)

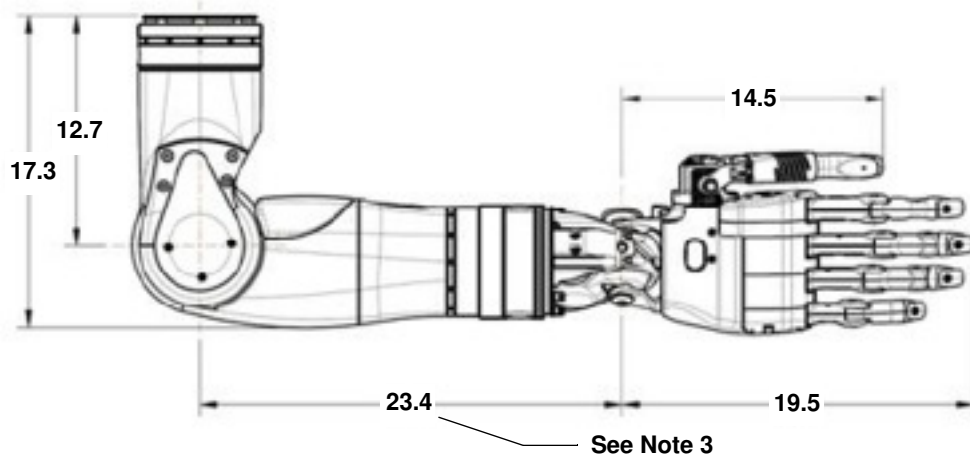

- **Note 3:** Forearm length configurations in 1 cm increments from 23.4 cm to 27.4 cm. See *Arm Configurations*.

Figure 140. Dimensions of Radial Configuration (In Centimeters)

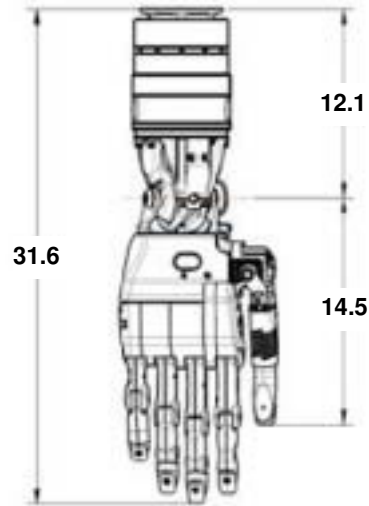

Battery Specifications

Table 40. Battery Charge and Operation Times

Arm System Configuration	Battery Type	One (1) Hour Charge Operation Time ¹	Full Charge ² Operation Time ¹
SC/HC	Internal Battery	One (1) Hour	Two (2) Hours
SC/HC	External Battery	Two (2) Hours	Five (5) Hours
RC	External Battery	Four (4) Hours	Ten (10) Hours
IMU	Not Applicable	Not Applicable	One (1) Day

NOTES:

1. Actual use time may vary from stated figures based on use patterns, battery age, and arm configuration. Contact Technical Support for additional information. See *Contacting Technical Support*.
2. See Chapter 9, “Installing, Connecting, and Charging the System Batteries” for charging time.

Table 41. Power Specifications - Internal Battery

Parameter	Range/Explanation
Battery Type	Lithium-Ion
Capacity	30 Watt-Hours
Charging time (approximate)	80% capacity in less than 2.0 hours
Storage Life	Three (3) months without recharging
Storage Temperature	Short Term (24 Hours Maximum): -25 °C to 70 °C (-13 °F to 158 °F) Long Term: -10 °C to 50 °C (14 °F to 122 °F)

Table 42. Power Specifications - External Battery

Parameter	Range/Explanation
Battery Type	Lithium-Ion
Capacity	74 Watt-Hours
Charging time (approximate)	80% capacity in less than 2.0 hours
Storage Life	Three (3) months without recharging
Storage Temperature	Short Term (24 Hours Maximum): -25 °C to 70 °C (-13 °F to 158 °F) Long Term: -10 °C to 50 °C (14 °F to 122 °F)

Table 43. Power Specifications - IMU Battery

Parameter	Range/Explanation
Battery Type	Lithium-Polymer
Capacity	190 mAh
Charging time (approximation)	80% capacity in less than 2.0 hours
Storage Life	Three (3) months without recharging
Storage Temperature	Short Term (24 Hours Maximum): -25 °C to 70 °C (-13 °F to 158 °F) Long Term: -10 °C to 50 °C (14 °F to 122 °F)

AC Adapter Specifications

Table 44. AC Adapter Specifications

Parameter	Range/Explanation
Input Voltage	100 VAC - 240 VAC
Input Frequency	50/60 Hz
Input Current	1.5 Amps
Operating Temperature	0 °C to 70 °C (32 °F to 158 °F)
Operating Humidity	10% to 95% RH, non-condensing
Storage Temperature	-40 °C to 80 °C (-40 °F to 176 °F)

Charging Pad Specifications

Table 45. Charging Pad Specifications

Parameter	Range/Explanation
Input Voltage	100 VAC - 240 VAC
Input Frequency	50/60 Hz
Current Rating	1 Amp Maximum
Transmit Frequency Range	100 kHz - 205 kHz
Transmit Power	<5 W
Protocol	Qi version 1.1, Wireless Power Consortium
Effective Range	10 mm or less
Wireless Security	Qi version 1.1
Quality of Service Provisions	<p>Any debris or clutter between the bottom of the IMU and the Charging Pad may prevent IMU charging. Any increase in the distance between the IMU and Charging Pad will increase communication interference. This interference, however, will not cause any incorrect data to be sent and will not cause any harm to the LUKE arm system.</p> <p>Loss or corruption of data between the IMU and Charging Pad for more than 2 seconds can result in the interruption of charging.</p> <p>In these cases, communication problems can usually be resolved by ensuring the top of the Charging Pad is clean and clear of clutter, the IMU is clean and its label is free of wrinkles, and that IMUs are placed label side down and placed as close as possible to the center of the charging pad targets.</p>

Arm Radio Specifications

Table 46. Arm Radio Specifications

Parameter	Range/Explanation
Transmit and Receive Frequency Range	2.4 - 2.5 GHz
Effective Radiated Power	<10 mW
Modulation	Direct Sequence Spread Spectrum per IEEE 802.15.4-2006
Protocol	Proprietary Frequency Hopping Communication Protocol
FCC Compliance	<p>This device complies with part 15 of the FCC Rules. Operation is subject to the following two conditions: (1) This device may not cause harmful interference, and (2) this device must accept any interference received, including interference that may cause undesired operation.</p> <p>Pursuant to FCC 15.21 of the FCC rules, changes not expressly approved by Mobius Bionics might cause harmful interference and void the FCC authorization to operate this product.</p> <p>This product complies with FCC OET Bulletin 65 radiation exposure limits set forth for an uncontrolled environment.</p>
Effective Range (Arm/IMU)	3 m or less
Effective Range (Arm/Dongle)	1 m or less
Wireless Security	Proprietary Frequency Hopping Communication Protocol

Table 46. Arm Radio Specifications (Continued)

Parameter	Range/Explanation
Quality of Service Provisions	<p>Interruption or corruption of communication between the Arm and IMUs can lead to interruptions in arm motion. Interruption of communication for more than 2 seconds may lead to the system reverting to Standby mode. Interruption of communication for more than 8 seconds results in the system declaring a fault.</p> <p>Common consumer electronic devices that transmit in the same frequency band used by the LUKE arm system may prevent the Arm and IMUs from communicating. Microwave ovens, Bluetooth® devices, Wi-Fi® networks and 2.4 GHz cordless phones, when transmitting or receiving, can cause interruption of communication between the Arm and IMUs. During testing, the LUKE arm system experienced occasional communication interruptions in the presence of Bluetooth mice. It is likely that other devices operating in similar frequency ranges can have a similar effect. This interference, however, will not cause any incorrect data to be sent and will not cause any harm to the LUKE arm system.</p> <p>Some metal detectors and anti-theft detection systems at store exits transmit in the same frequency band used by the LUKE arm system. These devices can cause interruption of communication between the Arm and IMUs. Again, this interference will not cause any incorrect data to be sent and will not cause any harm to the LUKE arm system.</p> <p>In each of these cases, communication problems can usually be resolved by turning off or moving away from other RF transmitting devices.</p>



Manufacturers and Part Numbers

This appendix lists the Manufacturer and Part Numbers for LUKE arm types, accessories, and user inputs within the LUKE arm system.

Topics in this appendix include:

- *Hand and Finger Covers*
- *General Accessories*
- *User Inputs*
- *Optional Accessories*
- *External Cables*

LUKE Arms

Table 47. LUKE Arm Manufacturers and Part Numbers

Arm Type	Manufacturer	Part Number
SC (with Internal Battery)	Mobius Bionics	LU-105 A1-BCD
SC (without Internal Battery)	Mobius Bionics	LU-105 A2-BCD
HC (with Internal Battery)	Mobius Bionics	LU-103 A1-0CD
HC (without Internal Battery)	Mobius Bionics	LU-103 A2-0CD
RC	Mobius Bionics	LU-101 A2-00D
NOTES: <ul style="list-style-type: none">• A designates hand type. 1 = Right Hand, 2 = Left Hand• B designates upper arm length• C designates forearm length• D designates hand length		

Hand and Finger Covers

Table 48. Hand and Finger Cover Manufacturers and Part Numbers

Description	Manufacturer	Part Number
Hand Cover, Right	Mobius Bionics	LU-38012-001
Hand Cover, Left	Mobius Bionics	LU-38012-002
Nylon Tape for Securing Hand Cover	Mobius Bionics	LU-41091-001
Finger Cover, Thumb, Right	Mobius Bionics	LU-38013-001
Finger Cover, Thumb, Left	Mobius Bionics	LU-38013-002
Finger Cover, Index	Mobius Bionics	LU-38014-001
Finger Cover, Middle	Mobius Bionics	LU-38015-001
Finger Cover, Ring	Mobius Bionics	LU-38016-001
Finger Cover, Pinky	Mobius Bionics	LU-38017-001
Fingernail, Thumb	Mobius Bionics	LU-36352-001
Fingernail, Index	Mobius Bionics	LU-36434-001
Fingernail, Middle and Ring	Mobius Bionics	LU-36407-001
Fingernail, Pinky	Mobius Bionics	LU-36403-001
Screw, Fingernail, All Except Pinky	Mobius Bionics	LU-41005-20060
Screw, Fingernail, Pinky	Mobius Bionics	LU-41005-20050

General Accessories

Table 49. General Accessories Manufacturers and Part Numbers

Accessory	Manufacturer	Part Number
ACI	Mobius Bionics	LU-20264-001
ACI USB Port Cover	Mobius Bionics	LU-38021-001
External Battery Charging Dock	Mobius Bionics	LU-20272-001
External Battery Holster (without Power Button) ¹	Mobius Bionics	LU-20273-001
External Battery Holster (with Power Button) ²	Mobius Bionics	LU-20273-002
PC Dongle	Mobius Bionics	LU-20275-001
RC Battery Adapter ³	Mobius Bionics	LU-20311-001
External Battery	Mobius Bionics	LU-70154-001
AC Adapter	Mobius Bionics	LU-70214-001
<p>NOTES:</p> <p>1. Used with all arm types that have an internal battery.</p> <p>2. Used with all arm types that have no internal battery.</p> <p>3. Only used with RC arms.</p>		

User Inputs

NOTICE

The LUKE arm system has been evaluated with the following input signal sources.

Table 50. User Inputs Manufacturers and Part Numbers

Input	Manufacturer	Part Number
IMU	Mobius Bionics	LU-20260-001
Pressure Transducer	Mobius Bionics	LU-20276-001
EMG	Otto Bock	13E200
Linear Transducers	Otto Bock Liberating Technologies	9X50 LT01/LT02
Pressure Switch	Otto Bock	9X37
Rocker Switch	Otto Bock	9X25

Optional Accessories

Table 51. Optional Accessories Manufacturers and Part Numbers

Accessory	Manufacturer	Part Number
IMU Shoe Clips	Mobius Bionics	LU-40128-001
Tactor	Mobius Bionics	LU-20274-001
Tactor Mounting Clips	Mobius Bionics	LU-40130-001 LU-40176-001
Wireless Charging Pad ¹	Mobius Bionics	LU-70388-001
NOTES:		
1. Used to charge up to two IMUs.		

External Cables

Table 52. External Cable Manufacturers, Part Numbers, and Maximum Length

Cable	Manufacturer	Part Number	Maximum Length
ACI & Tactor Extension Cable	Mobius Bionics	LU-60068-0000	500 mm
External Battery Extension Cable	Mobius Bionics	LU-60072-0000	1000 mm
ACI Straight to Flat Ribbon Cable	Mobius Bionics	LU-60099-001	500 mm
1 Channel ACI Straight to Otto Bock 9E185 Cable	Mobius Bionics	LU-60100-000	300 mm
2 Channel ACI Straight to Otto Bock 9E185 Cable	Mobius Bionics	LU-60101-000	300 mm
ACI Right Angle to Flat Ribbon Cable	Mobius Bionics	LU-60103-001	500 mm
1 Channel ACI Right Angle to Otto Bock 9E185 Cable	Mobius Bionics	LU-60104-000	300 mm
2 Channel ACI Right Angle to Otto Bock 9E185 Cable	Mobius Bionics	LU-60105-000	300 mm
AC Adapter Line Cord, USA	Mobius Bionics	LU-70261-001	1830 mm
RC Arm Power & CAN Harness	Mobius Bionics	LU-60119-001	200 mm

⚠ WARNING

RISK OF DEATH OR SERIOUS HARM

The use of accessories, transducers, and cables other than those specified may result in increased emission or decreased immunity of the LUKE arm system.

Socket Fabrication Components

Table 53. Socket Fabrication Components

Description	Manufacturer	Part Number
RC Socket Adapter	Mobius Bionics	LU-20269-001
RC Socket Adapter Cable Hole Plug	Mobius Bionics	LU-38035-001
RC Socket Adapter Thread Protector	Mobius Bionics	LU-38033-001
HC Socket Adapter	Mobius Bionics	LU-20283-001
HC Socket Adapter Thread Protector	Mobius Bionics	LU-38034-001
SC Socket Adapter	Mobius Bionics	LU-37158-001
SC Socket Adapter Screws, M3 x 0.5, 6 mm Long, Flat Head	Mobius Bionics	LU-41003-30061
SC Bend Bracket	Mobius Bionics	LU-37156-001
SC Arm Mounting Screws, M4 x 0.7, 12 mm Long, Socket Head	Mobius Bionics	LU-41000-040121
Spanner Wrench	Mobius Bionics	LU-80203-001
Fitting Arm	Mobius Bionics	LU-20293-001
Form Shoulder	Mobius Bionics	LU-20305-001

Guidance and Manufacturer's Declaration

This Appendix details information on the electromagnetic environment and recommended spacing between portable and mobile RF communications equipment (transmitters) and the LUKE arm system.

Electromagnetic Environment

The LUKE arm system is intended for use in the electromagnetic environment specified in [Table 54](#) and [Table 55](#). The user of the LUKE arm system should assure that it is used in such an environment.

Electromagnetic Emissions

Table 54. Guidance and Manufacturer's Declaration - Electromagnetic Emissions

Emissions Test	Compliance	Electromagnetic Environment - Guidance
RF emissions CISPR 11	Group 1	The LUKE arm system uses RF energy only for its internal function. Therefore, its RF emissions are very low and are not likely to cause any interference in nearby electronic equipment.
RF emissions CISPR 11	Class B	The LUKE arm system is suitable for use in all establishments, including domestic establishments and those directly connected to the public low voltage power supply network that supplies buildings used for domestic purposes.

Electromagnetic Immunity

Table 55. Guidance and Manufacturer's Declaration - Electromagnetic Immunity

Immunity Test	IEC 60601 Test Level	Compliance Level	Electromagnetic Environment - Guidance
Electrostatic discharge (ESD) IEC 61000-4-2	+/- 6 kV contact +/- 8 kV air	+/- 6 kV contact +/- 8 kV air	Floors should be wood, concrete or ceramic tile. If floors are covered with synthetic material, the relative humidity should be at least 30%.
Electrical fast transient/burst IEC 61000-4-4	+/- 2 kV for power supply lines +/- 1 kV for input/output lines	+/- 2 kV for power supply lines +/- 1 kV for input/output lines	Mains power quality should be that of a typical commercial or hospital environment.
Surge IEC 61000-4-5	+/- 1 kV line(s) to line(s) +/- 2 kV line(s) to earth	+/- 1 kV line(s) to line(s) +/- 2 kV line(s) to earth	Mains power quality should be that of a typical commercial or hospital environment.
Voltage dips, short interruptions and voltage variations on power supply input lines IEC 61000-4-11	<5% U_T (>95% dip in U_T) for 0,5 cycle 40% U_T (60% dip in U_T) for 5 cycles 70% U_T (30% dip in U_T) for 25 cycles <5% U_T (>95% dip in U_T) for 5 s	<5% U_T (>95% dip in U_T) for 0,5 cycle 40% U_T (60% dip in U_T) for 5 cycles 70% U_T (30% dip in U_T) for 25 cycles <5% U_T (>95% dip in U_T) for 5 s	Mains power quality should be that of a typical commercial or hospital environment. If the user of the LUKE arm system requires continued operation during power mains interruptions, it is recommended that the LUKE arm system be powered from an uninterruptible power supply or a battery.
Power frequency (50/60 Hz) magnetic field IEC 61000-4-8	3 A/m	3 A/m	Power frequency magnetic fields should be at levels characteristic of a typical location in a typical commercial or hospital environment.
NOTE: U_T is the a.c. mains voltage prior to application of the test level.			

Table 55. Guidance and Manufacturer’s Declaration - Electromagnetic Immunity

Immunity Test	IEC 60601 Test Level	Compliance Level	Electromagnetic Environment - Guidance
<p>Conducted RF IEC 61000-4-6</p> <p>Radiated RF IEC 61000-4-3 (continued on next page)</p>	<p>3 Vrms 150 kHz to 80 MHz</p>	<p>3 Vrms 150 kHz to 80 MHz</p>	<p>Portable and mobile RF communications equipment should be used no closer to any part of the LUKE arm system, including cables, than the recommended separation distance calculated from the equation applicable to the frequency of the transmitter.</p> <p>Recommended Separation Distance:</p> <p>$d = 1.2\sqrt{P}$</p>
	<p>3 V/m 80 MHz to 2.5 GHz</p>	<p>10 V/m 26 MHz to 80 MHz</p>	<p>$d = 0.35\sqrt{P}$</p>
	<p></p>	<p>3 V/m 80 MHz to 460 MHz</p>	<p>$d = 1.2\sqrt{P}$</p>
	<p></p>	<p>10 V/m 460 MHz to 470 MHz</p>	<p>$d = 0.35\sqrt{P}$</p>
	<p></p>	<p>3 V/m 470 MHz to 690 MHz</p>	<p>$d = 1.2\sqrt{P}$</p>
	<p></p>	<p>20 V/m 690 MHz to 800MHz</p>	<p>$d = 0.18\sqrt{P}$</p>
	<p></p>	<p>20 V/m 800MHz to 965 MHz</p> <p>(continued on next page)</p>	<p>$d = 0.35\sqrt{P}$</p> <p>where P is the maximum output power rating of the transmitter in watts (W) according to the transmitter manufacturer and d is the recommended separation distance in meters (m).</p>

Table 55. Guidance and Manufacturer's Declaration - Electromagnetic Immunity

Immunity Test	IEC 60601 Test Level	Compliance Level	Electromagnetic Environment - Guidance
Radiated RF IEC 61000-4-3 (continued)	3 V/m 80 MHz to 2.5 GHz	3 V/m 965MHz to 1.39 GHz 20 V/m 1.39 GHz to 6.0 GHz	$d = 2.3\sqrt{P}$ $d = 0.35\sqrt{P}$ Field strengths from fixed RF transmitters, as determined by an electromagnetic site survey ^a should be less than the compliance level in each frequency range. ^b Interference may occur in the vicinity of equipment marked with the following symbol: 
Magnetic Fields generated by: <ul style="list-style-type: none"> • Metal Detectors • EAS Systems and Tag Deactivators (No Standard Applied)	N/A	0.1 kHz - 3.5 kHz 300 A/m 10 kHz - 60 kHz 50 A/m 50 kHz - 150 kHz 30 A/m	No special precautions required.
<p>NOTE 1: At 80 MHz, 460 MHz, 470 MHz, 690 MHz, 800 MHz, 965 MHz, and 1.39 GHz, the higher frequency range applies.</p> <p>NOTE 2: These guidelines may not apply in all situations. Electromagnetic propagation is affected by absorption and reflection from structures, objects and people.</p>			
<p>^a Field strengths from fixed transmitters, such as base stations for radio (cellular/cordless) telephones and land mobile radios, amateur radio, AM and FM radio broadcast and TV broadcast cannot be predicted theoretically with accuracy. To assess the electromagnetic environment due to fixed RF transmitters, an electromagnetic site survey should be considered. If the measured field strength in the location in which the LUKE arm system is used exceeds the applicable RF compliance level above, the LUKE arm system should be observed to verify normal operation. If abnormal performance is observed, additional measures may be necessary, such as re-orienting or relocating the LUKE arm system.</p> <p>^b Over the frequency range 150 kHz to 80 MHz, field strengths should be less than 3 V/m.</p>			

Recommended Separation Distances

The LUKE arm system is intended for use in an electromagnetic environment in which radiated RF disturbances are controlled. The user of the LUKE arm system can help prevent electromagnetic interference by maintaining a minimum distance between portable and mobile RF communications equipment (transmitters) and the LUKE arm system as recommended below, according to the maximum output power of the communications equipment.

Table 56 and Table 57 defines the recommended separation distances between portable and mobile RF communications equipment and the LUKE arm system.

Table 56. Recommended Separation Distances (Part I)

Rated Maximum Output Power of Transmitter W	Separation Distance According to Frequency of Transmitter m				
	150 kHz - 80 MHz $d = 1.2\sqrt{P}$	26 MHz - 80 MHz $d = 0.35\sqrt{P}$	80 MHz - 460 MHz $d = 1.2\sqrt{P}$	460 MHz - 470 MHz $d = 0.35\sqrt{P}$	470 MHz - 690 MHz $d = 1.2\sqrt{P}$
0.01	0.12	0.035	0.12	0.035	0.12
0.1	0.37	0.11	0.37	0.11	0.37
1	1.2	0.35	1.2	0.35	1.2
10	3.7	1.1	3.7	1.1	3.7
100	12	3.5	12	3.5	12

For transmitters rated at a maximum output power not listed above, the recommended separation distance d in meters (m) can be estimated using the equation applicable to the frequency of the transmitter, where P is the maximum output power rating of the transmitter in watts (W) according to the transmitter manufacturer.

NOTE 1: At 80 MHz, 460 MHz, 470 MHz, 690 MHz, 800 MHz, 965 MHz, and 1.39 GHz, the separation distance for the higher frequency range applies.

NOTE 2: These guidelines may not apply in all situations. Electromagnetic propagation is affected by absorption and reflection from structures, objects and people.

Table 57. Recommended Separation Distances (Part II)

Rated Maximum Output Power of Transmitter W	Separation Distance According to Frequency of Transmitter m			
	690 MHz - 800 MHz $d = 0.18\sqrt{P}$	800 MHz - 965 MHz $d = 0.35\sqrt{P}$	965 MHz - 1.390 GHz $d = 2.3\sqrt{P}$	1.390 GHz - 6.0 GHz $d = 0.35\sqrt{P}$
0.01	0.018	0.035	0.23	0.035
0.1	0.055	0.11	0.74	0.11
1	0.18	0.35	2.3	0.35
10	0.55	1.1	7.4	1.1
100	1.8	3.5	23	3.5

For transmitters rated at a maximum output power not listed above, the recommended separation distance d in meters (m) can be estimated using the equation applicable to the frequency of the transmitter, where P is the maximum output power rating of the transmitter in watts (W) according to the transmitter manufacturer.

NOTE 1: At 80 MHz, 460 MHz, 470 MHz, 690 MHz, 800 MHz, 965 MHz, and 1.39 GHz, the separation distance for the higher frequency range applies.

NOTE 2: These guidelines may not apply in all situations. Electromagnetic propagation is affected by absorption and reflection from structures, objects and people.

Essential Performance

The following items are the Essential Performance of the LUKE arm system.

The LUKE arm system:

- is able to safely power on and off.
- enters Standby mode at power on.
- hand open button operates normally.
- gross motor movements are slowed within the slowdown region.
- low battery alert operates normally.