



Electromagnetic Compatibility Test Report

Tests Performed on a Mobius Bionics LLC

2.4 GHz Transceiver, Model DLKU-20275-001

Radiometrics Document RP-8463C



Product Detail:

FCC ID: 2AJ4M20275

Equipment type: 2.4 GHz Low power transmitter

Test Standards:

US CFR Title 47, Chapter I, FCC Part 15 Subpart C
FCC Part 15 CFR Title 47: 2016

This report concerns: Original Grant for Certification
FCC Part 15.249

Tests Performed For:

Mobius Bionics LLC
470 Commercial St.
Manchester, NH 03101

Test Facility:

Radiometrics Midwest Corporation
12 Devonwood Avenue
Romeoville, IL 60446-1349
(815) 293-0772

Test Date(s): (Month-Day-Year)

November 5 to December 16, 2016

Document RP-8463C Revisions:

Rev.	Issue Date	Affected Sections	Revised By
0	January 19, 2017		
1	January 30, 2017	1, 6, 10, 11.2.3.1 & 11.2.3.2	Joseph Strzelecki

Table of Contents

1.0 ADMINISTRATIVE DATA	3
2.0 TEST SUMMARY AND RESULTS	3
2.1 RF Exposure Compliance Requirements	3
3.0 EQUIPMENT UNDER TEST (EUT) DETAILS	3
3.1 EUT Description	3
3.1.1 FCC Section 15.203 Antenna Requirements	4
3.2 Related Submittals	4
4.0 TESTED SYSTEM DETAILS	4
4.1 Tested System Configuration	4
4.2 Special Accessories	4
4.3 Equipment Modifications	4
5.0 TEST SPECIFICATIONS	5
6.0 TEST PROCEDURE DOCUMENTS	5
7.0 RADIOMETRICS' TEST FACILITIES	5
8.0 DEVIATIONS AND EXCLUSIONS FROM THE TEST SPECIFICATIONS	5
9.0 CERTIFICATION	6
10.0 TEST EQUIPMENT TABLE	6
11.0 TEST SECTIONS	6
11.1 AC Conducted Emissions	6
11.2 Radiated RF Emissions	9
11.2.1 Field Strength Calculation	10
11.2.2 Duty Cycle	10
11.2.3 Radiated Emissions Test Results	12
11.3 Occupied Bandwidth Data	14
11.3.1 Measurement Instrumentation Uncertainty	16

Notice: This report must not be reproduced (except in full) without the written approval of Radiometrics Midwest Corporation.

1.0 ADMINISTRATIVE DATA

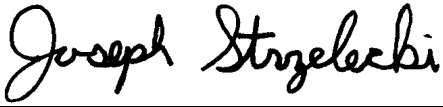
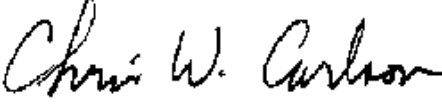
<i>Equipment Under Test:</i>	
A Mobius Bionics LLC, 2.4 GHz Transceiver Model: DLKU-20275-001 Serial Number: PCDA-Q0-029 This will be referred to as the EUT in this Report	
<i>Date EUT Received at Radiometrics: (Month-Day-Year)</i>	<i>Test Date(s): (Month-Day-Year)</i>
November 2, 2016	November 5 to December 16, 2016
<i>Test Report Written By:</i>	<i>Test Witnessed By:</i>
Joseph Strzelecki Senior EMC Engineer	The tests were not witnessed by Mobius Bionics LLC
<i>Radiometrics' Personnel Responsible for Test:</i>	<i>Test Report Approved By</i>
	
Joseph Strzelecki Senior EMC Engineer NARTE EMC-000877-NE	Chris W. Carlson Director of Engineering NARTE EMC-000921-NE

2.0 TEST SUMMARY AND RESULTS

The EUT (Equipment Under Test) is a 2.4 GHz Transceiver, Model DKLK-20275-001, manufactured by Mobius Bionics LLC. The detailed test results are presented in a separate section. The following is a summary of the test results.

Emissions Tests Results

Environmental Phenomena	Frequency Range	Basic Standard	Test Result
RF Radiated Emissions	30-25,000 MHz	FCC Part 15	Pass
Conducted Emissions, AC Mains	0.15 - 30 MHz	FCC Part 15	Pass
Occupied Bandwidth Test	Fundamental Freq.	FCC Part 15	Pass

2.1 RF Exposure Compliance Requirements

Since the power output is less than 10 mW, the EUT meets the FCC requirement for RF. There are no power level adjustments available to the end user. The antenna is permanently attached. The detailed calculations for RF Exposure are presented in a separate document.

3.0 EQUIPMENT UNDER TEST (EUT) DETAILS

3.1 EUT Description

The EUT is a PC USB Dongle for use with a prosthetic arm, Model DKLK-20275-001, manufactured by Mobius Bionics, LLC. The EUT was in good working condition during the tests, with no known defects.

3.1.1 FCC Section 15.203 Antenna Requirements

The antenna is internal to the EUT and it is not readily available to be modified by the end user. Therefore, it meets the 15.203 Requirements.

3.2 Related Submittals

The associated transceiver is operated under part 15.249. It is subject to the FCC requirements pursuant to the Certification equipment authorization under Part 15 Subpart C, and is being submitted as FCC ID: 2AJ4M20260 and 2AJ4M10112.

4.0 TESTED SYSTEM DETAILS

4.1 Tested System Configuration

The system was configured for testing in a typical fashion. The EUT was placed on an 80-cm high, nonconductive test stand. The testing was performed in conditions as close as possible to installed conditions. Wiring was consistent with manufacturer's recommendations. The EUT was tested while connected to a laptop computer, since this is the worst-case configuration.

The identification for all equipment, plus descriptions of all cables used in the tested system, are:

Tested System Configuration List

Item	Description	Type*	Manufacturer	Model Number	Serial Number
1	Dongle	E	Mobius	DLKU-20275-001	PCDA-Q0-029
2	Laptop Computer	S	Lenovo	T430	PB-ZYMDV
3	Laptop power supply	S	Lenovo	T430	11592P1109Z1Z787AD4
4	Router	P	Dynex	DX-GB8PRT	10K22B16124

* Type: E = EUT, P = Peripheral, S = Support Equipment; H = Host Computer

List of System Cables

QTY	Length (m)	Cable Description	Shielded?
1	1.0	USB Cable to Dongle	Yes
1	1.0	AC Cord to input of computer power supply	No
1	1.8	DC output cable of charger	No
1	1.7	Ethernet Cable from router to computer	No

4.2 Special Accessories

No special accessories were used during the tests in order to achieve compliance.

4.3 Equipment Modifications

No modifications were made to the EUT at Radiometrics' test facility in order to comply with the standards listed in this report.

5.0 TEST SPECIFICATIONS

Document	Date	Title
FCC CFR Title 47	2016	Code of Federal Regulations Title 47, Chapter 1, Federal Communications Commission, Part 15 - Radio Frequency Devices

6.0 TEST PROCEDURE DOCUMENTS

The tests were performed using the procedures from the following specifications:

Document	Date	Title
ANSI C63.4-2014	2014	Methods of Measurement of Radio Noise Emissions from Low-Voltage Electrical and Electronic Equipment in the Range of 9 kHz to 40 GHz
ANSI C63.10-2013	2013	American National Standard for Testing Unlicensed Wireless Devices

7.0 RADIOMETRICS' TEST FACILITIES

The results of these tests were obtained at Radiometrics Midwest Corp. in Romeoville, Illinois, USA. Radiometrics is accredited by A2LA (American Association for Laboratory Accreditation) to conform to ISO/IEC 17025: 2005 "General Requirements for the Competence of Calibration and Testing Laboratories". Radiometrics' Lab Code is 121191 and Certification Number is 1495.01. Radiometrics' scope of accreditation includes all of the test methods listed herein. A copy of the accreditation can be accessed on our web site (www.radiomet.com). Radiometrics accreditation status can be verified at A2LA's web site (www.a2la2.org).

The following is a list of shielded enclosures located in Romeoville, Illinois used during the tests:

Chamber E: Is a custom made anechoic chamber that measures 52' L X 30' W X 18' H. The walls and ceiling are fully lined with RF absorber. Pro-shield of Collinsville, Oklahoma manufactured the chamber. The floor has a 9' x 9' section of microwave absorber for testing above 1 GHz.

Test Station F: Is an area that measures 10' D X 12' W X 10' H. The floor and back wall are metal shielded. This area is used for conducted emissions measurements.

A separate ten-foot long, brass plated, steel ground rod attached via a 6 inch copper braid grounds each of the above chambers. Each enclosure is also equipped with low-pass power line filters.

The FCC has accepted these sites as test site number US1065. The FCC test site Registration Number is 732175. Details of the site characteristics are on file with the Industry Canada as site number IC 8727A-1.

A complete list of the test equipment is provided herein. The calibration due dates are indicated on the equipment list. The equipment is calibrated in accordance to ANSI/NCSL Z540-1 with traceability to the National Institute of Standards and Technology (NIST).

8.0 DEVIATIONS AND EXCLUSIONS FROM THE TEST SPECIFICATIONS

There were no deviations or exclusions from the test specifications.

9.0 CERTIFICATION

Radiometrics Midwest Corporation certifies that the data contained herein was taken under conditions that meet or exceed the requirements of the test specification and the data contained herein was taken with calibrated test equipment. The results relate only to the EUT listed herein.

10.0 TEST EQUIPMENT TABLE

RMC ID	Manufacturer	Description	Model No.	Serial No.	Frequency Range	Cal Period	Cal Date
AMP-05	RMC/Celeritek	Pre-amplifier	MW110G	1001	1.0-12GHz	12 Mo.	01/05/16
AMP-20	Avantek	Pre-amplifier	SF8-0652	15221	8-18GHz	12 Mo.	01/05/16
AMP-22	Anritsu	Pre-amplifier	MH648A	M23969	0.1-1200MHz	12 Mo.	01/05/16
AMP-29	HP / Agilent	Amplifier	11975A	2304A00158	2-8 GHz	12 Mo.	01/08/16
ANT-03	Tensor	Biconical Antenna	4104	2231	20-250MHz	24 Mo.	12/07/15
ANT-04	Tensor	Biconical Antenna	4104	2246	20-250MHz	24 Mo.	05/16/16
ANT-06	EMCO	Log-Periodic Ant.	3146	1248	200-1000MHz	24 Mo.	11/25/15
ANT-08	RMC	Log-Periodic Ant.	LP1000	1002	200-1000MHz	24 Mo.	10/06/16
ANT-13	EMCO	Horn Antenna	3115	2502	1.0-18GHz	24 Mo.	12/28/16
ANT-36	Ailtech (Eaton)	Horn Antenna	96001	2013	1.0-18GHz	24 Mo.	11/02/16
ANT-48	RMC	Std Gain Horn	HW2020	1001	18-26 GHz	24 Mo.	12/15/15
HPF-01	Solar	High Pass Filter	7930-100	HPF-1	0.15-30MHz	24 Mo.	03/15/16
LSN-01	Electrometrics	50 uH LISN	FCC/VDE 50/2	1001	0.01-30MHz	24 Mo.	06/23/15
MXR-02	HP / Agilent	Harmonic Mixer	11970K	2332A00489	18-26.5GHz	12 Mo.	01/08/16
REC-08	HP / Agilent	Spectrum Analyzer	8566B	2648A13481 2209A01436	30Hz-22GHz	24 Mo.	12/21/15
REC-11	HP / Agilent	Spectrum Analyzer	E7405A	US39110103	9Hz-26.5GHz	12 Mo.	03/23/16
REC-20	HP / Agilent	Spectrum Analyzer	85460A/84562A	33330A00135 3410A00178	30Hz-6GHz	24 Mo.	07/13/16
REC-21	Agilent	Spectrum Analyzer	E7405A	MY45118341	9Hz-26.5 GHz	24 Mo.	12/22/15
THM-02	Fluke	Temp/Humid Meter	971	93490471	N/A	24 Mo.	08/03/15
THM-03	Fluke	Temp/Humid Meter	971	95850465	N/A	12 Mo.	01/11/16

Note: All calibrated equipment is subject to periodic checks.

Software Company	Test Software Name	Version	Applicable Tests
Radiometrics	EN550XX0	06.10.16	RF Conducted Emissions (FCC Part 15 & EN 55011/22) REC-10
Radiometrics	REREC11D	01.05.16	RF Radiated Emissions (FCC Part 15 & EN 55011/22)
Agilent	PSA/ESA-E/L/EMC	2.4.0.42	Bandwidth and screen shots

11.0 TEST SECTIONS

11.1 AC Conducted Emissions

The tests and limits are in accordance with FCC section 15.207.

A computer-controlled analyzer was used to perform the conducted emissions measurements. The frequency range was divided into 500 subranges equally spaced on a logarithmic scale. The computer recorded the peak of each subrange. This data was then plotted on a semi-log graph generated by the computer. Adjusting the positions of the cables and orientation of the test system then maximizes the highest emissions.

Mains Conducted emission measurements were performed using a 50 Ohm/50 uH Line Impedance Stabilization Network (LISN) as the pick-up device. Measurements were repeated on both leads within the power cord. If the EUT power cord exceeded 80 cm in length, the excess length of the power cord was made into a 30 to 40 cm bundle near the center of the cord. The LISN was placed on the floor at the base of the test platform and electrically bonded to the ground plane.

FCC Limits of Conducted Emissions at the AC Mains Ports

Frequency Range (MHz)	Class B Limits (dBuV)	
	Quasi-Peak	Average
0.150 - 0.50*	66 - 56	56 - 46
0.5 – 5.0	56	46
5.0 - 30	60	50

* The limit decreases linearly with the logarithm of the frequency in this range.

The initial step in collecting conducted data is a peak detector scan and the plotting of the measurement range. Significant peaks are then marked as shown on the following table, and these signals are then measured with the quasi-peak detector. The following represents the worst case emissions from EUT Computer power cord, after testing all modes of operation.

Test Date : December 15, 2016

The Amplitude is the final corrected value with cable and LISN Loss.

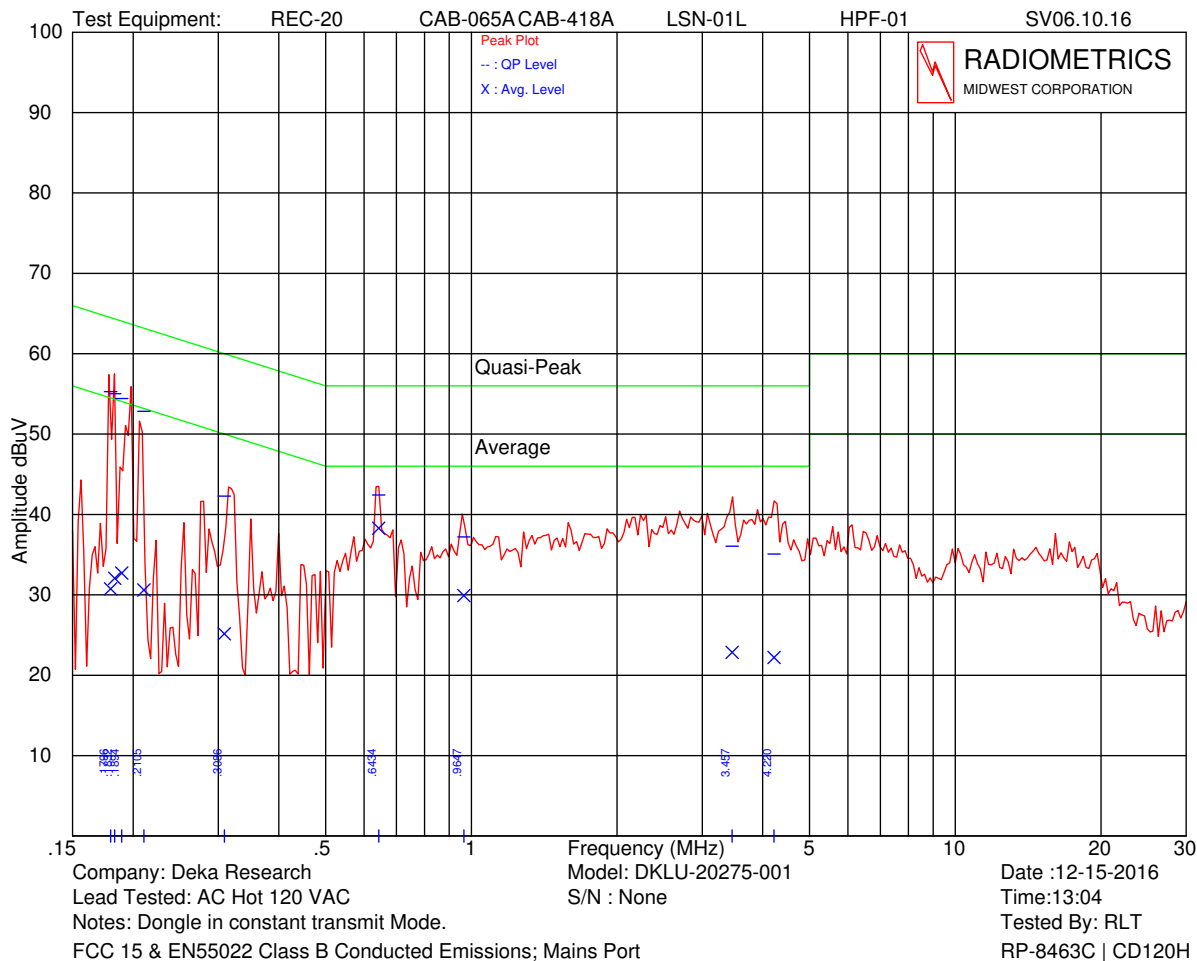

Testing of the Mobius Bionics LLC, Model DLKU-20275-001, 2.4 GHz Transceiver

Company name should be Mobius Bionics, LLC

Frequency (MHz)	QP Amplitude (dBuV)	QP Limit (dBuV)	Average Amplitude (dBuV)	Average Limit (dBuV)	Margin (dB)
0.180	55.3	64.5	30.7	54.5	9.2
0.183	55.0	64.3	32.1	54.3	9.3
0.189	54.4	64.1	32.7	54.1	9.6
0.211	52.8	63.2	30.6	53.2	10.4
0.309	42.3	60.0	25.2	50.0	17.7
0.643	42.4	56.0	38.3	46.0	7.7
0.965	37.2	56.0	29.9	46.0	16.1
3.457	36.0	56.0	22.8	46.0	20.0
4.221	35.1	56.0	22.2	46.0	20.9

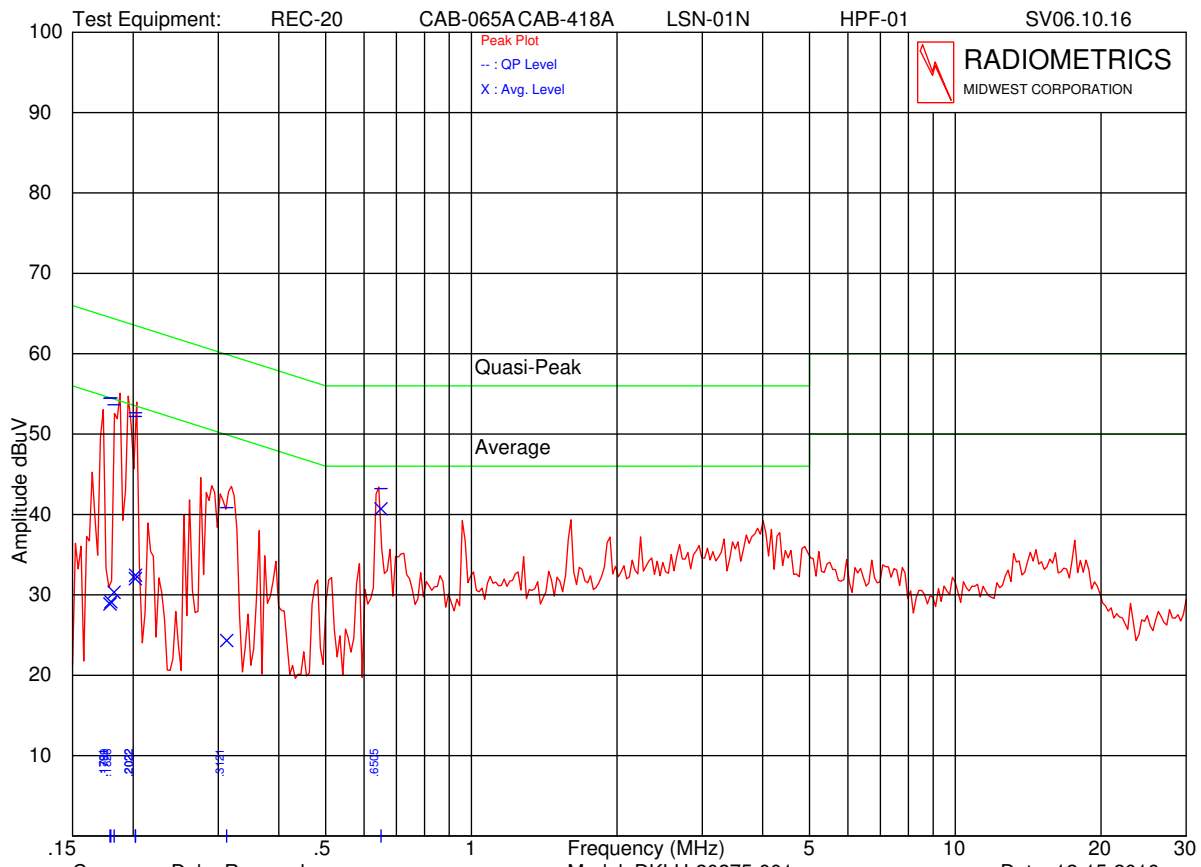

Company name should be Mobius Bionics, LLC

Frequency (MHz)	QP Amplitude (dBuV)	QP Limit (dBuV)	Average Amplitude (dBuV)	Average Limit (dBuV)	Margin (dB)
0.179	54.5	64.5	28.9	54.5	10.0
0.180	54.5	64.5	29.1	54.5	10.0

Testing of the Mobius Bionics LLC, Model DLKU-20275-001, 2.4 GHz Transceiver

0.183	53.6	64.4	30.3	54.4	10.7
0.202	52.7	63.5	32.4	53.5	10.9
0.312	40.9	59.9	24.3	49.9	19.1
0.651	43.2	56.0	40.7	46.0	5.3

Judgment: Passed by at least 5.3 dB

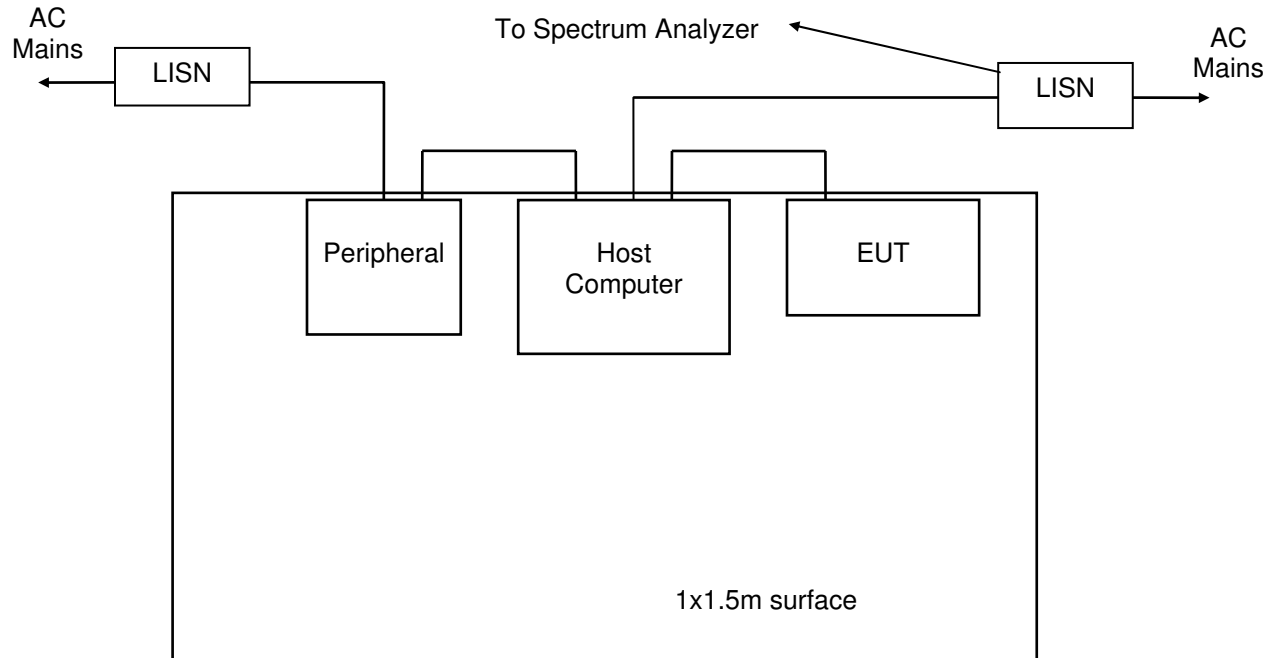
Figure 1. Conducted Emissions Test Setup**Notes:**

- LISN's at least 80 cm from EUT chassis
- Vertical conductive plane 40 cm from rear of table top
- EUT power cord bundled

11.2 Radiated RF Emissions

Radiated emission measurements were performed with linearly polarized broadband antennas. The results obtained with these antennas can be correlated with results obtained with a tuned dipole antenna. The radiated emission measurements were performed with a spectrum analyzer. The bandwidth used from 150 kHz to 30 MHz is 9 or 10 kHz and the bandwidth from 30 MHz to 1000 MHz is 100 or 120 kHz. Above 1 GHz, a 1 MHz bandwidth is used. A 10 dB linearity check is performed prior to start of testing in order to determine if an overload condition exists. A harmonic mixer was used from 18 to 25 GHz. Figure 4 herein lists the details of the test equipment used during radiated emissions tests.

The EUT was rotated through three orthogonal axis as per 5.10.1 of ANSI C63.10 during the radiated tests.

Final radiated emissions measurements were performed inside of an anechoic chamber at a test distance of 3 meters. The anechoic chamber is designated as Chamber E. This Chamber meets the Site Attenuation requirements of ANSI C63.4 and CISPR 16-1. Chamber E is located at 12 East Devonwood Ave. Romeoville, Illinois EMI test lab.

The entire frequency range from 30 to 25,000 MHz was slowly scanned with particular attention paid to those frequency ranges which appeared high. Measurements were performed using two antenna polarizations, (vertical and horizontal). The worst case emissions were recorded. All measurements may be performed using either the peak, average or quasi-peak detector functions. If the peak detector data exceeds or is marginally close to the limits, the measurements are repeated using a quasi-peak detector or average function as required by the specification for final determination of compliance.

The detected emission levels were maximized by rotating the EUT, adjusting the positions of all cables, and by scanning the measurement antenna from 1 to 4 meters above the ground.

11.2.1 Field Strength Calculation

The field strength is calculated by adding the Antenna Factor and Cable Loss, and by subtracting the Amplifier Gain from the measured reading. The basic equation is as follows:

$$FS = RA + AF + CF - AG + HPF + PKA$$

Where: FS = Field Strength

RA = Receiver Amplitude

AF = Antenna Factor

CF = Cable Attenuation Factor

AG = Amplifier Gain

PKA = Peak to Average Factor (This is only used for average measurements above 1 GHz)

The Peak to average factor is used when average measurements are required. It is calculated by the highest duty cycle in percent over any 100mS transmission. The factor in dB is $20 * \text{Log}(\text{Duty cycle}/100)$.

Note: The actual FCC limits are in uV/m. The data in the results table covered the limits to dBuV/m.

100 uV/m = 40.0 dBuV/m

150 uV/m = 43.5 dBuV/m

200 uV/m = 46.0 dBuV/m

500 uV/m = 54.0 dBuV/m

11.2.2 Duty Cycle

The Peak to average factor is calculated by the highest duty cycle in percent over any 100mS transmission. The factor in dB is $20 * \text{Log}(\text{Duty cycle}/100)$.

The transmitter operates for a maximum duration of $(1.222 * 2)$ ms in any 100 ms interval for a **2.444%** maximum duty cycle. $20 \text{Log}^*(2.444\text{mSec}/100\text{mSec}) = -32.2$ dB Peak to average Correction factor.

Testing of the Mobius Bionics LLC, Model DLKU-20275-001, 2.4 GHz Transceiver

Agilent 14:37:45 Nov 18, 2016

R T

Dongle Duty cycle at 2445 MHz.

Mkr1 Δ 80.04 ms

Ref -5 dBm

#Atten 5 dB

-0.066 dB

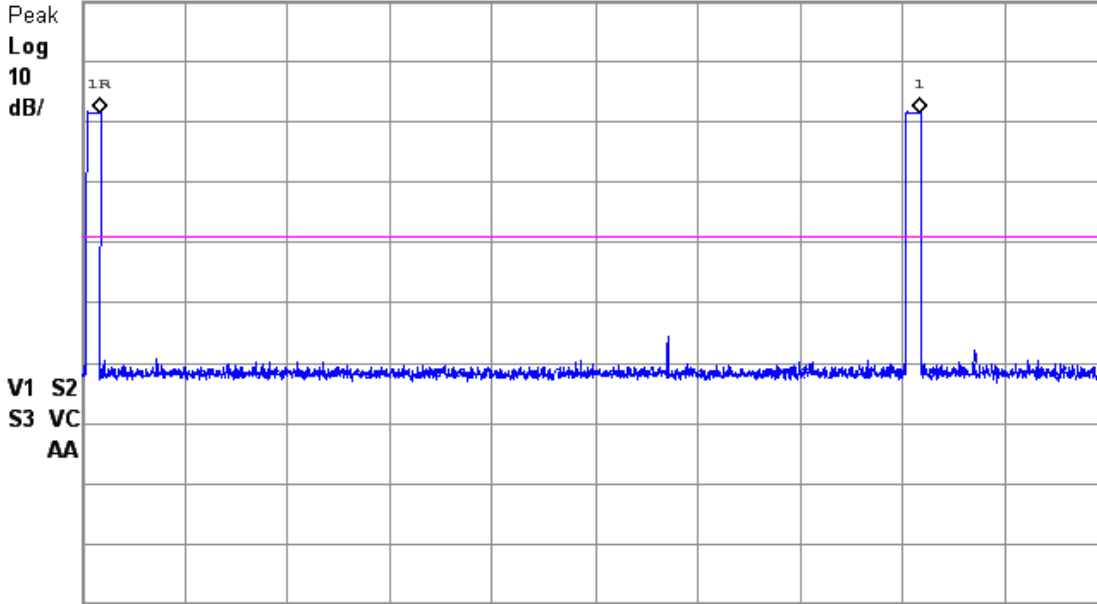

Start 2.445 GHz

Stop 2.445 GHz

Res BW 1 MHz

#VBW 3 MHz

Sweep 100 ms (2000 pts)

Agilent 14:43:25 Nov 18, 2016

R T

Dongle Pulse Width at 2445 MHz.

Mkr1 Δ 1.222 ms

Ref -5 dBm

#Atten 5 dB

-15.2 dB

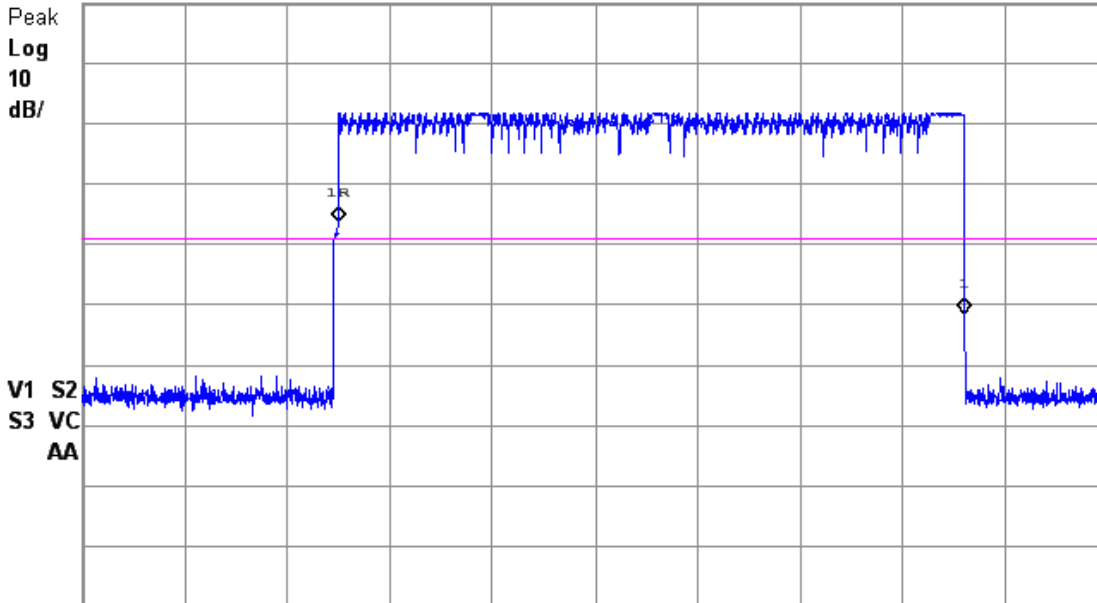

Start 2.445 GHz

Stop 2.445 GHz

Res BW 1 MHz

#VBW 3 MHz

Sweep 1.999 ms (2000 pts)

Testing of the Mobius Bionics LLC, Model DLKU-20275-001, 2.4 GHz Transceiver

11.2.3 Radiated Emissions Test Results**11.2.3.1 Emissions Below 1 GHz**

Test Date	11/5, 11/14 & 12/16/2016
Test Distance	3 Meters
Specification	FCC Part 15.209 & 15.249
Tested by	Richard Tichgelaar, Chris Dalessio
Abbreviations	Pol = Antenna Polarization; V = Vertical; H = Horizontal; P = peak; Q = QP

EUT Tx Freq	Meter Reading dBuV	Det.	Ant Pol.	Antenna Factor	Corr. Factor	Dist. Factor	EUT dBuV/m	Limit dBuV/m	Margin under limit	Note
35.0	47.6	P	H	11.5	-28.3	0.0	30.8	40.0	9.2	
64.7	44.2	P	H	7.9	-28.1	0.0	23.9	40.0	16.1	
74.6	43.3	P	H	6.2	-28.0	0.0	21.5	40.0	18.5	
108.7	40.8	P	H	12.3	-27.8	0.0	25.3	40.0	14.7	
159.8	44.4	P	H	15.0	-27.6	0.0	31.8	40.0	8.2	
199.9	46.0	Q	H	16.4	-27.5	0.0	34.9	40.0	5.1	
223.6	42.7	P	H	14.4	-27.4	0.0	29.6	40.0	10.4	
283.8	44.8	P	H	13.1	-27.3	0.0	30.6	47.0	16.4	
306.9	43.6	P	H	13.9	-27.2	0.0	30.3	47.0	16.7	
348.8	41.8	P	H	14.3	-27.2	0.0	28.9	47.0	18.1	
396.9	39.5	P	H	14.6	-27.2	0.0	26.8	47.0	20.2	
425.0	40.6	P	H	15.9	-26.9	0.0	29.6	47.0	17.4	
456.3	35.3	P	H	15.7	-27.1	0.0	23.9	47.0	23.1	
526.3	34.8	P	H	16.9	-26.6	0.0	25.2	47.0	21.8	
576.3	34.9	P	H	18.5	-26.6	0.0	26.8	47.0	20.2	
747.5	35.1	P	H	20.1	-26.1	0.0	29.1	47.0	17.9	
797.5	42.2	P	H	21.1	-25.7	0.0	37.6	47.0	9.4	
876.3	38.4	P	H	22.1	-25.2	0.0	35.2	47.0	11.8	
913.8	34.5	P	H	21.9	-24.8	0.0	31.6	47.0	15.4	
43.8	49.6	Q	V	12.0	-28.3	0.0	33.3	40.0	6.7	
64.7	53.5	P	V	7.9	-28.1	0.0	33.3	40.0	6.7	
108.7	48.4	P	V	12.3	-27.8	0.0	32.9	40.0	7.1	
159.8	45.9	P	V	15.0	-27.6	0.0	33.3	40.0	6.7	
199.9	45.7	Q	V	16.4	-27.5	0.0	34.6	40.0	5.4	
225.3	41.3	P	V	14.4	-27.4	0.0	28.3	40.0	11.7	
283.8	36.1	P	V	13.1	-27.3	0.0	21.8	47.0	25.2	
375.0	41.9	P	V	14.4	-27.1	0.0	29.2	47.0	17.8	
425.0	41.1	P	V	15.9	-26.9	0.0	30.2	47.0	16.8	
475.0	38.5	P	V	17.7	-26.7	0.0	29.4	47.0	17.6	
526.3	35.9	P	V	16.9	-26.6	0.0	26.2	47.0	20.8	
626.3	34.6	P	V	19.1	-26.5	0.0	27.2	47.0	19.8	
797.5	33.2	P	V	21.1	-25.7	0.0	28.6	47.0	18.4	
932.5	31.6	P	V	22.5	-24.7	0.0	29.3	47.0	17.7	

Judgment: Passed by 5.1 dB

Since all readings passed in peak, Quasi-Peak measurements were not performed.

Testing of the Mobius Bionics LLC, Model DLKU-20275-001, 2.4 GHz Transceiver

11.2.3.2 Emissions above 1 GHz

Test Date: 11/14/2016

Tested by: Dave Jarvis; Chris Dalessio

Radiated Emissions per FCC 15.249

#	hrm	Tx	Spectrum Analyzer Readings								EUT	Peak	Ave	Peak	Ave	Margin							
			Vertical Polarization				Horizontal Polarization										Corr.	Emission	Tot. FS		Limit		Under
			X	Y	Z	Max	X	Y	Z	Max									Fact.	Freq MHz	dBuV/m		
1		2405	98.1	105.0	98.5	72.8	102.5	99.0	98.9	70.3	-5.6	2405.0	99.4	67.2	114	94	14.6						
BE		2405	54.0	60.9	54.4	28.7	58.4	0.0	54.8	26.2	-5.6	2400.0	55.3	23.1	74	54	18.7						
2		2405	44.6	49.6	45.5	17.4	53.7	47.5	47.4	21.5	2.1	4810.0	55.8	23.6	74	54	18.2						
3		2405	41.2	44.6	41.3	12.4	41.9	41.4	41.8	9.7	6.8	7215.0	51.4	19.2	74	54	22.6						
1		2445	94.7	99.6	97.3	67.4	101.7	98.6	97.5	69.5	-5.2	2445.0	96.5	64.3	114	94	17.5						
2		2445	43.1	43.8	44.8	12.6	50.9	47.1	44.9	18.7	2.4	4890.0	53.3	21.1	74	54	20.7						
3		2445	40.3	40.3	41.3	9.1	42.8	45.8	40.6	13.6	7.2	7335.0	53.0	20.8	74	54	21.0						
1		2480	95.1	96.1	96.2	0.0	102.0	97.5	97.0	69.8	-5.3	2480.0	96.7	64.5	114	94	17.3						
BE		2480	55.8	56.8	56.9	24.7	62.7	58.2	57.7	30.5	-5.3	2483.5	57.4	25.2	74	54	16.6						
2		2480	42.9	51.3	45.1	19.1	46.6	44.5	44.5	14.4	2.4	4960.0	53.7	21.5	74	54	20.3						
3		2480	42.2	43.7	40.5	11.5	41.2	46.7	40.9	14.5	7.5	7440.0	54.2	22.0	74	54	19.8						
Column numbers (see below for explanations)																							
1	2	3	4	5	6	7	8	9	10	11	12	13	14	15	16	17							

Column #1. hrm = Harmonic; BE = Band Edge emissions

Column #2. Frequency of Transmitter.

Column #3. Uncorrected readings from the spectrum analyzer with First Axis Rotation.

Column #4. Uncorrected readings from the spectrum analyzer with Second Axis Rotation.

Column #5. Uncorrected readings from the spectrum analyzer with Third Axis Rotation.

Column #6. Average Reading based on peak reading reduced by the Duty cycle correction

Column #7. Uncorrected readings from the spectrum analyzer with First Axis Rotation.

Column #8. Uncorrected readings from the spectrum analyzer with Second Axis Rotation.

Column #9. Uncorrected readings from the spectrum analyzer with Third Axis Rotation.

Column #10. Average Reading based on peak reading reduced by the Duty cycle correction

Column #11. Corr. Factors = Cable Loss – Preamp Gain + Antenna Factor

Column #12. Frequency of Tested Emission

Column #13. Highest peak field strength at listed frequency.

Column #14. Highest Average field strength at listed frequency.

Column #15. Peak Limit.

Column #16. Average Limit.

Column #17. The margin (last column) is the worst case margin under the peak or average limits for that row.

All emissions outside of the band from 2400 to 2483.5 were below the limits of 15.209.

No other Emissions were detected from 30 to 25,000 MHz within 10 dB of the limits.

Overall Judgment: Passed by at least 10 dB

Figure 2. Drawing of Radiated Emissions Setup

Chamber E, anechoic

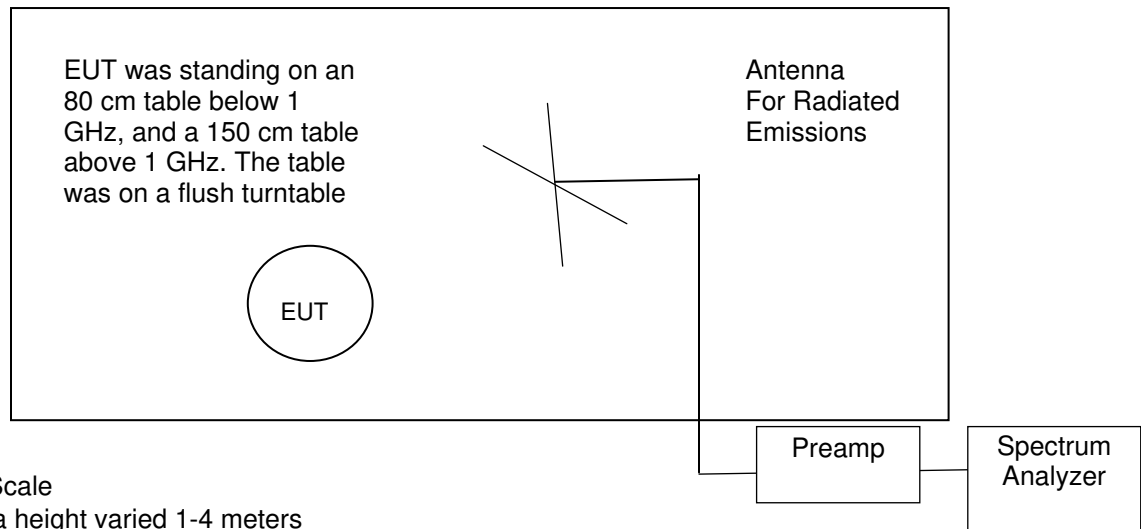
**Notes:**

- Not to Scale
- Antenna height varied 1-4 meters
- Distance from antenna to tested system is 3 meters
- AC cords not shown. They are connected to AC outlet with low-pass filter on turntable

Frequency Range	Receive Antenna	Pre-Amplifier	Spectrum Analyzer
30 to 200 MHz	ANT-04	AMP-22	REC-11
200 to 1000 MHz	ANT-08	AMP-22	REC-11
1 to 10 GHz	ANT-13	AMP-05	REC-11
10 to 18 GHz	ANT-36	AMP-20	REC-11
18 to 25 GHz	ANT-48	AMP-29	REC-08; MXR-01

11.3 Occupied Bandwidth Data

The occupied bandwidth of the RF output was measured using a spectrum analyzer. The bandwidth was measured using the peak detector function and a narrow resolution bandwidth.

A broadband antenna was used to receive the modulated signal. The spectrum analyzer was set to the MAX HOLD mode to record the worst case of the modulation. The spectrum analyzer display was digitized and plotted. A limit was drawn on the plots based on the level of the modulated carrier. The plots of the occupied bandwidth for the EUT are supplied on the following page.

Test Date: 11/18/2016

Tested by: Richard Tichelaar

EUT MHz	20 dB BW MHz
2405	4.254
2445	3.073
2480	4.895

Figure 3. Occupied Bandwidth Plots

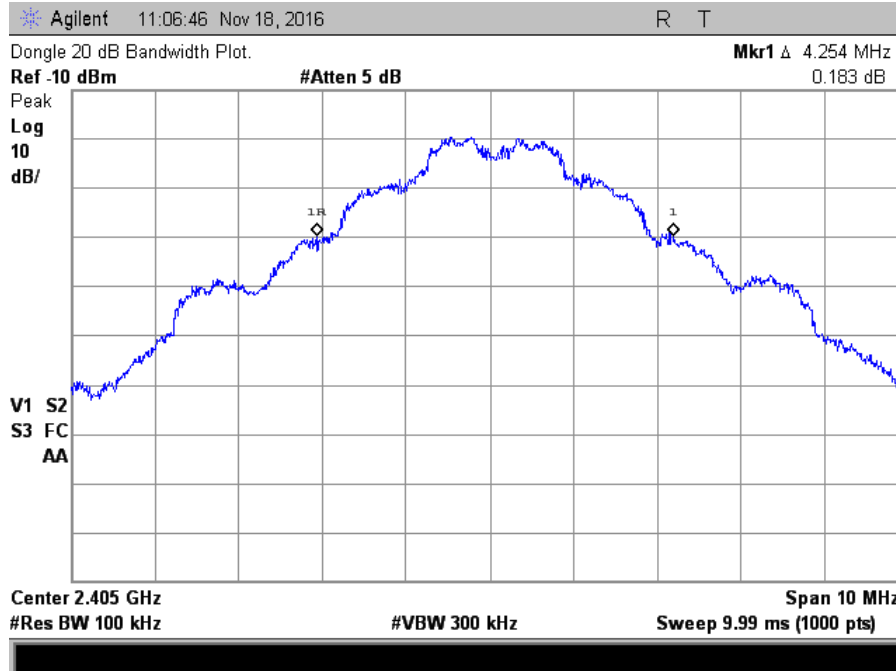

2405 MHz

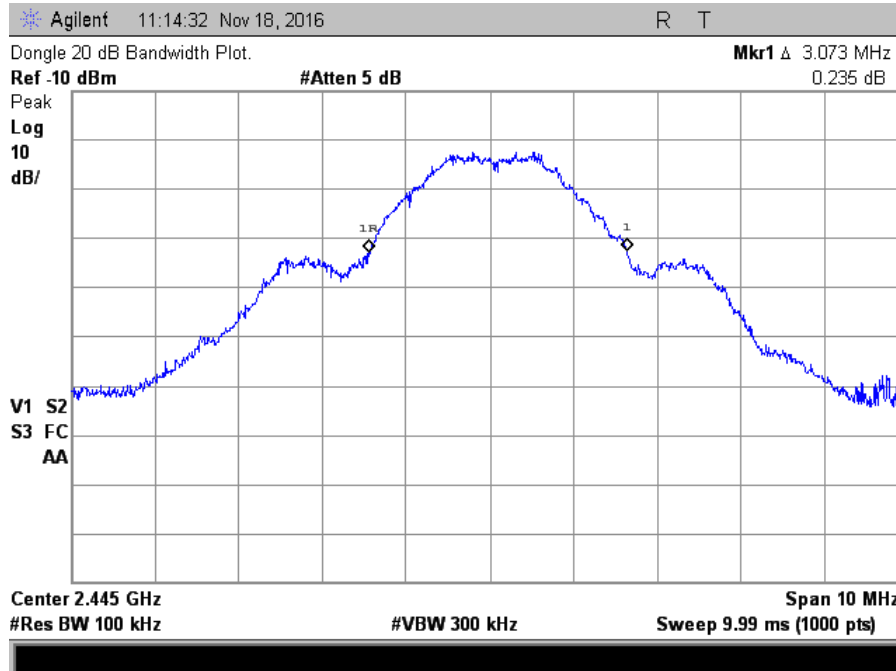

2445 MHz

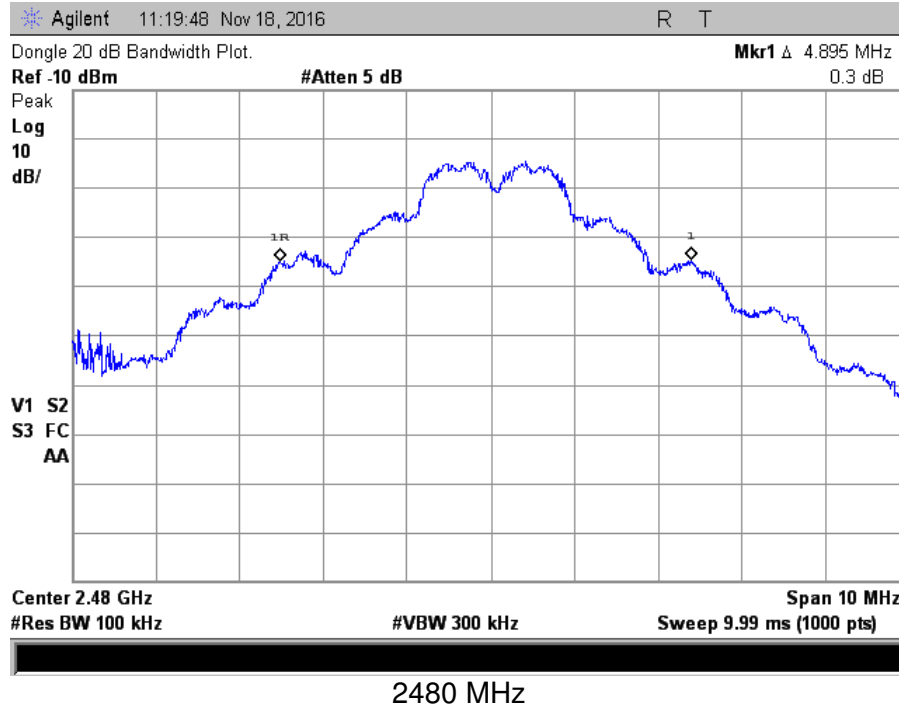

11.3.1 Measurement Instrumentation Uncertainty

Measurement	Uncertainty
Conducted Emissions, LISN method, 150 kHz to 30 MHz	2.7 dB
Radiated Emissions, E-field, 3 meters, 30 to 200 MHz	3.3 dB
Radiated Emissions, E-field, 3 meters, 200 to 1000 MHz	4.9 dB
Radiated Emissions, E-field, 3 meters, 1 to 18 GHz	4.8 dB
Bandwidth using marker delta method at a span of 10 MHz	4 kHz
Temperature THM-02	0.6 Deg C

The uncertainties represent expanded uncertainties expressed at approximately the 95% confidence level using a coverage factor of $k=2$ in accordance with CISPR 16-4-2.