



RADIO TEST REPORT

Report No:STS1712098W01

Issued for

Hangzhou Eboylamp Electronics Co., Ltd.

no.326 Liangyun Road hangzhou China

Product Name:	LED Lamp
Brand Name:	N/A
Model Name:	EBE-QPZ11
Series Model:	N/A
FCC ID:	2AJ3WEBEQPZ11
Test Standard:	FCC Part 15.247

Any reproduction of this document must be done in full. No single part of this document may be reproduced without permission from STS, All Test Data Presented in this report is only applicable to presented Test sample.





TEST RESULT CERTIFICATION

Applicant's name: Hangzhou Eboylamp Electronics Co., Ltd.

Address: no.326 Liangyun Road hangzhou China

Manufacture's Name: Hangzhou Eboylamp Electronics Co., Ltd.

Address: no.326 Liangyun Road hangzhou China

Product description

Product Name.....: LED Lamp

Brand Name: N/A

Model Name: EBE-QPZ11

Series Model.....: N/A

Test Standards: FCC Part15.247

Test procedure ANSI C63.10-2013

This device described above has been tested by STS, the test results show that the equipment under test (EUT) is in compliance with the FCC requirements. And it is applicable only to the tested sample identified in the report.

This report shall not be reproduced except in full, without the written approval of STS, this document may be altered or revised by STS, personal only, and shall be noted in the revision of the document.

Date of Test

Date (s) of performance of tests: 13 Dec. 2017 ~19 Dec. 2017

Date of Issue: 20 Dec. 2017

Test Result.....: **Pass**

Testing Engineer :

Sean She

(Sean she)

Technical Manager :

Hakim.hou

(Hakim.hou)

Authorized Signatory :

Vita Li

(Vita Li)

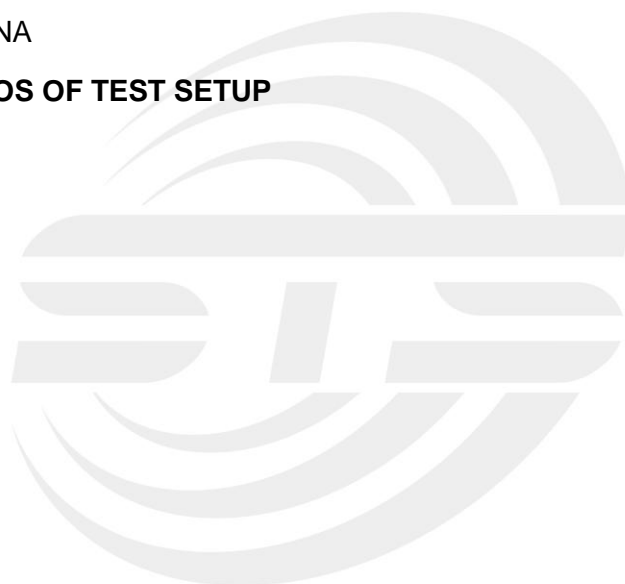



Table of Contents	Page
1. SUMMARY OF TEST RESULTS	6
1.1 TEST FACTORY	7
1.2 MEASUREMENT UNCERTAINTY	7
2. GENERAL INFORMATION	8
2.1 GENERAL DESCRIPTION OF EUT	8
2.2 DESCRIPTION OF TEST MODES	10
2.3 BLOCK DIGRAM SHOWING THE CONFIGURATION OF SYSTEM TESTED	11
2.4 DESCRIPTION OF SUPPORT UNITS	12
2.5 EQUIPMENTS LIST FOR ALL TEST ITEMS	13
3. EMC EMISSION TEST	15
3.1 CONDUCTED EMISSION MEASUREMENT	15
3.2 RADIATED EMISSION MEASUREMENT	19
4. CONDUCTED SPURIOUS & BAND EDGE EMISSION	30
4.1 APPLIED PROCEDURES / LIMIT	30
4.2 TEST PROCEDURE	30
4.3 DEVIATION FROM STANDARD	30
4.4 TEST SETUP	30
4.5 EUT OPERATION CONDITIONS	30
4.6 TEST RESULTS	31
5. POWER SPECTRAL DENSITY TEST	40
5.1 APPLIED PROCEDURES / LIMIT	40
5.2 TEST PROCEDURE	40
5.3 DEVIATION FROM STANDARD	40
5.4 TEST SETUP	40
5.5 EUT OPERATION CONDITIONS	40
5.6 TEST RESULTS	41
6. BANDWIDTH TEST	47
6.1 APPLIED PROCEDURES / LIMIT	47
6.2 TEST PROCEDURE	47
6.3 DEVIATION FROM STANDARD	47
6.4 TEST SETUP	47
6.5 EUT OPERATION CONDITIONS	47
6.6 TEST RESULTS	48



Table of Contents	Page
7. PEAK OUTPUT POWER TEST	54
7.1 APPLIED PROCEDURES / LIMIT	54
7.2 TEST PROCEDURE	54
7.3 DEVIATION FROM STANDARD	54
7.4 TEST SETUP	54
7.5 EUT OPERATION CONDITIONS	54
7.6 TEST RESULTS	55
8. ANTENNA REQUIREMENT	56
8.1 STANDARD REQUIREMENT	56
8.2 EUT ANTENNA	56
APPENDIX - PHOTOS OF TEST SETUP	57





Revision History

Rev.	Issue Date	Report NO.	Effect Page	Contents
00	20 Dec. 2017	STS1712098W01	ALL	Initial Issue





1. SUMMARY OF TEST RESULTS

Test procedures according to the technical standards:
KDB 558074 D01 DTS Meas Guidance v04

FCC Part 15.247, Subpart C			
Standard Section	Test Item	Judgment	Remark
15.207	Conducted Emission	PASS	
15.247 (a)(2)	6dB Bandwidth	PASS	
15.247 (b)(3)	Output Power	PASS	
15.247 (c)	Radiated Spurious Emission	PASS	
15.247 (d)	Conducted Spurious & Band Edge Emission	PASS	
15.247 (e)	Power Spectral Density	PASS	
15.205	Restricted Band Edge Emission	PASS	
Part 15.247(d)/part 15.209(a)	Band Edge Emission	PASS	
15.203	Antenna Requirement	PASS	

NOTE:

- (1) "N/A" denotes test is not applicable in this Test Report
- (2) all tests are according to ANSI C63.10-2013 .



1.1 TEST FACTORY

Shenzhen STS Test Services Co., Ltd.

Add. : 1/F., Building B, Zhuoke Science Park, No.190, Chongqing Road,
Fuyong Street, Bao'an District, Shenzhen, Guangdong, China

CNAS Registration No.: L7649; FCC Registration No.: 625569

IC Registration No.: 12108A; A2LA Certificate No.: 4338.01;

1.2 MEASUREMENT UNCERTAINTY

The reported uncertainty of measurement $y \pm U$, where expanded uncertainty U is based on a standard uncertainty multiplied by a coverage factor of $k=2$, providing a level of confidence of approximately 95 %.

No.	Item	Uncertainty
1	Conducted Emission (9KHz-150KHz)	$\pm 2.88\text{dB}$
2	Conducted Emission (150KHz-30MHz)	$\pm 2.67\text{dB}$
3	RF power,conducted	$\pm 0.71\text{dB}$
4	Spurious emissions,conducted	$\pm 0.63\text{dB}$
5	All emissions,radiated (9KHz-30MHz)	$\pm 3.02\text{dB}$
6	All emissions,radiated (30MHz-200MHz)	$\pm 3.80\text{dB}$
7	All emissions,radiated (200MHz-1000MHz)	$\pm 3.97\text{dB}$
8	All emissions,radiated(>1G)	$\pm 3.03\text{dB}$



2. GENERAL INFORMATION

2.1 GENERAL DESCRIPTION OF EUT

Product Name	LED Lamp														
Trade Name	N/A														
Model Name	EBE-QPZ11														
Series Model	N/A														
Model Difference	N/A														
Product Description	<p>The EUT is a LED Lamp</p> <table border="1"><tr><td>Operation Frequency:</td><td>802.11b/g/n 20: 2412~2462 MHz</td></tr><tr><td>Modulation Type:</td><td>CCK/BPSK/QPSK/16QAM</td></tr><tr><td>Bit Rate of Transmitter:</td><td>802.11b:11/5.5/2/1 Mbps 802.11g:54/48/36/24/18/12/9/6 Mbps 802.11n(20MHz): 65/58.5/52/39/26/19.5/13/6.5 Mbps</td></tr><tr><td>Number Of Channel:</td><td>802.11b/g/n20: 11CH</td></tr><tr><td>Antenna Designation:</td><td>Please see Note 3.</td></tr><tr><td>Antenna Gain (dBi):</td><td>3 dBi</td></tr><tr><td>Duty Cycle:</td><td>>98%</td></tr></table>	Operation Frequency:	802.11b/g/n 20: 2412~2462 MHz	Modulation Type:	CCK/BPSK/QPSK/16QAM	Bit Rate of Transmitter:	802.11b:11/5.5/2/1 Mbps 802.11g:54/48/36/24/18/12/9/6 Mbps 802.11n(20MHz): 65/58.5/52/39/26/19.5/13/6.5 Mbps	Number Of Channel:	802.11b/g/n20: 11CH	Antenna Designation:	Please see Note 3.	Antenna Gain (dBi):	3 dBi	Duty Cycle:	>98%
Operation Frequency:	802.11b/g/n 20: 2412~2462 MHz														
Modulation Type:	CCK/BPSK/QPSK/16QAM														
Bit Rate of Transmitter:	802.11b:11/5.5/2/1 Mbps 802.11g:54/48/36/24/18/12/9/6 Mbps 802.11n(20MHz): 65/58.5/52/39/26/19.5/13/6.5 Mbps														
Number Of Channel:	802.11b/g/n20: 11CH														
Antenna Designation:	Please see Note 3.														
Antenna Gain (dBi):	3 dBi														
Duty Cycle:	>98%														
Channel List	Please refer to the Note 2.														
Power rating	AC 120V/60Hz														
Hardware version number	N/A														
Software version number	N/A														
Connecting I/O Port(s)	Please refer to the User's Manual														

Note:

- 1 For a more detailed features description, please refer to the manufacturer's specifications or the User's Manual.



2

Operation Frequency of channel	
802.11b/g/n(20MHz)	
Channel	Frequency
01	2412
02	2417
03	2422
04	2427
05	2432
06	2437
07	2442
08	2447
09	2452
10	2457
11	2462

- 3 Note:
In section 15.31(m), regards to the operating frequency range over 10 MHz, the Lowest frequency, the middle frequency, and the highest frequency of channel were selected to perform the test, and the selected channel see below:
Carrier Frequency Channel

2.4GHz Test Frequency:

For 802.11b/g/n (HT20)	
Channel	Freq.(MHz)
01	2412
06	2437
11	2462

3

Ant	Brand	Model Name	Antenna Type	Connector	Gain (dBi)	NOTE
1	N/A	EBE-QPZ11	PCB Antenna	N/A	3	WLAN Antenna



2.2 DESCRIPTION OF TEST MODES

Each of these EUT operation mode(s) or test configuration mode(s) mentioned above was evaluated respectively.

Worst Mode	Description	Data Rate
Mode 1	TX IEEE 802.11b CH1	1 Mbps
Mode 2	TX IEEE 802.11b CH6	1 Mbps
Mode 3	TX IEEE 802.11 b CH11	1 Mbps
Mode 4	TX IEEE 802.11g CH1	6 Mbps
Mode 5	TX IEEE 802.11g CH6	6 Mbps
Mode 6	TX IEEE 802.11g CH11	6 Mbps
Mode 7	TX IEEE 802.11n HT20 CH1	MCS 0
Mode 8	TX IEEE 802.11n HT20 CH6	MCS 0
Mode 9	TX IEEE 802.11n HT20 CH11	MCS 0

Note:

- (1) The measurements are performed at all Bit Rate of Transmitter, the worst data was reported
- (2) We have be tested for all available U.S. voltage and frequencies(For 120V,50/60Hz and 240V, 50/60Hz) for which the device is capable of operation, and the worst case of 120V 60Hz is shown in the report
- (3) The EUT was programmed to be in continuously transmitting mode and the transmit duty cycle is not less than 98%.

AC Conducted Emission

Test Case	
AC Conducted Emission	Mode10: Keeping WIFI TX



2.3 BLOCK DIGRAM SHOWING THE CONFIGURATION OF SYSTEM TESTED

Radiation Test Set

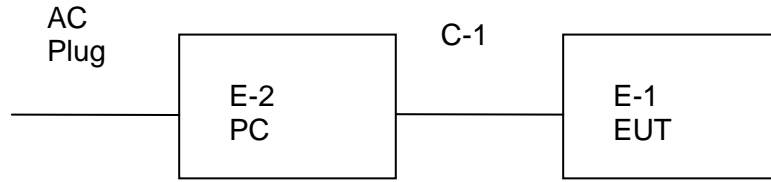

conduction Test Set

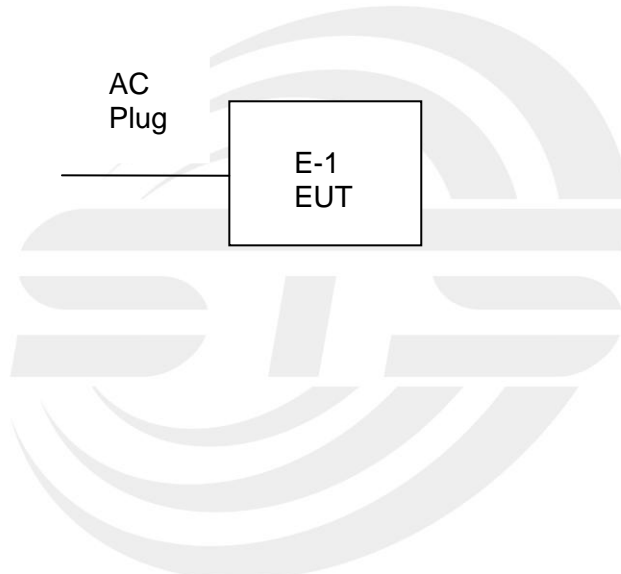



2.4 DESCRIPTION OF SUPPORT UNITS

The EUT has been tested as an independent unit together with other necessary accessories or support units. The following support units or accessories were used to form a representative test configuration during the tests.

Item	Equipment	Mfr/Brand	Model/Type No.	Serial No.	Note
E-2	PC	HP	500-320cx	N/A	N/A

Item	Shielded Type	Ferrite Core	Length	Note
C-1	USB Cable shielded line (Charging)	NO	100cm	N/A

Note:

- (1) The support equipment was authorized by Declaration of Confirmation.
- (2) For detachable type I/O cable should be specified the length in cm in 『Length』 column.
- (3) “YES” is means “shielded” “with core”; “NO” is means “unshielded” “without core”.



2.5 EQUIPMENTS LIST FOR ALL TEST ITEMS

Radiation Test equipment

Kind of Equipment	Manufacturer	Type No.	Serial No.	Last calibration	Calibrated until
EMI Test Receiver	R&S	ESW	101535	2017.06.01	2018.05.31
Bilog Antenna	TESEQ	CBL6111D	34678	2017.03.24	2018.03.23
Horn Antenna	Schwarzbeck	BBHA 9120D	9120D-1343	2017.03.06	2018.03.05
SHF-EHF Horn Antenna (15G-40GHz)	BBHA 9170	SCHWARZBECK	BBHA9170367	2017.05.02	2018.05.01
Temperature & Humidity	HH660	Mieo	N/A	2017.10.15	2018.10.14
Temperature & Humidity	HH660	Mieo	N/A	2017.10.15	2018.10.14
Pre-mpifier (0.1M-3GHz)	EM	EM330	60538	2017.03.12	2018.03.11
PreAmplifier (1G-26.5GHz)	Agilent	8449B	60538	2017.10.15	2018.10.14
Pre-mpifier (18G-40G)	MINI-CIRCUITS	AP-040G	1382501	2017.05.15	2018.05.14
Operational Manual Passive Loop (9K--30MHz)	ETS	6512	00165355	2017.03.06	2018.03.05
Low frequency cable	EM	R01	N/A	2017.03.12	2018.03.11
Low frequency cable	EM	R06	N/A	2017.03.12	2018.03.11
High frequency cable	SCHWARZBECK	R04	N/A	2017.03.12	2018.03.11
High frequency cable	SCHWARZBECK	R02	N/A	2017.03/12	2018.03.11
Semi-anechoic chamber	Changling	966	N/A	2017.10.15	2018.10.14
trun table	EM	SC100_1	60531	N/A	N/A
Antnna mast	EM	SC100	N/A	N/A	N/A
Max-full Antenna Corp	MF	MFA-440H	N/A	N/A	N/A

Conduction Test equipment

Kind of Equipment	Manufacturer	Type No.	Serial No.	Last calibration	Calibrated until
Test Receiver	R&S	ESCI	101427	2017.10.15	2018.10.14
LISN	R&S	ENV216	101242	2017.10.15	2018.10.14
conduction Cable	EM	C01	N/A	2017.03.12	2018.03.11
Temperature & Humidity	Mieo	HH660	N/A	2017.10.15	2018.10.14



RF Connected Test

Kind of Equipment	Manufacturer	Type No.	Serial No.	Last calibration	Calibrated until
USB RF power sensor	DARE	RPR3006W	15I00041SNO03	2017.10.15	2018.10.14
Power Meter	R&S	NRP	100510	2017.10.15	2018.10.14
Spectrum Analyzer	Agilent	E4407B	MY50140340	2017.03.11	2018.03.10
Signal Analyzer	Agilent	N9020A	MY49100060	2017.03.11	2018.03.10





3. EMC EMISSION TEST

3.1 CONDUCTED EMISSION MEASUREMENT

3.1.1 POWER LINE CONDUCTED EMISSION LIMITS

operating frequency band. In case the emission fall within the restricted band specified on Part 15.207(a) limit in the table below has to be followed.

FREQUENCY (MHz)	Conducted Emission limit (dBUV)	
	Quasi-peak	Average
0.15 -0.5	66 - 56 *	56 - 46 *
0.50 -5.0	56.00	46.00
5.0 -30.0	60.00	50.00

Note:

- (1) The tighter limit applies at the band edges.
- (2) The limit of " * " marked band means the limitation decreases linearly with the logarithm of the frequency in the range.

The following table is the setting of the receiver

Receiver Parameters	Setting
Attenuation	10 dB
Start Frequency	0.15 MHz
Stop Frequency	30 MHz
IF Bandwidth	9 kHz

3.1.2 TEST PROCEDURE

- a. The EUT was 0.8 meters from the horizontal ground plane and 0.4 meters from the vertical ground plane with EUT being connected to the power mains through a line impedance stabilization network (LISN). All other support equipments powered from additional LISN(s). The LISN provide 50 Ohm/ 50uH of coupling impedance for the measuring instrument.
- b. Interconnecting cables that hang closer than 40 cm to the ground plane shall be folded back and forth in the center forming a bundle 30 to 40 cm long.
- c. I/O cables that are not connected to a peripheral shall be bundled in the center. The end of the cable may be terminated, if required, using the correct terminating impedance. The overall length shall not exceed 1 m.
- d. LISN at least 80 cm from nearest part of EUT chassis.
- e. For the actual test configuration, please refer to the related Item –EUT Test Photos.

3.1.3 TEST SETUP

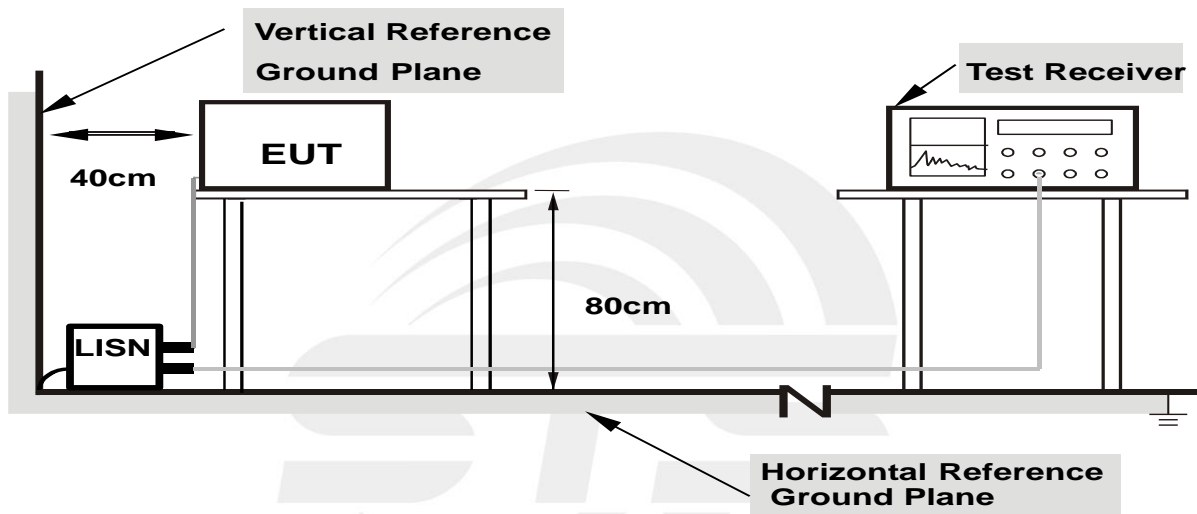

Note: 1.Support units were connected to second LISN.

2.Both of LISNs (AMN) are 80 cm from EUT and at least 80 from other units and other metal planes

3.1.4 EUT OPERATING CONDITIONS

The EUT was configured for testing in a typical fashion (as a customer would normally use it). The EUT has been programmed to continuously transmit during test. This operating condition was tested and used to collect the included data.



3.1.5 TEST RESULT

Temperature:	23.5 °C	Relative Humidity:	59%
Pressure:	1010hPa	Phase:	L
Test Voltage:	AC 120V/60Hz	Test Mode:	Mode 10

Frequency (MHz)	Reading (dBuV)	Correct Factor(dB)	Result (dBuV)	Limit (dBuV)	Margin (dB)	Remark
0.1500	42.62	9.79	52.41	66.00	-13.59	QP
0.1500	23.89	9.79	33.68	56.00	-22.32	AVG
0.1980	35.16	9.78	44.94	63.69	-18.75	QP
0.1980	13.21	9.78	22.99	53.69	-30.70	AVG
0.2740	33.50	10.11	43.61	61.00	-17.39	QP
0.2740	11.59	10.11	21.70	51.00	-29.30	AVG
0.6900	24.50	9.85	34.35	56.00	-21.65	QP
0.6900	4.26	9.85	14.11	46.00	-31.89	AVG
2.3740	22.47	9.80	32.27	56.00	-23.73	QP
2.3740	4.22	9.80	14.02	46.00	-31.98	AVG
24.2460	26.86	10.20	37.06	60.00	-22.94	QP
24.2460	10.53	10.20	20.73	50.00	-29.27	AVG

Remark:

1. All readings are Quasi-Peak and Average values.
2. Margin = Result (Result =Reading + Factor) –Limit

100.0 dBuV

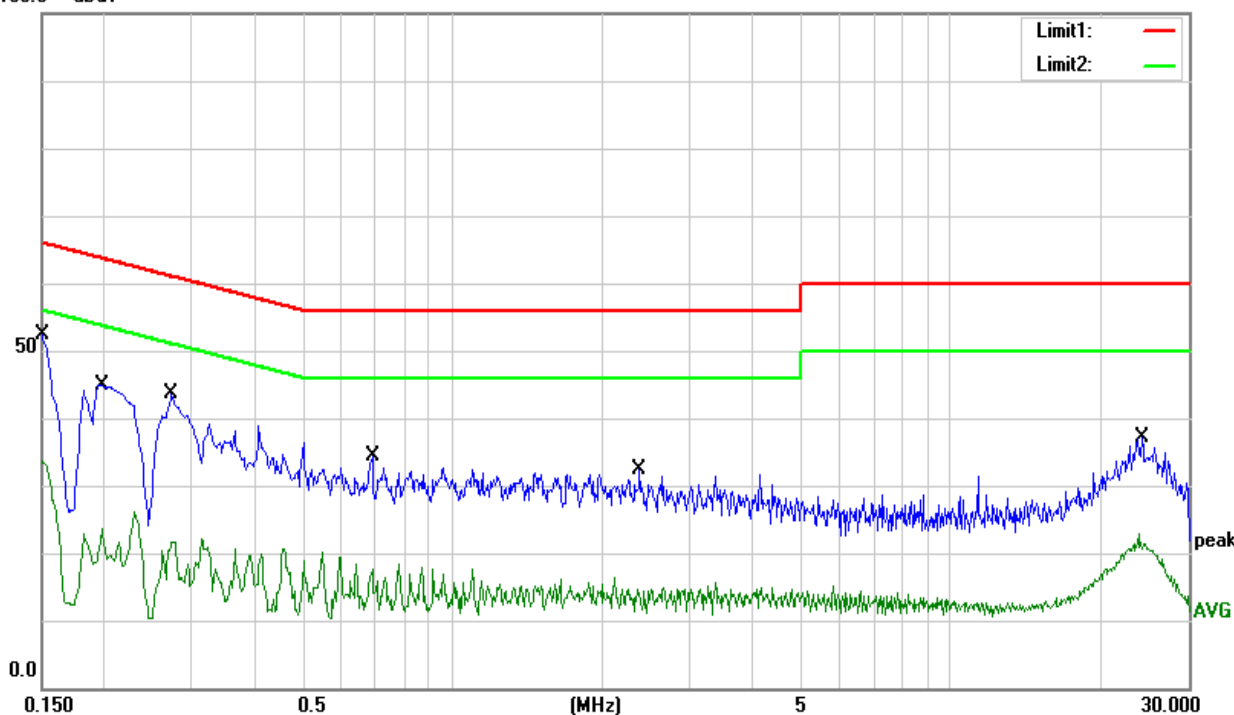



Temperature:	23.5 °C	Relative Humidity:	59%
Pressure:	1010hPa	Phase:	N
Test Voltage:	AC 120V/60Hz	Test Mode:	Mode 10

Frequency (MHz)	Reading (dBuV)	Correct Factor(dB)	Result (dBuV)	Limit (dBuV)	Margin (dB)	Remark
0.1500	38.58	9.75	48.33	66.00	-17.67	QP
0.1500	19.25	9.75	29.00	56.00	-27.00	AVG
0.2020	33.61	9.88	43.49	63.53	-20.04	QP
0.2020	8.44	9.88	18.32	53.53	-35.21	AVG
0.2780	30.96	10.18	41.14	60.88	-19.74	QP
0.2780	10.00	10.18	20.18	50.88	-30.70	AVG
0.8220	20.70	9.84	30.54	56.00	-25.46	QP
0.8220	4.33	9.84	14.17	46.00	-31.83	AVG
2.5220	19.34	9.90	29.24	56.00	-26.76	QP
2.5220	1.03	9.90	10.93	46.00	-35.07	AVG
24.8580	26.24	10.28	36.52	60.00	-23.48	QP
24.8580	9.41	10.28	19.69	50.00	-30.31	AVG

Remark:

1. All readings are Quasi-Peak and Average values.
2. Margin = Result (Result = Reading + Factor) – Limit

100.0 dBuV

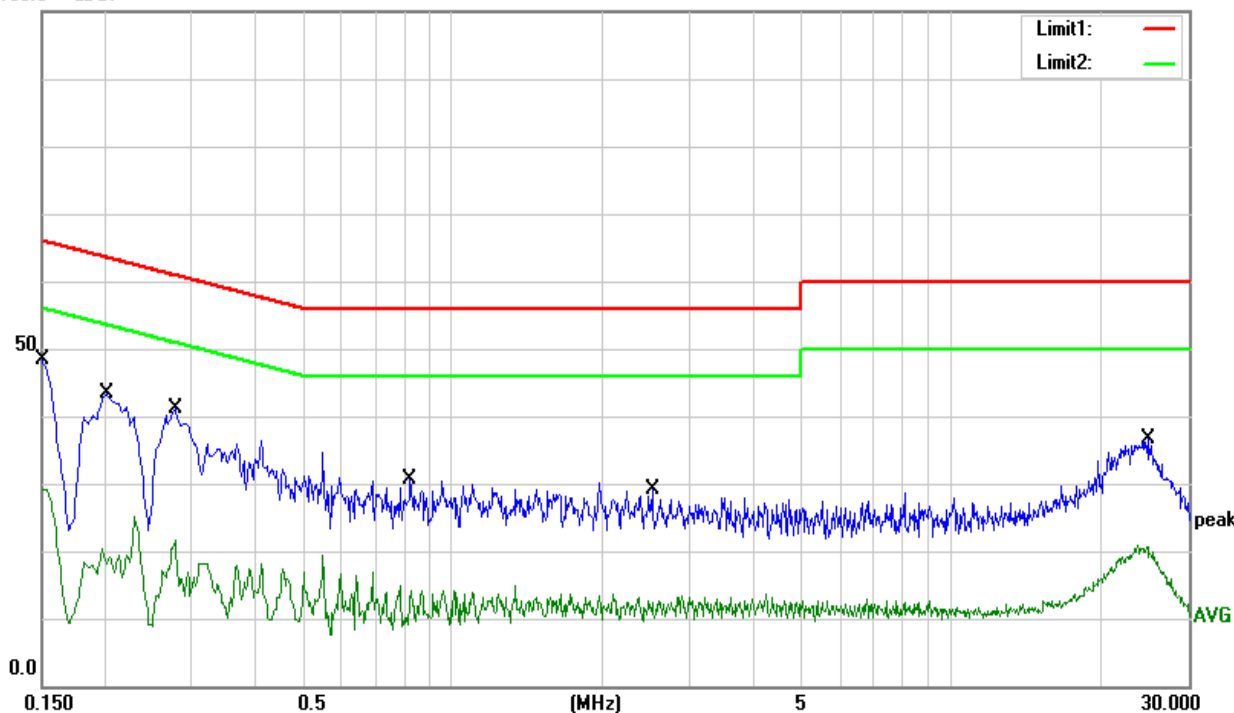



3.2 RADIATED EMISSION MEASUREMENT

3.2.1 RADIATED EMISSION LIMITS

in any 100 kHz bandwidth outside the operating frequency band. In case the emission fall within the Restricted band specified on Part15.205(a)&209(a) limit in the table and according to ANSI C63.10-2013 below has to be followed.

LIMITS OF RADIATED EMISSION MEASUREMENT (0.009MHz - 1000MHz)

Frequencies (MHz)	Field Strength (micovolts/meter)	Measurement Distance (meters)
0.009~0.490	2400/F(KHz)	300
0.490~1.705	24000/F(KHz)	30
1.705~30.0	30	30
30~88	100	3
88~216	150	3
216~960	200	3
Above 960	500	3

LIMITS OF RADIATED EMISSION MEASUREMENT (1000MHz-25GHz)

FREQUENCY (MHz)	(dBuV/m) (at 3M)	
	PEAK	AVERAGE
Above 1000	74	54

Notes:

- (1) The limit for radiated test was performed according to FCC PART 15C.
- (2) The tighter limit applies at the band edges.
- (3) Emission level (dBuV/m)=20log Emission level (uV/m).

For Radiated Emission

Spectrum Parameter	Setting
Attenuation	Auto
Detector	Peak
Start Frequency	1000 MHz(Peak/AV)
Stop Frequency	10th carrier hamonic(Peak/AV)
RB / VB (emission in restricted band)	1 MHz /3MHz

For Band edge

Spectrum Parameter	Setting
Detector	Peak
Start/Stop Frequency	Lower Band Edge: 2300 to 2422 MHz Upper Band Edge: 2452 to 2500 MHz
RB / VB (emission in restricted band)	1 MHz /3MHz



Receiver Parameter	Setting
Start ~ Stop Frequency	9kHz~90kHz / RB 200Hz for PK & AV
Start ~ Stop Frequency	90kHz~110kHz / RB 200Hz for QP
Start ~ Stop Frequency	110kHz~490kHz / RB 200Hz for PK & AV
Start ~ Stop Frequency	490kHz~30MHz / RB 9kHz for QP
Start ~ Stop Frequency	30MHz~1000MHz / RB 120kHz for QP

3.2.2 TEST PROCEDURE

- a. The measuring distance of at 3 m shall be used for measurements at frequency 0.009MHz up to 1GHz, and above 1GHz
- b. The EUT was placed on the top of a rotating table 0.8 meters(above 1GHz is 1.5 m) above the ground at a 3 meter anechoic chamber. The table was rotated 360 degrees to determine the position of the highest radiation.
- c. The height of the equipment shall be 0.8 m(above 1GHz is 1.5 m); the height of the test antenna shall vary between 1 m to 4 m. Horizontal and vertical polarizations of the antenna are set to make the measurement
- d. The initial step in collecting conducted emission data is a spectrum analyzer peak detector mode pre-scanning the measurement frequency range. Significant peaks are then marked and then Quasi Peak detector mode re-measured.
- e. If the Peak Mode measured value compliance with and lower than Quasi Peak Mode Limit, the EUT shall be deemed to meet QP Limits and then no additional QP Mode measurement performed.
- f. For the actual test configuration, please refer to the related Item –EUT Test Photos.

Note:

Both horizontal and vertical antenna polarities were tested and performed test to three orthogonal axis. The worst case emissions were reported

3.2.3 TEST SETUP

(A) Radiated Emission Test-Up Frequency Below 30MHz

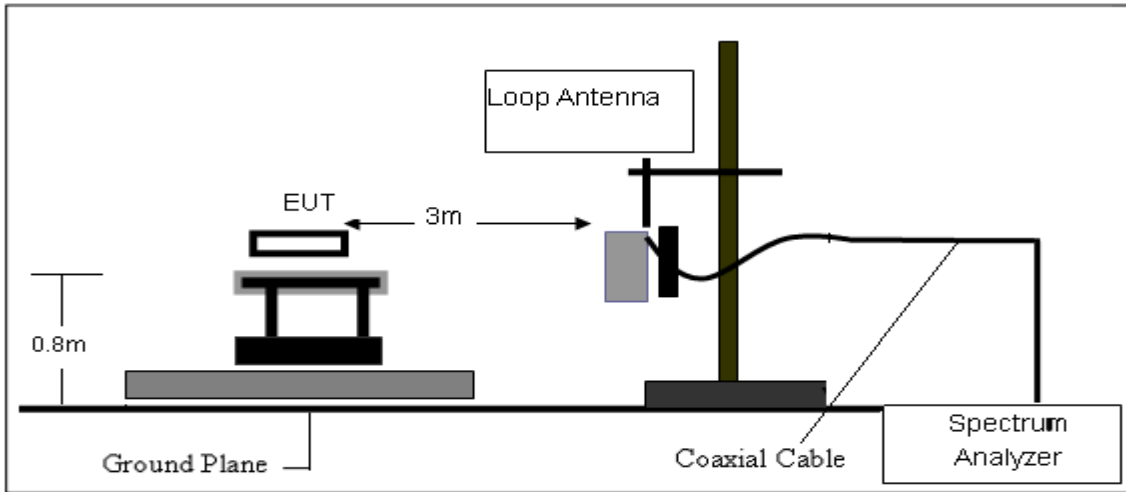

(B) Radiated Emission Test-Up Frequency 30MHz~1GHz

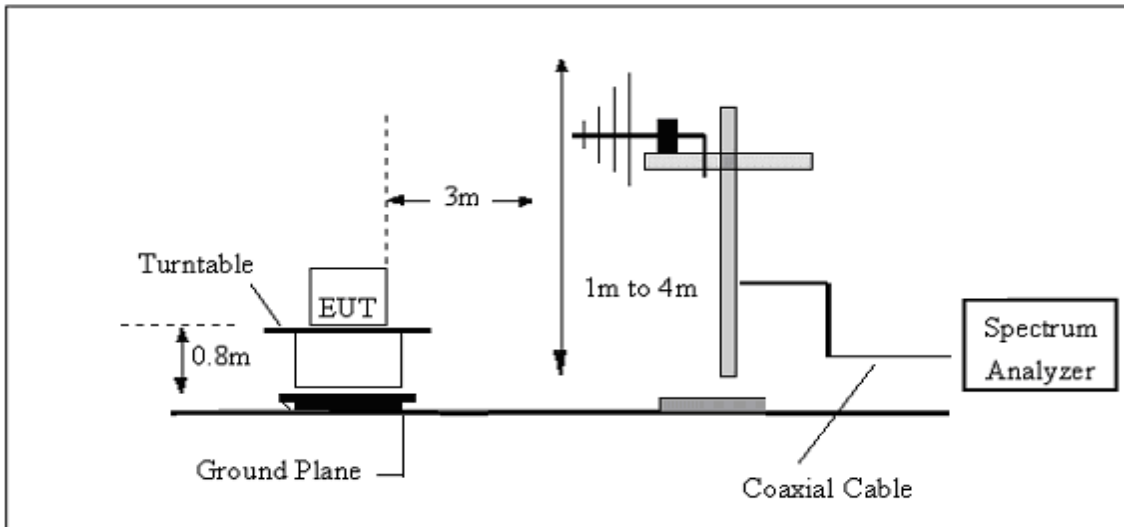

(C) Radiated Emission Test-Up Frequency Above 1GHz

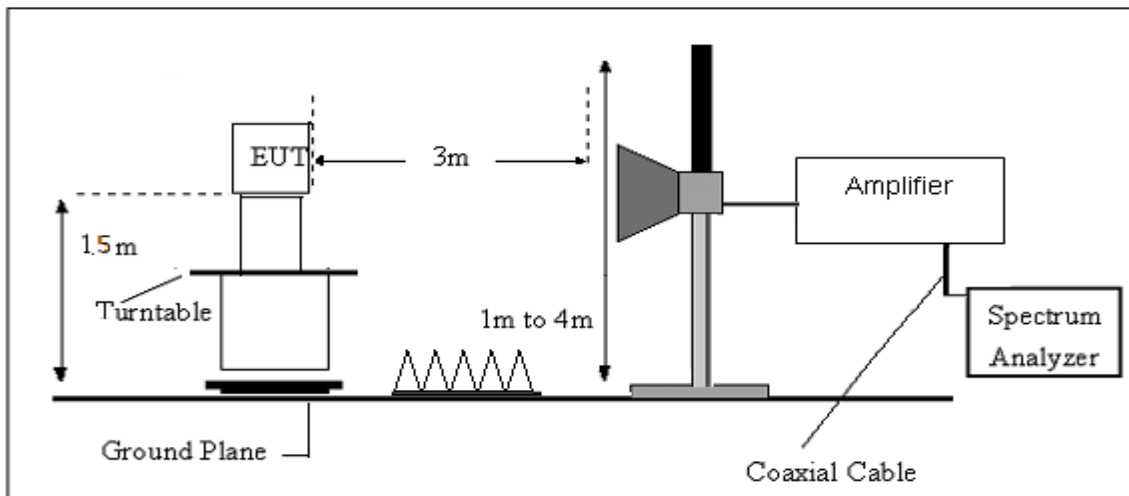

3.2.4 EUT OPERATING CONDITIONS

The EUT tested system was configured as the statements of 2.3 Unless otherwise a special operating condition is specified in the follows during the testing.



3.2.5 FIELD STRENGTH CALCULATION

The field strength is calculated by adding the Antenna Factor and Cable Factor and subtracting the Amplifier Gain and Duty Cycle Correction Factor (if any) from the measured reading. The basic equation with a sample calculation is as follows:

$$FS = RA + AF + CL - AG$$

Where

FS = Field Strength

CL = Cable Attenuation Factor (Cable Loss)

RA = Reading Amplitude

AG = Amplifier Gain

AF = Antenna Factor

For example

Frequency (MHz)	FS (dB μ V/m)	RA (dB μ V/m)	AF (dB)	CL (dB)	AG (dB)	Factor (dB)
300	40	58.1	12.2	1.6	31.9	-18.1

$$\text{Factor} = \text{AF} + \text{CL} - \text{AG}$$





3.2.6 TEST RESULT

9KHz-30MHz

Temperature:	23.5 °C	Relative Humidity:	59%
Pressure:	1010 hPa	Test Voltage:	DC 5V From PC
Test Mode:	TX Mode	Polarization:	--

Freq. (MHz)	Reading (dBuV/m)	Limit (dBuV/m)	Margin (dB)	State P/F	Test Result
--	--	--	--	--	PASS
--	--	--	--	--	PASS

Note:

The amplitude of spurious emissions which are attenuated by more than 20dB below the permissible value has no need to be reported.

Distance extrapolation factor = $40 \log (\text{specific distance}/\text{test distance})$ (dB);

Limit line = specific limits(dBuv) + distance extrapolation factor.



(30MHz - 1000MHz)

Temperature:	24.6 °C	Relative Humidity:	58%
Pressure:	1010 hPa	Test Voltage:	DC 5V From PC
Test Mode:	Mode 1/2/3/4/5/6/7/8/9 (Mode 1-1M worst mode)	Polarization:	Horizontal

Frequency (MHz)	Reading (dBuV)	Correct Factor(dB/m)	Result (dBuV/m)	Limit (dBuV/m)	Margin (dB)	Remark
36.7662	31.30	-14.66	16.64	40.00	-23.36	QP
50.9420	40.38	-21.75	18.63	40.00	-21.37	QP
175.0368	41.95	-19.38	22.57	43.50	-20.93	QP
287.9904	53.24	-15.49	37.75	46.00	-8.25	QP
480.5276	51.31	-9.38	41.93	46.00	-4.07	QP
640.6110	44.97	-6.35	38.62	46.00	-7.38	QP

Remark:

1. Margin = Result (Result = Reading + Factor) – Limit

80.0 dBuV/m

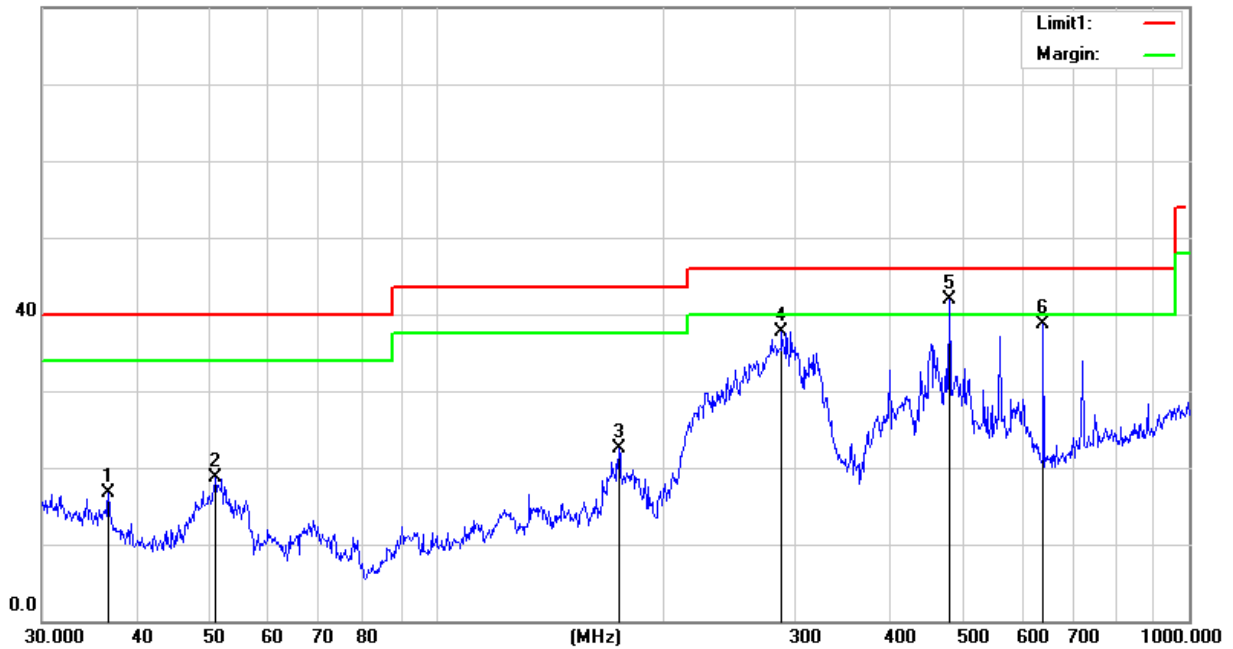



Temperature:	24.6 °C	Relative Humidity:	58%
Pressure:	1010 hPa	Test Voltage:	DC 5V From PC
Test Mode:	Mode 1/2/3/4/5/6/7/8/9 (Mode 1-1M worst mode)	Polarization:	Vertical

Frequency (MHz)	Reading (dBuV)	Correct Factor(dB/m)	Result (dBuV/m)	Limit (dBuV/m)	Margin (dB)	Remark
36.7662	48.13	-14.66	33.47	40.00	-6.53	QP
80.0806	48.06	-22.67	25.39	40.00	-14.61	QP
258.3264	52.61	-15.27	37.34	46.00	-8.66	QP
319.9370	57.03	-14.17	42.86	46.00	-3.14	QP
480.5276	46.59	-9.38	37.21	46.00	-8.79	QP
560.6928	46.54	-6.57	39.97	46.00	-6.03	QP

Remark:.

1. Margin = Result (Result =Reading + Factor)–Limit

80.0 dBuV/m

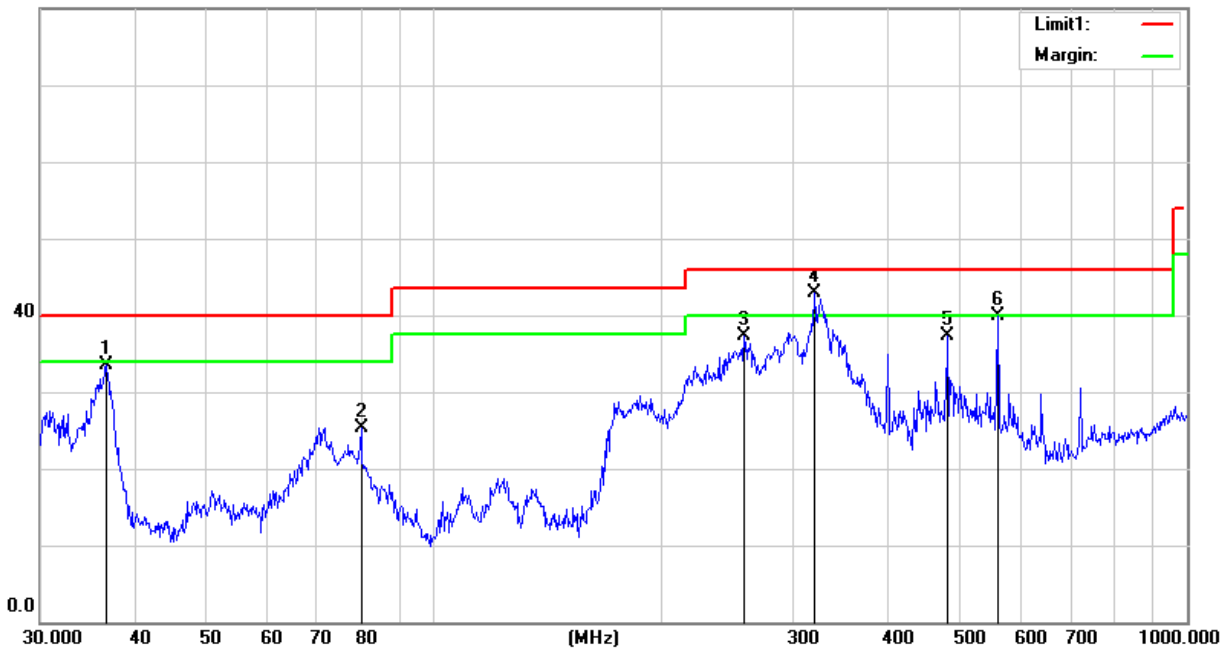



(1000MHz-25GHz) Restricted band and Spurious emission Requirements

802.11b Low Channel

Frequency (MHz)	Reading (dBμV)	Amplifier (dB)	Loss (dB)	Antenna Factor (dB/m)	Corrected Factor (dB)	Emission Level (dBμV/m)	Limits (dBμV/m)	Margin (dB)	Detector Type	Comment
Low Channel (2412 MHz)										
3264.65	48.83	44.70	6.70	28.20	-9.80	39.03	74.00	-34.97	PK	Vertical
3264.65	38.45	44.70	6.70	28.20	-9.80	28.65	54.00	-25.35	AV	Vertical
3264.61	48.94	44.70	6.70	28.20	-9.80	39.14	74.00	-34.86	PK	Horizontal
3264.61	37.95	44.70	6.70	28.20	-9.80	28.15	54.00	-25.85	AV	Horizontal
4824.40	59.47	44.20	9.04	31.60	-3.56	55.91	74.00	-18.09	PK	Vertical
4824.40	38.77	44.20	9.04	31.60	-3.56	35.21	54.00	-18.79	AV	Vertical
4824.54	59.03	44.20	9.04	31.60	-3.56	55.47	74.00	-18.53	PK	Horizontal
4824.54	38.72	44.20	9.04	31.60	-3.56	35.16	54.00	-18.84	AV	Horizontal
5359.64	45.04	44.20	9.86	32.00	-2.34	42.70	74.00	-31.30	PK	Vertical
5359.64	37.39	44.20	9.86	32.00	-2.34	35.05	54.00	-18.95	AV	Vertical
5359.70	46.41	44.20	9.86	32.00	-2.34	44.07	74.00	-29.93	PK	Horizontal
5359.70	37.78	44.20	9.86	32.00	-2.34	35.44	54.00	-18.56	AV	Horizontal
7235.79	51.11	43.50	11.40	35.50	3.40	54.51	74.00	-19.49	PK	Vertical
7235.79	32.81	43.50	11.40	35.50	3.40	36.21	54.00	-17.79	AV	Vertical
7235.93	51.50	43.50	11.40	35.50	3.40	54.90	74.00	-19.10	PK	Horizontal
7235.69	30.65	43.50	11.40	35.50	3.40	34.05	54.00	-19.95	AV	Horizontal



802.11b Mid Channel

Frequency (MHz)	Reading (dBμV)	Amplifier (dB)	Loss (dB)	Antenna Factor (dB/m)	Corrected Factor (dB)	Emission Level (dBμV/m)	Limits (dBμV/m)	Margin (dB)	Detector Type	Comment
Mid Channel (2437 MHz)										
3264.64	49.01	44.70	6.70	28.20	-9.80	39.21	74.00	-34.79	PK	Vertical
3264.64	39.67	44.70	6.70	28.20	-9.80	29.87	54.00	-24.13	AV	Vertical
3264.57	48.65	44.70	6.70	28.20	-9.80	38.85	74.00	-35.15	PK	Horizontal
3264.57	39.07	44.70	6.70	28.20	-9.80	29.27	54.00	-24.73	AV	Horizontal
4874.30	58.83	44.20	9.04	31.60	-3.56	55.27	74.00	-18.73	PK	Vertical
4874.30	38.26	44.20	9.04	31.60	-3.56	34.70	54.00	-19.30	AV	Vertical
4874.31	59.63	44.20	9.04	31.60	-3.56	56.07	74.00	-17.93	PK	Horizontal
4874.31	39.16	44.20	9.04	31.60	-3.56	35.60	54.00	-18.40	AV	Horizontal
5359.84	45.61	44.20	9.86	32.00	-2.34	43.27	74.00	-30.73	PK	Vertical
5359.84	37.64	44.20	9.86	32.00	-2.34	35.30	54.00	-18.70	AV	Vertical
5359.87	45.18	44.20	9.86	32.00	-2.34	42.84	74.00	-31.16	PK	Horizontal
5359.87	38.46	44.20	9.86	32.00	-2.34	36.12	54.00	-17.88	AV	Horizontal
7310.75	50.75	43.50	11.40	35.50	3.40	54.15	74.00	-19.85	PK	Vertical
7310.75	33.52	43.50	11.40	35.50	3.40	36.92	54.00	-17.08	AV	Vertical
7310.95	51.77	43.50	11.40	35.50	3.40	55.17	74.00	-18.83	PK	Horizontal
7310.95	33.48	43.50	11.40	35.50	3.40	36.88	54.00	-17.12	AV	Horizontal



802.11b High Channel

Frequency (MHz)	Reading (dBμV)	Amplifier (dB)	Loss (dB)	Antenna	Corrected	Emission				
				Factor (dB/m)	Factor (dB)	Level (dBμV/m)	Limits (dBμV/m)	Margin (dB)	Detector Type	Comment
High Channel (2462 MHz)										
3264.66	48.76	44.70	6.70	28.20	-9.80	38.96	74.00	-35.04	PK	Vertical
3264.66	39.09	44.70	6.70	28.20	-9.80	29.29	54.00	-24.71	AV	Vertical
3264.70	48.28	44.70	6.70	28.20	-9.80	38.48	74.00	-35.52	PK	Horizontal
3264.70	39.13	44.70	6.70	28.20	-9.80	29.33	54.00	-24.67	AV	Horizontal
4924.53	58.15	44.20	9.04	31.60	-3.56	54.59	74.00	-19.41	PK	Vertical
4924.53	38.55	44.20	9.04	31.60	-3.56	34.99	54.00	-19.01	AV	Vertical
4924.54	58.46	44.20	9.04	31.60	-3.56	54.90	74.00	-19.10	PK	Horizontal
4924.54	39.51	44.20	9.04	31.60	-3.56	35.95	54.00	-18.05	AV	Horizontal
5359.60	46.19	44.20	9.86	32.00	-2.34	43.85	74.00	-30.15	PK	Vertical
5359.60	37.71	44.20	9.86	32.00	-2.34	35.37	54.00	-18.63	AV	Vertical
5359.57	45.21	44.20	9.86	32.00	-2.34	42.87	74.00	-31.13	PK	Horizontal
5359.57	37.84	44.20	9.86	32.00	-2.34	35.50	54.00	-18.50	AV	Horizontal
7385.95	51.06	43.50	11.40	35.50	3.40	54.46	74.00	-19.54	PK	Vertical
7385.95	33.90	43.50	11.40	35.50	3.40	37.30	54.00	-16.70	AV	Vertical
7385.81	50.82	43.50	11.40	35.50	3.40	54.22	74.00	-19.78	PK	Horizontal
7385.81	33.69	43.50	11.40	35.50	3.40	37.09	54.00	-16.91	AV	Horizontal

Remark:

- Factor = Antenna Factor + Cable Loss – Pre-amplifier.
- Scan with 802.11b, 802.11g, 802.11n (HT-20) the worst case is 802.11b.
 Emission Level = Reading + Factor
 Margin = Limit - Emission Level
- The frequency emission of peak points that did not show above the forms are at least 20dB below the limit, the frequency emission is mainly from the environment noise.



3.2.6 TEST RESULTS (Band edge Requirements)

Frequency (MHz)	Reading (dBμV)	Amplifier (dB)	Loss (dB)	Antenna Factor (dB/m)	Corrected Factor (dB)	Emission Level (dBμV/m)	Limits (dBμV/m)	Margin (dB)	Detector Type	Comment
802.11b										
2390.00	68.08	43.80	4.91	25.90	-12.99	55.09	74.00	-18.91	PK	Vertical
2390.00	54.25	43.80	4.91	25.90	-12.99	41.26	54.00	-12.74	AV	Vertical
2390.00	68.67	43.80	4.91	25.90	-12.99	55.68	74.00	-18.32	PK	Horizontal
2390.00	53.01	43.80	4.91	25.90	-12.99	40.02	54.00	-13.98	AV	Horizontal
2483.50	69.12	43.80	5.12	25.90	-12.78	56.34	74.00	-17.66	PK	Vertical
2483.50	52.69	43.80	5.12	25.90	-12.78	39.91	54.00	-14.09	AV	Vertical
2483.50	70.57	43.80	5.12	25.90	-12.78	57.79	74.00	-16.21	PK	Horizontal
2483.50	52.66	43.80	5.12	25.90	-12.78	39.88	54.00	-14.12	AV	Horizontal
802.11g										
2390.00	66.70	43.80	4.91	25.90	-12.99	53.71	74.00	-20.29	PK	Vertical
2390.00	52.74	43.80	4.91	25.90	-12.99	39.75	54.00	-14.25	AV	Vertical
2390.00	65.39	43.80	4.91	25.90	-12.99	52.40	74.00	-21.60	PK	Horizontal
2390.00	54.45	43.80	4.91	25.90	-12.99	41.46	54.00	-12.54	AV	Horizontal
2483.50	66.27	43.80	5.12	25.90	-12.78	53.49	74.00	-20.51	PK	Vertical
2483.50	53.51	43.80	5.12	25.90	-12.78	40.73	54.00	-13.27	AV	Vertical
2483.50	65.28	43.80	5.12	25.90	-12.78	52.50	74.00	-21.50	PK	Horizontal
2483.50	53.27	43.80	5.12	25.90	-12.78	40.49	54.00	-13.51	AV	Horizontal
802.11n20										
2390.00	67.09	43.80	4.91	25.90	-12.99	54.10	74.00	-19.90	PK	Vertical
2390.00	52.78	43.80	4.91	25.90	-12.99	39.79	54.00	-14.21	AV	Vertical
2390.00	65.68	43.80	4.91	25.90	-12.99	52.69	74.00	-21.31	PK	Horizontal
2390.00	53.51	43.80	4.91	25.90	-12.99	40.52	54.00	-13.48	AV	Horizontal
2483.50	65.61	43.80	5.12	25.90	-12.78	52.83	74.00	-21.17	PK	Vertical
2483.50	53.19	43.80	5.12	25.90	-12.78	40.41	54.00	-13.59	AV	Vertical
2483.50	65.58	43.80	5.12	25.90	-12.78	52.80	74.00	-21.20	PK	Horizontal
2483.50	52.28	43.80	5.12	25.90	-12.78	39.50	54.00	-14.50	AV	Horizontal

Remark: Factor = Antenna Factor + Cable Loss – Pre-amplifier.
 Low measurement frequencies is range from 2300 to 2422 MHz, high measurement frequencies is range from 2452 to 2500 MHz.
 Only show the worst point data of the emissions in the frequency 2300-2422 MHz and 2452-2500 MHz.

4. CONDUCTED SPURIOUS & BAND EDGE EMISSION

4.1 APPLIED PROCEDURES / LIMIT

According to FCC section 15.247(d), in any 100kHz bandwidth outside the frequency band in which the spread spectrum or digitally modulated intentional radiator is operating, the radio frequency power that is produced by the intentional radiator shall be at least 20dB below that in the 100kHz bandwidth within the band that contains the highest level of the desired power, based on either an RF conducted or a radiated measurement.

4.2 TEST PROCEDURE

Spectrum Parameter	Setting
Detector	Peak
Start/Stop Frequency	30 MHz to 10th carrier harmonic
RB / VB (emission in restricted band)	100 KHz/300 KHz
Trace-Mode:	Max hold

For Band edge

Spectrum Parameter	Setting
Detector	Peak
Start/Stop Frequency	Lower Band Edge: 2300 to 2422 MHz Upper Band Edge: 2452 to 2500 MHz
RB / VB (emission in restricted band)	100 KHz/300 KHz
Trace-Mode:	Max hold

4.3 DEVIATION FROM STANDARD

No deviation.

4.4 TEST SETUP

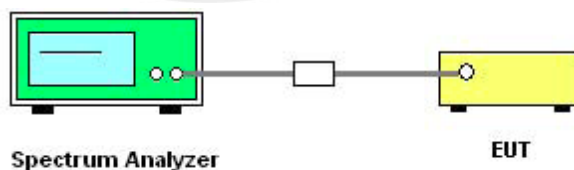

The EUT which is powered by the Battery, is coupled to the Spectrum Analyzer; the RF load attached to the EUT antenna terminal is 50Ohm; the path loss as the factor is calibrated to correct the reading.

Make the measurement with the spectrum analyzer's resolution bandwidth (RBW) = 100 kHz. In order to make an accurate measurement, set the span greater than RBW.

4.5 EUT OPERATION CONDITIONS

The EUT tested system was configured as the statements of 2.3 Unless otherwise a special operating condition is specified in the follows during the testing.



4.6 TEST RESULTS

Temperature:	25 °C	Relative Humidity:	60%
Pressure:	1015 hPa	Test Voltage:	DC 5V From PC
Test Mode:	TX b Mode /CH01, CH06, CH11		

CH 01

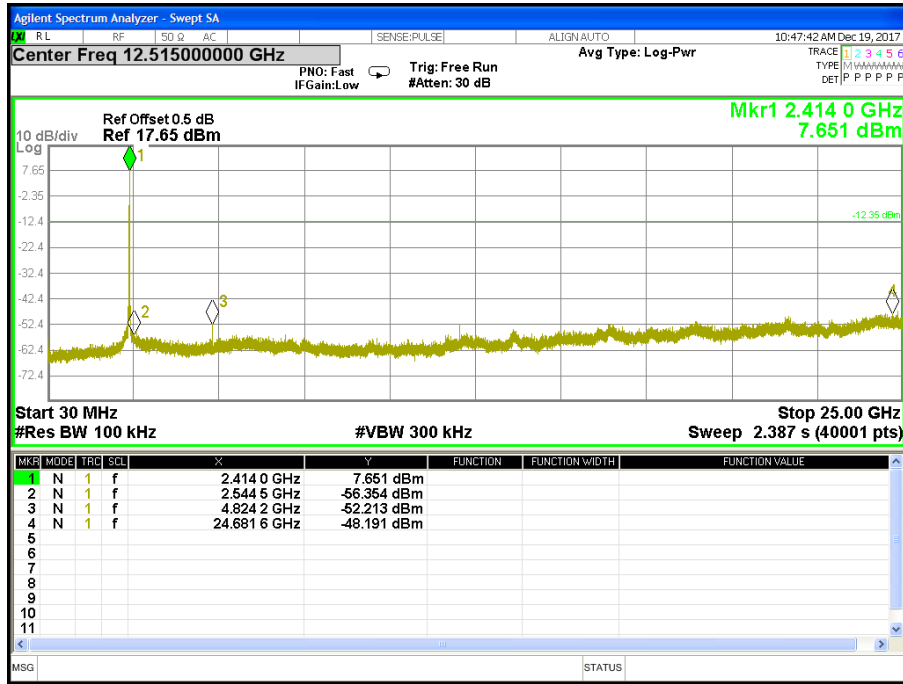

CH 06

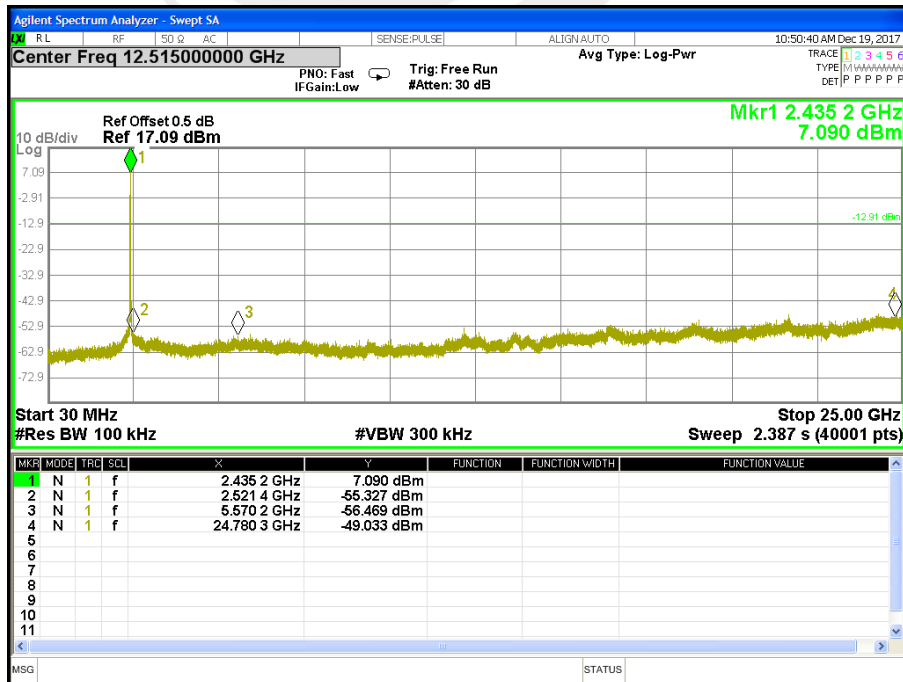



CH 11

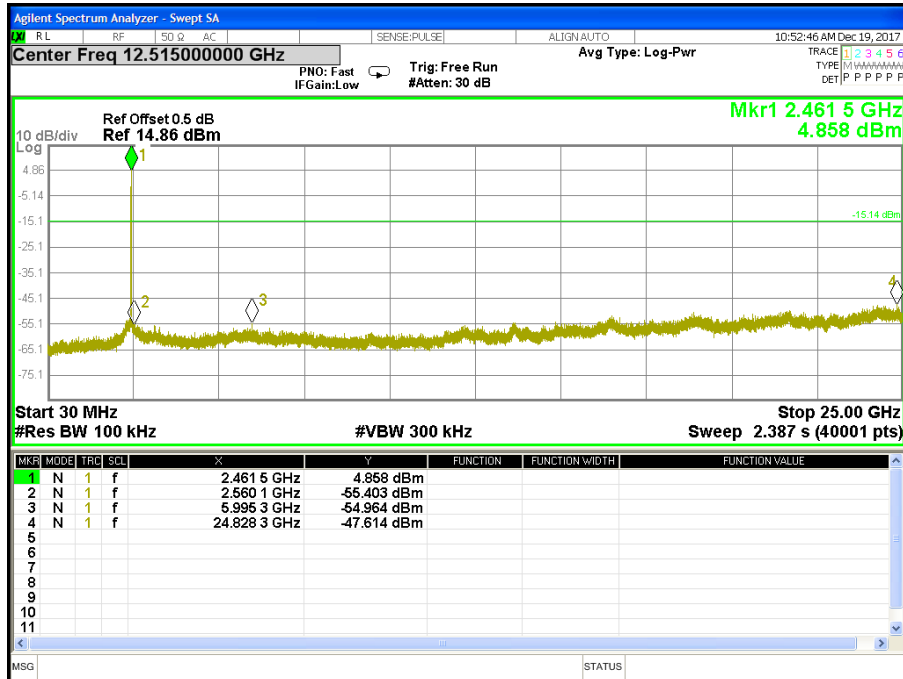



Band edge

CH 01

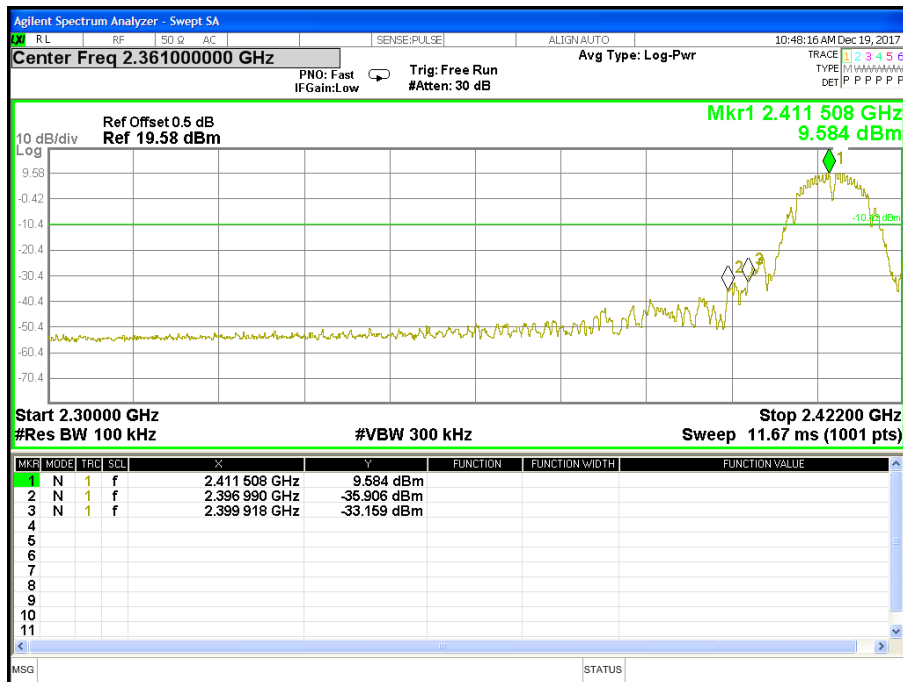

CH 11

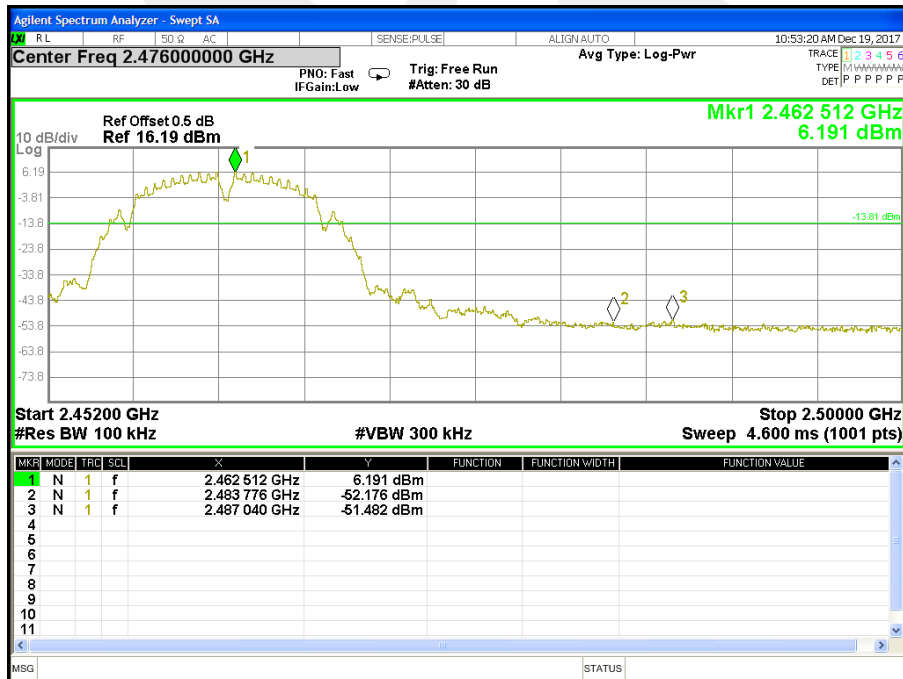



Temperature:	25 °C	Relative Humidity:	60%
Pressure:	1015 hPa	Test Voltage:	DC 5V From PC
Test Mode:	TX g Mode /CH01, CH06, CH11		

CH 01

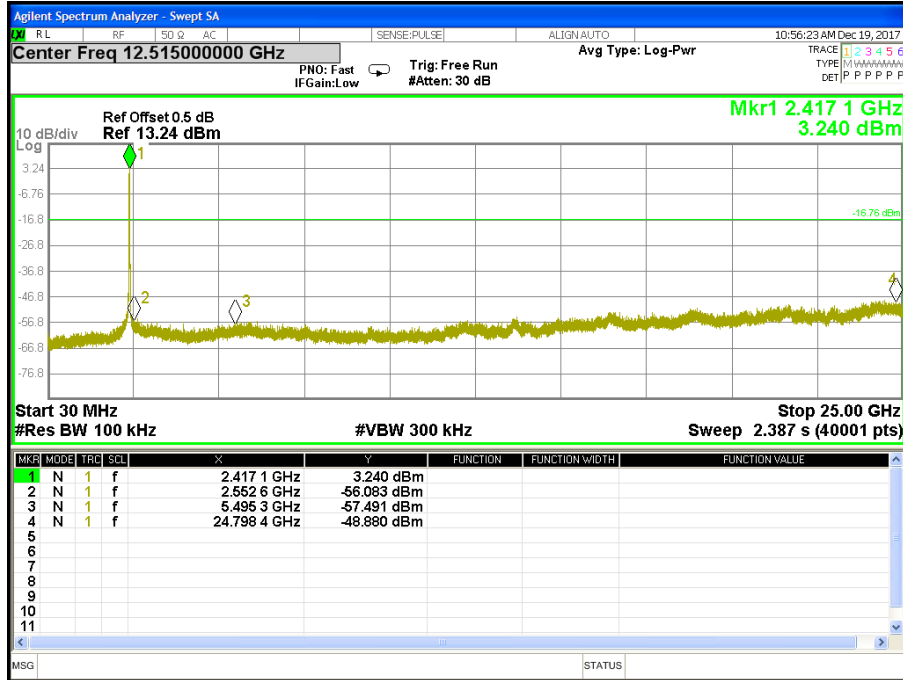

CH06

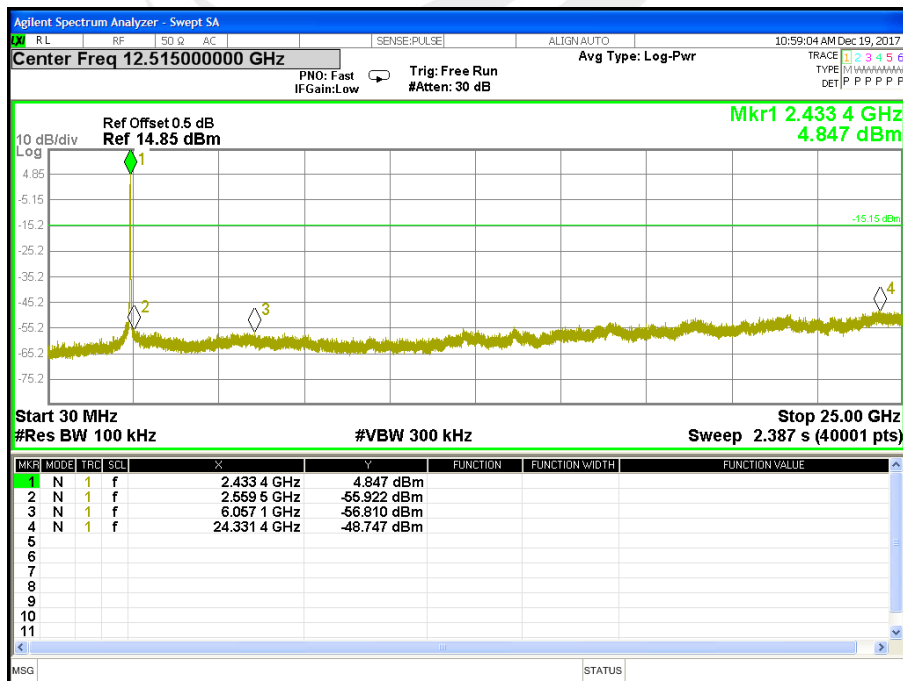



CH 11

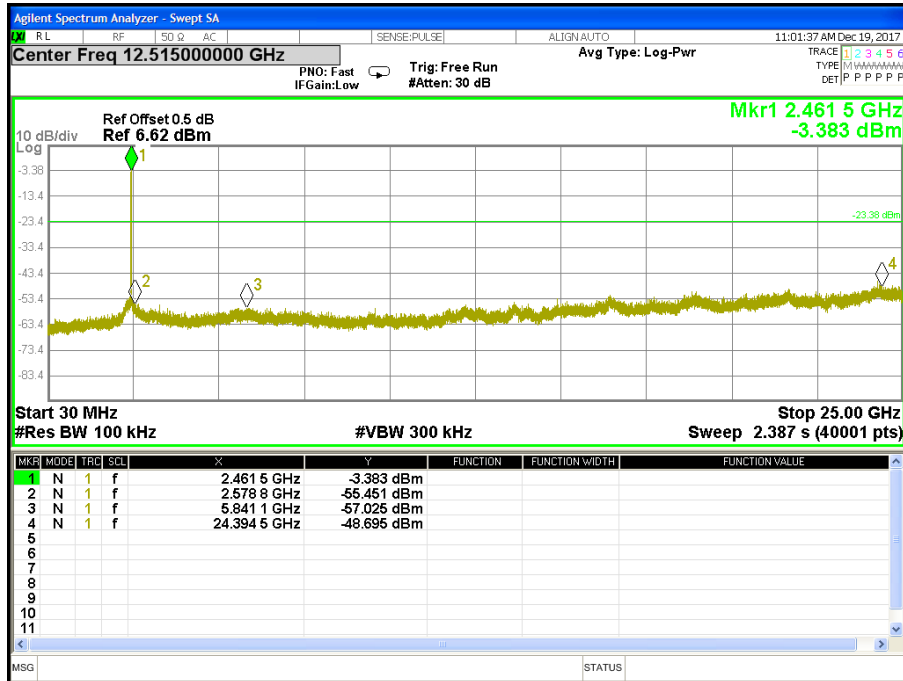



Band edge

CH 01

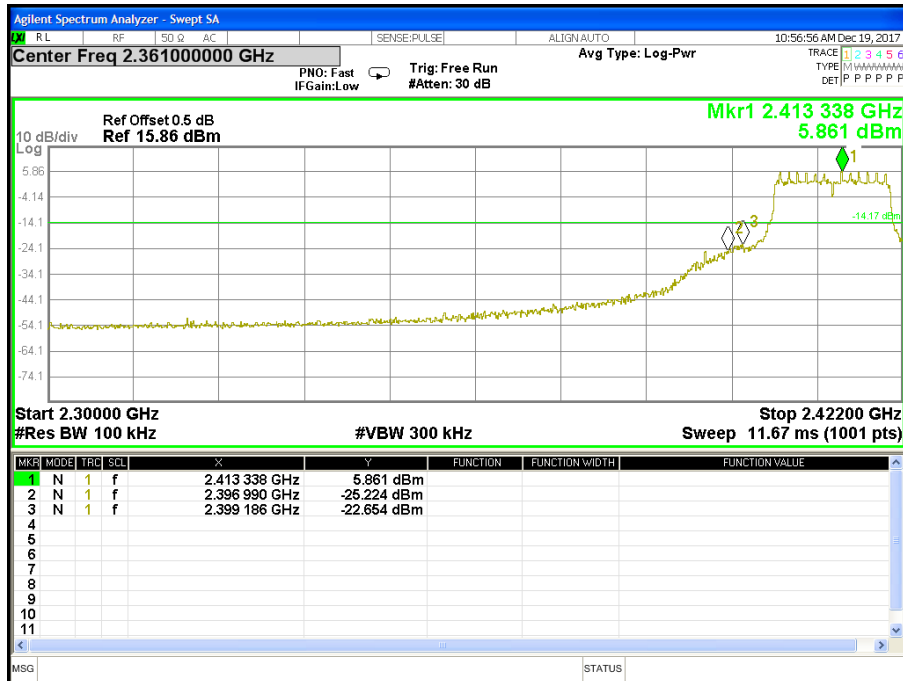

CH11

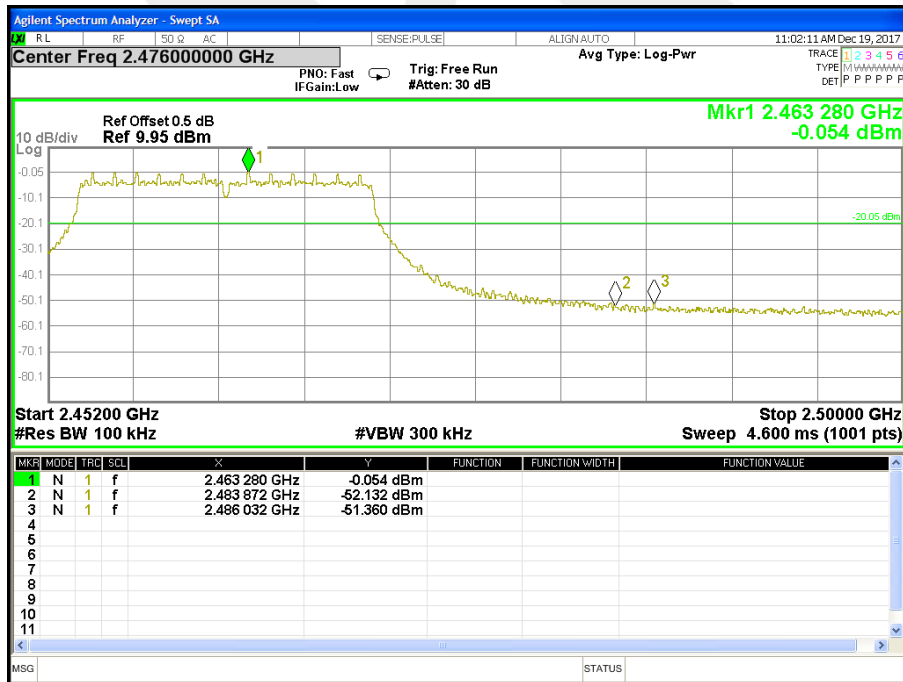



Temperature:	25 °C	Relative Humidity:	60%
Pressure:	1015 hPa	Test Voltage:	DC 5V From PC
Test Mode:	TX n Mode(20M) /CH01, CH06, CH11		

CH 01

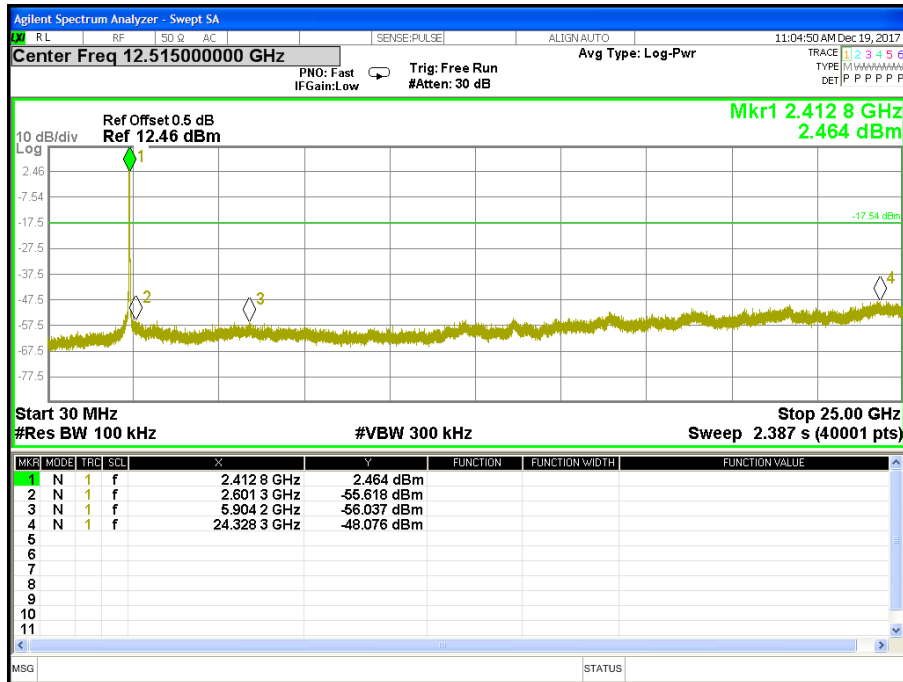

CH 06

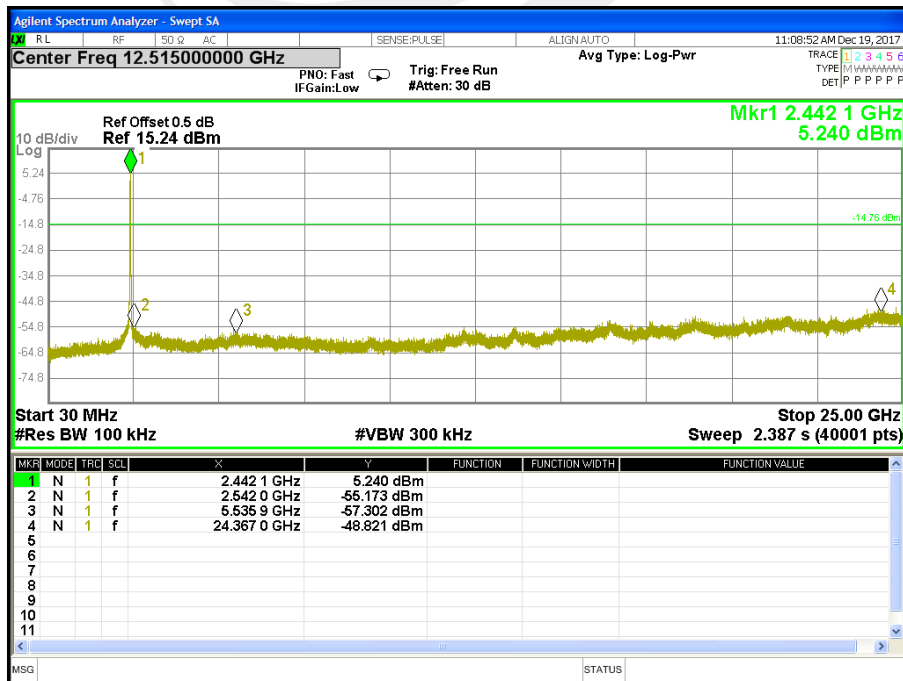



CH 11

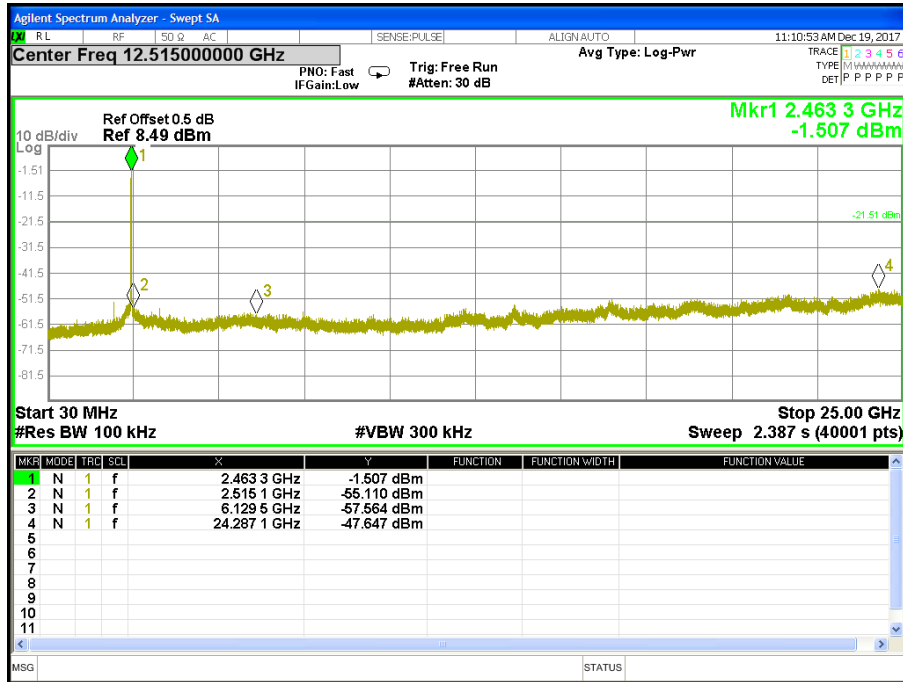



Band edge

CH 01

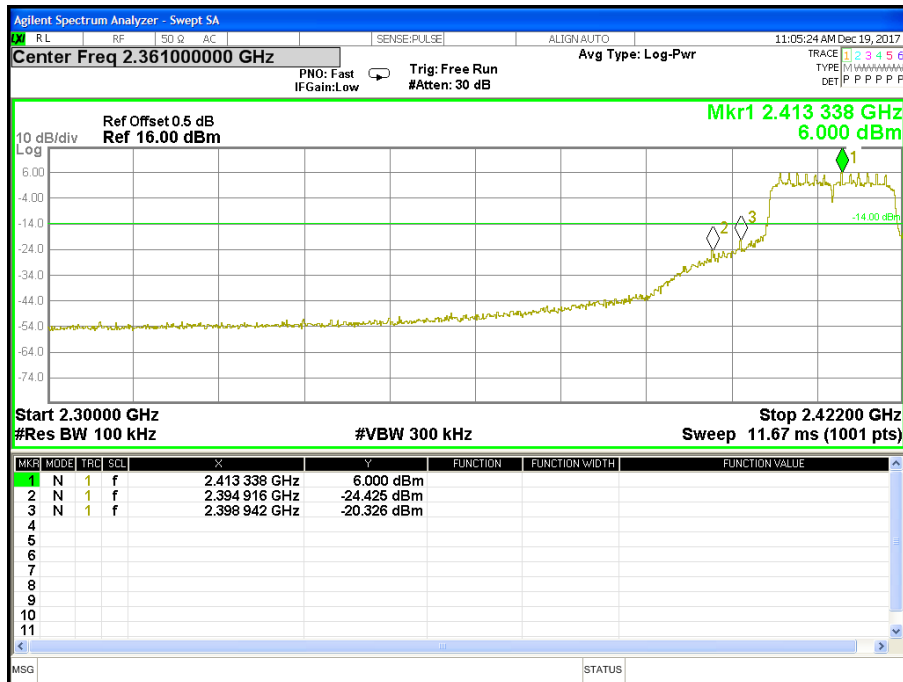

CH 11

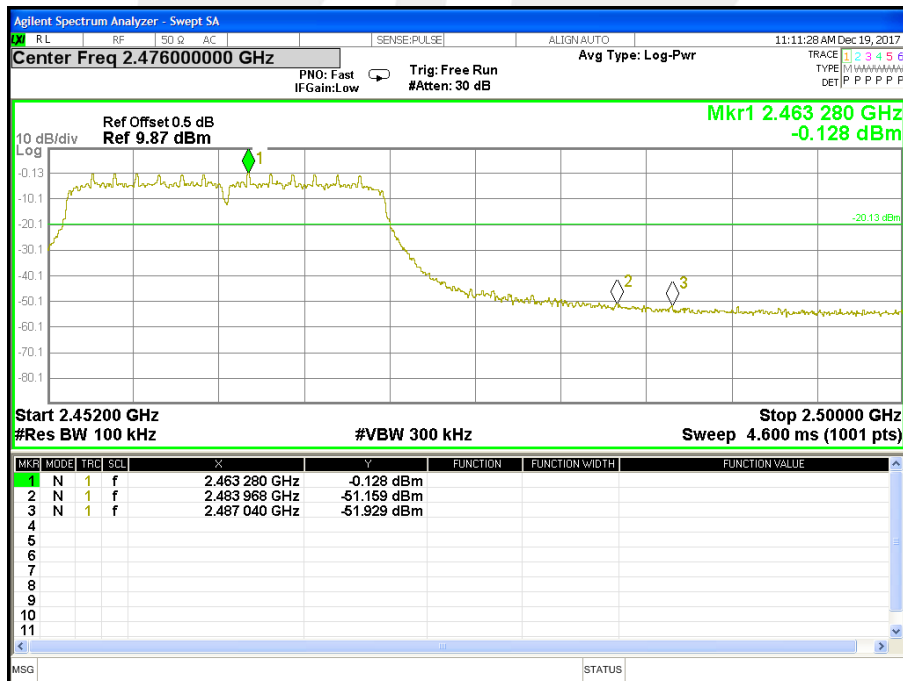



5. POWER SPECTRAL DENSITY TEST

5.1 APPLIED PROCEDURES / LIMIT

FCC Part15.247 , Subpart C				
Section	Test Item	Limit	Frequency Range (MHz)	Result
15.247(e)	Power Spectral Density	≤ 8 dBm (RBW ≥ 3 KHz)	2400-2483.5	PASS

5.2 TEST PROCEDURE

1. Set analyzer center frequency to DTS channel center frequency.
2. Set the span to 1.5 times the DTS channel bandwidth.
3. Set the $100 \text{ kHz} \geq \text{RBW} \geq 3 \text{ kHz}$.
4. Set the $\text{VBW} \geq 3 \times \text{RBW}$.
5. Detector = peak.
6. Sweep time = auto couple.
7. Trace mode = max hold.
8. Allow trace to fully stabilize.
9. Use the peak marker function to determine the maximum amplitude level.
10. If measured value exceeds limit, reduce RBW (no less than 3 kHz) and repeat.

5.3 DEVIATION FROM STANDARD

No deviation.

5.4 TEST SETUP



5.5 EUT OPERATION CONDITIONS

The EUT tested system was configured as the statements of 2.3 Unless otherwise a special operating condition is specified in the follows during the testing.



5.6 TEST RESULTS

Temperature:	25 °C	Relative Humidity:	60%
Pressure:	1015 hPa	Test Voltage:	DC 5V From PC
Test Mode:	TX b Mode /CH01, CH06, CH11		

Frequency	Power Density (dBm/3kHz)	Limit (dBm/3KHz)	Result
2412 MHz	-4.698	≤8	PASS
2437 MHz	-6.956	≤8	PASS
2462 MHz	-8.073	≤8	PASS

TX CH01

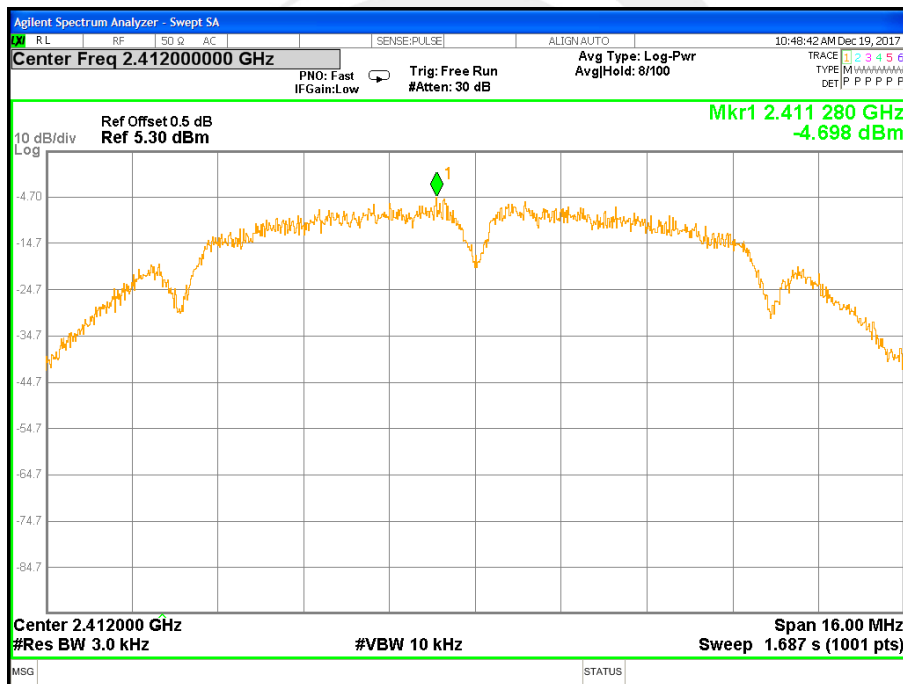



TX CH06

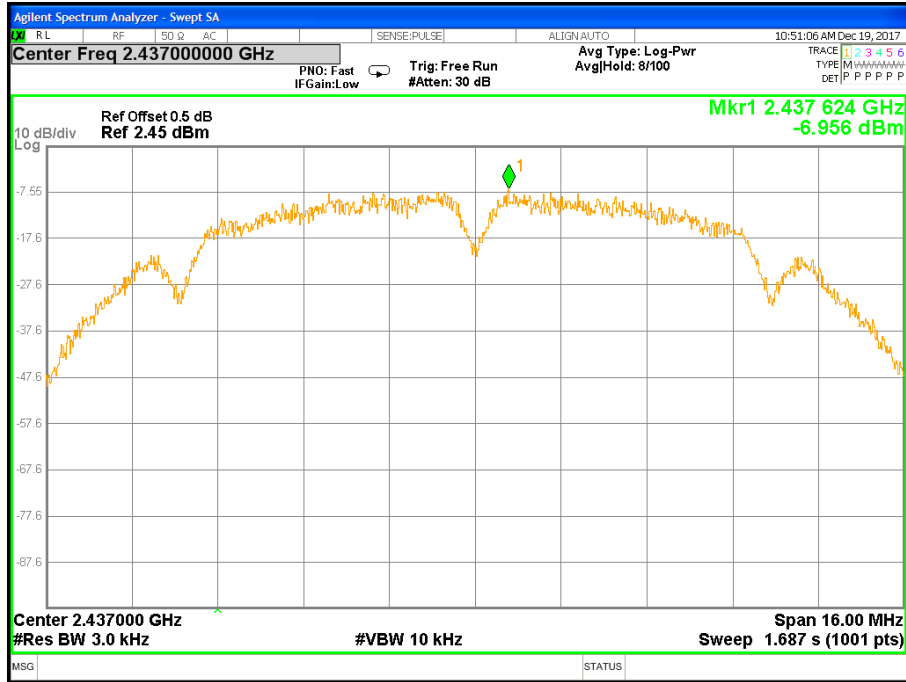

TX CH11

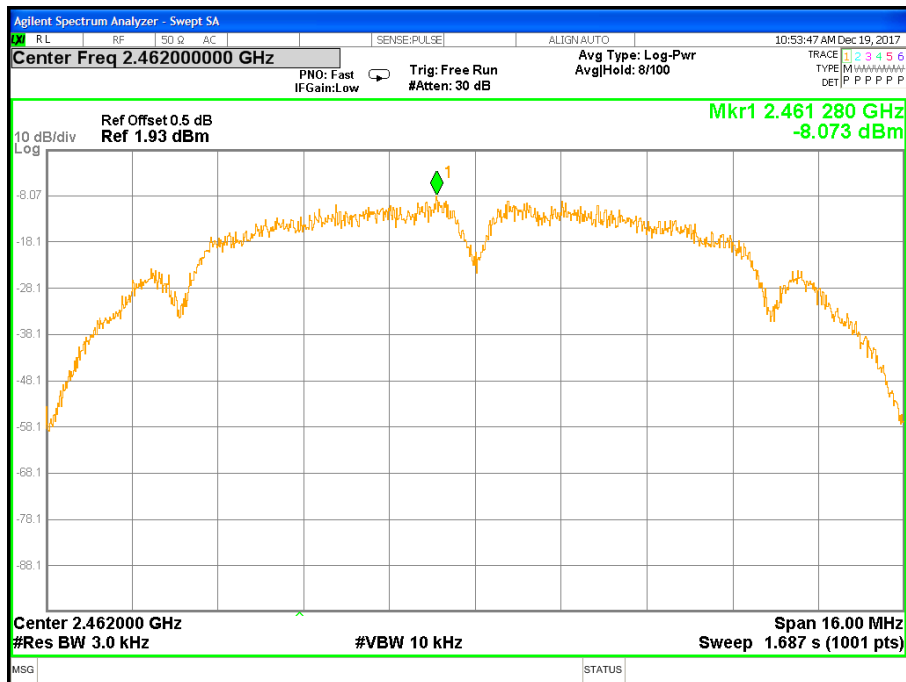



Temperature:	25 °C	Relative Humidity:	60%
Pressure:	1015 hPa	Test Voltage:	DC 5V From PC
Test Mode:	TX g Mode /CH01, CH06, CH11		

Frequency	Power Density (dBm/3kHz)	Limit (dBm/3KHz)	Result
2412 MHz	-8.763	≤8	PASS
2437 MHz	-9.207	≤8	PASS
2462 MHz	-14.561	≤8	PASS

TX CH01

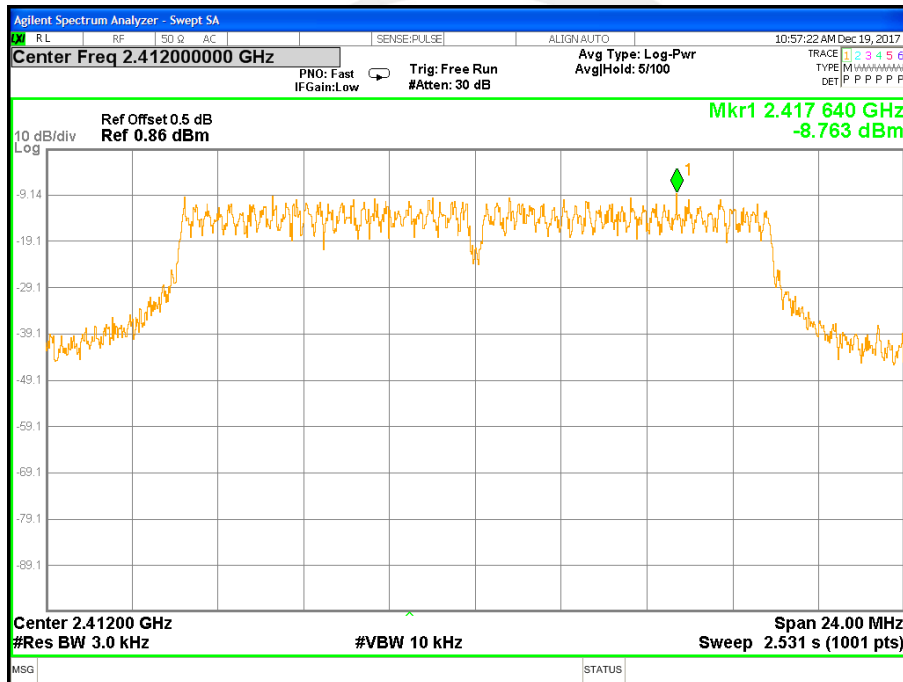



TX CH06

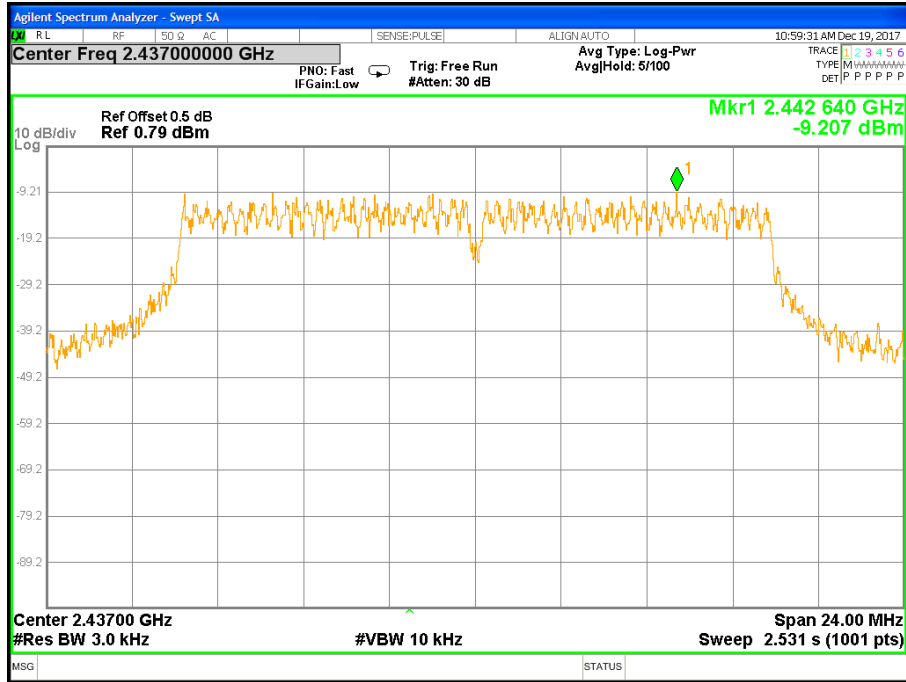

TX CH11

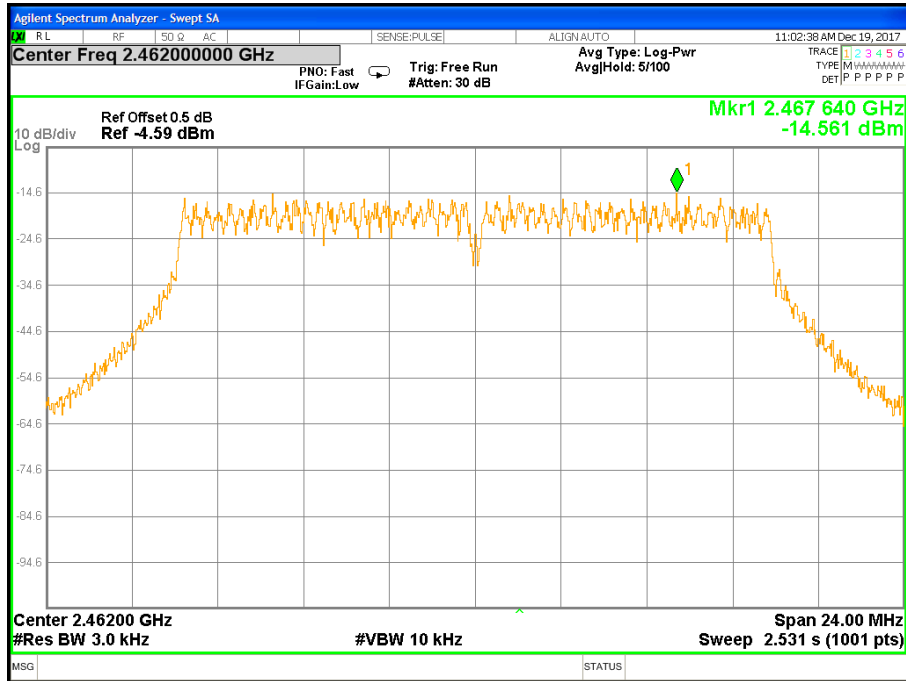



Temperature:	25 °C	Relative Humidity:	60%
Pressure:	1015 hPa	Test Voltage:	DC 5V From PC
Test Mode:	TX n Mode(20M) /CH01, CH06, CH11		

Frequency	Power Density (dBm/3kHz)	Limit (dBm/3KHz)	Result
2412 MHz	-8.903	≤8	PASS
2437 MHz	-9.068	≤8	PASS
2462 MHz	-15.555	≤8	PASS

TX CH01

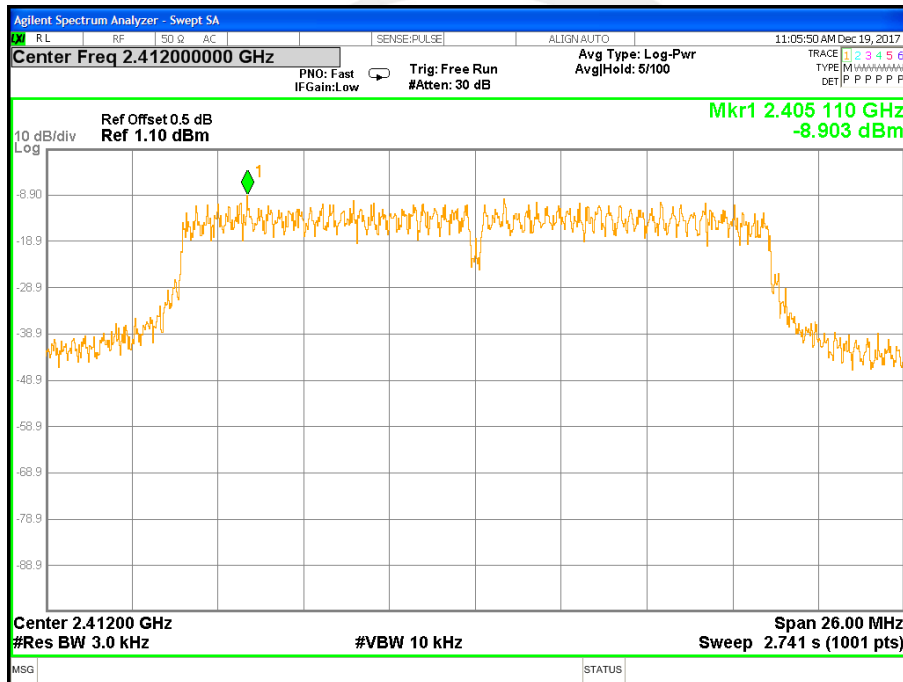



TX CH06

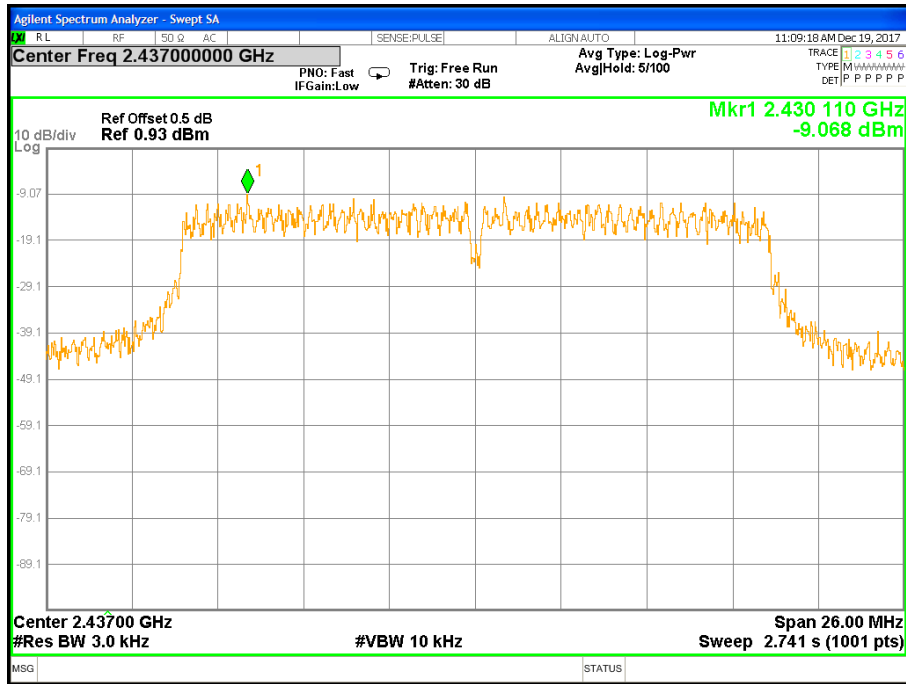

TX CH11

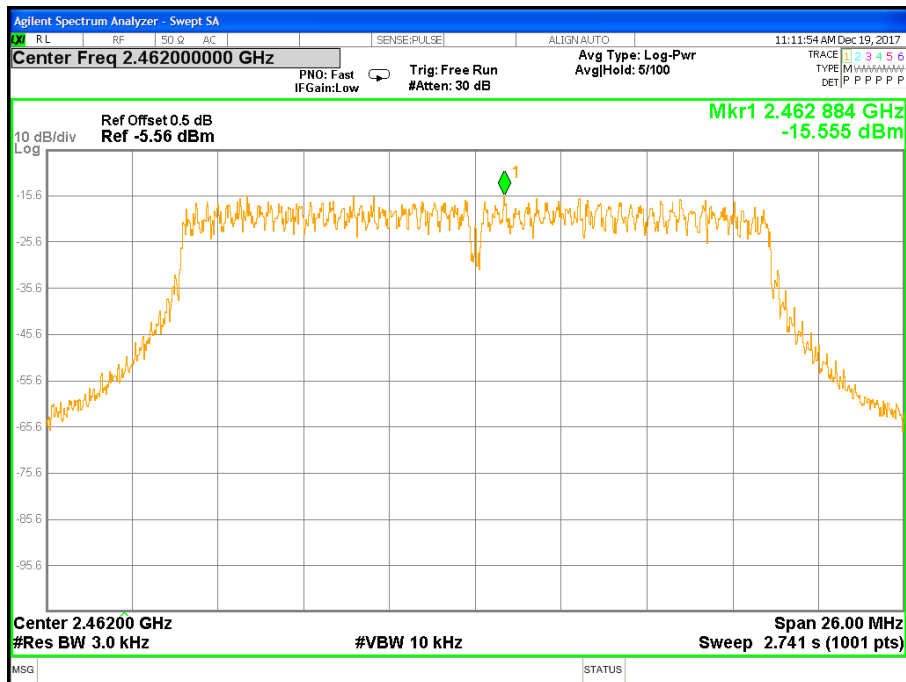



6. BANDWIDTH TEST

6.1 APPLIED PROCEDURES / LIMIT

FCC Part 15.247, Subpart C				
Section	Test Item	Limit	Frequency Range (MHz)	Result
15.247(a)(2)	Bandwidth	$\geq 500\text{KHz}$ (6dB bandwidth)	2400-2483.5	PASS

6.2 TEST PROCEDURE

The automatic bandwidth measurement capability of an instrument may be employed using the X dB bandwidth mode with X set to 6 dB, if the functionality described above (i.e., RBW = 100 kHz, VBW \geq 3RBW, peak detector with maximum hold) is implemented by the instrumentation function. When using this capability, care shall be taken so that the bandwidth measurement is not influenced by any intermediate power nulls in the fundamental emission that might be ≥ 6 dB.

6.3 DEVIATION FROM STANDARD

No deviation.

6.4 TEST SETUP



6.5 EUT OPERATION CONDITIONS

The EUT tested system was configured as the statements of 2.3 Unless otherwise a special operating condition is specified in the follows during the testing.



6.6 TEST RESULTS

Temperature:	25 °C	Relative Humidity:	60%
Pressure:	1012 hPa	Test Voltage:	DC 5V From PC
Test Mode:	TX b Mode /CH01, CH06, CH11		

Remark: PEAK DETECTOR IS USED

Frequency	6dB Bandwidth (MHz)	Channel Separation (KHz)	Result
2412 MHz	9.033	≥500KHz	PASS
2437 MHz	9.035	≥500KHz	PASS
2462 MHz	8.546	≥500KHz	PASS

TX CH 01

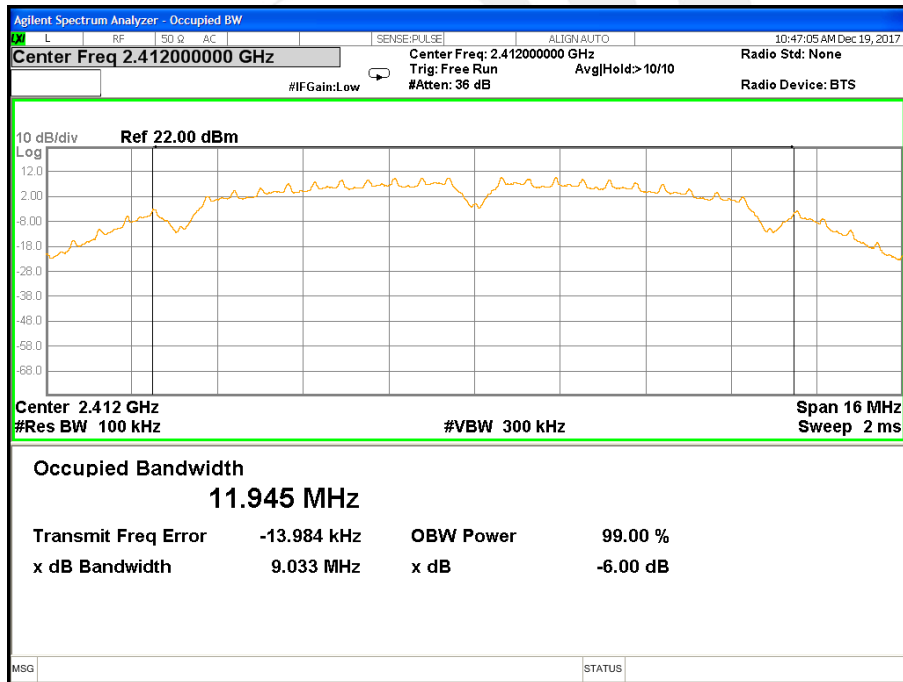



TX CH 06

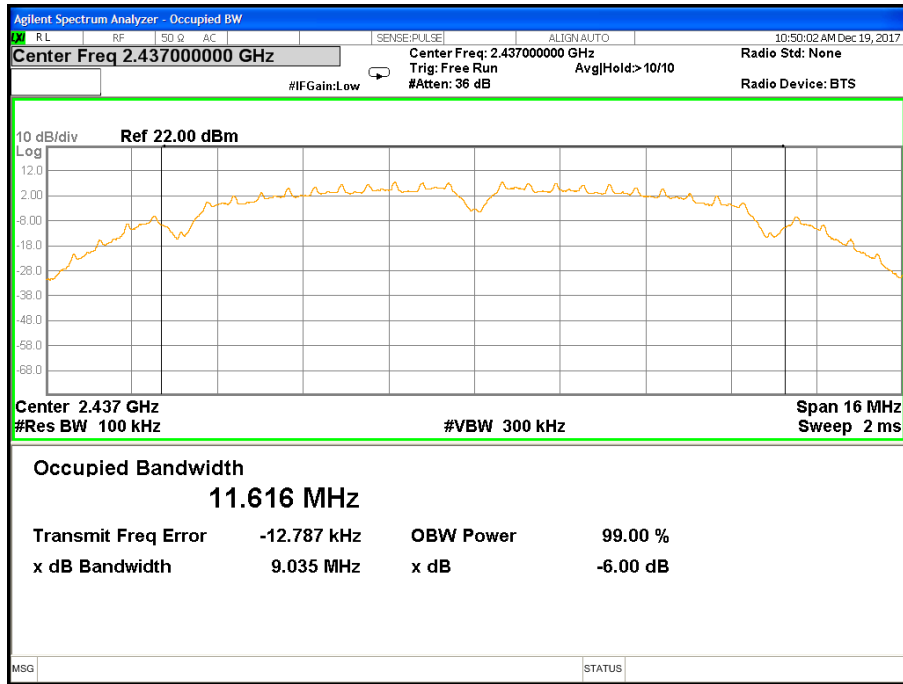

TX CH 11

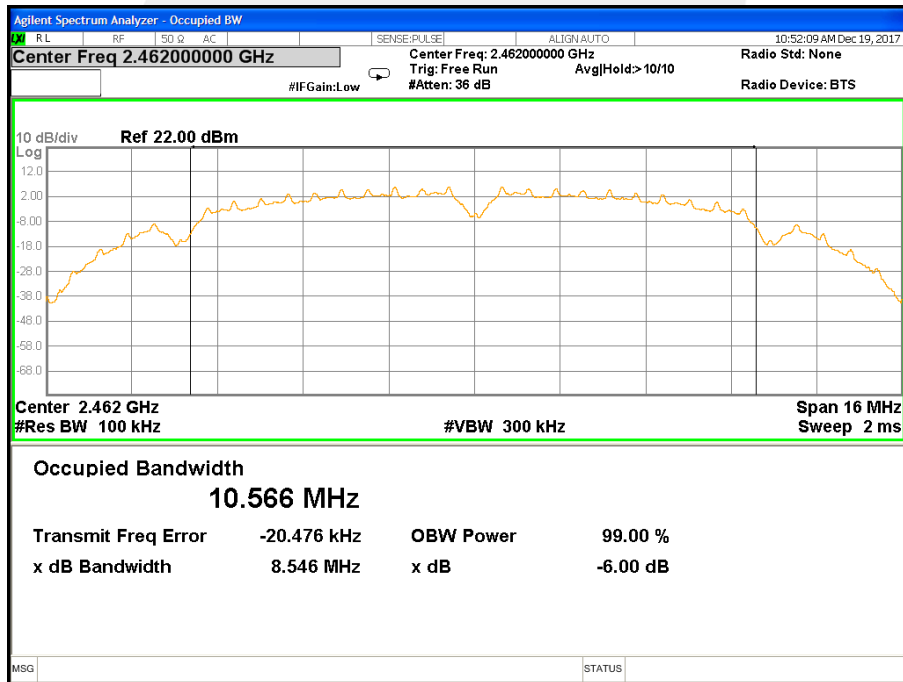



Temperature:	25 °C	Relative Humidity:	60%
Pressure:	1012 hPa	Test Voltage:	DC 5V From PC
Test Mode:	TX g Mode /CH01, CH06, CH11		

Frequency	6dB Bandwidth (MHz)	Channel Separation (KHz)	Result
2412 MHz	16.33	≥500KHz	PASS
2437 MHz	16.34	≥500KHz	PASS
2462 MHz	16.35	≥500KHz	PASS

TX CH 01

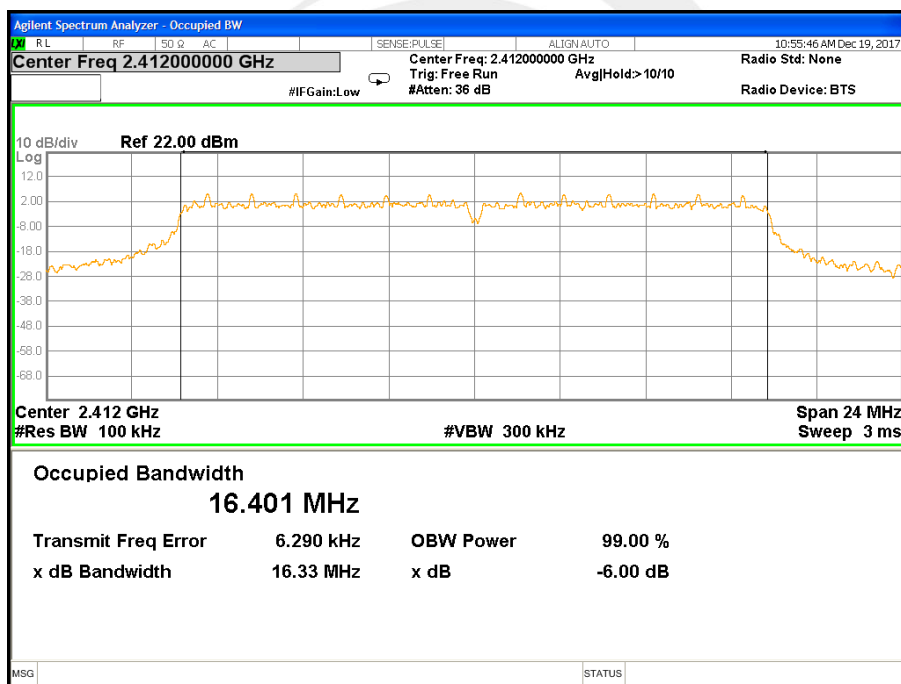



TX CH 06

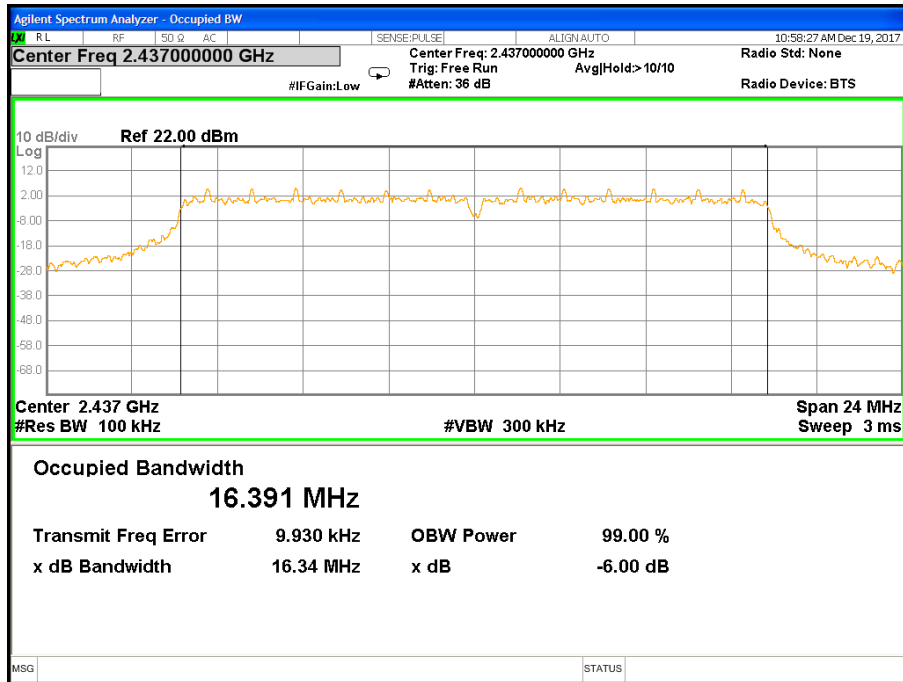

TX CH 11

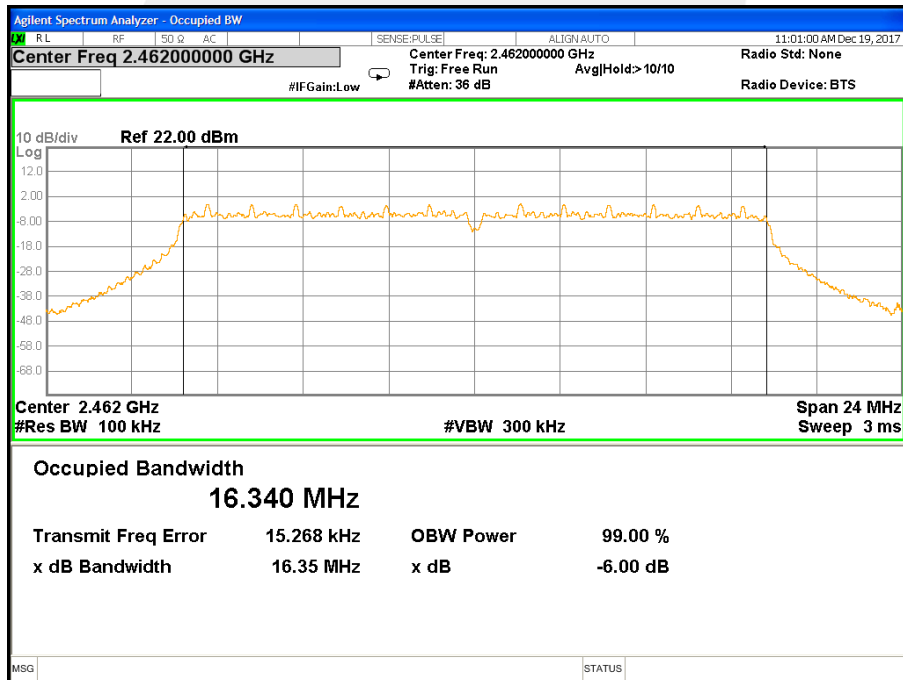



Temperature:	25 °C	Relative Humidity:	60%
Pressure:	1012 hPa	Test Voltage:	DC 5V From PC
Test Mode:	TX n Mode(20M) /CH01, CH06, CH11		

Frequency	6dB Bandwidth (MHz)	Channel Separation (KHz)	Result
2412 MHz	16.68	≥500KHz	PASS
2437 MHz	16.79	≥500KHz	PASS
2462 MHz	16.69	≥500KHz	PASS

TX CH 01

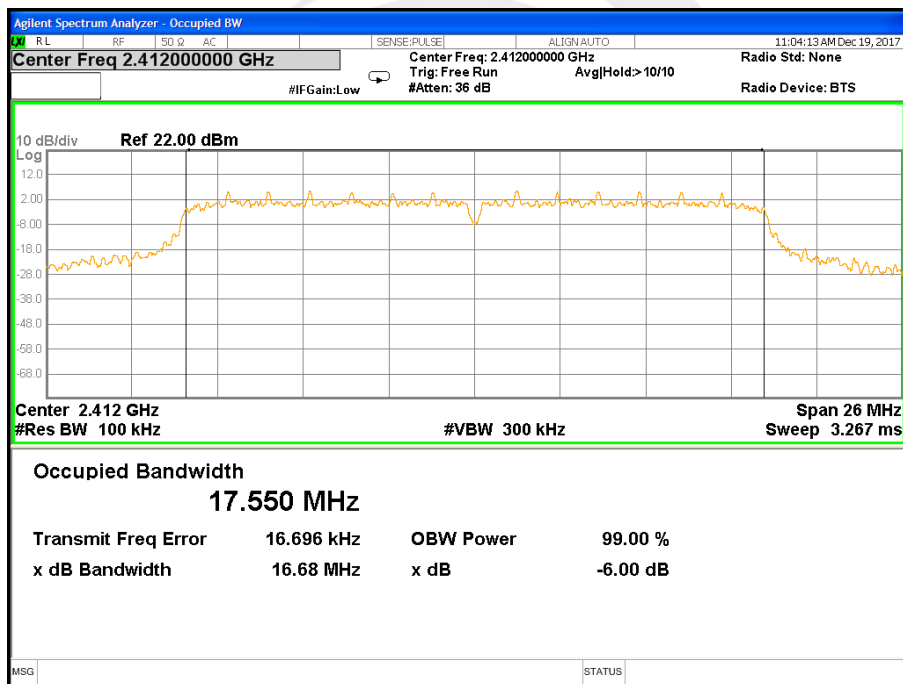



TX CH 06

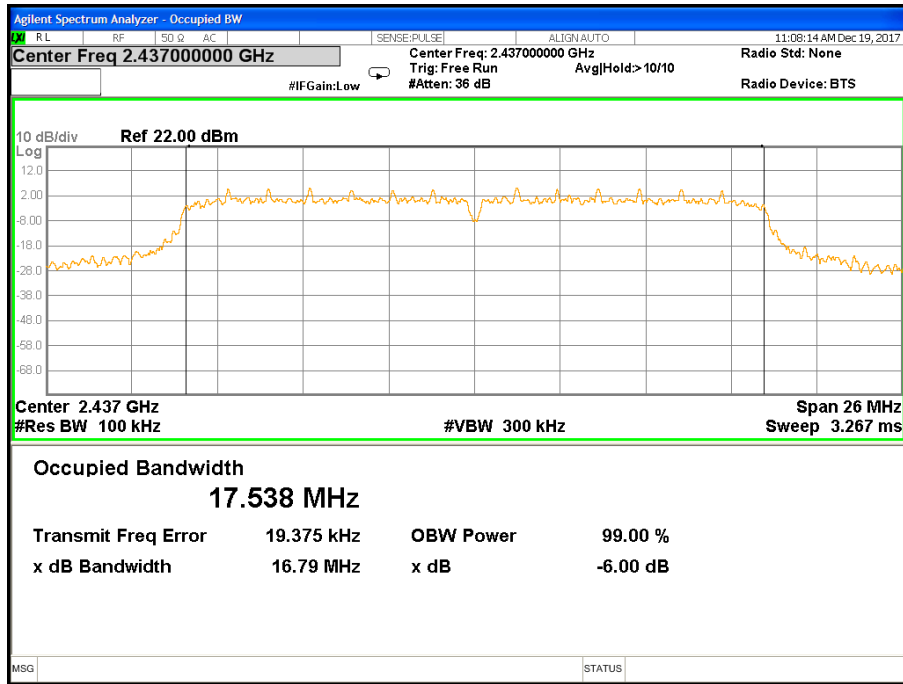

TX CH 11

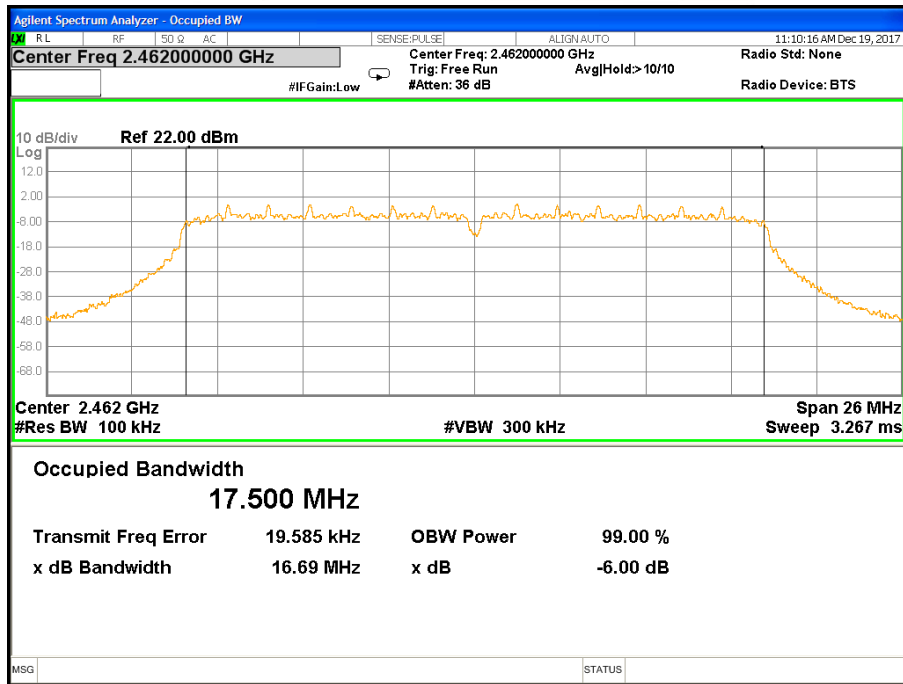



7. PEAK OUTPUT POWER TEST

7.1 APPLIED PROCEDURES / LIMIT

FCC Part 15.247, Subpart C				
Section	Test Item	Limit	Frequency Range (MHz)	Result
15.247(b)(3)	Output Power	1 watt or 30dBm	2400-2483.5	PASS

7.2 TEST PROCEDURE

- a. The EUT was directly connected to the Power Meter

7.3 DEVIATION FROM STANDARD

No deviation.

7.4 TEST SETUP



7.5 EUT OPERATION CONDITIONS

The EUT tested system was configured as the statements of 2.3 Unless otherwise a special operating condition is specified in the follows during the testing.



7.6 TEST RESULTS

Temperature:	25 °C	Relative Humidity:	60%
Pressure:	1012 hPa	Test Voltage:	DC 5V From PC

TX 802.11b Mode				
Test Channel	Frequency	Conducted Output Power		LIMIT
	(MHz)	Peak(dBm)	AVG(dBm)	dBm
CH01	2412	17.84	16.81	30
CH06	2437	16.73	15.72	30
CH11	2462	16.07	15.05	30

TX 802.11g Mode				
Test Channel	Frequency	Conducted Output Power		LIMIT
	(MHz)	Peak(dBm)	AVG(dBm)	dBm
CH01	2412	16.81	15.80	30
CH06	2437	16.24	15.22	30
CH11	2462	15.48	14.44	30

TX 802.11n20 Mode				
Test Channel	Frequency	Conducted Output Power		LIMIT
	(MHz)	Peak(dBm)	AVG(dBm)	dBm
CH01	2412	16.75	14.73	30
CH06	2437	16.13	14.11	30
CH11	2462	15.32	13.31	30



8. ANTENNA REQUIREMENT

8.1 STANDARD REQUIREMENT

15.203 requirement: For intentional device, according to 15.203: an intentional radiator shall be designed to ensure that no antenna other than that furnished by the responsible party shall be used with the device.

8.2 EUT ANTENNA

The EUT antenna is Internal PCB Antenna. It comply with the standard requirement.



APPENDIX - PHOTOS OF TEST SETUP

Radiated Measurement Photos





Conducted Measurement Photos

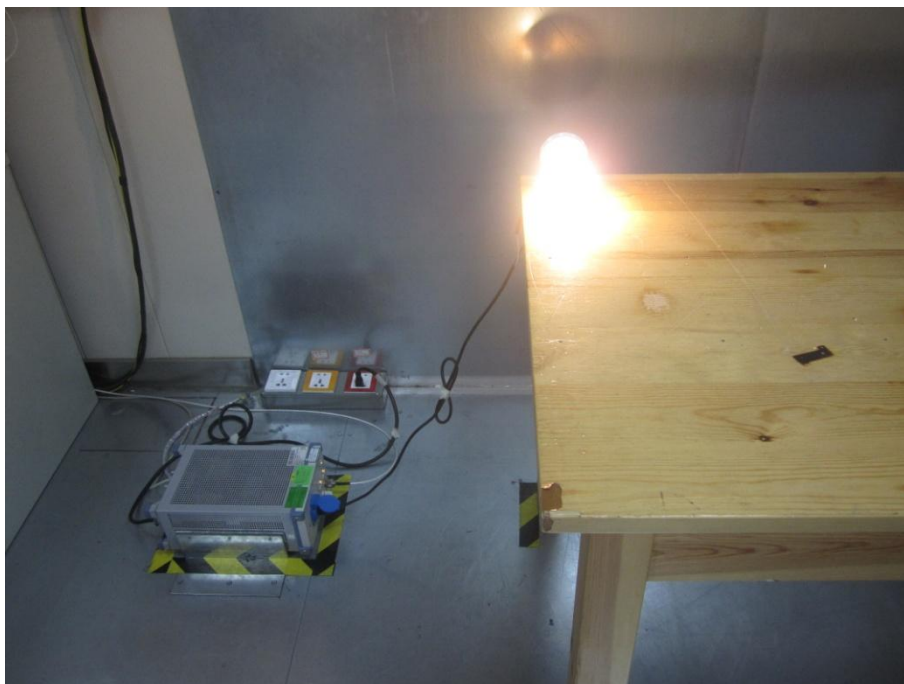

*****END OF THE REPORT*****