



FCC Part 15.247

TEST REPORT

For

Hangzhou Eboylamp Electronics Co., Ltd.

No.568 Huabao Street, Qianyuan Town ,Deqing huzhou China

FCC ID: 2AJ3WEBEQPW35

Report Type: Original Report	Product Type: LED lamp
Report Producer : <u>Kaylee Chiang</u> <i>Kaylee Chiang</i>	
Report Number : <u>RXZ190604004-00A</u>	
Report Date : <u>2019-06-19</u>	
Reviewed By: <u>Jerry Chang</u> <i>Jerry Chang</i>	
Prepared By: Bay Area Compliance Laboratories Corp.(Taiwan) 70, Lane 169, Sec. 2, Datong Road, Xizhi Dist., New Taipei City 22183, Taiwan, R.O.C. Tel: +886 (2) 2647 6898 Fax: +886 (2) 2647 6895 www.bacl.com.tw	

Revision History

Revision	No.	Report Number	Issue Date	Description	Author/ Revised by
1.0	RXZ190604004	RXZ190604004-00A	2019-06-19	Original Report	Kaylee Chiang

TABLE OF CONTENTS

1 General Information 5

1.1 Product Description for Equipment under Test (EUT) 5

1.2 Objective 6

1.3 Related Submittal(s)/Grant(s)..... 6

1.4 Test Methodology..... 6

1.5 Test Facility 6

2 System Test Configuration..... 7

2.1 Description of Test Configuration..... 7

2.2 Equipment Modifications 7

2.3 EUT Exercise Software 7

2.4 Test Mode..... 8

2.5 Support Equipment List and Details..... 8

2.6 External Cable List and Details 8

2.7 Block Diagram of Test Setup 9

2.8 Duty Cycle..... 11

3 Summary of Test Results..... 13

4 Test Equipment List and Details 14

5 FCC §15.247(i), §1.1310, § 2.1091 - Maximum Permissible Exposure (MPE) 16

5.1 Applicable Standard 16

5.2 RF Exposure Evaluation Result..... 16

6 FCC §15.203 – Antenna Requirements..... 17

6.1 Applicable Standard 17

6.2 Antenna List and Details 17

7 FCC §15.207(a) – AC Line Conducted Emissions 18

7.1 Applicable Standard 18

7.2 Measurement Uncertainty 18

7.3 EUT Setup 19

7.4 EMI Test Receiver Setup 19

7.5 Test Procedure..... 19

7.6 Corrected Factor & Margin Calculation..... 20

7.7 Environmental Conditions..... 20

7.8 Test Results 21

8 FCC §15.209, §15.205 , §15.247(d) – Spurious Emissions 23

8.1 Applicable Standard 23

8.2 Measurement Uncertainty 24

8.3 EUT Setup 25

8.4 EMI Test Receiver & Spectrum Analyzer Setup..... 25

8.5 Test Procedure..... 26

8.6 Corrected Factor & Margin Calculation..... 26

8.7 Test Results Summary..... 26

8.8 Environmental Conditions..... 26

8.9 Test Results 27

9 FCC §15.247(a)(2) – 6 dB Emission Bandwidth..... 39

9.1	Applicable Standard	39
9.2	Test Procedure	39
9.3	Environmental Conditions.....	39
9.4	Test Results	40
10	FCC §15.247(b)(3) – Maximum Output Power	45
10.1	Applicable Standard	45
10.2	Test Procedure	45
10.3	Environmental Conditions.....	45
10.4	Test Results	46
11	FCC§15.247(d) – 100 kHz Bandwidth of Frequency Band Edge	48
11.1	Applicable Standard	48
11.2	Test Procedure	48
11.3	Environmental Conditions.....	48
11.4	Test Results	49
12	FCC §15.247(e) – Power Spectral Density	53
12.1	Applicable Standard	53
12.2	Test Procedure	53
12.3	Environmental Conditions.....	53
12.4	Test Results	54

1 General Information

1.1 Product Description for Equipment under Test (EUT)

Applicant	Hangzhou Eboylamp Electronics Co., Ltd.
	No.568 Huabao Street,Qianyuan Town ,Deqing huzhou China
Manufacturer	Hangzhou Eboylamp Electronics Co., Ltd.
	No.568 Huabao Street,Qianyuan Town ,Deqing huzhou China
Brand(Trade) Name	eboy
Product (Equipment)	LED lamp
Main Model Name	EBE-QPW35
Series Model Name	N/A
Frequency Range	IEEE 802.11b/g / IEEE 802.11n HT20 Mode: 2412 ~ 2462 MHz
Transmit Power	IEEE 802.11b Mode: 16.51 dBm (0.045W)
	IEEE 802.11g Mode: 15.74 dBm (0.037W)
	IEEE 802.11n HT20 Mode: 14.73 dBm (0.030W)
Modulation Technique	IEEE 802.11b: DSSS
	IEEE 802.11g: OFDM
	IEEE 802.11n HT20 Mode: OFDM
Transmit Data Rate	IEEE 802.11b Mode: 11, 5.5, 2, 1 Mbps
	IEEE 802.11g Mode: 54, 48, 36, 24, 18, 12, 11, 9, 6Mbps
	IEEE 802.11n HT 20 Mode: 6.5, 7.2, 13, 14.4, 14.44, 19.5, 21.7, 26, 28.89, 28.9, 39, 43.3, 43.33 52, 57.78, 57.8, 58.5, 65.0, 72.2, 78, 86.67, 104, 115.56, 117, 130, 144.44 Mbps
Number of Channels	IEEE 802.11b/g / IEEE 802.11n HT20 Mode: 11 Channels
Antenna Specification	Metal antenna / 2 dBi
Power Operation (Voltage Range)	<input checked="" type="checkbox"/> AC 120V/60Hz
	<input type="checkbox"/> Adapter I/P: 100-240Vac,1.2A ; O/P: 12Vdc, 3A
	<input checked="" type="checkbox"/> By AC Power Cord
	<input type="checkbox"/> PoE
	<input type="checkbox"/> DC Type
	<input type="checkbox"/> Battery
	<input type="checkbox"/> DC Power Supply
	<input type="checkbox"/> External from USB Cable
	<input type="checkbox"/> External DC Adapter
	<input type="checkbox"/> Host System
Received Date	June 04, 2019
Date of Test	June 10, 2019 ~ June 13, 2019

**All measurement and test data in this report was gathered from production sample serial number: 190604004
(Assigned by BACL, Taiwan).*

1.2 Objective

This report is prepared on behalf of *Hangzhou Eboylamp Electronics Co., Ltd.* in accordance with Part 2, Subpart J, Part 15, Subparts A and C of the Federal Communication Commission's rules.

The objective is to determine compliance with FCC Part 15.247 rules for Output Power, Antenna Requirements, 6 dB Bandwidth, Power Spectral Density, 100 kHz Bandwidth of Band Edges Measurement, Conducted and Radiated Spurious Emissions.

1.3 Related Submittal(s)/Grant(s)

N/A.

1.4 Test Methodology

All measurements contained in this report were conducted with ANSI C63.10-2013, American National Standard of Procedures for Compliance Testing of Unlicensed Wireless Devices KDB 558074 D01 15.247 Meas Guidance v05r02

1.5 Test Facility

The Test site used by Bay Area Compliance Laboratories Corp. (Taiwan) to collect test data is located on

70, Lane 169, Sec. 2, Datong Road, Xizhi Dist., New Taipei City 22183, Taiwan, R.O.C.

68-3, Lane 169, Sec. 2, Datong Road, Xizhi Dist., New Taipei City 22183, Taiwan, R.O.C.

Bay Area Compliance Laboratories Corp. (Taiwan) Lab is accredited to ISO 17025 by Taiwan Accreditation Foundation (TAF code: 3180) and the FCC designation No.TW3180 under the Mutual Recognition Agreement (MRA) in FCC Test. The facility also complies with the radiated and AC line conducted test site criteria set forth in ANSI C63.10.

The Federal Communications Commission has the reports on file and is listed under FCC Registration No.: 974454. The test site has been approved by the FCC for public use and is listed in the FCC Public Access Link (PAL) database.

2 System Test Configuration

2.1 Description of Test Configuration

For WIFI mode, there are totally 11 channels.

Channel	Frequency (MHz)	Channel	Frequency (MHz)
1	2412	7	2442
2	2417	8	2447
3	2422	9	2452
4	2427	10	2457
5	2432	11	2462
6	2437		

For 802.11 b/g/n20 Modes were tested with channel 1, 6 and 11.

2.2 Equipment Modifications

No modification was made to the EUT.

2.3 EUT Exercise Software

Used “ESP_RF_test_tool_v1.1.0” software.

Test Frequency		Low	Mid	High
Power Level Setting	B Mode	0	0	0
	G Mode	24	24	24
	N20 Mode	24	24	24

The EUT was configured for testing in an engineering mode which was provided by the manufacturer.

The worst-case data rates are determined to be as follows for each mode based upon investigations by measuring the average power and PSD across all data rates bandwidths, and modulations.

802.11b: 1Mbps

802.11g: 6Mbps

802.11n ht20: MCS0

2.4 Test Mode

Pre-Scan

Mode 1: Full System (model: EBE-QPW35) for all test item.

Pre-scan has been conducted to determine the worst-case mode from all possible combinations between available.

Final Test

Mode 1: Full System (model: EBE-QPW35) for all test item.

2.5 Support Equipment List and Details

Description	Manufacturer	Model Number	BSMI	FCC ID	S/N
NB	DELL	E6410	N/A	PD98260NG U	10912240367
FIX	N/A	N/A	N/A	N/A	N/A

2.6 External Cable List and Details

Cable Description	Length (m)	From	To
Micro USB Cable	1.5	NB	FIX

2.7 Block Diagram of Test Setup

See test photographs attached in setup photos for the actual connections between EUT and support equipment.

Radiation:

Below 1GHz:

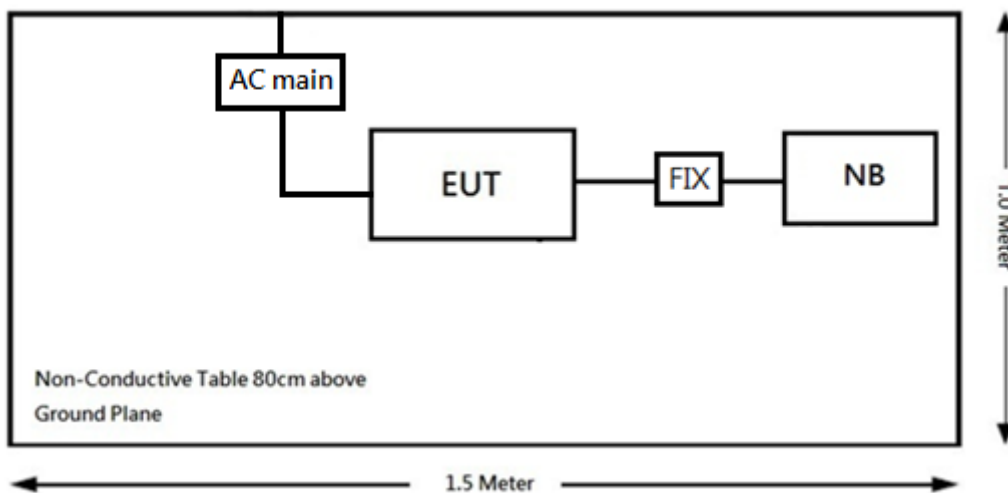

Above 1GHz:

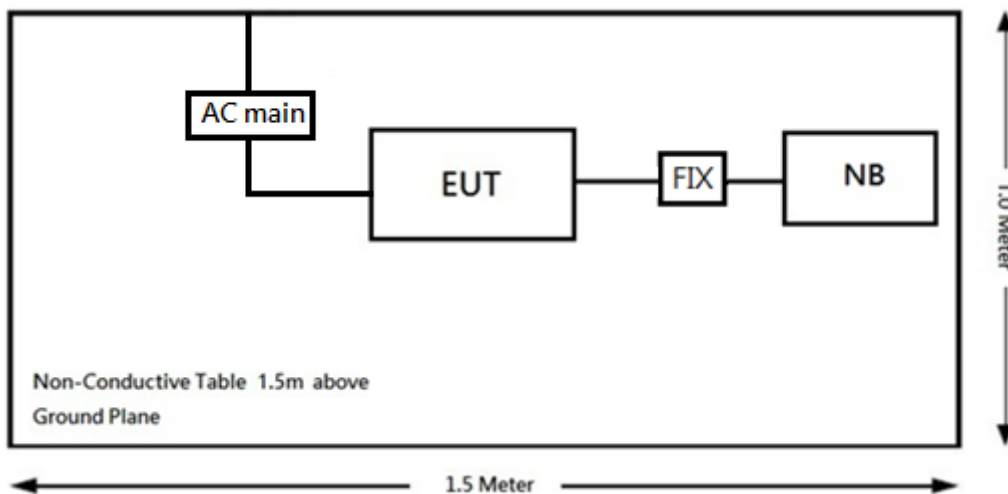

Conduction:

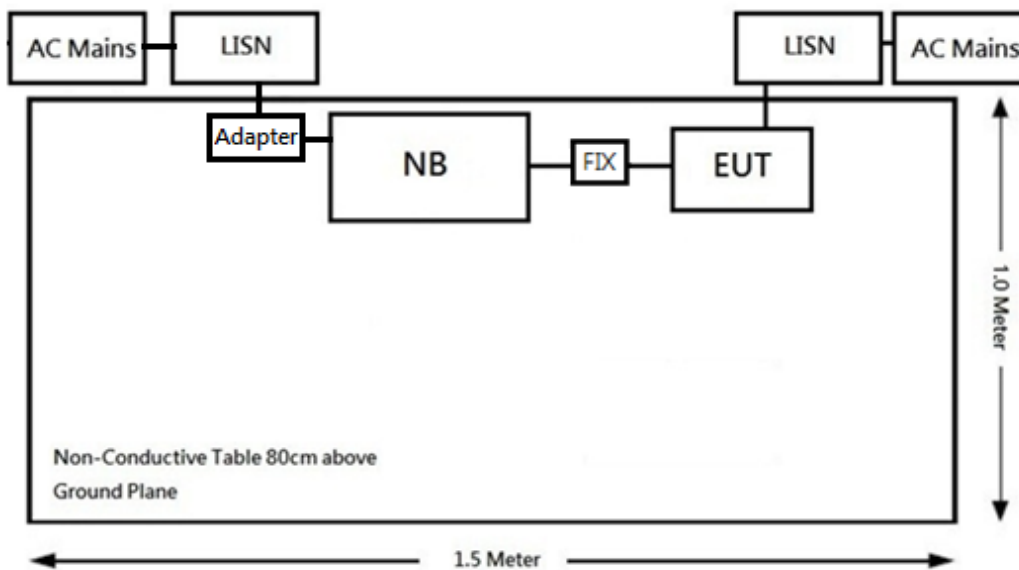

2.8 Duty Cycle

According to KDB 558074 D01 15.247 Meas Guidance v05r02 section 6.0:

All measurements are to be performed with the EUT transmitting at 100% duty cycle at its maximum power control level; however, if 100% duty cycle cannot be achieved, measurements of duty cycle, x, and maximum power transmission duration, T, are required for each tested mode of operation.

Radio Mode	On Time (ms)	Period (ms)	Duty Cycle (%)	Duty Cycle Correction Factor (dB)
802.11b	4.134	4.711	0.88	0.56
802.11g	0.673	0.793	0.85	0.71
802.11n20	0.633	0.761	0.83	0.81

Note: Duty Cycle Correction Factor = $10 \cdot \log(1/\text{duty cycle})$

Please refer to the following plots.

B Mode

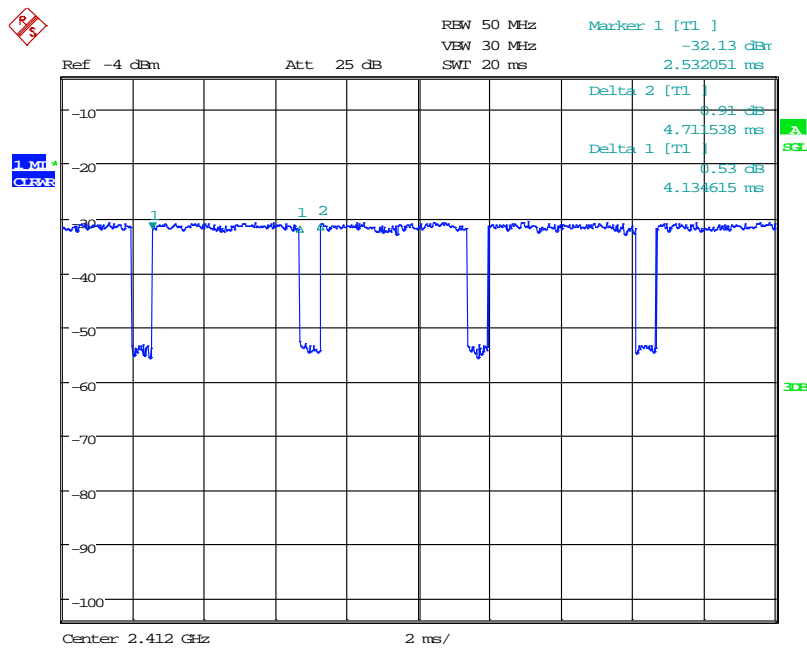

Date: 11.JUN.2019 18:59:38

G Mode

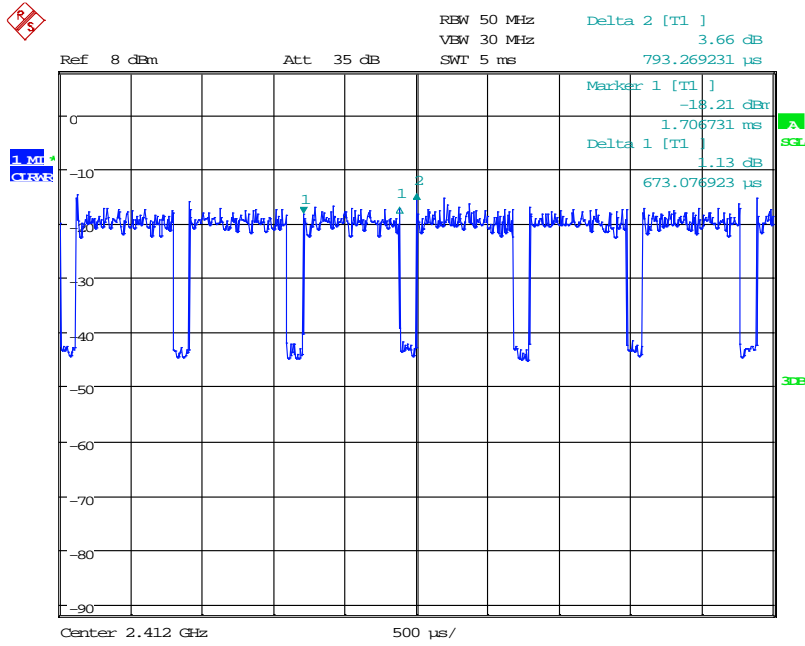

Date: 11.JUN.2019 19:02:37

N20 Mode

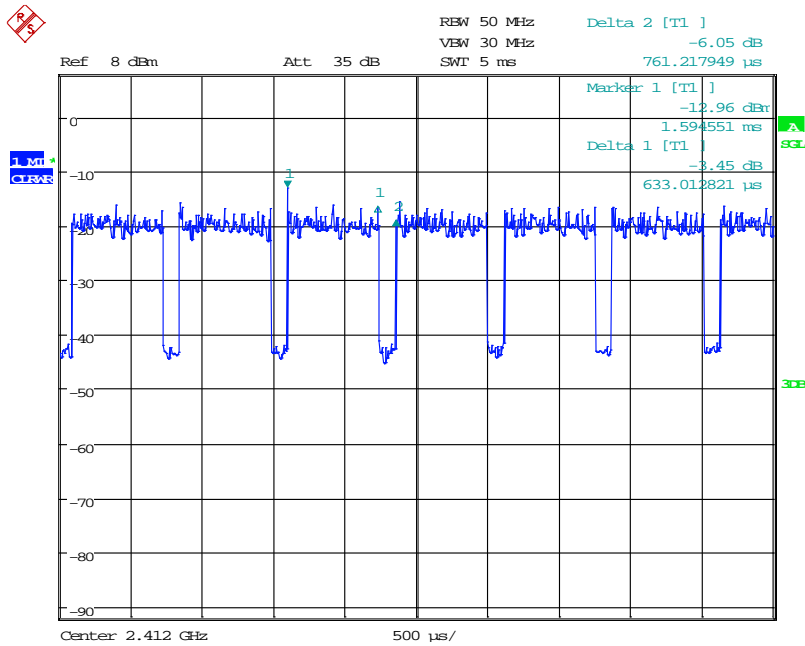

Date: 11.JUN.2019 19:04:36

3 Summary of Test Results

FCC Rules	Description of Test	Results
§15.247(i), §1.1310, §2.1091	Maximum Permissible Exposure (MPE)	Compliance
§15.203	Antenna Requirement	Compliance
§15.207(a)	AC Line Conducted Emissions	Compliance
§15.205, §15.209, §15.247(d)	Spurious Emissions	Compliance
§15.247(a)(2)	6 dB Emission Bandwidth	Compliance
§15.247(b)(3)	Maximum Peak Output Power	Compliance
§15.247(d)	100 kHz Bandwidth of Frequency Band Edge	Compliance
§15.247(e)	Power Spectral Density	Compliance

4 Test Equipment List and Details

Description	Manufacturer	Model	Serial Number	Calibration Date	Calibration Due Date
AC Line Conduction Room (CON-A)					
LISN	Rohde & Schwarz	ENV216	101612	2019/02/21	2020/02/20
LISN	Rohde & Schwarz	ENV216	101248	2018/06/27	2019/06/26
EMI Test Receiver	Rohde & Schwarz	ESR7	101419	2018/10/23	2019/10/22
Pulse Limiter	Rohde & Schwarz	ESH3Z2	TXZEM104	2018/08/03	2019/08/02
RF Cable	EMEC	EM-CB5D	001	2018/07/02	2019/07/01
Software	AUDIX	E3	V9.150826k	N.C.R	N.C.R
Radiated Room (966-A)					
Bilog Antenna with 6 dB Attenuator	SUNOL SCIENCES & MINI-CIRCUITS	JB6/UNAT-6+	A050115/1554_2_01	2018/12/11	2019/12/10
Horn Antenna	EMCO	SAS-571	1020	2019/04/17	2020/04/16
Horn Antenna	ETS-Lindgren	3116	62638	2018/08/29	2019/08/28
Preamplifier	Sonoma	310N	130602	2018/07/04	2019/07/03
Preamplifier	EM Electronics Corp.	EM01G18G	060657	2018/12/07	2019/12/06
Microwave Preamplifier	EM Electronics Corporation	EM18G40G	060656	2019/01/11	2020/01/10
EMI Test Receiver	Rohde & Schwarz	ESR7	101419	2018/10/23	2019/10/22
Spectrum Analyzer	Rohde & Schwarz	FSV40	101435	2019/02/13	2020/02/12
Micro flex Cable	UTIFLEX	FSCM 64639 / (2M)	93D0127	2018/07/31	2019/07/30
Micro flex Cable	UTIFLEX	UFA210A-1-3149-300300	MFR64639 226389-001	2018/11/16	2019/11/15
Micro flex Cable	ROSNO	K1K50-UP0264-K1K50-450CM	160309-1	2019/03/04	2020/03/03
Micro flex Cable	ROSNO	K1K50-UP0264-K1K50-80CM	160309-2	2019/01/16	2020/01/15
Turn Table	Champro	TT-2000	060772-T	N.C.R	N.C.R
Antenna Tower	Champro	AM-BS-4500-B	060772-A	N.C.R	N.C.R
Controller	Champro	EM1000	60772	N.C.R	N.C.R
Software	Farad	EZ_EM	BACL-03A1	N.C.R	N.C.R

Description	Manufacturer	Model	Serial Number	Calibration Date	Calibration Due Date
Conducted Room					
Spectrum Analyzer	Rohde & Schwarz	FSU26	200268	2019/05/10	2020/05/09
Cable	WOKEN	SFL402	S02-160323-07	2019/02/11	2020/02/10
Power Sensor	KEYSIGHT	U2021XA	MY54080018	2019/03/06	2020/03/05
Attenuator	MINI-CIRCUITS	BW-S10W5+	N/A	2019/03/07	2020/03/07

**Statement of Traceability: BACL Corp. attests that all of the calibrations on the equipment items listed above were traceable to the SI System of Units via the R.O.C. Center for Measurement Standards of the Electronics Testing Center, Taiwan (ETC) or to another internationally recognized National Metrology Institute (NMI), and were compliant with the current Taiwan Accreditation Foundation (TAF) requirements*

5 FCC §15.247(i), §1.1310, § 2.1091 - Maximum Permissible Exposure (MPE)

5.1 Applicable Standard

According to subpart 15.247(i)and subpart §1.1310, systems operating under the provisions of this section shall be operated in a manner that ensures that the public is not exposed to radio frequency energy level in excess of the Commission’s guidelines.

Limits for Maximum Permissible Exposure (MPE) (§1.1310, §2.1091)

(B) Limits for General Population/Uncontrolled Exposure				
Frequency Range (MHz)	Electric Field Strength (V/m)	Magnetic Field Strength (A/m)	Power Density (mW/cm²)	Averaging Time (minutes)
0.3–1.34	614	1.63	*(100)	30
1.34–30	824/f	2.19/f	*(180/f ²)	30
30–300	27.5	0.073	0.2	30
300–1500	/	/	f/1500	30
1500–100,000	/	/	1.0	30

f = frequency in MHz; * = Plane-wave equivalent power density;

According to §1.1310 and §2.1091 RF exposure is calculated.

Calculated Formulary:

Predication of MPE limit at a given distance

$S = PG/4\pi R^2$ = power density (in appropriate units, e.g. mW/cm²);

P = power input to the antenna (in appropriate units, e.g., mW);

G = power gain of the antenna in the direction of interest relative to an isotropic radiator, the power gain factor, is normally numeric gain;

R = distance to the center of radiation of the antenna (appropriate units, e.g., cm);

5.2 RF Exposure Evaluation Result

MPE evaluation:

Mode	Frequency Range (MHz)	Antenna Gain		Target Power		Evaluation Distance (cm)	Power Density (mW/cm²)	MPE Limit (mW/cm²)
		(dBi)	(numeric)	(dBm)	(mW)			
2.4G WIFI	2412-2462	2	1.58	17	50.12	20	0.015	1.0

Note: the maximum antenna gain was used for evaluation.

Result: MPE evaluation meet 20 cm the requirement of standard.

6 FCC §15.203 – Antenna Requirements

6.1 Applicable Standard

According to § 15.203,

An intentional radiator shall be designed to ensure that no antenna other than that furnished by the responsible party shall be used with the device. The use of a permanently attached antenna or of an antenna that uses a unique coupling to the intentional radiator shall be considered sufficient to comply with the provisions of this section. The manufacturer may design the unit so that a broken antenna can be replaced by the user, but the user of a standard antenna jack or electrical connector is prohibited.

And according to FCC 47 CFR section 15.247 (b), if the transmitting antennas of directional gain greater than 6dBi are used, the power shall be reduced by the amount in dB that the directional gain of the antenna does not exceed 6dBi.

6.2 Antenna List and Details

Manufacturer	Type	Antenna Gain	Result
Dongguan RF Electronic Technology Co., Ltd	Metal Antenna	2 dBi	Compliance

The EUT has an internal antenna arrangement, which was permanently attached; fulfill the requirement of this section.

Result: Compliance

7 FCC §15.207(a) – AC Line Conducted Emissions

7.1 Applicable Standard

According to §15.207

For an intentional radiator that is designed to be connected to the public utility (AC) power line, the radio frequency voltage that is conducted back onto the AC power line on any frequency or frequencies within the band 150 kHz to 30 MHz shall not exceed the limits in the following table, as measured using a 50 μH/50 ohms line impedance stabilization network (LISN). Compliance with the provisions of this paragraph shall be based on the measurement of the radio frequency voltage between each power line and ground at the power terminal. The lower limit applies at the boundary between the frequencies ranges.

Frequency of Emission (MHz)	Conducted Limit (dBuV)	
	Quasi-Peak	Average
0.15-0.5	66 to 56 ^{Note 1}	56 to 46 ^{Note 2}
0.5-5	56	46
5-30	60	50

Note 1: Decreases with the logarithm of the frequency.

Note 2: A linear average detector is required

7.2 Measurement Uncertainty

Input quantities to be considered for conducted disturbance measurements maybe receiver reading, attenuation of the connection between LISN/ISN and receiver, LISN/ISN voltage division factor, LISN/ISN VDF frequency interpolation and receiver related input quantities, etc.

Based on CISPR 16-4-2:2011, the expended combined standard uncertainty of conducted disturbance test at Bay Area Compliance Laboratories Corp. (Taiwan) is shown as below. And the uncertainty will not be taken into consideration for the test data recorded in the report

Port	Expanded Measurement uncertainty
AC Mains	2.71 dB (k=2, 95% level of confidence)

7.3 EUT Setup

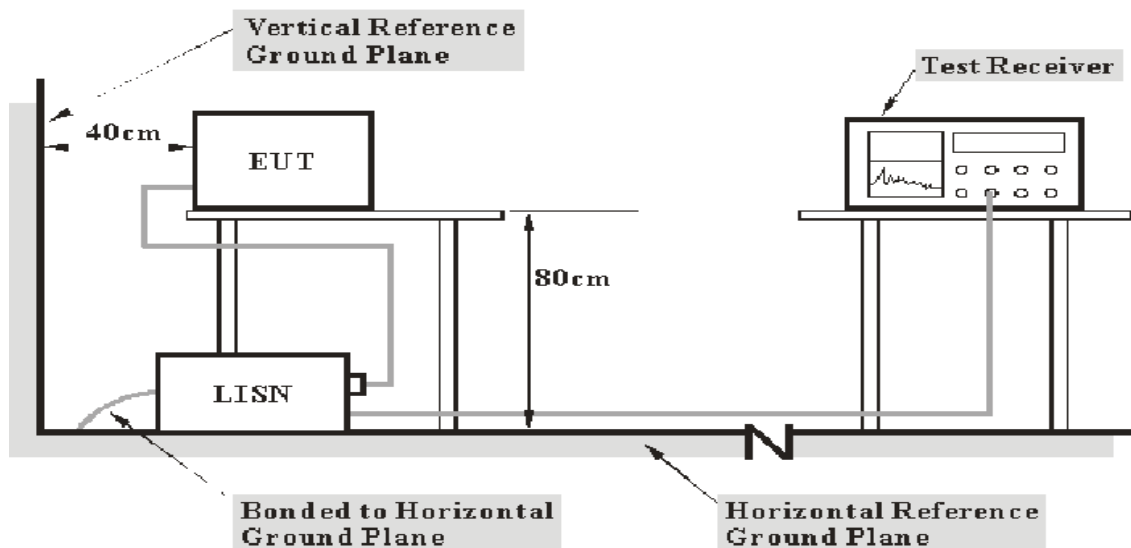

- Note:**
1. Support units were connected to second LISN.
 2. Both of LISNs (AMN) 80 cm from EUT and at the least 80 cm from other units and other metal planes support units.

The setup of EUT is according with per ANSI C63.10-2013 measurement procedure. The specification used was with the FCC Part 15.207 limits.

7.4 EMI Test Receiver Setup

The EMI test receiver was set to investigate the spectrum from 150kHz to 30MHz.

During the conducted emission test, the EMI test receiver was set with the following configurations

Frequency Range	IF B/W
150kHz – 30MHz	9kHz

7.5 Test Procedure

During the conducted emission test, the adapter was connected to the outlet of the LISN.

Maximizing procedure was performed on the six (6) highest emissions of the EUT.

All data was recorded in the Quasi-peak and average detection mode.

7.6 Corrected Factor & Margin Calculation

The factor is calculated by adding LISN/ISN VDF (Voltage Division Factor), Cable Loss and Transient Limiter Attenuation. The basic equation is as follows:

$$\text{Factor} = \text{LISN VDF} + \text{Cable Loss} + \text{Transient Limiter Attenuation}$$

The “Over Limit” column of the following data tables indicates the degree of compliance with the applicable limit. For example, an over limit of -7 dB means the emission is 7 dB below the limit. The equation for Over Limit calculation is as follows:

$$\text{Over Limit} = \text{Level} - \text{Limit Line}$$

7.7 Environmental Conditions

Temperature:	22.1 °C
Relative Humidity:	43 %
ATM Pressure:	1010 hPa

The testing was performed by Tom Hsu on 2019-06-10.

7.8 Test Results

Test Mode: Transmitting

Main: AC120 V, 60 Hz, Line

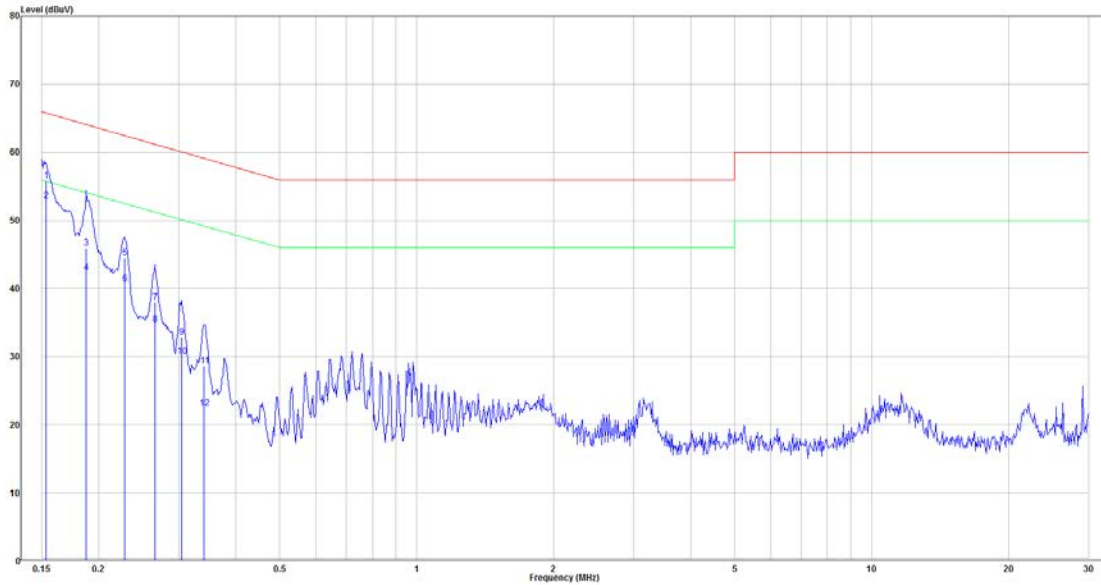

No.	Frequency (MHz)	Reading (dBµV)	Correct Factor(dB)	Result (dBµV)	Limit (dBµV)	Over limit (dB)	Remark
1	0.153	36.43	19.45	55.88	65.83	-9.95	QP
2	0.153	33.40	19.45	52.85	55.83	-2.98	Average
3	0.188	26.45	19.46	45.91	64.14	-18.23	QP
4	0.188	22.83	19.46	42.29	54.14	-11.85	Average
5	0.228	25.05	19.46	44.51	62.52	-18.01	QP
6	0.228	21.26	19.46	40.72	52.52	-11.80	Average
7	0.266	18.51	19.46	37.97	61.24	-23.27	QP
8	0.266	15.27	19.46	34.73	51.24	-16.51	Average
9	0.304	13.40	19.47	32.87	60.12	-27.25	QP
10	0.304	10.62	19.47	30.09	50.12	-20.03	Average
11	0.341	9.13	19.47	28.60	59.17	-30.57	QP
12	0.341	2.97	19.47	22.44	49.17	-26.73	Average

Note:

Level = Read Level + Factor

Over Limit = Level – Limit Line

Factor = (LISN, ISN, PLC or current probe) Factor + Cable Loss + Attenuator

Main: AC120 V, 60 Hz, Neutral

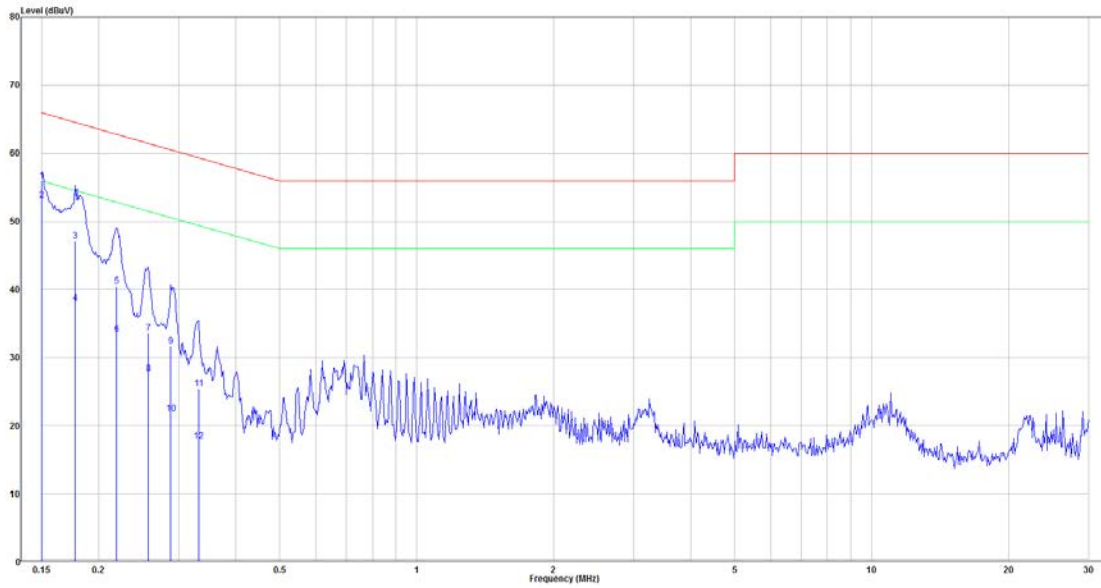

No.	Frequency (MHz)	Reading (dBµV)	Correct Factor(dB)	Result (dBµV)	Limit (dBµV)	Over limit (dB)	Remark
1	0.150	36.53	19.44	55.97	66.00	-10.03	QP
2	0.150	33.71	19.44	53.15	56.00	-2.85	Average
3	0.178	27.65	19.45	47.10	64.59	-17.49	QP
4	0.178	18.59	19.45	38.04	54.59	-16.55	Average
5	0.219	21.08	19.46	40.54	62.85	-22.31	QP
6	0.219	13.94	19.46	33.40	52.85	-19.45	Average
7	0.257	14.13	19.46	33.59	61.53	-27.94	QP
8	0.257	8.24	19.46	27.70	51.53	-23.83	Average
9	0.288	12.16	19.46	31.62	60.58	-28.96	QP
10	0.288	2.29	19.46	21.75	50.58	-28.83	Average
11	0.331	6.04	19.46	25.50	59.42	-33.92	QP
12	0.331	-1.74	19.46	17.72	49.42	-31.70	Average

Note:

Level = Read Level + Factor

Over Limit = Level – Limit Line

Factor = (LISN, ISN, PLC or current probe) Factor + Cable Loss + Attenuator

8 FCC §15.209, §15.205 , §15.247(d) – Spurious Emissions

8.1 Applicable Standard

As per FCC §15.35(d): Unless otherwise specified, on any frequency or frequencies above 1000 MHz, the radiated emission limits are based on the use of measurement instrumentation employing an average detector function. Unless otherwise specified, measurements above 1000 MHz shall be performed using a minimum resolution bandwidth of 1MHz.

As Per FCC §15.205(a) except as show in paragraph (d) of this section, only spurious emissions are permitted in any of the frequency bands listed below:

MHz	MHz	MHz	GHz
0.090 – 0.110	16.42 – 16.423	960 – 1240	4. 5 – 5. 15
0.495 – 0.505	16.69475 – 16.69525	1300 – 1427	5. 35 – 5. 46
2.1735 – 2.1905	25.5 – 25.67	1435 – 1626.5	7.25 – 7.75
4.125 – 4.128	37.5 – 38.25	1645.5 – 1646.5	8.025 – 8.5
4.17725 – 4.17775	73 – 74.6	1660 – 1710	9.0 – 9.2
4.20725 – 4.20775	74.8 – 75.2	1718.8 – 1722.2	9.3 – 9.5
6.215 – 6.218	108 – 121.94	2200 – 2300	10.6 – 12.7
6.26775 – 6.26825	123 – 138	2310 – 2390	13.25 – 13.4
6.31175 – 6.31225	149.9 – 150.05	2483.5 – 2500	14.47 – 14.5
8.291 – 8.294	156.52475 – 156.52525	2690 – 2900	15.35 – 16.2
8.362 – 8.366	156.7 – 156.9	3260 – 3267	17.7 – 21.4
8.37625 – 8.38675	162.0125 – 167.17	3332 – 3339	22.01 – 23.12
8.41425 – 8.41475	167.72 – 173.2	3 3458 – 3 358	23.6 – 24.0
12.29 – 12.293	240 – 285	3.600 – 4.400	31.2 – 31.8
12.51975 – 12.52025	322 – 335.4		36.43 – 36.5
12.57675 – 12.57725	399.9 – 410		Above 38.6
13.36 – 13.41	608 – 614		

As per FCC §15.209(a): Except as provided elsewhere in this Subpart, the emissions from an intentional radiator shall not exceed the field strength levels specified in the following table:

Frequency (MHz)	Field Strength (micro volts/meter)	Measurement Distance (meters)
0.009 - 0.490	2400/F(kHz)	300
0.490 - 1.705	24000/F(kHz)	30
1.705 - 30.0	30	30
30 - 88	100**	3
88 - 216	150**	3
216 - 960	200**	3
Above 960	500	3

** Except as provided in paragraph (g), fundamental emissions from intentional radiators operating under this Section shall not be located in the frequency bands 54-72 MHz, 76-88 MHz, 174-216 MHz or 470-806 MHz. However, operation within these frequency bands is permitted under other sections of this Part, e.g., Sections 15.231 and 15.241.

As per FCC §15.247 (d) In any 100 kHz bandwidth outside the frequency band in which the spread spectrum or digitally modulated intentional radiator is operating, the radio frequency power that is produced by the intentional radiator shall be at least 20 dB below that in the 100 kHz bandwidth within the band that contains the highest level of the desired power, based on either an RF conducted or a radiated measurement, provided the transmitter demonstrates compliance with the peak conducted power limits. If the transmitter complies with the conducted power limits based on the use of RMS averaging over a time interval, as permitted under paragraph (b)(3) of this section, the attenuation required under this paragraph shall be 30 dB instead of 20 dB. Attenuation below the general limits specified in §15.209(a) is not required. In addition, radiated emissions which fall in the restricted bands, as defined in §15.205(a), must also comply with the radiated emission limits specified in §15.209(a) (see §15.205(c)).

8.2 Measurement Uncertainty

All measurements involve certain levels of uncertainties, especially in field of EMC. The factors contributing to uncertainties are spectrum analyzer, cable loss, antenna factor calibration, antenna directivity, antenna factor variation with height, antenna phase center variation, antenna factor frequency interpolation, measurement distance variation, site imperfections, mismatch (average), and system repeatability.

Based on CISPR 16-4-2:2011, the expended combined standard uncertainty of radiation emissions at Bay Area Compliance Laboratories Corp. (Taiwan) is shown in below table. And the uncertainty will not be taken into consideration for the test data recorded in the report.

Frequency	Measurement uncertainty
30 MHz~200 MHz	3.75 dB (k=2, 95% level of confidence)
200 MHz~1 GHz	4.21 dB (k=2, 95% level of confidence)
1 GHz~6 GHz	4.83 dB (k=2, 95% level of confidence)
6 GHz~18 GHz	5.18 dB (k=2, 95% level of confidence)
18 GHz~26 GHz	4.55 dB (k=2, 95% level of confidence)
26 GHz~40 GHz	4.67 dB (k=2, 95% level of confidence)

8.3 EUT Setup

Below 1 GHz:

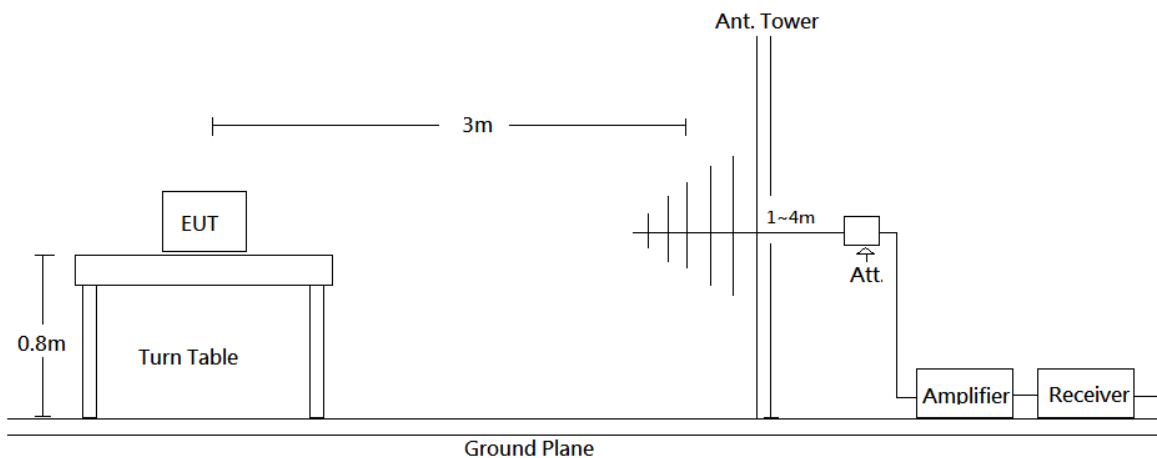

Above 1 GHz:

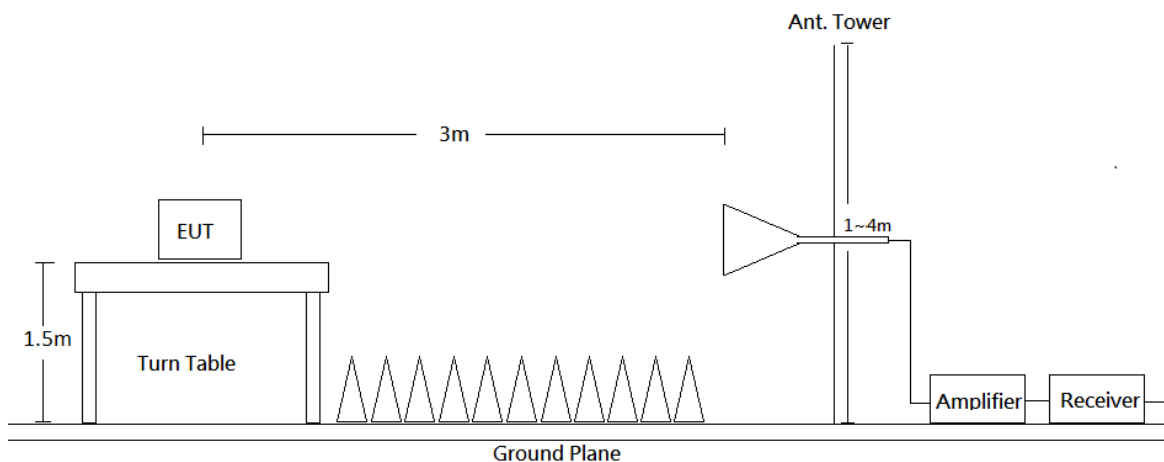

Radiated emission tests were performed in the 3 meters chamber test site, using the setup accordance with the ANSI C63.10-2013. The specification used was the FCC Part 15.209 and FCC 15.247 Limits.

8.4 EMI Test Receiver & Spectrum Analyzer Setup

The system was investigated from 30 MHz to 26.5 GHz. During the radiated emission test, the EMI test receiver was set with the following configurations measurement method 6.3 in ANSI C63.10.

Frequency Range	RBW	VBW	Detector	Duty cycle	Measurement method
30-1000 MHz	120 kHz	/	QP		QP
Above 1 GHz	1 MHz	3 MHz	PK		PK
	1 MHz	3 MHz	RMS	>98%	Ave
	1 MHz	1/T	PK	<98%	Ave

8.5 Test Procedure

Maximizing procedure was performed on the highest emissions to ensure that the EUT complied with all installation combinations.

All data was recorded in the Quasi-peak detector mode from 30 MHz to 1 GHz and PK and average detector modes for frequencies above 1 GHz.

8.6 Corrected Factor & Margin Calculation

The Correct Factor is calculated by adding the Antenna Factor and Cable Loss, and subtracting the Amplifier Gain from the Meter Reading. The basic equation is as follows:

$$\text{Correct Factor} = \text{Antenna Factor} + \text{Cable Loss} - \text{Amplifier Gain}$$

The “Margin” column of the following data tables indicates the degree of compliance with the applicable limit. For example, a margin of -7 dB means the emission is 7 dB below the limit. The equation for margin calculation is as follows:

$$\text{Margin} = \text{Result} - \text{Limit}$$

8.7 Test Results Summary

According to the recorded data in following table, the EUT complied with the FCC Title 47, Part 15, Subpart C, section 15.205, 15.209 and 15.247.

8.8 Environmental Conditions

Radiation		Conducted	
Temperature:	25 °C	Temperature:	21.5 °C
Relative Humidity:	55 %	Relative Humidity:	60.6 %
ATM Pressure:	1010 hPa	ATM Pressure:	1010 hPa

The Radiation Spurious Emissions testing was performed by Tom Hsu on 2019-06-13.

The Conducted Spurious Emissions testing was performed by Tom Hsu on 2019-06-13.

8.9 Test Results

Test Mode: Transmitting

(Pre-scan with three orthogonal axis, and worse case as Z axis.)

Horizontal (worst case is Wi-Fi G mode low channel)

30MHz-1GHz:

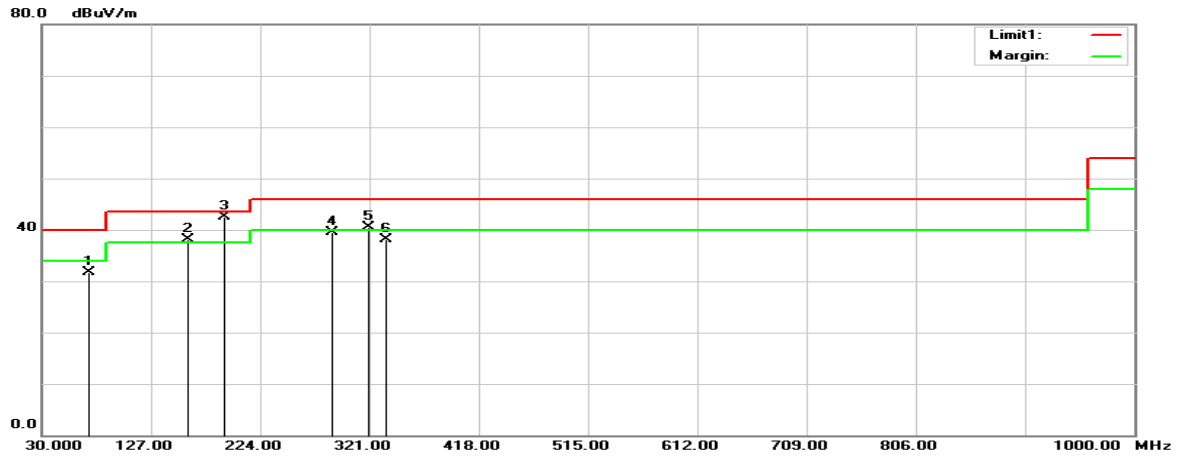

1GHz-18GHz:

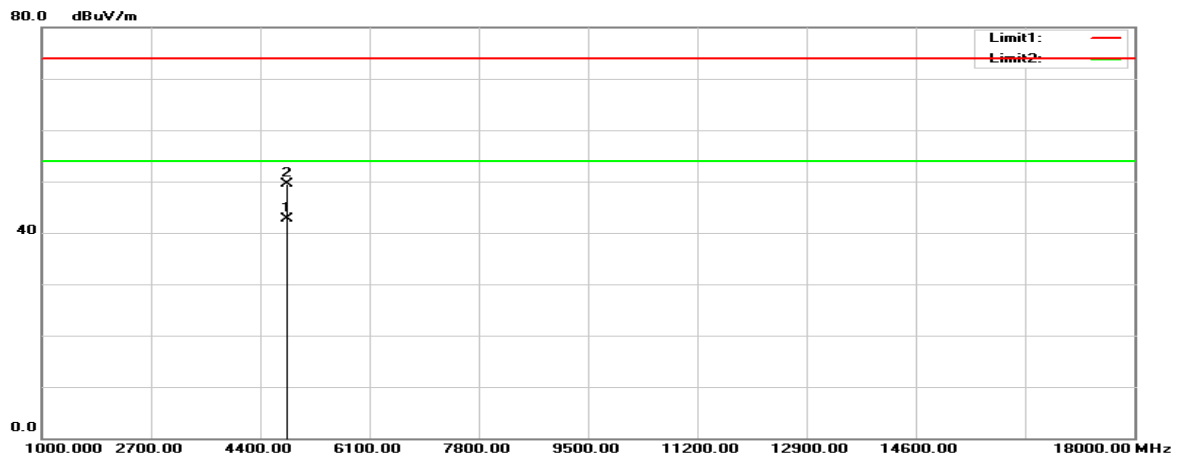

18GHz-26.5GHz:

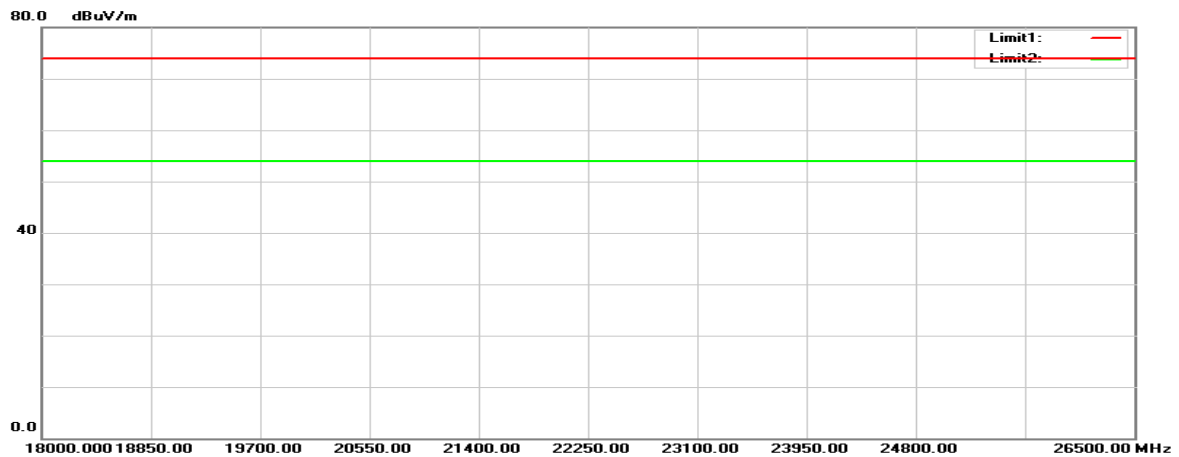

Vertical (worst case is Wi-Fi B mode Middle channel)

30MHz-1GHz:

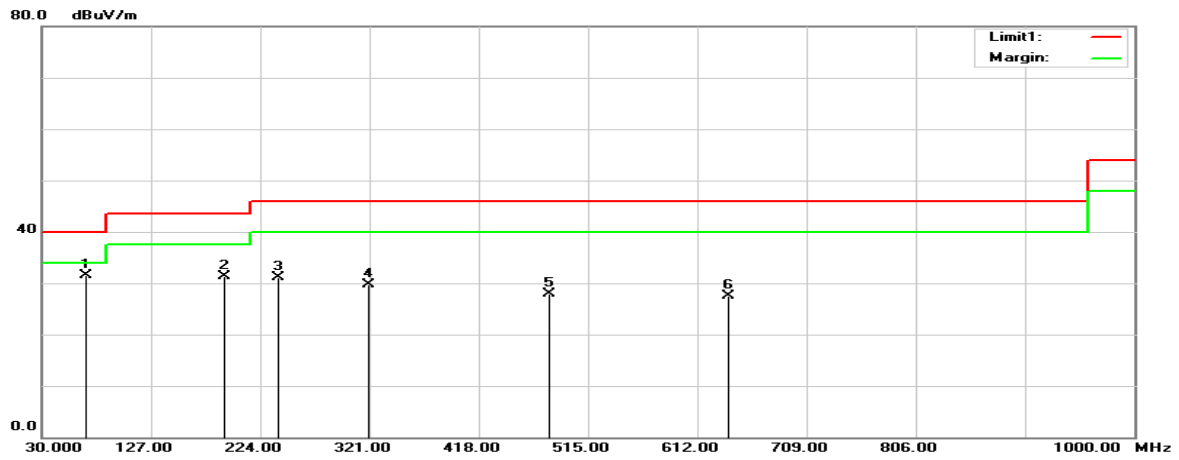

1GHz-18GHz:

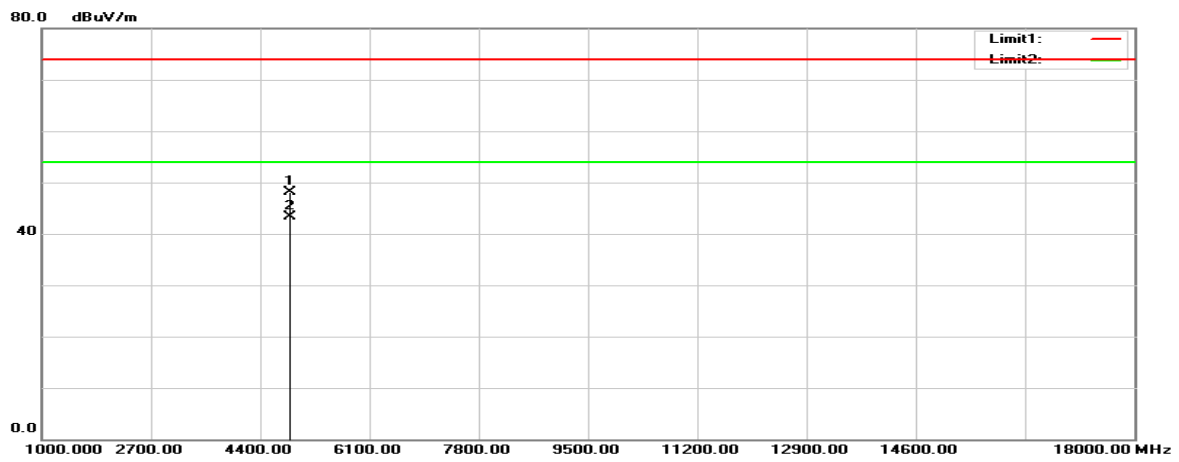

18GHz-26.5GHz:

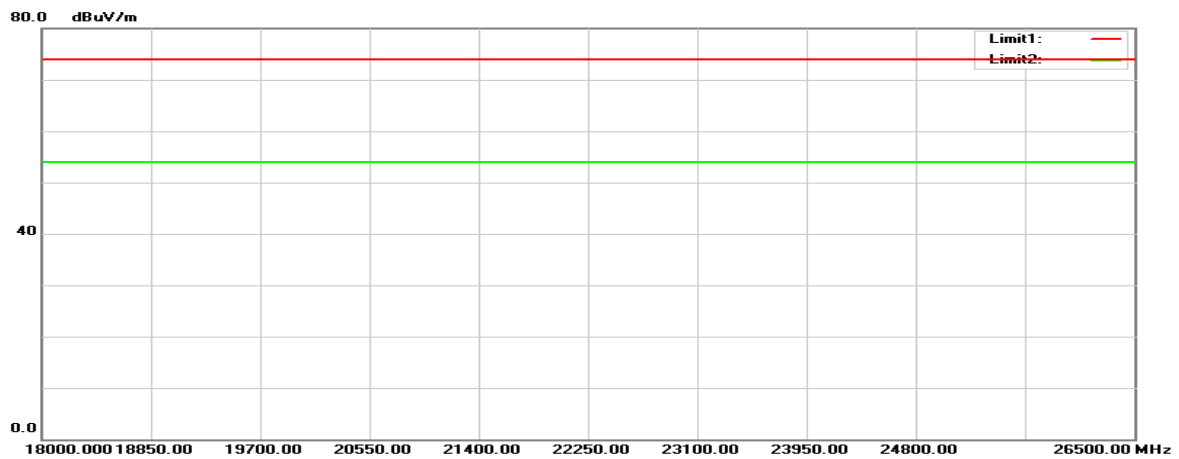

Below 1GHz**Horizontal**

Frequency (MHz)	Reading (dB μ V)	Correct Factor(dB/m)	Result (dB μ V/m)	Limit (dB μ V/m)	Margin (dB)	Height (cm)	Degree ($^{\circ}$)	Remark
B Mode								
159.9800	47.82	-9.79	38.03	43.50	-5.47	100	76	QP
192.0000	53.10	-10.56	42.54	43.50	-0.96	100	87	QP
239.5200	50.94	-10.39	40.55	46.00	-5.45	100	97	QP
288.0200	47.14	-8.17	38.97	46.00	-7.03	100	83	QP
320.0300	47.29	-7.56	39.73	46.00	-6.27	100	19	QP
359.8000	42.24	-6.76	35.48	46.00	-10.52	100	27	QP
G Mode								
71.7100	47.39	-15.77	31.62	40.00	-8.38	100	303	QP
159.9800	47.81	-9.79	38.02	43.50	-5.48	100	5	QP
191.9900	53.14	-10.56	42.58	43.50	-0.92	100	38	QP
288.0200	47.77	-8.17	39.60	46.00	-6.40	100	157	QP
320.0300	47.99	-7.56	40.43	46.00	-5.57	100	23	QP
335.5500	45.26	-7.24	38.02	46.00	-7.98	100	284	QP
N20 Mode								
159.9800	47.53	-9.79	37.74	43.50	-5.76	100	284	QP
191.9900	52.95	-10.56	42.39	43.50	-1.11	100	297	QP
239.5200	50.01	-10.39	39.62	46.00	-6.38	100	163	QP
288.0200	48.02	-8.17	39.85	46.00	-6.15	100	34	QP
320.0300	48.31	-7.56	40.75	46.00	-5.25	100	62	QP
359.8000	43.04	-6.76	36.28	46.00	-9.72	100	166	QP

Result = Reading + Correct Factor

Margin = Result - Limit

Correct Factor = Antenna Factor + Cable Loss - Amplifier Gain

Spurious emissions more than 20 dB below the limit were not reported.

Vertical

Frequency (MHz)	Reading (dB μ V)	Correct Factor(dB/m)	Result (dB μ V/m)	Limit (dB μ V/m)	Margin (dB)	Height (cm)	Degree ($^{\circ}$)	Remark
B Mode								
68.8000	47.40	-15.92	31.48	40.00	-8.52	100	69	QP
191.9900	41.95	-10.56	31.39	43.50	-12.11	100	315	QP
239.5200	41.54	-10.39	31.15	46.00	-14.85	100	130	QP
320.0300	37.24	-7.56	29.68	46.00	-16.32	100	67	QP
480.0800	32.73	-4.75	27.98	46.00	-18.02	100	101	QP
640.1300	30.45	-3.04	27.41	46.00	-18.59	100	81	QP
G Mode								
67.8300	47.76	-16.01	31.75	40.00	-8.25	100	83	QP
159.9800	39.48	-9.79	29.69	43.50	-13.81	100	53	QP
191.9900	42.18	-10.56	31.62	43.50	-11.88	100	210	QP
239.5200	41.91	-10.39	31.52	46.00	-14.48	100	29	QP
320.0300	37.43	-7.56	29.87	46.00	-16.13	100	305	QP
480.0800	33.63	-4.75	28.88	46.00	-17.12	100	331	QP
N20 Mode								
68.8000	47.28	-15.92	31.36	40.00	-8.64	100	344	QP
191.9900	42.24	-10.56	31.68	43.50	-11.82	100	202	QP
239.5200	41.81	-10.39	31.42	46.00	-14.58	100	40	QP
320.0300	37.01	-7.56	29.45	46.00	-16.55	100	66	QP
398.6000	34.05	-6.05	28.00	46.00	-18.00	100	103	QP
480.0800	33.51	-4.75	28.76	46.00	-17.24	100	105	QP

Result = Reading + Correct Factor

Margin = Result – Limit

Correct Factor = Antenna Factor + Cable Loss – Amplifier Gain

Spurious emissions more than 20 dB below the limit were not reported.

Above 1GHz

Horizontal

Frequency (MHz)	Reading (dBµV)	Correct Factor(dB/m)	Result (dBµV/m)	Limit (dBµV/m)	Margin (dB)	Height (cm)	Degree (°)	Remark
B Mode, Low channel								
2390.000	51.57	-3.87	47.70	74.00	-26.30	200	37	peak
2390.000	40.02	-3.87	36.15	54.00	-17.85	200	37	AVG
2412.000	96.45	-3.66	92.79	NA	NA	263	89	peak
2412.000	92.96	-3.66	89.30	NA	NA	263	89	AVG
4824.000	40.35	2.04	42.39	74.00	-31.61	100	115	peak
4824.000	30.68	2.04	32.72	54.00	-21.28	100	115	AVG
B Mode, Middle channel								
2437.000	97.09	-3.39	93.70	NA	NA	200	238	peak
2437.000	92.33	-3.39	88.94	NA	NA	200	238	AVG
4874.000	46.83	2.59	49.42	74.00	-24.58	100	96	peak
4874.000	43.53	2.59	46.12	54.00	-7.88	100	96	AVG
B Mode, High channel								
2462.000	96.30	-3.12	93.18	NA	NA	200	238	peak
2462.000	91.55	-3.12	88.43	NA	NA	200	238	AVG
2483.500	51.87	-2.88	48.99	74.00	-25.01	200	325	peak
2483.500	40.11	-2.88	37.23	54.00	-16.77	200	325	AVG
4924.000	45.77	2.81	48.58	74.00	-25.42	100	87	peak
4924.000	40.37	2.81	43.18	54.00	-10.82	100	87	AVG

Vertical

Frequency (MHz)	Reading (dBµV)	Correct Factor(dB/m)	Result (dBµV/m)	Limit (dBµV/m)	Margin (dB)	Height (cm)	Degree (°)	Remark
B Mode, Low channel								
2390.000	52.06	-3.87	48.19	74.00	-25.81	200	166	peak
2390.000	40.97	-3.87	37.10	54.00	-16.90	200	166	AVG
2412.000	101.25	-3.66	97.59	NA	NA	200	110	peak
2412.000	97.03	-3.66	93.37	NA	NA	200	110	AVG
4824.000	41.82	2.04	43.86	74.00	-30.14	100	205	peak
4824.000	30.58	2.04	32.62	54.00	-21.38	100	205	AVG
B Mode, Middle channel								
2437.000	100.19	-3.39	96.80	NA	NA	200	109	peak
2437.000	95.48	-3.39	92.09	NA	NA	200	109	AVG
4874.000	45.47	2.59	48.06	74.00	-25.94	100	192	peak
4874.000	40.65	2.59	43.24	54.00	-10.76	100	192	AVG
B Mode, High channel								
2462.000	100.20	-3.12	97.08	NA	NA	200	106	peak
2462.000	95.70	-3.12	92.58	NA	NA	200	106	AVG
2483.500	52.60	-2.88	49.72	74.00	-24.28	200	117	peak
2483.500	40.76	-2.88	37.88	54.00	-16.12	200	117	AVG
4924.000	44.39	2.81	47.20	74.00	-26.80	100	184	peak
4924.000	39.15	2.81	41.96	54.00	-12.04	100	184	AVG

Result = Reading + Correct Factor

Margin = Result – Limit

Correct Factor = Antenna Factor + Cable Loss – Amplifier Gain

Spurious emissions more than 20 dB below the limit were not reported.

Horizontal

Frequency (MHz)	Reading (dBµV)	Correct Factor(dB/m)	Result (dBµV/m)	Limit (dBµV/m)	Margin (dB)	Height (cm)	Degree (°)	Remark
G Mode, Low channel								
2390.000	50.53	-3.87	46.66	74.00	-27.34	200	64	peak
2390.000	39.89	-3.87	36.02	54.00	-17.98	200	64	AVG
2412.000	92.85	-3.66	89.19	NA	NA	200	239	peak
2412.000	82.17	-3.66	78.51	NA	NA	200	239	AVG
4824.000	40.69	2.04	42.73	74.00	-31.27	100	41	peak
4824.000	47.47	2.04	49.51	54.00	-4.49	100	41	AVG
G Mode, Middle channel								
2437.000	92.50	-3.39	89.11	NA	NA	200	90	peak
2437.000	82.20	-3.39	78.81	NA	NA	200	90	AVG
4874.000	40.10	2.59	42.69	74.00	-31.31	100	199	peak
4874.000	28.37	2.59	30.96	54.00	-23.04	100	199	AVG
G Mode, High channel								
2462.000	92.77	-3.12	89.65	NA	NA	200	237	peak
2462.000	82.28	-3.12	79.16	NA	NA	200	237	AVG
2483.500	51.17	-2.88	48.29	74.00	-25.71	200	246	peak
2483.500	40.70	-2.88	37.82	54.00	-16.18	200	246	AVG
4924.000	39.48	2.81	42.29	74.00	-31.71	100	100	peak
4924.000	27.68	2.81	30.49	54.00	-23.51	100	100	AVG

Vertical

Frequency (MHz)	Reading (dBµV)	Correct Factor(dB/m)	Result (dBµV/m)	Limit (dBµV/m)	Margin (dB)	Height (cm)	Degree (°)	Remark
G Mode, Low channel								
2390.000	51.29	-3.87	47.42	74.00	-26.58	200	99	peak
2390.000	40.81	-3.87	36.94	54.00	-17.06	200	99	AVG
2412.000	97.49	-3.66	93.83	NA	NA	200	109	peak
2412.000	87.02	-3.66	83.36	NA	NA	200	109	AVG
4824.000	40.23	2.04	42.27	74.00	-31.73	100	291	peak
4824.000	29.30	2.04	31.34	54.00	-22.66	100	291	AVG
G Mode, Middle channel								
2437.000	96.61	-3.39	93.22	NA	NA	200	109	peak
2437.000	85.73	-3.39	82.34	NA	NA	200	109	AVG
4874.000	39.38	2.59	41.97	74.00	-32.03	100	168	peak
4874.000	26.80	2.59	29.39	54.00	-24.61	100	168	AVG
G Mode, High channel								
2462.000	96.21	-3.12	93.09	NA	NA	200	103	peak
2462.000	85.62	-3.12	82.50	NA	NA	200	103	AVG
2483.500	51.93	-2.88	49.05	74.00	-24.95	200	76	peak
2483.500	41.03	-2.88	38.15	54.00	-15.85	200	76	AVG
4924.000	39.71	2.81	42.52	74.00	-31.48	100	0	peak
4924.000	27.07	2.81	29.88	54.00	-24.12	100	0	AVG

Result = Reading + Correct Factor

Margin = Result – Limit

Correct Factor = Antenna Factor + Cable Loss – Amplifier Gain

Spurious emissions more than 20 dB below the limit were not reported.

Horizontal

Frequency (MHz)	Reading (dBµV)	Correct Factor(dB/m)	Result (dBµV/m)	Limit (dBµV/m)	Margin (dB)	Height (cm)	Degree (°)	Remark
N20 Mode, Low channel								
2390.000	51.71	-3.87	47.84	74.00	-26.16	200	349	peak
2390.000	40.11	-3.87	36.24	54.00	-17.76	200	349	AVG
2412.000	91.79	-3.66	88.13	NA	NA	200	89	peak
2412.000	81.16	-3.66	77.50	NA	NA	200	89	AVG
4824.000	40.18	2.04	42.22	74.00	-31.78	100	207	peak
4824.000	27.80	2.04	29.84	54.00	-24.16	100	207	AVG
N20 Mode, Middle channel								
2437.000	92.28	-3.39	88.89	NA	NA	200	239	peak
2437.000	80.97	-3.39	77.58	NA	NA	200	239	AVG
4874.000	39.43	2.59	42.02	74.00	-31.98	100	225	peak
4874.000	27.84	2.59	30.43	54.00	-23.57	100	225	AVG
N20 Mode, High channel								
2462.000	91.91	-3.12	88.79	NA	NA	200	238	peak
2462.000	80.97	-3.12	77.85	NA	NA	200	238	AVG
2483.500	51.34	-2.88	48.46	74.00	-25.54	200	157	peak
2483.500	40.60	-2.88	37.72	54.00	-16.28	200	157	AVG
4924.000	38.87	2.81	41.68	74.00	-32.32	100	102	peak
4924.000	27.26	2.81	30.07	54.00	-23.93	100	102	AVG

Vertical

Frequency (MHz)	Reading (dBµV)	Correct Factor(dB/m)	Result (dBµV/m)	Limit (dBµV/m)	Margin (dB)	Height (cm)	Degree (°)	Remark
N20 Mode, Low channel								
2390.000	51.63	-3.87	47.76	74.00	-26.24	200	223	peak
2390.000	40.65	-3.87	36.78	74.00	-37.22	200	223	AVG
2412.000	96.67	-3.66	93.01	NA	NA	200	109	peak
2412.000	85.95	-3.66	82.29	NA	NA	200	109	AVG
4824.000	40.39	2.04	42.43	74.00	-31.57	100	283	peak
4824.000	28.05	2.04	30.09	54.00	-23.91	100	283	AVG
N20 Mode, Middle channel								
2437.000	95.98	-3.39	92.59	NA	NA	200	108	peak
2437.000	85.21	-3.39	81.82	NA	NA	200	108	AVG
4874.000	40.23	2.59	42.82	74.00	-31.18	100	217	peak
4874.000	26.97	2.59	29.56	54.00	-24.44	100	217	AVG
N20 Mode, High channel								
2462.000	96.43	-3.12	93.31	NA	NA	200	106	peak
2462.000	85.08	-3.12	81.96	NA	NA	200	106	AVG
2483.500	52.56	-2.88	49.68	74.00	-24.32	200	93	peak
2483.500	41.43	-2.88	38.55	54.00	-15.45	200	93	AVG
4924.000	39.38	2.81	42.19	74.00	-31.81	100	255	peak
4924.000	26.89	2.81	29.70	54.00	-24.30	100	255	AVG

Result = Reading + Correct Factor

Margin = Result – Limit

Correct Factor = Antenna Factor + Cable Loss – Amplifier Gain

Spurious emissions more than 20 dB below the limit were not reported.

Conducted Spurious Emissions:

Channel	Frequency (MHz)	Delta Peak to Band Emission (dBc)	Limit (dBc)	Result
B Mode				
Low	2412	47.04	≥ 20	PASS
Mid	2437	47.76	≥ 20	PASS
High	2462	47.39	≥ 20	PASS
G Mode				
Low	2412	43.93	≥ 20	PASS
Mid	2437	46.43	≥ 20	PASS
High	2462	47.47	≥ 20	PASS
N20 Mode				
Low	2412	42.89	≥ 20	PASS
Mid	2437	42.94	≥ 20	PASS
High	2462	43.80	≥ 20	PASS

**B Mode
Low Channel**

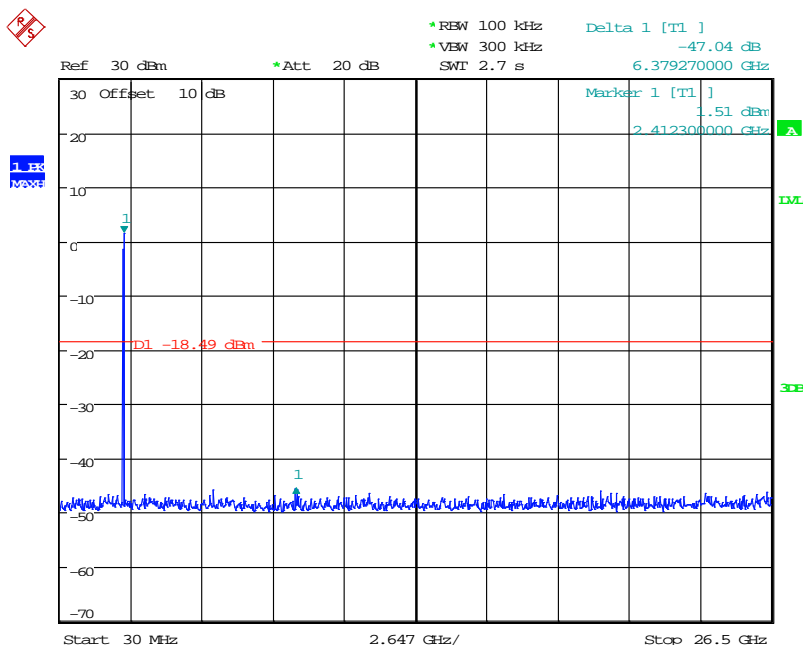

Date: 11.JUN.2019 10:15:23

Middle Channel

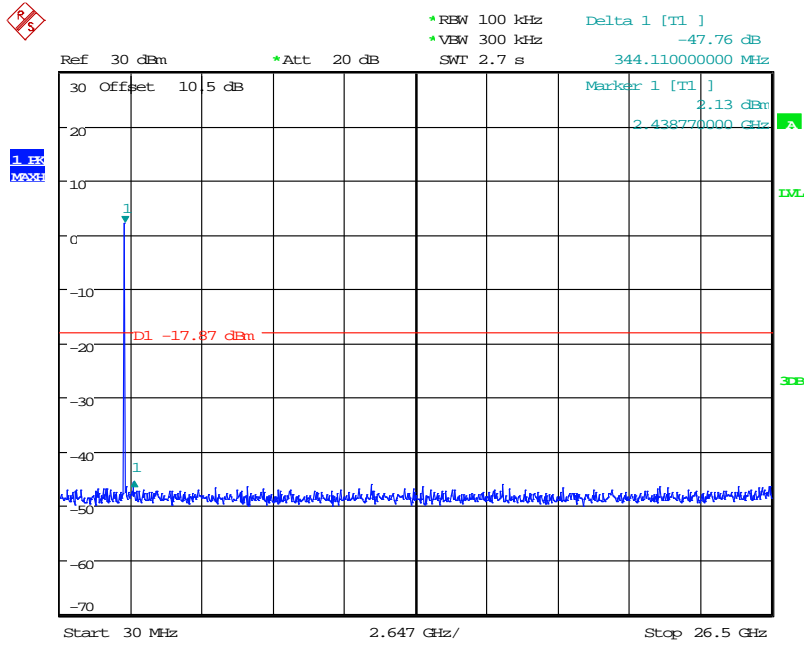

Date: 11.JUN.2019 10:27:32

High Channel

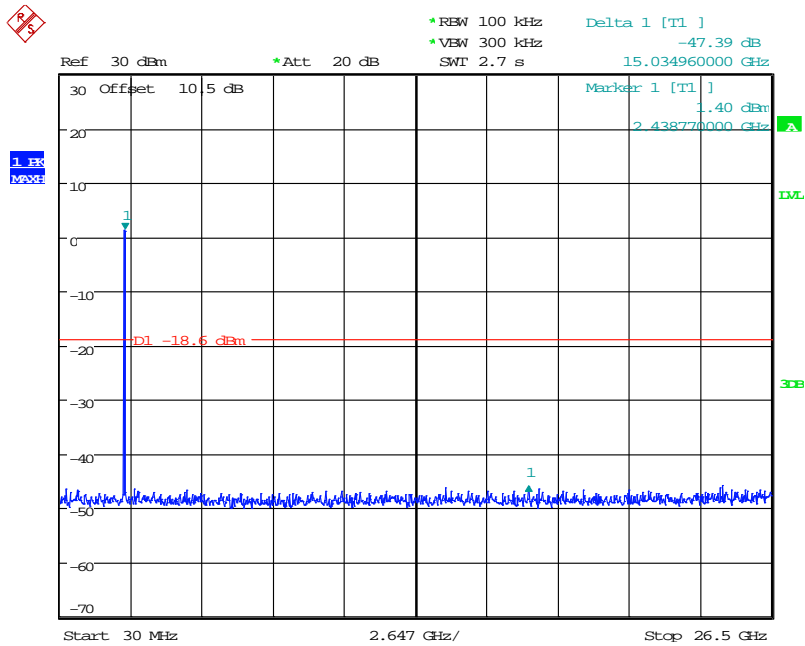

Date: 11.JUN.2019 10:30:01

G Mode Low Channel

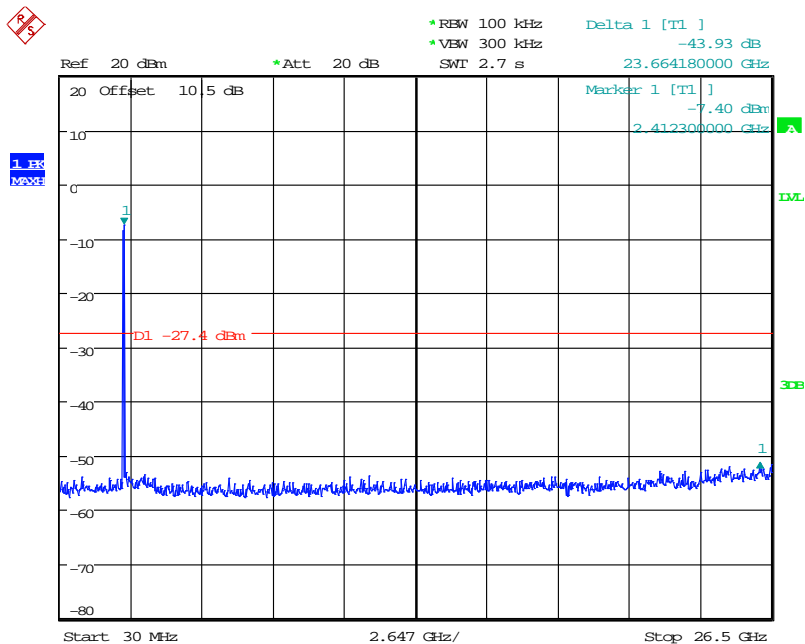

Date: 11.JUN.2019 10:50:53

Middle Channel

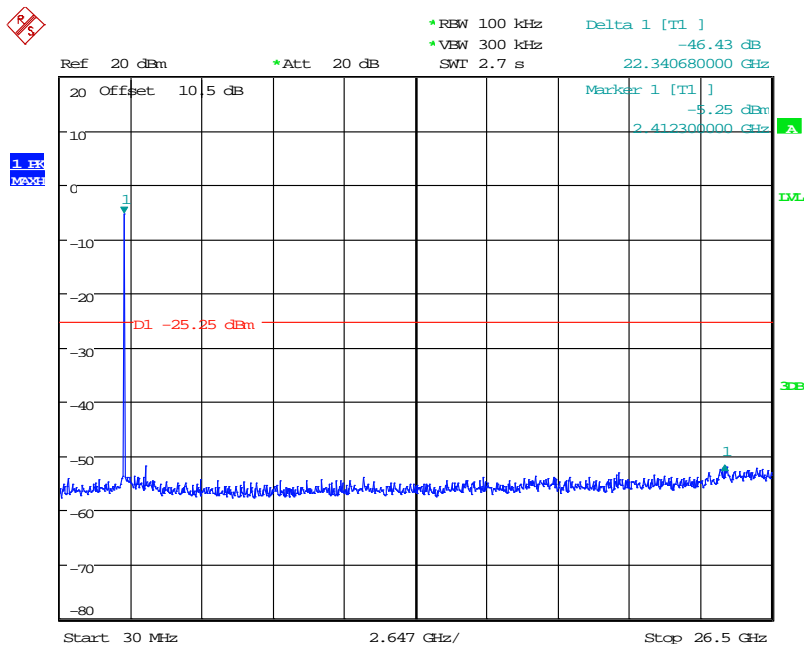

Date: 11.JUN.2019 10:54:17

High Channel

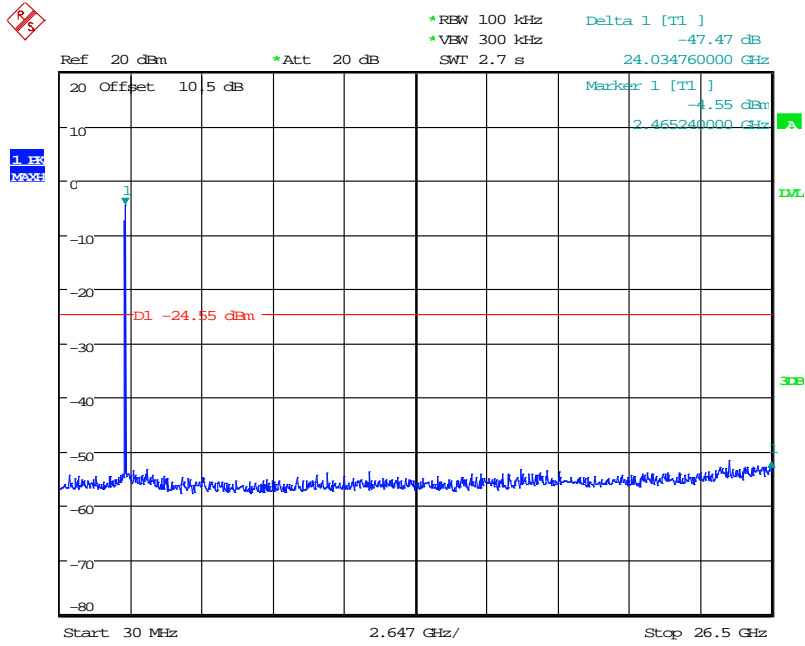

Date: 11.JUN.2019 11:01:40

N20 Mode Low Channel

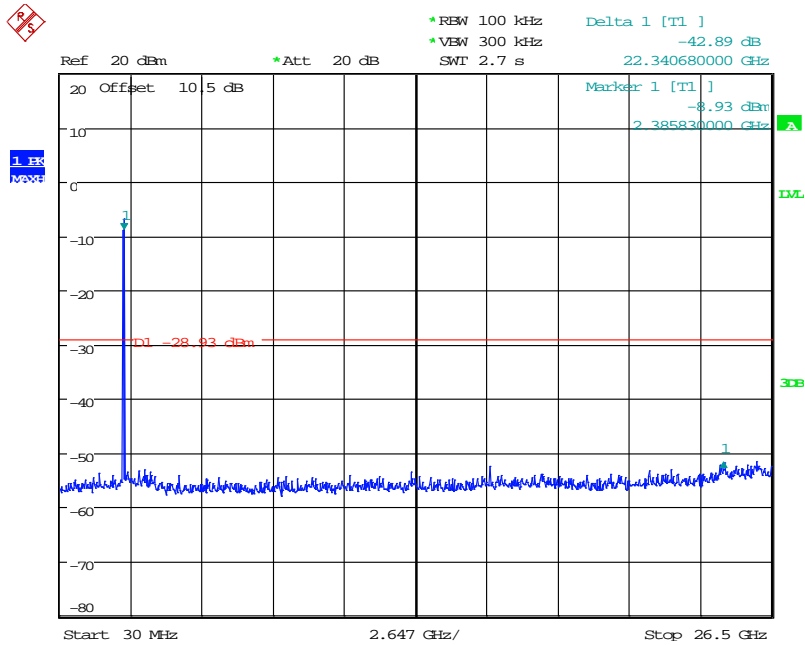

Date: 11.JUN.2019 11:20:53

Middle Channel

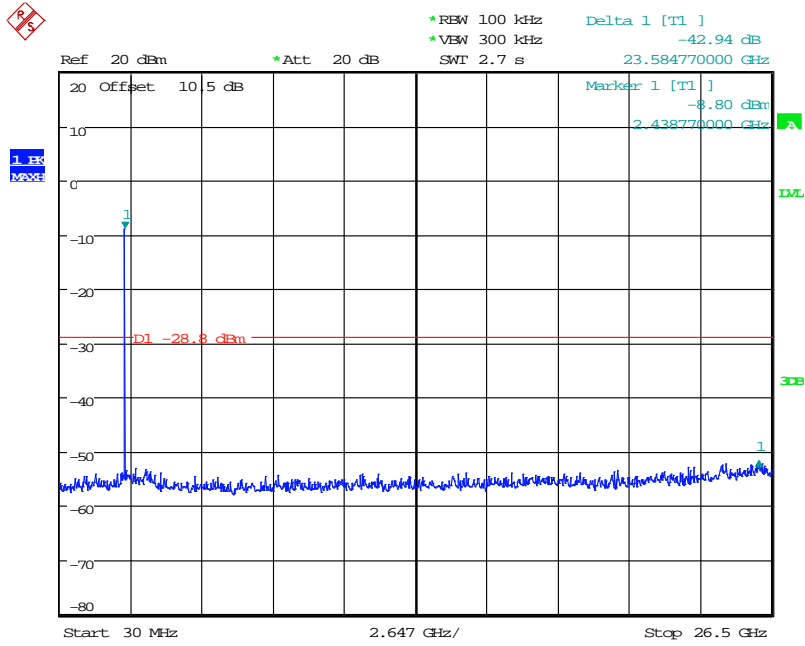

Date: 11.JUN.2019 11:16:30

High Channel

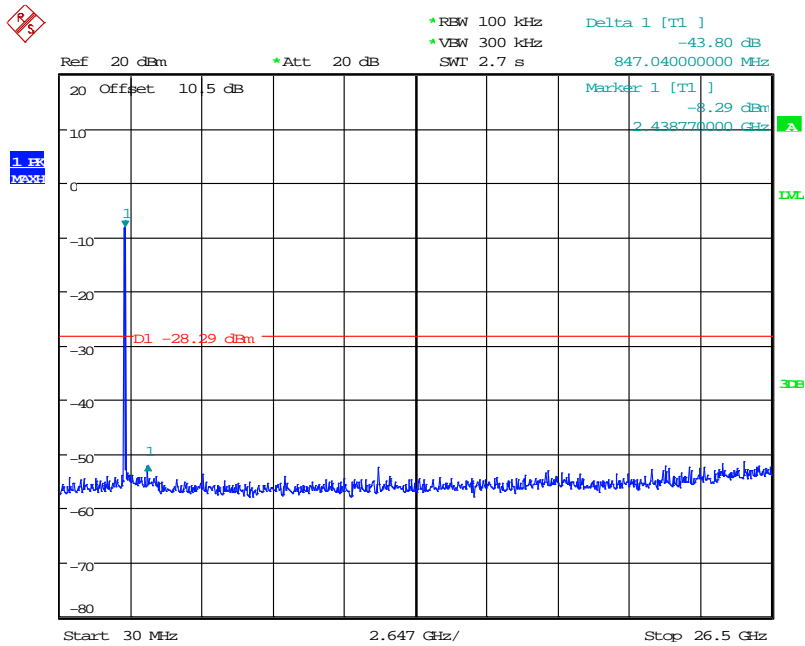

Date: 11.JUN.2019 11:23:46

9 FCC §15.247(a)(2) – 6 dB Emission Bandwidth

9.1 Applicable Standard

According to FCC §15.247(a)(2).

Systems using digital modulation techniques may operate in the 902–928 MHz, 2400–2483.5 MHz, and 5725–5850 MHz bands. The minimum 6 dB bandwidth shall be at least 500 kHz.

9.2 Test Procedure

The steps for the first option are as follows:

- a) Set RBW = 100 kHz.
- b) Set the VBW $\geq [3 \times \text{RBW}]$.
- c) Detector = peak.
- d) Trace mode = max hold.
- e) Sweep = auto couple.
- f) Allow the trace to stabilize.
- g) Measure the maximum width of the emission that is constrained by the frequencies associated with the two outermost amplitude points (upper and lower frequencies) that are attenuated by 6 dB relative to the maximum level measured in the fundamental emission.

9.3 Environmental Conditions

Temperature:	21.8 °C
Relative Humidity:	57.9 %
ATM Pressure:	1010 hPa

The testing was performed by Tom Hsu on 2019-06-11.

9.4 Test Results

Channel	Frequency (MHz)	6 dB Emission Bandwidth (MHz)	Limit (kHz)	Result
B Mode				
Low	2412	8.56	> 500	PASS
Middle	2437	8.56	> 500	PASS
High	2462	8.56	> 500	PASS
G Mode				
Low	2412	16.28	> 500	PASS
Middle	2437	16.32	> 500	PASS
High	2462	16.08	> 500	PASS
N20 Mode				
Low	2412	16.28	> 500	PASS
Middle	2437	16.28	> 500	PASS
High	2462	16.32	> 500	PASS

Please refer to the following plots

**B Mode
Low Channel**

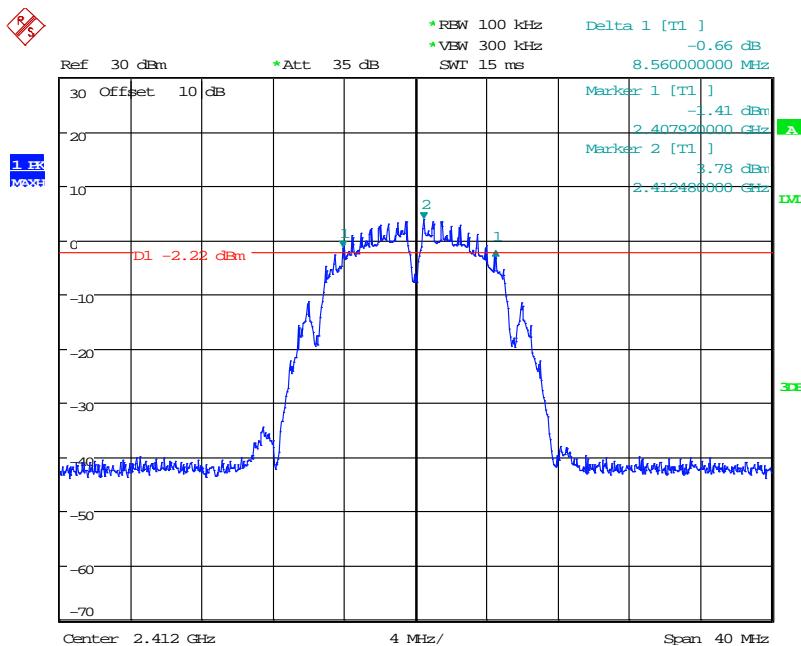

Date: 11.JUN.2019 10:14:36

Middle Channel

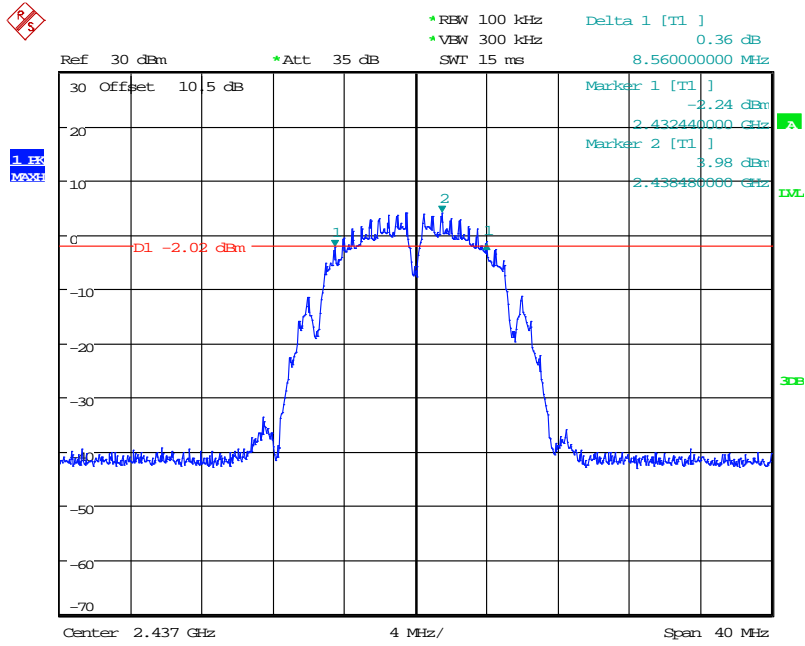

Date: 11.JUN.2019 10:27:04

High Channel

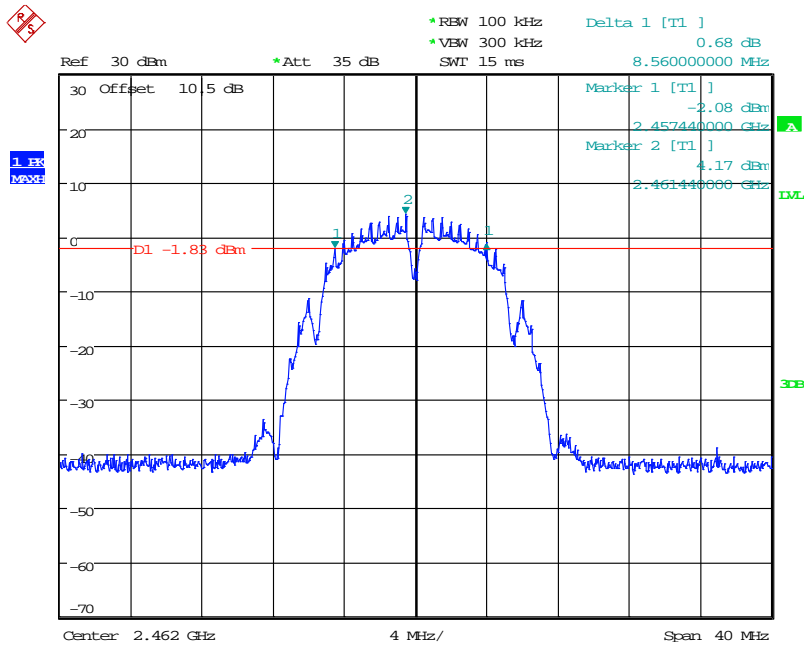

Date: 11.JUN.2019 10:29:14

G Mode Low Channel

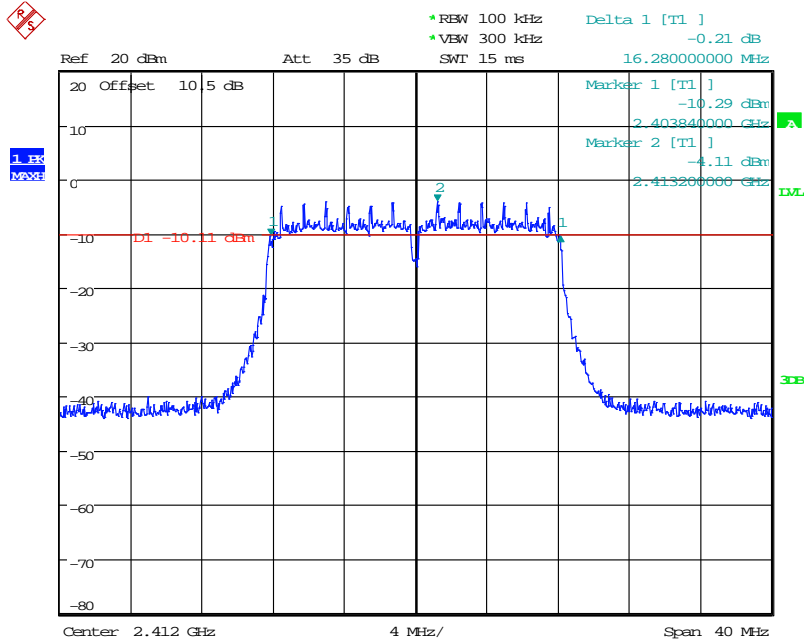

Date: 11.JUN.2019 10:50:07

Middle Channel

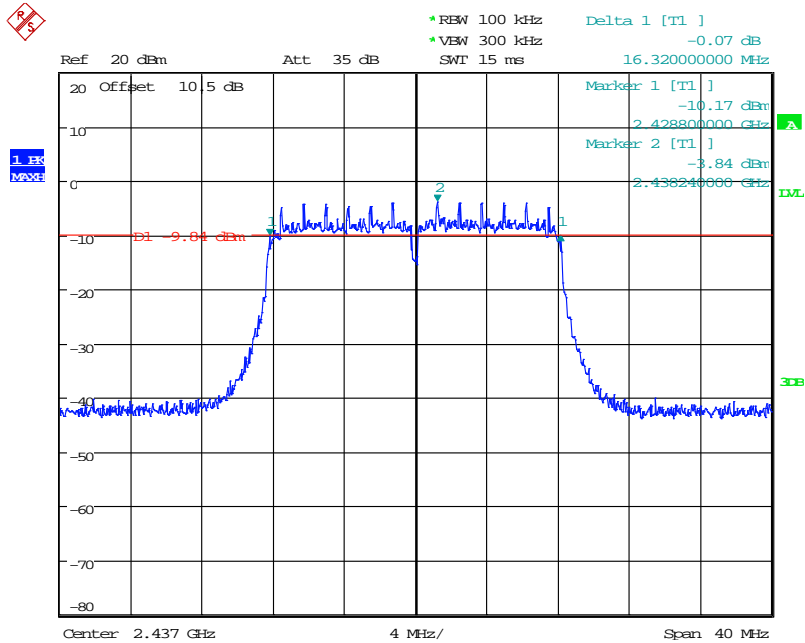

Date: 11.JUN.2019 10:53:49

High Channel

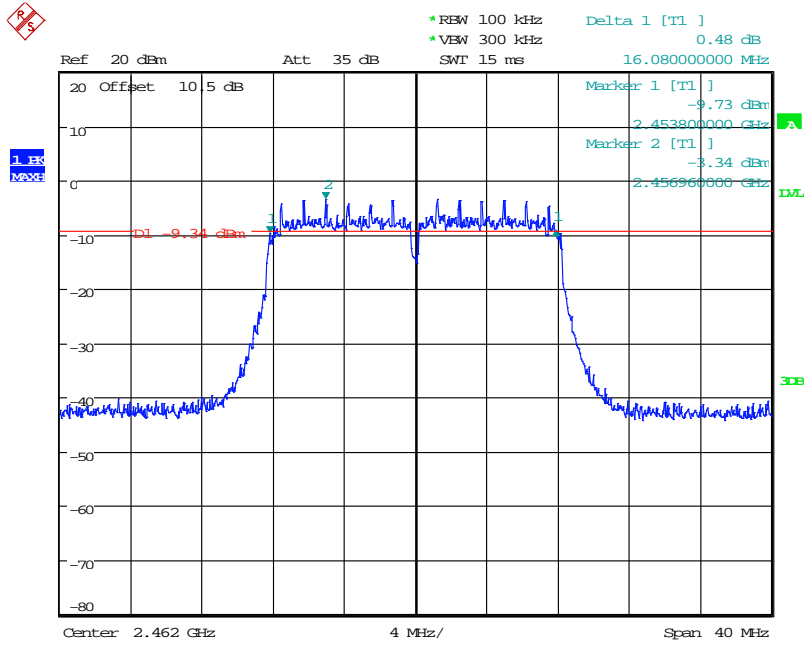

Date: 11.JUN.2019 11:00:53

N20 Mode Low Channel

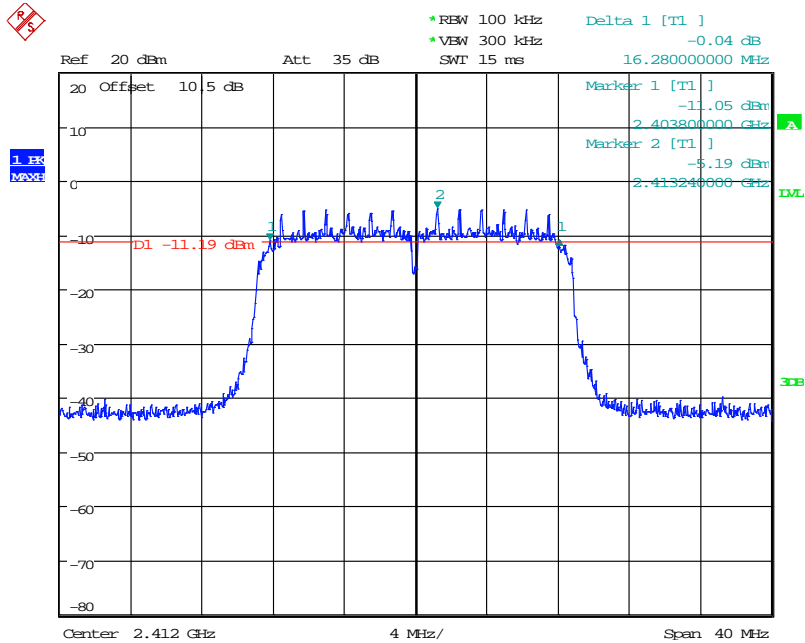

Date: 11.JUN.2019 11:20:06

Middle Channel

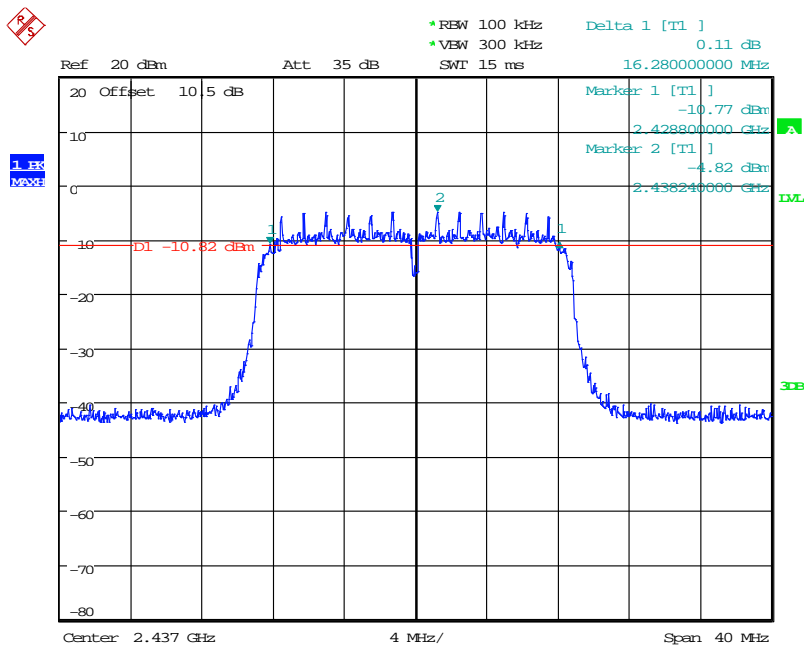

Date: 11.JUN.2019 11:16:02

High Channel

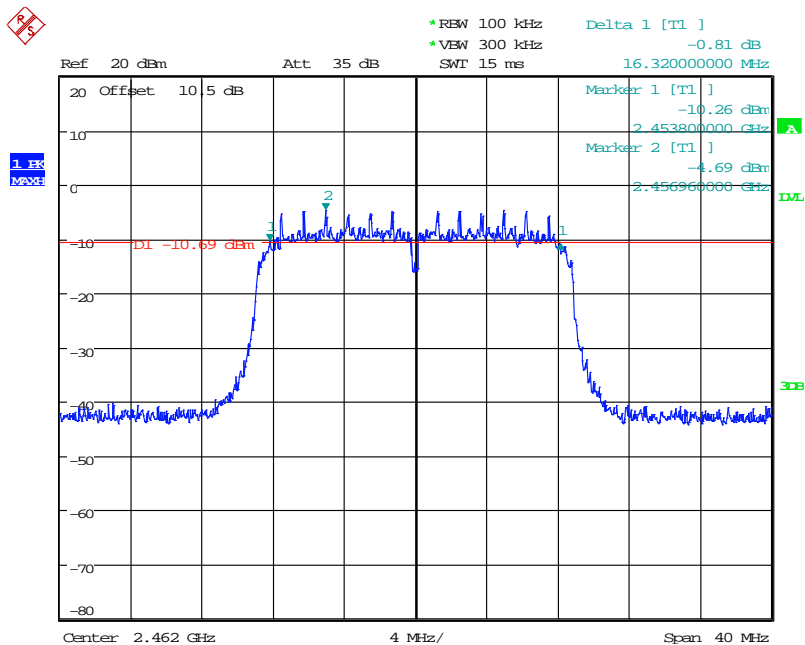

Date: 11.JUN.2019 11:22:59

10 FCC §15.247(b)(3) – Maximum Output Power

10.1 Applicable Standard

According to FCC §15.247(b) (3).

Systems using digital modulation in the 902-928 MHz, 2400-2483.5 MHz, and 5725-5850 MHz bands: 1 Watt. As an alternative to a peak power measurement, compliance with the one Watt limit can be based on a measurement of the maximum conducted output power. Maximum Conducted Output Power is defined as the total transmit power delivered to all antennas and antenna elements averaged across all symbols in the signaling alphabet when the transmitter is operating at its maximum power control level. Power must be summed across all antennas and antenna elements. The average must not include any time intervals during which the transmitter is off or is transmitting at a reduced power level. If multiple modes of operation are possible (e.g., alternative modulation methods), the maximum conducted output power is the highest total transmit power occurring in any mode.

10.2 Test Procedure

1. Place the EUT on a bench and set it in transmitting mode.
2. Remove the antenna from the EUT and then connect a low loss RF cable from the antenna port to measuring equipment.

10.3 Environmental Conditions

Temperature:	21.8 °C
Relative Humidity:	57.9 %
ATM Pressure:	1010 hPa

The testing was performed by Tom Hsu on 2019-06-11.

10.4 Test Results

Conducted Peak Output Power

Channel	Frequency (MHz)	Power (dBm)	Power (W)	Limit (W)	Result
B Mode					
Low	2412	16.31	0.043	1	PASS
Middle	2437	16.51	0.045	1	PASS
High	2462	16.39	0.044	1	PASS
G Mode					
Low	2412	15.24	0.033	1	PASS
Middle	2437	15.53	0.036	1	PASS
High	2462	15.74	0.037	1	PASS
N20 Mode					
Low	2412	14.30	0.027	1	PASS
Middle	2437	14.58	0.029	1	PASS
High	2462	14.73	0.030	1	PASS

Conducted Average Output Power

Channel	Frequency (MHz)	Power (dBm)	Duty Factor (dB)	Power With Duty Factor (dBm)	Limit (dBm)	Result
B Mode						
Low	2412	10.89	0.56	11.45	30	PASS
Middle	2437	11.56	0.56	12.12	30	PASS
High	2462	11.65	0.56	12.21	30	PASS
G Mode						
Low	2412	6.34	0.71	7.05	30	PASS
Middle	2437	6.61	0.71	7.32	30	PASS
High	2462	6.79	0.71	7.5	30	PASS
N20 Mode						
Low	2412	5.2	0.81	6.01	30	PASS
Middle	2437	5.48	0.81	6.29	30	PASS
High	2462	5.62	0.81	6.43	30	PASS

11 FCC§15.247(d) – 100 kHz Bandwidth of Frequency Band Edge

11.1 Applicable Standard

According to FCC §15.247(d).

In any 100kHz bandwidth outside the frequency band in which the spread spectrum or digitally modulated intentional radiator is operating, the radio frequency power that is produced by the intentional radiator shall be at least 20dB below that in the 100kHz bandwidth within the band that contains the highest level of the desired power, based on either an RF conducted or a radiated measurement, provided the transmitter demonstrates compliance with the peak conducted power limits. If the transmitter complies with the conducted power limits based on the use of RMS averaging over a time interval, as permitted under paragraph (b)(3) of this section, the attenuation required under this paragraph shall be 30dB instead of 20dB. Attenuation below the general limits specified in §15.209(a) is not required. In addition, radiated emissions which fall in the restricted bands, as defined in §15.205(a), must also comply with the radiated emission limits specified in §15.209(a) (see §15.205(c)).

11.2 Test Procedure

1. Check the calibration of the measuring instrument using either an internal calibrator or a known signal from an external generator.
2. Position the EUT without connection to measurement instrument. Turn on the EUT and connect its antenna terminal to measurement instrument via a low loss cable. Then set it to any one measured frequency within its operating range, and make sure the instrument is operated in its linear range.
3. Set RBW to 100 kHz and VBW of spectrum analyzer to 300 kHz with a convenient frequency span including 100 kHz bandwidth from band edge.
4. Measure the highest amplitude appearing on spectral display and set it as a reference level. Plot the graph with marking the highest point and edge frequency.
5. Repeat above procedures until all measured frequencies were complete.

11.3 Environmental Conditions

Temperature:	21.8 °C
Relative Humidity:	57.9 %
ATM Pressure:	1010 hPa

The testing was performed by Tom Hsu on 2019-06-11.

11.4 Test Results

Channel	Frequency (MHz)	Delta Peak to Band Emission (dBc)	Limit (dBc)	Result
B Mode				
Low	2412	42.37	≥ 20	PASS
High	2462	43.55	≥ 20	PASS
G Mode				
Low	2412	36.67	≥ 20	PASS
High	2462	36.91	≥ 20	PASS
N20 Mode				
Low	2412	35.80	≥ 20	PASS
High	2462	36.13	≥ 20	PASS

Please refer to the following plots.

**B Mode
Band Edge, Left Side**

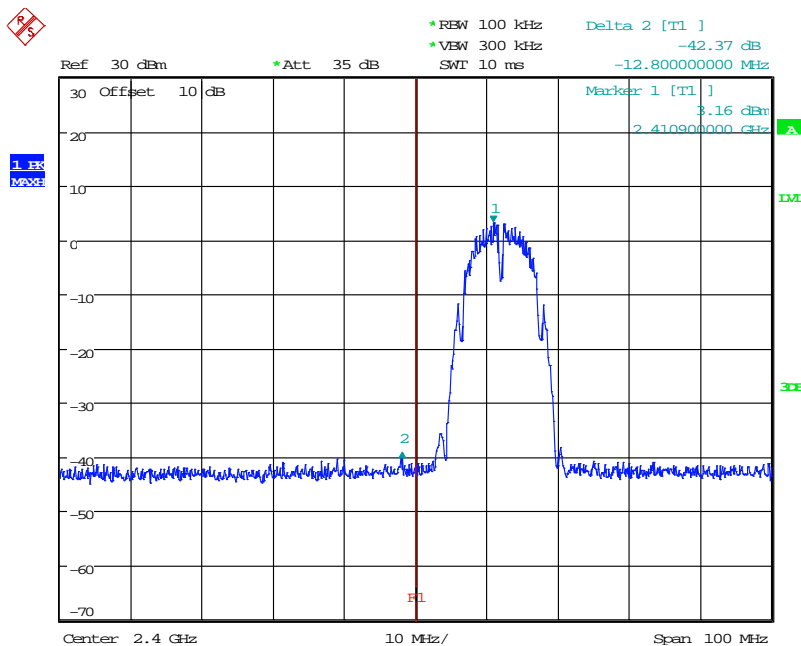

Date: 11.JUN.2019 10:15:05

Band Edge, Right Side

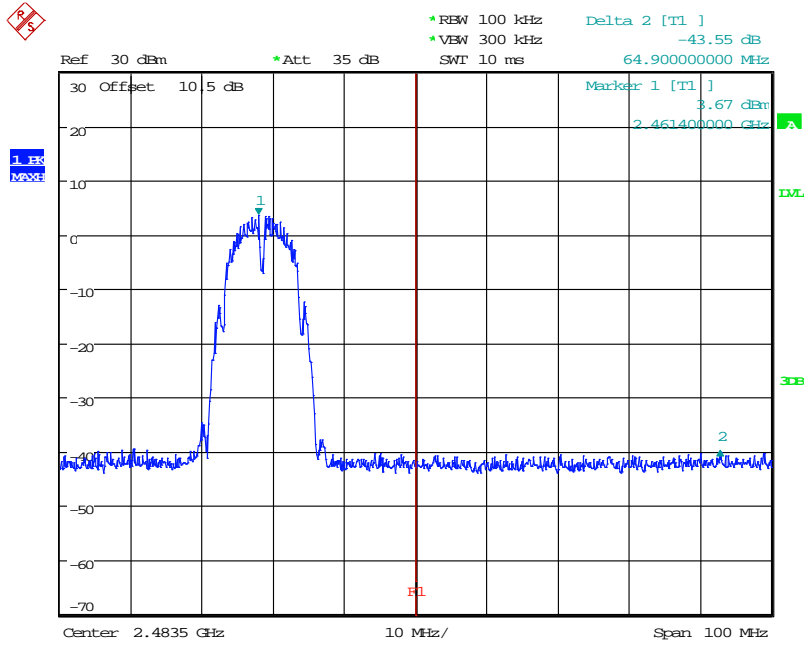

Date: 11.JUN.2019 10:29:43

G Mode Band Edge, Left Side

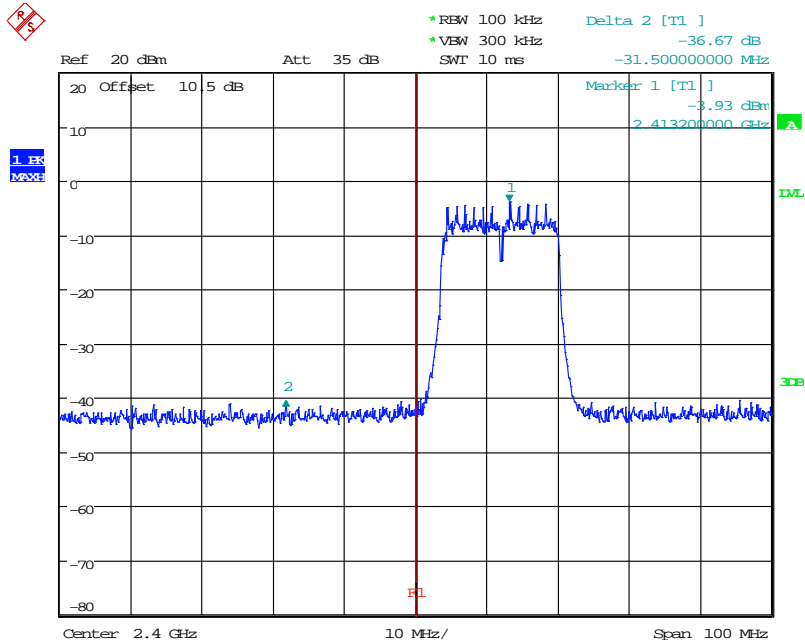

Date: 11.JUN.2019 10:50:35

Band Edge, Right Side

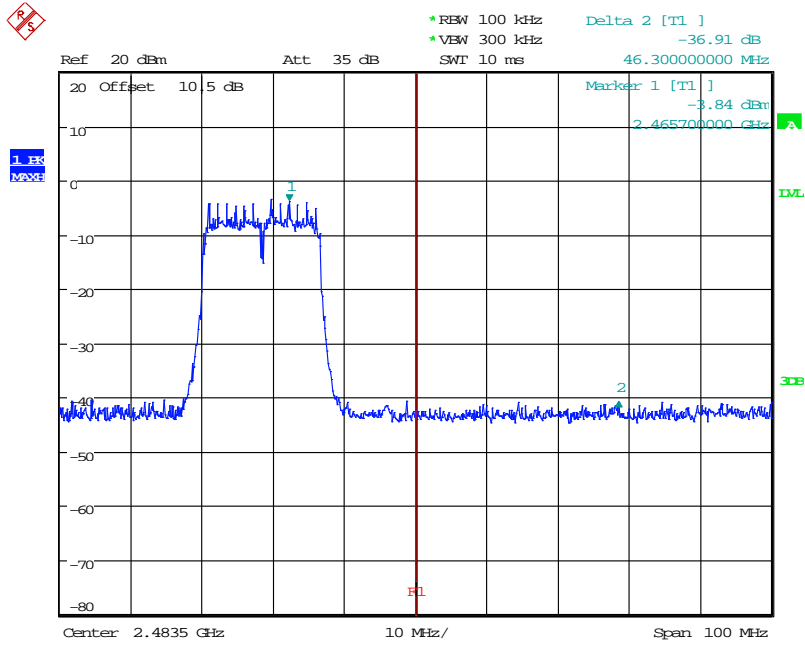

Date: 11.JUN.2019 11:01:21

N20 Mode Band Edge, Left Side

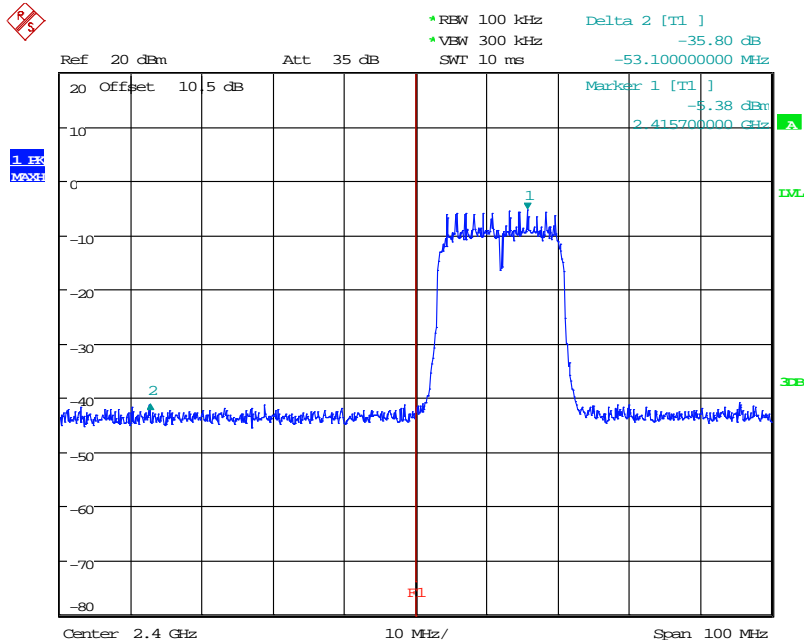

Date: 11.JUN.2019 11:20:34

Band Edge, Right Side

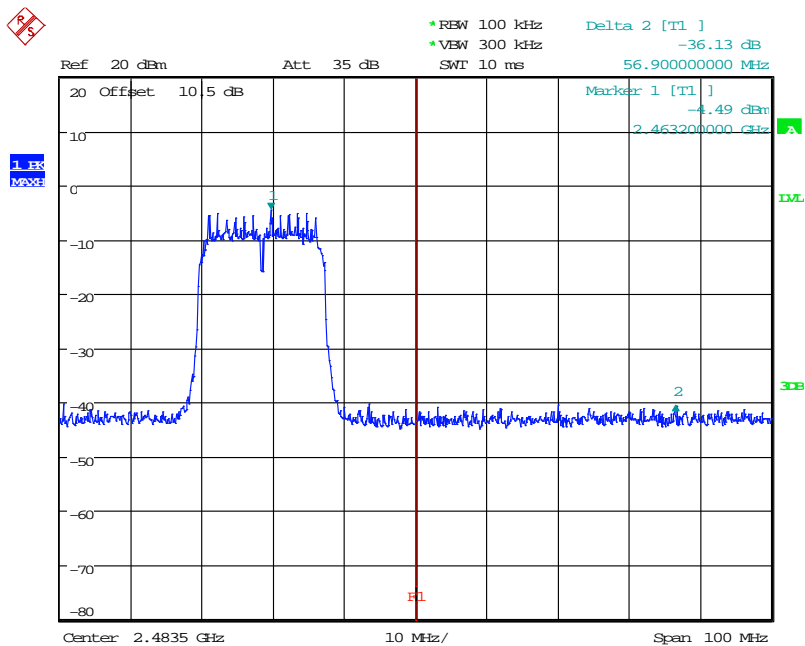

Date: 11.JUN.2019 11:23:28

12 FCC §15.247(e) – Power Spectral Density

12.1 Applicable Standard

According to FCC §15.247(e).

For digitally modulated systems, the power spectral density conducted from the intentional radiator to the antenna shall not be greater than 8 dBm in any 3 kHz band during any time interval of continuous transmission. This power spectral density shall be determined in accordance with the provisions of paragraph (b) of this section. The same method of determining the conducted output power shall be used to determine the power spectral density.

12.2 Test Procedure

According to ANSI C63.10-2013

- a) Set analyzer center frequency to DTS channel center frequency.
- b) Set the span to 1.5 times the DTS bandwidth.
- c) Set the RBW to $3 \text{ kHz} \leq \text{RBW} \leq 100 \text{ kHz}$.
- d) Set the VBW $\geq [3 \times \text{RBW}]$.
- e) Detector = peak.
- f) Sweep time = auto couple.
- g) Trace mode = max hold.
- h) Allow trace to fully stabilize.
- i) Use the peak marker function to determine the maximum amplitude level within the RBW.
- j) If measured value exceeds requirement, then reduce RBW (but no less than 3 kHz) and repeat

12.3 Environmental Conditions

Temperature:	21.8 °C
Relative Humidity:	57.9 %
ATM Pressure:	1010 hPa

The testing was performed by Tom Hsu on 2019-06-11.

12.4 Test Results

Channel	Frequency (MHz)	Power Spectral Density (dBm/3 kHz)	Limit (dBm/3 kHz)	Result
B Mode				
Low	2412	-10.80	8	PASS
Middle	2437	-10.62	8	PASS
High	2462	-11.37	8	PASS
G Mode				
Low	2412	-17.61	8	PASS
Middle	2437	-17.65	8	PASS
High	2462	-16.94	8	PASS
N20 Mode				
Low	2412	-19.59	8	PASS
Middle	2437	-18.43	8	PASS
High	2462	-19.25	8	PASS

Please refer to the following plots

**B Mode
Low Channel**

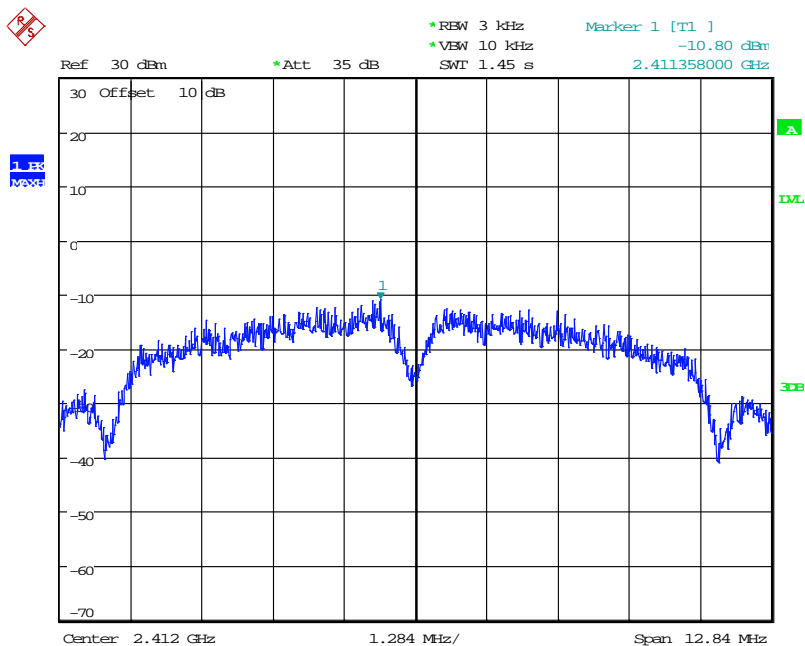

Date: 11.JUN.2019 10:14:46

Middle Channel

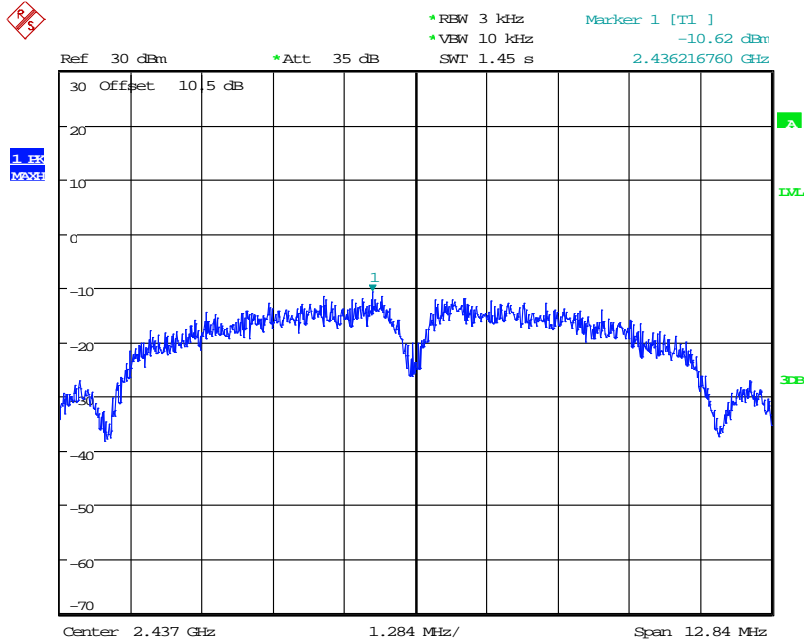

Date: 11.JUN.2019 10:27:14

High Channel

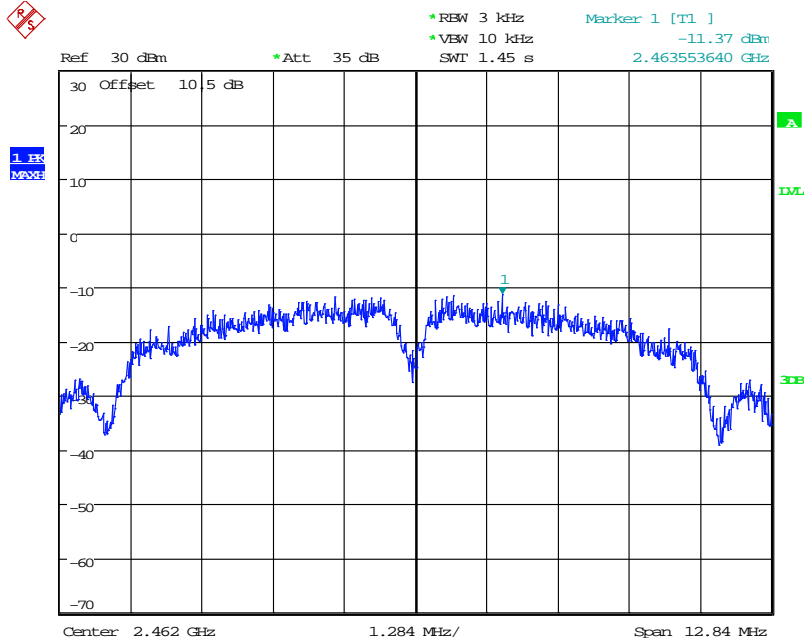

Date: 11.JUN.2019 10:29:24

G Mode Low Channel

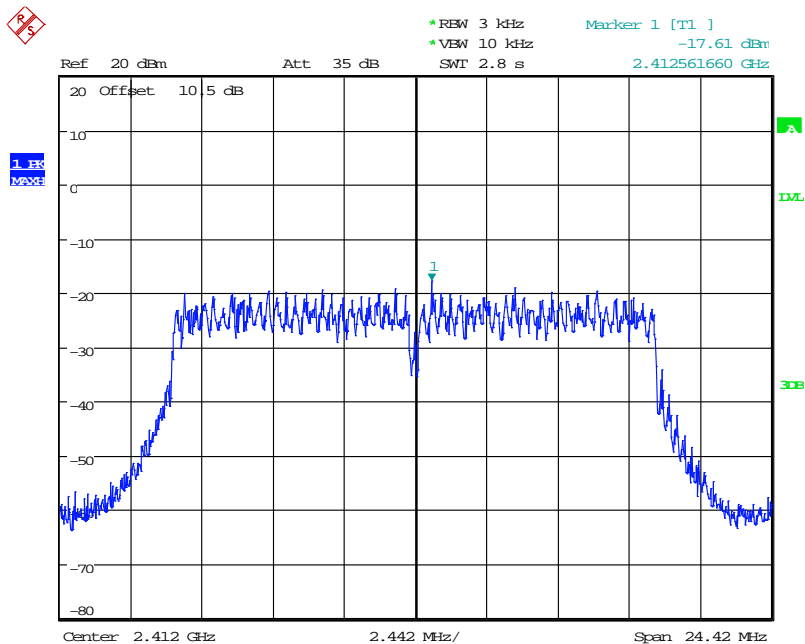

Date: 11.JUN.2019 10:50:17

Middle Channel

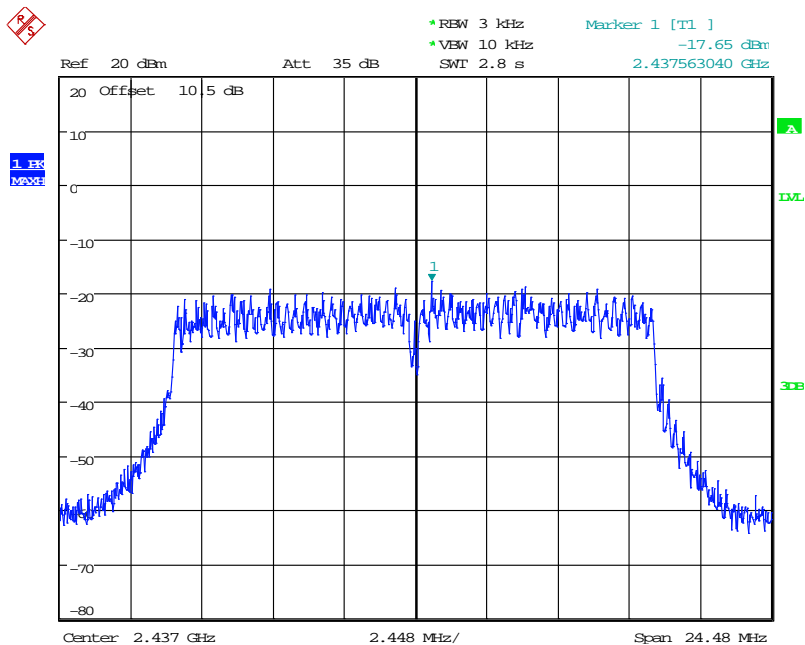

Date: 11.JUN.2019 10:53:59

High Channel

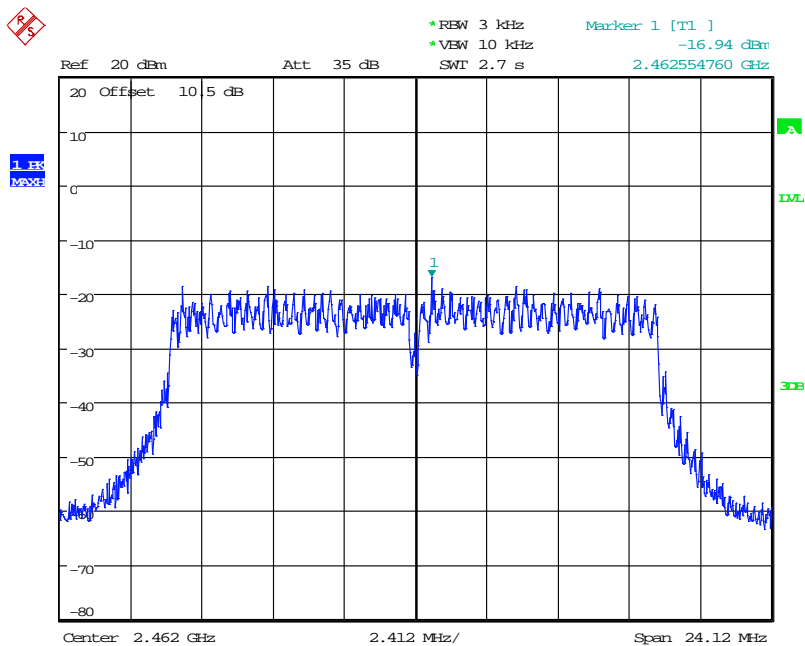

Date: 11.JUN.2019 11:01:03

N20 Mode Low Channel

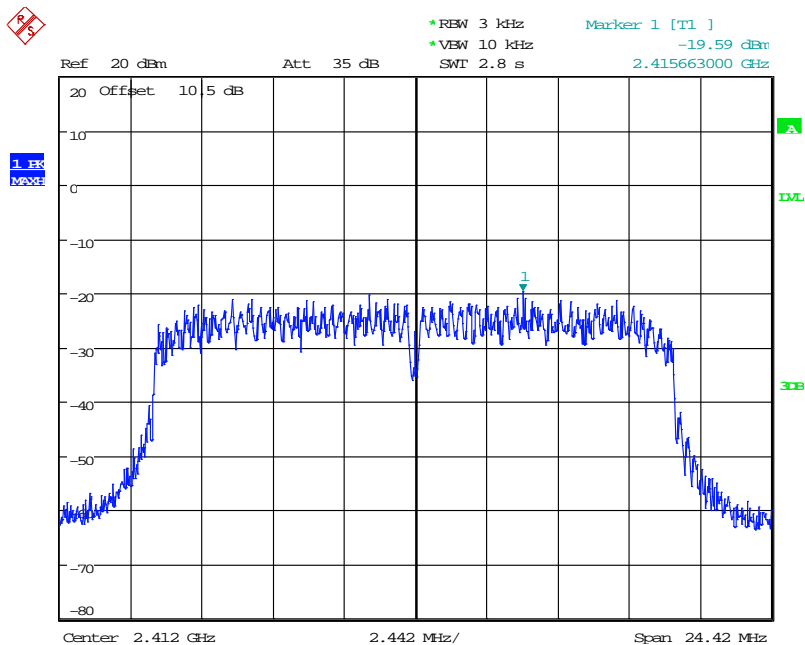

Date: 11.JUN.2019 11:20:16

Middle Channel

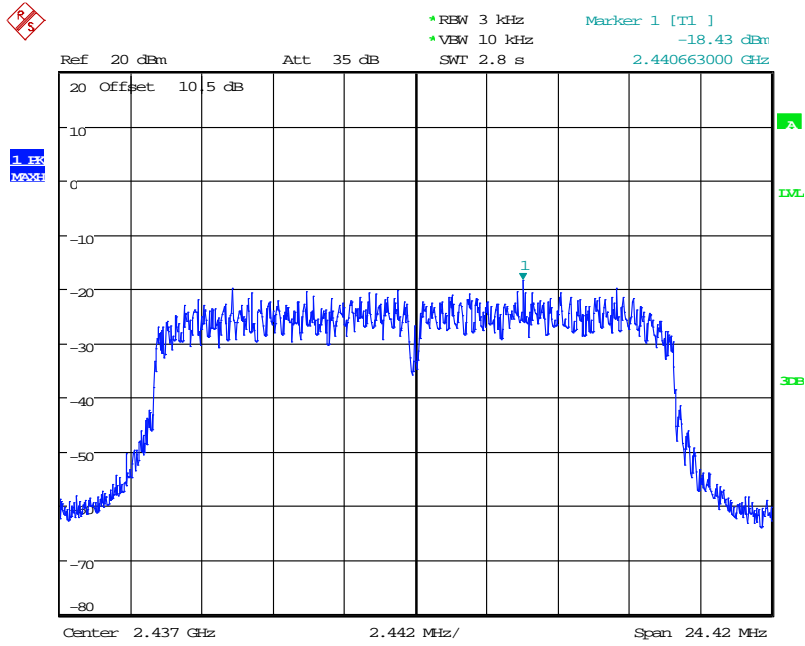

Date: 11.JUN.2019 11:16:12

High Channel

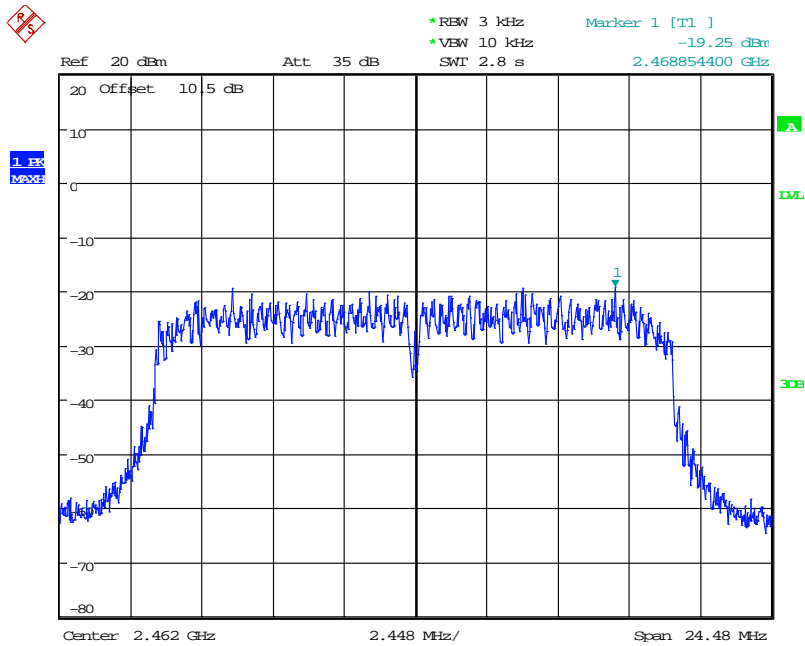

Date: 11.JUN.2019 11:23:09

***** END OF REPORT *****