

TEST REPORT

FCC ID: 2AJ3GCH728H4CWA28PW

Product: Wireless Camera

Model No.: RS-CH728H4C-WA28PW

**Additional Model No.: zzyy-CHxxxzyz-zzz-zzyyyyzz-zzz; (x= 0-9; y=0-9 or blank;
z= A-Z or blank;)**

Trade Mark: N/A

Report No.: TCT201012E012

Issued Date: Oct. 28, 2020

Issued for:

**Zhuhai RaySharp Technology Co., Ltd
NO.100 OF TECHNOLOGY ROAD 6, NATIONAL HI-TECH ZONE, ZHUHAI,
China**

Issued By:

**Shenzhen Tongce Testing Lab.
1B/F., Building 1, Yibaolai Industrial Park, Qiaotou, Fuyong, Baoan District,
Shenzhen, Guangdong, China**

TEL: +86-755-27673339

FAX: +86-755-27673332

Note: This report shall not be reproduced except in full, without the written approval of Shenzhen Tongce Testing Lab.

This document may be altered or revised by Shenzhen Tongce Testing Lab. personnel only, and shall be noted in the revision section of the document. The test results in the report only apply to the tested sample.

TABLE OF CONTENTS

1. Test Certification.....	3
2. Test Result Summary	4
3. EUT Description	5
4. General Information.....	7
4.1. Test environment and mode.....	7
4.2. Description of Support Units.....	8
5. Facilities and Accreditations	9
5.1. Facilities	9
5.2. Location	9
5.3. Measurement Uncertainty.....	9
6. Test Results and Measurement Data	10
6.1. Antenna requirement	10
6.2. Conducted Emission.....	11
6.3. Maximum Conducted (Average) Output Power	15
6.4. Emission Bandwidth	16
6.5. Power Spectral Density.....	17
6.6. Conducted Band Edge and Spurious Emission Measurement	18
6.7. Radiated Spurious Emission Measurement.....	20
Appendix A: Test Result of Conducted Test	
Appendix B: Photographs of Test Setup	
Appendix C: Photographs of EUT	

1. Test Certification

Product:	Wireless Camera
Model No.:	RS-CH728H4C-WA28PW
Additional Model No.:	zzyy-CHxxxzyz-zzz-zzyyyyzz-zzz; (x= 0-9; y=0-9 or blank; z= A-Z or blank;)
Trade Mark:	N/A
Applicant:	Zhuhai RaySharp Technology Co., Ltd
Address:	NO.100 OF TECHNOLOGY ROAD 6, NATIONAL HI-TECH ZONE, ZHUHAI, China
Manufacturer:	Zhuhai RaySharp Technology Co., Ltd
Address:	NO.100 OF TECHNOLOGY ROAD 6, NATIONAL HI-TECH ZONE, ZHUHAI, China
Date of Test:	Oct. 13, 2020 – Oct. 27, 2020
Applicable Standards:	FCC CFR Title 47 Part 15 Subpart C Section 15.247 FCC KDB 558074 D01 15.247 Meas Guidance v05r02 ANSI C63.10:2013

The above equipment has been tested by Shenzhen Tongce Testing Lab. and found compliance with the requirements set forth in the technical standards mentioned above. The results of testing in this report apply only to the product/system, which was tested. Other similar equipment will not necessarily produce the same results due to production tolerance and measurement uncertainties.

Tested By:

Brave Zeng

Date:

Oct. 27, 2020

Brave Zeng

Reviewed By:

Beryl Zhao

Date:

Oct. 28, 2020

Beryl Zhao

Approved By:

Tomsin

Date:

Oct. 28, 2020

Tomsin

2. Test Result Summary

Requirement	CFR 47 Section	Result
Antenna requirement	§15.203/§15.247 (c)	PASS
AC Power Line Conducted Emission	§15.207	PASS
Conducted Peak Output Power	§15.247 (b)(3)	PASS
6dB Emission Bandwidth	§15.247 (a)(2)	PASS
Power Spectral Density	§15.247 (e)	PASS
Band Edge	§15.247(d)	PASS
Spurious Emission	§15.205/§15.209	PASS

Note:

1. PASS: Test item meets the requirement.
2. Fail: Test item does not meet the requirement.
3. N/A: Test case does not apply to the test object.
4. The test result judgment is decided by the limit of test standard.

3. EUT Description

Product:	Wireless Camera
Model No.:	RS-CH728H4C-WA28PW
Additional Model No.:	zzyy-CHxxxzyz-zzz-zzyyyyzz-zzz; (x= 0-9; y=0-9 or blank; z= A-Z or blank;)
Trade Mark:	N/A
Operation Frequency:	2412MHz~2462MHz (802.11b/802.11g/802.11n(HT20)) 2422MHz~2452MHz (802.11n(HT40))
Channel Separation:	5MHz
Number of Channel:	11 for 802.11b/802.11g/802.11n(HT20) 7 for 802.11n(HT40)
Modulation Technology: (IEEE 802.11b)	Direct Sequence Spread Spectrum (DSSS)
Modulation Technology: (IEEE 802.11g/802.11n)	Orthogonal Frequency Division Multiplexing(OFDM)
Data speed (IEEE 802.11b):	1Mbps, 2Mbps, 5.5Mbps, 11Mbps
Data speed (IEEE 802.11g):	6Mbps, 9Mbps, 12Mbps, 18Mbps, 24Mbps, 36Mbps, 48Mbps, 54Mbps
Data speed (IEEE 802.11n):	Up to 150Mbps
Antenna Type:	FPC Antenna
Antenna Gain:	2dBi
Power Supply:	DC 12V
Remark:	All models above are identical in interior structure, electrical circuits and components, just model names, lens size and shell color are different for the marketing requirement.

Note: The antenna gain listed in this report is provided by applicant, and the test laboratory is not responsible for this parameter.

Operation Frequency each of channel For 802.11b/g/n(HT20)

Channel	Frequency	Channel	Frequency	Channel	Frequency	Channel	Frequency
1	2412MHz	4	2427MHz	7	2442MHz	10	2457MHz
2	2417MHz	5	2432MHz	8	2447MHz	11	2462MHz
3	2422MHz	6	2437MHz	9	2452MHz	--	--

Operation Frequency each of channel For 802.11n (HT40)

Channel	Frequency	Channel	Frequency	Channel	Frequency	Channel	Frequency
--	--	4	2427MHz	7	2442MHz	--	--
--	--	5	2432MHz	8	2447MHz	--	--
3	2422MHz	6	2437MHz	9	2452MHz		

Note:

In section 15.31(m), regards to the operating frequency range over 10 MHz, the Lowest frequency, the middle frequency, and the highest frequency of channel were selected to perform the test, and the selected channel see below:

802.11b/802.11g/802.11n (HT20)

Channel	Frequency
The lowest channel	2412MHz
The middle channel	2437MHz
The Highest channel	2462MHz

802.11n (HT40)

Channel	Frequency
The lowest channel	2422MHz
The middle channel	2437MHz
The Highest channel	2452MHz

4. General Information

4.1. Test environment and mode

Operating Environment:		
Condition	Conducted Emission	Radiated Emission
Temperature:	25.0 °C	25.0 °C
Humidity:	55 % RH	55 % RH
Atmospheric Pressure:	1010 mbar	1010 mbar
Test Mode:		
Engineering mode:	Keep the EUT in continuous transmitting by select channel and modulations with Fully-charged battery	
<p>The sample was placed 0.8m & 1.5m for the measurement below & above 1GHz above the ground plane of 3m chamber. Measurements in both horizontal and vertical polarities were performed. During the test, each emission was maximized by: having the EUT continuously working, investigated all operating modes, rotated about all 3 axis (X, Y & Z) and considered typical configuration to obtain worst position, manipulating interconnecting cables, rotating the turntable, varying antenna height from 1m to 4m in both horizontal and vertical polarizations. The emissions worst-case(Z axis) are shown in Test Results of the following pages.</p>		

We have verified the construction and function in typical operation. All the test modes were carried out with the EUT in transmitting operation, which was shown in this test report and defined as follows:

Per-scan all kind of data rate in lowest channel, and found the follow list which it was worst case.

Mode	Data rate
802.11b	1Mbps
802.11g	6Mbps
802.11n(H20)	6.5Mbps
802.11n(H40)	13.5Mbps

Final Test Mode:

Operation mode:	Keep the EUT in continuous transmitting with modulation
-----------------	---

1. For WIFI function, the engineering test program was provided and enabled to make EUT continuous transmit/receive.

2. According to ANSI C63.10 standards, the test results are both the "worst case" and "worst setup" 1Mbps for 802.11b, 6Mbps for 802.11g, 6.5Mbps for 802.11n(H20), 13.5Mbps for 802.11n(H40). Duty cycle setting during the transmission is 100% with maximum power setting for all modulations.

4.2. Description of Support Units

The EUT has been tested as an independent unit together with other necessary accessories or support units. The following support units or accessories were used to form a representative test configuration during the tests.

Equipment	Model No.	Serial No.	FCC ID	Trade Name
Adapter	JD-050200	20120109075767 35	/	/

Note:

1. All the equipment/cables were placed in the worst-case configuration to maximize the emission during the test.
2. Grounding was established in accordance with the manufacturer's requirements and conditions for the intended use.
3. For conducted measurements (Output Power, 6dB Emission Bandwidth, Power Spectral Density, Spurious Emissions), the antenna of EUT is connected to the test equipment via temporary antenna connector, the antenna connector is soldered on the antenna port of EUT, and the temporary antenna connector is listed in the Test Instruments.

5. Facilities and Accreditations

5.1. Facilities

The test facility is recognized, certified, or accredited by the following organizations:

- FCC - Registration No.: 645098

Shenzhen Tongce Testing Lab.

The 3m Semi-anechoic chamber has been registered and fully described in a report with the (FCC) Federal Communications Commission. The acceptance letter from the FCC is maintained in our files.

- IC - Registration No.: 10668A-1

The 3m Semi-anechoic chamber of Shenzhen TCT Testing Technology Co., Ltd. has been registered by Certification and Engineering Bureau of Industry Canada for radio equipment testing

5.2. Location

Shenzhen Tongce Testing Lab.

Address: 1B/F., Building 1, Yibaolai Industrial Park, Qiaotou, Fuyong, Baoan District, Shenzhen, Guangdong, China

TEL: +86-755-27673339

5.3. Measurement Uncertainty

The reported uncertainty of measurement $y \pm U$, where expanded uncertainty U is based on a standard uncertainty multiplied by a coverage factor of $k=2$, providing a level of confidence of approximately 95 %.

No.	Item	MU
1	Conducted Emission	$\pm 2.56\text{dB}$
2	RF power, conducted	$\pm 0.12\text{dB}$
3	Spurious emissions, conducted	$\pm 0.11\text{dB}$
4	All emissions, radiated(<1G)	$\pm 3.92\text{dB}$
5	All emissions, radiated(>1G)	$\pm 4.28\text{dB}$
6	Temperature	$\pm 0.1^\circ\text{C}$
7	Humidity	$\pm 1.0\%$

6. Test Results and Measurement Data

6.1. Antenna requirement

Standard requirement:

FCC Part15 C Section 15.203 /247(c)

15.203 requirement:

An intentional radiator shall be designed to ensure that no antenna other than that furnished by the responsible party shall be used with the device. The use of a permanently attached antenna or of an antenna that uses a unique coupling to the intentional radiator, the manufacturer may design the unit so that a broken antenna can be replaced by the user, but the use of a standard antenna jack or electrical connector is prohibited.

15.247(c) (1)(i) requirement:

(i) Systems operating in the 2400-2483.5 MHz band that is used exclusively for fixed. Point-to-point operations may employ transmitting antennas with directional gain greater than 6dBi provided the maximum conducted output power of the intentional radiator is reduced by 1 dB for every 3 dB that the directional gain of the antenna exceeds 6dBi.

E.U.T Antenna:

The WIFI antenna is FPC antenna which permanently attached, and the best case gain of the antenna is 2dBi.

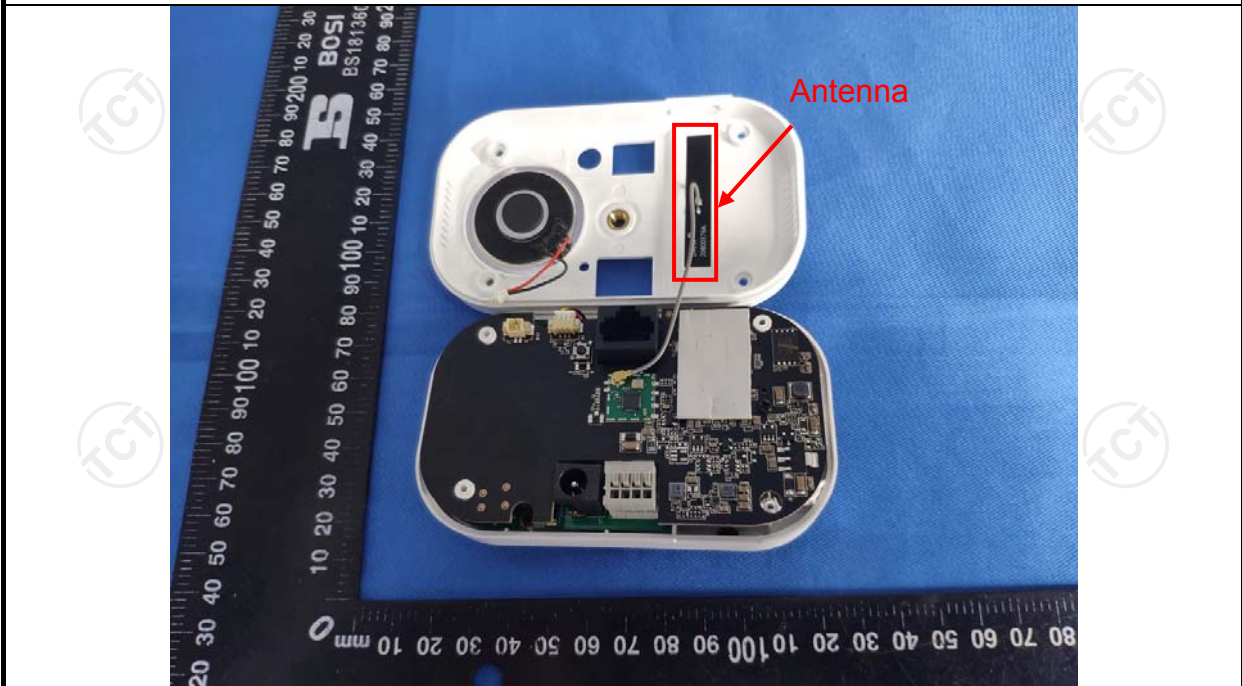

6.2. Conducted Emission

6.2.1. Test Specification

Test Requirement:	FCC Part15 C Section 15.207														
Test Method:	ANSI C63.10:2013														
Frequency Range:	150 kHz to 30 MHz														
Receiver setup:	RBW=9 kHz, VBW=30 kHz, Sweep time=auto														
Limits:	<table border="1"> <thead> <tr> <th rowspan="2">Frequency range (MHz)</th> <th colspan="2">Limit (dBuV)</th> </tr> <tr> <th>Quasi-peak</th> <th>Average</th> </tr> </thead> <tbody> <tr> <td>0.15-0.5</td> <td>66 to 56*</td> <td>56 to 46*</td> </tr> <tr> <td>0.5-5</td> <td>56</td> <td>46</td> </tr> <tr> <td>5-30</td> <td>60</td> <td>50</td> </tr> </tbody> </table>	Frequency range (MHz)	Limit (dBuV)		Quasi-peak	Average	0.15-0.5	66 to 56*	56 to 46*	0.5-5	56	46	5-30	60	50
Frequency range (MHz)	Limit (dBuV)														
	Quasi-peak	Average													
0.15-0.5	66 to 56*	56 to 46*													
0.5-5	56	46													
5-30	60	50													
Test Setup:	<p><i>Remark</i> E.U.T: Equipment Under Test LISN: Line Impedance Stabilization Network Test table height=0.8m</p>														
Test Mode:	Charging + transmitting with modulation														
Test Procedure:	<ol style="list-style-type: none"> 1. The E.U.T is connected to the main power through a line impedance stabilization network (L.I.S.N.). This provides a 50ohm/50uH coupling impedance for the measuring equipment. 2. The peripheral devices are also connected to the main power through a LISN that provides a 50ohm/50uH coupling impedance with 50ohm termination. (Please refer to the block diagram of the test setup and photographs). 3. Both sides of A.C. line are checked for maximum conducted interference. In order to find the maximum emission, the relative positions of equipment and all of the interface cables must be changed according to ANSI C63.10: 2013 on conducted measurement. 														
Test Result:	PASS														

6.2.2. Test Instruments

Conducted Emission Shielding Room Test Site (843)				
Equipment	Manufacturer	Model	Serial Number	Calibration Due
Test Receiver	R&S	ESCI3	100898	Jul. 27, 2021
LISN-2	Schwarzbeck	NSLK 8126	8126453	Sep. 11, 2021
Line-5	TCT	CE-05	N/A	Sep. 02, 2021
EMI Test Software	Shurple Technology	EZ-EMC	N/A	N/A

Note: The calibration interval of the above test instruments is 12 months and the calibrations are traceable to international system unit (SI).

6.2.3. Test data

Please refer to following diagram for individual
Conducted Emission on Line Terminal of the power line (150 kHz to 30MHz)

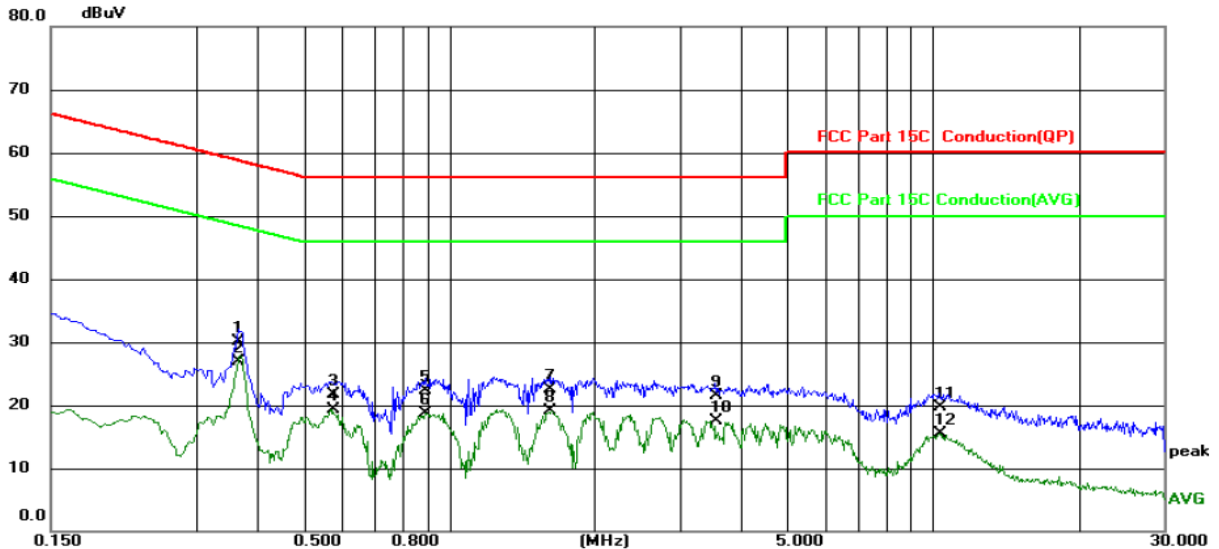

Site: Phase: **L1** Temperature: 25 (C)
Limit: FCC Part 15C Conduction(QP) Power: Humidity: 55 %RH

No.	Mk.	Freq. MHz	Reading Level dBuV	Correct Factor dB	Measure- ment dBuV	Limit dBuV	Over dB	Detector	Comment
1		0.3660	19.93	10.13	30.06	58.59	-28.53	QP	
2	*	0.3660	16.76	10.13	26.89	48.59	-21.70	AVG	
3		0.5740	11.66	10.13	21.79	56.00	-34.21	QP	
4		0.5740	9.14	10.13	19.27	46.00	-26.73	AVG	
5		0.8900	12.09	10.12	22.21	56.00	-33.79	QP	
6		0.8900	8.67	10.12	18.79	46.00	-27.21	AVG	
7		1.6180	12.36	10.12	22.48	56.00	-33.52	QP	
8		1.6180	8.89	10.12	19.01	46.00	-26.99	AVG	
9		3.5620	11.39	10.13	21.52	56.00	-34.48	QP	
10		3.5620	7.42	10.13	17.55	46.00	-28.45	AVG	
11		10.3260	9.65	10.15	19.80	60.00	-40.20	QP	
12		10.3260	5.33	10.15	15.48	50.00	-34.52	AVG	

Note:

- Freq. = Emission frequency in MHz
- Reading level (dBuV) = Receiver reading
- Corr. Factor (dB) = LISN factor + Cable loss
- Measurement (dBuV) = Reading level (dBuV) + Corr. Factor (dB)
- Limit (dBuV) = Limit stated in standard
- Margin (dB) = Measurement (dBuV) – Limits (dBuV)
- Q.P. =Quasi-Peak
- AVG =average
- * is meaning the worst frequency has been tested in the frequency range 150 kHz to 30MHz.

Conducted Emission on Neutral Terminal of the power line (150 kHz to 30MHz)

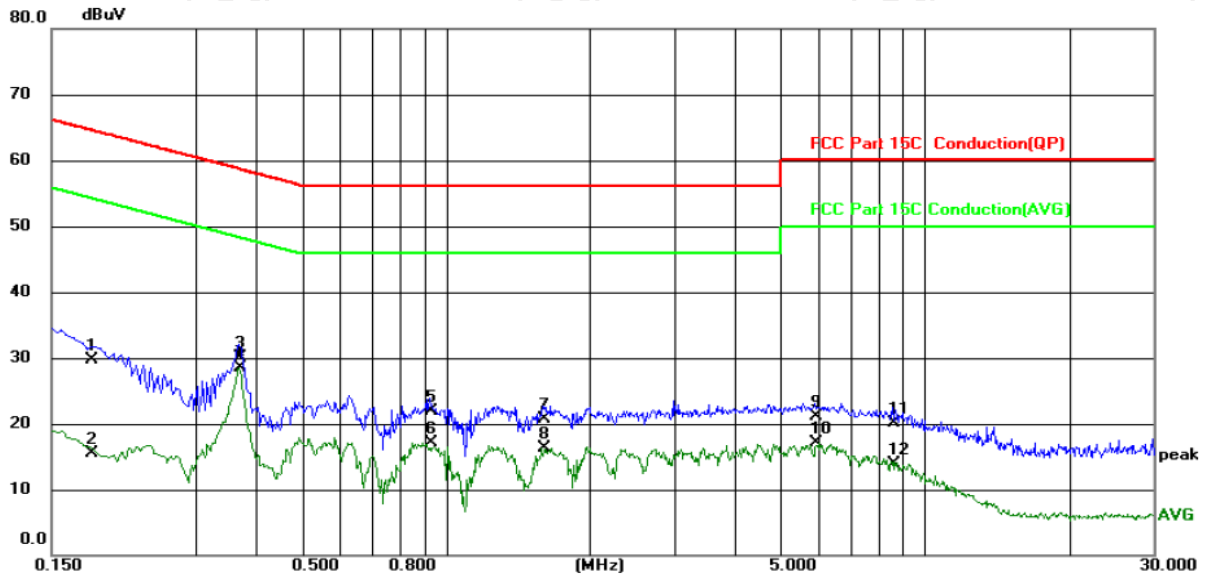

Site: Phase: **N** Temperature: 25 (C)
 Limit: FCC Part 15C Conduction(QP) Power: Humidity: 55 %RH

No.	Mk.	Freq. MHz	Reading Level dBuV	Correct Factor dB	Measure- ment dBuV	Limit dBuV	Over dB	Detector	Comment
1		0.1819	19.53	10.22	29.75	64.40	-34.65	QP	
2		0.1819	5.34	10.22	15.56	54.40	-38.84	AVG	
3		0.3700	19.79	10.22	30.01	58.50	-28.49	QP	
4	*	0.3700	18.20	10.22	28.42	48.50	-20.08	AVG	
5		0.9260	11.56	10.33	21.89	56.00	-34.11	QP	
6		0.9260	6.83	10.33	17.16	46.00	-28.84	AVG	
7		1.5980	10.21	10.41	20.62	56.00	-35.38	QP	
8		1.5980	5.85	10.41	16.26	46.00	-29.74	AVG	
9		5.9180	10.69	10.49	21.18	60.00	-38.82	QP	
10		5.9180	6.54	10.49	17.03	50.00	-32.97	AVG	
11		8.5659	9.65	10.54	20.19	60.00	-39.81	QP	
12		8.5659	3.27	10.54	13.81	50.00	-36.19	AVG	

Note:

- Freq. = Emission frequency in MHz
- Reading level (dBuV) = Receiver reading
- Corr. Factor (dB) = LISN factor + Cable loss
- Measurement (dBuV) = Reading level (dBuV) + Corr. Factor (dB)
- Limit (dBuV) = Limit stated in standard
- Margin (dB) = Measurement (dBuV) – Limits (dBuV)
- Q.P. =Quasi-Peak
- AVG =average
- * is meaning the worst frequency has been tested in the frequency range 150 kHz to 30MHz.

6.3. Maximum Conducted (Average) Output Power

6.3.1. Test Specification

Test Requirement:	FCC Part15 C Section 15.247 (b)(3)
Test Method:	KDB 558074 D01 v05r02
Limit:	30dBm
Test Setup:	 Spectrum Analyzer EUT
Test Mode:	Transmitting mode with modulation
Test Procedure:	<ol style="list-style-type: none">1. The RF output of EUT was connected to the spectrum analyzer by RF cable and attenuator. The path loss was compensated to the results for each measurement.2. Set to the maximum power setting and enable the EUT transmit continuously.3. Measure the conducted output power and record the results in the test report.
Test Result:	PASS

6.3.2. Test Instruments

RF Test Room				
Equipment	Manufacturer	Model	Serial Number	Calibration Due
Spectrum Analyzer	Agilent	N9020A	MY49100619	Sep. 11, 2021
RF Cable (9KHz-26.5GHz)	TCT	RE-06	N/A	Sep. 11, 2021
Antenna Connector	TCT	RFC-01	N/A	Sep. 11, 2021

Note: The calibration interval of the above test instruments is 12 months and the calibrations are traceable to international system unit (SI).

6.4. Emission Bandwidth

6.4.1. Test Specification

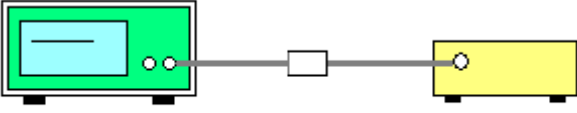
Test Requirement:	FCC Part15 C Section 15.247 (a)(2)
Test Method:	KDB 558074 D01 v05r02
Limit:	>500kHz
Test Setup:	 <p style="text-align: center;">Spectrum Analyzer EUT</p>
Test Mode:	Transmitting mode with modulation
Test Procedure:	<ol style="list-style-type: none"> 1. Set to the maximum power setting and enable the EUT transmit continuously. 2. Make the measurement with the spectrum analyzer's resolution bandwidth (RBW) = 100 kHz. Set the Video bandwidth (VBW) = 300 kHz. In order to make an accurate measurement. The 6dB bandwidth must be greater than 500 kHz. 3. Measure and record the results in the test report.
Test Result:	PASS

6.4.2. Test Instruments

RF Test Room				
Equipment	Manufacturer	Model	Serial Number	Calibration Due
Spectrum Analyzer	Agilent	N9020A	MY49100619	Sep. 11, 2021
RF Cable (9KHz-26.5GHz)	TCT	RE-06	N/A	Sep. 11, 2021
Antenna Connector	TCT	RFC-01	N/A	Sep. 11, 2021

Note: The calibration interval of the above test instruments is 12 months and the calibrations are traceable to international system unit (SI).

6.5. Power Spectral Density

6.5.1. Test Specification

Test Requirement:	FCC Part15 C Section 15.247 (e)
Test Method:	KDB 558074
Limit:	The average power spectral density shall not be greater than 8dBm in any 3kHz band at any time interval of continuous transmission.
Test Setup:	 <p style="text-align: center;">Spectrum Analyzer EUT</p>
Test Mode:	Transmitting mode with modulation
Test Procedure:	<ol style="list-style-type: none"> 1. The RF output of EUT was connected to the spectrum analyzer by RF cable and attenuator. The path loss was compensated to the results for each measurement. 2. Set to the maximum power setting and enable the EUT transmit continuously. 3. Make the measurement with the spectrum analyzer's resolution bandwidth (RBW): $3\text{ kHz} \leq \text{RBW} \leq 100\text{ kHz}$. Video bandwidth $\text{VBW} \geq 3 \times \text{RBW}$. Set the span to at least 1.5 times the OBW. 4. Detector = RMS, Sweep time = auto couple. 5. Employ trace averaging (RMS) mode over a minimum of 100 traces. Use the peak marker function to determine the maximum power level. 6. Measure and record the results in the test report.
Test Result:	PASS

6.5.2. Test Instruments

RF Test Room				
Equipment	Manufacturer	Model	Serial Number	Calibration Due
Spectrum Analyzer	Agilent	N9020A	MY49100619	Sep. 11, 2021
RF Cable (9KHz-26.5GHz)	TCT	RE-06	N/A	Sep. 11, 2021
Antenna Connector	TCT	RFC-01	N/A	Sep. 11, 2021

Note: The calibration interval of the above test instruments is 12 months and the calibrations are traceable to international system unit (SI).

6.6. Conducted Band Edge and Spurious Emission Measurement

6.6.1. Test Specification

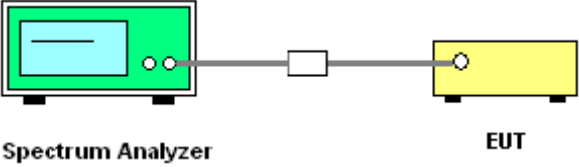
Test Requirement:	FCC Part15 C Section 15.247 (d)
Test Method:	KDB558074
Limit:	In any 100 kHz bandwidth outside of the authorized frequency band, the emissions which fall in the non-restricted bands shall be attenuated at least 20 dB / 30dB relative to the maximum PSD level in 100 kHz by RF conducted measurement and radiated emissions which fall in the restricted bands, as defined in Section 15.205(a), must also comply with the radiated emission limits specified in Section 15.209(a).
Test Setup:	 The diagram illustrates the test setup. On the left is a Spectrum Analyzer (green box with a screen and knobs). A cable connects its RF output to a small white rectangular attenuator. From the attenuator, another cable connects to the RF input of the EUT (Equipment Under Test, yellow box). Labels 'Spectrum Analyzer' and 'EUT' are placed below their respective components.
Test Mode:	Transmitting mode with modulation
Test Procedure:	<ol style="list-style-type: none"> 1. The RF output of EUT was connected to the spectrum analyzer by RF cable and attenuator. The path loss was compensated to the results for each measurement. 2. Set to the maximum power setting and enable the EUT transmit continuously. 3. Set RBW = 100 kHz, VBW=300 kHz, Peak Detector. Unwanted Emissions measured in any 100 kHz bandwidth outside of the authorized frequency band shall be attenuated by at least 20 dB relative to the maximum in-band peak PSD level in 100 kHz when maximum peak conducted output power procedure is used. If the transmitter complies with the conducted power limits based on the use of RMS averaging over a time interval, the attenuation required under this paragraph shall be 30 dB instead of 20 dB per 15.247(d). 4. Measure and record the results in the test report. 5. The RF fundamental frequency should be excluded against the limit line in the operating frequency band.
Test Result:	PASS

6.6.2. Test Instruments

RF Test Room				
Equipment	Manufacturer	Model	Serial Number	Calibration Due
Spectrum Analyzer	Agilent	N9020A	MY49100619	Sep. 11, 2021
RF Cable (9KHz-26.5GHz)	TCT	RE-06	N/A	Sep. 11, 2021
Antenna Connector	TCT	RFC-01	N/A	Sep. 11, 2021

Note: The calibration interval of the above test instruments is 12 months and the calibrations are traceable to international system unit (SI).

6.7. Radiated Spurious Emission Measurement

6.7.1. Test Specification

Test Requirement:	FCC Part15 C Section 15.209					
Test Method:	ANSI C63.10: 2013					
Frequency Range:	9 kHz to 25 GHz					
Measurement Distance:	3 m					
Antenna Polarization:	Horizontal & Vertical					
Operation mode:	Transmitting mode with modulation					
Receiver Setup:	Frequency	Detector	RBW	VBW	Remark	
	9kHz- 150kHz	Quasi-peak	200Hz	1kHz	Quasi-peak Value	
	150kHz- 30MHz	Quasi-peak	9kHz	30kHz	Quasi-peak Value	
	30MHz-1GHz	Quasi-peak	120KHz	300KHz	Quasi-peak Value	
	Above 1GHz	Peak	1MHz	3MHz	Peak Value	
		Peak	1MHz	10Hz	Average Value	
Limit:	Frequency	Field Strength (microvolts/meter)	Measurement Distance (meters)			
	0.009-0.490	2400/F(KHz)	300			
	0.490-1.705	24000/F(KHz)	30			
	1.705-30	30	30			
	30-88	100	3			
	88-216	150	3			
	216-960	200	3			
	Above 960	500	3			
	Frequency	Field Strength (microvolts/meter)	Measurement Distance (meters)	Detector		
	Above 1GHz	500	3	Average		
	5000	3	Peak			
Test setup:	For radiated emissions below 30MHz					
	<p>Distance = 3m</p> <p>0.8m</p> <p>Turn table</p> <p>1m</p> <p>Ground Plane</p> <p>Computer</p> <p>Pre-Amplifier</p> <p>Receiver</p>					
	30MHz to 1GHz					

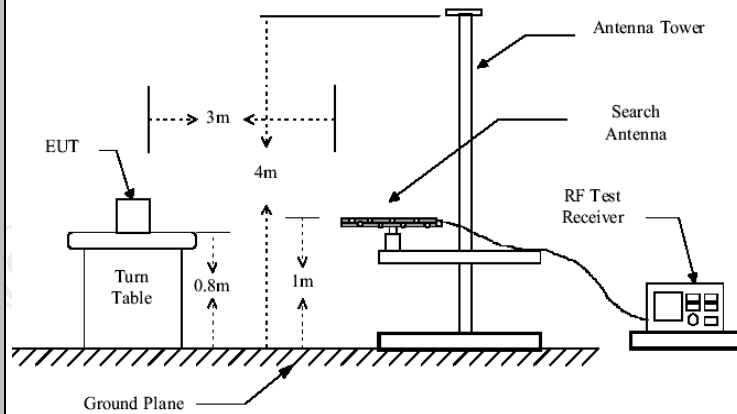

Above 1GHz

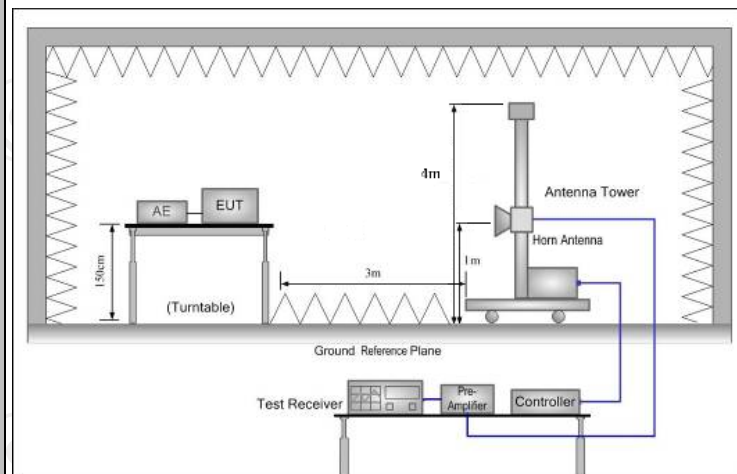

Test Procedure:

- For the radiated emission test below 1GHz:
The EUT was placed on a turntable with 0.8 meter above ground. The EUT was set 3 meters from the interference receiving antenna, which was mounted on the top of a variable height antenna tower. The EUT was arranged to its worst case and then tune the antenna tower (from 1 m to 4 m) and turntable (from 0 degree to 360 degrees) to find the maximum reading. A pre-amp and a high PASS filter are used for the test in order to get better signal level.
- For the radiated emission test above 1GHz:
Place the measurement antenna on a turntable with 1.5 meter above ground, which is away from each area of the EUT determined to be a source of emissions at the specified measurement distance, while keeping the measurement antenna aimed at the source of emissions at each frequency of significant emissions, with polarization oriented for maximum response. The measurement antenna may have to be higher or lower than the EUT, depending on the radiation pattern of the emission and staying aimed at the emission source for receiving the maximum signal. The final measurement antenna elevation shall be that which

	<p>maximizes the emissions. The measurement antenna elevation for maximum emissions shall be restricted to a range of heights of from 1 m to 4 m above the ground or reference ground plane.</p> <p>3. Corrected Reading: Antenna Factor + Cable Loss + Read Level - Preamp Factor = Level</p> <p>4. For measurement below 1GHz, If the emission level of the EUT measured by the peak detector is 3 dB lower than the applicable limit, the peak emission level will be reported. Otherwise, the emission measurement will be repeated using the quasi-peak detector and reported.</p> <p>5. Use the following spectrum analyzer settings:</p> <p>(1) Span shall wide enough to fully capture the emission being measured;</p> <p>(2) Set RBW=120 kHz for $f < 1$ GHz; VBW \geq RBW; Sweep = auto; Detector function = peak; Trace = max hold;</p> <p>(3) Set RBW = 1 MHz, VBW= 3MHz for $f > 1$ GHz for peak measurement.</p> <p>For average measurement: VBW = 10 Hz, when duty cycle is no less than 98 percent. VBW $\geq 1/T$, when duty cycle is less than 98 percent where T is the minimum transmission duration over which the transmitter is on and is transmitting at its maximum power control level for the tested mode of operation.</p>
Test results:	PASS

6.7.2. Test Instruments

Radiated Emission Test Site (966)				
Name of Equipment	Manufacturer	Model	Serial Number	Calibration Due
Test Receiver	ROHDE&SCHW ARZ	ESIB7	100197	Jul. 27, 2021
Spectrum Analyzer	ROHDE&SCHW ARZ	FSQ40	200061	Sep. 11, 2021
Pre-amplifier	EM Electronics Corporation CO.,LTD	EM30265	07032613	Sep. 02, 2021
Pre-amplifier	HP	8447D	2727A05017	Sep. 02, 2021
Loop antenna	ZHINAN	ZN30900A	12024	Oct. 27, 2020
Broadband Antenna	Schwarzbeck	VULB9163	340	Sep. 04, 2022
Horn Antenna	Schwarzbeck	BBHA 9120D	631	Sep. 04, 2022
Horn Antenna	A-INFO	LB-180400-KF	J211020657	Sep. 04, 2022
Antenna Mast	Keleto	RE-AM	N/A	N/A
Line-4	RE-high-04	TCT	N/A	Sep. 02, 2021
Line-8	RE-01	TCT	N/A	Jul. 27, 2021
EMI Test Software	Shurple Technology	EZ-EMC	N/A	N/A

Note: The calibration interval of the above test instruments is 12 months and the calibrations are traceable to international system unit (SI).

6.7.3. Test Data

Please refer to following diagram for individual
Below 1GHz

Horizontal:

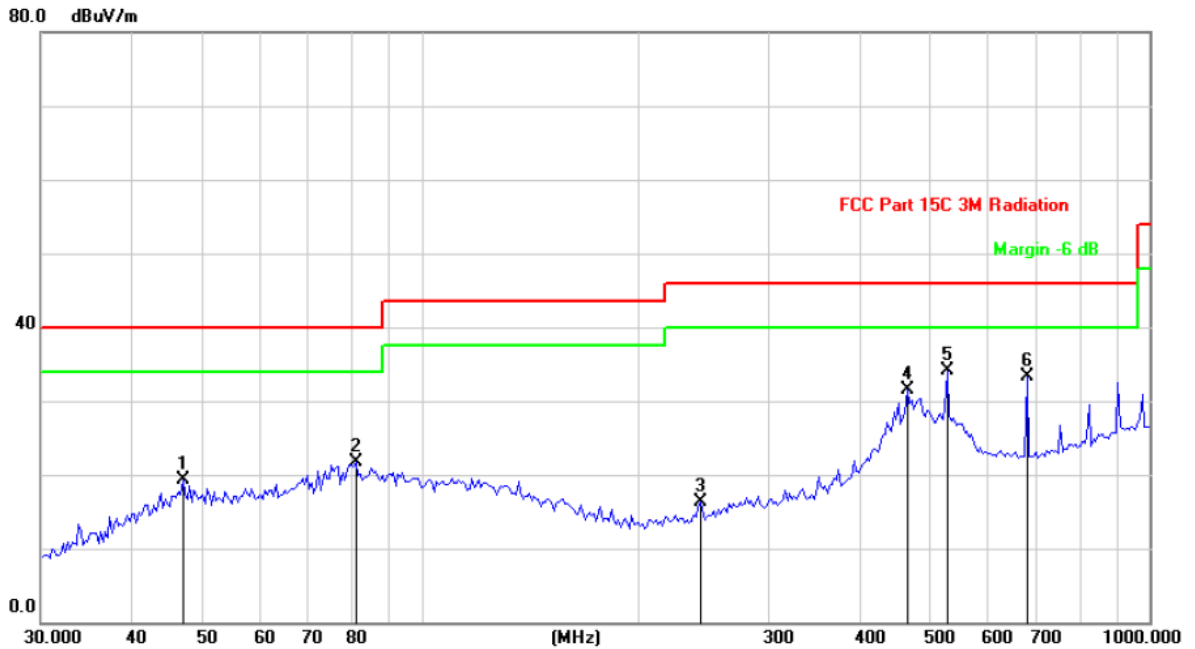

Site: Polarization: *Horizontal* Temperature: 25
Limit: FCC Part 15C 3M Radiation Power: Humidity: 55 %

No.	Mk.	Freq. MHz	Reading Level dBuV	Correct Factor dB	Measure- ment dBuV/m	Limit dB/m	Over dB	Detector
1		47.0371	29.67	-10.32	19.35	40.00	-20.65	peak
2		81.3740	37.46	-15.84	21.62	40.00	-18.38	peak
3		241.8377	29.05	-12.80	16.25	46.00	-29.75	peak
4		464.8867	39.48	-8.05	31.43	46.00	-14.57	peak
5	*	527.5707	41.34	-7.18	34.16	46.00	-11.84	peak
6		679.4346	38.74	-5.51	33.23	46.00	-12.77	peak

Vertical:

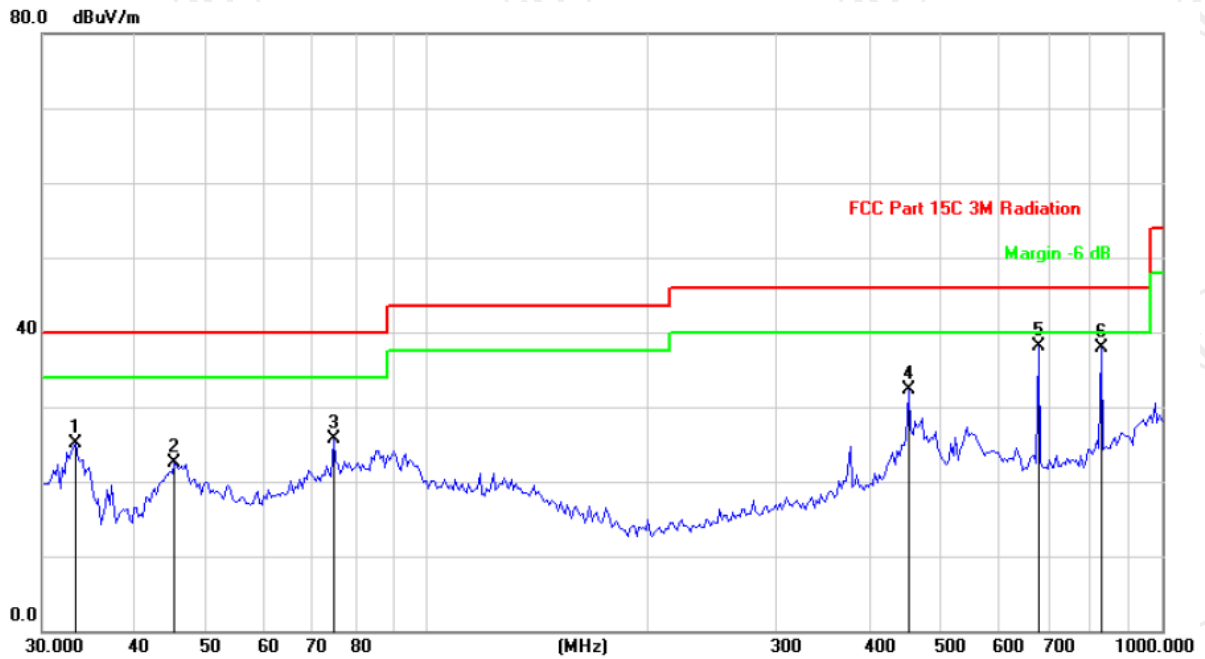

Site: Polarization: **Vertical** Temperature: 25
 Limit: FCC Part 15C 3M Radiation Power: Humidity: 55 %

No.	Mk.	Freq. MHz	Reading Level dBuV	Correct Factor dB	Measure- ment dBuV/m	Limit dB/m	Over dB	Detector
1		33.3349	36.15	-11.02	25.13	40.00	-14.87	peak
2		45.4130	32.98	-10.49	22.49	40.00	-17.51	peak
3		74.7934	41.84	-16.16	25.68	40.00	-14.32	peak
4		452.0013	40.52	-8.28	32.24	46.00	-13.76	peak
5	*	679.4346	43.52	-5.51	38.01	46.00	-7.99	peak
6		827.1793	42.05	-4.21	37.84	46.00	-8.16	peak

Note: 1. The low frequency, which started from 9KHz~30MHz, was pre-scanned and the result which was 20dB lower than the limit line per 15.31(o) was not reported

2. Measurements were conducted in all three channels (high, middle, low) and all modulation(802.11b, 802.11g, 802.11n(HT20), 802.11n(HT40)), and the worst case Mode (Middle channel and 802.11b) was submitted only.

3. Freq. = Emission frequency in MHz

Measurement (dBuV/m) = Reading level (dBuV) + Corr. Factor (dB)

Correction Factor= Antenna Factor + Cable loss – Pre-amplifier

Limit (dBuV/m) = Limit stated in standard

Margin (dB) = Measurement (dBuV/m) – Limits (dBuV/m)

Any value more than 10dB below limit have not been specifically reported

* is meaning the worst frequency has been tested in the test frequency range

Test Result of Radiated Spurious at Band edges

Lowest channel 2412:

Horizontal:

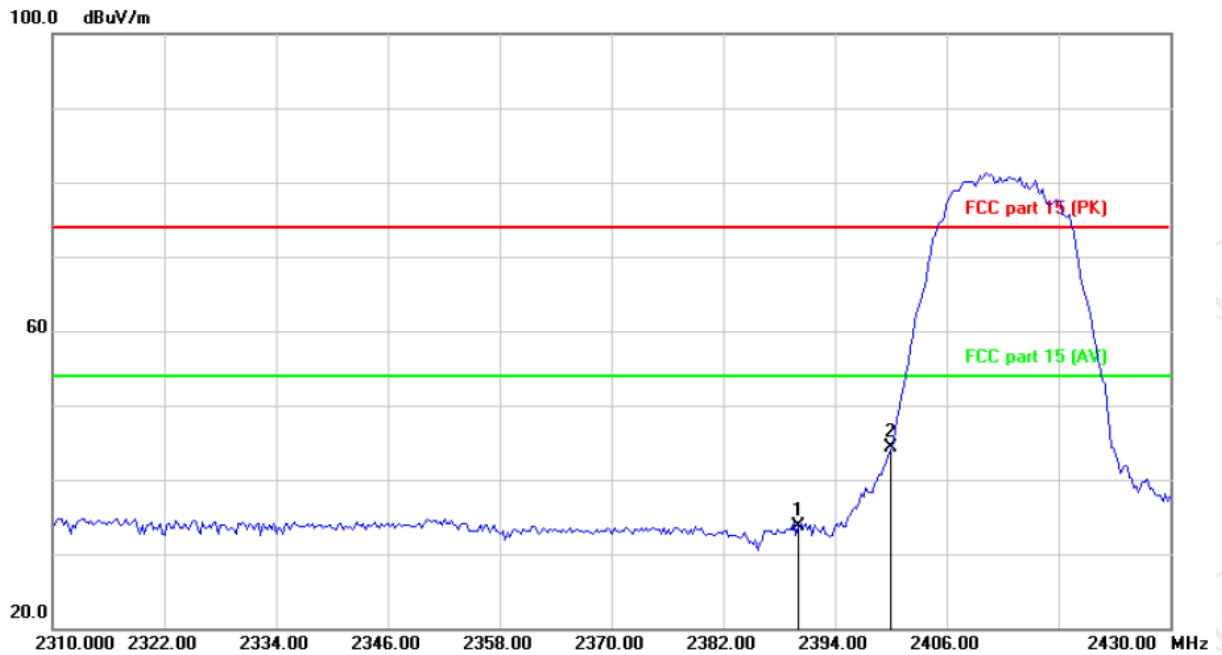

Site: Polarization: *Horizontal* Temperature: 25
Limit: FCC part 15 (PK) Power: Humidity: 55 %

No.	Mk.	Freq. MHz	Reading Level dBuV	Correct Factor dB	Measure- ment dBuV/m	Limit dB/m	Over dB	Detector
1		2390.000	46.89	-13.15	33.74	74.00	-40.26	peak
2	*	2400.000	57.41	-13.12	44.29	74.00	-29.71	peak

Vertical:

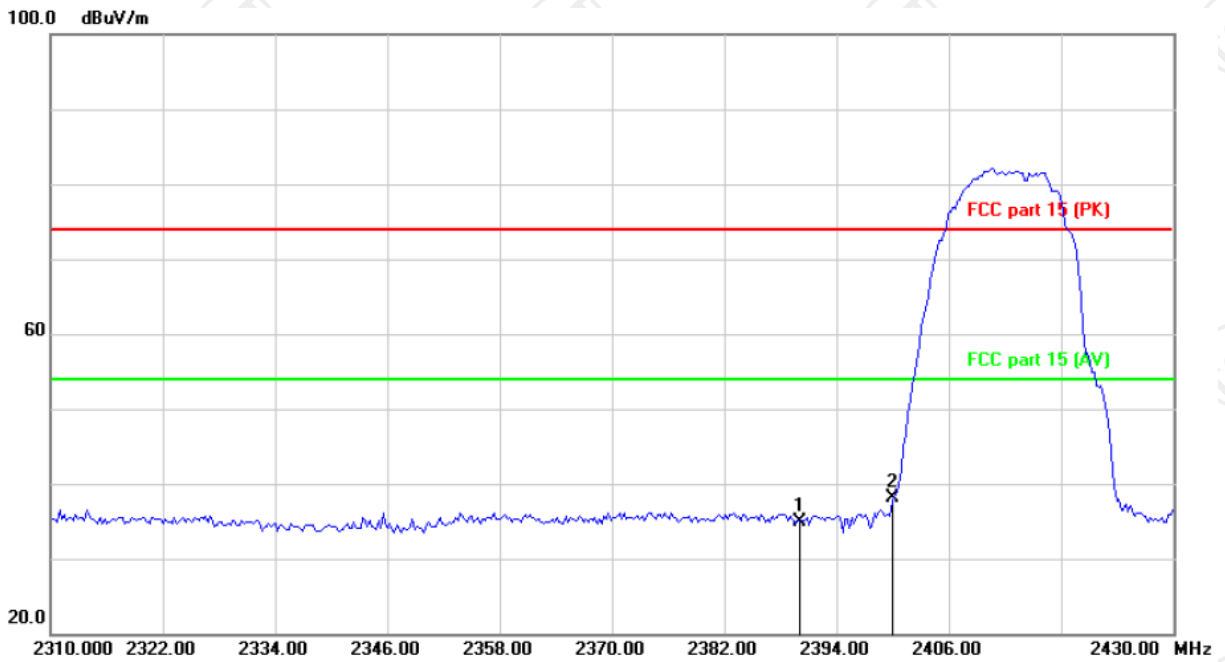

Site: Polarization: *Vertical* Temperature: 25
 Limit: FCC part 15 (PK) Power: Humidity: 55 %

No.	Mk.	Freq. MHz	Reading Level dBuV	Correct Factor dB	Measure- ment dBuV/m	Limit dB/m	Over dB	Detector
1		2390.000	47.96	-13.15	34.81	74.00	-39.19	peak
2	*	2400.000	51.19	-13.12	38.07	74.00	-35.93	peak

Highest channel 2462:

Horizontal:

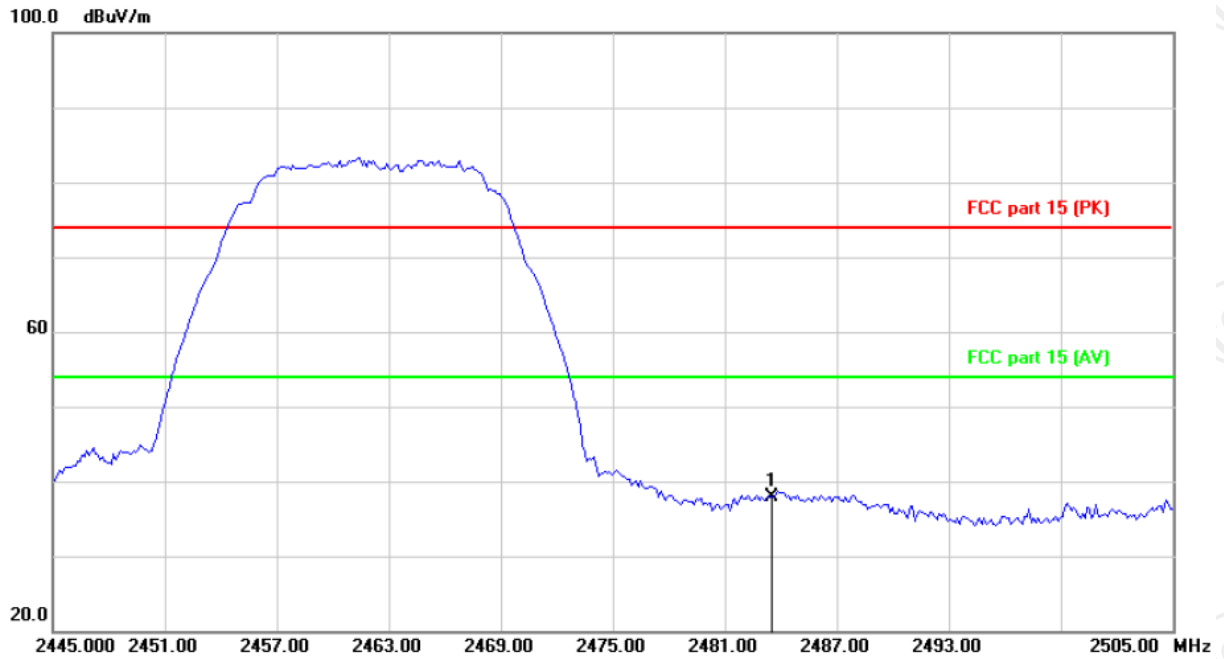

Site: _____ Polarization: **Horizontal** Temperature: 25
 Limit: FCC part 15 (PK) Power: _____ Humidity: 55 %

No.	Mk.	Freq.	Reading Level	Correct Factor	Measurement	Limit	Over	Detector
		MHz	dBuV	dB	dBuV/m	dB/m	dB	
1	*	2483.500	50.65	-12.74	37.91	74.00	-36.09	peak

Vertical:

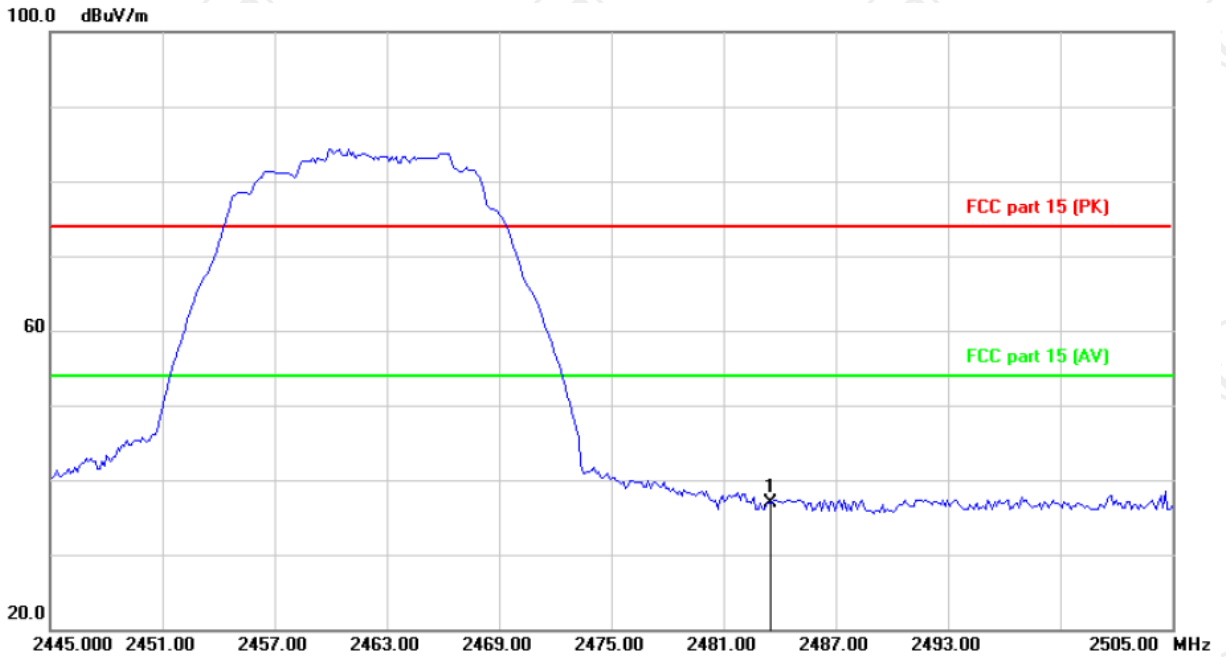

Site: Polarization: **Vertical** Temperature: 25
 Limit: FCC part 15 (PK) Power: Humidity: 55 %

No.	Mk.	Freq.	Reading Level	Correct Factor	Measurement	Limit	Over	Detector
		MHz	dBuV	dB	dBuV/m	dB/m	dB	
1	*	2483.500	49.68	-12.74	36.94	74.00	-37.06	peak

Note:

1. Peak Final Emission Level=Peak Reading + Correction Factor;
2. Correction Factor= Antenna Factor + Cable loss – Pre-amplifier
3. Measurements were conducted in all modulation(802.11b, 802.11g, 802.11n(HT20), 802.11n(HT40)), and the worst case Mode 802.11b was submitted only.

Above 1GHz

Modulation Type: 802.11b

Low channel: 2412 MHz

Frequency (MHz)	Ant. Pol. H/V	Peak reading (dBμV)	AV reading (dBμV)	Correction Factor (dB/m)	Emission Level		Peak limit (dBμV/m)	AV limit (dBμV/m)	Margin (dB)
					Peak (dBμV/m)	AV (dBμV/m)			
4824	H	47.42	---	0.75	48.17	---	74	54	-5.83
7236	H	39.29	---	9.87	49.16	---	74	54	-4.84
---	H	---	---	---	---	---	---	---	---
4824	V	46.13	---	0.75	46.88	---	74	54	-7.12
7236	V	39.21	---	9.87	49.08	---	74	54	-4.92
---	V	---	---	---	---	---	---	---	---

Middle channel: 2437MHz

Frequency (MHz)	Ant. Pol. H/V	Peak reading (dBμV)	AV reading (dBμV)	Correction Factor (dB/m)	Emission Level		Peak limit (dBμV/m)	AV limit (dBμV/m)	Margin (dB)
					Peak (dBμV/m)	AV (dBμV/m)			
4874	H	47.61	---	0.97	48.58	---	74	54	-5.42
7311	H	40.37	---	9.83	50.20	---	74	54	-3.80
---	H	---	---	---	---	---	---	---	---
4874	V	48.38	---	0.97	49.35	---	74	54	-4.65
7311	V	40.13	---	9.83	49.96	---	74	54	-4.04
---	V	---	---	---	---	---	---	---	---

High channel: 2462 MHz

Frequency (MHz)	Ant. Pol. H/V	Peak reading (dBμV)	AV reading (dBμV)	Correction Factor (dB/m)	Emission Level		Peak limit (dBμV/m)	AV limit (dBμV/m)	Margin (dB)
					Peak (dBμV/m)	AV (dBμV/m)			
4924	H	48.42	---	1.18	49.60	---	74	54	-4.40
7386	H	37.50	---	10.07	47.57	---	74	54	-6.43
---	H	---	---	---	---	---	---	---	---
4924	V	47.52	---	1.18	48.70	---	74	54	-5.30
7386	V	39.60	---	10.07	49.67	---	74	54	-4.33
---	V	---	---	---	---	---	---	---	---

Note:

1. Emission Level=Peak Reading + Correction Factor; Correction Factor= Antenna Factor + Cable loss – Pre-amplifier
2. Margin (dB) = Emission Level (Peak) (dBμV/m)-Average limit (dBμV/m)
3. The emission levels of other frequencies are very lower than the limit and not show in test report.
4. Measurements were conducted from 1 GHz to the 10th harmonic of highest fundamental frequency. The highest test frequency is 25GHz.
5. Data of measurement shown "—" in the above table mean that the reading of emissions is attenuated more than 20 dB below the limits or the field strength is too small to be measured.
6. All the restriction bands are compliance with the limit of 15.209.

Modulation Type: 802.11g

Low channel: 2412 MHz

Frequency (MHz)	Ant. Pol. H/V	Peak reading (dB μ V)	AV reading (dB μ V)	Correction Factor (dB/m)	Emission Level		Peak limit (dB μ V/m)	AV limit (dB μ V/m)	Margin (dB)
					Peak (dB μ V/m)	AV (dB μ V/m)			
4824	H	48.13	---	0.75	48.88	---	74	54	-5.12
7236	H	39.25	---	9.87	49.12	---	74	54	-4.88
---	H	---	---	---	---	---	---	---	---
4824	V	46.12	---	0.75	46.87	---	74	54	-7.13
7236	V	39.55	---	9.87	49.42	---	74	54	-4.58
---	V	---	---	---	---	---	---	---	---

Middle channel: 2437MHz

Frequency (MHz)	Ant. Pol. H/V	Peak reading (dB μ V)	AV reading (dB μ V)	Correction Factor (dB/m)	Emission Level		Peak limit (dB μ V/m)	AV limit (dB μ V/m)	Margin (dB)
					Peak (dB μ V/m)	AV (dB μ V/m)			
4874	H	46.61	---	0.97	47.58	---	74	54	-6.42
7311	H	39.92	---	9.83	49.75	---	74	54	-4.25
---	H	---	---	---	---	---	---	---	---
4874	V	46.74	---	0.97	47.71	---	74	54	-6.29
7311	V	39.54	---	9.83	49.37	---	74	54	-4.63
---	V	---	---	---	---	---	---	---	---

High channel: 2462 MHz

Frequency (MHz)	Ant. Pol. H/V	Peak reading (dB μ V)	AV reading (dB μ V)	Correction Factor (dB/m)	Emission Level		Peak limit (dB μ V/m)	AV limit (dB μ V/m)	Margin (dB)
					Peak (dB μ V/m)	AV (dB μ V/m)			
4924	H	46.97	---	1.18	48.15	---	74	54	-5.85
7386	H	38.47	---	10.07	48.54	---	74	54	-5.46
---	H	---	---	---	---	---	---	---	---
4924	V	46.79	---	1.18	47.97	---	74	54	-6.03
7386	V	38.88	---	10.07	48.95	---	74	54	-5.05
---	V	---	---	---	---	---	---	---	---

Note:

1. Emission Level=Peak Reading + Correction Factor; Correction Factor= Antenna Factor + Cable loss – Pre-amplifier
2. Margin (dB) = Emission Level (Peak) (dB μ V/m)-Average limit (dB μ V/m)
3. The emission levels of other frequencies are very lower than the limit and not show in test report.
4. Measurements were conducted from 1 GHz to the 10th harmonic of highest fundamental frequency. The highest test frequency is 25GHz.
5. Data of measurement shown “---“in the above table mean that the reading of emissions is attenuated more than 20 dB below the limits or the field strength is too small to be measured.
6. All the restriction bands are compliance with the limit of 15.209.

Modulation Type: 802.11n (HT20)

Low channel: 2412 MHz

Frequency (MHz)	Ant. Pol. H/V	Peak reading (dB μ V)	AV reading (dB μ V)	Correction Factor (dB/m)	Emission Level		Peak limit (dB μ V/m)	AV limit (dB μ V/m)	Margin (dB)
					Peak (dB μ V/m)	AV (dB μ V/m)			
4824	H	48.32	---	0.75	49.07	---	74	54	-4.93
7236	H	39.50	---	9.87	49.37	---	74	54	-4.63
---	H	---	---	---	---	---	---	---	---
4824	V	46.72	---	0.75	47.47	---	74	54	-6.53
7236	V	40.03	---	9.87	49.90	---	74	54	-4.10
---	V	---	---	---	---	---	---	---	---

Middle channel: 2437MHz

Frequency (MHz)	Ant. Pol. H/V	Peak reading (dB μ V)	AV reading (dB μ V)	Correction Factor (dB/m)	Emission Level		Peak limit (dB μ V/m)	AV limit (dB μ V/m)	Margin (dB)
					Peak (dB μ V/m)	AV (dB μ V/m)			
4874	H	47.22	---	0.97	48.19	---	74	54	-5.81
7311	H	39.73	---	9.83	49.56	---	74	54	-4.44
---	H	---	---	---	---	---	---	---	---
4874	V	46.54	---	0.97	47.51	---	74	54	-6.49
7311	V	39.78	---	9.83	49.61	---	74	54	-4.39
---	V	---	---	---	---	---	---	---	---

High channel: 2462 MHz

Frequency (MHz)	Ant. Pol. H/V	Peak reading (dB μ V)	AV reading (dB μ V)	Correction Factor (dB/m)	Emission Level		Peak limit (dB μ V/m)	AV limit (dB μ V/m)	Margin (dB)
					Peak (dB μ V/m)	AV (dB μ V/m)			
4924	H	47.61	---	1.18	48.79	---	74	54	-5.21
7386	H	40.36	---	10.07	50.43	---	74	54	-3.57
---	H	---	---	---	---	---	---	---	---
4924	V	46.44	---	1.18	47.62	---	74	54	-6.38
7386	V	39.52	---	10.07	49.59	---	74	54	-4.41
---	V	---	---	---	---	---	---	---	---

Note:

1. Emission Level=Peak Reading + Correction Factor; Correction Factor= Antenna Factor + Cable loss – Pre-amplifier
2. Margin (dB) = Emission Level (Peak) (dB μ V/m)-Average limit (dB μ V/m)
3. The emission levels of other frequencies are very lower than the limit and not show in test report.
4. Measurements were conducted from 1 GHz to the 10th harmonic of highest fundamental frequency. The highest test frequency is 25GHz.
5. Data of measurement shown “---“in the above table mean that the reading of emissions is attenuated more than 20 dB below the limits or the field strength is too small to be measured.
6. All the restriction bands are compliance with the limit of 15.209.

Modulation Type: 802.11n (HT40)

Low channel: 2422 MHz

Frequency (MHz)	Ant. Pol. H/V	Peak reading (dB μ V)	AV reading (dB μ V)	Correction Factor (dB/m)	Emission Level		Peak limit (dB μ V/m)	AV limit (dB μ V/m)	Margin (dB)
					Peak (dB μ V/m)	AV (dB μ V/m)			
4844	H	44.86	---	0.75	45.61	---	74	54	-8.39
7266	H	37.59	---	9.87	47.46	---	74	54	-6.54
---	H	---	---	---	---	---	---	---	---
4824	V	43.88	---	0.75	44.63	---	74	54	-9.37
7236	V	34.61	---	9.87	44.48	---	74	54	-9.52
---	V	---	---	---	---	---	---	---	---

Middle channel: 2437MHz

Frequency (MHz)	Ant. Pol. H/V	Peak reading (dB μ V)	AV reading (dB μ V)	Correction Factor (dB/m)	Emission Level		Peak limit (dB μ V/m)	AV limit (dB μ V/m)	Margin (dB)
					Peak (dB μ V/m)	AV (dB μ V/m)			
4874	H	41.75	---	0.97	42.72	---	74	54	-11.28
7311	H	33.92	---	9.83	43.75	---	74	54	-10.25
---	H	---	---	---	---	---	---	---	---
4874	V	42.67	---	0.97	43.64	---	74	54	-10.36
7311	V	36.84	---	9.83	46.67	---	74	54	-7.33
---	V	---	---	---	---	---	---	---	---

High channel: 2452 MHz

Frequency (MHz)	Ant. Pol. H/V	Peak reading (dB μ V)	AV reading (dB μ V)	Correction Factor (dB/m)	Emission Level		Peak limit (dB μ V/m)	AV limit (dB μ V/m)	Margin (dB)
					Peak (dB μ V/m)	AV (dB μ V/m)			
4904	H	44.60	---	1.18	45.78	---	74	54	-8.22
7356	H	35.91	---	10.07	45.98	---	74	54	-8.02
---	H	---	---	---	---	---	---	---	---
4904	V	42.23	---	1.18	43.41	---	74	54	-10.59
7356	V	35.37	---	10.07	45.44	---	74	54	-8.56
---	V	---	---	---	---	---	---	---	---

Note:

1. Emission Level=Peak Reading + Correction Factor; Correction Factor= Antenna Factor + Cable loss – Pre-amplifier
2. Margin (dB) = Emission Level (Peak) (dB μ V/m)-Average limit (dB μ V/m)
3. The emission levels of other frequencies are very lower than the limit and not show in test report.
4. Measurements were conducted from 1 GHz to the 10th harmonic of highest fundamental frequency. The highest test frequency is 25GHz.
5. Data of measurement shown “---“in the above table mean that the reading of emissions is attenuated more than 20 dB below the limits or the field strength is too small to be measured.
6. All the restriction bands are compliance with the limit of 15.209.

Appendix A: Test Result of Conducted Test

DTS Bandwidth

Test Result

Test Mode	Antenna	Channel	DTS BW[MHz]	FL[MHz]	FH[MHz]	Limit[MHz]	Verdict
11B	Ant1	2412	10.160	2406.920	2417.080	0.5	PASS
		2437	10.160	2431.920	2442.080	0.5	PASS
		2462	10.160	2456.920	2467.080	0.5	PASS
11G	Ant1	2412	16.520	2403.760	2420.280	0.5	PASS
		2437	16.600	2428.680	2445.280	0.5	PASS
		2462	16.640	2453.680	2470.320	0.5	PASS
11N20SISO	Ant1	2412	17.760	2403.120	2420.880	0.5	PASS
		2437	17.760	2428.120	2445.880	0.5	PASS
		2462	17.720	2453.120	2470.840	0.5	PASS
11N40SISO	Ant1	2422	36.560	2403.760	2440.320	0.5	PASS
		2437	36.480	2418.760	2455.240	0.5	PASS
		2452	36.560	2433.680	2470.240	0.5	PASS

Test Graphs

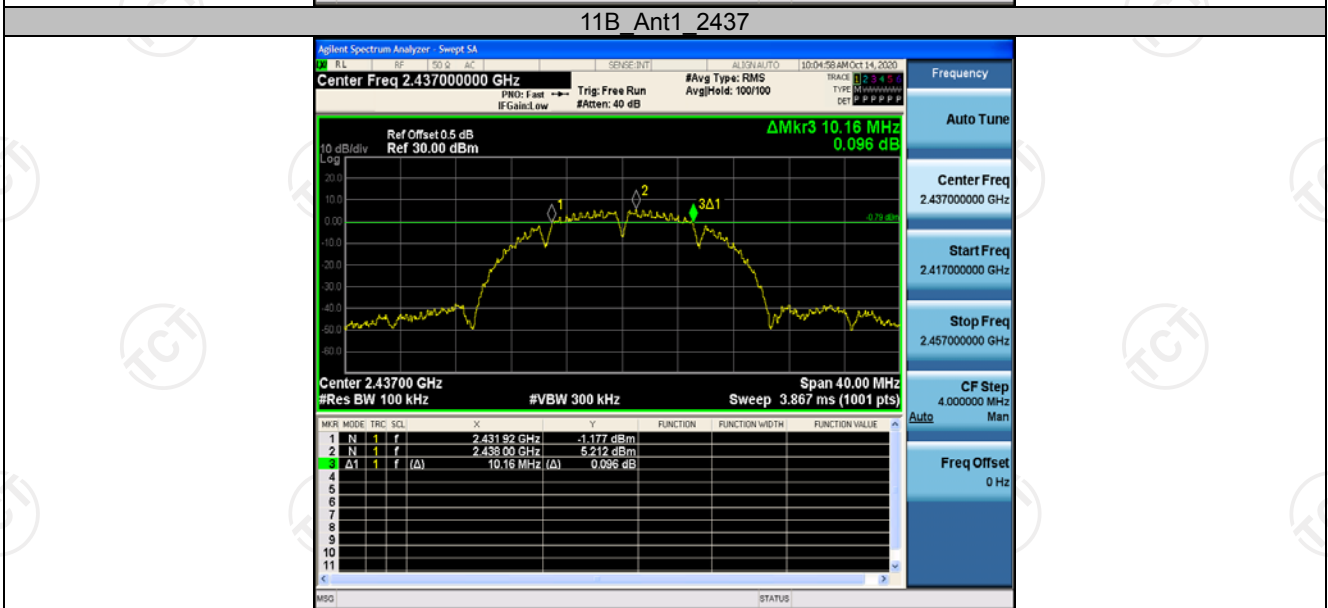
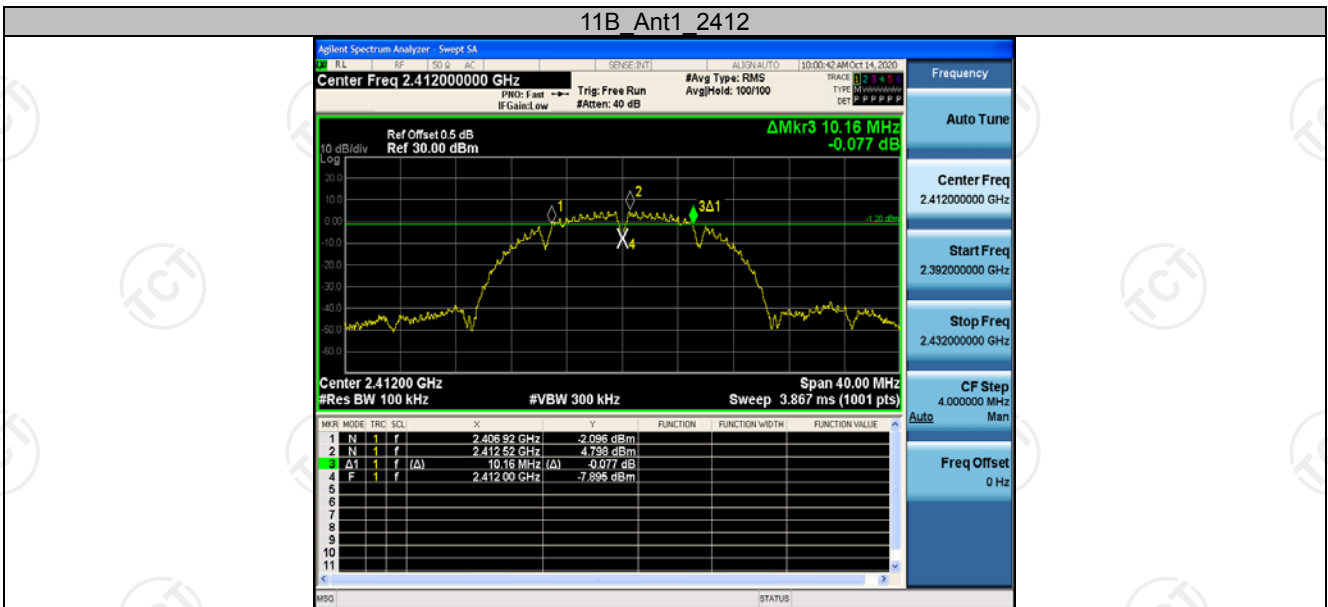

11B_Ant1_2462



11G_Ant1_2412

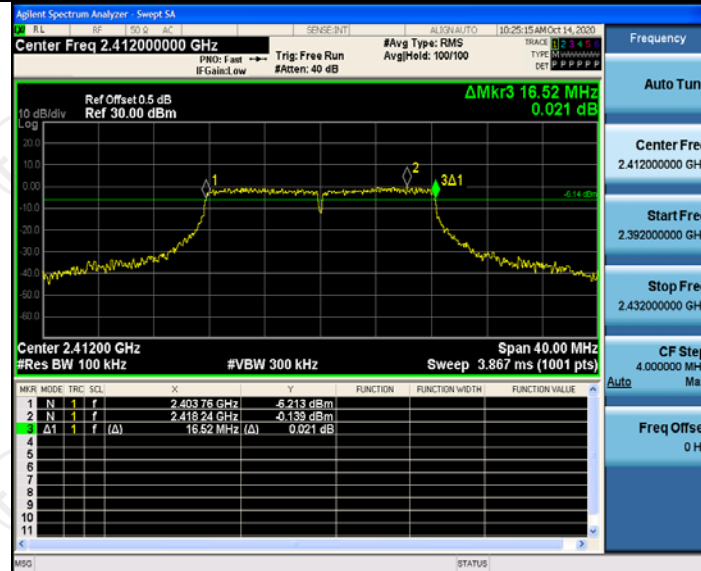

11G_Ant1_2437

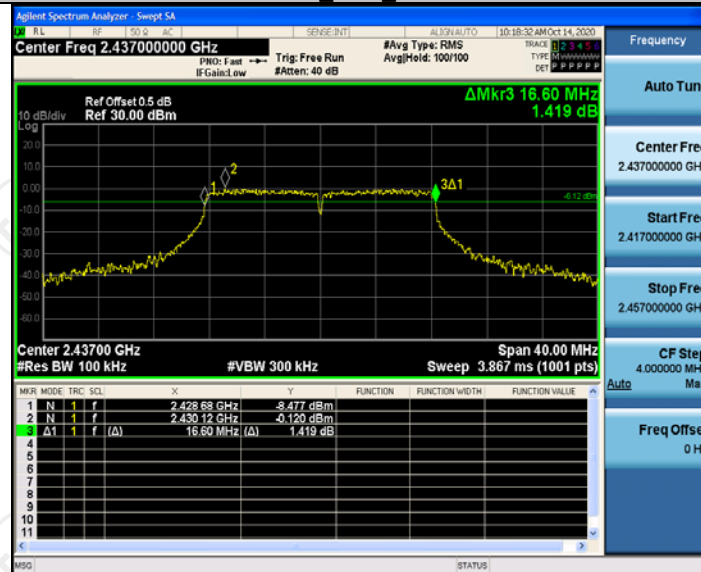

11G_Ant1_2462

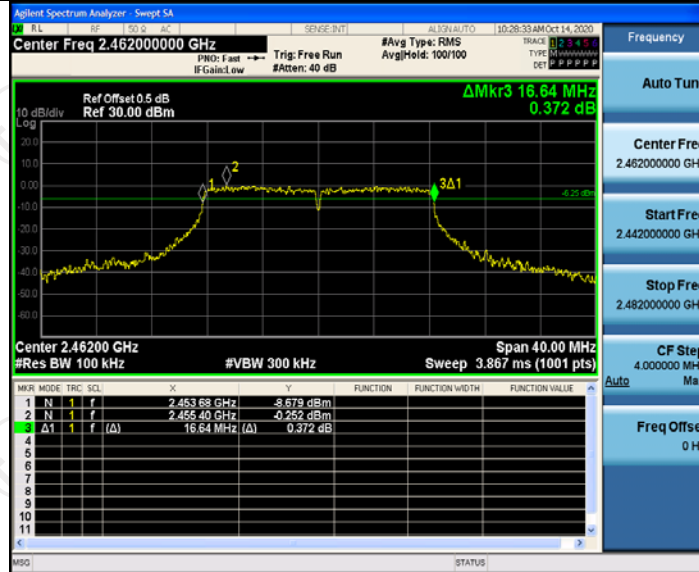

11N20SISO_Ant1_2412

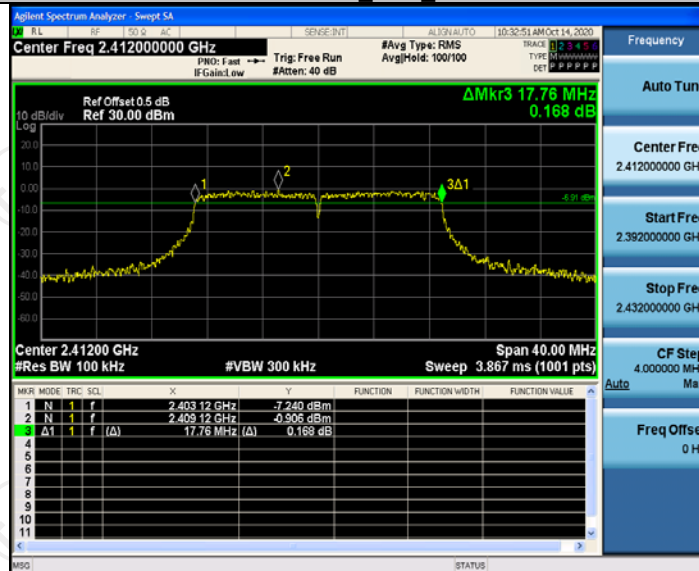

11N20SISO_Ant1_2437



11N20SISO_Ant1_2462

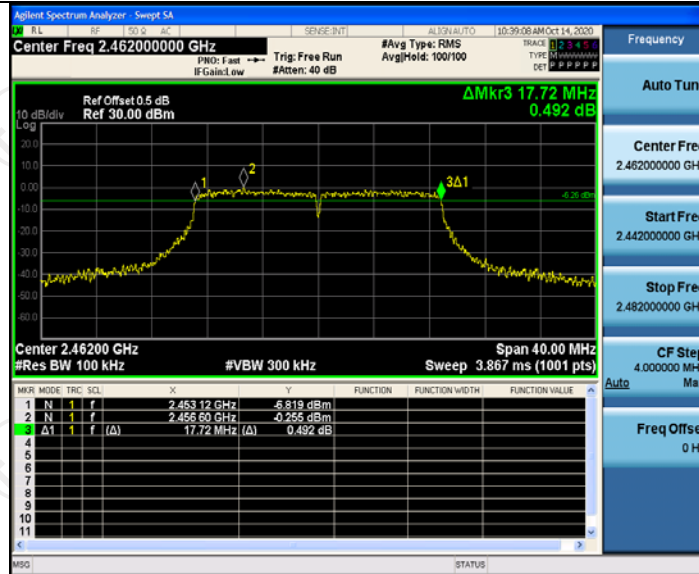

11N40SISO_Ant1_2422

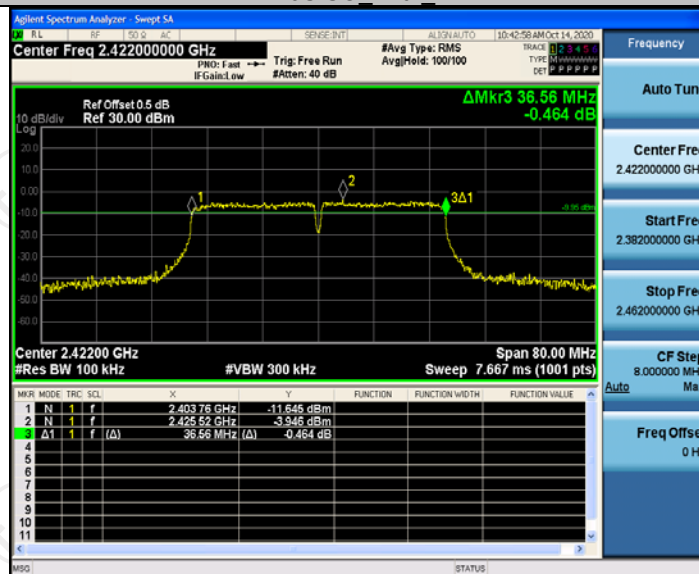

11N40SISO_Ant1_2437

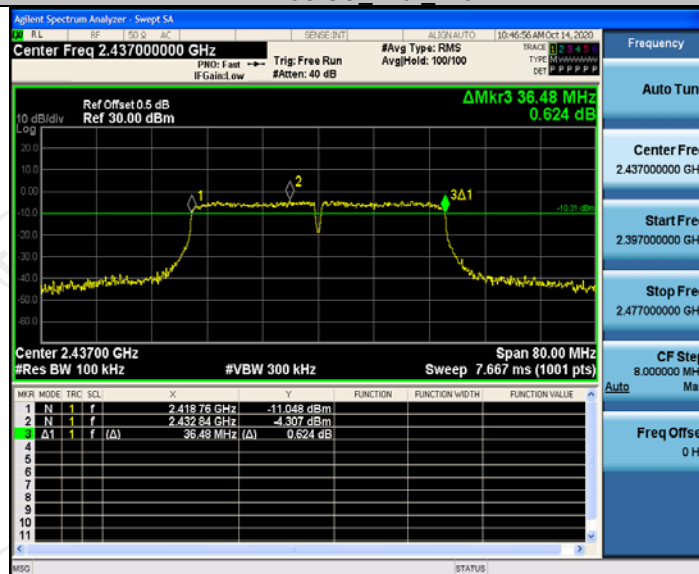

11N40SISO_Ant1_2452

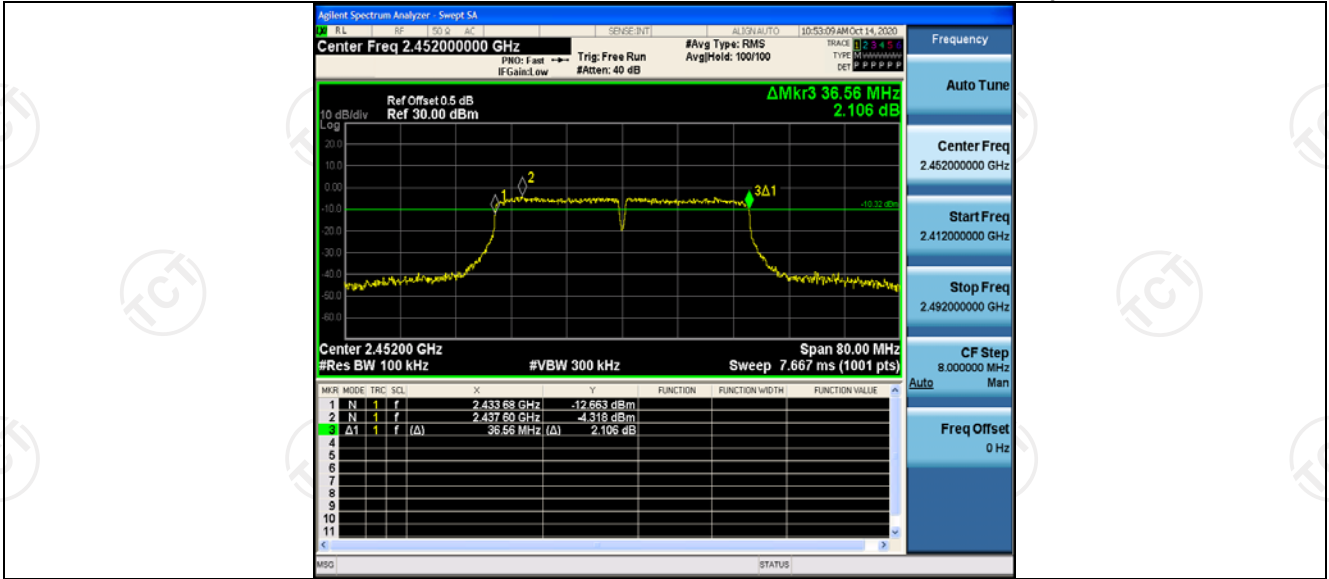

Occupied Channel Bandwidth

Test Result

Test Mode	Antenna	Channel	OCB[MHz]	FL[MHz]	FH[MHz]	Limit[MHz]	Verdict
11B	Ant1	2412	14.990	2404.523	2419.513	---	PASS
		2437	14.979	2429.497	2444.476	---	PASS
		2462	14.994	2454.449	2469.443	---	PASS
11G	Ant1	2412	16.932	2403.522	2420.454	---	PASS
		2437	16.909	2428.489	2445.398	---	PASS
		2462	16.973	2453.424	2470.397	---	PASS
11N20SISO	Ant1	2412	17.929	2403.036	2420.965	---	PASS
		2437	17.906	2428.038	2445.944	---	PASS
		2462	17.904	2453.009	2470.913	---	PASS
11N40SISO	Ant1	2422	36.364	2403.922	2440.286	---	PASS
		2437	36.281	2418.902	2455.183	---	PASS
		2452	36.380	2433.799	2470.179	---	PASS

Test Graphs



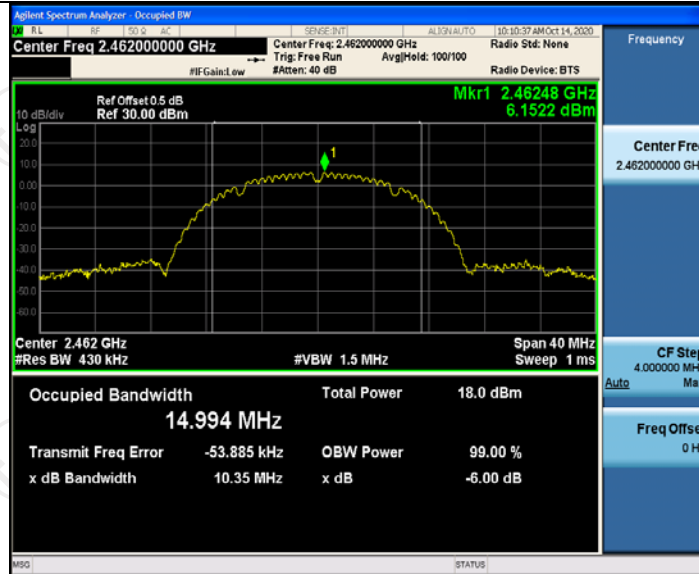

11G Ant1_2412

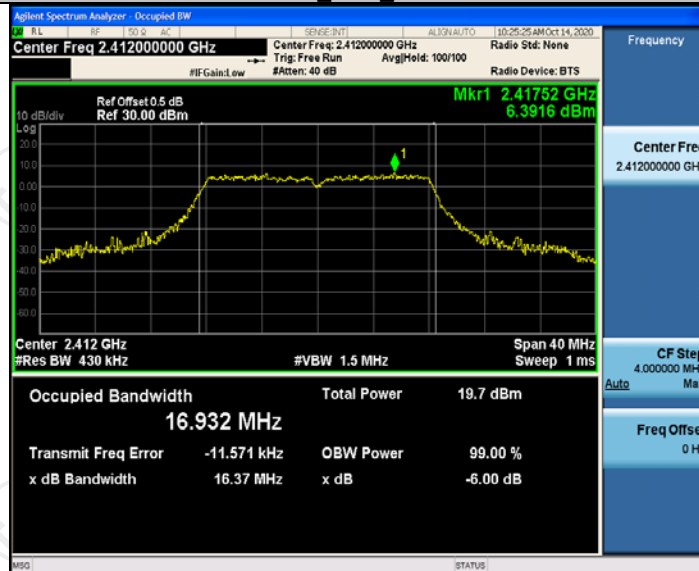

11G Ant1_2437

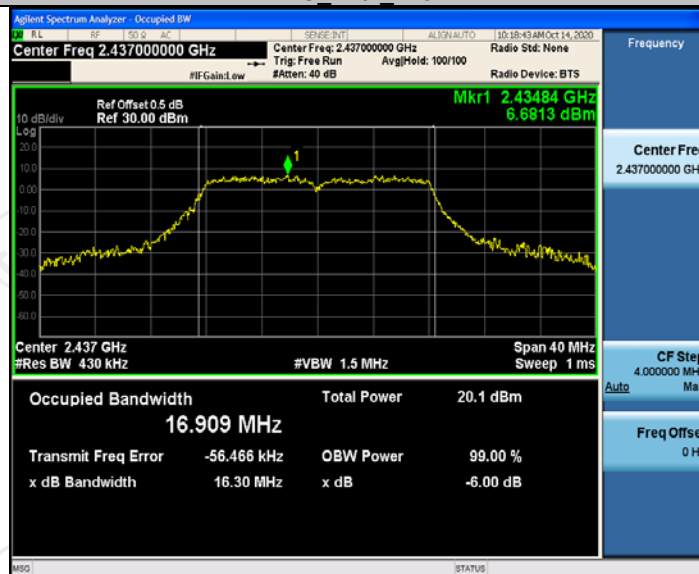

11G Ant1_2462

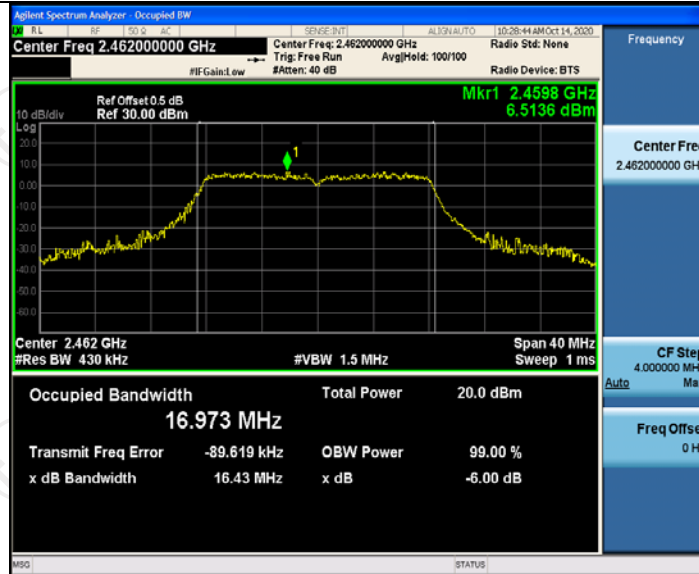

11N20SISO_Ant1_2412



11N20SISO_Ant1_2437

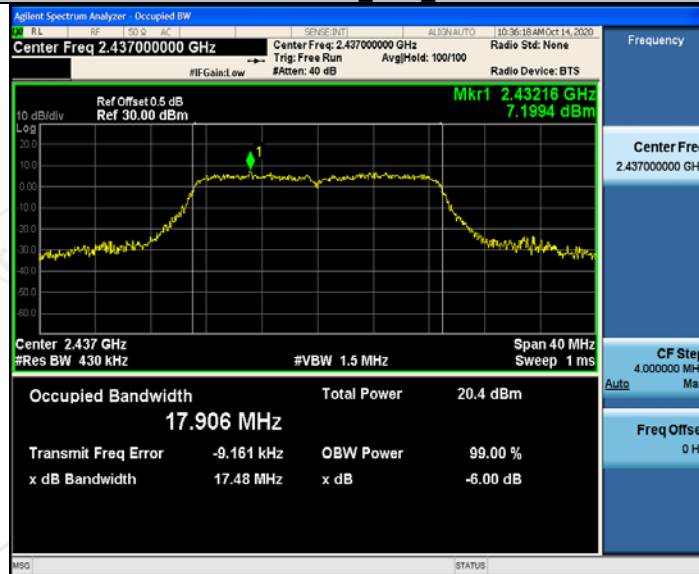

11N20SISO_Ant1_2462

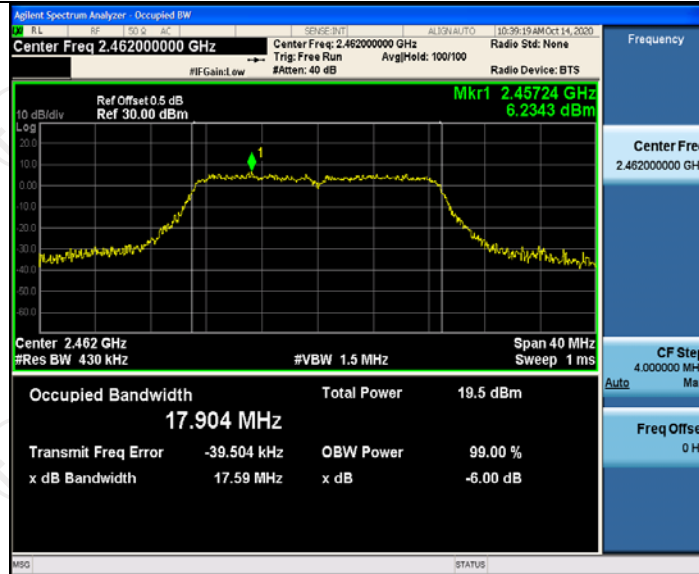

11N40SISO_Ant1_2422

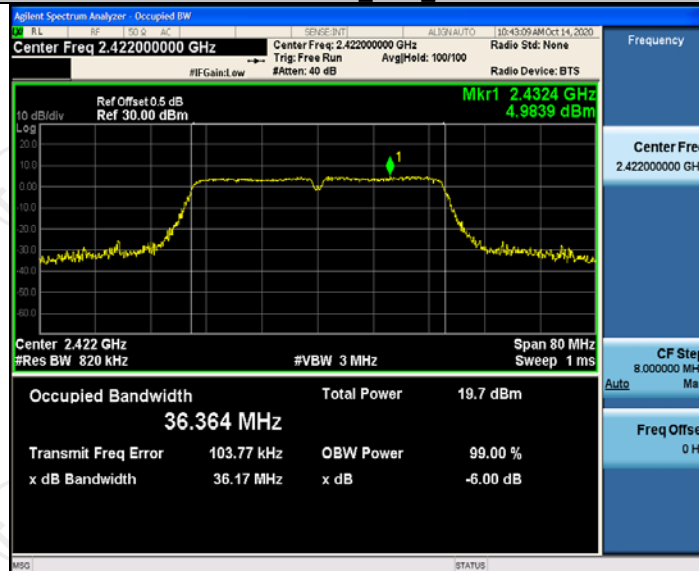

11N40SISO_Ant1_2437

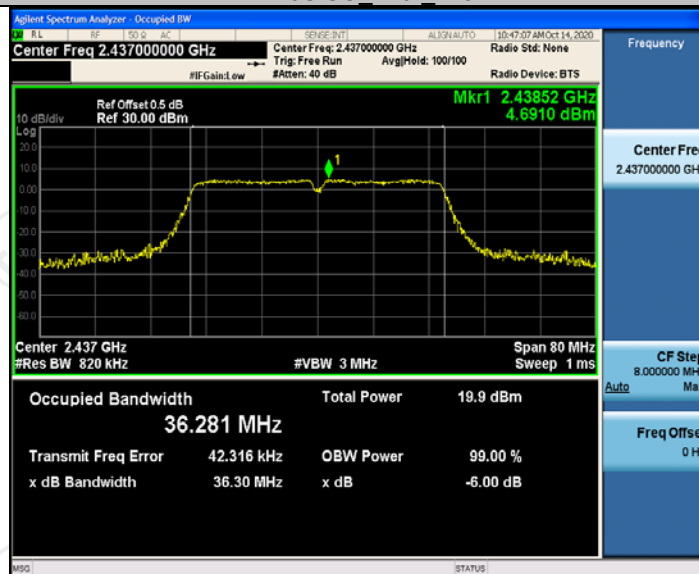

11N40SISO_Ant1_2452

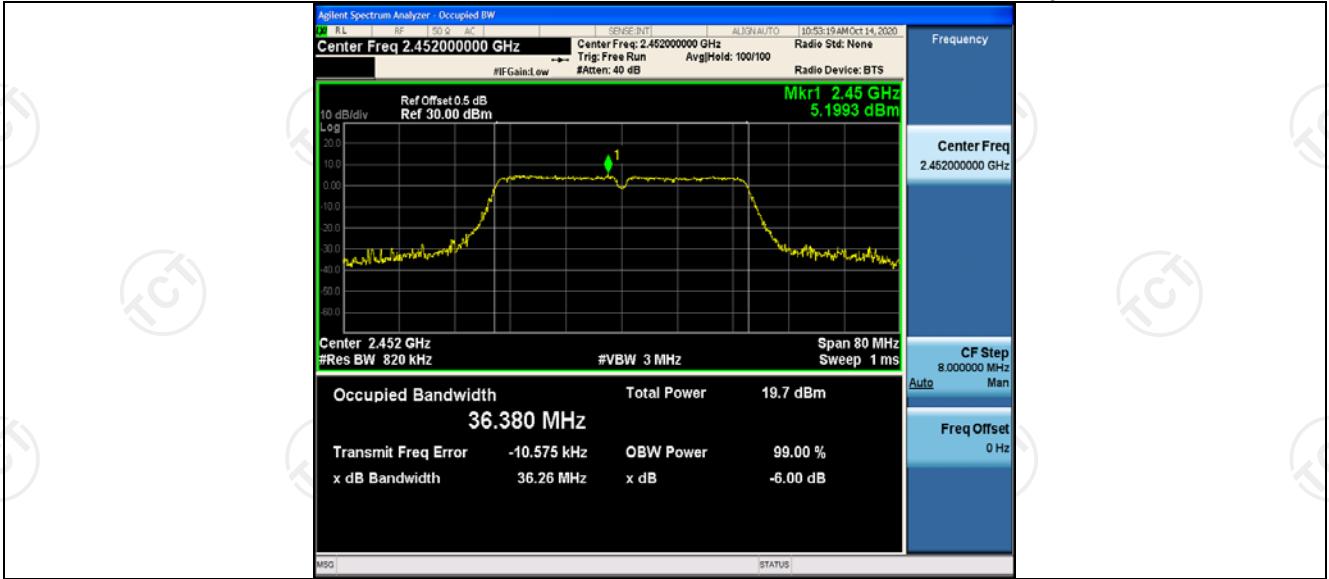

Maximum conducted output power

Test Result

Test Mode	Antenna	Channel	Result[dBm]	Limit[dBm]	Verdict
11B	Ant1	2412	14.91	<=30	PASS
		2437	15.49	<=30	PASS
		2462	15.00	<=30	PASS
11G	Ant1	2412	13.72	<=30	PASS
		2437	13.92	<=30	PASS
		2462	13.90	<=30	PASS
11N20SISO	Ant1	2412	13.22	<=30	PASS
		2437	14.21	<=30	PASS
		2462	13.34	<=30	PASS
11N40SISO	Ant1	2422	12.84	<=30	PASS
		2437	13.02	<=30	PASS
		2452	12.91	<=30	PASS

Test Graphs

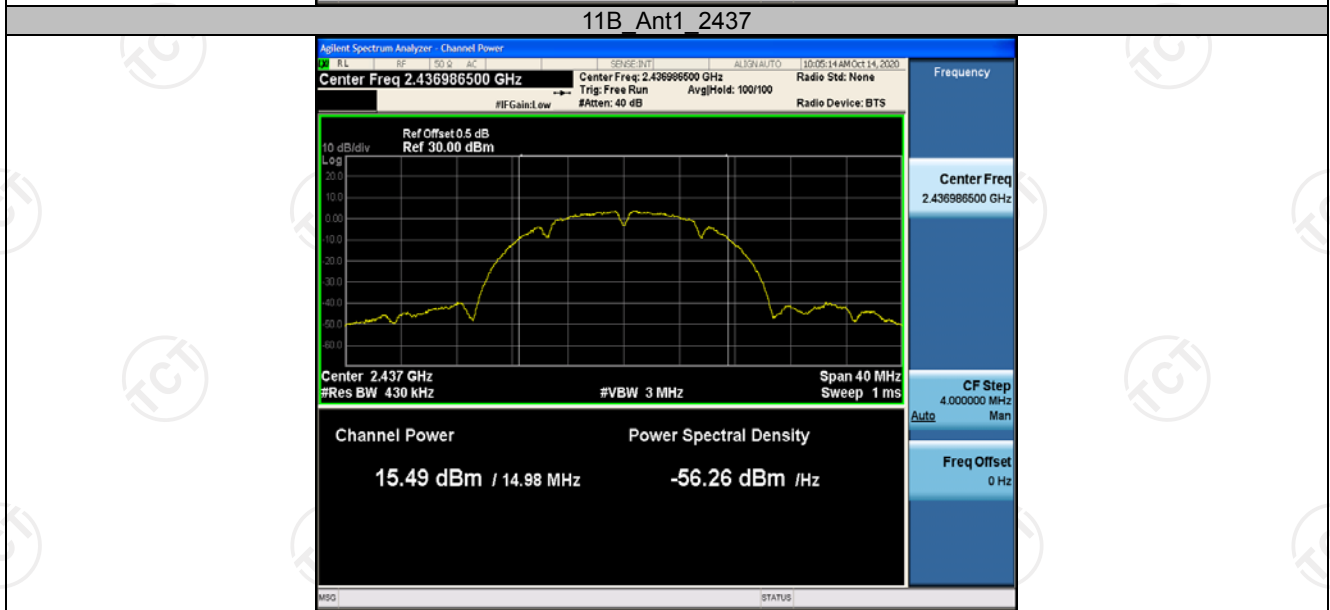
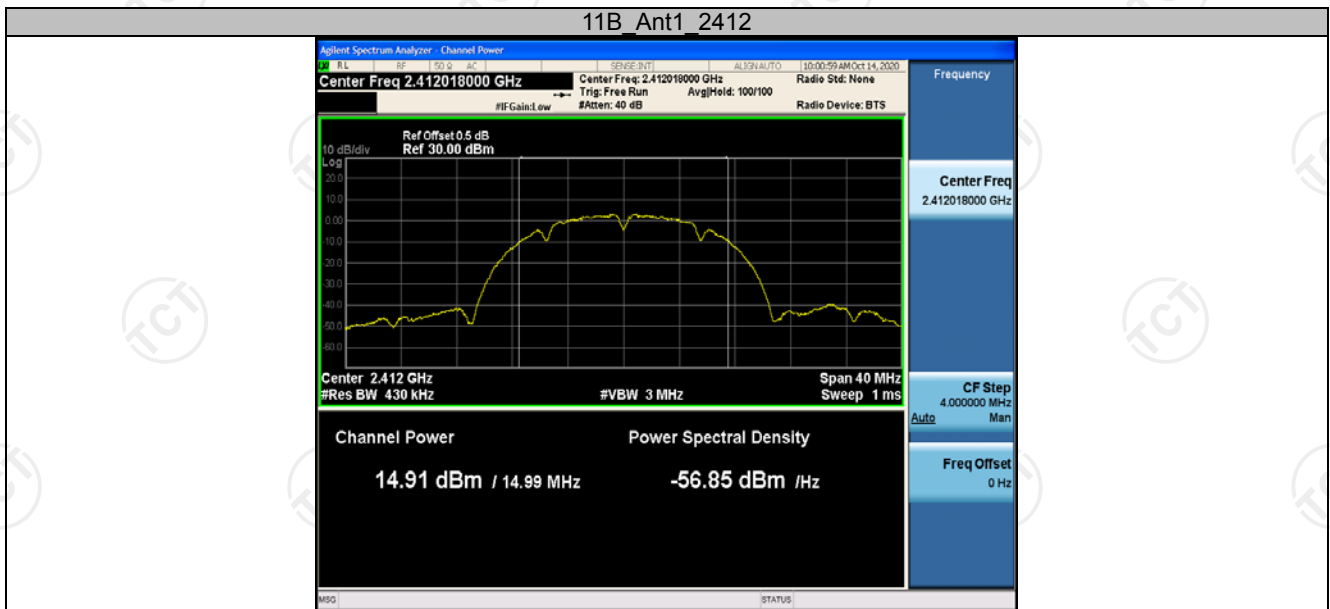

11B_Ant1_2462

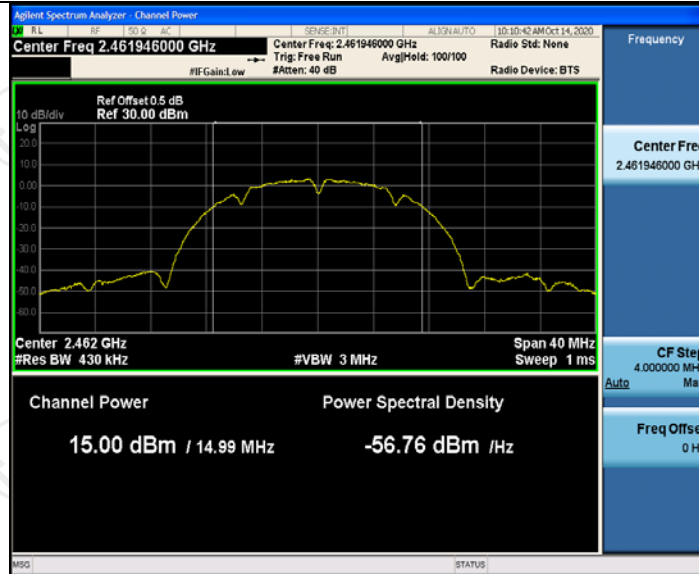

11G Ant1_2412

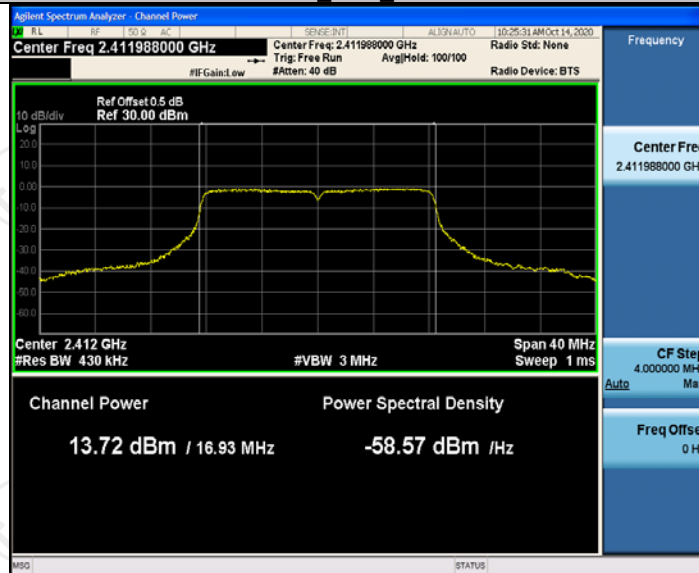

11G Ant1_2437

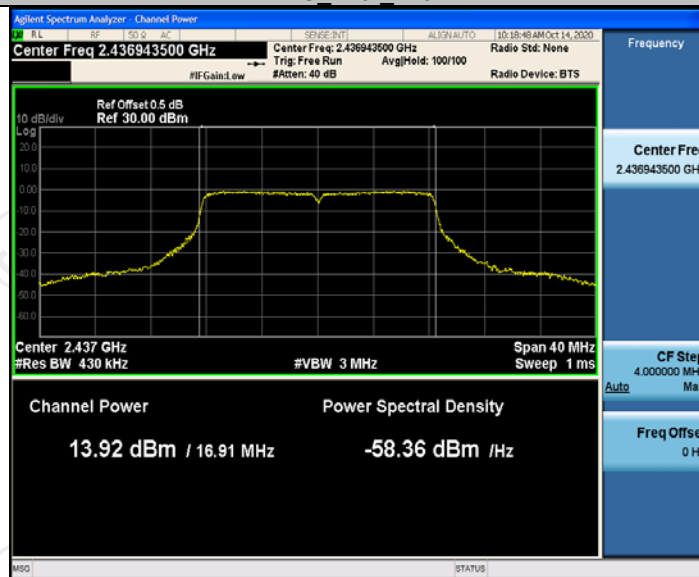

11G Ant1_2462

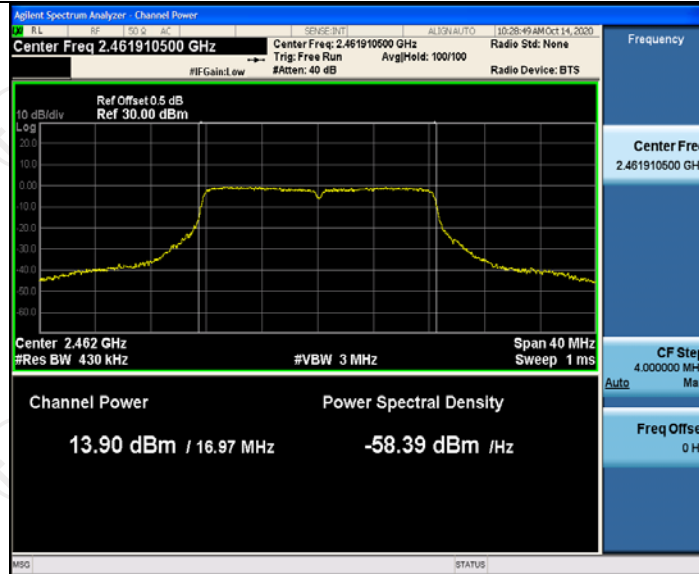

11N20SISO_Ant1_2412

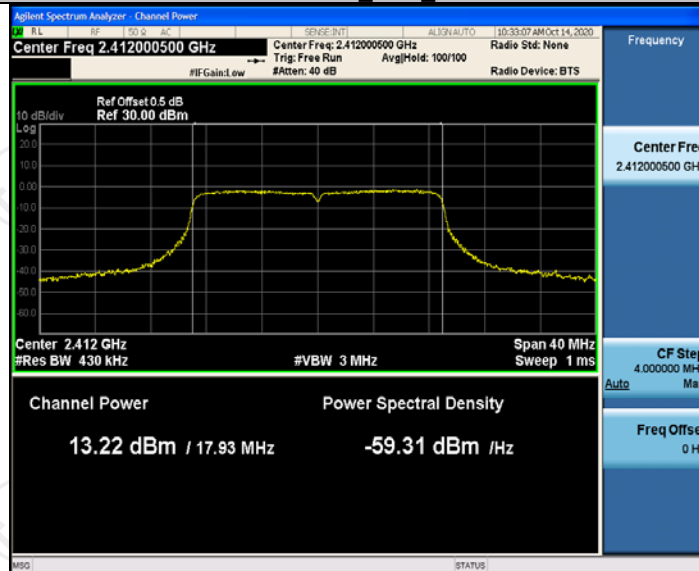

11N20SISO_Ant1_2437

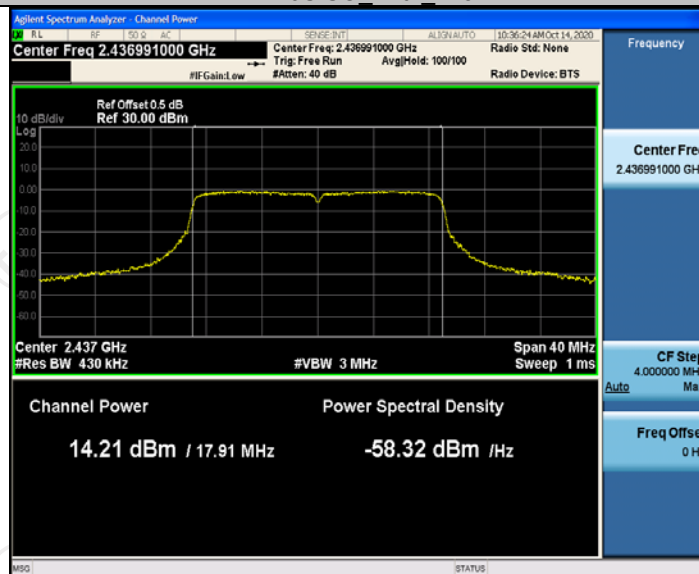

11N20SISO_Ant1_2462

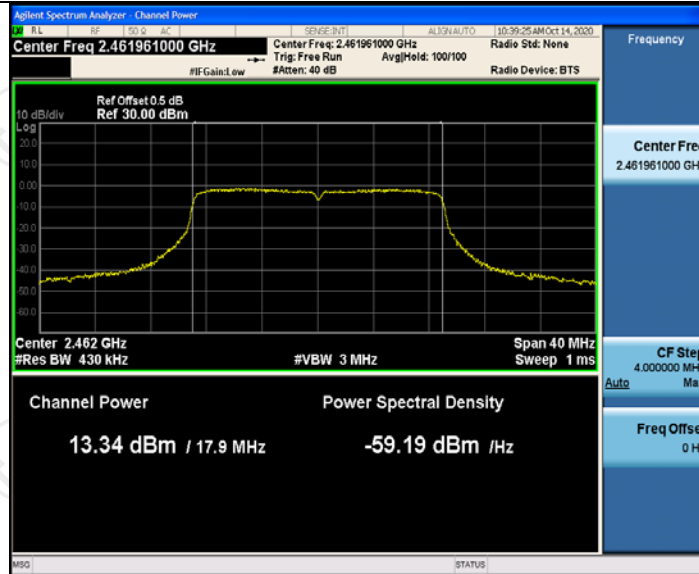

11N40SISO_Ant1_2422

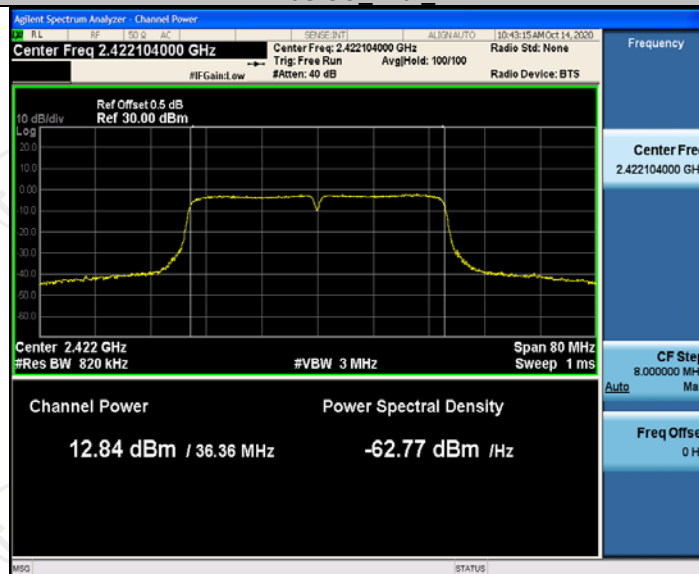

11N40SISO_Ant1_2423

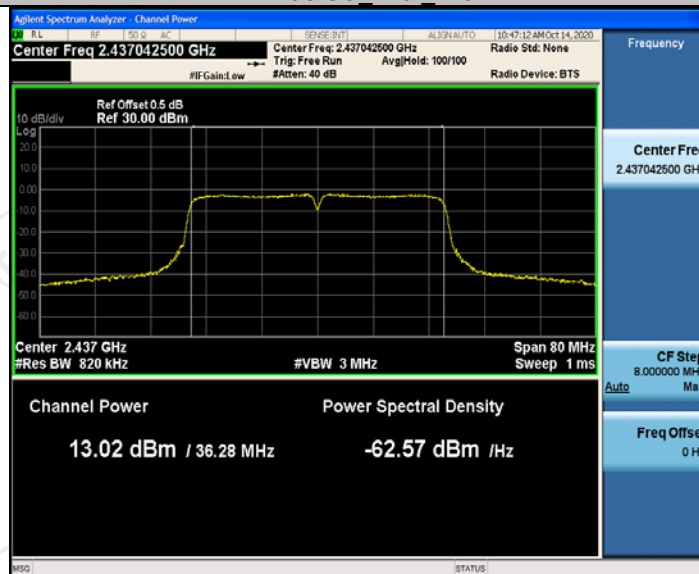

11N40SISO_Ant1_2452

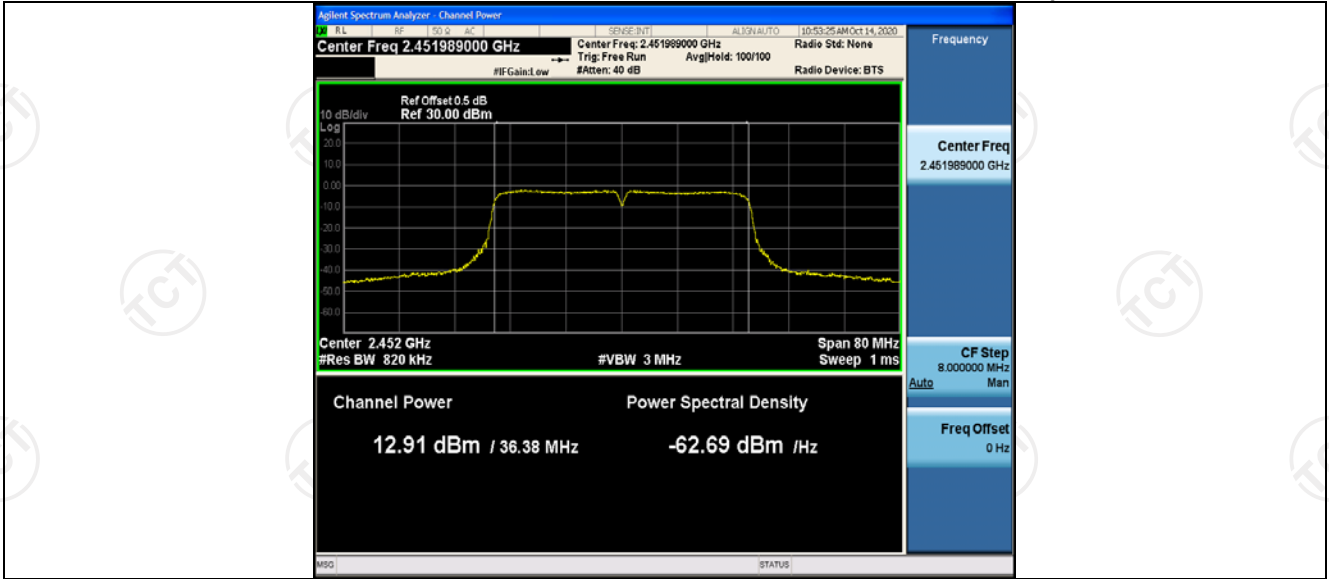

Maximum power spectral density

Test Result

Test Mode	Antenna	Channel	Result[dBm/30kHz]	Result[dBm/3kHz]	Limit[dBm/3kHz]	Verdict
11B	Ant1	2412	-7.40	-17.40	<=8	PASS
		2437	-7.04	-17.04	<=8	PASS
		2462	-7.50	-17.50	<=8	PASS
11G	Ant1	2412	-10.70	-20.70	<=8	PASS
		2437	-10.58	-20.58	<=8	PASS
		2462	-9.85	-19.85	<=8	PASS
11N20SISO	Ant1	2412	-10.72	-20.72	<=8	PASS
		2437	-9.95	-19.95	<=8	PASS
		2462	-10.95	-20.95	<=8	PASS
11N40SISO	Ant1	2422	-14.82	-24.82	<=8	PASS
		2437	-14.51	-24.51	<=8	PASS
		2452	-14.73	-24.73	<=8	PASS

Test Graphs

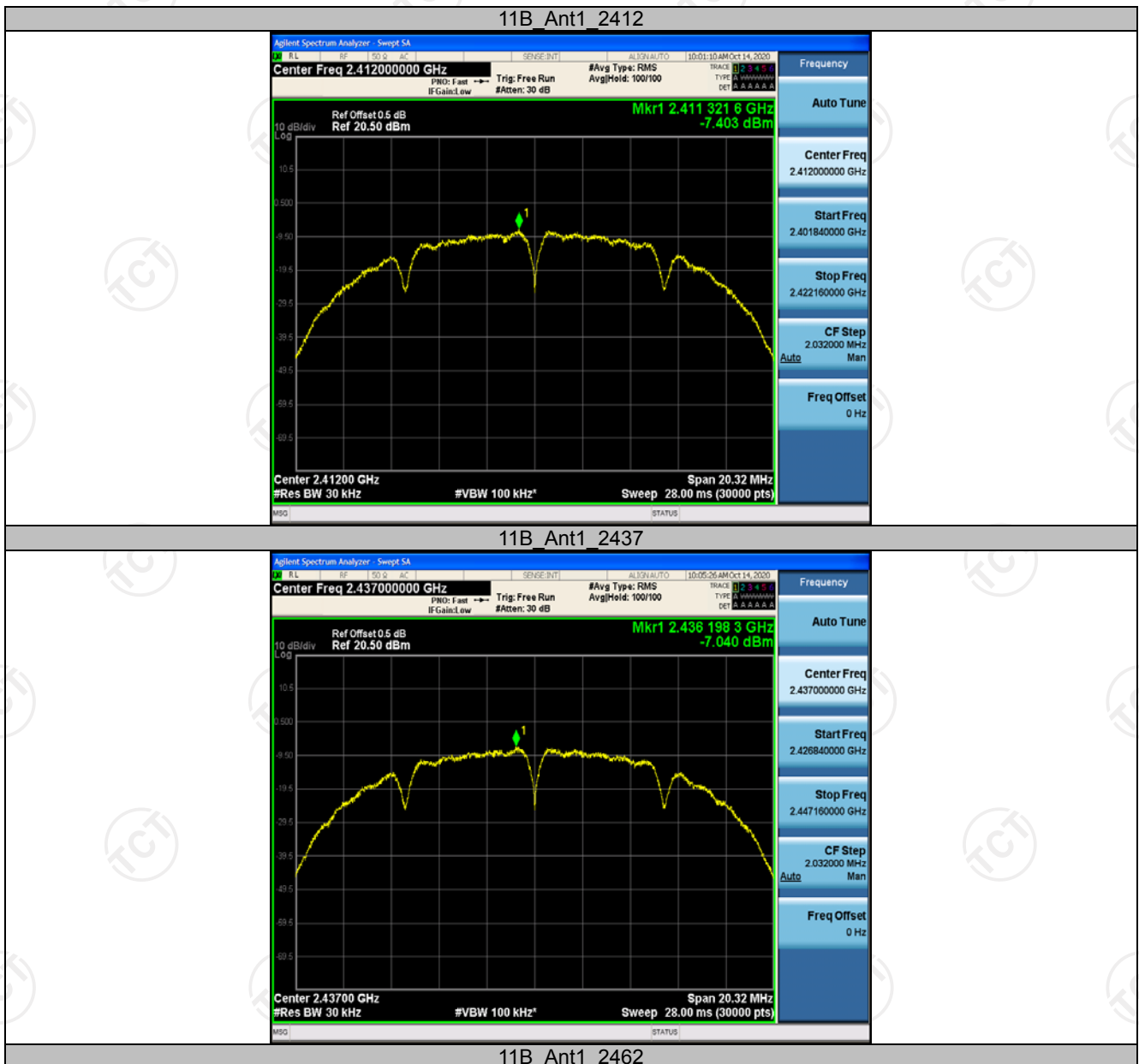



11G Ant1_2412



11G Ant1_2437

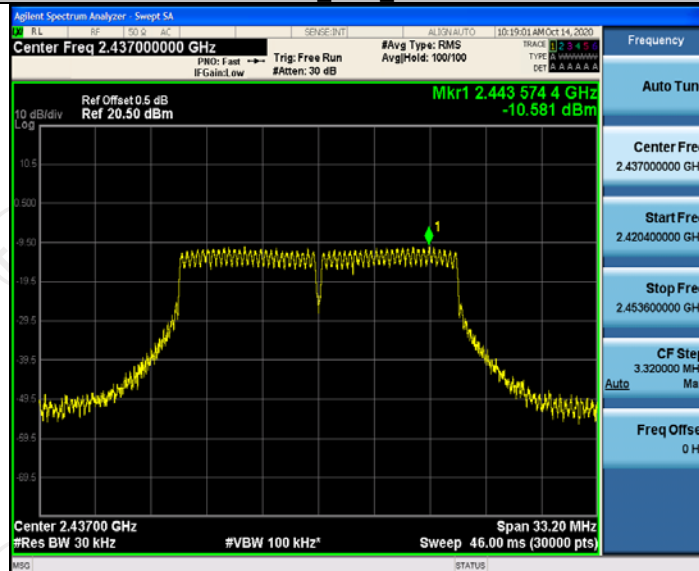

11G Ant1_2462