



SmartCam View

Wireless NVR System

Quick Start Guide

What's in the Box



Wireless NVR

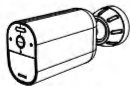

Battery Camera



Solar Panel



3.3ft (1m)
Network Cable



10ft (3m) USB-C
Extension Cord

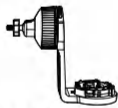

Solar Panel
Mounting Bracket



USB Mouse



HDMI Cable



Camera
Holding Bracket



NVR Power Adapter



Pack of Screws



Reset Needle Pin



Quick Start Guide



Screw Positioning Stickers

Note: Quantity of devices and accessories vary by different models that you purchase.

Introduce the NVR

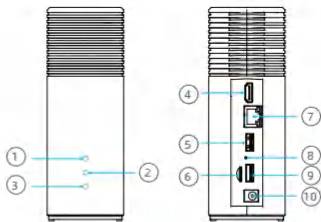

- ① Network Status LED
- ② Storage Status LED
- ③ Power Status LED
- ④ HDMI Port
- ⑤ USB Port
- ⑥ MicroSD Card Slot
- ⑦ Ethernet Port
- ⑧ Reset Hole
- ⑨ USB Port
- ⑩ Power Port

Introduce the Camera

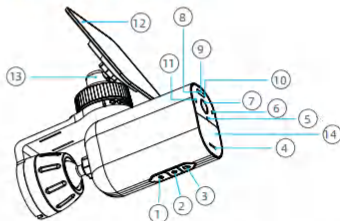

- ① USB-C Charging Port
- ② Pair/Power* Button
- ③ Micro SD Card Slot
- ④ Speaker
- ⑤ Microphone
- ⑥ Photosensitive Sensor
- ⑦ Camera Lens
- ⑧ Red and Green Light
- ⑨ Spot Light
- ⑩ Infrared LED
- ⑪ Indicator Light
- ⑫ Solar Panel
- ⑬ Solar Panel Bracket
- ⑭ PIR Sensor

Indicator Light Status	Description
Red light is solid on	Camera is booting
Infrared LEDs flashing	Waiting for pairing
Green light is solid on	Camera is charging
Blue light is flashing	Remote preview
Purple light is solid on	Camera is upgrading
Red & Blue light is flashing	Network Error
Off	Sleep Mode / Fully Charged

*Power Button:

1. Press and hold for 3 seconds to turn on the camera when it is off.
2. Press and hold for 8 seconds to turn off the camera when it is on.

Expanding Storage(Optional)

The NVR supports SD cards (maximum capacity of 512G) or 2.5-inch hard drives for saving video recordings.

Prepare Your Hard Drive

Your hard drive must meet the following requirements:

Type	Hard disk drive (HDD) or solid state drive (SSD) that uses the SATA interface
Size	2.5 inch
Capacity	Unlimited
Recommended	Western Digital, Seagate, SAMSUNG, Toshiba, Kingston, PNY, Crucial, SanDisk

 A new hard drive must be formatted. You may need to transfer all the data from your hard drive to a secure location if necessary.

Install Your Hard Drive

 NVR must be powered off when you install or remove a hard drive.

1. Push down the bottom lid to remove it.
2. Loosen the screw, then pull out the hard drive bracket.

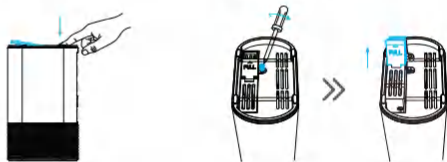

3. Fix your hard drive to the bracket with the provided screws.



4. Insert and screw the bracket back to NVR, then put the bottom lid back into place.

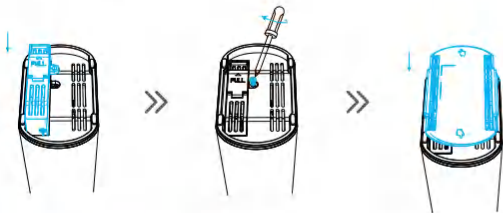

Charging the Camera

We recommend fully charge the cameras before first use.

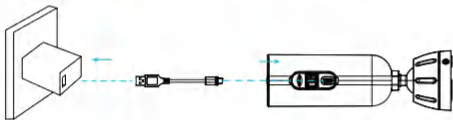

Indicator Light Status	Description
Green light is solid on	Camera is charging
OFF	Fully charged

Setting Up the System

EN

1. Connect the included power adapter to the NVR, wait a few minutes for the system to start up.
2. Connect the NVR to your router using the included Ethernet cable. And then, connect the USB mouse to the USB port of the NVR.

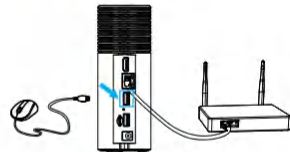
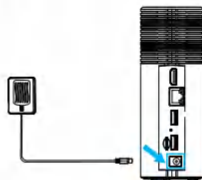

3. Connect the NVR to the monitor with a HDMI cable. (Optional, if you wish to monitor on a screen)

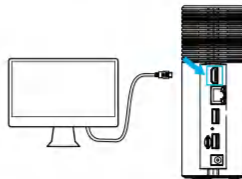

4. To turn on the camera, press and hold the power button located at the bottom of the camera for 3 seconds. It will automatically connect to the NVR via a wireless signal.

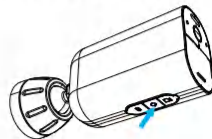

5. Download and install the free "SmartCam View" app from the App Store (iOS devices) or Google Play (Android devices).



Or Download the APP by scanning below QR code.



6. Run the "SmartCam View" app, sign up for a SmartCam View Life account. Then login with your account ID, tap "+ Add Device" and scan the setup QR code on the Device Bottom (remove the bottom lid). Or scan the setup QR code in the NVR menu, and then follow the in-app instructions to add the NVR to the device list.

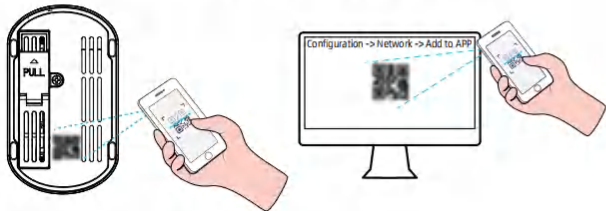

Mounting the Camera

Option 1: Mount the Camera with the Solar Panel Attached (Less Drilling)

If you mount a location without eaves and sunlight is not obstructed, install the solar panel directly on the top of the camera with the solar panel's mounting bracket.



1. Install the solar panel onto the solar panel's mounting bracket by turning it.

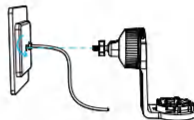

2. Secure the power cable of the solar panel onto the bracket's slot.

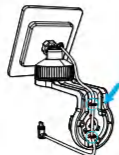

3. Drill holes with a 6.0 mm drill bit with the included positioning card, then insert the anchors into the holes.

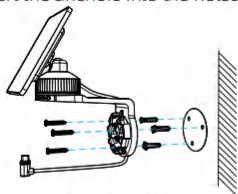

4. Install the camera onto its mounting bracket by turning it clockwise until it clicks into place.

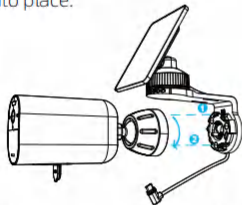

5. Tighten the locking screw on the mount bracket, and then adjust to the angle you need.

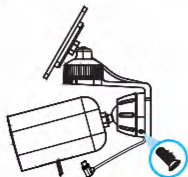

6. Connect the USB-C connector to the USB-C port of the solar panel.

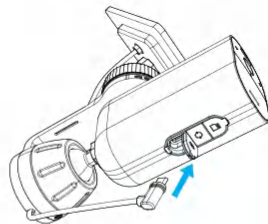

Option 2: Mount the Camera and the Solar Panel Separately (Best for Strong Solar Power)

If the camera is blocked, install the solar panel independently and use the provided USB-C extension cable to get strong solar power. The camera can be mounted on a wall or on the ceiling.

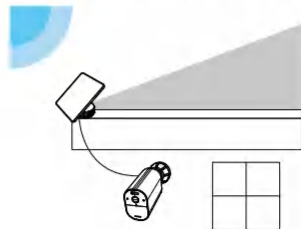

1. Disassemble the Solar Panel Mounting Bracket.

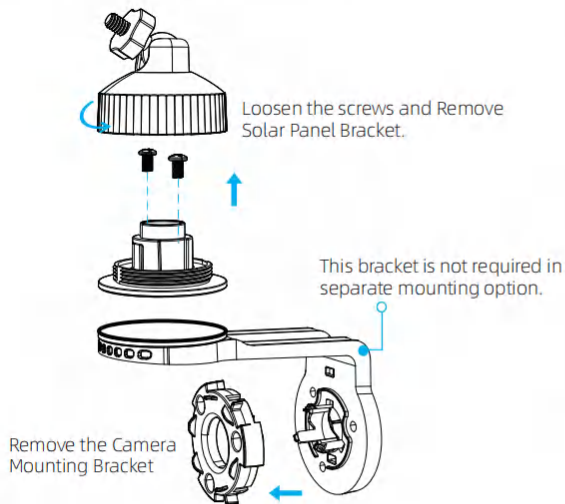

2. Install the mounting bracket of the solar panel in a suitable position.



3. Install the solar panel onto its mounting bracket by turning it, then adjust the angle.

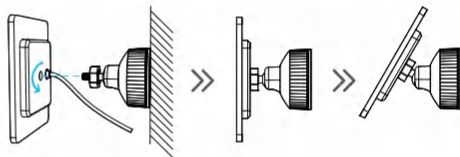

4. Install the camera

Drill holes with a 6.0 mm drill bit with the included positioning card, then insert the anchors into the holes.

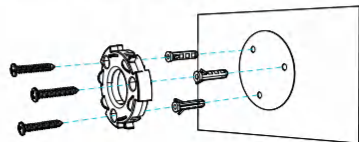

5. Install the camera onto its mounting bracket by turning it clockwise until it clicks into place.

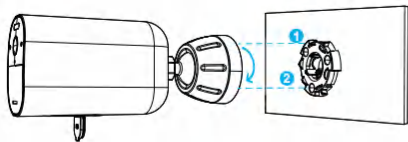

6. Tighten the locking screw on the mount bracket, and then adjust to the angle you need.

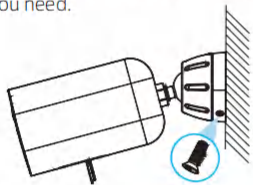

7. Connect the solar panel to the camera using the provided USB-C extension cable.

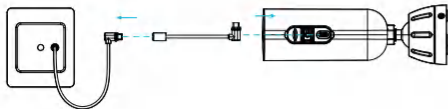

Camera Holding Bracket

EN

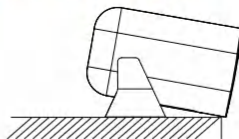

The camera holding bracket can be used for placement and adjustment of angles in some scenarios.

Pairing the Camera

Pair your add-on camera or re-add existing camera to your NVR:
Option 1: Using the "SmartCam View Life" app, from the Live view, tap the "..." button, and then tap "Pairing" to start the pairing process. You will have a 180-second timer to pair with your Camera.

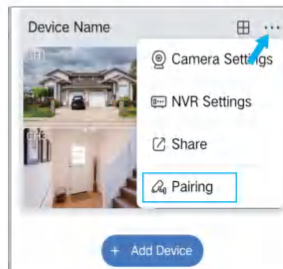

Press the camera pair button three times within three seconds to start pairing with your NVR. A "Pairing Successful" message should appear on the screen. If you do not see this message, repeat the steps above.

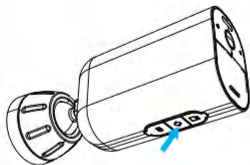

Option 2 : You can also add the camera via the Monitor, tap the "pair" button on NVR Live View menu to start the pairing process.

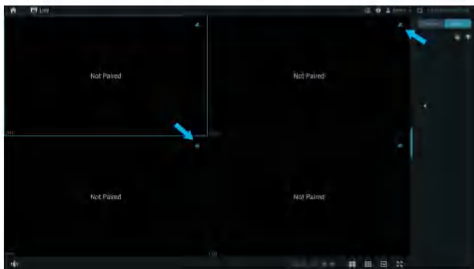

Press the camera pair button three times within three seconds to start pairing with your NVR. A "Pairing Successful" message should appear on the screen. If you do not see this message, repeat the steps above.

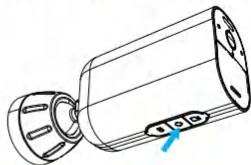

Troubleshooting

No video output on the monitor

If there's no video output on the monitor from NVR, please try the following solutions:

- Monitor resolution should be at least 720P or above.
- Hold down right mouse button for 10 seconds to restore default resolution.
- Double check the HDMI connection, or swap another cable or monitor to test.

Notification of Compliance



The terms HDMI and HDMI High-Definition Multimedia Interface, and the HDMI Logo are trademarks or registered trademarks of HDMI Licensing Administrator, Inc. in the United States and other countries.

FC Compliance Statement

This device contains licence-exempt transmitter(s)/receiver(s) that comply with Part 15 of the FCC Rules. Operation is subject to the following two conditions:

- (1) This device may not cause interference.
- (2) This device must accept any interference, including interference that may cause undesired operation of the device.

Caution: The user is cautioned that changes or modifications not expressly approved by the party responsible for compliance could void the user's authority to operate the equipment.

NOTE: This equipment has been tested and found to comply with the limits for a Class B digital device, pursuant to Part 15 of the FCC Rules. These limits are designed to provide reasonable protection against harmful interference in a residential installation. This equipment generates, uses and can radiate radio frequency energy and, if not installed and used in accordance with the instructions, may cause harmful interference to radio communications. However, there is no guarantee that interference will not occur in a particular installation. If this equipment does cause harmful interference to radio or television reception, which can be determined by turning the equipment off and on, the user is encouraged to try to correct the interference by one or more of the following measures:

- Reorient or relocate the receiving antenna.
- Increase the separation between the equipment and receiver.
- Connect the equipment into an outlet on a circuit different from that to which the receiver is connected.
- Consult the dealer or an experienced radio/TV technician for help.

FCC Radiation Exposure Statement:

This equipment complies with FCC radiation exposure limits set forth for an uncontrolled environment. This equipment should be installed and operated with a minimum distance of 20cm between the radiator and your body. This transmitter must not be co-located or operating in conjunction with any other antenna or transmitter.

IC Compliance Statement

The transmitter/receiver exempt from licensing contained in this device complies with Innovation, Science and Economic Development Canada's (ISED) regulations applicable to license-exempt radio apparatus. Operation is subject to the following two conditions:

- (1) This device must not cause interference, and
- (2) this device must accept any interference, including interference that may cause undesired operation of the device.

IC Radiation Exposure Statement:

This equipment complies with the radiation exposure limits set forth for uncontrolled environments in Canada. This equipment should be installed and operated with a minimum distance of 20 cm between the radiator and your body. This transmitter must not be co-located or operating in conjunction with any other antenna or transmitter.

CE Simplified EU Declaration of Conformity

SmartCam View declares that this device is in compliance with the essential requirements and other relevant provision of Directive EN300328, EN301489-1, EN31489-17, EN IEC 62311, EN IEC 62368.



Correct Disposal of This Product

Please recycle this product responsibly to promote the sustainable reuse of material resources and avoid potential harm to the environment.



Correct Disposal of This Product

This marking indicates that this product should not be disposed with other household wastes throughout the EU. To prevent possible harm to the environment or human health from uncontrolled waste disposal, recycle it responsibly to promote the sustainable reuse of material resources. To return your used device, please use the return and collection systems or contact the retailer where the product was purchased. They can take this product for environment safe recycling.

Was ist in der Box



Drahtloser NVR

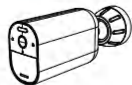

Batteriekamera



Solarpanel



3,3ft (1m)
Netzwerkabel



10ft (3m) USB-C
Verlängerungskabel

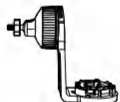

Solarpanel-
Montagewinkel



USB-Maus



HDMI-Kabel



Kamerahalterung
Bracket



NVR Netzteil



Packung
Schrauben



Resetnadel



Schnellstartanleitung



Schraubenpositionierungs-
Aufkleber

Hinweis: Die Anzahl der Geräte und Zubehörteile variiert je nach dem von Ihnen erworbenen Modell.

Vorstellung des NVR

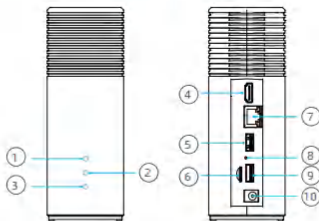

- ① Netzwerkstatus-LED
- ② Status-LED für Speicher
- ③ LED für den Leistungsstatus
- ④ HDMI-Anschluss
- ⑤ USB-Anschluss
- ⑥ MicroSD-Kartensteckplatz
- ⑦ Ethernet-Port
- ⑧ Resetloch
- ⑨ USB-Anschluss
- ⑩ Stromanschluss

Vorstellung der Kamera

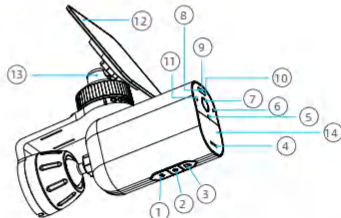

- ① USB-C-Ladeanschluss
- ② Pair/Power*-Taste
- ③ Micro-SD-Kartensteckplatz
- ④ Lautsprecher
- ⑤ Mikrofon
- ⑥ Lichtempfindlicher Sensor
- ⑦ Kameraobjektiv
- ⑧ Rot und grünes Licht
- ⑨ Spot-Licht
- ⑩ Infrarot-LED
- ⑪ Kontrollleuchte
- ⑫ Solarpanel
- ⑬ Solarpanel-Halterung
- ⑭ PIR-Sensor

Anzeigelichtstatus	Beschreibung
Rotes Licht ist dauerhaft an	Kamera wird gestartet
Infrarot-LEDs blinken	Warten auf Paarung
Grünes Licht ist dauerhaft an	Kamera wird geladen
Blaues Licht blinkt	Fernvorschau
Violettes Licht ist dauerhaft an	Kamera wird aktualisiert
Rotes und blaues Licht blinkt	Netzwerkfehler
Aus	Schlafmodus / Vollständig aufgeladen

*Ein-/Ausschalter:

1. Drücken und halten Sie die Taste für 3 Sekunden, um die Kamera einzuschalten, wenn sie ausgeschaltet ist.
2. Halten Sie die Taste 8 Sekunden lang gedrückt, um die Kamera auszuschalten, wenn sie eingeschaltet ist.

Erweiterung des Speichers (Optional)

Die NVR unterstützt SD-Karten (maximale Kapazität von 512G) oder 2.5 Zoll Festplatten für die Speicherung von Videoaufzeichnungen.

Bereiten Sie Ihre Festplatte vor

Ihre Festplatte muss folgende Anforderungen erfüllen:

Typ	Festplattenlaufwerk (HDD) oder Solid State Drive (SSD), das die SATA-Schnittstelle verwendet
Größe	2,5 Zoll
Kapazität	Unbegrenzt
Empfohlen	Western Digital, Seagate, SAMSUNG, Toshiba, Kingston, PNY, Crucial, SanDisk



Eine neue Festplatte muss formatiert werden. Gegebenenfalls müssen Sie alle Daten von Ihrer Festplatte an einen sicheren Ort übertragen.

DE

Installieren Sie Ihre Festplatte



Das NVR muss ausgeschaltet sein, wenn Sie eine Festplatte einbauen oder entfernen.

1. Drücken Sie den unteren Deckel nach unten, um ihn zu entfernen.
2. Lösen Sie die Schraube und ziehen Sie dann den Festplattenhalter heraus.

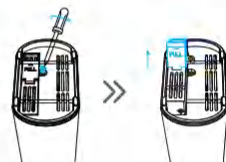

3. Befestigen Sie Ihre Festplatte mit den mitgelieferten Schrauben am Halter.



4. Befestigen und schrauben Sie die Halterung wieder an den NVR und setzen Sie dann den Bodendeckel wieder ein.

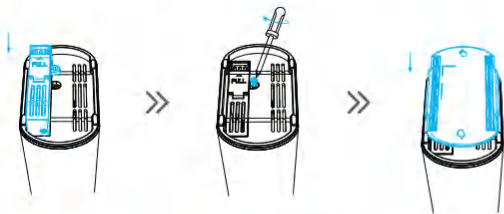

Das Aufladen der Kamera

Wir empfehlen, die Kameras vor der ersten Benutzung vollständig aufzuladen.

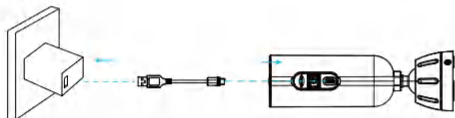

Anzeigenlichtstatus	Beschreibung
Grünes Licht leuchtet durchgehend	Kamera wird aufgeladen
AUS	Vollständig aufgeladen

Einrichten des Systems

1. Schließen Sie den mitgelieferten Netzadapter an den NVR an und warten Sie einige Minuten, bis das System hochgefahren ist.
2. Verbinden Sie den NVR mit Ihrem Router unter Verwendung des mitgelieferten Ethernet-Kabels. Und dann, schließen Sie die USB-Maus an den USB-Port des NVR an.

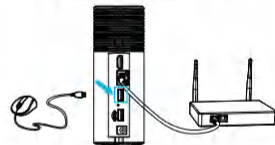
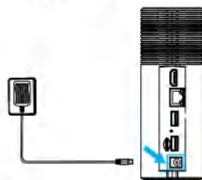

3. Verbinden Sie den NVR mit einem HDMI-Kabel mit dem Monitor. (Optional, falls Sie auf einem Bildschirm überwachen möchten)

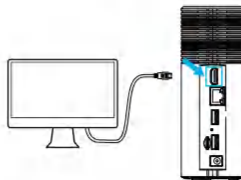

4. Um die Kamera einzuschalten, drücken und halten Sie die Ein-/Austaste, die sich an der Unterseite der Kamera befindet, für 3 Sekunden. Sie wird automatisch über ein drahtloses Signal mit dem NVR verbinden.

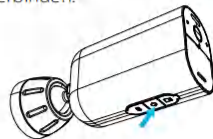

5. Laden Sie die kostenlose "SmartCam View" App aus dem App Store (iOS-Geräte) oder Google Play (Android-Geräte) herunter und installieren Sie sie.



Oder laden Sie die App herunter, indem Sie den unten stehenden QR-Code scannen.



For iOS



For Android

6. Starten Sie die "SmartCam View"-App, registrieren Sie sich für ein SmartCam View Life-Konto. Melden Sie sich dann mit Ihrer Kontonummer an, tippen Sie auf "+ Gerät hinzufügen" und scannen Sie den Einrichtungs-QR-Code auf der Geräteunterseite (entfernen Sie dazu den Bodendeckel). Oder scannen Sie den Einrichtungs-QR-Code im NVR-Menü und folgen Sie dann den Anweisungen in der App, um den NVR zur Geräteliste hinzuzufügen.

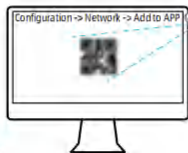
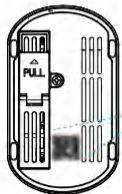

Montage der Kamera

Option 1: Montieren Sie die Kamera mit dem angebrachten Solarpanel (Weniger Bohren)

DE

Wenn Sie einen Ort ohne Überdachung wählen und das Sonnenlicht nicht blockiert ist, montieren Sie das Solarpanel mit der Montagehalterung des Solarmoduls direkt auf der Oberseite der Kamera.



1. Installieren Sie das Solarpanel, indem Sie es auf die Halterung des Solarmoduls drehen.

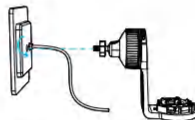

2. Befestigen Sie das Stromkabel des Solarmoduls am Schlitz der Halterung.

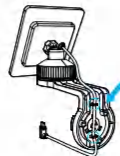

3. Bohren Sie Löcher mit einem 6,0-mm-Bohrer mithilfe der beiliegenden Positionierungskarte, und setzen Sie anschließend die Dübel in die Löcher ein.

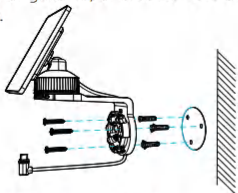

4. Installieren Sie die Kamera auf ihrer Montagehalterung, indem Sie sie im Uhrzeigersinn drehen, bis sie einrastet.

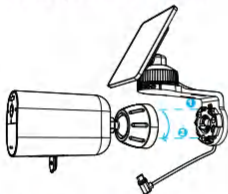

5. Ziehen Sie die Arretierschraube an der Halterung fest und justieren Sie dann den Winkel nach Bedarf.

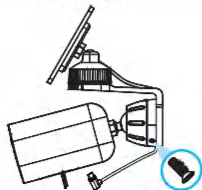

6. Verbinden Sie den USB-C-Stecker mit dem USB-C-Anschluss des Solarmoduls.

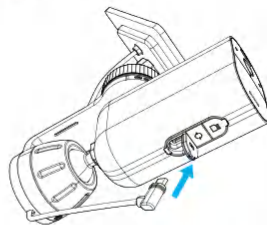

Option 2: Montieren Sie die Kamera und das Solarpanel separat (Am besten für starke Solarenergie)

Wenn die Kamera blockiert ist, installieren Sie das Solarmodul unabhängig und verwenden Sie das mitgelieferte USB-C-Verlängerungskabel, um starke Solarenergie zu erhalten. Die Kamera kann an einer Wand oder an der Decke montiert werden.

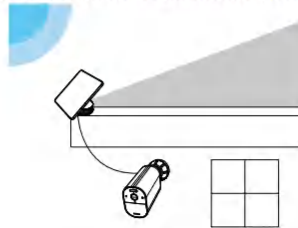

1. Zerlegen Sie die Montagehalterung des Solarmoduls.

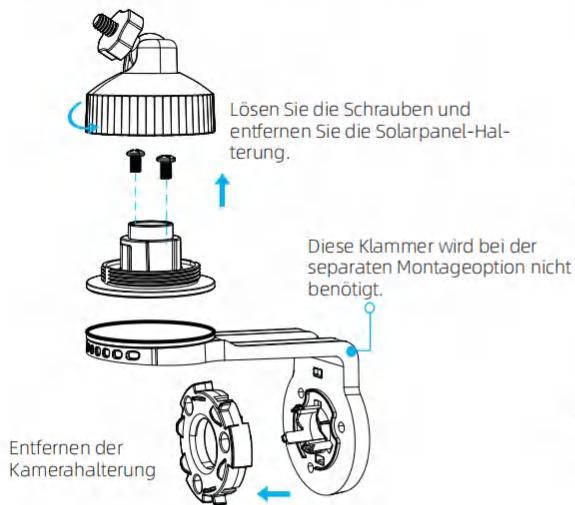

2. Installieren Sie das Montagegestell des Solarmoduls an einer geeigneten Stelle.



DE

3. Installieren Sie das Solarmodul auf seinem Halterungswinkel, indem Sie es drehen, und justieren Sie dann den Winkel.

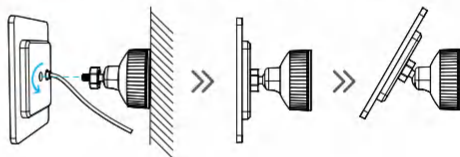

4. Installieren Sie die Kamera

Bohren Sie Löcher mit einem 6,0 mm Bohrer mit der mitgelieferten Positionierungskarte, dann setzen Sie die Dübel in die Löcher ein.

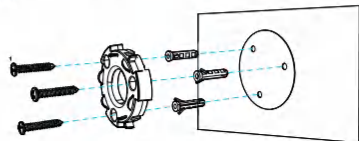

5. Installieren Sie die Kamera auf ihrer Halterung, indem Sie sie im Uhrzeigersinn drehen, bis sie einrastet.

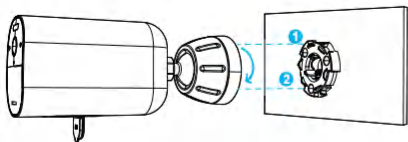

6. Ziehen Sie die Arretierschraube an der Montagehalterung fest und stellen Sie dann den gewünschten Winkel ein.

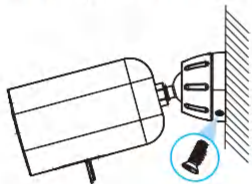

7. Verbinden Sie das Solarmodul über das mitgelieferte USB-C-Verlängerungskabel mit der Kamera.

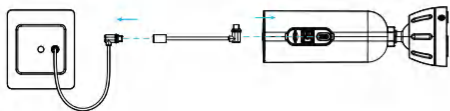

Kamerahalterung

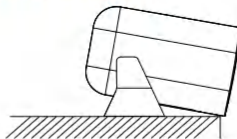

Das Kamerahalterungsgestell kann in einigen Szenarien zur Platzierung und Winkelverstellung verwendet werden.

Koppeln der Kamera

Koppeln Sie Ihre zusätzliche Kamera oder fügen Sie eine vorhandene Kamera erneut zu Ihrem NVR hinzu:

Option 1: Verwenden Sie die "SmartCam View Life"-App, tippen Sie in der Live-Ansicht auf die Schaltfläche "...", und dann auf "Koppeln", um den Kopplungsvorgang zu starten. Sie haben einen 180-Sekundentimer, um mit Ihrer Kamera zu koppeln.

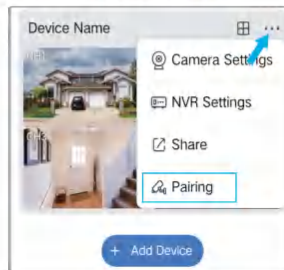

Drücken Sie die Kamera paarungstaste dreimal innerhalb von drei Sekunden, um die Kopplung mit Ihrem NVR zu starten. Eine Meldung "Kopplung erfolgreich" sollte auf dem Bildschirm erscheinen. Wenn Sie diese Meldung nicht sehen, wiederholen Sie die obigen Schritte.

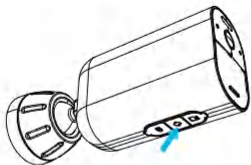

Option 2 : Sie können die Kamera auch über den Monitor hinzufügen, tippen Sie auf die Schaltfläche "pairen" im NVR Live View-Menü, um den Kopplungsvorgang zu starten.

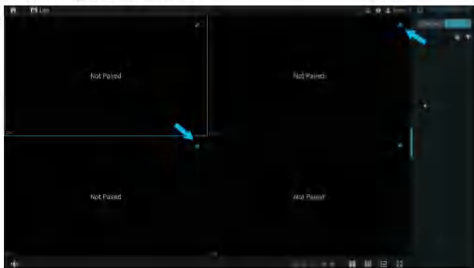

Drücken Sie dreimal innerhalb von drei Sekunden die Kamera-Pairing-Taste, um die Kopplung mit Ihrem NVR zu starten. Eine "Pairing erfolgreich"-Meldung sollte auf dem Bildschirm erscheinen. Wenn Sie diese Meldung nicht sehen, wiederholen Sie die oben genannten Schritte.

DE

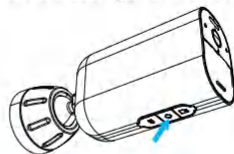

Fehlerbehebung

Keine Videoausgabe auf dem Monitor

Wenn von NVR kein Videoausgang auf dem Monitor ist, versuchen Sie bitte die folgenden Lösungen:

- Die Auflösung des Monitors sollte mindestens 720P oder höher sein.
- Halten Sie die rechte Maustaste 10 Sekunden lang gedrückt, um die Standardauflösung wiederherzustellen.
- Überprüfen Sie die HDMI-Verbindung doppelt, oder tauschen Sie ein anderes Kabel oder einen anderen Monitor zum Testen aus.

Benachrichtigung über Konformität

HDMI™
HDMI ist ein eingetragenes Warenzeichen von HDMI Licensing Administrator, Inc. in den Vereinigten Staaten und anderen Ländern.

Die Begriffe HDMI und HDMI High-Definition Multimedia Interface sowie das HDMI-Logo sind Warenzeichen oder eingetragene Warenzeichen von HDMI Licensing Administrator, Inc. in den Vereinigten Staaten und anderen Ländern.



Erklärung des Vergleichs

Dieses Gerät enthält lizenzfreie Sender/Empfänger, die den Teil 15 der FCC-Vorschriften entsprechen. Der Betrieb unterliegt den folgenden zwei Bedingungen:

- (1) Dieses Gerät darf keine Störungen verursachen.
- (2) Dieses Gerät muss jede Störung akzeptieren, einschließlich derjenigen, die einen unerwünschten Betrieb des Geräts verursachen können.

Vorsicht: Dem Benutzer wird darauf hingewiesen, dass Änderungen oder Modifikationen, die nicht ausdrücklich von der für die Einhaltung verantwortlichen Partei genehmigt wurden, die Berechtigung des Benutzers zum Betrieb der Ausrüstung aufheben könnten.

HINWEIS: Dieses Gerät wurde getestet und entspricht den Grenzwerten für ein digitales Gerät der Klasse B gemäß Teil 15 der FCC-Bestimmungen. Diese Grenzwerte sind so ausgelegt, dass sie einen angemessenen Schutz gegen schädliche Störungen bei einer Installation in Wohngebieten bieten. Dieses Gerät erzeugt, verwendet und kann Funkfrequenzenergie ausstrahlen und kann, wenn es nicht gemäß der Anleitung installiert und verwendet wird, schädliche Störungen für Funkkommunikation verursachen. Es kann jedoch nicht garantiert werden, dass es bei einer bestimmten Installation nicht zu Störungen kommt. Sollte dieses Gerät schädliche Störungen des Radio- oder Fernsehempfangs verursachen, was durch Ein- und Ausschalten des Geräts festgestellt werden kann, wird dem Benutzer empfohlen, die Störung durch eine oder mehrere der folgenden Maßnahmen zu korrigieren:

- Richten Sie die Empfangsantenne neu aus oder versetzen Sie sie an einen anderen Ort.
- Erhöhen Sie den Abstand zwischen dem Gerät und dem Empfänger.
- Schließen Sie das Gerät an eine Steckdose eines anderen Stromkreises an als den, an den der Empfänger angeschlossen ist.
- Konsultieren Sie den Händler oder einen erfahrenen Radio-/Fernsehtechniker um Hilfe.

FCC Erklärung zur Strahlenexposition:

Dieses Gerät entspricht den von der FCC festgelegten Strahlenexpositionsgrenzwerten für eine unkontrollierte Umgebung. Dieses Gerät sollte mit einem Mindestabstand von zwischen dem Strahler und Ihrem Körper installiert und betrieben werden. Dieser Sender darf nicht gemeinsam mit einer anderen Antenne oder einem anderen Sender an einem Ort platziert oder in Betrieb genommen werden.



Konformitätserklärung

Der in diesem Gerät enthaltene lizenzfreie Sender/Empfänger entspricht den von Innovation, Science and Economic Development Canada (ISED) geltenden Vorschriften für lizenzfreie Funkgeräte. Der Betrieb unterliegt den folgenden zwei Bedingungen:

- (1) Dieses Gerät darf keine Störungen verursachen und
- (2) Dieses Gerät muss jede Art von Störungen akzeptieren, einschließlich Störungen, die einen unerwünschten Betrieb des Gerätes verursachen können.

IC Erklärung zur Strahlenexposition:

Dieses Gerät entspricht den für unkontrollierte Umgebungen in Kanada festgelegten Strahlenexpositionsgrenzwerten. Dieses Gerät sollte mit einem Mindestabstand von zwischen dem Strahler und Ihrem Körper installiert und betrieben werden. Dieser Sender darf nicht gemeinsam am selben Ort oder in Verbindung mit einer anderen Antenne oder einem anderen Sender betrieben werden.



Vereinfachte EU-Konformitätserklärung

SmartCam View erklärt, dass dieses Gerät den wesentlichen Anforderungen und anderen relevanten Vorschriften der Richtlinie EN300328, EN301489-1, EN31489-17, EN IEC 62311, EN IEC 62368 entspricht.



Korrekte Entsorgung dieses Produkts

Bitte recyceln Sie dieses Produkt verantwortungsvoll, um die nachhaltige Wiederverwendung von Materialressourcen zu fördern und mögliche Schäden für die Umwelt zu vermeiden:



Korrekte Entsorgung dieses Produkts

Diese Kennzeichnung weist darauf hin, dass dieses Produkt nicht zusammen mit anderen Haushaltsabfällen in der gesamten EU entsorgt werden darf. Um mögliche Schäden für die Umwelt oder die menschliche Gesundheit durch unkontrollierte Abfallentsorgung zu verhindern, recyceln Sie es verantwortungsbewusst, um die nachhaltige Wiederverwendung von Materialressourcen zu fördern. Um Ihr gebrauchtes Gerät zurückzugeben, verwenden Sie bitte die Rücknahme- und Sammelsysteme oder kontaktieren Sie den Händler, bei dem das Produkt gekauft wurde. Sie können dieses Produkt umweltgerecht recyceln.

Ce qui est dans la Boîte



NVR sans fil

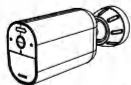

Caméra sur Batterie



Panneau Solaire



Câble réseau de 3,3 pieds (1m)



Cordon de rallonge USB-C de 10 pieds (3m)

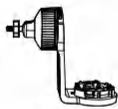

Support de Montage pour Panneau Solaire



Souris USB



Câble HDMI



Support de fixation pour appareil photo



Adaptateur d'alimentation NVR



Paquet de Vis



Réinitialiser l'aiguille du Pin



Guide de Démarrage Rapide



Autocollants pour le positionnement des vis

Remarque : La quantité d'appareils et d'accessoires varie selon les différents modèles que vous achetez.

Présentez le NVR

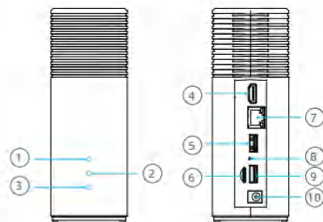

- ① LED d'état du réseau
- ② Témoin d'état de stockage
- ③ Témoin lumineux de l'état d'alimentation
- ④ Port HDMI
- ⑤ Port USB
- ⑥ Emplacement pour carte MicroSD
- ⑦ Port Ethernet
- ⑧ Trou de réinitialisation
- ⑨ Port USB
- ⑩ Port d'alimentation

FR

Présentation de l'appareil photo

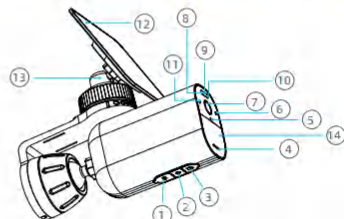

- ① Port de chargement USB-C
- ② Bouton Pair / Power*
- ③ Emplacement pour carte Micro SD
- ④ Haut-parleur
- ⑤ Microphone
- ⑥ Capteur photosensible
- ⑦ Objectif de l'appareil photo
- ⑧ Feu Rouge et Vert
- ⑨ Projecteur
- ⑩ LED infrarouge
- ⑪ Témoin lumineux
- ⑫ Panneau solaire
- ⑬ Support de panneau solaire
- ⑭ Capteur PIR

État du voyant indicateur	Description
La lumière rouge est allumée en continu	La caméra est en cours de démarrage
Les LED infrarouges clignotent	En attente de jumelage
La lumière verte est allumée en continu	La caméra est en charge
La lumière bleue clignote	Aperçu à distance
La lumière violette est allumée en continu	La caméra est en cours de mise à niveau
La lumière rouge et bleue clignote	Erreur de réseau
Éteint	Mode veille / Batterie complètement chargée

Bouton d'Alimentation :

- Maintenez enfoncé pendant 3 secondes pour allumer l'appareil photo lorsqu'il est éteint.
- Maintenez enfoncé pendant 8 secondes pour éteindre l'appareil photo lorsqu'il est allumé.

Extension de stockage (Optionnel)

Le NVR supporte les cartes SD (capacité maximum de 512G) ou les disques durs de 2.5 pouces pour enregistrer les vidéos.

Préparez votre disque dur

Votre disque dur doit répondre aux exigences suivantes :

Type	Disque dur (HDD) ou disque à semi-conducteurs (SSD) utilisant l'interface SATA
Taille	2,5 pouces
Capacité	Illimitée
Recommandés	Western Digital, Seagate, SAMSUNG, Toshiba, Kingston, PNY, Crucial, SanDisk



Un nouveau disque dur doit être formaté. Il peut être nécessaire de transférer toutes les données de votre disque dur vers un emplacement sécurisé si besoin.

Installez Votre Disque Dur



L'NVR doit être éteint lorsque vous installez ou retirez un disque dur.

- Appuyez vers le bas sur le couvercle inférieur pour le retirer.
- Desserrez la vis, puis tirez le support du disque dur vers l'extérieur.

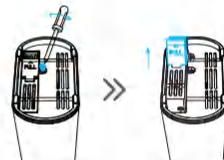

- Fixez votre disque dur au support avec les vis fournies.



4. Insérez et vissez le support à nouveau sur le NVR, puis remettez le couvercle inférieur en place.

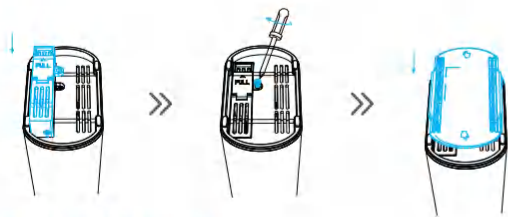

Charger la caméra

Nous recommandons de charger complètement les caméras avant la première utilisation.

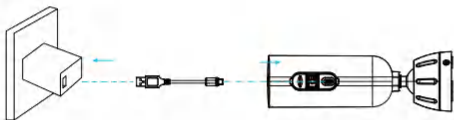

État du voyant indicateur	Description
La lumière verte est allumée en continu	La caméra est en charge
ÉTEINT	Complètement chargée

Configuration du système

1. Connectez l'adaptateur d'alimentation inclus au NVR, attendez quelques minutes pour que le système démarre.

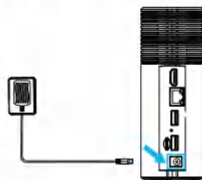

3. Connectez le NVR au moniteur avec un câble HDMI. (Optionnel, si vous souhaitez surveiller sur un écran)

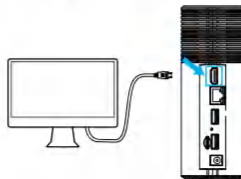

2. Connectez le NVR à votre routeur en utilisant le câble Ethernet inclus. Ensuite, connectez la souris USB au port USB du NVR.

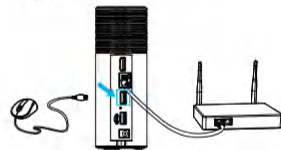

4. Pour allumer l'appareil photo, appuyez et maintenez enfoncé le bouton d'alimentation situé en bas de l'appareil pendant 3 secondes. Il se connectera automatiquement au NVR via un signal sans fil.

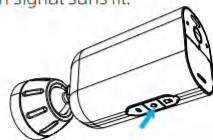

FR

5. Téléchargez et installez l'application gratuite "SmartCam View" depuis l'App Store (appareils iOS) ou Google Play (appareils Android).

Ou téléchargez l'application en scannant le code QR ci-dessous.

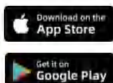

For iOS



For Android

6. Exécutez l'application "SmartCam View", inscrivez-vous pour un compte SmartCam View Life. Ensuite, connectez-vous avec votre identifiant de compte, appuyez sur "+ Ajouter un appareil" et scannez le code QR de configuration situé sous l'appareil (retirez le couvercle inférieur). Ou scannez le code QR de configuration dans le menu NVR, puis suivez les instructions dans l'application pour ajouter le NVR à la liste des appareils.

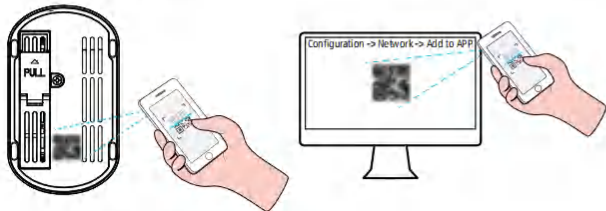

Installation de la caméra

Option 1 : Monter la caméra avec le panneau solaire attaché (Moins de perçage)

Si vous installez l'équipement à un endroit sans avancée de toit et que la lumière du soleil n'est pas obstruée, installez le panneau solaire directement sur le dessus de la caméra à l'aide du support de montage du panneau solaire.



1. Installez le panneau solaire sur le support de montage du panneau solaire en le tournant.

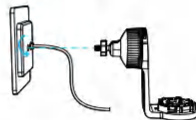

2. Fixez le câble d'alimentation du panneau solaire dans la fente du support.

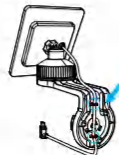

3. Percez des trous avec un foret de 6,0 mm à l'aide de la carte de positionnement incluse, puis insérez les chevilles dans les trous.

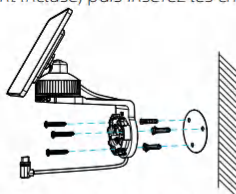

4. Installez la caméra sur son support de montage en la tournant dans le sens des aiguilles d'une montre jusqu'à ce qu'elle se verrouille en place par un clic.

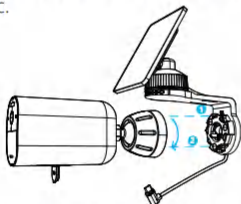

5. Serrez la vis de blocage sur le support de montage, puis ajustez à l'angle dont vous avez besoin.

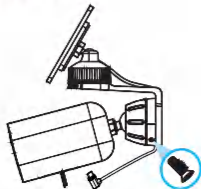

6. Connectez le connecteur USB-C au port USB-C du panneau solaire.

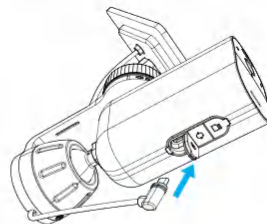

Option 2: Monter la caméra et le panneau solaire séparément (Idéal pour une puissance solaire importante)

Si la caméra est bloquée, installez le panneau solaire indépendamment et utilisez le câble d'extension USB-C fourni pour obtenir une forte puissance solaire. La caméra peut être montée sur un mur ou au plafond.

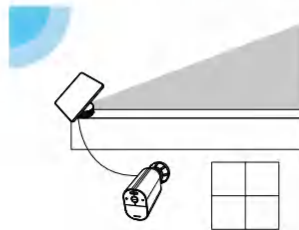

1. Démontez le support de montage du panneau solaire.

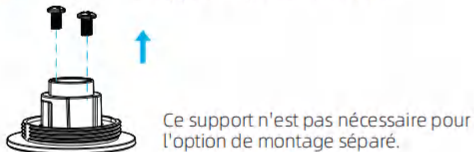

Retirer le support de montage de la caméra

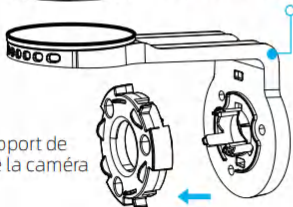

2. Installez le support de montage du panneau solaire dans une position appropriée.



3. Installez le panneau solaire sur son support de montage en le tournant, puis ajustez l'angle.

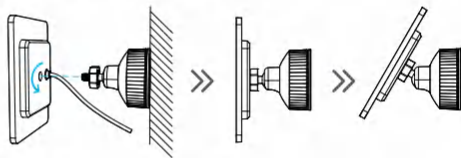

4. Installer la caméra

Percez des trous avec un foret de 6,0 mm à l'aide de la carte de positionnement incluse, puis insérez les chevilles dans les trous.

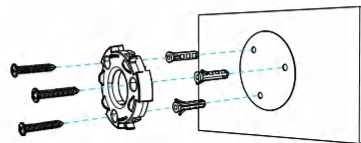

5. Installez la caméra sur son support de montage en la tournant dans le sens des aiguilles d'une montre jusqu'à ce qu'elle se mette en place avec un clic.

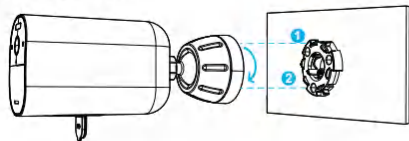

6. Serrez la vis de blocage sur le support de montage, puis ajustez à l'angle dont vous avez besoin.



7. Connectez le panneau solaire à la caméra en utilisant le câble d'extension USB-C fourni.

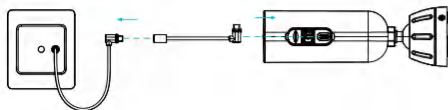

Support de Maintien pour Appareil Photo

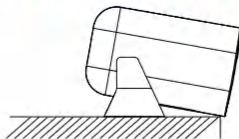

Le support de maintien de l'appareil photo peut être utilisé pour le placement et le réglage des angles dans certains scénarios.

Appairage de la caméra

Associez votre caméra complémentaire ou ajoutez de nouveau la caméra existante à votre NVR :

Option 1: Utilisez l'application "SmartCam View Life", depuis la vue en direct, appuyez sur le bouton "...", puis sur "Appairage" pour commencer le processus de couplage. Vous aurez un minuteur de 180 secondes pour jumeler avec votre Caméra.

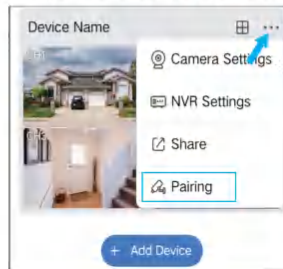

Appuyez trois fois sur le bouton de jumelage de la caméra en moins de trois secondes pour commencer le jumelage avec votre NVR. Un message "Jumelage réussi" devrait s'afficher à l'écran. Si vous ne voyez pas ce message, répétez les étapes ci-dessus.

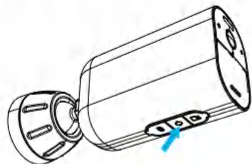

Option 2 : Vous pouvez également ajouter la caméra via le Moniteur, appuyez sur le bouton "appairer" du menu Vue en Direct NVR pour démarrer le processus d'appairage.

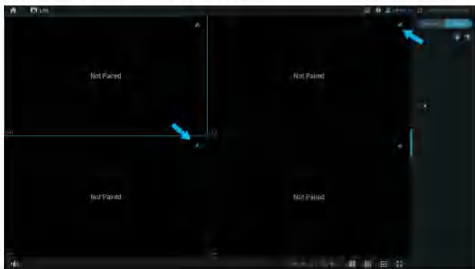

Appuyez trois fois sur le bouton de couplage de la caméra dans les trois secondes pour commencer l'appairage avec votre NVR. Un message "Appairage réussi" devrait apparaître à l'écran. Si vous ne voyez pas ce message, répétez les étapes ci-dessus.

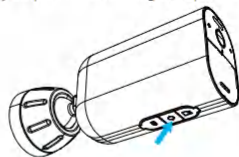

Dépannage

Aucune sortie vidéo sur le moniteur

Si vous n'avez pas de sortie vidéo sur le moniteur depuis le NVR, veuillez essayer les solutions suivantes:

- La résolution de l'écran doit être au minimum de 720P ou supérieure.
- Maintenez le bouton droit de la souris enfoncé pendant 10 secondes pour restaurer la résolution par défaut.
- Vérifiez deux fois la connexion HDMI, ou échangez-le pour un autre câble ou moniteur pour tester.

Notification de Conformité



Les termes HDMI et HDMI High-Definition Multimedia Interface, ainsi que le Logo HDMI, sont des marques commerciales ou des marques déposées de HDMI Licensing Administrator, Inc. aux États-Unis et dans d'autres pays.



Déclaration de conformité

Cet appareil contient un ou plusieurs émetteur(s)/récepteur(s) exempt(s) de licence qui se conforment à la Partie 15 des Règles de la FCC. Son fonctionnement est soumis aux deux conditions suivantes :

- (1) Cet appareil ne doit pas causer d'interférence.
- (2) Cet appareil doit accepter toute interférence, y compris celle qui peut entraîner un fonctionnement indésirable de l'appareil.

Attention : Il est mis en garde que des changements ou modifications non expressément approuvés par la partie responsable de la conformité pourraient annuler l'autorité de l'utilisateur à utiliser l'équipement.

REMARQUE : Cet équipement a été testé et est conforme aux limites des appareils numériques de classe B, conformément à la partie 15 des règles de la FCC. Ces limites sont conçues pour offrir une protection raisonnable contre les interférences nuisibles dans une installation résidentielle. Cet équipement génère, utilise et peut émettre de l'énergie de fréquence radio et, s'il n'est pas installé et utilisé conformément aux instructions, peut causer des interférences nuisibles à la communication radio. Cependant, il n'y a aucune garantie que des interférences ne surviennent pas dans une installation particulière. Si cet équipement provoque des interférences nuisibles à la réception radio ou télévision, ce qui peut être déterminé en éteignant et en allumant l'équipement, il est recommandé à l'utilisateur d'essayer de corriger les interférences en prenant une ou plusieurs des mesures suivantes :

- Réorientez ou déplacez l'antenne de réception.
- Augmentez la séparation entre l'équipement et le récepteur.
- Branchez l'équipement sur une prise d'un circuit différent de celui auquel le récepteur est connecté.
- Consultez le revendeur ou un technicien radio/TV expérimenté pour obtenir de l'aide.

FCC Déclaration d'exposition aux radiations :

Cet équipement est conforme aux limites d'exposition aux radiations de la FCC établies pour un environnement non contrôlé. Cet équipement doit être installé et utilisé avec une distance minimale de entre le radiateur et votre corps. Cet émetteur ne doit pas être co-localisé ou fonctionner conjointement avec une autre antenne ou émetteur.



Déclaration de conformité

L'émetteur/récepteur exempt de licence contenu dans le présent appareil est conforme aux CNR d'Innovation, Sciences et Développement économique Canada applicables aux appareils radio exempts de licence. L'exploitation est autorisée aux deux conditions suivantes :

- (1) L'appareil ne doit pas produire de brouillage;
- (2) L'appareil doit accepter tout brouillage radioélectrique subi, même si le brouillage est susceptible d'en compromettre le fonctionnement.

Déclaration d'IC sur l'exposition aux radiations:

Cet équipement est conforme aux limites d'exposition aux radiations définies par le Canada pour des environnements non contrôlés. Cet équipement doit être installé et utilisé à une distance minimum de 20 cm entre l'antenne et votre corps. Cet émetteur ne doit pas être installé au même endroit ni utilisé avec une autre antenne ou un autre émetteur.



Déclaration de Conformité Simplifiée de l'UE

SmartCam View déclare que cet appareil est conforme aux exigences essentielles et autres dispositions pertinentes de la Directive EN300328, EN301489-1, EN31489-17, EN IEC 62311, EN IEC 62368.



Élimination correcte de ce produit

Veillez recycler ce produit de manière responsable afin de promouvoir la réutilisation durable des ressources matérielles et d'éviter un éventuel dommage à l'environnement.



Élimination correcte de ce produit

Cette marque indique que ce produit ne doit pas être jeté avec les autres déchets ménagers dans toute l'UE. Pour éviter de nuire à l'environnement ou à la santé humaine en raison d'une élimination des déchets incontrôlée, recyclez-le de manière responsable pour promouvoir la réutilisation durable des ressources matérielles. Pour retourner votre appareil usagé, veuillez utiliser les systèmes de retour et de collecte ou contacter le revendeur où le produit a été acheté. Ils peuvent prendre ce produit pour un recyclage sûr pour l'environnement.

Qué hay en la Caja



Grabador de Vídeo en Red Inalámbrico

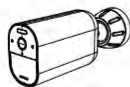

Cámara de Batería



Panel Solar



Cable de Red de 3.3 pies (1m)



Cable de Extensión USB-C de 10 pies (3m)

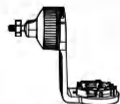

Soporte de Montaje para Panel Solar



Ratón USB



Cable HDMI



Soporte de Sujeción para Cámara



Adaptador de Corriente para NVR



Paquete de Tornillos



Restablecer Aguja de Pin



Guía de Inicio Rápido



Pegatinas para Posicionamiento de Tornillos

Nota: La cantidad de dispositivos y accesorios varía según los diferentes modelos que adquieras.

Presentamos el NVR

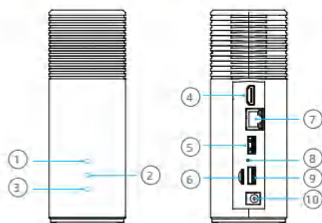

- ① LED de estado de red
- ② LED de estado de almacenamiento
- ③ Indicador LED de estado de energía
- ④ Puerto HDMI
- ⑤ Puerto USB
- ⑥ Ranura para Tarjeta MicroSD
- ⑦ Puerto Ethernet
- ⑧ Orificio de Reinicio
- ⑨ Puerto USB
- ⑩ Puerto de alimentación

Presentación de la Cámara

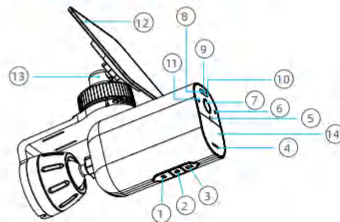

- ① Puerto de carga USB-C
- ② Botón de Emparejar/ Encendido*
- ③ Ranura para tarjeta Micro SD
- ④ Altavoz
- ⑤ Micrófono
- ⑥ Sensor fotosensible
- ⑦ Lente de Cámara
- ⑧ Luz Roja y Verde
- ⑨ Foco de Atención
- ⑩ LED infrarrojo
- ⑪ Luz indicadora
- ⑫ Panel solar
- ⑬ Soporte para Panel Solar
- ⑭ Sensor PIR

Estado de la Luz Indicadora	Descripción
Luz roja encendida de forma sólida	La cámara se está iniciando
LED infrarrojos parpadeando	Esperando emparejamiento
Luz verde encendida de forma sólida	La cámara se está cargando
Luz azul parpadeando	Vista previa remota
Luz morada encendida de forma sólida	La cámara se está actualizando
Luz roja y azul parpadeando	Error de red
Apagado	Modo de suspensión / Completamente cargado

*Botón de Encendido:

1. Mantén presionado durante 3 segundos para encender la cámara cuando esté apagada.
2. Mantén presionado durante 8 segundos para apagar la cámara cuando esté encendida.

Expansión de Almacenamiento (Opcional)

La NVR soporta tarjetas SD (con una capacidad máxima de 512G) o discos duros de 2.5 pulgadas para almacenar grabaciones de video.

Prepara tu Disco Duro

Tu disco duro debe cumplir con los siguientes requisitos:

Tipo	Disco duro (HDD) o unidad de estado sólido (SSD) que utiliza la interfaz SATA
Tamaño	2.5 pulgadas
Capacidad	Ilimitada
Recomendado	Western Digital, Seagate, SAMSUNG, Toshiba, Kingston, PNY, Crucial, SanDisk



Una nueva unidad de disco duro debe ser formateada. Es posible que necesites transferir todos los datos de tu disco duro a una ubicación segura si es necesario.

Instalar su Disco Duro



El NVR debe estar apagado cuando instales o retires un disco duro.

ES

1. Presione hacia abajo la tapa inferior para quitarla.
2. Afloje el tornillo, luego saque el soporte del disco duro.

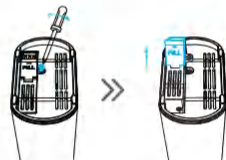

3. Fije su disco duro al soporte con los tornillos proporcionados.



4. Inserte y atornille la abrazadera de vuelta al NVR, luego coloque la tapa inferior de nuevo en su lugar.

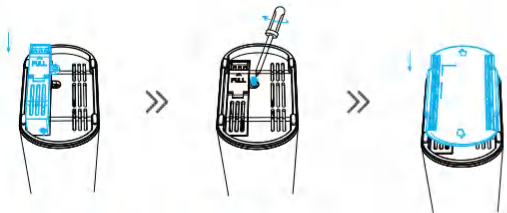

Cargando la Cámara

Recomendamos cargar completamente las cámaras antes del primer uso.

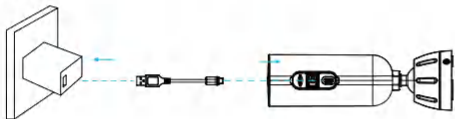

Estado de la Luz Indicadora	Descripción
Luz verde encendida de forma sólida	La cámara se está cargando
APAGADO	Completamente cargado

Configuración del Sistema

1. Conecte el adaptador de corriente incluido al NVR, espere unos minutos para que el sistema se inicie.
2. Conecta el NVR a tu enrutador utilizando el cable Ethernet incluido. Y luego, conecta el ratón USB al puerto USB del NVR.

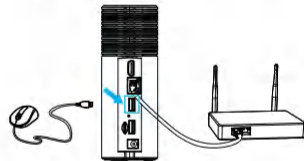
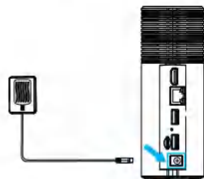

3. Conecte el NVR al monitor con un cable HDMI. (Opcional, si desea monitorear en una pantalla)

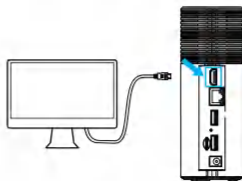

4. Para encender la cámara, presione y mantenga presionado el botón de encendido ubicado en la parte inferior de la cámara durante 3 segundos. Se conectará automáticamente al NVR mediante una señal inalámbrica.



5. Descarga e instala la aplicación gratuita "SmartCam View" desde la App Store (dispositivos iOS) o Google Play (dispositivos Android).

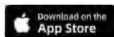

O descarga la aplicación escaneando el siguiente código QR.



For iOS



For Android

6. Ejecute la aplicación "SmartCam View", regístrese para obtener una cuenta de SmartCam View Life. Luego inicie sesión con su ID de cuenta, toque "+ Agregar dispositivo" y escanee el código QR de configuración en la parte inferior del dispositivo (quite la tapa inferior). O escanee el código QR de configuración en el menú del NVR y, a continuación, siga las instrucciones de la aplicación para agregar el NVR a la lista de dispositivos.

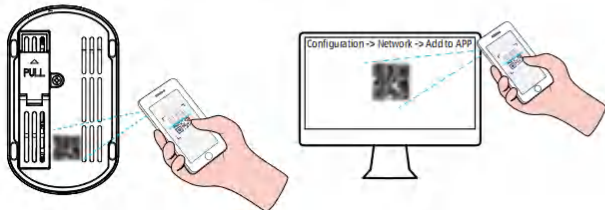

Montaje de la Cámara

Opción 1: Montar la cámara con el panel solar adjunto (Menos perforación)

Si monta una ubicación sin aleros y la luz del sol no está obstruida, instale el panel solar directamente en la parte superior de la cámara con el soporte de montaje del panel solar.



1. Instale el panel solar en el soporte de montaje del panel solar girándolo.

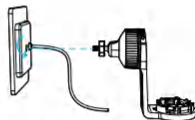

2. Asegure el cable de alimentación del panel solar en la ranura del soporte.

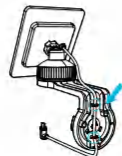

ES

3. Perfore los orificios con una broca de 6.0 mm con la tarjeta de posicionamiento incluida, luego inserte los anclajes en los orificios.

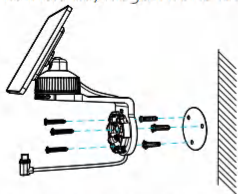

4. Instale la cámara en su soporte de montaje girándola en sentido horario hasta que haga clic en su lugar.

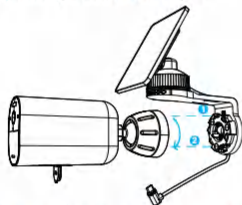

5. Apriete el tornillo de bloqueo en el soporte de montaje y luego ajústelo al ángel que necesite.

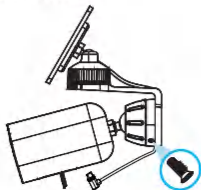

6. Conecta el conector USB-C al puerto USB-C del panel solar.

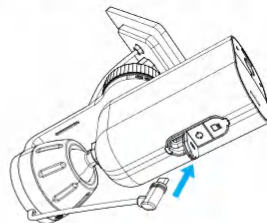

Opción 2: Montar la Cámara y el Panel Solar por Separado (Mejor para Potencia Solar Fuerte)

Si la cámara está bloqueada, instale el panel solar de forma independiente y utilice el cable de extensión USB-C proporcionado para obtener una fuerte energía solar. La cámara se puede montar en una pared o en el techo.

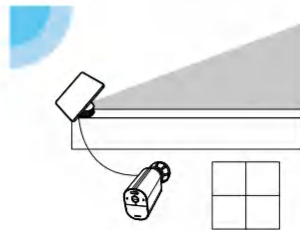

1. Desmontar el soporte de montaje del panel solar.

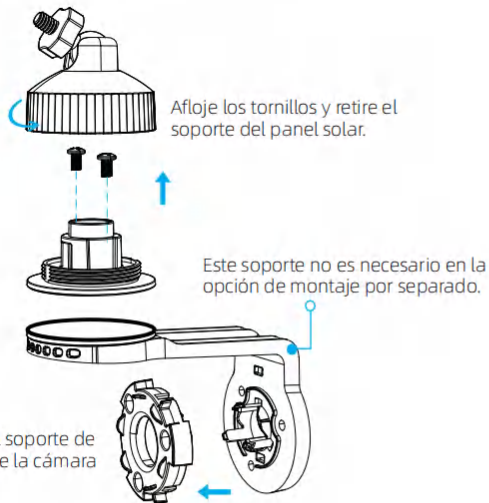

2. Instale el soporte de montaje del panel solar en una posición adecuada.



3. Instala el panel solar en su soporte de montaje girándolo y luego ajusta el ángulo.

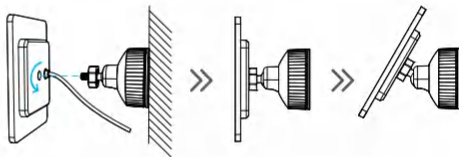

4. Instalar la cámara

Realice agujeros con una broca de 6.0 mm utilizando la tarjeta de posicionamiento incluida, luego inserte los tacos en los agujeros.

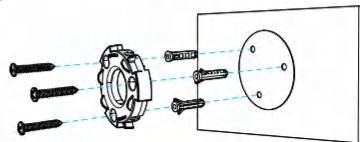

5. Instale la cámara en su soporte de montaje girándola en el sentido de las agujas del reloj hasta que haga clic en su lugar.

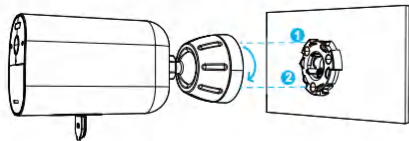

6. Apriete el tornillo de bloqueo en el soporte de montaje y luego ajústelo al ángel que necesite.

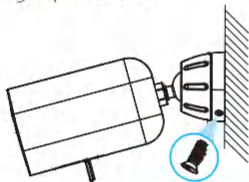

7. Conecta el panel solar a la cámara utilizando el cable de extensión USB-C proporcionado.

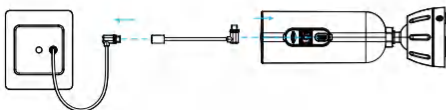

Soporte para Sujetar la Cámara

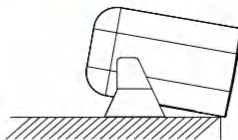

El soporte de sujeción para cámaras puede utilizarse para la colocación y ajuste de ángulos en algunos escenarios.

Emparejamiento de la Cámara

Empareje su cámara adicional o vuelva a agregar la cámara existente a su NVR:

Opción 1: Usando la aplicación "SmartCam View Life", desde la vista en vivo, toca el botón "...", y luego toca "Emparejar" para iniciar el proceso de emparejamiento. Tendrás un temporizador de 180 segundos para emparejar con tu Cámara.

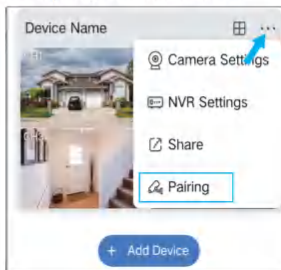

Presione el botón de emparejar de la cámara tres veces dentro de tres segundos para comenzar el emparejamiento con su NVR. Un mensaje de "Emparejamiento Exitoso" debería aparecer en la pantalla. Si no ve este mensaje, repita los pasos anteriores.

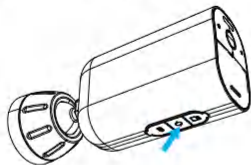

Opción 2: También puedes agregar la cámara a través del Monitor, pulsa el botón "emparejar" en el menú de Vista en Vivo del NVR para comenzar el proceso de emparejamiento.

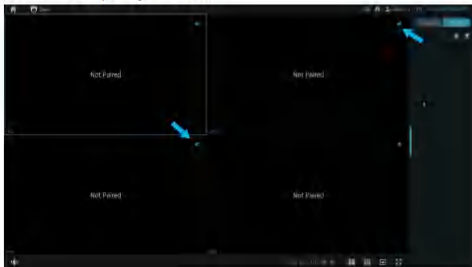

Pulse el botón de emparejamiento de las cámaras tres veces en un lapso de tres segundos para comenzar el emparejamiento con su NVR. Un mensaje de "Emparejamiento Exitoso" debería aparecer en pantalla. Si no ve este mensaje, repita los pasos anteriores.

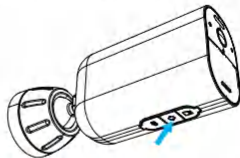

ES

Solución de Problemas

Sin salida de video en el monitor

Si no hay salida de video en el monitor desde el NVR, por favor intente las siguientes soluciones:

- La resolución del monitor debe ser al menos 720P o superior.
- Mantén presionado el botón derecho del ratón durante 10 segundos para restaurar la resolución predeterminada.
- Verifica nuevamente la conexión HDMI, o cambia a otro cable o monitor para probar.

Notificación de Cumplimiento

HDMI™
HIGH-DEFINITION MULTIMEDIA INTERFACE

Los términos HDMI y HDMI High-Definition Multimedia Interface, y el Logo de HDMI son marcas comerciales o marcas registradas de HDMI Licensing Administrator, Inc. en los Estados Unidos y otros países.



Declaración de conformidad

Este dispositivo contiene transmisor(es)/receptor(es) exentos de licencia que cumplen con la Parte 15 de las Reglas de la FCC. El funcionamiento está sujeto a las siguientes dos condiciones:

- (1) Este dispositivo no puede causar interferencia.
- (2) Este dispositivo debe aceptar cualquier interferencia, incluyendo aquella que pueda provocar un funcionamiento no deseado del dispositivo.

Precaución: Se advierte al usuario que cambios o modificaciones no expresamente aprobados por la parte responsable del cumplimiento podrían anular la autoridad del usuario para operar el equipo.

NOTA: Este equipo ha sido probado y se ha encontrado que cumple con los límites para un dispositivo digital Clase B, de acuerdo con la Parte 15 de las Reglas de la FCC. Estos límites están diseñados para proporcionar una protección razonable contra interferencias perjudiciales en una instalación residencial. Este equipo genera, usa y puede irradiar energía de radiofrecuencia y, si no se instala y utiliza de acuerdo con las instrucciones, puede causar interferencias perjudiciales a las comunicaciones de radio. Sin embargo, no hay garantía de que no ocurran interferencias en una instalación particular. Si este equipo causa interferencias perjudiciales a la recepción de radio o televisión, lo cual se puede determinar encendiendo y apagando el equipo, se recomienda al usuario intentar corregir las interferencias mediante una o más de las siguientes medidas:

- Reoriente o traslade la antena receptora.
- Aumente la separación entre el equipo y el receptor.
- Conecte el equipo en un enchufe de un circuito diferente al que está conectado el receptor.
- Consulte al distribuidor o a un técnico de radio/TV con experiencia para obtener ayuda.

FCC Declaración de Exposición a Radiación:

Este equipo cumple con los límites de exposición a la radiación de la FCC establecidos para un entorno no controlado. Este equipo debe instalarse y operarse con una distancia mínima de entre el radiador y su cuerpo. Este transmisor no debe estar co-ubicado ni operar en conjunto con ninguna otra antena o transmisor.



Declaración de Conformidad

El transmisor/receptor exento de licencia contenido en este dispositivo cumple con las regulaciones de Innovation, Science and Economic Development Canada (ISED) aplicables a aparatos de radio exentos de licencia. La operación está sujeta a las siguientes dos condiciones:

- (1) Este dispositivo no debe causar interferencias, y
- (2) Este dispositivo debe aceptar cualquier interferencia, incluida la interferencia que pueda causar un funcionamiento no deseado del dispositivo.

IC Declaración de Exposición a la Radiación:

Este equipo cumple con los límites de exposición a la radiación establecidos para ambientes no controlados en Canadá. Este equipo debe ser instalado y operado con una distancia mínima de entre el radiador y su cuerpo. Este transmisor no debe estar co-ubicado ni operar en conjunto con ninguna otra antena o transmisor.



Declaración de Conformidad Simplificada de la UE

SmartCam View declara que este dispositivo cumple con los requisitos esenciales y otras disposiciones relevantes de las Directivas EN300328, EN301489-1, EN31489-17, EN IEC 6231 1, EN IEC 62368.



Eliminación correcta de este producto

Por favor, recicle este producto de manera responsable para promover la reutilización sostenible de los recursos materiales y evitar posibles daños al medio ambiente.



Eliminación correcta de este producto

Esta marca indica que este producto no se debe desechar con otros residuos domésticos en toda la UE. Para prevenir posibles daños al medio ambiente o la salud humana por la eliminación incontrolada de residuos, reciclelo de manera responsable para promover la reutilización sostenible de los recursos materiales. Para devolver su dispositivo usado, por favor utilice los sistemas de devolución y recolección o contacte al minorista donde se adquirió el producto. Ellos pueden encargarse de reciclar este producto de manera segura para el medio ambiente.

Cosa c'è nella Scatola



NVR Wireless

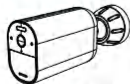

Fotocamera a Batteria



Pannello Solare



Cavo di Rete
3,3 piedi (1m)



Cavo di prolunga
USB-C da 10 ft (3m)

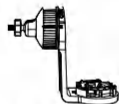

Supporto di Montaggio
per Pannello Solare



Mouse USB



Cavo HDMI



Staffa di Supporto
per Fotocamera



Adattatore di
alimentazione NVR



Pacco di Viti



Reimposta Ago Pin



Guida Rapida



Adesivi per il
Posizionamento delle Viti

Nota: La quantità di dispositivi e accessori varia a seconda dei diversi modelli acquistati.

Presentazione del NVR

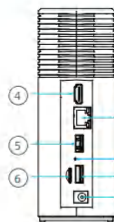
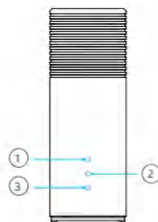

- ① LED di stato della rete
- ② LED di stato della memoria
- ③ LED Stato Alimentazione
- ④ Porta HDMI
- ⑤ Porta USB
- ⑥ Slot per scheda MicroSD
- ⑦ Porta Ethernet
- ⑧ Foro di Reset
- ⑨ Porta USB
- ⑩ Porta di alimentazione

IT

Presentazione della Fotocamera

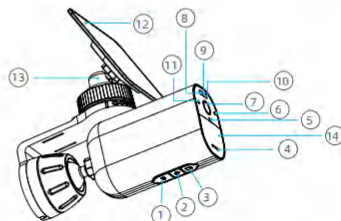

- ① Porta di ricarica USB-C
- ② Pulsante di accoppiamento /alimentazione*
- ③ Slot per Micro SD Card
- ④ Altoparlante
- ⑤ Microfono
- ⑥ Sensore fotosensibile
- ⑦ Lente della Fotocamera
- ⑧ Luce Rossa e Verde
- ⑨ Luce Spot
- ⑩ LED infrarosso
- ⑪ Spia di segnalazione
- ⑫ Pannello Solare
- ⑬ Staffa per Pannello Solare
- ⑭ Sensore PIR

Stato della luce dell'indicatore	Descrizione
La luce rossa è accesa fissa	La fotocamera si sta avviando
LED infrarossi lampeggianti	In attesa dell'abbinamento
La luce verde è accesa fissa	La fotocamera si sta caricando
La luce blu lampeggia	Anteprima remota
La luce viola è accesa fissa	La fotocamera si sta aggiornando
La luce rossa e blu lampeggia	Errore di rete
Spento	Modalità di riposo / Completamente carica

*Pulsante di Accensione:

1. Premere e tenere premuto per 3 secondi per accendere la fotocamera quando è spenta.
2. Premere e tenere premuto per 8 secondi per spegnere la fotocamera quando è accesa.

Espansione della Memoria (Opzionale)

La NVR supporta schede SD (capacità massima di 512G) o dischi rigidi da 2.5 pollici per la memorizzazione di registrazioni video.

Prepara il Tuo Disco Rigido

L'hard disk deve soddisfare i seguenti requisiti:

Type	Hard disk drive (HDD) o solid state drive (SSD) che utilizza l'interfaccia SATA
Size	2.5 pollici
Capacità	Illimitata
Consigliati	Western Digital, Seagate, SAMSUNG, Toshiba, Kingston, PNY, Crucial, SanDisk



Un nuovo hard disk deve essere formattato. Potrebbe essere necessario trasferire tutti i dati dal tuo hard disk in un luogo sicuro se necessario.

Installa il tuo Hard Disk



L'NVR deve essere spento quando si installa o si rimuove un disco rigido.

1. Premere verso il basso il coperchio inferiore per rimuoverlo.
2. Allentare la vite, poi tirare fuori il supporto del disco rigido.

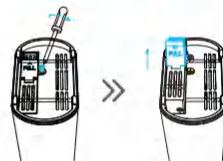

3. Fissa il tuo disco rigido al supporto con le viti fornite.

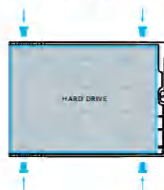

- Inserire e avvitare nuovamente la staffa al NVR, poi rimettere a posto il coperchio inferiore.

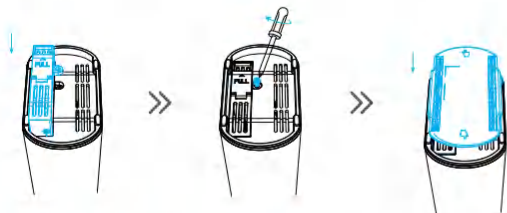

Carica della Fotocamera

Raccomandiamo di caricare completamente le telecamere prima del primo utilizzo.

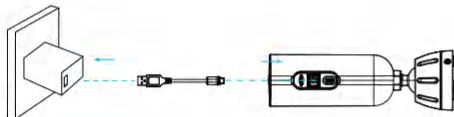

Stato della luce indicatrice	Descrizione
La luce verde è accesa fisso	La fotocamera è in carica
SPENTO	Completamente carico

Configurazione del Sistema

- Collegare l'adattatore di corrente incluso all'NVR, attendere qualche minuto per l'avvio del sistema.
- Collega il NVR al tuo router utilizzando il cavo Ethernet incluso. E poi, collega il mouse USB alla porta USB del NVR.

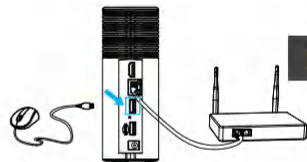
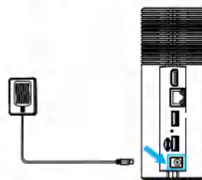

- Collega il NVR al monitor con un cavo HDMI. (Opzionale, se desideri monitorare su uno schermo)
- Per accendere la fotocamera, premere e tenere premuto il pulsante di accensione situato nella parte inferiore della fotocamera per 3 secondi. Si collegherà automaticamente all'NVR tramite un segnale wireless.

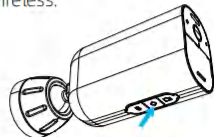
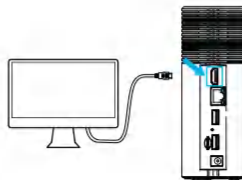

5. Scarica e installa gratuitamente l'app "SmartCam View" dall'App Store (dispositivi iOS) o Google Play (dispositivi Android).

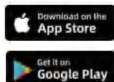

O scarica l'app scansionando il seguente codice QR.



For iOS



For Android

6. Avvia l'app "SmartCam View", registrati per un account SmartCam View Life. Poi accedi con il tuo ID account, tocca "+ Aggiungi dispositivo" e scansiona il codice QR di configurazione sul fondo del dispositivo (rimuovi il coperchio inferiore). Oppure scansiona il codice QR di configurazione nel menu NVR, e poi segui le istruzioni nell'app per aggiungere l'NVR alla lista dei dispositivi.

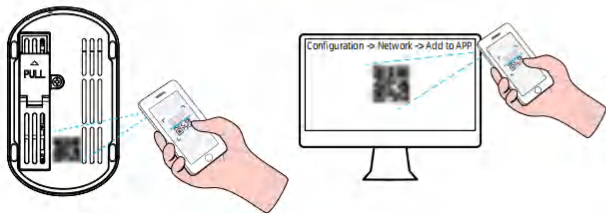

Installazione della Fotocamera

Opzione 1: Installare la Telecamera con il Pannello Solare Collegato (Meno Foratura)

Se montate una posizione senza sporgenza e la luce solare non è ostruita, installate il pannello solare direttamente sulla parte superiore della telecamera con la staffa di montaggio del pannello solare.



1. Installa il pannello solare sul supporto di montaggio del pannello solare girandolo.

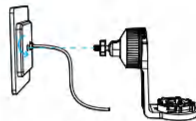

2. Fissare il cavo di alimentazione del pannello solare nello slot del supporto.

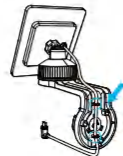

3. Pratica dei fori con una punta da 6,0 mm utilizzando la scheda di posizionamento inclusa, poi inserisci i tasselli nei fori.

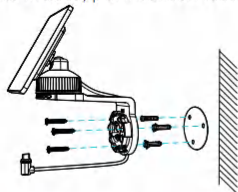

4. Installa la telecamera sul suo supporto di montaggio girandola in senso orario finché non si incastra con un clic.

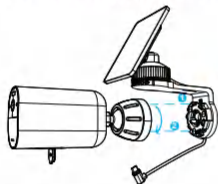

5. Stringere la vite di bloccaggio sulla staffa di montaggio e poi regolare all'angolo desiderato.

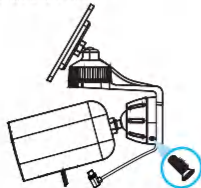

6. Collegare il connettore USB-C alla porta USB-C del pannello solare.

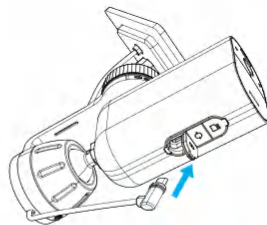

IT

Opzione 2: Montare separatamente la telecamera e il pannello solare (Migliore per un forte apporto di energia solare)

Se la telecamera è bloccata, installa il pannello solare indipendentemente e usa il cavo di prolunga USB-C fornito per ottenere una potente energia solare. La telecamera può essere montata su una parete o sul soffitto.

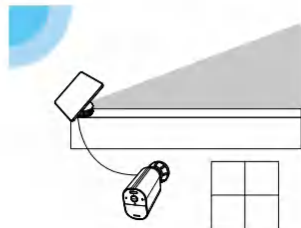

1. Smontare il supporto di montaggio del pannello solare.

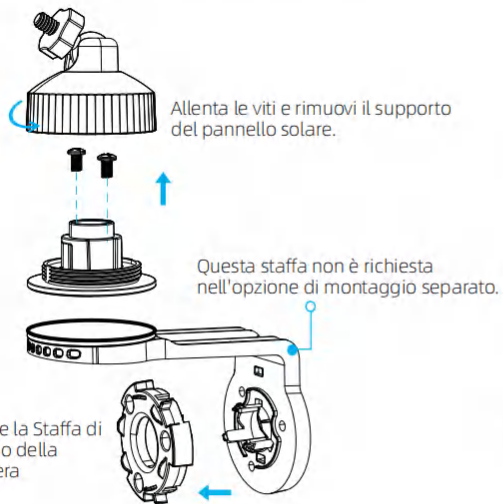

2. Installa il supporto di montaggio del pannello solare in una posizione adatta.



3. Installa il pannello solare sul suo supporto di montaggio ruotandolo, poi regola l'angolo.

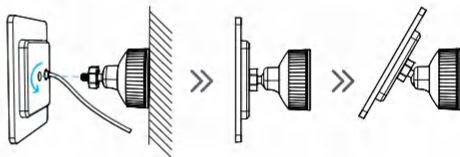

4. Installa la fotocamera

Pratica fori con una punta da 6,0 mm utilizzando la carta di posizionamento inclusa, poi inserisci i tasselli nei fori.

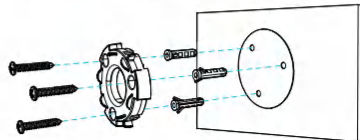

5. Installa la telecamera sul suo supporto ruotandola in senso orario fino a quando non si incastra con un clic.

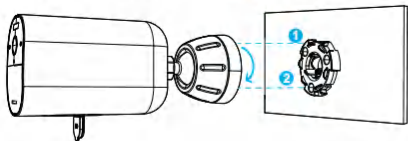

6. Stringere la vite di bloccaggio sul supporto di montaggio, e poi regolare all'angolo di cui si ha bisogno.

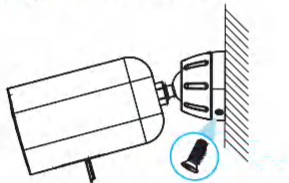

7. Collega il pannello solare alla telecamera utilizzando il cavo di prolunga USB-C fornito in dotazione.

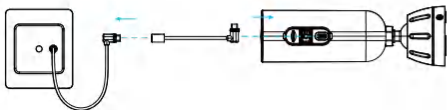

Staffa di Supporto per Fotocamera

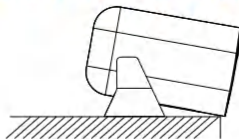

Il supporto di fissaggio per la fotocamera può essere utilizzato per il posizionamento e la regolazione degli angoli in alcuni scenari.

IT

Associare la Fotocamera

Accoppia la tua telecamera aggiuntiva o riaggiungi la telecamera esistente al tuo NVR:

Opzione 1: Utilizzando l'app "SmartCam View Life", dalla visualizzazione Dal vivo, tocca il pulsante "...", e poi tocca "Accoppiamento" per avviare il processo di accoppiamento. Avrai un timer di 180 secondi per accoppiare la tua Camera.

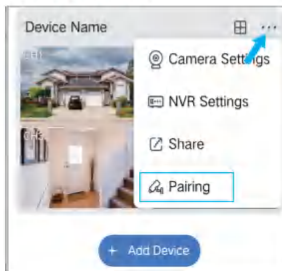

Premi il pulsante di accoppiamento della coppia di fotocamere tre volte entro tre secondi per iniziare l'accoppiamento con il tuo NVR. Un messaggio "Accoppiamento Riuscito" dovrebbe apparire sullo schermo. Se non vedi questo messaggio, ripeti i passaggi sopra descritti.

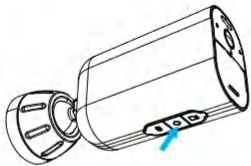

Opzione 2: Puoi anche aggiungere la telecamera tramite il Monitor, premi il pulsante "associa" nel menu Vista Dal Vivo NVR per avviare il processo di associazione.

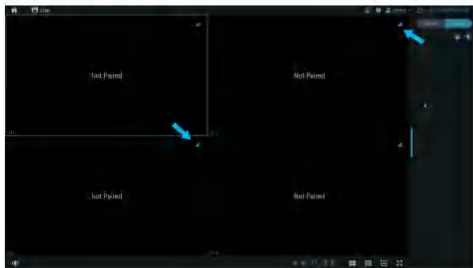

Premi il pulsante di accoppiamento della telecamera tre volte entro tre secondi per iniziare l'accoppiamento con il tuo NVR. Un messaggio "Accoppiamento Riuscito" dovrebbe apparire sullo schermo. Se non vedi questo messaggio, ripeti i passaggi sopra.

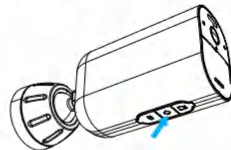

Risoluzione dei problemi

Nessun segnale video sul monitor

Se non c'è uscita video sul monitor dall'NVR, prova le seguenti soluzioni:

- La risoluzione del monitor dovrebbe essere almeno 720P o superiore.
- Tenere premuto il tasto destro del mouse per 10 secondi per ripristinare la risoluzione predefinita.
- Controlla due volte la connessione HDMI, oppure scambia un altro cavo o monitor per testarla.

Notifica di Conformità



I termini HDMI e HDMI High-Definition Multimedia Interface, e il logo HDMI sono marchi commerciali o marchi registrati di HDMI Licensing Administrator, Inc. negli Stati Uniti e in altri paesi.

FC Dichiarazione di Acquisto

Questo dispositivo contiene trasmettitore(i)/ricevitore(i) esente da licenza che rispetta(rispettano) la Parte 15 delle Regole FCC. Il funzionamento è soggetto alle seguenti due condizioni:

- (1) Questo dispositivo non può causare interferenze.
- (2) Questo dispositivo deve accettare qualsiasi interferenza, inclusa l'interferenza che può causare un funzionamento indesiderato del dispositivo.

Attenzione: Si avvisa l'utente che modifiche o variazioni non espressamente approvate dalla parte responsabile per la conformità potrebbero annullare l'autorità dell'utente di utilizzare l'apparecchiatura.

NOTA: Questo apparecchio è stato testato e risulta conforme ai limiti per un dispositivo digitale di Classe B, ai sensi della Parte 15 delle Regole FCC. Questi limiti sono progettati per fornire una ragionevole protezione contro interferenze dannose in un'installazione residenziale. Questo apparecchio genera, utilizza e può irradiare energia a frequenza radio e, se non installato e utilizzato in conformità con le istruzioni, può causare interferenze dannose alle comunicazioni radio. Tuttavia, non c'è garanzia che non si verifichino interferenze in una particolare installazione. Se questo apparecchio dovesse causare interferenze dannose alla ricezione radio o televisiva, che possono essere determinate accendendo e spegnendo l'apparecchio, si incoraggia l'utente a tentare di correggere l'interferenza adottando una o più delle seguenti misure:

- Riorientare o spostare l'antenna ricevente.
- Aumentare la separazione tra l'attrezzatura e il ricevitore.
- Collegare l'apparecchiatura a una presa su un circuito diverso da quello a cui è collegato il ricevitore.
- Consultare il rivenditore o un tecnico esperto di radio/TV per assistenza.

FCC Dichiarazione sull'esposizione alle radiazioni:

Questo apparecchio è conforme ai limiti di esposizione alle radiazioni FCC stabiliti per un ambiente non controllato. Questo apparecchio deve essere installato e utilizzato mantenendo una distanza minima di tra il radiatore e il tuo corpo. Questo trasmettitore non deve essere collocato o utilizzato in congiunzione con altre antenne o trasmettitori.

IC Dichiarazione di Conformità

Il trasmettitore/ricevitore esente da licenza contenuto in questo dispositivo è conforme alle normative di Innovation, Science and Economic Development Canada (ISED) applicabili agli apparati radio esenti da licenza. L'operazione è soggetta alle seguenti due condizioni:

- (1) Questo dispositivo non deve causare interferenze, e
- (2) questo dispositivo deve accettare qualsiasi interferenza, incluso l'interferenza che può causare un funzionamento indesiderato del dispositivo.

IC Dichiarazione sull'Esposizione alle Radiazioni:

Questo apparecchio è conforme ai limiti di esposizione alle radiazioni stabiliti per ambienti non controllati in Canada. Questo apparecchio dovrebbe essere installato e operato mantenendo una distanza minima di tra il radiatore e il tuo corpo. Questo trasmettitore non deve essere co-locato o operare in congiunzione con qualsiasi altra antenna o trasmettitore.

CE Dichiarazione di Conformità UE Semplificata

SmartCam View dichiara che questo dispositivo è conforme ai requisiti essenziali e alle altre disposizioni pertinenti della Direttiva EN300328, EN301489-1, EN31489-17, EN IEC 62311, EN IEC 62368.



Smaltimento Corretto di Questo Prodotto

Si prega di riciclare questo prodotto in modo responsabile per promuovere il riutilizzo sostenibile delle risorse materiali ed evitare potenziali danni all'ambiente.



Smaltimento Corretto di Questo Prodotto

Questa marcatura indica che questo prodotto non deve essere smaltito insieme agli altri rifiuti domestici in tutta l'UE. Per prevenire possibili danni all'ambiente o alla salute umana derivanti dallo smaltimento incontrollato dei rifiuti, riciclarlo responsabilmente per promuovere il riutilizzo sostenibile delle risorse materiali. Per restituire il dispositivo usato, si prega di utilizzare i sistemi di ritorno e raccolta oppure contattare il rivenditore presso cui è stato acquistato il prodotto. Essi possono gestire il riciclaggio di questo prodotto in modo sicuro per l'ambiente.

